



# USER'S GUIDE

V:1425-0119-10



IT319

## 3.1 Channel Home Theater System with Dock for iPod

*For the most up-to-date version of this User's Guide, go to [www.ilive.net](http://www.ilive.net)*

## WARNINGS AND PRECAUTIONS

- **CAUTION:** TO PREVENT ELECTRIC SHOCK, MATCH WIDE BLADE OF PLUG TO WIDE SLOT, FULLY INSERT.
- **WARNING:** To prevent fire or shock hazards, do not expose this unit to rain or moisture.
- **CAUTION:** Use of controls or adjustments or performance of procedures other than those specified may result in hazardous radiation exposure.
- **WARNING:** Changes or modifications to this unit not expressly approved by the party responsible for compliance could void the user's authority to operate the equipment.
- **WARNING:** Do not place the unit on top of any soft, porous, or sensitive surfaces to avoid damaging the surface. Use a protective barrier between the unit and surface to protect the surface.
- **WARNING:** Use of this unit near fluorescent lighting may cause interference regarding use of the remote. If the unit is displaying erratic behavior move away from any fluorescent lighting, as it may be the cause.
- **CAUTION:** Danger of explosion if battery is incorrectly replaced. Replace only with the same or equivalent type.
- **PRÉCAUTION:** *Danger d'explosion si les piles sont remplacées de façon incorrect. Remplacer les piles seulement par le même type de pile ou l'équivalent.*
- **WARNING:** There is a danger of explosion if you attempt to charge standard Alkaline batteries in the unit. Only use rechargeable NiMH batteries.
- **WARNING:** The remote control's button cell battery contains mercury. Do not put in the trash, instead recycle or dispose of as hazardous waste
- **WARNING:** Lithium ion batteries, like all rechargeable batteries are recyclable and should be recycled or disposed of in normal household waste. Contact your local government for disposal or recycling practices in your area. They should never be incinerated since they might explode.

Do not mix old and new batteries.

Do not mix alkaline, standard (carbon-zinc), or rechargeable (ni-cad, ni-mh, etc) batteries.

*No mezcle baterías viejas y nuevas.*

*No mezcle baterías alcalinas, estándar (carbono-zinc) o recargables (ni-cad, ni-mh, etc.).*

**CAUTION**  
RISK OF ELECTRIC SHOCK  
DO NOT OPEN

**WARNING:** TO REDUCE THE RISK OF ELECTRIC SHOCK, DO NOT REMOVE COVER (OR BACK). NO USER-SERVICEABLE PARTS INSIDE. REFER SERVICING TO QUALIFIED SERVICE PERSONNEL.



The lightning flash with arrowhead symbol, within an equilateral triangle, is intended to alert the user to the presence of uninsulated "dangerous voltage" within the product's enclosure that may be of sufficient magnitude to constitute a risk of electric shock to persons.



The exclamation point within an equilateral triangle is intended to alert the user to the presence of important operating and maintenance (servicing) instructions in the literature accompanying the appliance.

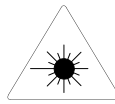

This product utilizes a Class 1 laser to read Compact Discs. This laser Compact Disc Player is equipped with safety switches to avoid exposure when the CD door is open and the safety interlocks are defeated. Invisible laser radiation is present when the CD Player's lid is open and the system's interlock has failed or been defeated. It is very important that you avoid direct exposure to the laser beam at all times. Please do not attempt to defeat or bypass the safety switches.

## IMPORTANT SAFETY INSTRUCTIONS

1. Read these Instructions.
2. Keep these Instructions.
3. Heed all Warnings.
4. Follow all instructions.
5. Do not use this apparatus near water.
6. Clean only with a dry cloth.
7. Do not block any ventilation openings. Install in accordance with the manufacturer's instructions.
8. Do not install near any heat sources such as radiators, heat registers, stoves, or other apparatus (including amplifiers) that produce heat.
9. Do not defeat the safety purpose of the polarized or grounding - type plug. A polarized plug has two blades with one wider than the other. A grounding type plug has two blades and a third grounding prong. The wide blade or the third prong are provided for your safety. When the provided plug does not fit into your outlet, consult an electrician for replacement of the obsolete outlet.
10. Protect the power cord from being walked on or pinched particularly at plugs, convenience receptacles, and the point where they exit from the apparatus.
11. Only use attachments/accessories specified by the manufacturer.
12. Use only with a cart, stand, tripod, bracket, or table specified by the manufacturer, or sold with the apparatus. When a cart is used, use caution when moving the cart/apparatus combination to avoid injury from tip-over.
13. Unplug this apparatus during lightning storms or when unused for long periods of time.
14. Refer all servicing to qualified service personnel. Servicing is required when the apparatus has been damaged in any way, such as power-supply cord or plug is damaged, liquid has been spilled or objects have fallen into the apparatus, the apparatus has been exposed to rain or moisture, does not operate normally, or has been dropped.



## Additional Warnings

- The apparatus shall not be exposed to dripping or splashing and that no objects filled with liquids, such as vases, shall be placed on apparatus.

*L'appareil ne doit pas être exposé aux écoulements ou aux éclaboussures et aucun objet ne contenant de liquide, tel qu'un vase, ne doit être placé sur l'objet.*

- Main plug is used as disconnect device and it should remain readily operable during intended use. In order to disconnect the apparatus from the mains completely, the mains plug should be disconnected from the mains socket outlet completely.

*La prise du secteur ne doit pas être obstruée ou doit être facilement accessible pendant son utilisation. Pour être complètement déconnecté de l'alimentation d'entrée, la prise doit être débranchée du secteur.*

- Battery shall not be exposed to excessive heat such as sunshine, fire or the like.

*Les piles ne doivent pas être exposées à de forte chaleur, tel qu'à la lumière du soleil, au feu ou autres choses de semblable.*

- Caution marking is located at the bottom of apparatus.

*Les précautions d'emploi sont inscrites en bas de l'appareil.*

- The marking information is located at the bottom of apparatus.

*Les marquages sont inscrits en bas de l'appareil.*

## FCC Warnings

NOTE: This equipment has been tested and found to comply with the limits for a Class B digital device, pursuant to Part 15 of the FCC Rules. These limits are designed to provide reasonable protection against harmful interference in a residential installation. This equipment generates, uses, and can radiate radio frequency energy and, if not installed and used in accordance with the instructions, may cause harmful interference to radio communications. However, there is no guarantee that interference will not occur in a particular installation. If this equipment does cause harmful interference to radio or television reception, which can be determined by turning the equipment off and on, the user is encouraged to try to correct the interference by one or more of the following measures:

- Reorient or relocate the receiving antenna.
- Increase the separation between the equipment and receiver.
- Connect the equipment into an outlet on a circuit different from that to which the receiver is connected.
- Consult the dealer or an experienced radio/TV technician for help.

## Features

- Dock plays and charges iPod
- HDMI DVD player upconverts to 1080p
- 3.1 channel speaker system with integrated subwoofer
- AM/FM radio with digital tuning
- SRS TruSurround XT™
- Motorized iPod docking drawer
- Remote
- 2 Composite video inputs
- 3 RCA stereo inputs
- Subwoofer output
- Component output
- S-Video output
- Composite video output
- HDMI output
- Disc compatibility: DVD, DVD±R/RW, CD, CD-R/RW, JPEG
- Preset EQ settings, electronic volume, treble, and bass controls
- Wall mountable
- Slot-load disc drive with anti-skip function
- Station memory presets and last channel memory
- Digital clock with timer function
- 32" wide
- AC power: built-in AC cord

## What's Included

- **IT319**
- **AM Loop Antenna**
- **FM Wire Antenna**
- **Wall-mount hardware**
- **Remote & 2 AAA batteries**
- **Documentation**

## Powering the Unit

Plug the attached AC power cable into a standard AC power outlet.

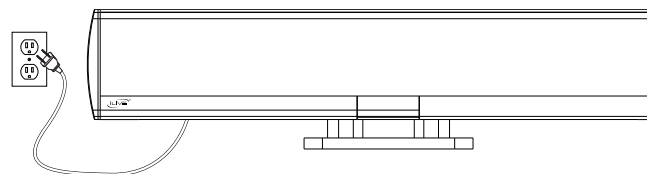

## Powering the Remote

The remote control requires 2 AAA batteries (included).

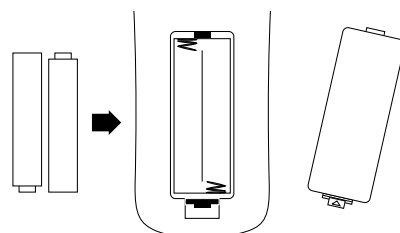

# INTRODUCTION

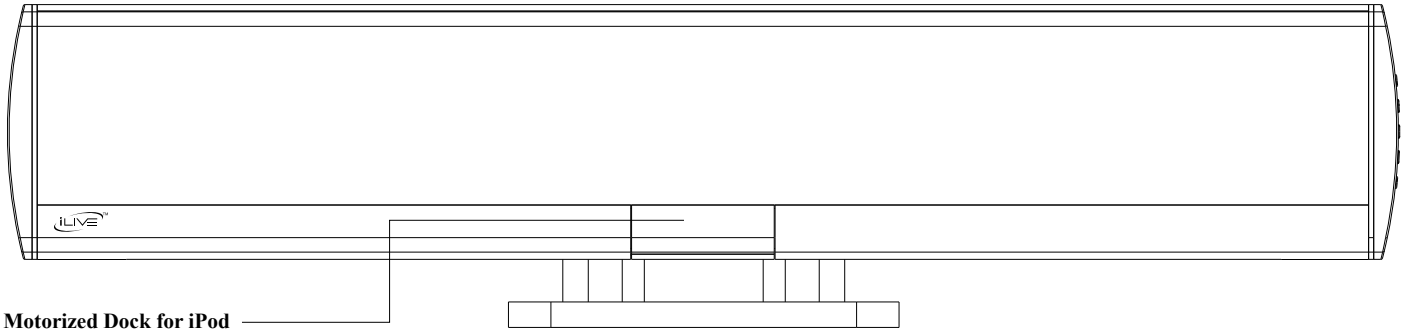

**Motorized Dock for iPod**

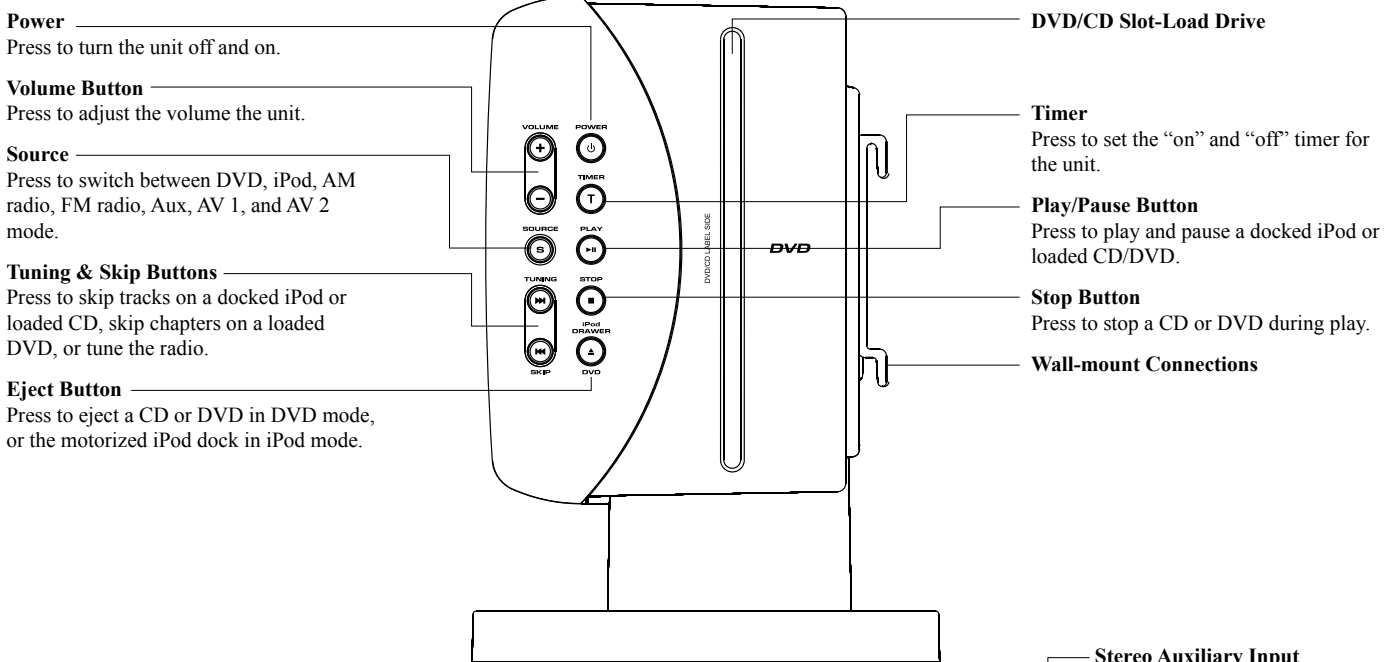

**Power**  
Press to turn the unit off and on.

**Volume Button**  
Press to adjust the volume the unit.

**Source**  
Press to switch between DVD, iPod, AM radio, FM radio, Aux, AV 1, and AV 2 mode.

**Tuning & Skip Buttons**  
Press to skip tracks on a docked iPod or loaded CD, skip chapters on a loaded DVD, or tune the radio.

**Eject Button**  
Press to eject a CD or DVD in DVD mode, or the motorized iPod dock in iPod mode.

**DVD/CD Slot-Load Drive**

**Timer**  
Press to set the "on" and "off" timer for the unit.

**Play/Pause Button**  
Press to play and pause a docked iPod or loaded CD/DVD.

**Stop Button**  
Press to stop a CD or DVD during play.

**Wall-mount Connections**

**HDMI Output (DVD only)**  
Use to connect the unit to a high definition display.

**FM & AM Antenna Inputs**  
Use to connect an FM and AM antenna to the unit.

**S-Video Output (DVD or iPod)**  
Use to connect the unit to a display using an S-Video cable.

**Stereo Auxiliary Input**  
Use to connect an MP3 player or other audio source to the unit.

**Reset**  
Press to reset the unit to it's original default settings.

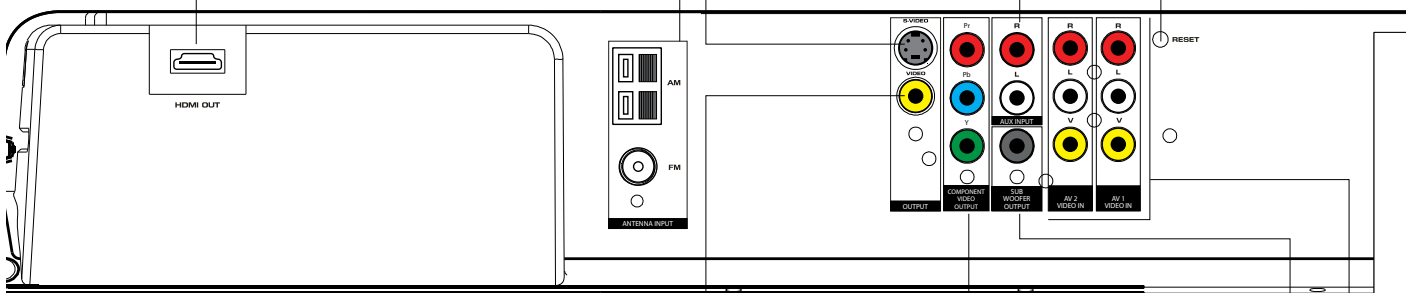

**Composite Video Output (DVD, iPod, or AV Inputs)**  
Use to connect the unit to a display using RCA video cables (not included).

**Component Video Output (DVD only)**  
Use to connect the unit to a display using component video cables (not included).

**Subwoofer Output**  
Use to connect an external subwoofer to the unit.

**AV 1 & AV 2 Inputs**  
Use to connect a DVD player or Set-Top Box to the unit.

**Power**  
Press to turn the unit off and on.

**Sleep**  
Press repeatedly to set the sleep timer between 1-90 minutes.

**Timer**  
Press to set the "on" and "off" timer for the unit.

**Source**  
Press to switch between DVD, iPod, AM radio, FM radio, Aux, AV 1, and AV 2 mode.

**Go To Button**  
Press and enter a specific time using the Number Keypad to automatically skip to that time on the loaded DVD.

**Display Button**  
Press to view the time when in radio, DVD, or Aux mode.

**Album Buttons**  
Press to cycle through albums on a docked iPod.

**Chapter Buttons**  
Press to cycle through chapters on a docked iPod.

**Set Up Button**  
Press to enter the unit's setup menu. (Must be in DVD Mode.)

**Program**  
Press to program a loaded CD or DVD to play tracks or chapters in a specified order.

**A-B Button**  
Press once to mark a starting point during a DVD. Press the button a second time to mark an ending point. After doing so the DVD will loop that section of video. Press the button a third time to cancel this function.

**Menu**  
Press to return to the loaded DVD's menu when in *DVD Mode*. Press to move backwards through a docked iPod's menus.

**Mute Button**  
Press to mute the volume of the unit.

**Eject Button**  
Press to eject a CD or DVD in DVD mode, or the motorized iPod dock in iPod mode.

**Number Keypad**

**Playlist Button**  
Press to cycle through playlists on a docked iPod.

**Preset Buttons**  
Press to cycle through saved radio stations.

**Memory Button**  
Press to save the current radio station to the unit's memory.

**Clear**

**Directional & Select Buttons**  
Press to move through a docked iPod's menus and tune the radio. Press the Select Button to make selections on a docked iPod.

**Repeat Button**  
Press to repeat a song, album or playlist from a docked iPod or a loaded CD or DVD.

**Return**

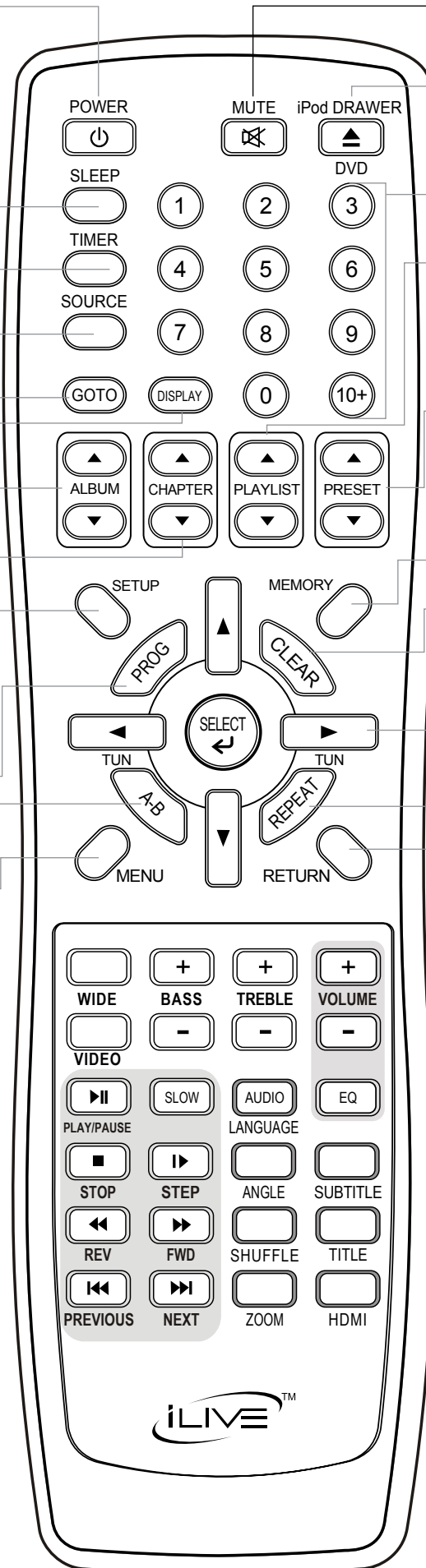

**Continued** ➔

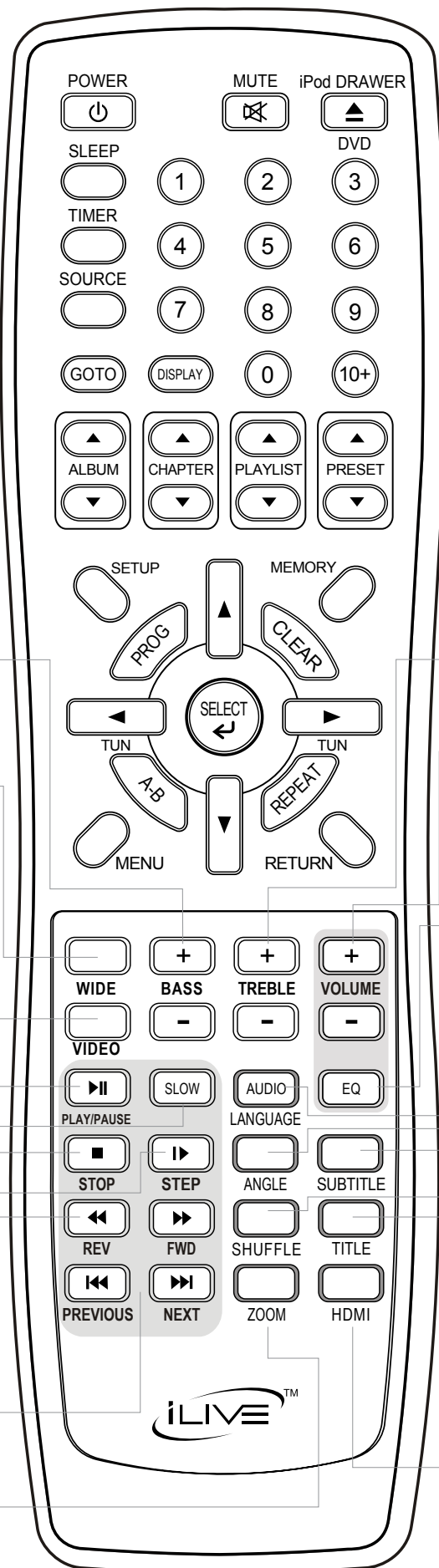

**Bass Button**

Press to adjust the bass of the unit. (The unit must be in Music 2.1 or Music 3.1 EQ mode.)

**Wide**

Press and hold to switch between 4:3LB, 4:3PS and 16:9 aspect ratio.

**Video Button**

Press to switch between Component or S-Video output.

**Play/Pause Button**

Press to play and pause a docked iPod or loaded CD/DVD.

**Slow Button**

Press to view a DVD movie in slow motion.

**Stop Button**

Press to stop a CD or DVD during play.

**Step Button**

Press to skip forward through a DVD one frame at a time.

**Search Buttons**

Press to search through an individual track on a docked iPod, CD, or chapter on a loaded DVD.

**Skip Buttons**

Press to skip through tracks on a docked iPod, CD, or chapters on a loaded DVD.

**Zoom**

Press to zoom in and out during a DVD movie.

**Treble Button**

Press to adjust the treble of the unit. (The unit must be in Music 2.1 or Music 3.1 EQ mode.)

**Volume Button**

Press to adjust the volume the unit.

**EQ Button**

Press to adjust the unit's preset equalizer settings. (Details on Page 15)

**Audio Button**

Press to adjust the audio language of a loaded DVD.

**Angle Button**

Press to view alternate angles on a playing DVD. The Angle Button will only work with compatible DVDs.

**Subtitle Button**

Press to adjust the subtitle language for a loaded DVD.

**Shuffle Button**

Press to play tracks from a CD or an iPod in a random order.

**Title Button**

Press to return to the title screen of a loaded DVD.

**HDMI**

Press to adjust the output resolution between 480i, 480p, 720p60, 1080i60, and 1080p60

➡ **Continued**

## IPOD OPERATIONS

### Docking an iPod

Locate the numbered bracket that fits the iPod that will be docked.

*Each included Bracket has a number on it, indicating which iPod model that bracket is compatible with. See the separate bracket chart page to identify which bracket is needed.*

Press the **Power Button** to turn the unit on.

Press the **Source Button** to switch the unit to iPod mode.

Press the **iPod Drawer Button** to open the iPod motorized door on the unit.

Snap the bracket into place over the iPod connector in the **Motorized Dock for iPod**.

*All Brackets will only fit one way onto the Dock.*

*When inserting an iPod nano (first or second generation), slide the Dock connection on the unit so that it matches the opening on the iPod nano (first or second generation).*

Connect the iPod to the iPod connector inside the **Motorized Dock for iPod**.

Once an iPod is connected to the **Motorized Dock for iPod**, the unit will charge the docked iPod.

### Playing an iPod

Dock an iPod onto the unit by following the “Docking an iPod” instructions.

Press the **Power Button** to turn the unit on.

Press the **Source Button** to switch the unit to iPod mode.

Press the **Play/Pause Button** to begin playing a docked iPod.

*The included remote control will allow you to access and play all of the media stored on the docked iPod from a distance.*

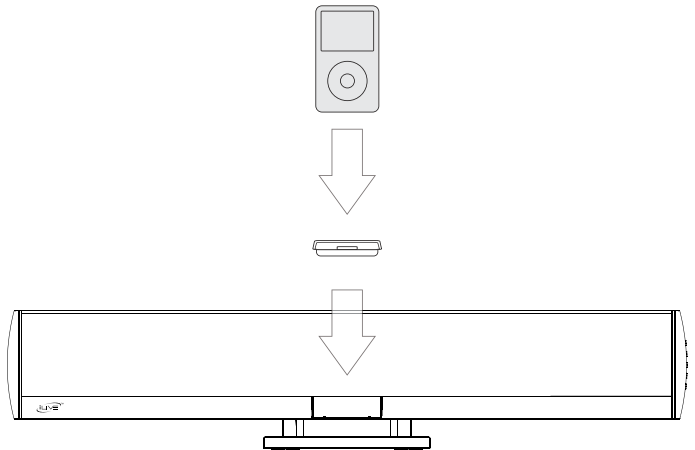

### Advanced features

#### Directional & Select Buttons (on remote)

Press to move through a docked iPod's menus. Press the Select Button to make selections on a docked iPod.

#### Repeat Button (on remote)

Press to repeat a song, album or playlist from a docked iPod.

#### Playlist Button (on remote)

Press to cycle through playlists on a docked iPod.

#### Album Buttons (on remote)

Press to cycle through albums on a docked iPod.

#### Chapter Buttons (on remote)

Press to cycle through chapters on a docked iPod.

#### Menu Button (on remote)

Press to move backwards through a docked iPod's menus.

#### iPod Drawer Button

Press to open the motorized dock for iPod in *iPod mode*.

### Video Output from a docked iPod

A docked iPod can only output video through the S-Video Output or the Composite Video Output.

To watch video from a docked iPod on a connected display, the iPod's TV Out setting must be set to “On” or “Ask”.

## USING THE BUILT-IN DVD/CD PLAYER

### Loading a CD or DVD

**IMPORTANT:** The CD or DVD must be loaded with the label side facing in the same direction as the front of the unit.

### Playing a CD or DVD

*The unit must be connected to an external display before viewing a DVD.*

Press the **Power Button** to turn the unit on.

Press the **Source Button** to switch to *DVD Mode*.

Load a CD or DVD into the unit.

Press the **Play/Pause Button** to play the loaded CD or DVD.

### Video Output from a loaded DVD

*Video can be output from a loaded DVD using any of the available video outputs on the unit. (Composite, S-Video, Component, or HDMI)*

Connect the bar speaker to the display using the desired video output that has a corresponding input on the display.

Press the **Source Button** to switch to *DVD Mode*.

Load a DVD into the unit.

Press the **Play/Pause Button** to play the loaded DVD.

LABEL SIDE

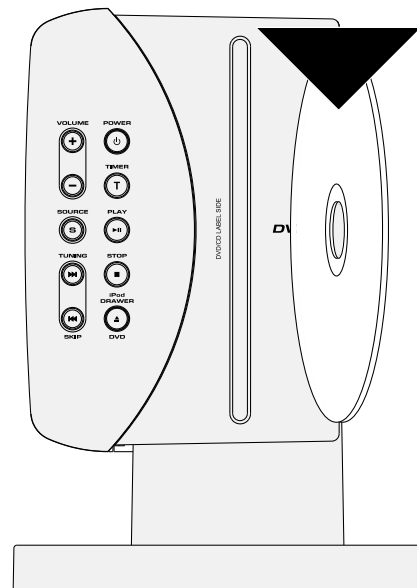

### Programming a CD or DVD

First press the **Source Button** to switch to *DVD Mode*, and load a CD or DVD into the television

Press the **Program Button**.

Use the **Number Keypad** to enter in specific titles and chapters or tracks in the order you want them to play.

Press the **Directional Buttons** to select the on-screen *Start* button to begin playing your programmed DVD.

To cancel a set program, press the **Program Button**, then use the **Directional Buttons** to select *Stop* then *Exit*.

**HDMI Output (DVD only)**  
Use to connect the unit to a high definition display.

**S-Video Output (DVD or iPod)**  
Use to connect the unit to a display using an S-Video cable.

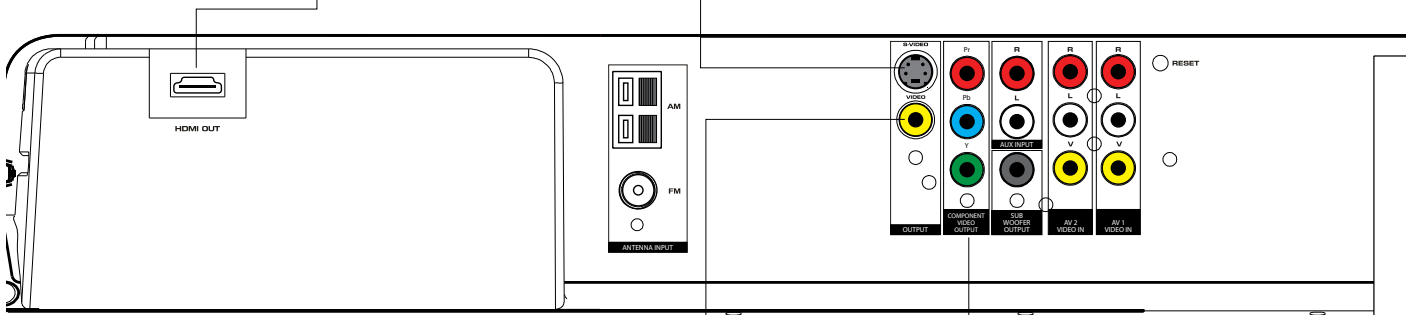

**Composite Video Output (DVD, iPod, or AV Inputs)**  
Use to connect the unit to a display using RCA video cables (not included).

**Component Video Output (DVD only)**  
Use to connect the unit to a display using component video cables (not included).



## DVD Menu

To access the DVD menu, press the **Setup Button (on the remote)** in *DVD Mode*.

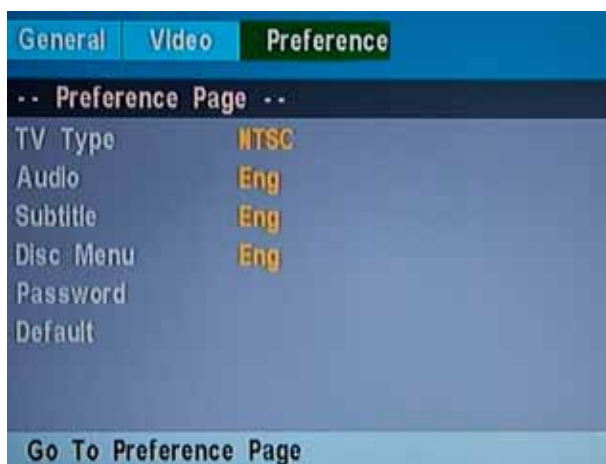
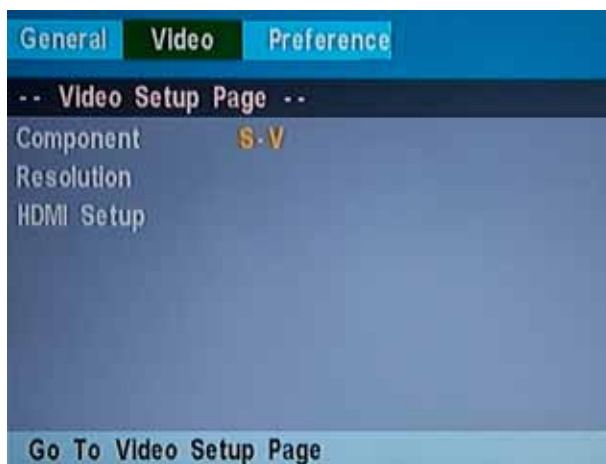
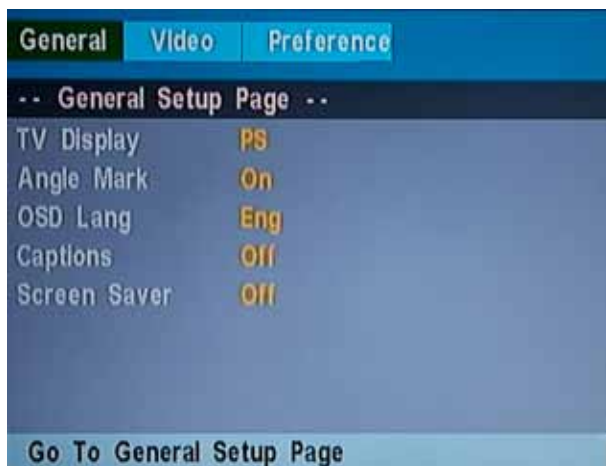

## Advanced DVD features

### Go To Button

Press and enter a specific time using the Number Keypad to automatically skip to that time on the loaded DVD.

### Set Up Button

Press to enter the unit's setup menu. (Must be in DVD Mode.)

### Program

Press to program a loaded CD or DVD to play tracks or chapters in a specified order.

### Repeat Button

Press to repeat a song, album or playlist from a docked iPod or a loaded CD or DVD.

### A-B Button

Press once to mark a starting point during a DVD. Press the button a second time to mark an ending point. After doing so the DVD will loop that section of video. Press the button a third time to cancel this function.

### Menu

Press to return to the loaded DVD's menu when in *DVD Mode*.

### Video Button

Press to switch between Component or S-Video Output.

### HDMI

Press to adjust the output resolution between 480i, 480p, 720p60, 1080i60, and 1080p60

### Angle Button

Press to view alternate angles on a playing DVD. The Angle Button will only work with compatible DVDs.

## BASIC CONNECTIVITY

Below, you'll see a basic flow chart of how you can connect your home entertainment devices to the bar speaker, and in turn how the bar speaker connects to them. The following pages contain more detailed instructions on what exactly needs to be done to make these connections.

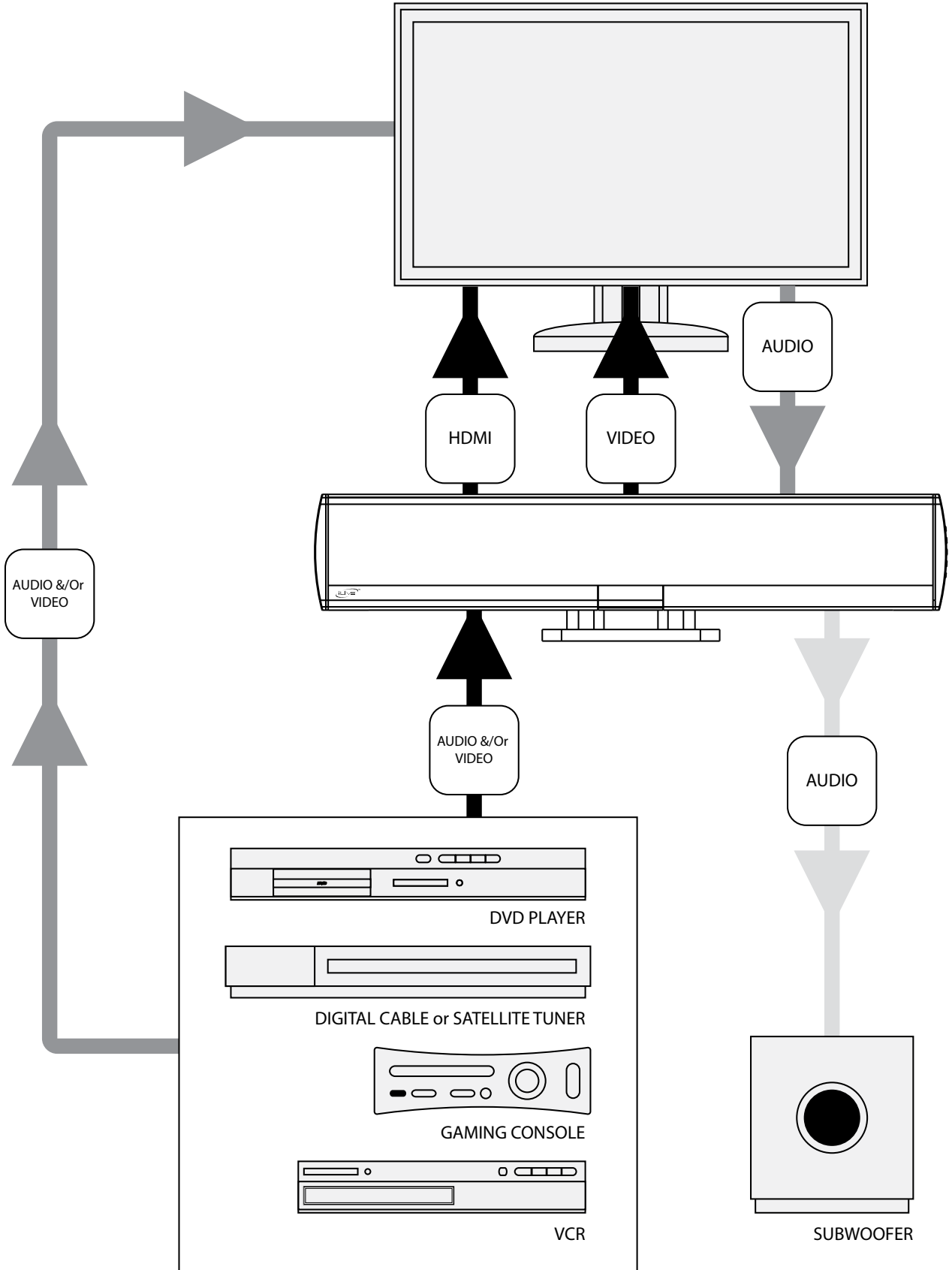

### Connecting a Display

You will need: a display, s-video cable or composite video cable or component video cable or a HDMI cable.

Connect the display's *video inputs* to the corresponding **Video Output** on the bar speaker.

Power the bar speaker on and press the **Source Button** to switch to a compatible video out source. (*DVD, iPod, AV1, or AV2*)

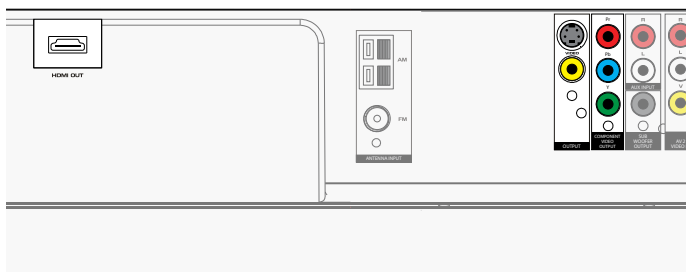

### Connecting a DVD Player or VCR

You will need: a DVD player or VCR, composite video and RCA stereo cables.

Connect the DVD player or VCR *audio* and *video outputs* to the corresponding **Audio** and **Video Inputs** on the bar speaker.

Power the bar speaker on and press the **Source Button** to switch to the connected input. (AV1 or AV2)

### Connecting a Set-top Box

You will need: a set-top box, composite video and RCA stereo cables

Connect the set-top box's *audio* and *video outputs* to the corresponding **Audio** and **Video Inputs** on the bar speaker.

Power the bar speaker on and press the **Source Button** to switch to the connected input. (AV1 or AV2)

### Connecting a Gaming Device

You will need: a gaming device, composite and RCA stereo cables.

Connect the gaming device's *audio* and *video outputs* to the corresponding **Audio** and **Video Inputs** on the bar speaker.

Power the bar speaker on and press the **Source Button** to switch to the connected input. (AV1 or AV2)

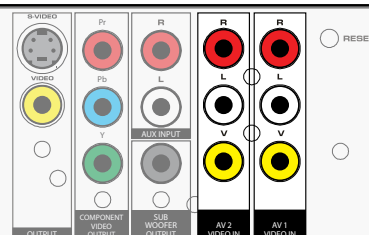

## INSTALLATION

### Bar Speaker Placement

The bar speaker depends, in part, on its environment to help produce a realistic surround sound environment. We've suggested two potential placement options in the diagrams below to help you get the most out of your 3.1 Channel Music System.

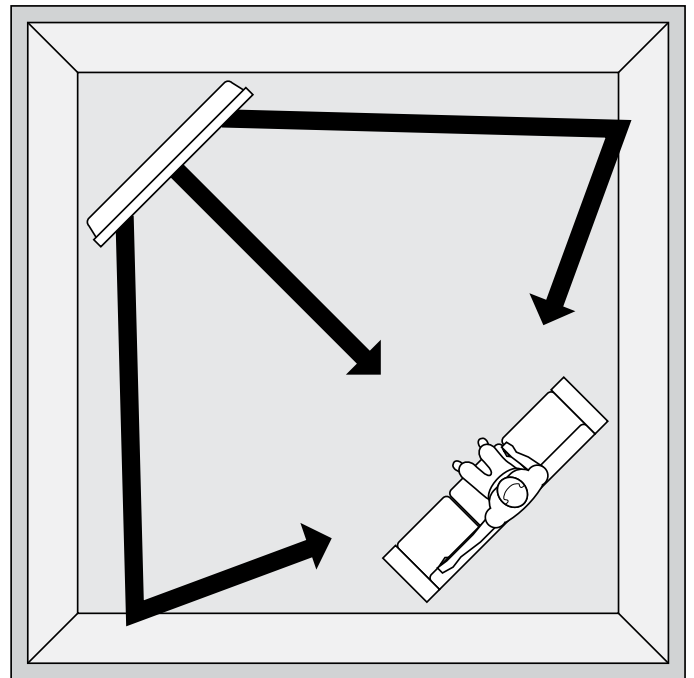
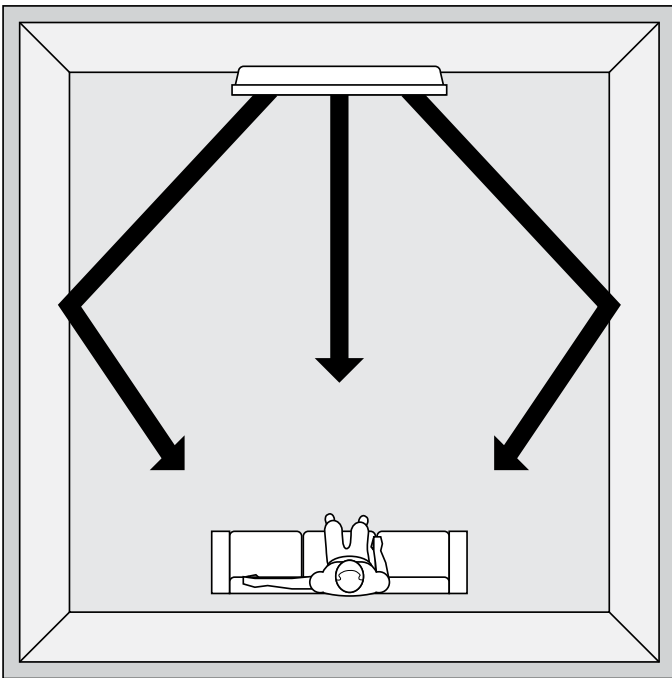

### Ventilation

When placing the bar speaker on an entertainment center, bookshelf, or any type of enclosed space, be sure to allow at least 2-3 inches of space around the bar speaker for ventilation. If the bar speaker is enclosed in a tight space, without ventilation, heat generated from the bar speaker could produce a potential heat hazard.

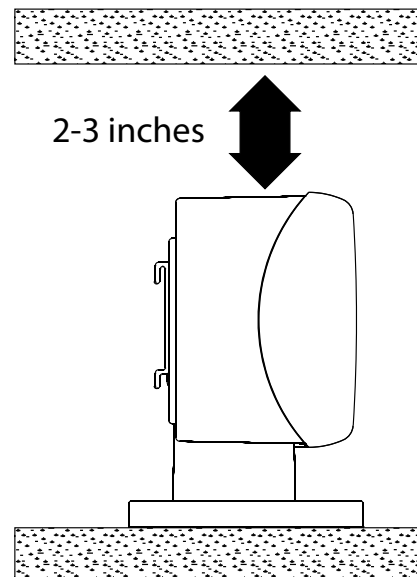

## Important Notes

We recommend having this bar speaker professionally mounted.

The included spacers should be used at your discretion to extend the face of the bar speaker farther from the wall. These are typically used when mounting the bar speaker under a television, and the face of the bar speaker needs to be flush with the face of the television.

## Required Tools

- Manual or Power Screwdriver
- Stud Finder
- Pencil
- Tape Measure
- Level

## Getting Started

Use the **Tape Measure** to decide how high you'd like to hang the bar speaker on the wall.

*The bar speaker must be hung within 6 feet of an AC power outlet for the attached AC Power Cord to reach.*

Use the **Stud Finder** to locate 2 parallel wooden studs to screw the mounting brackets into.

Mark the wall at the center of the studs using the **pencil**.

Line the **level** up on both of your marks to make sure they are level. If they're not, adjust the marks as needed to make them level.

After you've double checked your markings, **drill** through the top hole on both mounting brackets directly into the marks you've made on the wall.

If you are using the brackets only and no spacers, use the included short screws. If you are using any of the spacers or combination of the spacers, use the long screws.

Use the **Level** to level each of the hanging brackets, then drill the second screw into the bottom hole on both mounting brackets.

Slide the bar speaker onto the mounting brackets, and make sure there is a firm and stable connection before letting go of the bar speaker.

Finally, use the **Level** to confirm that the bar speaker is level.

## Bracket Placement on Wall

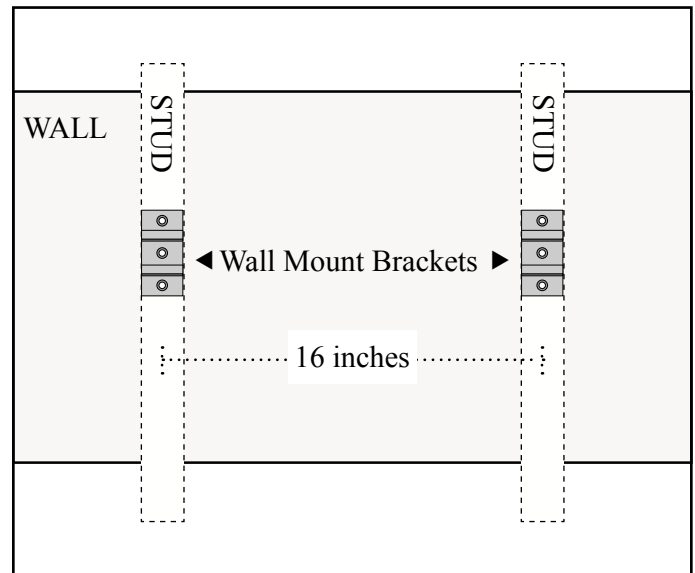

## Hanging the Unit

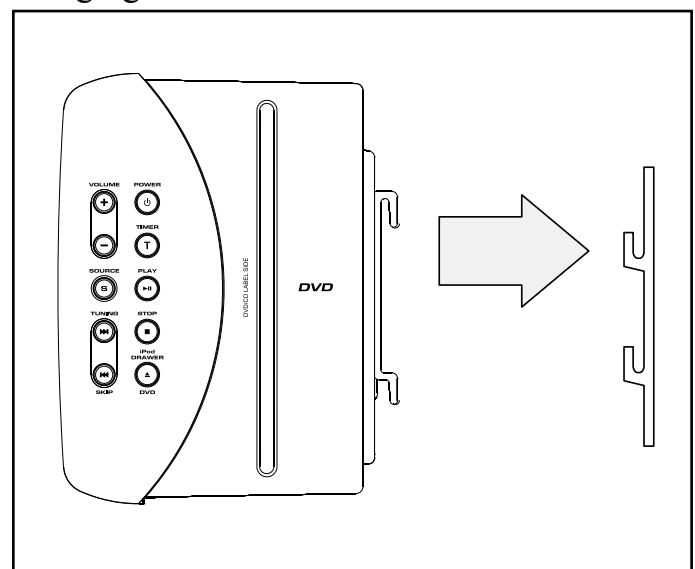

## BASIC OPERATIONS

### Setting the Clock

**IMPORTANT:** This operation cannot be done from the remote.

Press the **Power Button** to turn the bar speaker off.

Press and hold the **Timer Button**, the display will begin to flash.

While holding the **Timer Button**, press the **Tuning/Skip Buttons** on the bar speaker to adjust the hour and minute of the clock.

Release the **Timer Button** to finish setting the clock.

### Tuning the AM or FM Radio

*An external AM and FM antenna are included with the bar speaker. Connect these to the AM and FM Antenna Inputs on the bottom of the unit before attempting to use the built-in radio.*

Press the **Power Button** to turn the unit on.

Press the **Source Button** to switch to AM or FM radio mode.

Press the **◀ and ▶ Directional Buttons** on the remote to tune the radio.

*You can also use the **Tuning/Skip Buttons** on the unit to tune the radio.*

### Saving a Radio Station to the Unit's Memory

After tuning to the desired AM or FM radio station, press the **Memory Button** (on the remote).

Press the **▲ and ▼ Directional Buttons** (on the remote) to select a memory preset (ie. "P01").

After you have chosen a memory preset, press the **Memory Button** to save the selected station to the selected memory preset.

To cycle through preset radio stations, press the **Preset Buttons** (on the remote).

### Setting a Timer for the unit to Power On

**IMPORTANT:** This operation cannot be done from the remote.

Press the **Power Button** to turn the bar speaker on.

Press and hold the **Timer Button** until "ON" appears on the display.

While holding the **Timer Button**, press the **Tuning/Skip Buttons** to adjust the hour and minute.

While holding the **Timer Button**, press the **Volume Buttons** to adjust the volume of the timer.

While holding the **Timer Button**, press the **Source Buttons** to adjust the source of the timer.

Release the **Timer Button** to finish setting the on timer. Press the **Timer Button** to turn the on timer on or off. "Timer On" will appear on the display when the timer is activated..

### Setting a Timer for the unit to Power Off

**IMPORTANT:** This operation cannot be done from the remote.

Press the **Power Button** to turn the bar speaker on.

Press and hold the **Timer Button** until "ON" appears on the display.

While holding the **Timer Button**, press the **Power Button**. "OFF" will appear on the display.

While holding the **Timer Button**, press the **Tuning/Skip Buttons** to adjust the hour and minute.

Release the **Timer Button** to finish setting the off timer. Press the **Timer Button** to turn the off timer on or off. "Timer Off" will appear on the display when the off timer is activated.

### Resetting the Bar Speaker

If the bar speaker is not responding correctly, try resetting it.

Using a paperclip or like object, press the Reset Button on the bottom of the bar speaker. This will restore the bar speaker to it's default settings.

### Built-in Sound Technologies

If you press the EQ Button on the remote, you can cycle through the available sound technologies that are built into the bar speaker.

**SRS TruSurround XT®** creates a truly immersive surround sound experience with rich bass and clear dialog.



**SRS TruSurround XT® - Dialog Clarity Mode** enhances the vocals so dialog is clear and easy to understand.

**SRS WOW®** significantly improves the playback quality of audio, delivering a dynamic 3D entertainment experience with deep, rich bass.



**Music 2.1** delivers the audio through two of the three speakers and the subwoofer.

**Music 3.1** delivers the audio through all three of the bar speaker's speakers and the subwoofer.

### Connecting an External Subwoofer

*Requires an RCA Audio Cable.*

Plug an RCA Audio Cable into the **Subwoofer Output** on the bar speaker.

Connect the other end of the RCA Audio Cable into an external Subwoofer.

The connected external subwoofer will amplify the lower audio frequency output from the bar speaker.

## COMPANY INFORMATION

### Green Initiative

#### Environmental Commitment to 'Protect for Today and Sustain for Tomorrow'

2009 marks the official launch of DPI, Inc.'s corporate campaign for a greener and cleaner world. DPI and its four brands, iLive, WeatherX, Capri, and GPX, are building upon environmental initiatives introduced at all of their facilities to help formulate and sustain significant and important conservation efforts within its manufacturing and marketing communities. In addition to targeting and selecting energy efficient product features, and structuring 'green office' procedures, other initial program efforts include:

- Reduction of all packaging sizes
- Recyclable plastics for clamshell packages, with a plan to eventually replace plastic with recyclable paper
- Recycled fiber board in place of the polyfoam in packing boxes
- Recycled plastics in place of the virgin material in product construction

### International Support

To download this User's Guide in English, Spanish, or French, visit the support section at [www.ilive.net](http://www.ilive.net).

Para transferir esta guía de usuario en inglés, español, o francés, visite la sección de la ayuda en [www.ilive.net](http://www.ilive.net).

Pour télécharger ce guide de l'utilisateur en anglais, espagnol, ou français, visitez la section de soutien chez [www.ilive.net](http://www.ilive.net).

### Contact Information

Address: 2116 Carr Street, St. Louis MO, 63106

Phone: 1-314-621-2881

Fax: 1-314-588-1805

Email: [prodinfo@gpx.com](mailto:prodinfo@gpx.com)

Parts Email: [partsinfo@dpi-global.com](mailto:partsinfo@dpi-global.com)

Website: [www.ilive.net](http://www.ilive.net)



## Free Manuals Download Website

<http://myh66.com>

<http://usermanuals.us>

<http://www.somanuals.com>

<http://www.4manuals.cc>

<http://www.manual-lib.com>

<http://www.404manual.com>

<http://www.luxmanual.com>

<http://aubethermostatmanual.com>

Golf course search by state

<http://golfingnear.com>

Email search by domain

<http://emailbydomain.com>

Auto manuals search

<http://auto.somanuals.com>

TV manuals search

<http://tv.somanuals.com>