

DF-H22, DK-H22, DM-H22

# DUAL ALARM CLOCK SPEAKER SYSTEM

for iPod

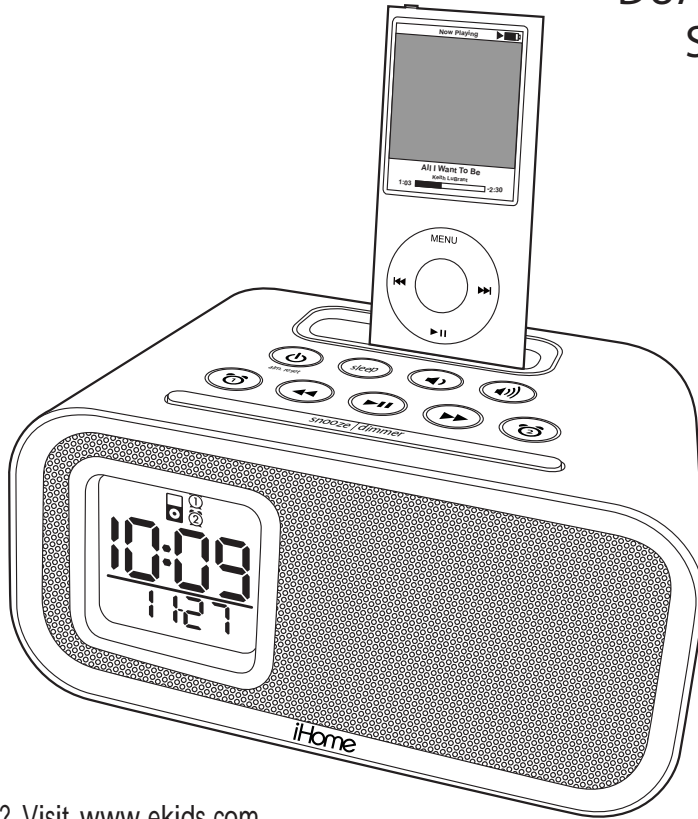

QUESTIONS? Visit [www.ekids.com](http://www.ekids.com)

## **IMPORTANT** Read before proceeding

If you have any questions regarding the operation or use of this product, please visit [www.ekids.com](http://www.ekids.com) to view answers to frequently asked questions.

To learn more about this and other iHome products, please visit [www.iHomeaudio.com](http://www.iHomeaudio.com) or [www.ekids.com](http://www.ekids.com). All Manuals Search And Download.

## Table of Contents

<b>Quick Start .....</b>	<b>1</b>
<b>Controls and Indicators .....</b>	<b>2</b>
<b>Unit display / Install Clock Backup Battery / Install iPod Insert .....</b>	<b>3</b>
<b>Using the Unit .....</b>	<b>4-6</b>
<b>A Consumer Guide to product Safety .....</b>	<b>7</b>
<b>Trouble Shooting .....</b>	<b>8</b>
<b>Warranty Information .....</b>	<b>9</b>

## Maintenance

- Place the unit on a level surface away from sources of direct sunlight or excessive heat.
- Protect your furniture when placing your unit on a natural wood and lacquered finish. A cloth or other protective material should be placed between it and the furniture.
- Clean your unit with a soft cloth moistened only with mild soap and water. Stronger cleaning agents, such as Benzine, thinner or similar materials can damage the surface of the unit.

## A Consumer Guide to Product Safety

**This device complies with Part 15 of the FCC Rules, operation is subject to the following two conditions: (1) This device may not cause harmful interference, and (2) this device must accept any interference received, including interference that may cause undesired operation.**

This equipment complies with the limits for a Class B digital device as specified in Part 15 of FCC Rules. These limits provide reasonable protection against radio and TV interference in a residential area.

However, your equipment might cause TV or radio interference even when it is operating properly. To eliminate interference you can try one or more of the following corrective measures:

- Reorient or relocate the receiving antenna.
- Increase the distance between the equipment and the radio or TV.
- Use outlets on different electrical circuits for the equipment and the radio or TV.
- Consult your dealer or an experienced radio/television technician if the problem still exists.

Modifying or tampering with your system's internal components can cause a malfunction and might invalidate the system's warranty and void your FCC authorization to operate it.

This Class B digital apparatus complies with Canadian ICES-003.

Cet appareil numérique de la classe B est conforme à la norme NMB-003 du Canada.

## Battery Warning

### For models that require more than one battery

- Do not mix with used or other battery types/brands
- Replace all batteries at the same time
- Do not open batteries
- Do not dispose of in fire
- Do not heat above 75°C (167°F)
- Do not expose contents to water
- Do not charge or recharge
- Do not install backwards

# Quick start

## 1:power

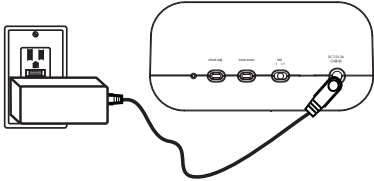

Attach AC adaptor cable to jack on back of the unit and plug the other end into a wall socket.

## 2:inserts

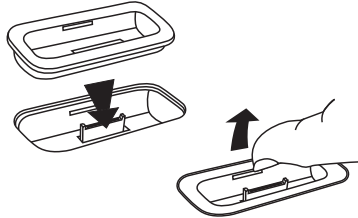

Select the dock insert for your iPod model from the table below and place insert in dock. To remove insert, place thumbnail in slot and gently pull upwards.

## 3:iPod

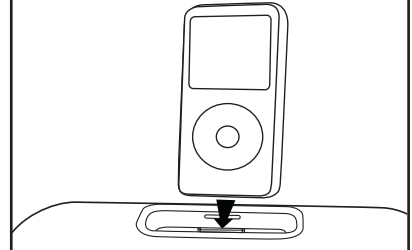

Insert an iPod into the dock with proper insert (iPod must not be in a skin or case). The iPod will charge while docked. Press the **▶||** Button on the unit to play your iPod.

Use this insert

iPod touch 2G  
insert 16

nano 6G/touch 4G  
insert 20

For this iPod

iPod touch 2G/3G

nano 6G  
iPod touch 4G

## 4:time



- Press & hold the Time Zone button on the back of the unit until the display flashes
- Press the **◀** or **▶** button to select your time zone
- Press the Time Zone button again.
- Move the DST switch on back of unit to +1 or -1 (adds or subtracts an hour)

# Controls and Indicators

## Top Panel

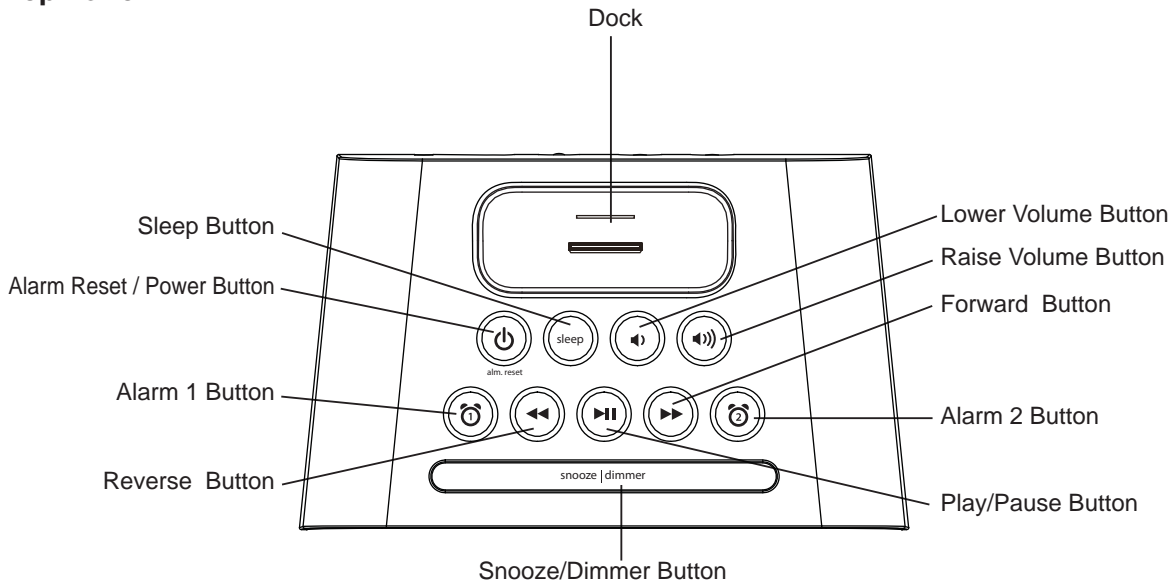

## Rear Panel

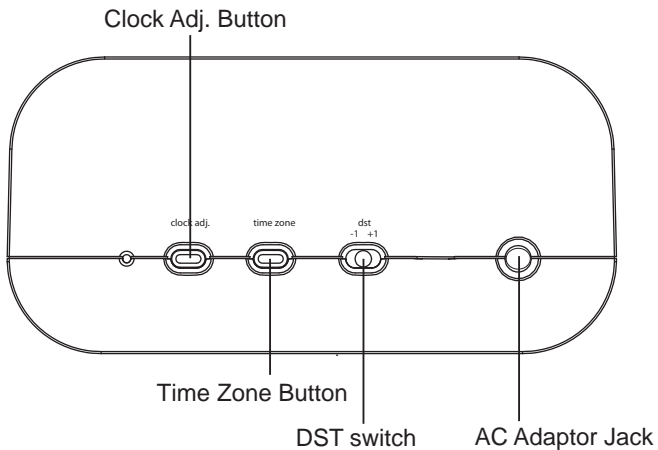

## Unit Display

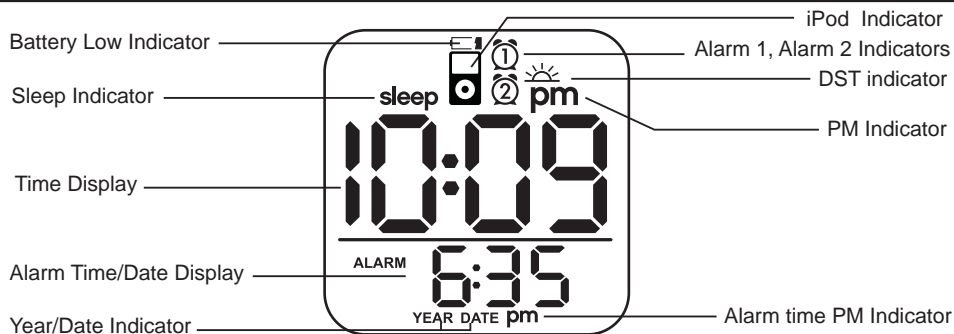

## Installing Clock Backup Batteries

The unit uses 3 AAA batteries (installed) for backup to provide continuous alarm operation and clock settings in the event of a power failure. If the backup batteries have been installed and a power failure occurs or the AC adaptor is accidentally disconnected, the display backlight will not remain lit, but current time and alarm time settings will be temporarily maintained. Otherwise, you must reset the time and alarm settings.

**Note:** You should replace backup batteries when the **Battery Low Indicator** appears on the display.

1. Please make sure the AC adaptor is connected. Otherwise all settings may be lost during battery replacement.
2. Open backup battery compartment door located on the bottom of the unit.
3. Insert three "AAA" batteries, checking the + and - ends of the batteries. We recommend to use alkaline battery for longer life time. Do not mix alkaline, standard (carbon-zinc) or rechargeable (nickel-cadmium) batteries.
4. Close the compartment cover.

**Note:** Make sure you dispose of batteries properly (see your local regulations).

### Battery Low Indicator

The **Battery Low Indicator** is located in the top of display. When it lights up it is time to replace backup batteries.

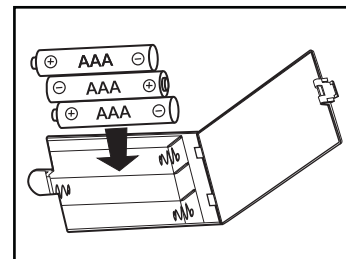

## Installing iPod Insert

Your unit comes with 2 inserts to ensure your iPod fits properly in the dock on the top of the system. If the inserts that come with the unit do not match your iPod model, use the insert that came with your iPod or visit [www.ihomeaudio.com](http://www.ihomeaudio.com) or call 1-800-288-2792 toll free to purchase the proper insert for our iPod model.

To place an insert:

1. Select the insert for your iPod. Using the correct insert ensures the proper fit to your iPod.
2. Gently press the iPod insert into the dock.
3. Carefully place your iPod into the dock. The iPod must not be in a case or "skin".
4. To remove/replace an insert, first remove your iPod then press down the insert latch, grip the insert and pull gently upwards.

## Using the Unit

This unit is a **PRESET Clock**: the time is already preset at the factory. Simply match the time zone setting to where you live.

1. Depending on your location and whether or not Daylight Saving Time (DST) is in effect, set the **DST Switch** located on the back of the unit to +1 to add an hour or to -1 to subtract an hour to/from the currently displayed time.
2. Press and hold the **Time Zone Button** located on the back of the unit until the current time zone flashes. Press the **◀◀** or **▶▶** **Button** to select your time zone.
3. Press the **Time Zone Button** again (or no button within 10 seconds) to exit the setting mode.
4. If time displayed is not correct, see Setting Time and Calendar to set the clock.

### Setting Time and Calendar

1. Press and hold the **Clock Adjust Button** located on the back of the unit until the current time flashes on the display. Press the **◀◀** or **▶▶** **Button** to adjust to correct time (holding the button for a few seconds will advance or reverse rapidly).
2. Remember to set the correct **AM** or **PM** time. The **PM Indicator** is located above the minute digits.
3. Press the **Clock Adjust Button** again to adjust year. Press the **◀◀** or **▶▶** **Button** until the current year is displayed.
4. Press the **Clock Adjust Button** again to adjust month and date. Press the **◀◀** or **▶▶** **Button** until the current month/date is displayed. Holding the button for a few seconds will advance or reverse rapidly.
5. Press the **Clock Adjust Button** again (or no button within 10 seconds) to exit the time/calendar setting mode. You will hear two beeps to confirm Time and Calendar setting are completed.

### Using the Alarms

#### Setting the Alarms

1. By default, the unit selects iPod as your wake source. If no iPod is docked or detected, the unit will automatically default to buzzer alarm.  
**Note:** make sure you have an hour of audio on your iPod.
2. Press and hold the **🔔 Button** until the current alarm time flashes in the lower part of the display. Press the **◀◀** or **▶▶** **Button** to set the alarm time. Remember to set the correct AM or PM time.
3. Press the **🔔 Button** (or if no button is pressed within 10 seconds). Two beeps will confirm alarm time and exit alarm setting mode. The alarm will be armed and the corresponding alarm icon will appear.
4. To set Alarm 2 just follow steps 2 - 3 using the **🔔 Button**.

#### Reviewing, Arming and Disarming Alarm (Turn Alarm Function On and Off)

1. Once an alarm is set, it is armed and the lower part of the display will show the alarm time. If both alarms are armed, the earliest alarm time will show.
2. To arm/disarm the alarm, just press the associated alarm button to toggle it on or off. If the alarm is armed, the related alarm icon will appear in the upper part of the display.

#### Resetting the Alarm to Come on the Next Day

1. When the alarm is sounding, press the **🕒 Button** to stop alarm and reset it to come on the following day.

# Using the Unit

## Snooze Operation

1. Press and hold the **Snooze/Dimmer Button** for a few seconds during normal operation (alarm is not sounding) to set snooze time. Press the **◀◀** or **▶▶** **Button** to set the snooze timer from 1 to 30 minutes.
2. Press the **Snooze/Dimmer Button** after the alarm sounds. The alarm will be silenced and come on again after the set snooze time. Snooze can be pressed several times during the 1 hour alarm cycle.

## Sure Alarm



The unit has a sure alarm feature. If backup batteries are installed, the buzzer alarm will still sound in the event of power failure.

## Charging your iPod

**Note:** Please make sure you are using the correct insert for your iPod (see Installing iPod Insert) and that the iPod is properly docked into the unit.

1. While your iPod is docked in the unit and the unit is connected to AC power, it recharges (until fully charged). Backup batteries will NOT charge iPod. Note that non-docking iPod models will NOT charge.

## Listening to your iPod

1. Dock your already playing iPod. The unit will automatically turn on and you will hear the music playing from your iPod.  
**Note:** If the volume on the playing track is too low, the unit may not detect that your iPod is in play mode. If this happens, press the **▶||** **Button** on the main unit to play it.
2. When the iPod is docked and in standby mode, press the **▶||** **Button** on the unit to play it. The  will appear on the display, indicating iPod play mode.
3. Press the **▶||** **Button** again to pause play; press again to resume it.
4. Press the **Volume**  and **Volume**  **Button** to adjust the system volume.
5. Press the **◀◀** or **▶▶** **Button** on the unit to go to the next or previous track. Press and hold while a track is playing for high speed forward or reverse music search of the current track.
6. To turn off the unit, press the **⏻** **Button**. The iPod will continue charging while in the dock.



## Using the Unit

### Sleep Operation

Sleep mode lets you sleep to your iPod until the unit shuts off at a selected time.

1. Press the **Sleep Button** to enter sleep mode. The Sleep Icon will appear on the display to indicate it is in sleep mode.
2. Press the **Sleep Button** as needed to adjust the sleep timer from 90, 60, 30 or 15 minutes (or turn sleep off).
3. When the display changes back to show the real time, press the **Sleep Button** once to show the sleep time remaining. Pressing it again to change sleep time to the next lowest increment.
4. To stop listening at any time, press the **⏻ Button** to turn unit off.

### Dimmer Operation

During normal operation, press the **Snooze/Dimmer Button** to control the brightness of the LCD display.

# IMPORTANT SAFETY INSTRUCTIONS

When used in the directed manner, this unit has been designed and manufactured to ensure your personal safety. However, improper use can result in potential electrical shock or fire hazards. Please read all safety and operating instructions carefully before installation and use, and keep these instructions handy for future reference. Take special note of all warnings listed in these instructions and on the unit.

1. **Water and Moisture** – The unit should not be used near water. For example: near a bathtub, washbowl, kitchen sink, laundry tub, swimming pool or in a wet basement.
2. **Ventilation** – The unit should be situated so that its location or position does not interfere with its proper ventilation. For example, it should not be situated on a bed, sofa, rug or similar surface that may block ventilation openings. Also, it should not be placed in a built-in installation, such as a bookcase or cabinet, which may impede the flow of air through the ventilation openings.
3. **Heat** – The unit should be situated away from heat sources such as radiators, heat registers, stoves or other appliances (including amplifiers) that produce heat.
4. **Power Sources** – The unit should be connected to a power supply only of the type described in the operating instructions or as marked on the appliance.
5. **Power-Cable Protection** – Power supply cables should be routed so that they are not likely to be walked on or pinched by items placed upon or against them. It is always best to have a clear area from where the cable exits the unit to where it is plugged into an AC socket.
6. **Cleaning** – The unit should be cleaned only as recommended. See the Maintenance section of this manual for cleaning instructions.
7. **Objects and Liquid Entry** – Care should be taken so that objects do not fall and liquids are not spilled into any openings or vents located on the product.
8. **Attachments** – Do not use attachments not recommended by the product manufacturer.
9. **Lightning and Power Surge Protection** – Unplug the unit from the wall socket and disconnect the antenna or cable system during a lightning storm or when it is left unattended and unused for long periods of time. This will prevent damage to the product due to lightning and power-line surges.
10. **Overloading** – Do not overload wall sockets, extension cords, or integral convenience receptacles as this can result in a risk of fire or electric shock.
11. **Damage Requiring Service** – The unit should be serviced by qualified service personnel when:
  - A. the power supply cable or plug has been damaged.
  - B. objects have fallen into or liquid has been spilled into the enclosure.
  - C. the unit has been exposed to rain.
  - D. the unit has been dropped or the enclosure damaged.
  - E. the unit exhibits a marked change in performance or does not operate normally.
12. **Periods of Nonuse** – If the unit is to be left unused for an extended period of time, such as a month or longer, the power cable should be unplugged from the unit to prevent damage or corrosion.
13. **Servicing** – The user should not attempt to service the unit beyond those methods described in the user's operating instructions. Service methods not covered in the operating instructions should be referred to qualified service personnel.

## Trouble Shooting

Symptom	Possible Problem	Solution
Unit doesn't respond (no power)	Wall outlet is not functioning	Plug another device into the same outlet to confirm the outlet is working
iPod does not dock properly	Using no or wrong iPod insert	Make sure the dock insert is the proper one for your iPod
	Dock or connector is obstructed	Remove your iPod from the dock and check for obstruction on the connectors in the dock and on your iPod. Then reseal it in the dock.
iPod does not respond to the unit	iPod is not docked properly	Remove your iPod from the dock and check for obstruction on the connectors in the dock and on your iPod. Then reseal it in the dock.
	Your iPod software is too old	Upgrade software on your iPod via iTunes
	iPod is locked up	Please refer to your iPod manual for details. Please make sure your iPod is working properly before docking in the unit.
iPod doesn't charge up	iPod is not docked properly	Remove your iPod from the dock and check for obstruction on the connectors in the dock and on your iPod. Then reseal it in the dock.
	Using 3rd generation iPod	This unit doesn't support 3rd generation iPod
	iPod is locked up/frozen	Please refer to your iPod manual for details. Please make sure your iPod is working properly before dock into the unit.
	iPod battery has problem	
Sound is distorted	Volume level is set too high	Decrease the volume.

# Limited 90-Day Warranty Information

---

eKids warrants this product to be free from defects in workmanship and materials, under normal use and conditions, for a period of 90 days from the date of original purchase.

Should this product fail to function in a satisfactory manner, it is best to first return it to the store where it was originally purchased. Should this fail to resolve the matter and service still be required by reason of any defect or malfunction during the warranty period, eKids will repair or, at its discretion, replace this product without charge (except for a \$10.00 charge for handling, packing, return UPS/postage, and insurance). This decision is subject to verification of the defect or malfunction upon delivery of this product to the Factory Service Center listed below. The product must include proof of purchase, including date of purchase. The fee for service without proof of purchase is

\$35.00. Before returning this product for service, please first replace the batteries (if applicable) with fresh ones, as exhausted or defective batteries are the most common cause of problems encountered.

If service is still required:

1. Remove the batteries (if applicable) and pack the unit in a well padded, heavy corrugated box.
2. Enclose a photocopy of your sales receipt, credit card statement, or other proof of the date of purchase, if within the warranty period.
3. Enclose a check or money order payable to the order of eKids, for the sum of \$10.00 (\$35.00 without proof of purchase).
4. Send the unit prepaid and insured, to the Factory Service Center listed below.

**Consumer Repair Department  
eKids  
1330 Goodyear Drive  
El Paso, TX 79936-6420**

## Disclaimer of Warranty

NOTE: This warranty is valid only if the product is used for the purpose for which it was designed. It does not cover (i) products which have been damaged by negligence or willful actions, misuse or accident, or which have been modified or repaired by unauthorized persons; (ii) cracked or broken cabinets, or units damaged by excessive heat; (iii) damage to digital media players, CD's or tape cassettes (if applicable); (iv) the cost of shipping this product to the Factory Service Center and its return to the owner.

This warranty is valid only in the United States of America and does not extend to owners of the product other than to the original purchaser. In no event will eKids or any of its affiliates, contractors, resellers, their officers, directors, shareholders, members or agents be liable to you or any third party for any consequential or incidental damages, any lost profits, actual, exemplary or punitive damages. (Some states do not allow limitations on implied warranties or exclusion of consequential damages, so these restrictions may not apply to you.) This warranty gives you specific legal rights, and you may also have other rights which vary from state to state.

Your acknowledgement and agreement to fully and completely abide by the above mentioned disclaimer of warranty is contractually binding to you upon your transfer of currency (money order, cashier's check, or credit card) for purchase of your eKids product.

**Questions? Visit [www.ekids.com](http://www.ekids.com)  
For any other questions: 1-800-288-2792 Toll Free  
©2011 SDI Technologies, Inc. All Rights Reserved.  
Home is a registered trademark of SDI Technologies Inc.,  
used under license.**

**© The Muppets Studio, LLC. All Rights Reserved.  
© Disney All Rights Reserved  
Visit the Disney website at [DisneyXD.com](http://DisneyXD.com)**

## Free Manuals Download Website

<http://myh66.com>

<http://usermanuals.us>

<http://www.somanuals.com>

<http://www.4manuals.cc>

<http://www.manual-lib.com>

<http://www.404manual.com>

<http://www.luxmanual.com>

<http://aubethermostatmanual.com>

Golf course search by state

<http://golfingnear.com>

Email search by domain

<http://emailbydomain.com>

Auto manuals search

<http://auto.somanuals.com>

TV manuals search

<http://tv.somanuals.com>