

PrecisionSwirl™ Module

310554V

ENG

An orbital dispenser used to apply sealant and adhesive materials for a variety of applications.

Part No. 241658, 234029, 289911 and 289912

3500 psi (24.1 MPa, 241 bar) Maximum Fluid Working Pressure



Important Safety Instructions

Read all warnings and instructions in this manual.
Save these instructions.

See page 2 for List of Models.

U.S. Patent No. 6,499,673

EU Patent No. 0852160

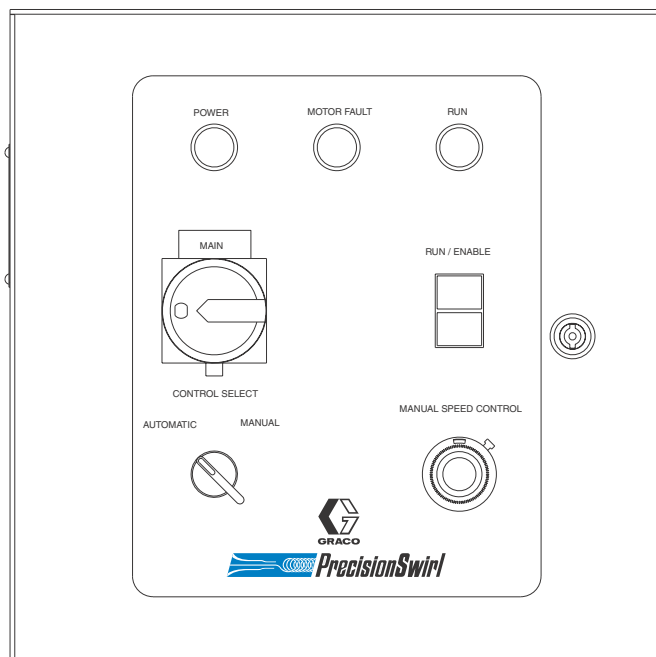

PrecisionSwirl Control Assembly
918616

8037B

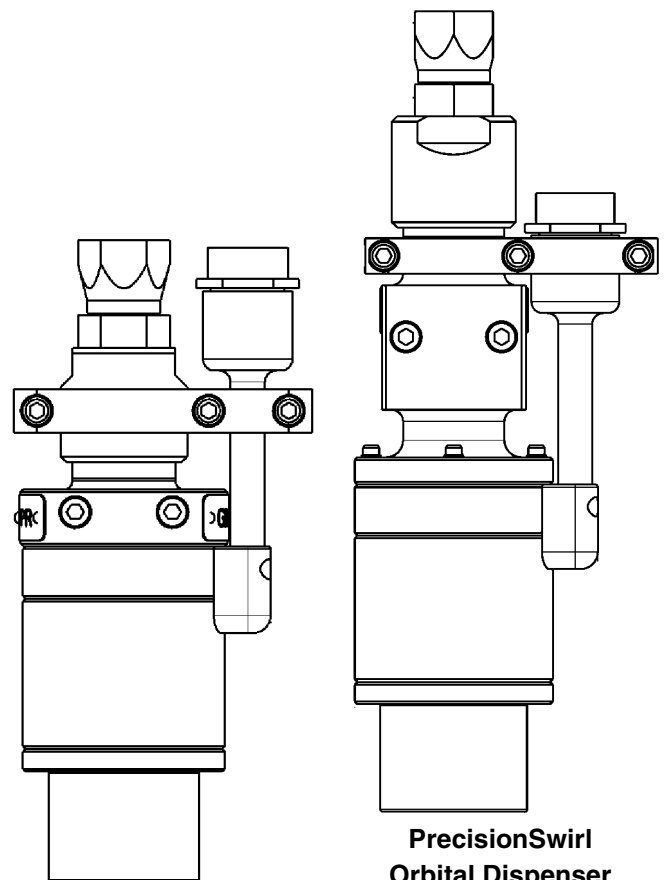

**PrecisionSwirl
Orbital Dispenser**
289261 and 289262

**PrecisionSwirl
Orbital Dispenser**
243402 and 243403



HO03

List of Models

Tool Mounted Dispensers

Part No. 241658, Series A

PrecisionSwirl Orbital Dispenser and Control Assembly
Kit includes 233123, 243403, 617829, 617870 and 918616.

Part No. 234029, Series A

PrecisionSwirl Orbital Dispenser and Control Assembly
Kit includes 233123, 243402, 617829, 617870 and 918616.

Part No. 289911, Series A

PrecisionSwirl Orbital Dispenser and Control Assembly
Kit includes 233123, 289261, 617829, 617870 and 918616.

Part No. 289912, Series A

PrecisionSwirl Orbital Dispenser and Control Assembly
Kit includes 233123, 289262, 617829, 617870 and 918616.

Part No. 918616, Series D

PrecisionSwirl Control Assembly

Cable Assemblies

Part No. 233125

6 ft (1.8 m) Motor Extension Cable Assembly

Part No. 233124

9 ft (2.7 m) Motor Extension Cable Assembly

Part No. 233123

15 ft (4.6 m) Motor Extension Cable Assembly

Part No. 617870

55 ft (16.8 m) Motor Extension Cable Assembly

Part No. 617829

40 ft (12.2 m) Robot Interface Cable Assembly

Tool Mount

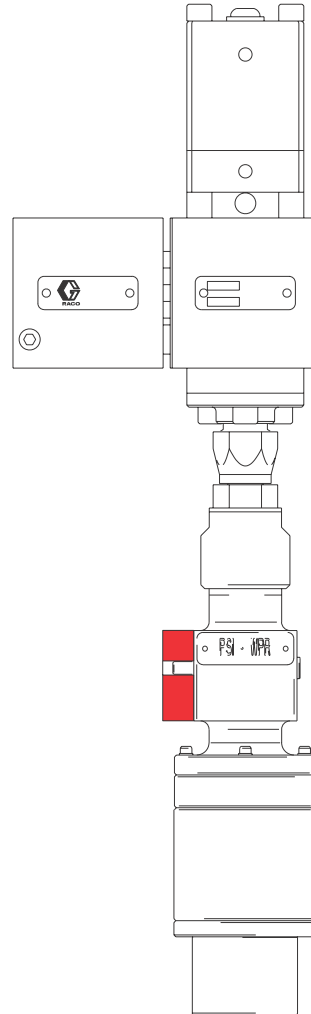

8130B

FIG. 1

Contents

List of Models	2	Control Assembly Service	26
Tool Mounted Dispensers	2	Servicing the Control Assembly	26
Cable Assemblies	2	Lamp Button and Switch Removal	26
Warnings	4	Lamp Button and Switch Replacement	26
Unpacking and Repacking	8	Light Bulb Removal	26
Unpacking the Product	8	Light Bulb Replacement	26
Repair and Repacking the Product	8	MAIN Power Switch Removal	27
PrecisionSwirl Overview	9	MAIN Power Switch Replacement	27
PrecisionSwirl Capabilities	9	Potentiometer Removal	28
PrecisionSwirl in Basic Robotic System	10	Potentiometer Replacement	28
Installing the Control Assembly	11	Panel Assembly Service	29
Preparing to Install the Control Assembly	11	Swirl Control Board Removal	30
Mounting the Control Assembly	11	Swirl Control Board Replacement	30
Mounting the Control Assembly (continued)	12	RFI Filter Removal	31
Installation	13	RFI Filter Replacement	31
Grounding the Control Assembly	13	Relay Removal	32
Connecting the Control Assembly to a Power		Relay Replacement	32
Source	14	Fuse Removal	33
Connecting the Control Assembly to a Power		Fuse Replacement	33
Source (continued)	15	Control Assembly Parts	34
Checking Resistance Between the Control		Accessory Parts	40
Assembly and the True Earth Ground	15	Motor Control Cable Assemblies	40
Installing the Dispense Valve	16	Torsional Motor Control Cable Assemblies	41
Mounting the Dispense Valve	16	Robot Interface Cable Assembly	42
Connecting Air Lines to Dispense Valve	16	Dispenser Valve Adapter Fittings	42
Connecting Material Hose to Dispense Valve	16	Wiring Diagrams	43
Installing Cable Assemblies	17	Motor Controller Wiring, Lines 200-238	43
Connecting the Motor Control Cable	17	Motor Controller Wiring, Lines 250-288	44
Connecting the Motor Control Cable (continued)	18	Technical Data	45
Connecting the Automatic Control Cable	19	Graco Standard Warranty	46
Verifying Ground Continuity	20	Graco Information	46
Verifying Ground Continuity	20		
Adjusting the Orbital Dispenser	20		
Inspecting the Orbital Dispenser	20		
Grounding the System	20		
PrecisionSwirl Module Operation	21		
Reading the PrecisionSwirl Control Assembly			
Controls and Indicators	21		
Setting Operation Modes	22		
Analyzing Causes for a Motor Fault Alarm	23		
Adjusting Orbital Dispenser Motor Speed	24		
Troubleshooting	25		

Warnings

The following warnings are for the setup, use, grounding, maintenance, and repair of this equipment. The exclamation point symbol alerts you to a general warning and the hazard symbol refers to procedure-specific risk. Refer back to these warnings. Additional, product-specific warnings may be found throughout the body of this manual where applicable.

WARNING



EQUIPMENT MISUSE HAZARD

Equipment misuse can cause the equipment to rupture, malfunction, or start unexpectedly and result in serious injury.

- This equipment is for professional use only.
- Read all instruction manuals, warnings, tags, and labels before operating the equipment.
- Use the equipment only for its intended purpose. If you are uncertain about usage, call your Graco distributor.
- Do not alter or modify this equipment. Use only genuine Graco parts and accessories.
- Check the equipment daily. Repair or replace worn or damaged parts immediately.
- Do not exceed the maximum fluid working pressure of 3500 psi (241 bar, 24.1 MPa) to the dispenser or manifold.
- Never exceed the recommended working pressure or the maximum air inlet pressure stated on your pump or in the **Technical Data** section on page 63.
- Be sure that all spray/dispensing equipment and accessories are rated to withstand the maximum working pressure of the pump. Do not exceed the maximum working pressure of any component or accessory used in the system.
- Route hoses and cables away from traffic areas, sharp edges, moving parts, and hot surfaces.
- Do not expose Graco standard hoses to temperatures above 180° F (82° C) or below -40° F (-40° C).
- Do not use the hoses to pull the equipment.
- Use only fluids and solvents that are compatible with the equipment wetted parts. See the **Technical Data** sections of all the equipment manuals. Read the fluid manufacturer's warnings.
- Always wear protective eyewear, gloves, clothing, and respirator as recommended by the fluid and solvent manufacturers.
- Comply with all applicable local, state, and national fire, electrical, and other safety regulations.

WARNING
**SKIN INJECTION HAZARD**

Spray from the applicator, hose leaks, or ruptured components can inject fluid into your body and cause extremely serious injury, including the need for amputation. Fluid splashed in the eyes or on the skin can also cause serious injury.

- Fluid injected into the skin might look like just a cut, but it is a serious injury. **Get immediate surgical treatment.**
- Do not point the applicator at anyone or at any part of the body.
- Do not put hand or fingers over the front of the applicator.
- Do not stop or deflect fluid leaks with your hand, body, glove, or rag.
- Follow the **Pressure Relief Procedure** from manual 309403 whenever you are instructed to: relieve pressure; stop dispensing; clean, check, or service the equipment; or install or clean a nozzle.
- Tighten all the fluid connections before operating the equipment.
- Check the hoses, tubes, and couplings daily. Replace worn, damaged, or loose parts immediately. Permanently coupled hoses cannot be repaired; replace the entire hose.
- Always wear eye protection and protective clothing when installing, operating, or servicing this dispensing equipment.
- Do not remove or modify any part of the applicator; this can cause a malfunction and result in serious bodily injury.
- Use extreme caution when cleaning or changing nozzles. If the nozzle clogs while applying material, Always follow the **Pressure Relief Procedure** from manual 309403, then remove the nozzle to clean it.
- Never wipe off build-up around the nozzle or inlet cap until pressure is fully relieved.

**FIRE AND EXPLOSION HAZARD**

Improper grounding, poor air ventilation, open flames, or sparks can cause a hazardous condition and result in fire or explosion and serious injury.

- Ground the equipment and the object being dispensed. See **Grounding** on page 20.
- Ground the equipment and the object being sprayed, and all other electrically conductive objects in the dispense area. Proper grounding dissipates static electricity generated in the equipment. See **Grounding** on page 20.
- Do not use this equipment with flammable liquids.
- Keep the dispense area free of debris, including solvent, rags, and gasoline.
- If there is any static sparking or you feel an electric shock while using the equipment, **stop dispensing immediately.** Do not use the equipment until you have identified and corrected the problem.
- Be sure all electrical work is performed by a qualified electrician only.
- Have any checks, installation, or service to electrical equipment performed by a qualified electrician only.
- Be sure all electrical equipment is installed and operated in compliance with applicable codes.
- Be sure power is disconnected when servicing and repairing equipment.
- Before operating the equipment, extinguish all open flames or pilot lights in the dispense area.
- Do not smoke in the dispensing area.
- Keep liquids away from the electrical components
- Disconnect electrical power at the main switch before servicing the equipment.

 **WARNING**



TOXIC FLUID OR FUMES HAZARD

Hazardous fluids or toxic fumes can cause serious injury or death if splashed in the eyes or on the skin, swallowed, or inhaled.

- Provide fresh air ventilation to avoid the buildup of vapors from the fluid being dispensed.
- Know the specific hazards of the fluid you are using.
- Store hazardous fluid in an approved container. Dispose of hazardous fluid according to all local, state, and national guidelines.
- Always wear protective eyewear, gloves, clothing, and respirator as recommended by the fluid and solvent manufacturer.
- Avoid exposure to heated material fumes.

Unpacking and Repacking

Unpacking the Product

The PrecisionSwirl orbital dispenser and control assembly were carefully packaged for shipment by Graco. When the package arrives, perform the following procedure to unpack the units:

1. Inspect the shipping box carefully for shipping damage. Contact the carrier promptly if damage is discovered.
 2. Unseal the box and inspect the contents carefully. There should not be any loose or damaged parts in the bag.
 3. Compare the packing slip against all items included in the box. Any shortages or other inspection problems should be reported immediately.
 4. Store the box and packing materials in a safe place for future use. Graco recommends that all packing materials be saved in case the unit needs to be shipped again.
2. Place the orbital dispenser and any loose or damaged parts in the same bag and box used in the original shipment. Fill the box with filler material to minimize the possibility of damage.
 3. Seal the box tightly to protect its contents and prevent shipping damage.
 4. Insure your shipment for the proper replacement value of its contents.
 5. Ship the orbital dispenser **freight prepaid** to your authorized Graco distributor for service.

Repair and Repacking the Product

When the PrecisionSwirl orbital dispenser requires service, it is the purchaser's responsibility to have the unit repaired. As an option, the purchaser can have the unit repaired by an authorized Graco distributor. For additional information, read the following subsections.

On-site Service

PrecisionSwirl components are customarily serviced by the purchaser or an authorized Graco technician. When service is required, follow the **Service** procedures in this manual.

Service by an Authorized Graco Distributor

The PrecisionSwirl orbital dispenser can be serviced by an authorized Graco distributor *after* completing a Return Goods Authorization (RGA) form. The purchaser must re-package and ship the orbital dispenser to the Graco distributor. When repacking the orbital dispenser, perform the following steps:

1. Retrieve the original box and packing materials for shipment.

PrecisionSwirl Overview

PrecisionSwirl Capabilities

The PrecisionSwirl orbital dispenser is regulated through the control assembly. The orbital dispenser is used to swirl sealant and adhesives in a variety of applications.

In a basic robotic system, the control assembly serves as the interface between the robot controller and the orbital dispenser via an interface cable. Refer to **Robot Interface Cable Assembly** on page 52.

The orbital dispenser is operated either manually from the control assembly or automatically from a robot controller where the orbital dispenser is programmed to apply material continuously, or at interrupted intervals, or both. The orbital dispenser can be stopped, started, and regulated to suit the application, making high quality swirl patterns that hold form after the material is dispensed.

The orbital dispenser applies a continuous swirled bead of material directly on components in targeted areas, such as the hem flanges on car doors, the interior seams of the chassis, and on the fixed glass openings of autos.

Bead profile is “pre-shaped” in a uniform pattern of overlaid circular loops (see FIG. 2). Bead shape is affected by nozzle size, material composition, flow rate, stand off distance, and orbital dispenser motor speed. The oscillating nozzle on the orbital dispenser can apply an accurate swirled bead of material on vertical and horizontal planes.

The orbital dispenser is small enough to apply sealant and adhesives on any type of surface or material, and can be directed on any programmable path, including: a series of crevices, creases, or around a maze of straight lines, sharp angles, contours, curves, corners, and openings.

The material source for the orbital dispenser is commonly supplied via a dual ram pump fluid supply system, which can be equipped with filters, temperature conditioning, and a fluid supply header.

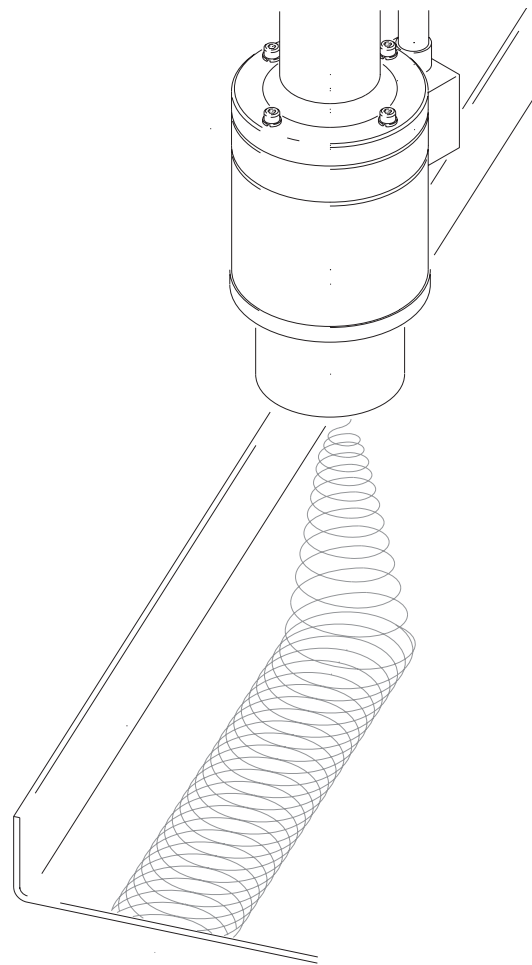

8128B

FIG. 2

PrecisionSwirl in Basic Robotic System

FIG. 3 shows the PrecisionSwirl components in a basic robotic system. The following list identifies the PrecisionSwirl components:

No.	Description
1	Control assembly (PrecisionSwirl)
2	Orbital dispenser (PrecisionSwirl)
4	Automatic control cable (PrecisionSwirl). Also called robot interface cable in this manual.
5	6, 9, or 15 ft (1.8, 2.7, or 4.6 m) flexible motor cable for robot mounting (PrecisionSwirl)
6	55 ft (16.8 m) motor cable (PrecisionSwirl)
7	Dispense valve (not included)
8	Sealer robot
9	Robot controller
10	Fluid supply system
11	Fluid supply header

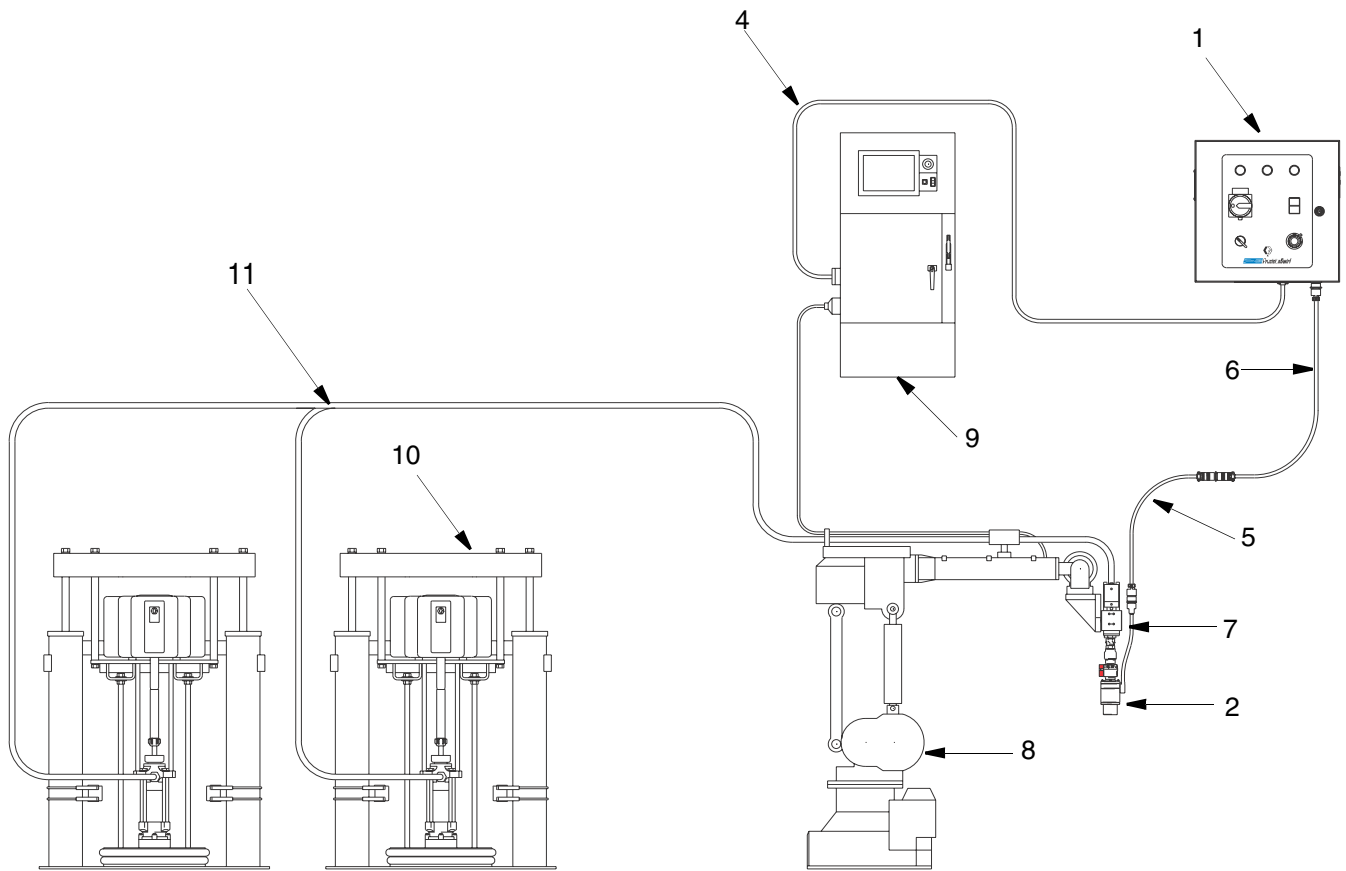



8024B

FIG. 3

Installing the Control Assembly

To install the control assembly:



- Prepare to install the control assembly
- Mount the control assembly
- Ground the control assembly (electrically)
- Connect control assembly to a power source
- Check resistance between the control assembly and a true earth ground.

							
<p>ELECTROCUTION HAZARD</p> <p>Installing and servicing this equipment requires access to parts which could cause an electric shock or other serious injury. Have only qualified electricians access the control assembly.</p>							

Preparing to Install the Control Assembly

Before installing the control assembly:

- See component manuals for specific data on component requirements, such as a robot. Data presented here pertains to the PrecisionSwirl control assembly only.
- Have all applicable documentation available during installation.
- Use only the Graco PrecisionSwirl control assembly with the PrecisionSwirl applicator.

							
<p>EQUIPMENT MISUSE HAZARD</p> <p>The PrecisionSwirl control assembly weighs approximately 23.5 lb (10.7 kg). Exercise care when mounting and handling the control assembly to prevent equipment damage or personal injury.</p>							

Mounting the Control Assembly

1. Select a location to mount the PrecisionSwirl control assembly. Keep the following in mind:

Allow sufficient space for mounting and using the equipment:

- Mount the control assembly approximately 24-67 in. (0.6-1.7 m) above the floor.
 - **Make sure all cables reach components without strain.**
 - Make sure there is sufficient space for repair, maintenance, and operation of the robot and applicator. The National Electrical Code requires 3 ft (91.4 cm) of open space in front of the control assembly.
 - Make sure there is sufficient clearance around the control assembly for running fluid lines and cables to other components.
 - Make sure there is easy and safe access to an appropriate electrical power source.
2. Secure the PrecisionSwirl control assembly with four 1/4 in. bolts through the 0.31 in. diameter holes in the mounting flanges. See FIG. 4 for the mounting hole spacing in the control assembly.

Mounting the Control Assembly (continued)

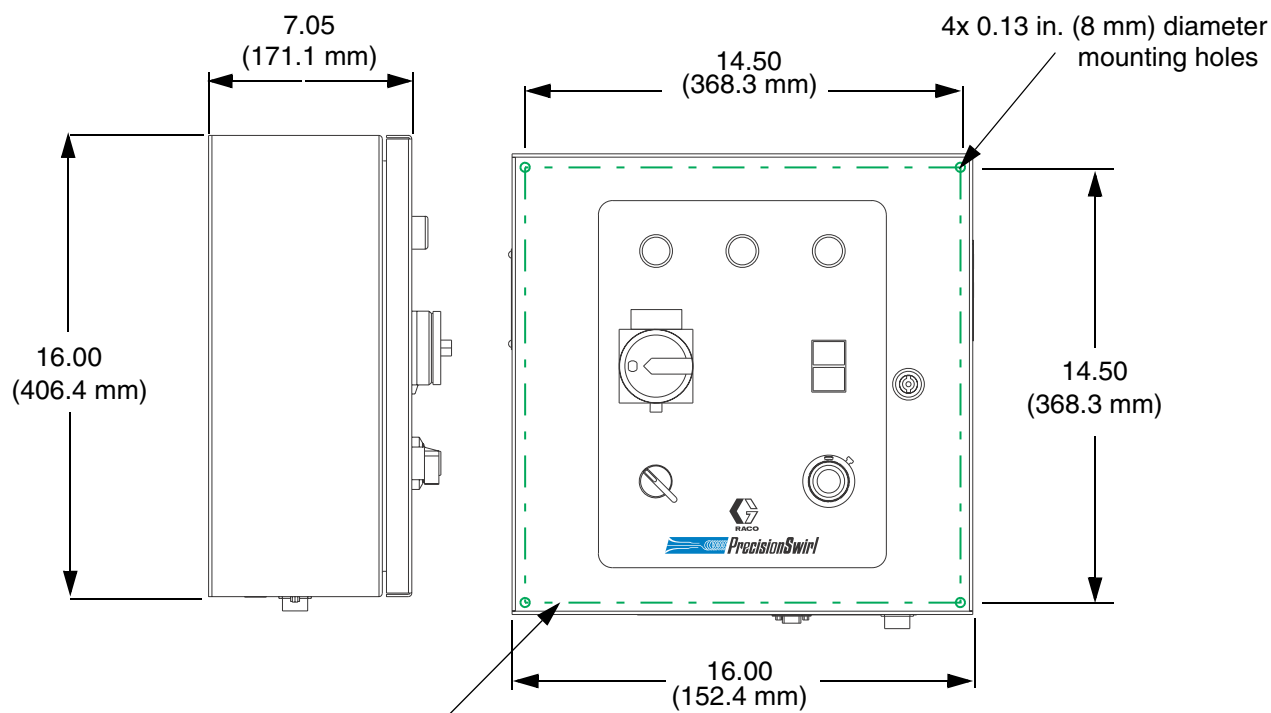

NOTE: Hidden lines depict the hole pattern for mounting the control assembly.

NOTE: Control assembly must be readily accessible and located 24-67 in. (0.6-1.7 m) above the floor.

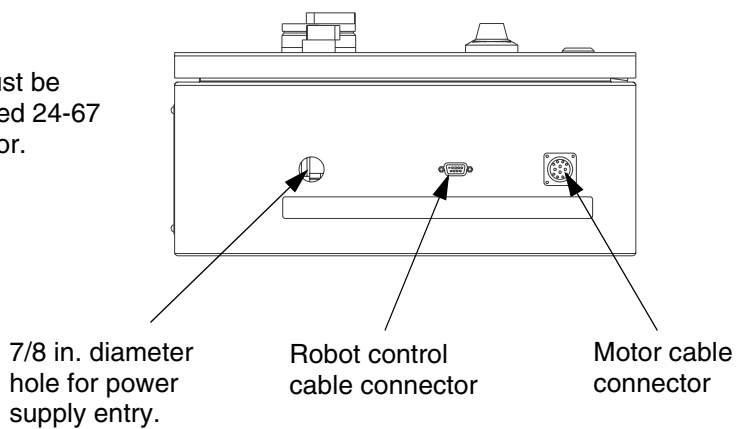

FIG. 4

Installation

Grounding the Control Assembly

--	--	--	--	--	--	--

FIRE, EXPLOSION, AND ELECTRIC SHOCK HAZARD

To reduce the risk of fire, explosion, or electric shock:

- The PrecisionSwirl control assembly must be electrically connected to a true earth ground; the ground in the electrical system may not be sufficient.
- All wires used for grounding must be 8 AWG (8.36 mm²) minimum.
- A qualified electrician must complete all grounding and wiring connections.
- Refer to your local code for the requirements for a “true earth ground” in your area.
- Also read and follow the warnings on page 4.

CAUTION

If power and grounding connections are not done properly, the equipment may be damaged and the warranty will be voided.

CAUTION

To help avoid damage to equipment, make sure that the robot and PrecisionSwirl equipment are grounded to the same point.

Connect a ground wire from the GND terminal in the PrecisionSwirl control assembly (shown in FIG. 5) to a true earth ground.

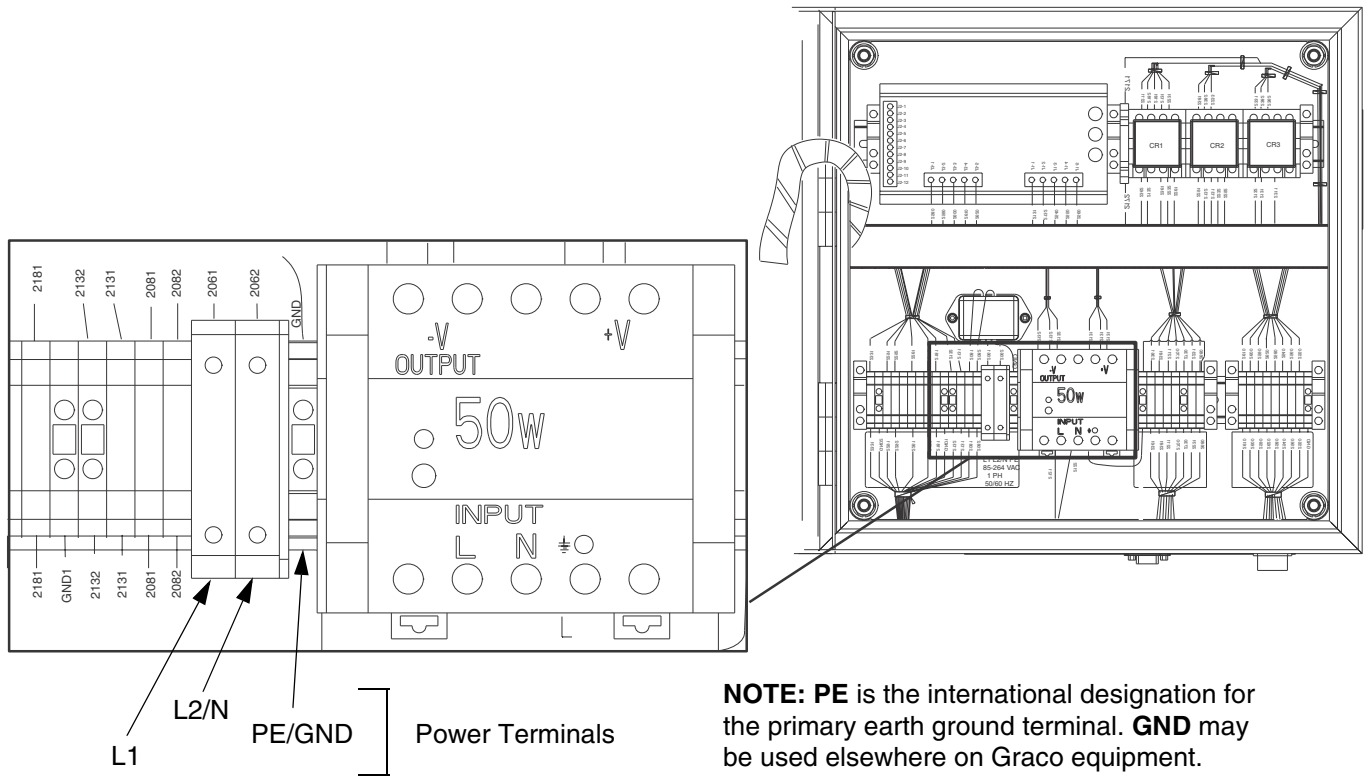

FIG. 5

Connecting the Control Assembly to a Power Source

Perform the following procedure to connect the control assembly to a power source.

<p>ELECTRIC SHOCK HAZARD</p> <p>Do not connect the PrecisionSwirl control assembly to a power source unless you are a trained electrician. Failure to follow standard procedures or to observe the necessary precautions could result in serious bodily injury or equipment damage.</p>					

CAUTION
<p>If power and grounding connections are not done properly, the equipment may be damaged and the warranty will be voided.</p>

Have a qualified electrician connect the PrecisionSwirl control assembly to a grounded electrical source that has the following required service ratings:

Description	Requirements
Vac	100-240
Hz	50/60
Phase	1
Full Load Amps	0.42 at 120 Vac
Circuit Breaker	5 Amp

Power to the control assembly must be supplied from a source with a lockable-off disconnect switch, or by use of a cord with a plug-and-socket connection to the source of power.

To connect the control assembly to the electrical source:

1. Shut off system power at the main circuit breaker.
2. Locate the opening on the bottom of the control assembly, labeled POWER SUPPLY. See FIG. 6.

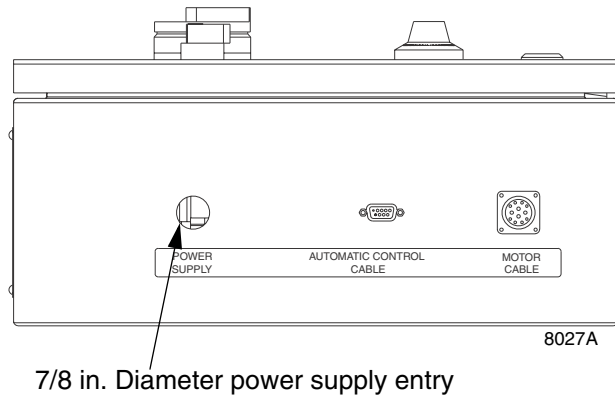

FIG. 6

3. Using 16 AWG wire or larger, connect electrical power to L1 (hot), L2 (neutral) power terminals in the PrecisionSwirl control assembly. See FIG. 8.
4. Use a cord grip to seal the area where wires enter the control assembly.

Any fitting that is used to connect a power cord (or conduit for power wiring) to the control assembly must provide a liquid-tight seal.

5. Apply system power at the main circuit breaker.
6. Move the POWER switch to the ON position, applying power to the control assembly.

Connecting the Control Assembly to a Power Source (continued)

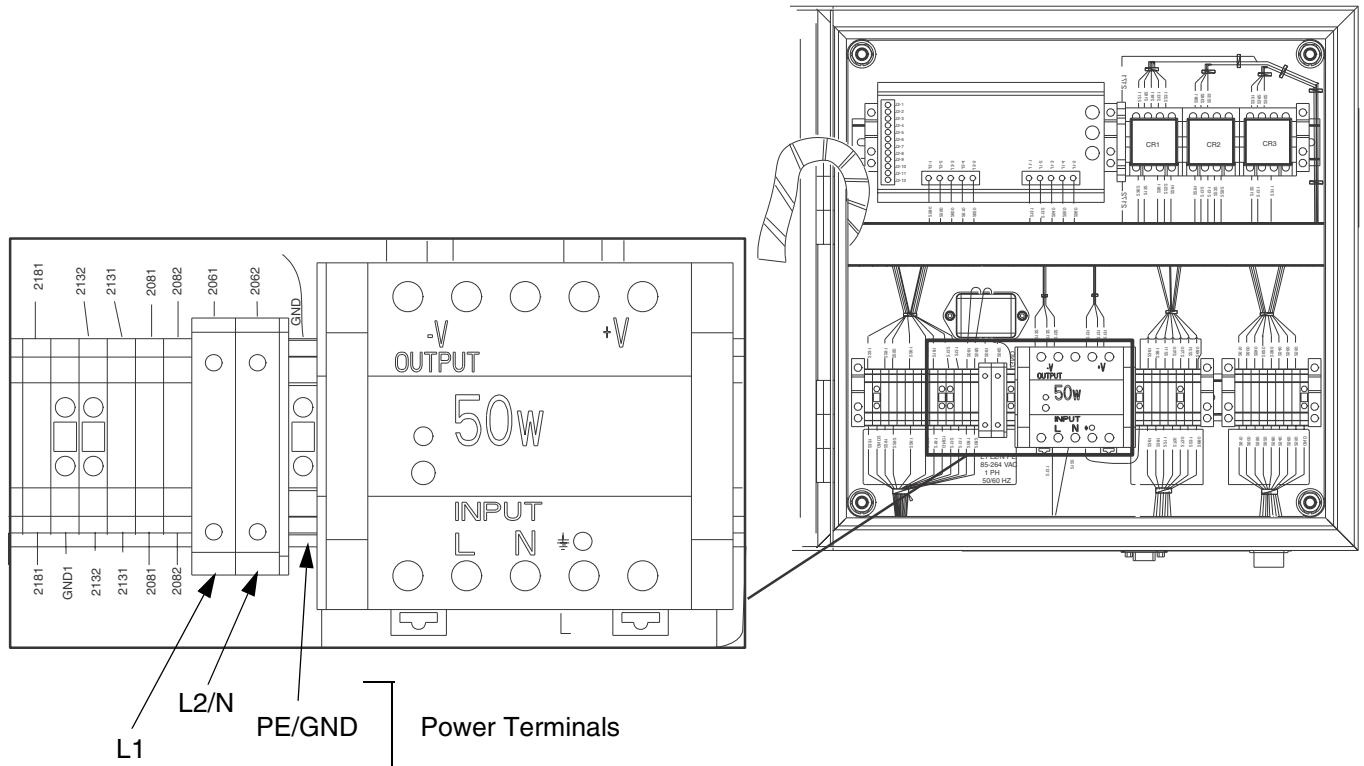

FIG. 7

Checking Resistance Between the Control Assembly and the True Earth Ground

FIRE, EXPLOSION, AND ELECTRIC SHOCK HAZARD						
To reduce the risk of fire, explosion, or electric shock, the resistance between the supply unit components and true earth ground must be less than 0.25 ohms.						

Have a qualified electrician check the resistance between each system component and the true earth ground. The resistance must be less than 0.25 ohms. If the resistance is greater than 0.25 ohms, a different ground site may be required. Do not operate the PrecisionSwirl module until the problem is corrected.

Installing the Dispense Valve

To install the dispense valve:

- Mount the dispense valve
- Connect the air lines
- Connect material hose

Mounting the Dispense Valve

Attach the dispense valve to the mounting bracket on a stationary support or robotic arm, using two socket head screws (38) and flat washers (39).

 The customer must provide a four-way pneumatic valve, activated by a separate on/off dispense signal via the robot, to control material flow.

Connecting Air Lines to Dispense Valve

Securely connect air lines to dispense valve air ports (F). Make sure to connect the appropriate air lines to the appropriate ports.

Connecting Material Hose to Dispense Valve

Securely connect the material hose to dispense valve inlet port (A).

Refer to Dispense Valve manuals 308876 and 309376.

Installing Cable Assemblies

CAUTION

Always make connections to the control assembly with power turned off.

Connecting the Motor Control Cable

Motor control cables are supplied in four lengths, 6 ft (1.8 m), 9 ft (2.7 m), 15 ft (4.6 m), and 55 ft (16.8). The 55 ft cable may be used by itself. The 6 ft, 9 ft, and 15 ft cable must be used with the 55 ft cable.

To connect the motor cable between the control assembly and the orbital dispenser, do the following:

1. Locate the receptacle on the bottom of the control assembly that is labeled MOTOR CABLE. See FIG. 8.

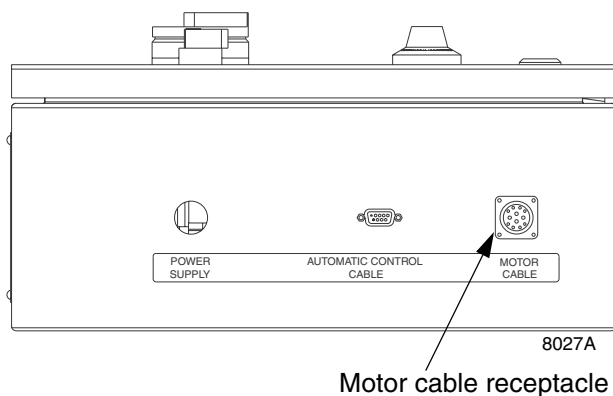

FIG. 8

2. Connect the orbital dispenser cable (55 ft) to the MOTOR CABLE receptacle. See FIG. 9.
3. Check the connections to ensure the cable is connected correctly.
4. Route the motor control cable and conform to the following cable routing requirements:
 - Avoid a bend radius of less than 5 in. (12.7 cm).
 - Avoid pinch points.
 - Avoid cable pulling or stretching.

- Keep cables from rubbing against other components or machinery.
- If a lot of robot wrist motion is required, leave sufficient cable length to allow for the motion, avoiding any cable droops that may interfere with the machinery or substrate.
- Route and secure the 7 in. motor cable to minimize any movement. The 7 in. motor cable is not intended to handle severe flexing motions.
- Cable ties should only be used to loosely bundle hoses together. Do not tighten cable ties to the point where cable movement is restricted.

Connecting the Motor Control Cable (continued)

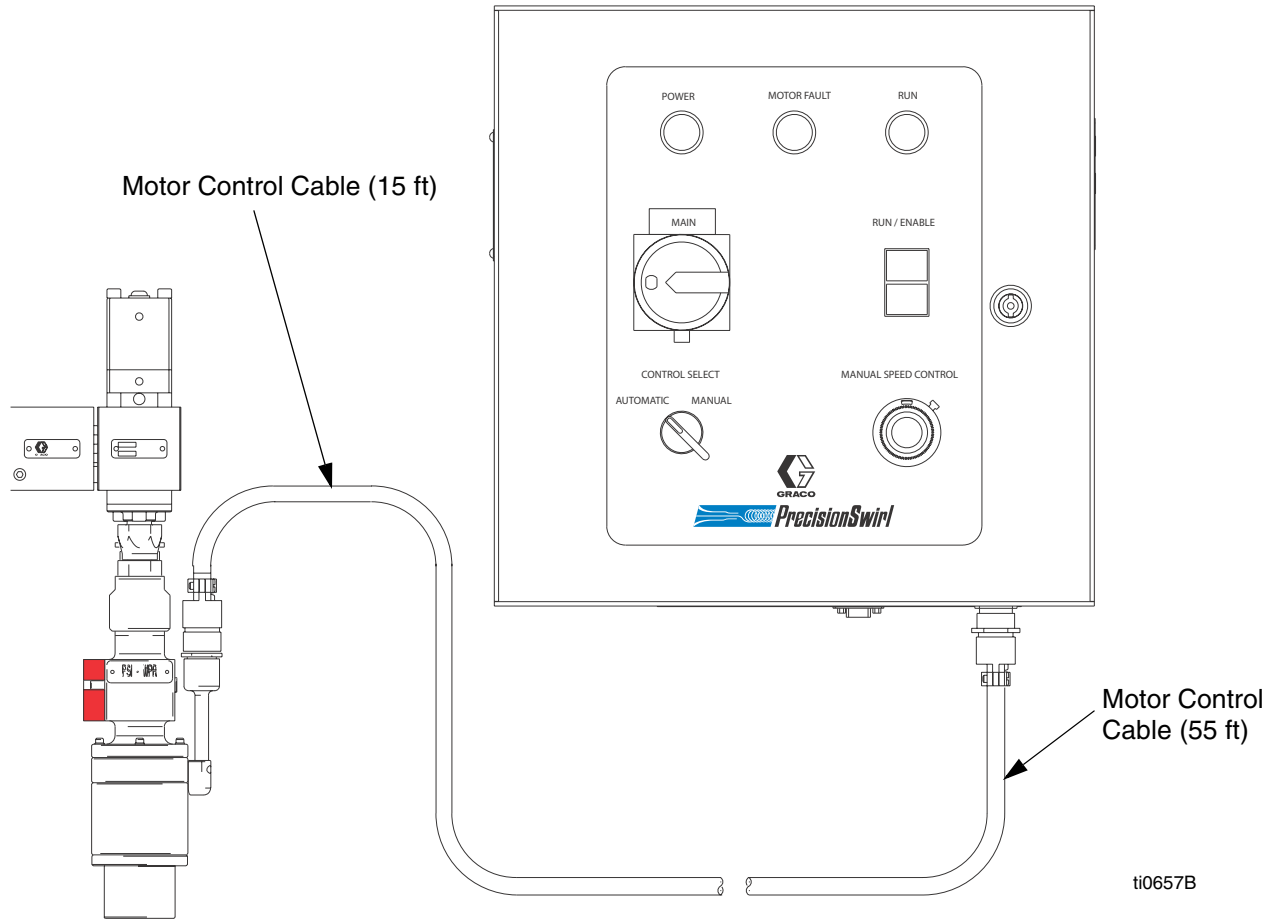



FIG. 9

Connecting the Automatic Control Cable

CAUTION

Always make connections to the control assembly with power turned off.

The PrecisionSwirl control assembly is provided with a 9-pin receptacle for the robot interface cable.

 Any wiring from an external source, such as a robot controller, must follow the robot manufacturer's instructions and must comply with the appropriate codes and standards.

To connect the automatic control cable (P/N 617829) between the control assembly and the robot, perform the following steps:

1. Locate the receptacle on the bottom of the control assembly that is labeled AUTOMATIC CONTROL CABLE. See FIG. 10.
2. Connect the cable assembly to the AUTOMATIC CONTROL CABLE receptacle in FIG. 10.
3. Secure the cable by tightening the two mounting screws.
4. Connect the opposite end of the cable assembly to the applicable terminals or receptacle on the robot controller.

For information about specific control assembly circuitry and connections, read the chart below and see the **Wiring Diagrams** on pages 56 and 57, and FIG. 11.

5. Check the connections to ensure the cable is connected correctly.

Automatic control cable receptacle

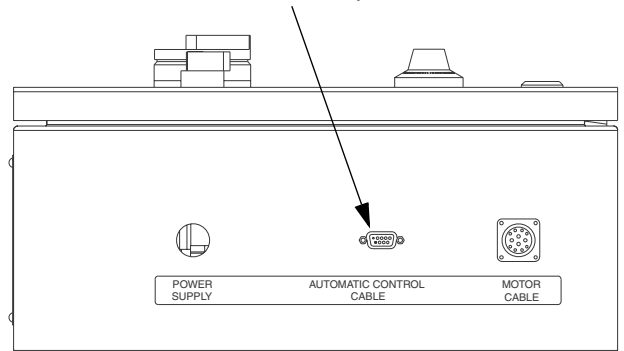

ti0827A

FIG. 10

Signal	Description
Enable	The 24V enable signal starts the orbital dispenser motor.
Swirl Speed Command	This 0-10 VDC analog signal is used to adjust the motor speed. (0-10 VDC = 6600-24,000 RPM)
Motor Fault Alarm	The alarm relay activates when the motor speed drops below 1500 RPM or does not start. The relay contacts are normally closed. A fault will be generated if any of the front panel controls are in the wrong position for automatic operation
Swirl Speed Readout	This analog signal can be used to monitor motor speed. (0-10 VDC = 0-24,000 RPM)

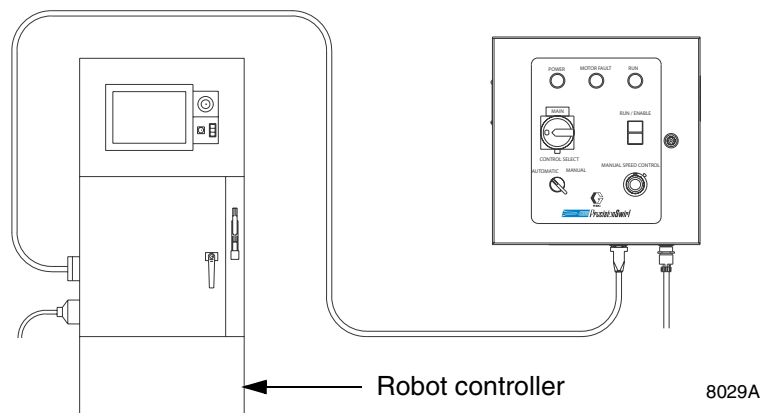

FIG. 11

Verifying Ground Continuity

Verifying Ground Continuity

Verify ground continuity between:

- True earth ground and the control assembly ground terminal
- The orbital dispenser and the robot

3. *Fluid and air hoses:* use only electrically conductive material and air hoses.
4. *Dispense gun:* obtain grounding through the connection of the hose, or cable.
5. *Air compressor:* follow the manufacturer's recommendations.
6. *Object being sprayed:* according to local code.
7. *Fluid supply container:* according to local code.

Adjusting the Orbital Dispenser



The PrecisionSwirl orbital dispenser is calibrated at the factory. No adjustment is required during initial setup.

Before applying power, read the reference information provided about controls and indicators to become familiar with the equipment.

Inspecting the Orbital Dispenser

Inspect the orbital dispenser cables, material, and air hoses daily for leakage and other visible damage.

Grounding the System

						
FIRE AND EXPLOSION HAZARD To reduce the risk of a fire, explosion, and serious injury, proper electrical grounding of every part of your system is essential. Read the warning section, FIRE AND EXPLOSION HAZARD , on page 5 and follow the grounding instructions below.						

The following grounding instructions are minimum requirements for a basic dispensing system. Your system may include other equipment or objects which must be grounded. Check your local electrical code for detailed grounding instructions for your area and type of equipment. Your system must be connected to a true earth ground.

1. *Pump:* connect a ground wire and clamp to a true earth ground as shown in separate pump manual.
2. *Orbital Dispenser:* obtain grounding through the motor cable assembly.

PrecisionSwirl Module Operation

Reading the PrecisionSwirl Control Assembly Controls and Indicators

Table 1 describes the controls on the PrecisionSwirl control assembly. See FIG. 12 for an illustration of the controls and indicators.

Table 1. Control Assembly Controls

Button/Switch	What it does
MAIN ON/OFF Switch	Controls power to the system. <ul style="list-style-type: none"> In the MAIN ON (I) position, system power is turned on. In the OFF (O) position, system power is turned off.
Control Select Switch AUTOMATIC / MANUAL	Switches the orbital dispenser to automatic or manual control. <ul style="list-style-type: none"> In the AUTOMATIC position, the orbital dispenser is controlled from a remote source, such as a robot, via an interface cable. In the MANUAL position, the orbital dispenser is controlled directly from the control assembly front panel.
RUN / ENABLE Button	Pushing the RUN/ENABLE (black) button starts the orbital dispenser motor in manual mode or enables the motor to be started in automatic mode.
STOP Button	Pushing the STOP (red) button removes power from the orbital dispenser.
MANUAL SPEED CONTROL Knob (potentiometer)	Regulates the motor speed of the orbital dispenser in the manual control mode. <ul style="list-style-type: none"> Rotating the control knob clockwise increases motor speed. Rotating the control knob counter-clockwise decreases motor speed.

Table 2 describes the indicators on the PrecisionSwirl control assembly. See FIG. 12 for an illustration of the controls and indicators.

Table 2. Control Assembly Indicators

Button/Switch	Indicator Light is	Meaning
POWER (white)	ON	Power is on.
	OFF	Power is off.
RUN (green)	ON	PrecisionSwirl orbital dispenser is ready for operation, or is operating in manual control mode.
	OFF	PrecisionSwirl orbital dispenser is not ready for operation, or is not operating in manual control mode.
MOTOR FAULT (red)	ON	Motor is not rotating. Or, the motor is rotating below the minimum speed.
	OFF	Motor is functioning properly.

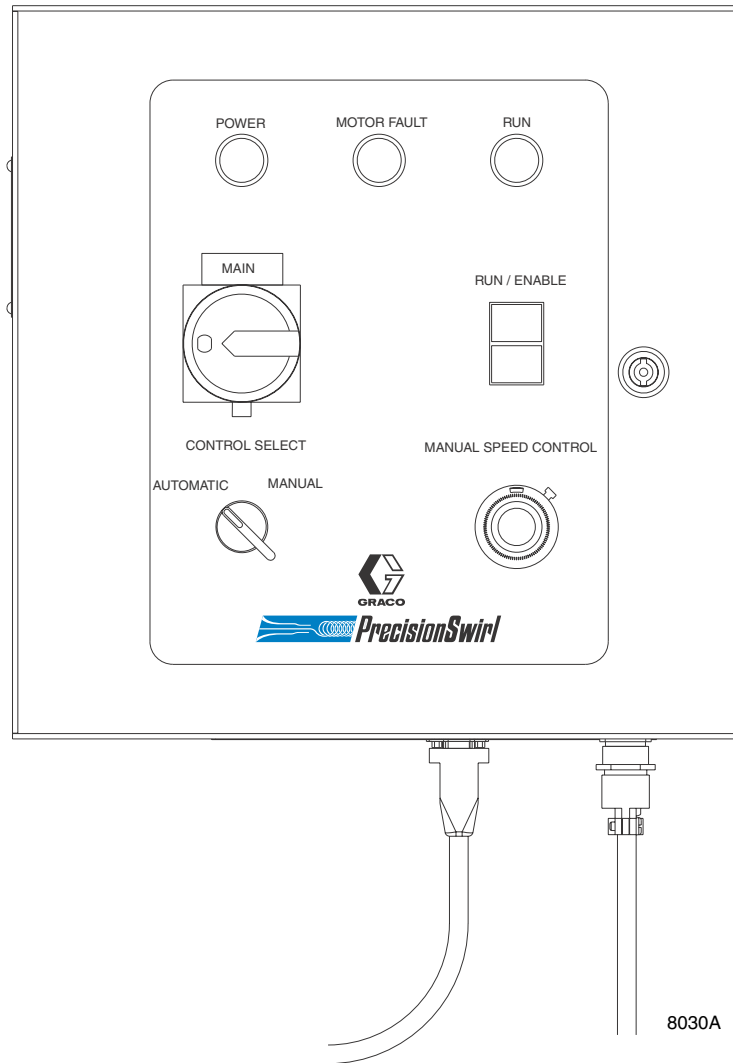



FIG. 12

Setting Operation Modes

The PrecisionSwirl module has two operating states:

- Automatic mode — enables the PrecisionSwirl orbital dispenser to be controlled by a remote signal source, such as a robot control. Motor speed can be controlled by a 0-10 VDC analog signal.
- Manual mode — enables the PrecisionSwirl orbital dispenser to swirl when you press the RUN/ENABLE button on the control assembly. Swirling continues until the STOP button is pressed.

 Material flow rate and “ON/OFF” flow are not controlled by the PrecisionSwirl orbital dispenser. These must be controlled by the other interfaces. Contact your Graco Distributor for assistance.

The PrecisionSwirl orbital dispenser is in an idle state until you press the RUN/ENABLE button on the control assembly. The only time the PrecisionSwirl orbital dispenser can swirl material is when the RUN/ENABLE button is pressed in either Automatic or Manual mode. When the STOP button is pressed, the PrecisionSwirl orbital dispenser becomes idle and will not swirl material.

The procedures in this section configure the module for manual or automatic operation.

Using Automatic Mode

Entering Automatic Mode

To put the PrecisionSwirl module into Automatic mode:

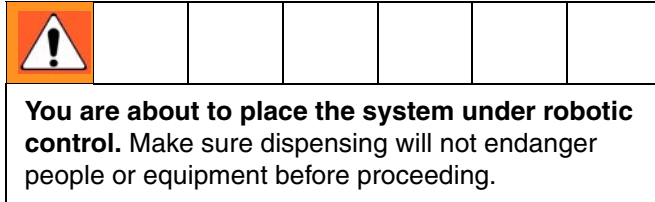

1. Make sure the POWER indicator, shown in FIG. 12, is lit at the control assembly. If it is not, turn the MAIN power switch to the ON position, turning on power to the PrecisionSwirl control assembly circuitry.
2. Set the CONTROL SELECT switch to AUTOMATIC.
3. Press the RUN/ENABLE (black) button. Make sure the green RUN indicator, shown in FIG. 12, is lit at the control assembly.

The PrecisionSwirl orbital dispenser is now enabled. When it receives a 24 Volt RUN/ENABLE command from the robot, the PrecisionSwirl orbital dispenser motor starts and reaches full speed in about one second. The orbital dispenser motor stops when the 24 Volt RUN/ENABLE command is removed.

4. Leave the control assembly in this state during normal operation.

Leaving Automatic Mode

To leave Automatic dispense mode and idle the module:

1. Press the STOP (red) button.
2. Set the CONTROL SELECT switch to MANUAL.
3. Make sure the green RUN indicator, shown in FIG. 12, is off at the control assembly.

Using Manual Mode

1. Make sure the POWER indicator, in FIG. 12, is lit at the control assembly. If it is not, turn the MAIN power switch to the ON position, turning on power to the PrecisionSwirl control assembly circuitry.
2. Set the CONTROL SELECT switch to MANUAL.

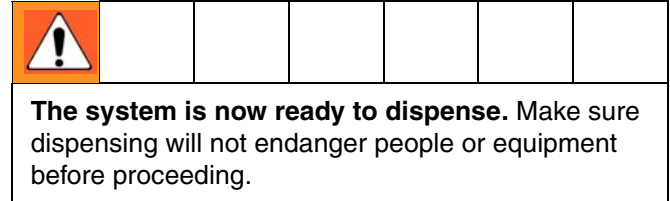

3. Press the RUN/ENABLE (black) button. Make sure the green RUN indicator, shown in FIG. 12, is lit at the control assembly.

The PrecisionSwirl orbital dispenser motor starts immediately.

Stop Manual Swirling

To stop manual swirling and idle the module:

1. Press the STOP (red) button.

The PrecisionSwirl orbital dispenser is now disabled and will stop swirling material.

2. Make sure the green RUN indicator, shown in FIG. 12, is off at the control assembly.

Analyzing Causes for a Motor Fault Alarm

Circuitry on the relay board monitors the motor speed to verify that the motor is functioning properly.

When the motor functions improperly, the circuitry on the relay board activates the motor fault alarm. The alarm turns on when:

- the motor speed has not risen within the +/-50% tolerance range within five seconds after startup.
- the motor speed is outside the tolerance range for at least five seconds while operating.

When a fault occurs, the motor fault light on the control panel illuminates, and the alarm relay activates sending the fault signal out via the automatic control cable. The alarm remains turned on until the fault condition is corrected or the run command is removed.

A fault will also be generated if any of the front panel controls are not in the correct position for automatic operation (power switch, enable switch, manual/auto switch).

Adjusting Orbital Dispenser Motor Speed

Adjust the orbital dispenser motor speed in the manual or automatic control mode as described in the following paragraphs.

Manual Mode:

Adjust motor speed by rotating the MANUAL SPEED CONTROL knob on the control box. See FIG. 12.

Rotate the knob clockwise to increase speed and counterclockwise to decrease speed. Use the motor speed chart (FIG. 13) to find the manual control setting required to achieve the desired motor speed.

Automatic Mode:

Use the motor speed chart (FIG. 13) to find the voltage setting required to achieve the desired motor speed. When the control signal voltage is increased, the motor speed increases. When the control signal voltage is decreased, the motor speed decreases.

						
Exceeding the maximum analog speed control voltage may result in damage to the motor controller.						

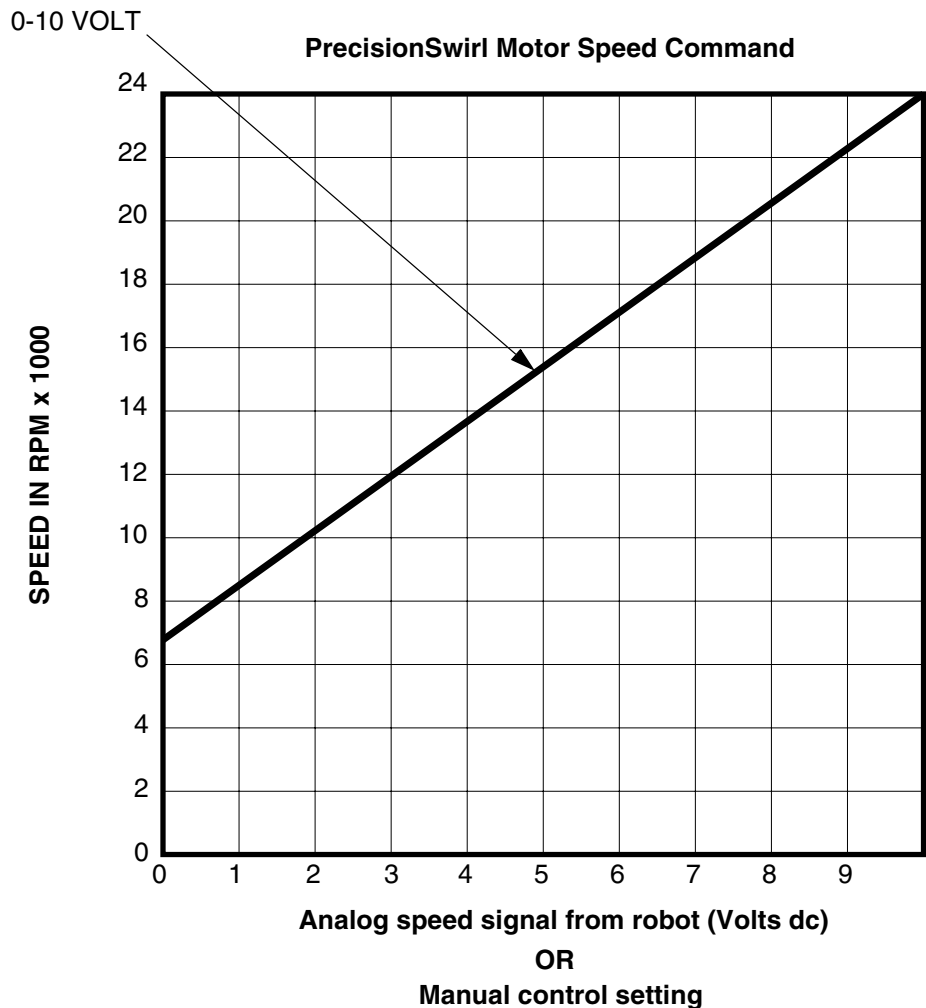

FIG. 13

Troubleshooting

Some solutions require disassembling the dispense valve or orbital dispenser. Always relieve system pressure before performing these procedures.

Table 3 provides troubleshooting information. For other troubleshooting situations, call your Graco distributor.



						
<p>To reduce the risk of serious injury whenever you are instructed to relieve pressure, always follow the Pressure Relief Procedure (see manual 309043).</p> <p>To reduce the risk of serious injury whenever you are instructed to remove, change, check, clean, or handle the nozzle in any manner, always disconnect the motor control cable from the control assembly (see FIG. 8 on page 17), or place the control assembly in the MANUAL mode of operation using the CONTROL SELECT switch. (See FIG. 12 on page 22.)</p>						

Table 3. Troubleshooting

Problem	Cause	Solution
No material being dispensed	Clogged nozzle	Change nozzle.
	No material or pressure	Check fluid delivery system.
	Broken or clogged dispense tube	Rebuild the orbital dispenser.
	Fault in dispense valve	Refer to Dispense Valve manuals 308876 or 309376.
Material dispensing but not swirling (Motor fault light is on)	Motor not operating	Check wiring connections and cable.
		Tube bearing defective; replace tube bearing.
		Motor defective; replace motor.
		Check for fluid leak.
	Control assembly failure	Check analog voltage control setting and enable signal.
		Check RPM setting.
		Check power and fuses.
		Check wiring.
Orbiter bearing failure	Replace bearing.	
Material dispensing but not swirling (Motor fault light is off)	Material accumulating on nozzle	Clean nozzle.
Motor is rotating but poor swirl pattern or change in bead size	Flow rate has changed	Check flow rate.
	Motor speed has changed	Check analog speed signal.
	Material viscosity has changed	Check material parameters.
	Partially clogged nozzle	Clean nozzle.

Control Assembly Service



Servicing the Control Assembly

This part of the manual provides information about the following control assembly components:

- Indicator Lamp Button and Select Switch (page 26)
- Light Bulb (page 26)
- MAIN Power Switch (page 27)
- Potentiometer (page 28)

 Refer to the **Parts** information on pages 34, 36, and 38 while servicing the control assembly.

Lamp Button and Switch Removal

						
<p>ELECTROCUTION HAZARD Installing and servicing this equipment requires access to parts which could cause an electric shock or other serious injury. Have only qualified electricians access the control assembly.</p>						

1. Shut off system power at the main circuit breaker.
2. At the control assembly, move the MAIN power switch to the OFF position.
3. Unlock and open the hinged cover of the control assembly enclosure.
4. Disconnect the lead wires from the fixture terminals. Refer to FIG. 21 and FIG. 22 for lead wire identification. If necessary, label the wires to facilitate reassembly after the fixture is replaced.
5. Loosen two screws which clamp the fixture to the cover. Rotate the fixture counter-clockwise relative to the lens cover or switch operator. Separate the two parts of the fixture and remove them from the cover.



Lamp Button and Switch Replacement

1. Reverse the disassembly procedures 3-5 in the previous section.

2. Refer to FIG. 21 and FIG. 22 for lead wire identification.
3. Apply system power at the main circuit breaker.
4. Move the MAIN power switch to the ON position, applying power to the control assembly.
5. Verify that the replaced fixture operates correctly.
6. Return the orbital dispenser and control assembly to normal operating condition.

Light Bulb Removal

Remove the light bulb as follows:

						
<p>ELECTROCUTION HAZARD Installing and servicing this equipment requires access to parts which could cause an electric shock or other serious injury. Have only qualified electricians access the control assembly.</p>						

1. Shut off system power at the main circuit breaker.
2. At the control assembly, move the MAIN power switch to the OFF position.
3. Unscrew and remove the indicator light lens.
4. Gently press and rotate the bulb counter-clockwise, 1/4 in. of a turn, unlocking the bulb from its socket. Remove the bulb from the socket.

Light Bulb Replacement



Replace the light bulb as follows:

1. Insert the light bulb in the socket.
2. Gently press and rotate the bulb clockwise, 1/4 in. of a turn to lock the bulb in its socket.
3. Replace the lens.
4. Apply system power at the main circuit breaker.
5. Move the MAIN power switch to the ON position, applying power to the control assembly.
6. Verify that the light bulb operates correctly.

- Return the control assembly to normal operating condition.

MAIN Power Switch Removal

Remove the MAIN power switch as follows:

						
ELECTROCUTION HAZARD						
Installing and servicing this equipment requires access to parts which could cause an electric shock or other serious injury. Have only qualified electricians access the control assembly						

- Shut off system power at the main circuit breaker.
- At the control assembly, move the MAIN power switch to the OFF position. See FIG. 14.
- Unlock and open the hinged cover of the control assembly.
- Disconnect the lead wires from the four terminals on the MAIN power switch. Refer to FIG. 21 and FIG. 22 for lead wire identification. If necessary, label the wires to facilitate reassembly after the switch is replaced.
- Remove one flat head screw that secures the red rotor to the switch assembly. Lift the rotor from the switch.

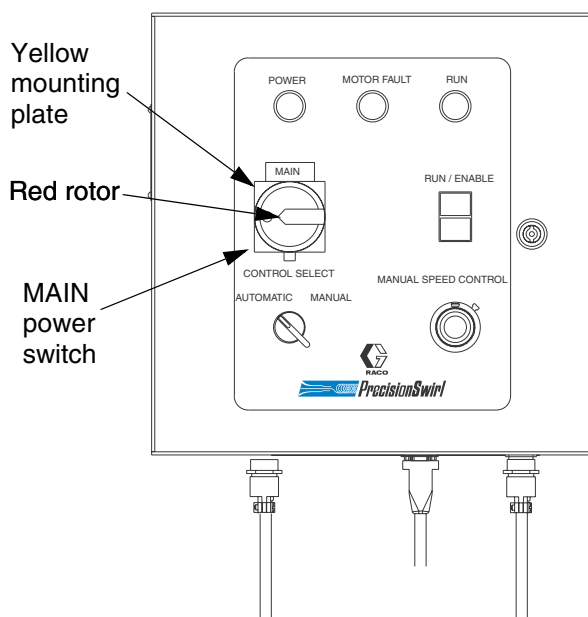

FIG. 14

- Remove two flat head screws from the yellow mounting plate, which fastens the switch to the hinged cover. Remove the switch.

MAIN Power Switch Replacement

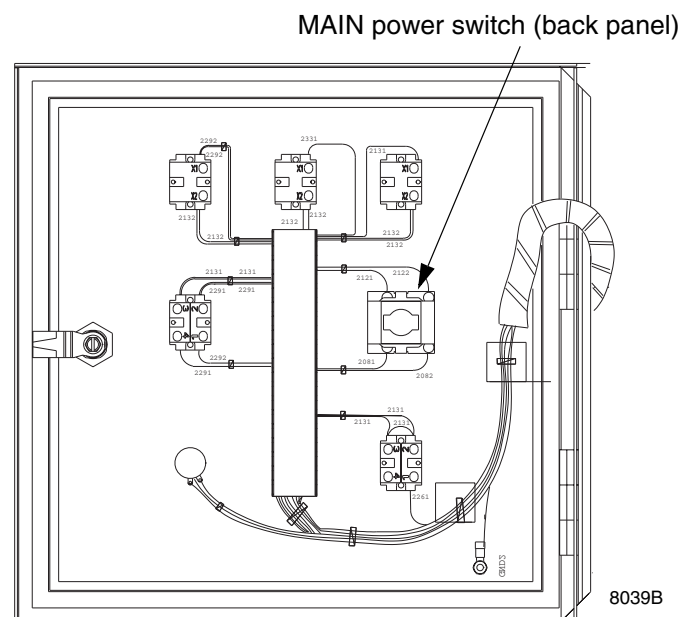

Replace the MAIN power switch as follows:

- Assemble the switch assembly to the yellow mounting plate with two flat head screws.
- Assemble the red rotor, which is keyed, onto the yellow mounting plate with one flat head screw. See Fig. 15.
- Turn the rotor to point down to ensure that the switch is in the OFF position.
- Reconnect the lead wires to the terminals on the switch. Refer to Fig. 18 to make sure that the connections are correct.
- Close and lock the hinged cover on the control assembly.
- Apply system power at the main circuit breaker.
- Move the MAIN power switch to the ON position applying power to the control assembly.
- Verify that the switch operates correctly.



Potentiometer Removal

Remove the potentiometer as follows:

						
<p>ELECTROCUTION HAZARD</p> <p>Installing and servicing this equipment requires access to parts which could cause an electric shock or other serious injury. Have only qualified electricians access the control assembly.</p>						

1. Shut off system power at the main circuit breaker.
2. At the control assembly, move the MAIN power switch to the OFF position.
3. Unlock and open the hinged cover of the control assembly.
4. Pull lead wires to remove from potentiometer.
5. Loosen setscrew (not shown) in the vernier dial knob and remove dial assembly from the potentiometer shaft.
6. Remove the hex nut and lockwasher from potentiometer shaft, and remove the potentiometer.

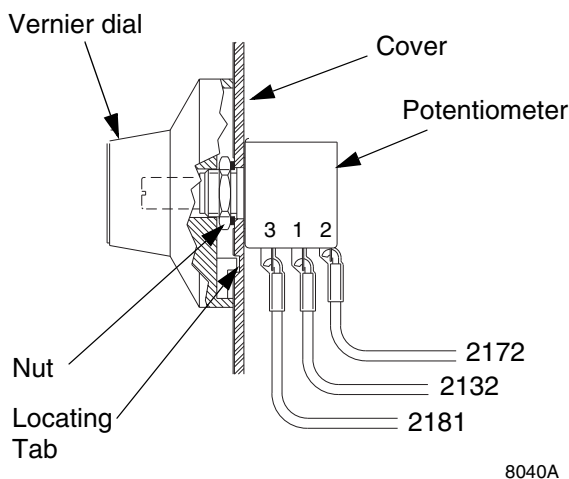

FIG. 15

Potentiometer Replacement

Replace the potentiometer as follows:

1. Insert the potentiometer through its hole from the back of the enclosure cover and rotate it so that terminals 1 and 3 are oriented at approximately 4:30 when viewed from the back. Refer to FIG. 16. Assemble the lockwasher and nut onto the shaft and secure the potentiometer to the cover.
2. At the front of the cover, turn the potentiometer shaft counter-clockwise to its stop.
3. Pre-set the vernier dial to 0.00 and place it over the potentiometer shaft, with its key tab inserted into the blind hole in the cover front surface. Tighten the dial setscrew (not shown) against the shaft.
4. Verify that the potentiometer is turned fully counter-clockwise when the vernier dial indicates 0.00. Loosen the setscrew and reposition the shaft and dial if necessary, then retighten the setscrew.
5. Connect wire leads to potentiometer.
6. Close and lock the cover on the control assembly.
7. Apply system power at the main circuit breaker.
8. Move the MAIN power switch to the ON position, applying power to the control assembly.
9. In the MANUAL control mode, verify that the potentiometer operates correctly.
10. Return the orbital dispenser and control assembly to normal operating condition.

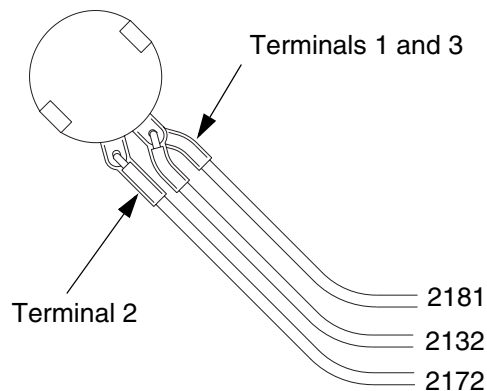

FIG. 16

Panel Assembly Service

This part of the manual provides information about the following panel assembly components:

- Swirl Control Board (page 30)
- RFI Filter (page 31)
- Relay (page 32)
- Fuse (page 33)

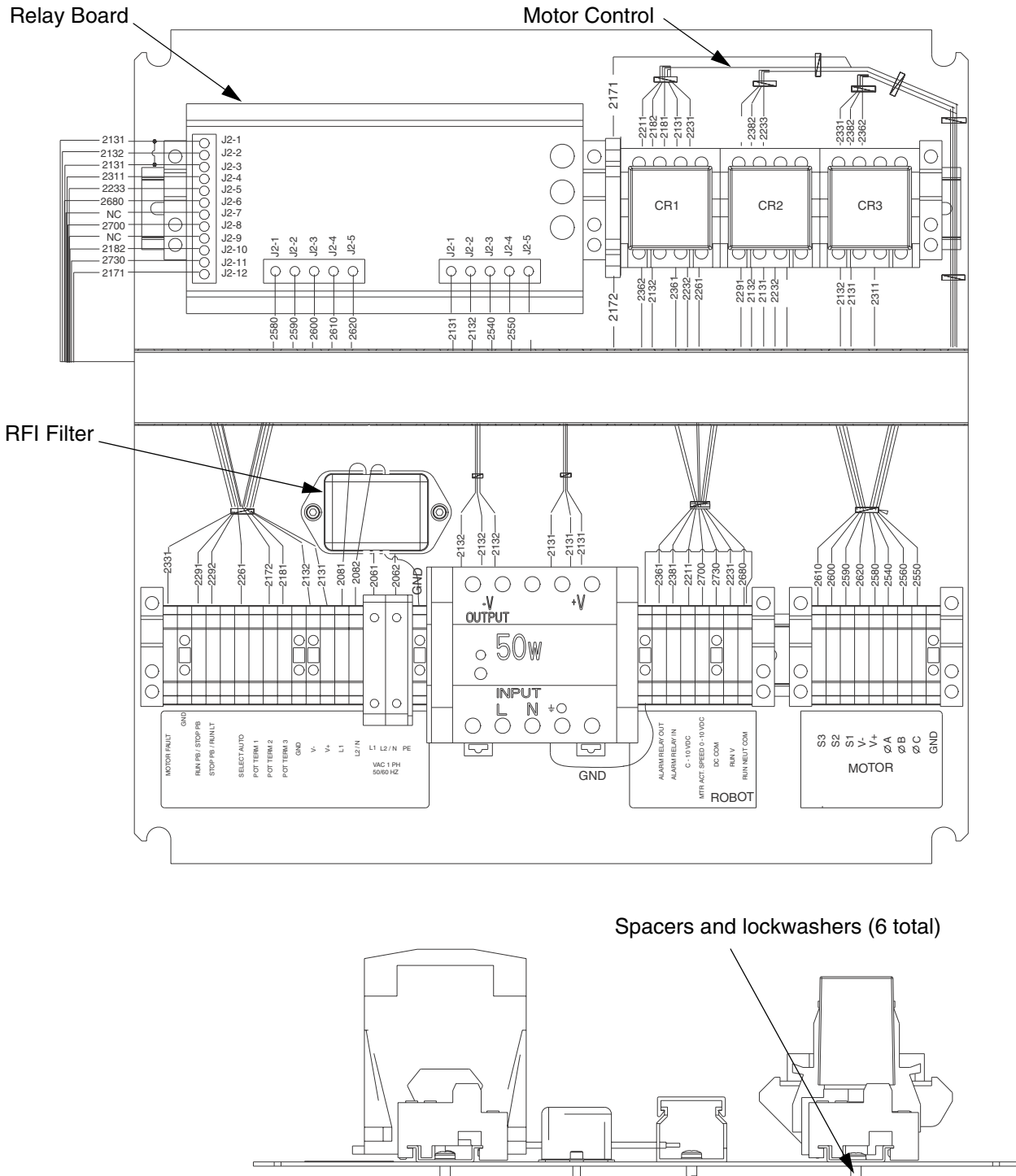



FIG. 17

Swirl Control Board Removal

Remove the relay board as follows:

						
ELECTROCUTION HAZARD Installing and servicing this equipment requires access to parts which could cause an electric shock or other serious injury. Have only qualified electricians access the control assembly.						

1. Shut off system power at the main circuit breaker.
2. At the control assembly, move the MAIN power switch to the OFF position.
3. Unlock and open the hinged cover of the control assembly.
4. Unplug the connectors from the swirl control board.
5. Pry the plastic cups off the board with a screwdriver to release the board from the din rail.



Swirl Control Board Replacement

Replace the relay board as follows:

1. Snap the swirl control board onto the din rail.
2. Plug the connectors into the swirl control board. Refer to FIG. 17 for lead wire identification.
3. Close and lock the hinged cover on the control assembly.
4. Apply system power at the main circuit breaker.
5. Move the MAIN power switch to the ON position, applying power to the control assembly.
6. Verify that the relay board operates correctly.
7. Return the control assembly to normal operating condition.

RFI Filter Removal

Remove the RFI Filter as follows:

						
<p>ELECTROCUTION HAZARD Installing and servicing this equipment requires access to parts which could cause an electric shock or other serious injury. Have only qualified electricians access the control assembly.</p>						

1. Shut off system power at the main circuit breaker.
2. At the control assembly, move the MAIN power switch to the OFF position.
3. Unlock and open the hinged cover of the control assembly.
4. Disconnect the wires from the terminal blocks on the control board. If necessary, label the wires to facilitate reassembly after the control board is replaced.
5. Remove the two screws and lockwashers from the RFI filter on the panel assembly. See FIG. 17.
6. Remove the RFI filter.



RFI Filter Replacement

Replace the RFI filter as follows:

1. Install the RFI filter using the two screws and lockwashers to secure the component on the panel assembly. See FIG. 17.
2. Connect the wires to the correct terminal block on the control board. Refer to FIG. 17 for lead wire identification.
3. Close and lock the hinged cover on the control assembly.
4. Apply system power at the main circuit breaker.
5. Move the MAIN power switch to the ON position, applying power to the control assembly.
6. Verify that the RFI filter operates correctly.
7. Return the control assembly to normal operating condition.

Relay Removal

Remove the relay as follows:

					
ELECTROCUTION HAZARD					
Installing and servicing this equipment requires access to parts which could cause an electric shock or other serious injury. Have only qualified electricians access the control assembly.					

1. Shut off system power at the main circuit breaker.
2. At the control assembly, move the MAIN power switch to the OFF position.
3. Unlock and open the hinged cover of the control assembly.
4. With force, carefully pull the top of the relay to unplug the relay from the base. See FIG. 18.

Relay Replacement

Replace the relay as follows:

 Relays are always P/N 15A797, 24 VDC. If the robot run command signal for automatic control mode is 24 VDC, then relay is also P/N 15A797.

1. Match pattern on bottom side of relay to base. Plug relay into base. FIG. 18.
2. Close and lock the hinged cover on the control assembly.
3. Apply system power at the main circuit breaker.
4. Move the MAIN power switch to the ON position, applying power to the control assembly.
5. Verify that the relay operates correctly.
6. Return the control assembly to normal operating condition.

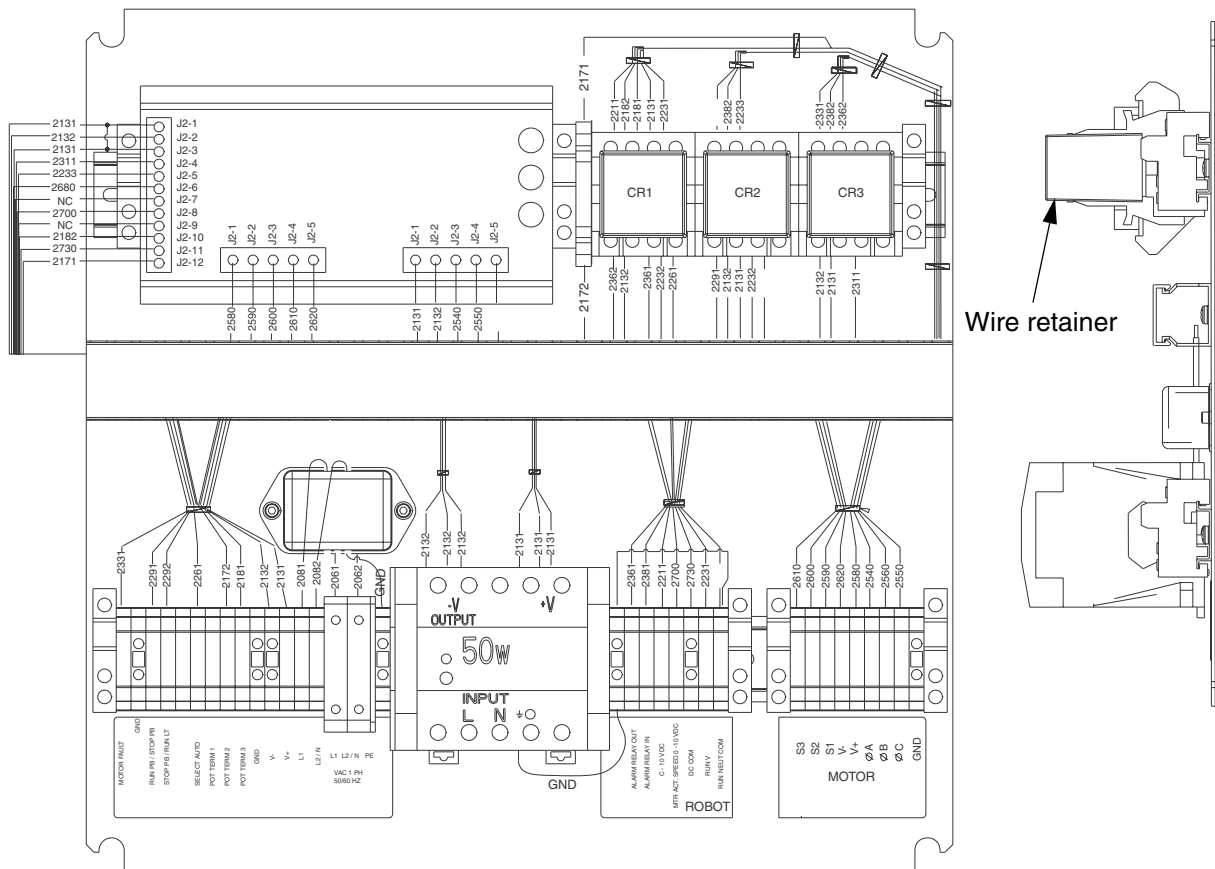



FIG. 18

Fuse Removal

Remove the fuse as follows:

					
ELECTROCUTION HAZARD					
Installing and servicing this equipment requires access to parts which could cause an electric shock or other serious injury. Have only qualified electricians access the control assembly.					

1. Shut off system power at the main circuit breaker.
2. At the control assembly, move the MAIN power switch to the OFF position.
3. Unlock and open the hinged cover of the control assembly.
4. Lift to unlock the top of the fuse holder (10), which is hinged at the bottom, from its clamp. See FIG. 19.
5. Open the fuse holder fully. Locate the failed fuse inside. Refer to FIG. 21 and FIG. 22 for fuse identification.

6. Carefully remove the fuse (24) from the fuse holder.

Fuse Replacement

Replace the fuse as follows:

 Check the new fuse (24) to ensure that it matches the Amp rating of the failed fuse.

1. Press both ends of the new fuse evenly into place in the fuse holder. See FIG. 19.
2. Close and lock the fuse holder into place.
3. Close and lock the hinged cover on the control assembly.
4. Apply system power at the main circuit breaker.
5. Move the MAIN power switch to the ON position, applying power to the control assembly.
6. Verify that the fuse operates correctly.
7. Return the orbital dispenser and control assembly to normal operating condition.

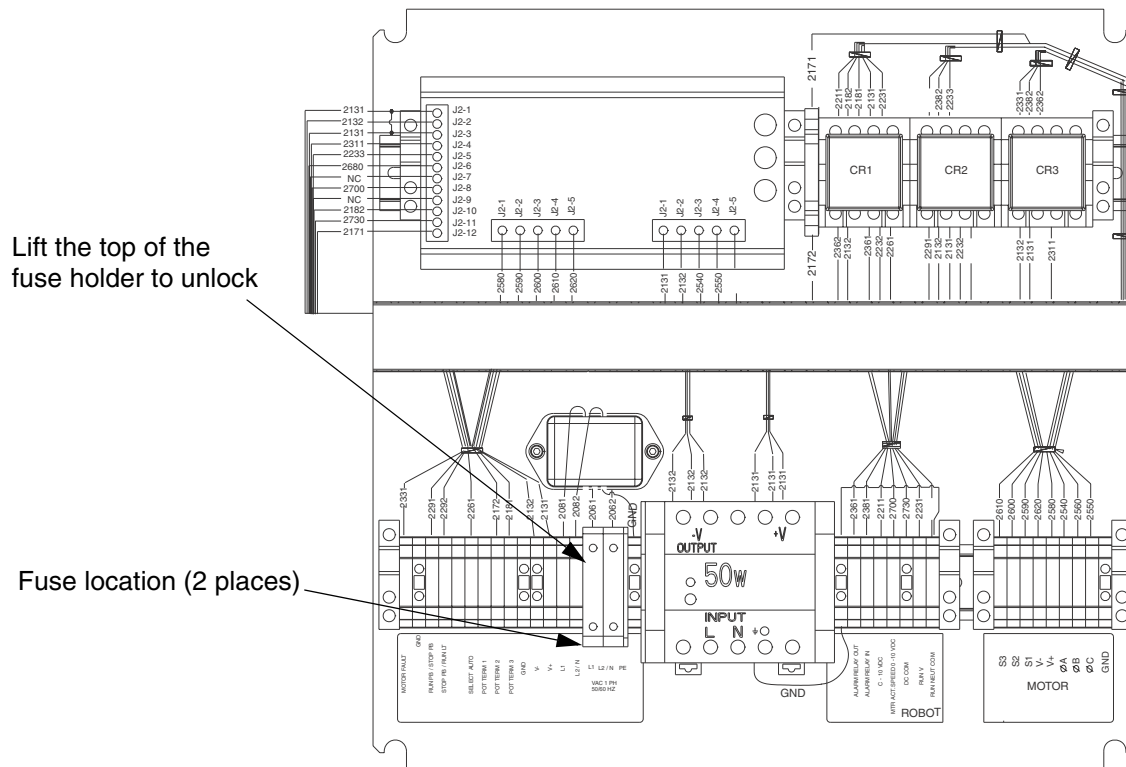

FIG. 19

Control Assembly Parts

Part No. 918616, PrecisionSwirl Control Assembly

Ref.	No.	Part No.	Description	Qty.
	1	241487	CABINET, PrecisionSwirl	1
	2	194896	LABEL, front panel,	1
	3	241580	PANEL, ASSY, control	1
	4	241600	CONNECTOR, motor	1
	5	617771	GASKET, flange, electrical connec- tor, #14	1
	6	241599	CONNECTOR, robot	1
	8	C19949	SCREW, SHC, #4-40 x 0.25	4
	9	115237	SWITCH, power, rotary	1
	13	617777	LIGHT base, direct supply	2
	14	617778	LENS, light, white, 7/8	1
	15	617779	LENS, light, green, 7/8	1
	16	617780	LAMP, incandescent, 24V	2
	17	617781	SWITCH BASE, 1-NO, 1-NC	2
	18	617782	ACTUATOR, switch, 2-PB, rect	1
	19	617783	ACTUATOR, switch, 2 position	1
	20	617775	POTENTIOMETER, 10 turn, 10K ohm, 0.5W	1
	21	617776	DIAL, vernier, 15 turn	1
	22†	113285	TERMINAL, ring, #10	2
	23†	100718	WASHER	2
	24†	617774	NUT, hex, #10-32, brass	4
	31	194897	LABEL, cable connector	1
	32▲†	617472	LABEL, danger, electric shock	1
	34†	C19738	SCREW, drive, round head	4
	35	C78216	CLAMP, ty-rap	10
	36	C78321	TIE, cable, 3.62 long	18
	42	100731	WASHER	4
	43	100133	WASHER, lock	4
	44†	100307	NUT, full, hex	4
	45	195899	DUCT, wire, 10 in.	1
	47†	114887	KEY, latch, door	1
	51	115217	SCREW, female, kit	1
	52	194984	COVER, wire, duct, 10 in.	1
	53	115434	LENS, light, red, 7/8	1

† These parts are not shown on the parts drawing.

▲ Replacement Danger and Warning labels, tags, and cards are available at no cost.

Part No. 918616, PrecisionSwirl Control Assembly

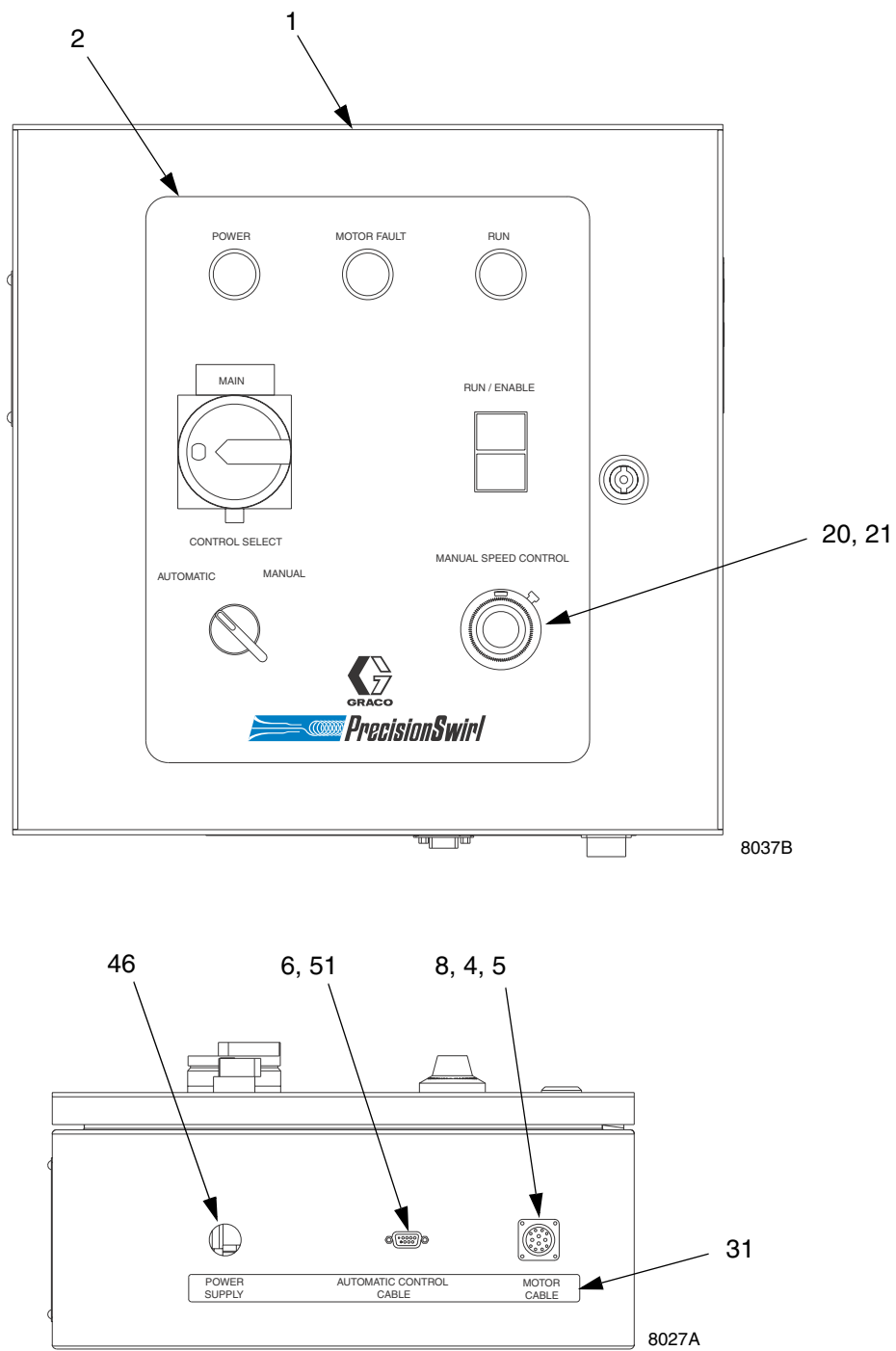

FIG. 20

Part No. 918616, PrecisionSwirl Control Assembly

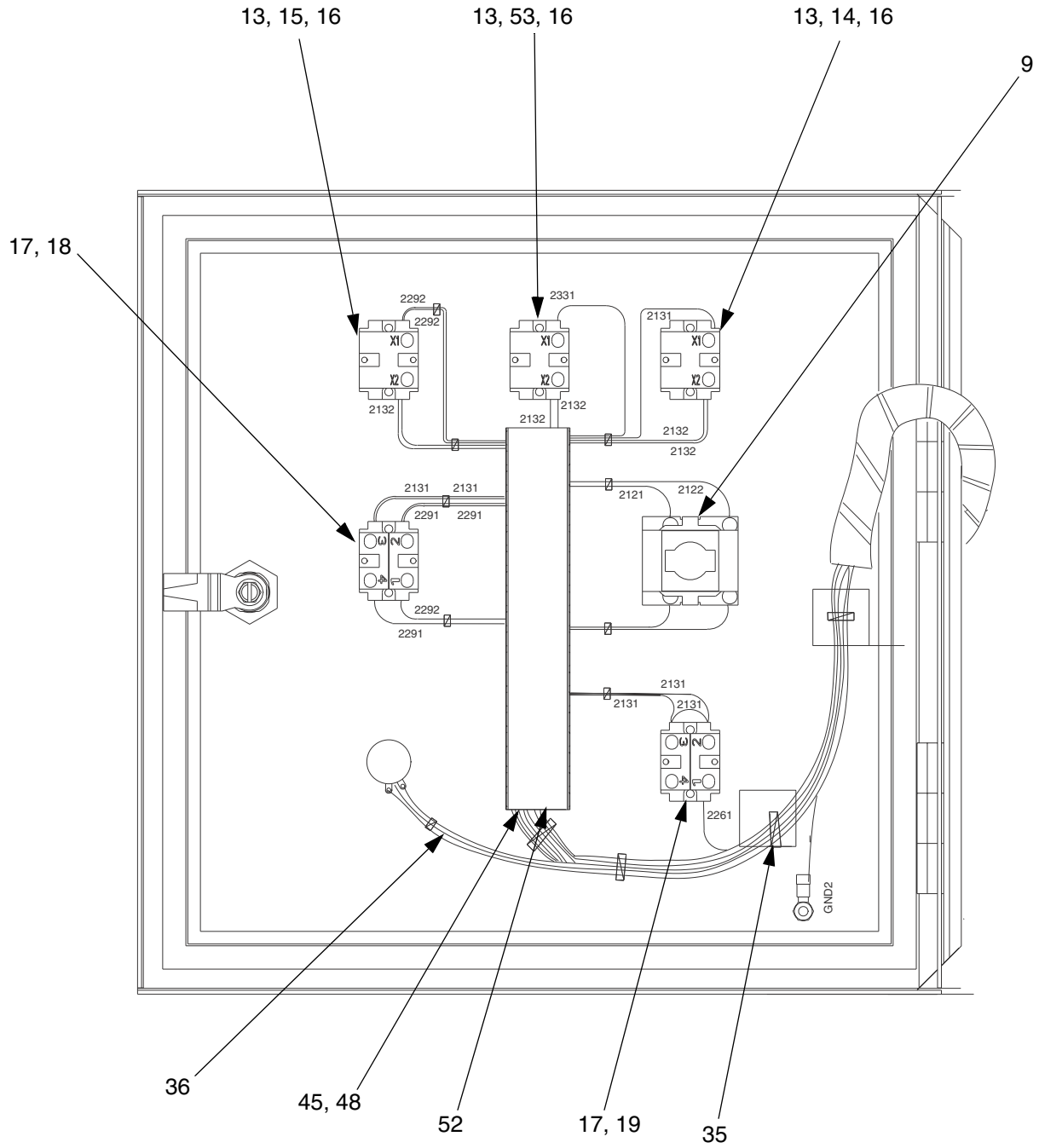

FIG. 21

Part No. 918616, PrecisionSwirl Control Assembly

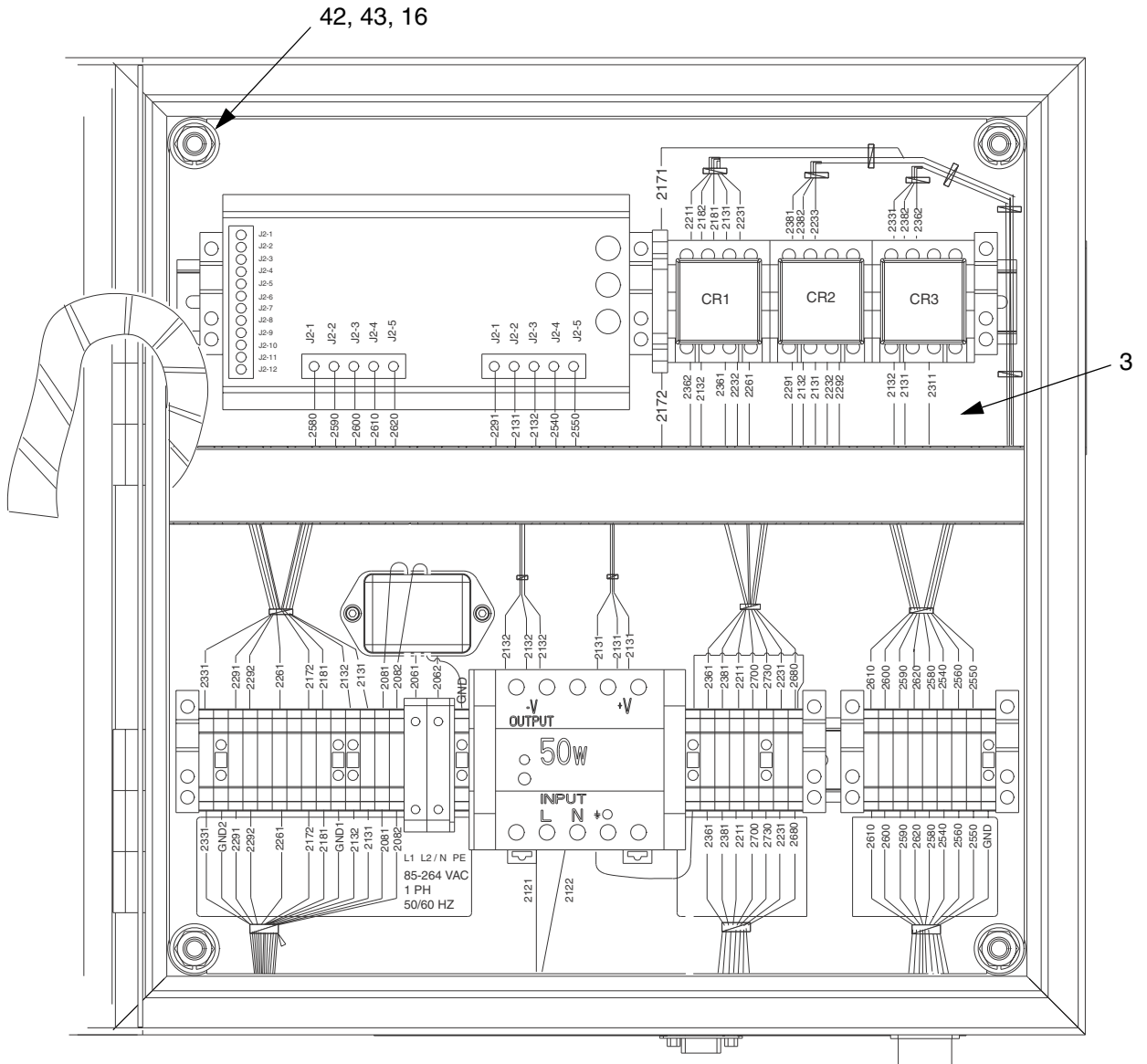

FIG. 22

Accessory Parts

Motor Control Cable Assemblies

The motor control cables that are provided with the module are OLFLEX® brand cables. The 55 ft (16.8) motor cable (617870) can be used alone.

Table 5. Motor Control Cables

Part Number	Length	Description
617870	55 ft (16.8 m)	Motor cable assembly

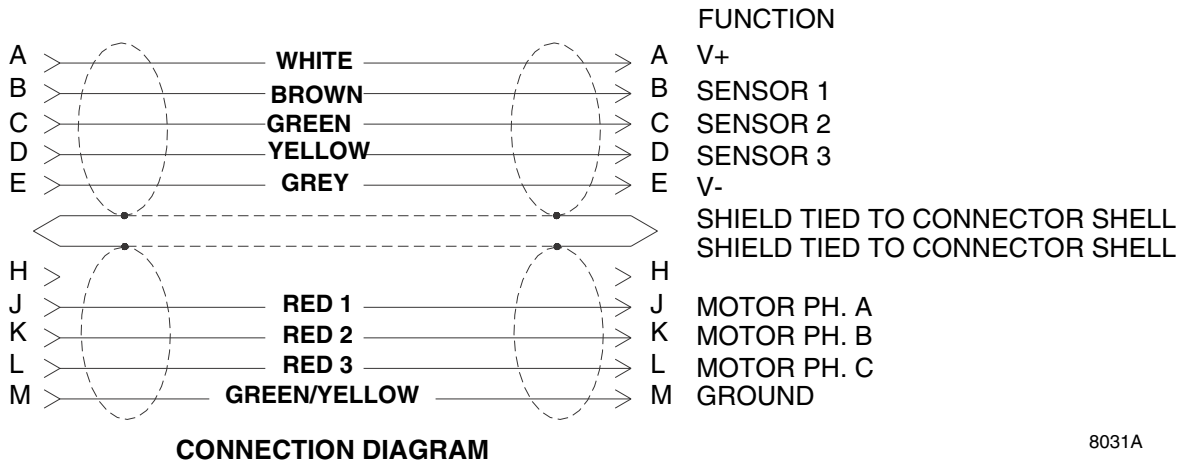
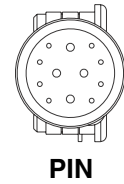
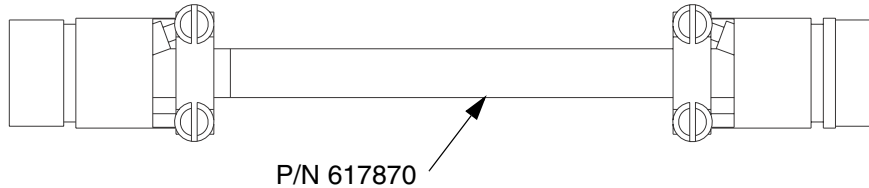
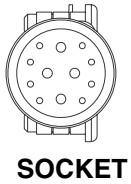

8031A

FIG. 24

Torsional Motor Control Cable Assemblies

For robot applications that have a lot of torsional motion to the cable in addition to bending. These cables are made from Olflex 900 series robot cable that are designed to handle more torsional loads. The cables must be used in conjunction with the 55 ft motor cable.

Table 6. Motor Control Cables

Part Number	Length	Description
233125	6 ft (1.8 m)	Motor cable assembly
233124	9 ft (2.7 m)	Motor cable assembly
233123	15 ft (4.6 m)	Motor cable assembly

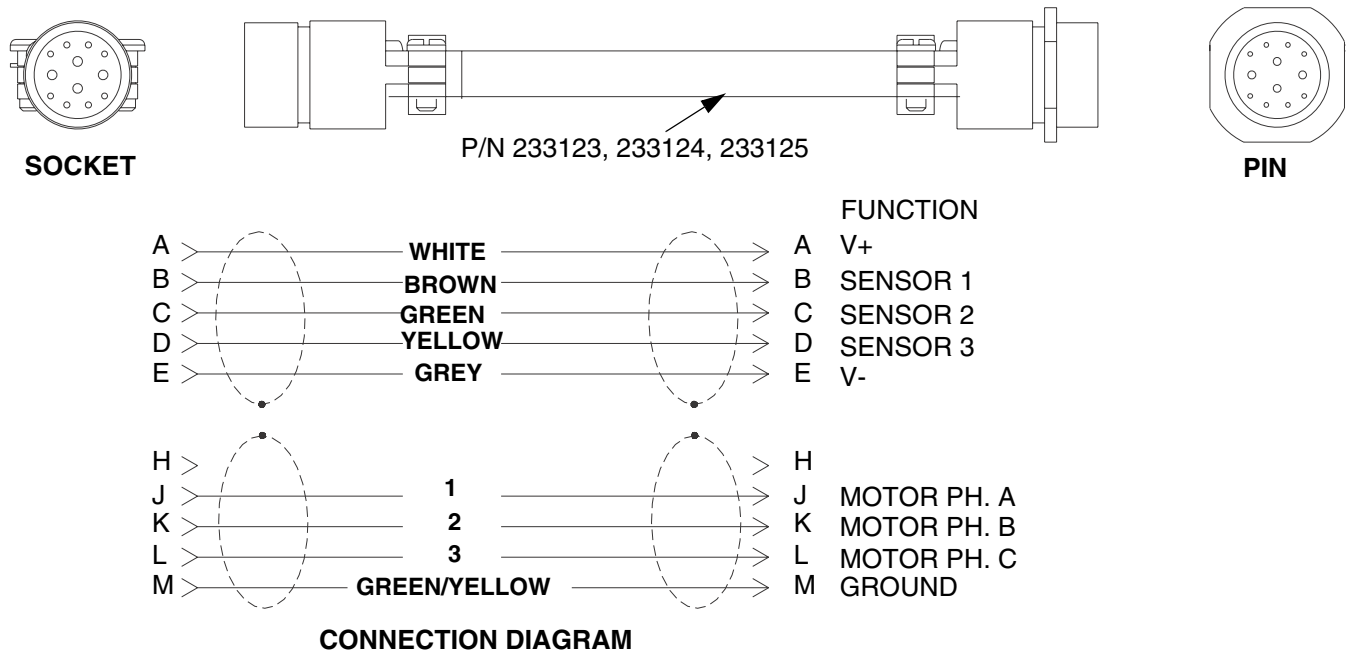

FIG. 25

Robot Interface Cable Assembly

The length of robot interface cable assembly 617829 is 40 ft (12.2 m). FIG. 26 shows the 9-pin cable and identifies the cable interface signals.

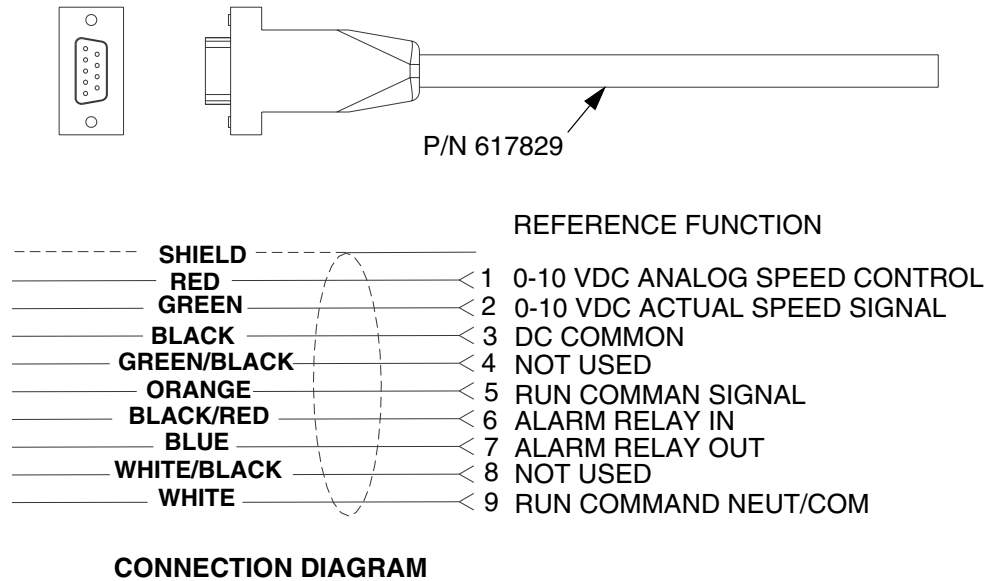

FIG. 26

Dispenser Valve Adapter Fittings

Ref. No.	Part No.	Description	Qty.
1	197504	Straight flange adapter, EnDure	1
2	197842	45 degree nosepiece	1
3	198323	Alternative orbiter nut	1
4	198324	Fitting, nosepiece to orbiter	1

45 degree orbiter mount uses reference numbers 2-4.

Wiring Diagrams

Motor Controller Wiring, Lines 200-238

200
201
202
203
204
205
206
207
208
209
210
211
212
213
214
215
216
217
218
219
220
221
222
223
224
225
226
227
228
229
231
232
233
234
235
236
237
238

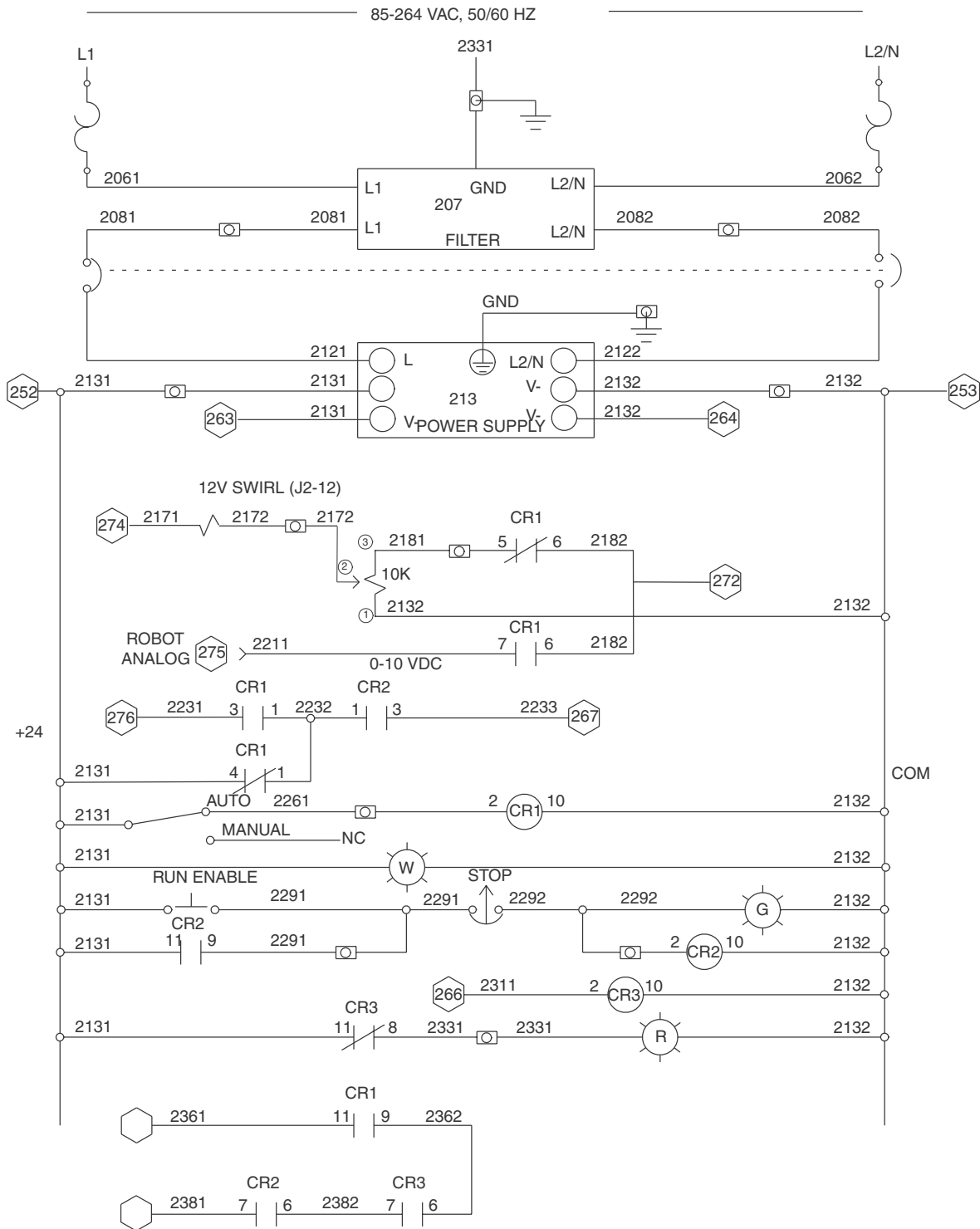

Motor Controller Wiring, Lines 250-288

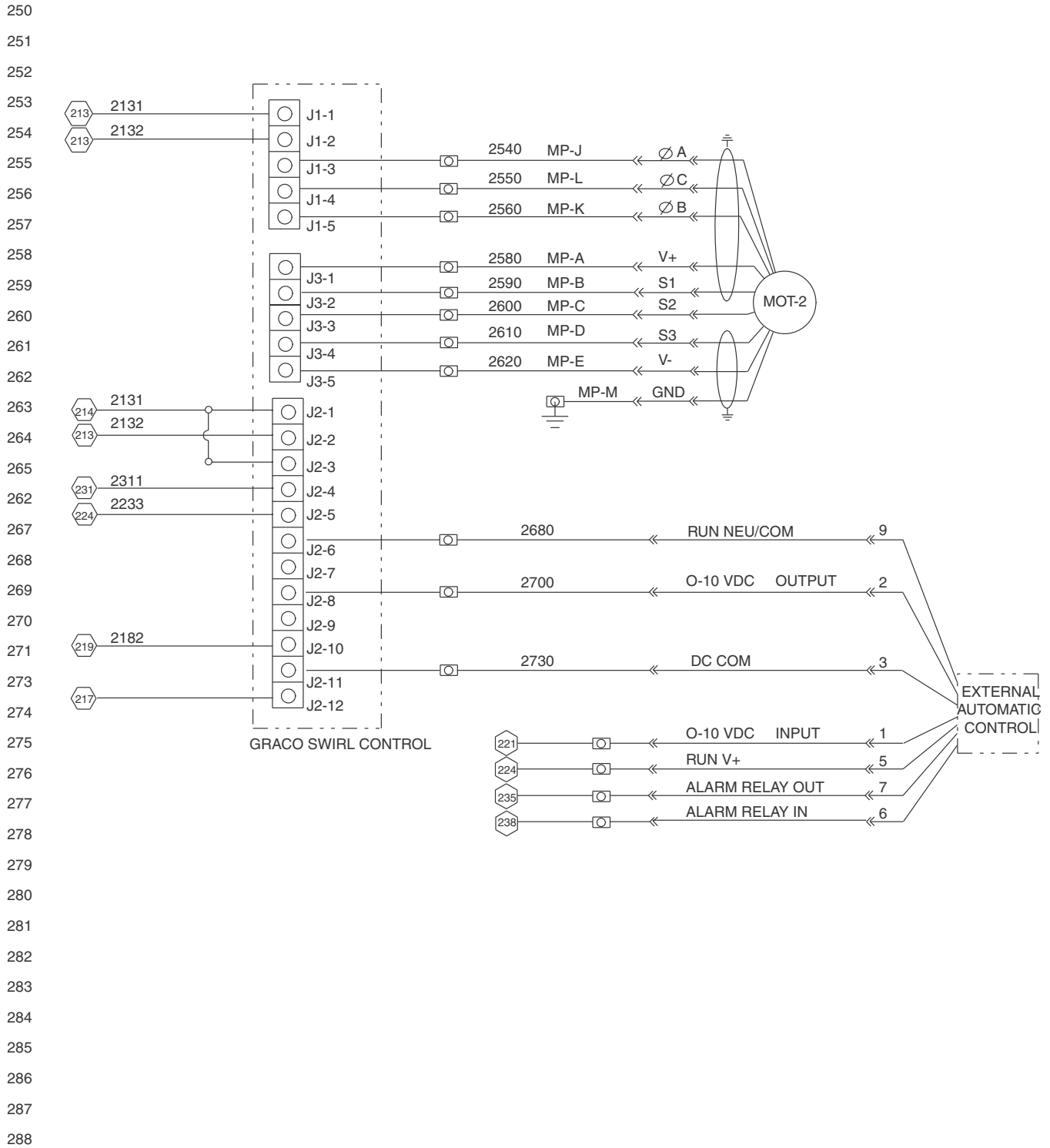

Technical Data

Control Assembly

Input power	100 - 240 Vac, 50/60Hz, 1 PH
Output power	Proprietary PWM voltage to the motor, less than 24V
Automatic control analog input	0-10 VDC for 6600-24,000 RPM
Speed signal output	0-10 VDC for 0-24,000 RPM
Auto control relay contact rating	3 Amps at 30 VDC
Weight	23.5 lbs (10.7 kg)

Orbital Dispenser

Input power	Proprietary PWM voltage to the motor, less than 24V
Motor torque	1.5 oz-in.
Maximum motor speed	24,000 RPM
Maximum operating pressure	3500 psi (241 bar, 24.1 MPa)
Fluid inlet	3/4-16 37° JIC female swivel
Nozzle attachment	#10-32 proprietary connection
Wetted components	Stainless steel, nickel alloy, brazing alloy, epoxy, EPDM rubber
Noise levels	Sound pressure level - 67 dBa
Weight	1.6 lbs (0.7 kg)

PrecisionSwirl™ is a trademark of Graco, Inc.

PARKER O LUBE™ is a trademark of Parker Hannifin Corp.

Loctite® is a registered trademark of the Loctite Corporation.

Graco Standard Warranty

Graco warrants all equipment referenced in this document which is manufactured by Graco and bearing its name to be free from defects in material and workmanship on the date of sale to the original purchaser for use. With the exception of any special, extended, or limited warranty published by Graco, Graco will, for a period of twelve months from the date of sale, repair or replace any part of the equipment determined by Graco to be defective. This warranty applies only when the equipment is installed, operated and maintained in accordance with Graco's written recommendations.

This warranty does not cover, and Graco shall not be liable for general wear and tear, or any malfunction, damage or wear caused by faulty installation, misapplication, abrasion, corrosion, inadequate or improper maintenance, negligence, accident, tampering, or substitution of non-Graco component parts. Nor shall Graco be liable for malfunction, damage or wear caused by the incompatibility of Graco equipment with structures, accessories, equipment or materials not supplied by Graco, or the improper design, manufacture, installation, operation or maintenance of structures, accessories, equipment or materials not supplied by Graco.

This warranty is conditioned upon the prepaid return of the equipment claimed to be defective to an authorized Graco distributor for verification of the claimed defect. If the claimed defect is verified, Graco will repair or replace free of charge any defective parts. The equipment will be returned to the original purchaser transportation prepaid. If inspection of the equipment does not disclose any defect in material or workmanship, repairs will be made at a reasonable charge, which charges may include the costs of parts, labor, and transportation.

THIS WARRANTY IS EXCLUSIVE, AND IS IN LIEU OF ANY OTHER WARRANTIES, EXPRESS OR IMPLIED, INCLUDING BUT NOT LIMITED TO WARRANTY OF MERCHANTABILITY OR WARRANTY OF FITNESS FOR A PARTICULAR PURPOSE.

Graco's sole obligation and buyer's sole remedy for any breach of warranty shall be as set forth above. The buyer agrees that no other remedy (including, but not limited to, incidental or consequential damages for lost profits, lost sales, injury to person or property, or any other incidental or consequential loss) shall be available. Any action for breach of warranty must be brought within two (2) years of the date of sale.

GRACO MAKES NO WARRANTY, AND DISCLAIMS ALL IMPLIED WARRANTIES OF MERCHANTABILITY AND FITNESS FOR A PARTICULAR PURPOSE, IN CONNECTION WITH ACCESSORIES, EQUIPMENT, MATERIALS OR COMPONENTS SOLD BUT NOT MANUFACTURED BY GRACO. These items sold, but not manufactured by Graco (such as electric motors, switches, hose, etc.), are subject to the warranty, if any, of their manufacturer. Graco will provide purchaser with reasonable assistance in making any claim for breach of these warranties.

In no event will Graco be liable for indirect, incidental, special or consequential damages resulting from Graco supplying equipment hereunder, or the furnishing, performance, or use of any products or other goods sold hereto, whether due to a breach of contract, breach of warranty, the negligence of Graco, or otherwise.

FOR GRACO CANADA CUSTOMERS

The Parties acknowledge that they have required that the present document, as well as all documents, notices and legal proceedings entered into, given or instituted pursuant hereto or relating directly or indirectly hereto, be drawn up in English. Les parties reconnaissent avoir convenu que la rédaction du présente document sera en Anglais, ainsi que tous documents, avis et procédures judiciaires exécutés, donnés ou intentés, à la suite de ou en rapport, directement ou indirectement, avec les procédures concernées.

Graco Information

For the latest information about Graco products, visit www.graco.com.

TO PLACE AN ORDER, contact your Graco distributor or call to identify the nearest distributor.

Phone: 612-623-6921 **or Toll Free:** 1-800-328-0211 **Fax:** 612-378-3505

*All written and visual data contained in this document reflects the latest product information available at the time of publication.
Graco reserves the right to make changes at any time without notice.*

This manual contains English. MM 310554

Graco Headquarters: Minneapolis
International Offices: Belgium, China, Japan, Korea

GRACO INC. P.O. BOX 1441 MINNEAPOLIS, MN 55440-1441

Copyright 2001, Graco Inc. is registered to ISO 9001

www.graco.com

Revised 11/2009

Download from Www.Softmanuals.com. All Manuals Search And Download.

Free Manuals Download Website

<http://myh66.com>

<http://usermanuals.us>

<http://www.somanuals.com>

<http://www.4manuals.cc>

<http://www.manual-lib.com>

<http://www.404manual.com>

<http://www.luxmanual.com>

<http://aubethermostatmanual.com>

Golf course search by state

<http://golfingnear.com>

Email search by domain

<http://emailbydomain.com>

Auto manuals search

<http://auto.somanuals.com>

TV manuals search

<http://tv.somanuals.com>