

## LineLazer IV 250SPS Self-Propelled Line Striper

3A2090A  
EN

**For the application of line striping materials.  
For professional use only.  
For outdoor use only.  
Not for use in hazardous locations or explosive atmospheres.**

*Maximum Operating Speed: 10 mph (16 kph)  
Maximum Operating Pressure: 3300 psi (22.8 MPa, 228 bar)*



### IMPORTANT SAFETY INSTRUCTIONS

Read all warnings and instructions in this manual and the engine manual. Save these instructions.

Model	Guns	Description
24F307	2 Guns	LLIV 250SPS (North America, Latin America, Asia Pacific)
24K960	1 Gun	LLIV 250SPS (Latin America, Asia Pacific)
24K961	1 Gun	LLIV 250SPS (Europe)
24K962	2 Guns	LLIV 250SPS (Europe)
24M608	1 Gun	FieldLazer G400 (North America)

Related Manuals:	
3A2593	Repair
3A2598	Parts
311254	Gun
309277	Pump
312307	Auto-Layout Applications Methods

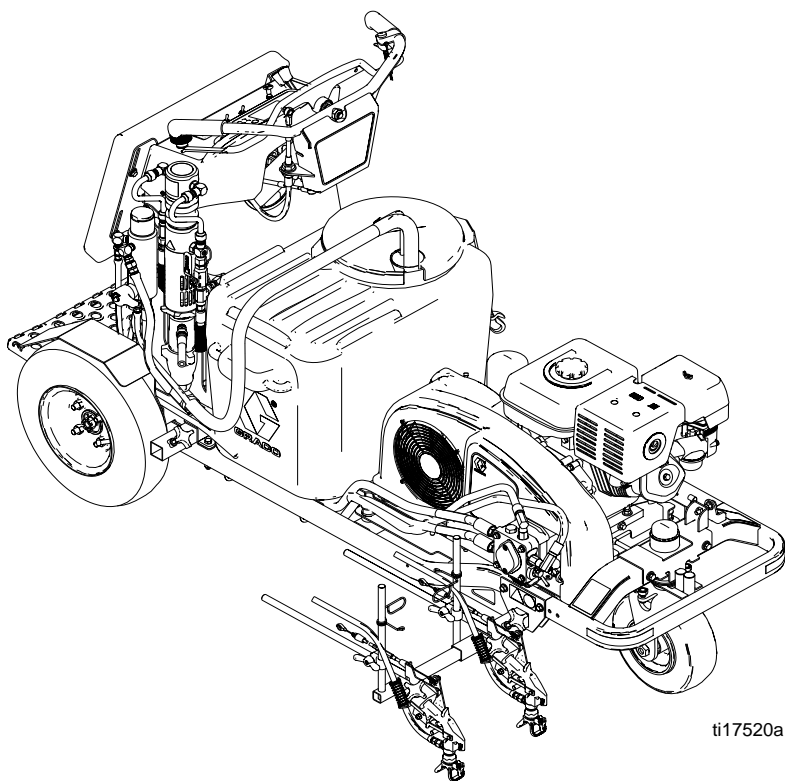

ti17520a















PROVEN QUALITY. LEADING TECHNOLOGY.

# Table of Contents





<b>Warnings</b> .....	<b>3</b>	<b>Smart Control Overview</b> .....	<b>21</b>
<b>Component Identification (Sprayer)</b> .....	<b>6</b>	Quick Guide .....	21
<b>Component Identification (Controls)</b> .....	<b>7</b>	<b>Smart Control Operation</b> .....	<b>22</b>
<b>Grounding Procedure</b>		Initial Setup .....	22
<b>(For Flammable Materials Only)</b> .....	<b>8</b>	Calibration .....	22
<b>Pressure Relief Procedure</b> .....	<b>8</b>	Change Units or Language .....	24
<b>Setup/Startup</b> .....	<b>9</b>	Operation in Manual Mode .....	25
SwitchTip and Guard Assembly .....	11	Operation in Automatic Mode .....	25
<b>Gun Placement</b> .....	<b>12</b>	Parking Layout Mode .....	27
Install Gun .....	12	Parking Mode .....	27
Position Gun .....	12	Marker Mode .....	29
Gun Arm Mounts .....	13	Measure Mode .....	30
Change Gun Position (Front and Back) .....	13	Machine Information .....	30
Change Gun Position (Left and Right) .....	13	<b>Cleanup</b> .....	<b>31</b>
Gun Cable Adjustment .....	15	<b>Hydraulic Oil/Filter Change</b> .....	<b>32</b>
Change Trigger Position .....	16	Removal .....	32
Gun Positions Chart .....	17	Installation .....	32
<b>Driving Instructions</b> .....	<b>18</b>	<b>Technical Specifications</b> .....	<b>33</b>
Parking / Emergency Brake .....	18	<b>Notes</b> .....	<b>34</b>
Drive Engagement .....	19	<b>Notes</b> .....	<b>35</b>
Straight Line Adjustment .....	19	<b>Graco Standard Warranty</b> .....	<b>36</b>
Handle Bar Height Adjustment .....	19		
Platform Storage Position .....	20		
Front Pad Adjustment .....	20		

# Warnings

The following warnings are for the setup, use, grounding, maintenance, and repair of this equipment. The exclamation point symbol alerts you to a general warning and the hazard symbols refer to procedure-specific risks. When these symbols appear in the body of this manual or on warning labels, refer back to these Warnings. Product-specific hazard symbols and warnings not covered in this section may appear throughout the body of this manual where applicable.

 <b>WARNING</b>	
 	<p><b>TRAFFIC HAZARD</b> Being struck by other vehicles may result in serious injury or death.</p> <ul style="list-style-type: none"> <li>Do not operate in traffic.</li> <li>Use appropriate traffic control in all traffic areas.</li> <li>Follow local highway and transportation regulations for traffic control (for example: Manual on Uniform Traffic Control Devices, U.S. Department of Transportation).</li> </ul>
   	<p><b>FIRE AND EXPLOSION HAZARD</b> Flammable fumes, such as solvent and paint fumes, in <b>work area</b> can ignite or explode. To help prevent fire and explosion:</p> <ul style="list-style-type: none"> <li>Use equipment only in well ventilated area.</li> <li>Do not fill fuel tank while engine is running or hot; shut off engine and let it cool. Fuel is flammable and can ignite or explode if spilled on hot surface.</li> <li>Keep work area free of debris, including solvent, rags and gasoline.</li> <li>Ground all equipment in the work area. See <b>Grounding</b> instructions.</li> <li>Use only grounded hoses.</li> <li>Hold gun firmly to side of grounded pail when triggering into pail. Do not use pail liners unless they are anti-static or conductive.</li> <li><b>Stop operation immediately</b> if static sparking occurs or you feel a shock. Do not use equipment until you identify and correct the problem.</li> <li>Keep a working fire extinguisher in the work area.</li> </ul>
  	<p><b>INJECTION HAZARD</b> High-pressure fluid from gun, hose leaks, or ruptured components will pierce skin. This may look like just a cut, but it is a serious injury that can result in amputation. <b>Get immediate surgical treatment.</b></p> <ul style="list-style-type: none"> <li>Do not spray without tip guard and trigger guard installed.</li> <li>Engage trigger lock when not spraying.</li> <li>Do not point gun at anyone or at any part of the body.</li> <li>Do not put your hand over the spray tip.</li> <li>Do not stop or deflect leaks with your hand, body, glove, or rag.</li> <li>Follow the <b>Pressure Relief Procedure</b> when you stop spraying and before cleaning, checking, or servicing equipment.</li> <li>Tighten all fluid connections before operating the equipment.</li> <li>Check hoses and couplings daily. Replace worn or damaged parts immediately.</li> </ul>
	<p><b>CARBON MONOXIDE HAZARD</b> Exhaust contains poisonous carbon monoxide, which is colorless and odorless. Breathing carbon monoxide can cause death.</p> <ul style="list-style-type: none"> <li>Do not operate in an enclosed area.</li> </ul>
	<p><b>PRESSURIZED ALUMINUM PARTS HAZARD</b> Use of fluids that are incompatible with aluminum in pressurized equipment can cause serious chemical reaction and equipment rupture. Failure to follow this warning can result in death, serious injury, or property damage.</p> <ul style="list-style-type: none"> <li>Do not use 1,1,1-trichloroethane, methylene chloride, other halogenated hydrocarbon solvents or fluids containing such solvents.</li> <li>Many other fluids may contain chemicals that can react with aluminum. Contact your material supplier for compatibility.</li> </ul>

# ⚠ WARNING

 	<p><b>ENTANGLEMENT HAZARD</b> Rotating parts can cause serious injury.</p> <ul style="list-style-type: none"> <li>• Keep clear of moving parts.</li> <li>• Do not operate equipment with protective guards or covers removed.</li> <li>• Do not wear loose clothing, jewelry or long hair while operating equipment.</li> <li>• Equipment can start without warning. Before checking, moving, or servicing equipment, follow the <b>Pressure Relief Procedure</b> and disconnect all power sources.</li> </ul>
 	<p><b>MOVING PARTS HAZARD</b> Moving parts can pinch, cut or amputate fingers and other body parts.</p> <ul style="list-style-type: none"> <li>• Keep clear of moving parts.</li> <li>• Do not operate equipment with protective guards or covers removed.</li> <li>• Pressurized equipment can start without warning. Before checking, moving, or servicing equipment, follow the <b>Pressure Relief Procedure</b> and disconnect all power sources.</li> </ul>
	<p><b>EQUIPMENT MISUSE HAZARD</b> Misuse can cause death or serious injury.</p> <ul style="list-style-type: none"> <li>• Do not operate the unit when fatigued or under the influence of drugs or alcohol.</li> <li>• Do not exceed the maximum working pressure or temperature rating of the lowest rated system component. See <b>Technical Data</b> in all equipment manuals.</li> <li>• Use fluids and solvents that are compatible with equipment wetted parts. See Technical Data in all equipment manuals. Read fluid and solvent manufacturer's warnings. For complete information about your material, request MSDS from distributor or retailer.</li> <li>• Do not leave the work area while equipment is energized or under pressure.</li> <li>• Turn off all equipment and follow the <b>Pressure Relief Procedure</b> when equipment is not in use.</li> <li>• Check equipment daily. Repair or replace worn or damaged parts immediately with genuine manufacturer's replacement parts only.</li> <li>• Do not alter or modify equipment. Alterations or modifications may void agency approvals and create safety hazards.</li> <li>• Make sure all equipment is rated and approved for the environment in which you are using it.</li> <li>• Use equipment only for its intended purpose. Call your distributor for information.</li> <li>• Route hoses and cables away from traffic areas, sharp edges, moving parts, and hot surfaces.</li> <li>• Do not kink or over bend hoses or use hoses to pull equipment.</li> <li>• Keep children and animals away from work area.</li> <li>• Comply with all applicable safety regulations.</li> <li>• Do not carry passengers.</li> <li>• Check work area for reduced overhead clearance (e.g. doorways, tree branches, parking ramp ceilings) and avoid contacting them.</li> </ul>



# WARNING

**BATTERY SAFETY**

The battery may leak, explode, cause burns, or cause an explosion if mishandled.

- Only use the battery type specified for use with the equipment. See **Technical Data**.
- Battery maintenance must only be performed or supervised by personnel knowledgeable of batteries and the required precautions. Keep unauthorized personnel away from battery.
- Do not dispose of battery in fire. The battery is capable of exploding.
- Follow local ordinances and/or regulations for disposal.
- Do not open or mutilate the battery. Released electrolyte has been known to be harmful to the skin and eyes and to be toxic.
- Remove watches, rings, or other metal objects.
- Only use tools with insulated handles. Do not lay tools or metal parts on top of battery.

**BURN HAZARD**

Equipment surfaces and fluid that's heated can become very hot during operation. To avoid severe burns:

- Do not touch hot fluid or equipment.

**PERSONAL PROTECTIVE EQUIPMENT**

Wear appropriate protective equipment when in the work area to help prevent serious injury, including eye injury, hearing loss, inhalation of toxic fumes, and burns. This protective equipment includes but is not limited to:

- Protective eyewear, and hearing protection.
- Respirators, protective clothing, and gloves as recommended by the fluid and solvent manufacturer.

# Component Identification (Sprayer)

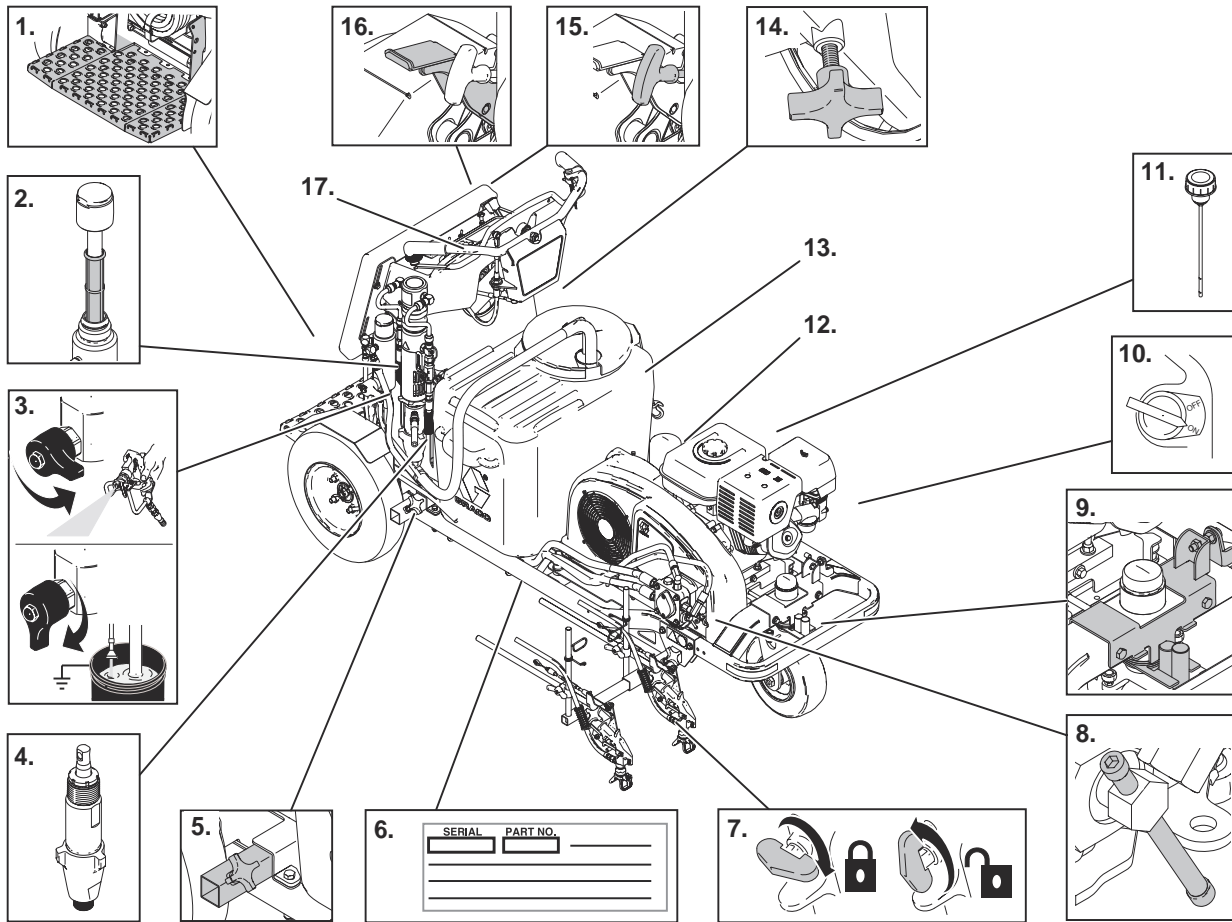

ti15841a

1	Operator Platform
2	Paint Filter
3	Prime / Drain Valve
4	Displacement Pump
5	Rear Gun Arm Mount
6	Serial Label
7	Gun Trigger Safety
8	Wheel Motor Bypass Valve
9	Straight Line Adjuster

10	Engine ON/OFF Switch
11	Hydraulic Fill Cap / Dipstick
12	Oil Filter
13	Paint Hopper (25 gallon / 75 liter)
14	Handle Bar Height Adjustment Knob
15	Engine Recoil Handle
16	Brake
17	Steering Handle

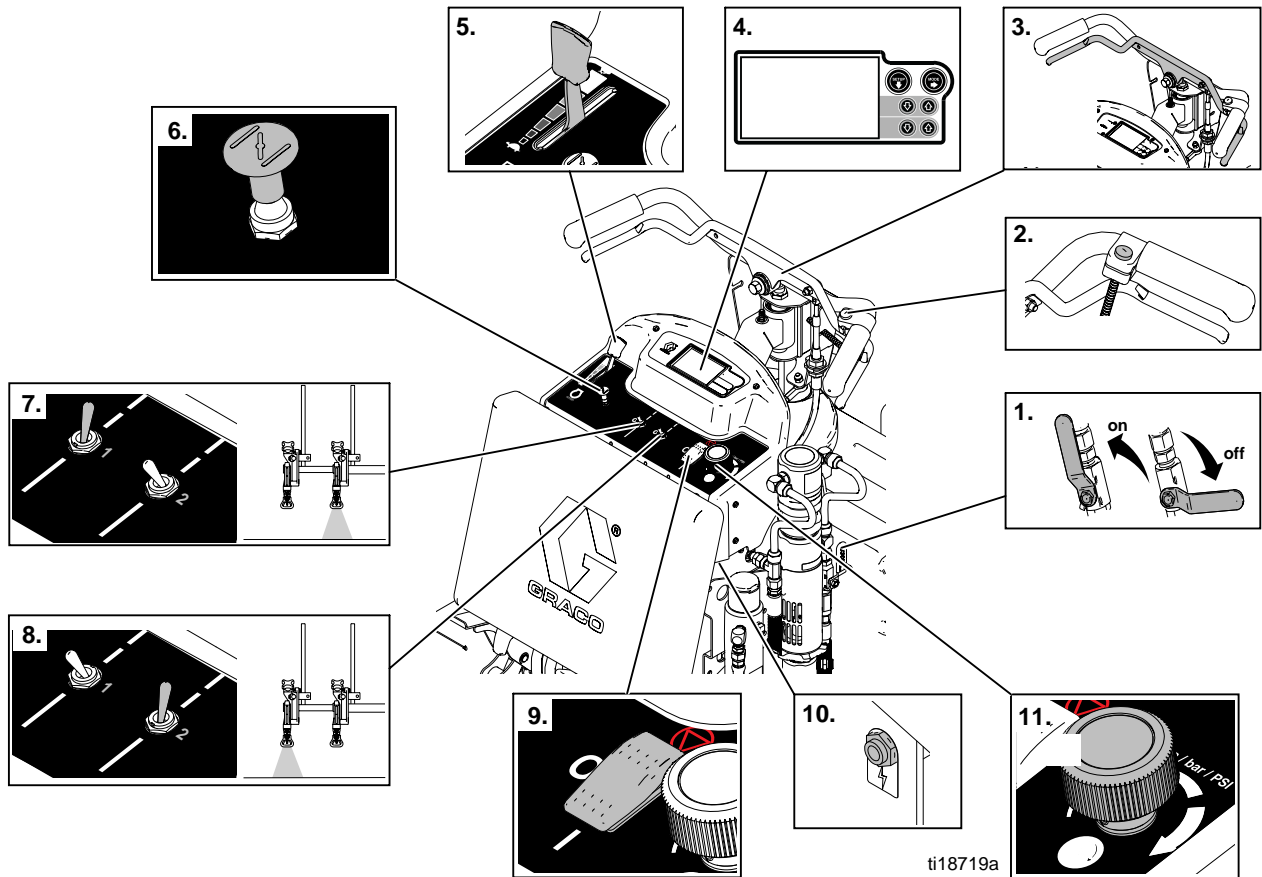

# Component Identification (Controls)



ti18719a

1	Hydraulic Pump Valve
2	Gun Trigger Control
3	Forward / Reverse Lever
4	Display
5	Engine Throttle
6	Engine Choke
7	Gun 1 Selector
8	Gun 2 Selector
9	Engine Kill / Main Power Switch
10	12V Accessory Jack
11	Pressure Control

## Grounding Procedure (For Flammable Materials Only)



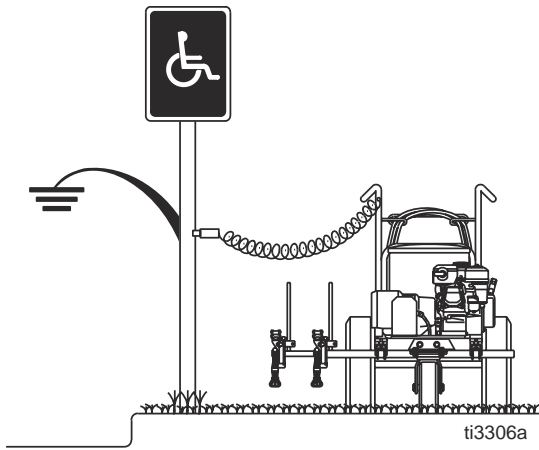

						
---	---	---	--	--	--	--

This equipment must be grounded to reduce the risk of static sparking. Static sparking can cause fumes to ignite or explode. Grounding provides an escape wire for the electric current.

1. Position striper so that the tires are not on pavement.
2. Ground sprayer with grounding clamp. Grounding clamp must attach to grounded object (e.g. metal sign post).



## Pressure Relief Procedure

						
---	---	--	---	---	--	--

This equipment stays pressurized until pressure is manually relieved. To help prevent serious injury from pressurized fluid, such as skin injection, splashing fluid and moving parts, follow the Pressure Relief Procedure when you stop spraying and before cleaning, checking, or servicing the equipment.

1. Perform **Grounding Procedure** if using flammable materials.
2. Set pump valve **OFF**. Turn engine **OFF**.

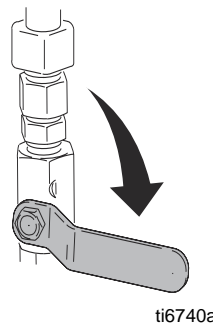

3. Turn pressure control to lowest setting. Trigger gun to relieve pressure.

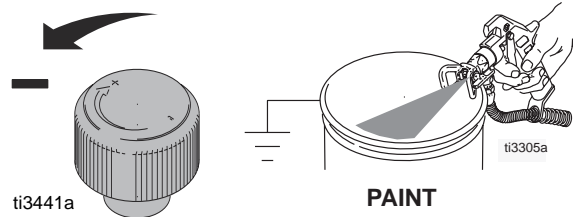



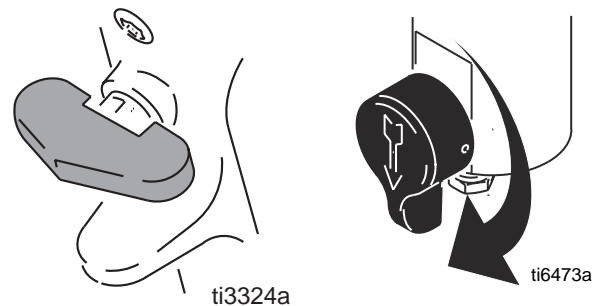

4. Engage gun trigger safety. Turn prime valve down.





# Setup/Startup

						
<p>This equipment stays pressurized until pressure is manually relieved. To help prevent serious injury from pressurized fluid, such as skin injection, splashing fluid and moving parts, follow the Pressure Relief Procedure when you stop spraying and before cleaning, checking, or servicing the equipment.</p>						

1. Perform **Grounding Procedure** (page 8) if using flammable materials.
2. Fill throat packing nut with Throat Seal Liquid (TSL) to decrease packing wear.

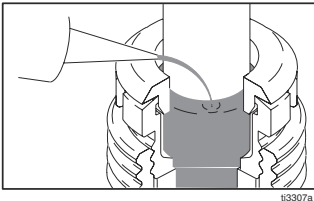

3. Check engine oil level. Add SAE 10W-30 (summer) or 5W-30 (winter). See engine manual.

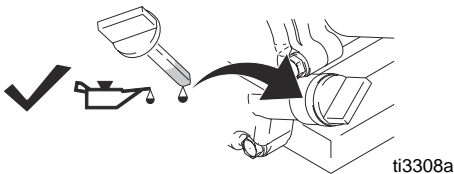

4. Fill fuel tank.

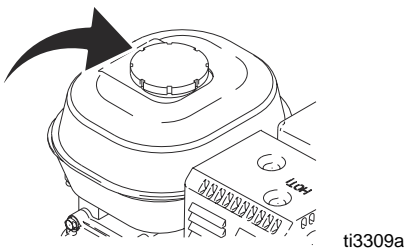

5. Set pump valve **OFF**.

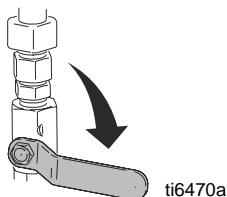

6. If removed, install strainer.

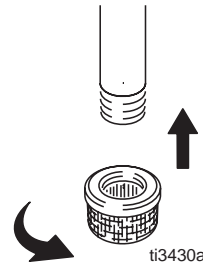

7. Turn prime valve down. Turn pressure control counterclockwise to lowest pressure.

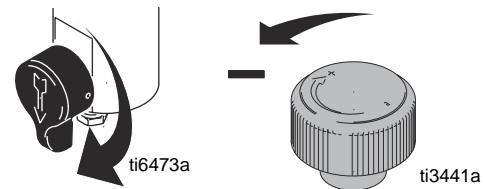

**NOTE:** Minimum hose size allowable for proper sprayer operation is 3/8 in. x 20 ft (9.5mm x 6mm).

8. Place siphon tube set in grounded metal pail partially filled with flushing fluid. Attach ground wire to true earth ground. Do 1. - 5. of **Startup** to flush out storage oil shipped in sprayer. Use water to flush water-base paint and mineral spirits to flush oil-base paint and storage oil.

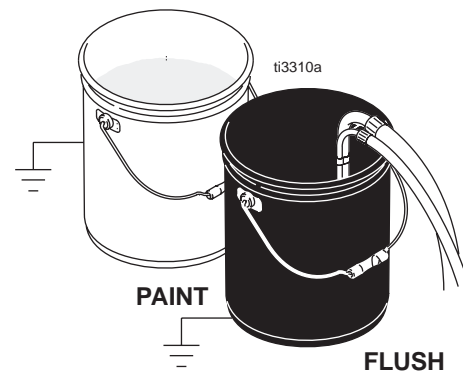

9. Apply brake.

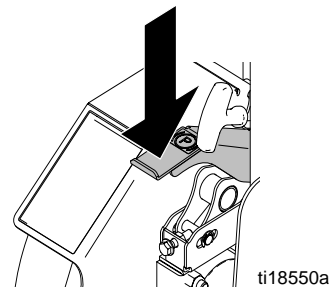

10. Start engine:

- a. Move fuel valve to open.

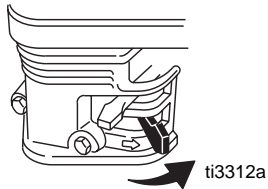

- b. Move choke to closed.

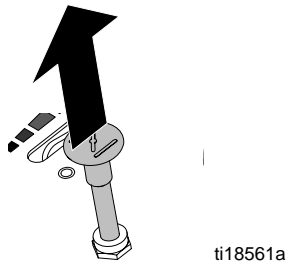

- c. Set throttle to fast.

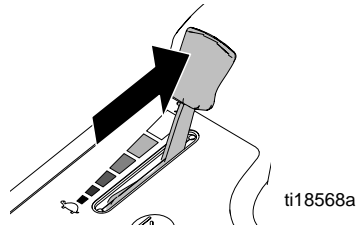

- d. Set engine switch ON.

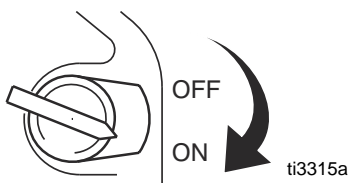

- e. Pull starter cord.

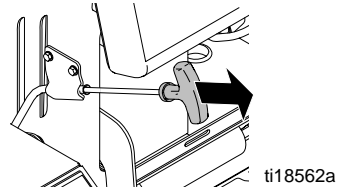

- f. After engine starts, move choke to open.

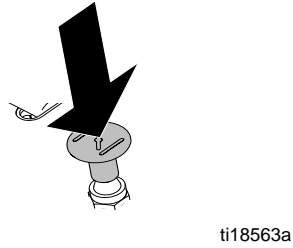

11. Set main power switch ON.

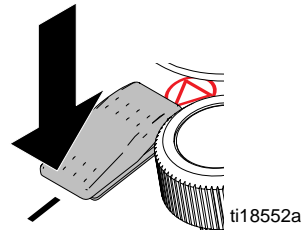

12. Set pump valve **ON** (pump is now active).

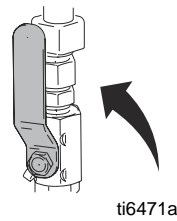

13. Set throttle to desired setting.

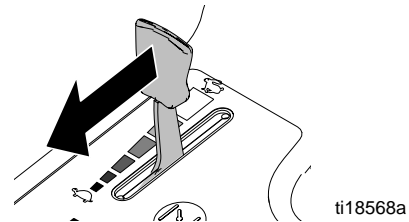

14. Increase pressure control enough to start pump. Allow fluid to circulate for 15 seconds.

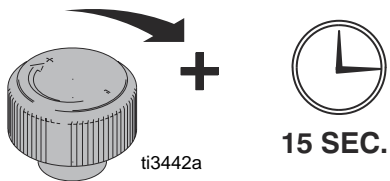

15. Turn pressure down, turn prime valve horizontal. Disengage gun trigger safety.

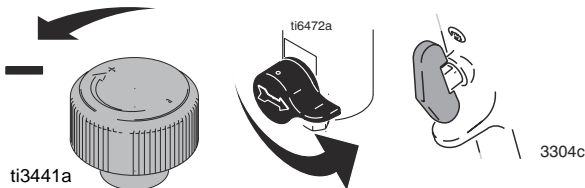

16. Hold gun against grounded metal flushing pail. Trigger gun and increase fluid pressure slowly until pump runs smoothly.

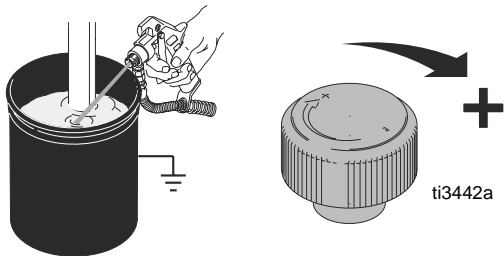

17. Inspect fittings for leaks. If leaks occur, turn sprayer OFF immediately. Perform **Pressure Relief Procedure**. Tighten leaky fittings. Repeat **Startup**, steps 1 - 7. If no leaks, continue to trigger gun until system is thoroughly flushed. Proceed to step 9.

To avoid skin injection injury, do not stop leaks with your hand or a rag.					

18. Place siphon tube in paint pail.

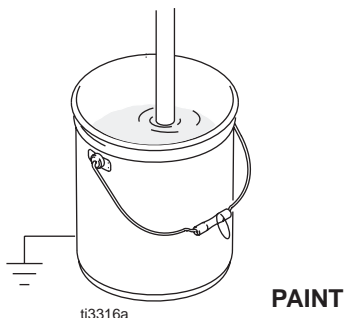

19. Trigger gun again into flushing fluid pail until paint appears. Assemble tip and guard.

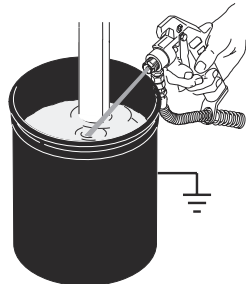

20. Repeat steps 6 - 10 on second gun for 2-gun models.

## SwitchTip and Guard Assembly

1. Engage trigger safety. Use end of SwitchTip (A) to press OneSeal (B) into tip guard (D), with curve matching tip bore (C).

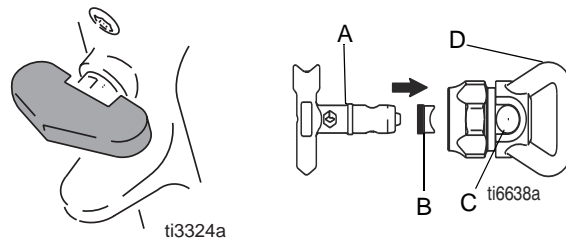

2. Insert SwitchTip in tip bore and firmly thread assembly onto gun.

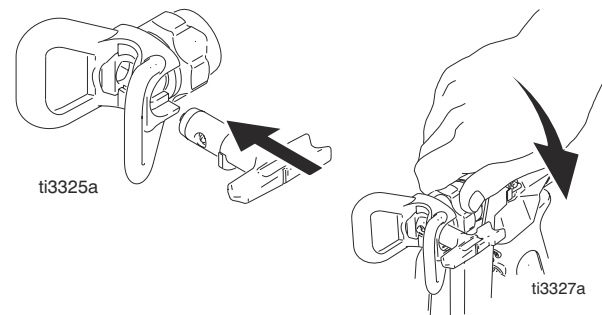

# Gun Placement

## Install Gun

1. Insert gun into gun holder. Tighten clamp.

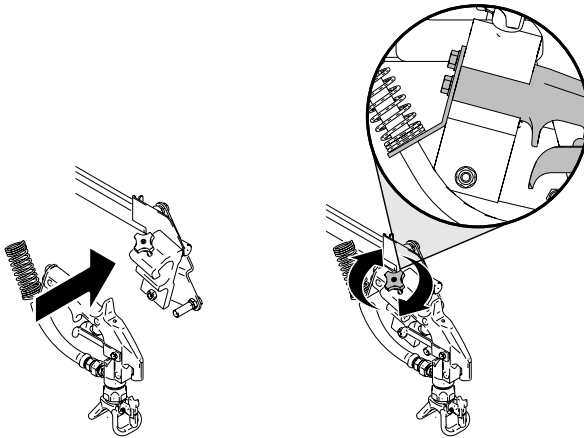

## Position Gun

2. Position gun: up/down, forward/reverse, left/right. See **Gun Positions Chart**, page 17 for examples.

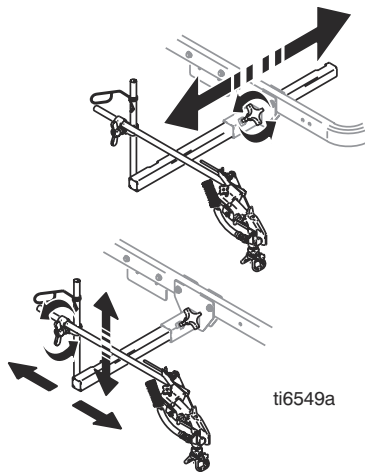

3. Use the Gun Selector Switches to determine which guns are active. Each gun selector switch has 3 positions: continuous line, OFF, and programmed line pattern.

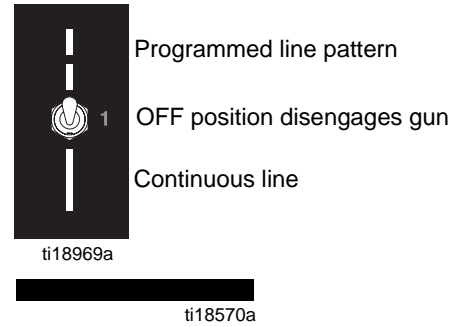

### 2 Examples:

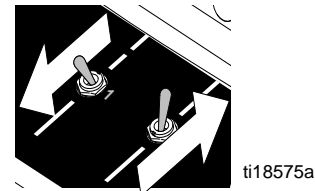
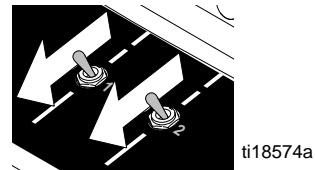

Use the Gun Trigger Control to actuate guns.

## Gun Arm Mounts

This unit is equipped with front and rear gun arm mounts.

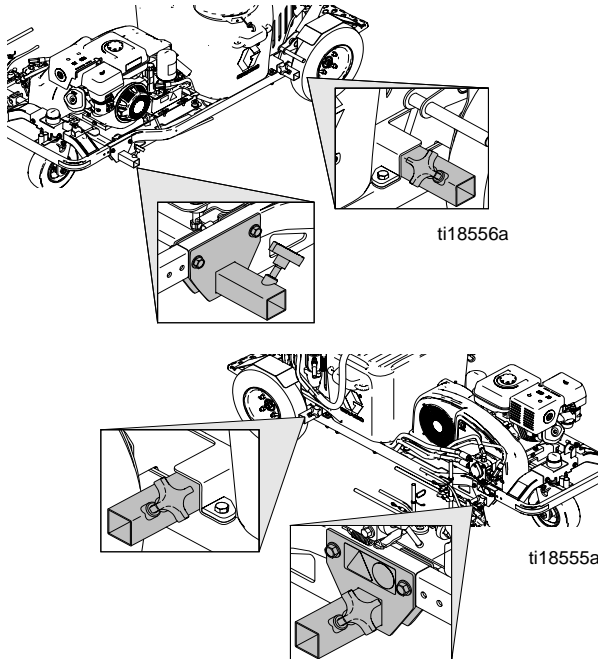

- Slide gun arm assembly into desired gun arm mounting slot.

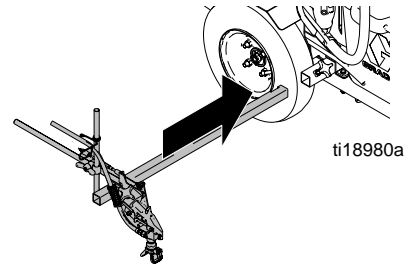

- Tighten gun arm knob into gun arm mounting slot.

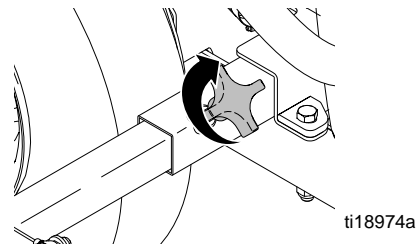

### NOTICE

Make sure all hoses, cables, and wires are properly routed through brackets and do NOT rub on tire. Contact with tire will result in damaged hoses, cables, and wires.

## Change Gun Position (Front and Back)

- Loosen gun arm knob and remove from gun arm mounting slot.

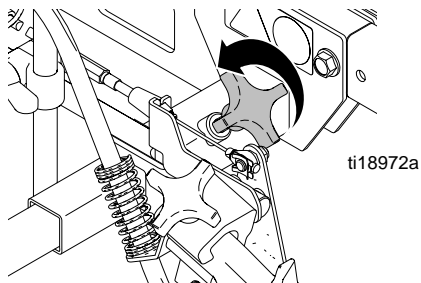

- Slide gun arm assembly (including gun and hoses) out from gun arm mounting slot.

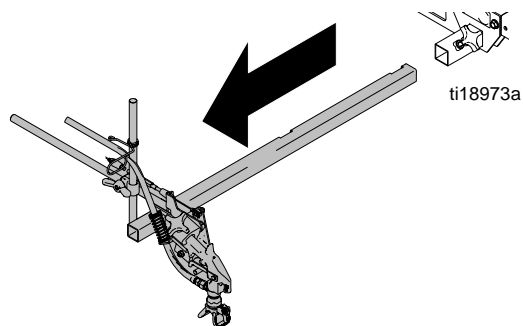

## Change Gun Position (Left and Right)

### Removal

- Loosen gun arm knob on gun arm mounting slot.

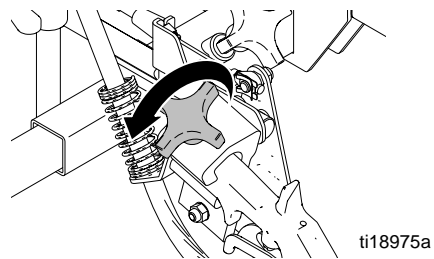

- Remove guns from gun mounts (be sure to keep track of which gun is 1 and which gun is 2).

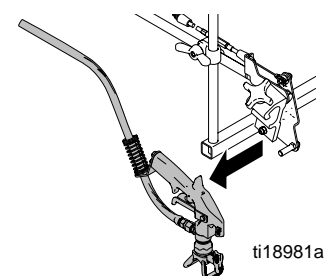

## Gun Placement

- Loosen gun mounting wing nut and remove gun mount.

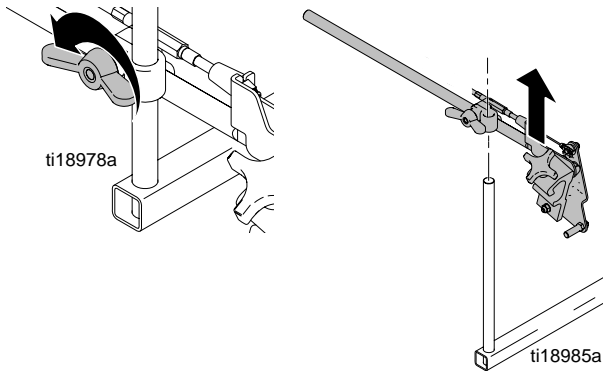

- Slide gun arm assembly out from gun arm mounting slot.

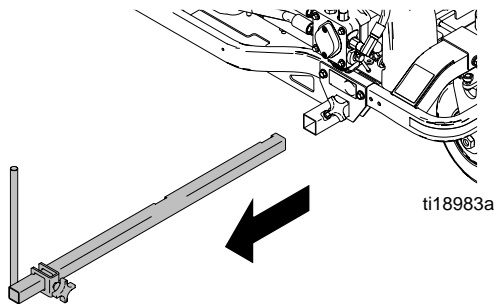

## Installation

- Slide gun arm assembly into gun arm mounting slot.

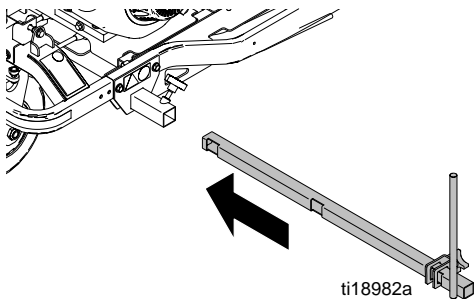

- Install gun mount onto gun arm assembly and tighten gun mount wing nut.

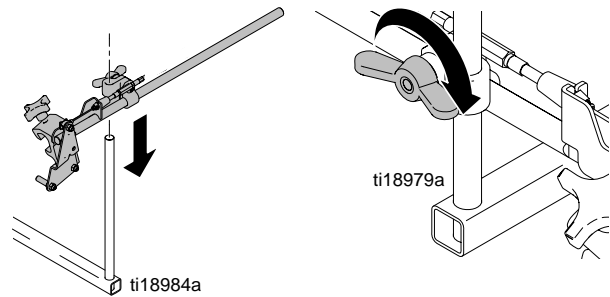

- Tighten gun arm knob into gun arm mounting slot.

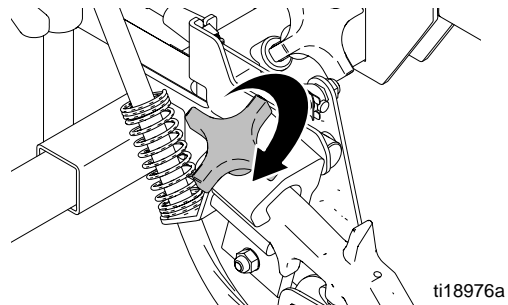

- Install guns into gun mounts.

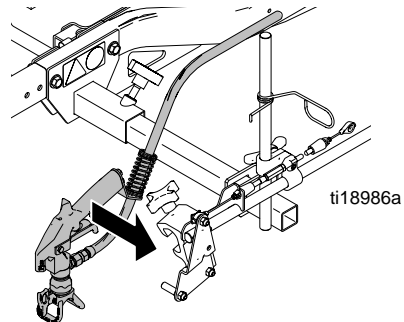

**NOTE:** Make sure all hoses, cables, and wires are properly routed through brackets.

## Gun Cable Adjustment

Adjusting the gun cable will increase or decrease the gap between the trigger plate and the gun trigger. To adjust trigger gap, perform the steps below.

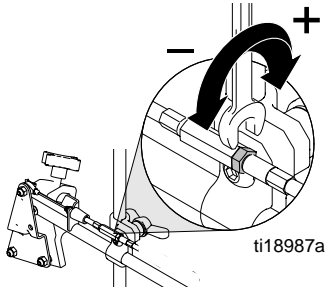

1. Use wrench to loosen locking nut on cable adjuster.
2. Loosen or tighten adjuster until desired result is achieved. **NOTE:** More thread exposed means less gap between gun trigger and trigger plate.
3. Use wrench to tighten locking nut on tie adjuster.

## Adding Gun Cable

1. Install exposed cable through cable bracket slot.

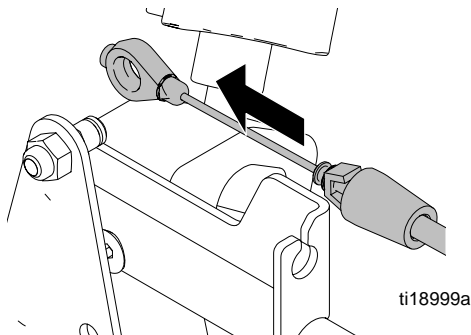

2. Insert plastic cable retainer into cable bracket hole.

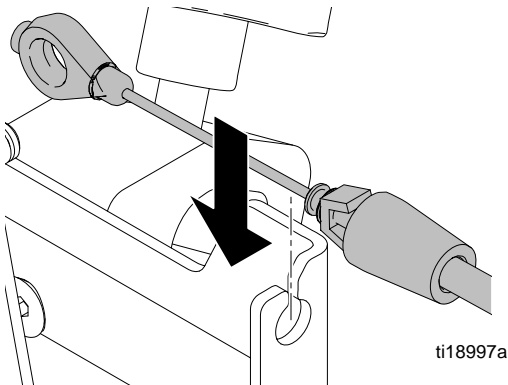

3. Install cable end onto trigger plate pin and install clip.

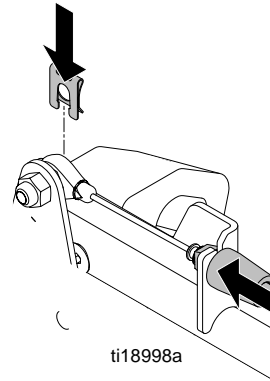

4. Route cable around unit and up through cable holes behind hose mount.

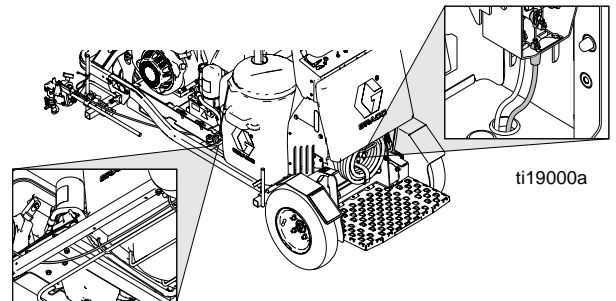

5. Route cable end loop through rectangular hole in bracket and insert plastic cable retainer into the actuator bracket. Install cable end onto actuator rod and install clip.

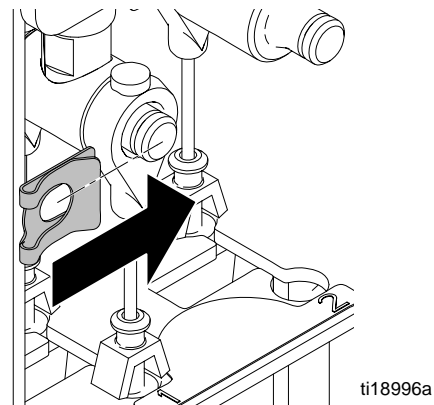

**NOTE:** Each gun actuator is capable of operating two cables. For second gun installation, attach cable to the unused actuator rod.

## Change Trigger Position

### Removal

1. Remove both hand grips from handle bar (spraying compressed air into end of handle grip works well for this).

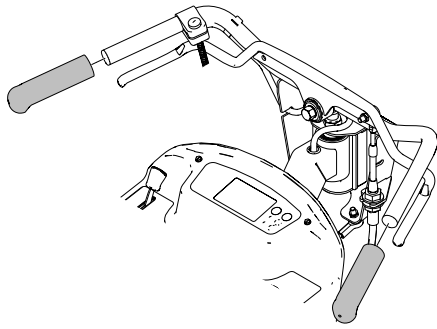

ti18988a

2. Use an allen wrench to loosen bolt on trigger mounting clamp.

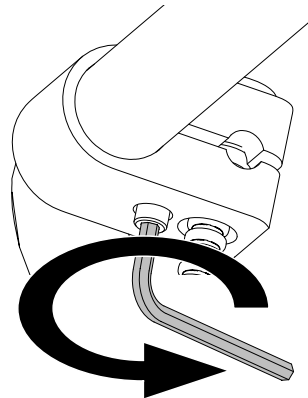

ti18989a

3. Remove trigger assembly from handle bar.

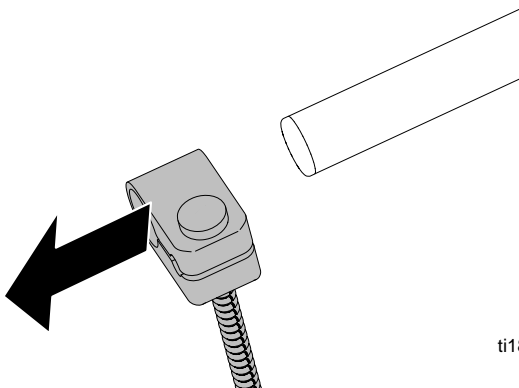

ti18990a

### Installation

1. Route trigger wire to other side of handle bar. Make sure wire is routed behind steering column, through wire slot on steering plate, and into wire clamp on handle bar.

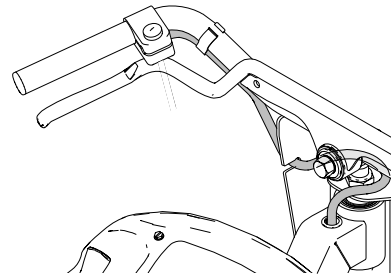

ti18993a

2. Install trigger assembly onto desired handle bar.

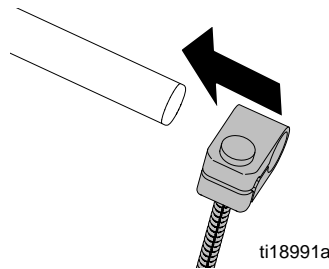

ti18991a

3. Use allen wrench to tighten bolt on trigger mounting clamp.

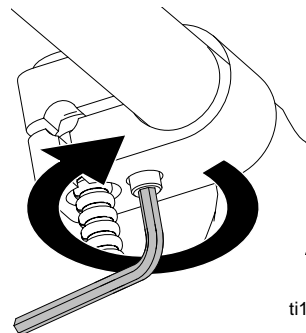

ti18992a

4. Replace hand grips.

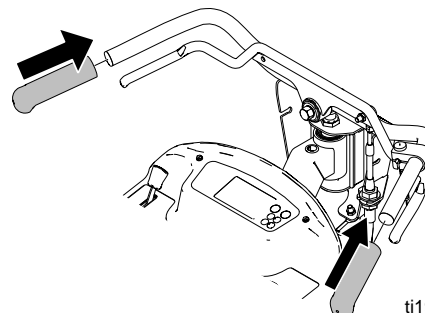

ti19254a



# Gun Positions Chart

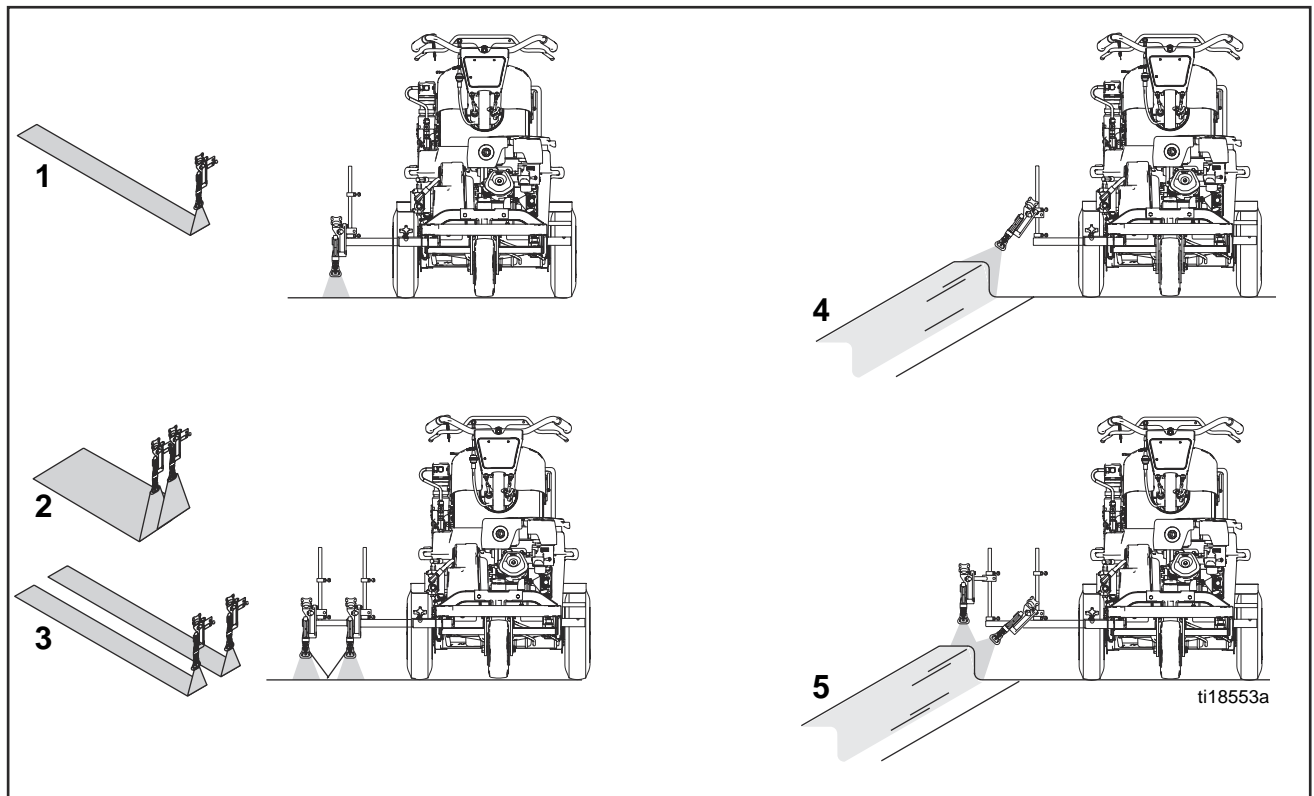

1	One line
2	One line up to 24 in. (61 cm) wide.
3	Two lines
4	One gun curb
5	Two gun curb

# Driving Instructions



Perform **Startup**, page 9.

Use the handle bars of the LineStriper to control all motion during operation. In addition to steering the LineStriper, the handle bars also control forward and reverse movement by pulling the forward/reverse control lever.

**NOTE:** Make sure wheel motor bypass valve is engaged (see page 19).

**To move forward:** Disengage brake and slowly pull control lever on right side of handlebar.

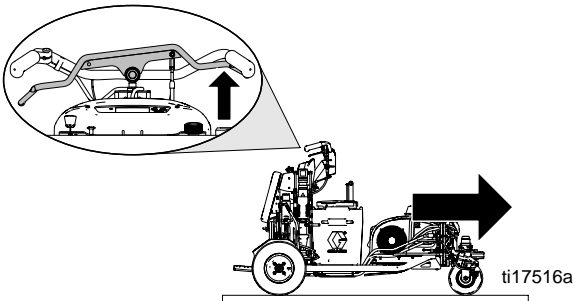

**To move in reverse:** Slowly pull control lever on left side of handlebar.

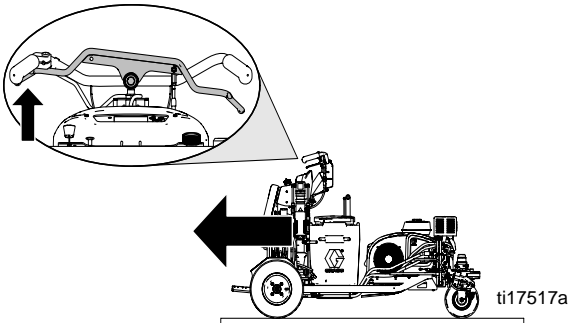

**To stop:** Release control lever and allow it to return to center.

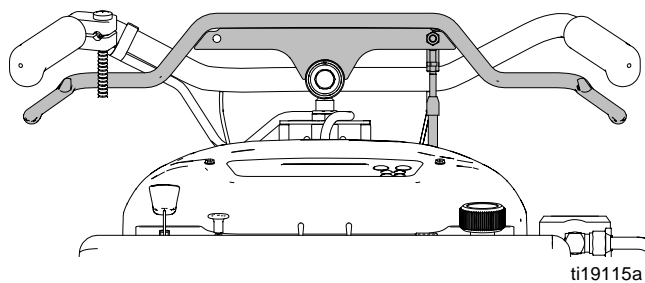

**To turn right and left:** Turn the handle bar right or left to steer the LineStriper.

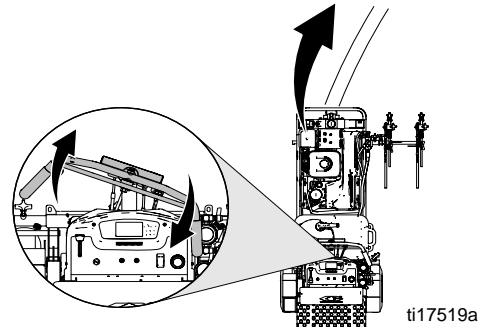
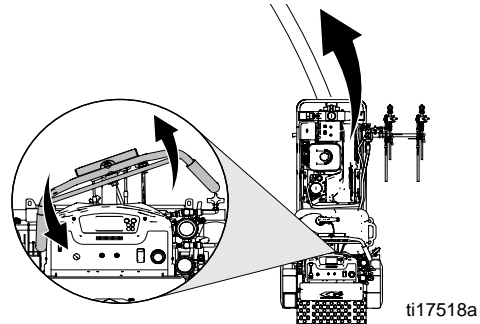

## Parking / Emergency Brake

This unit is equipped with a parking brake. Always engage parking brake when not in operation. Brake may also be used to stop machine in an emergency situation.

1. Step down on the brake lever to engage parking brake.

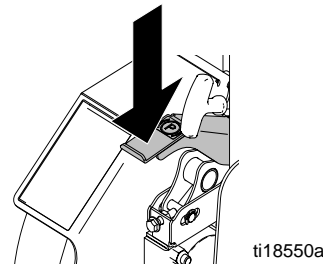

2. Lift brake lever up with foot to disengage parking brake.

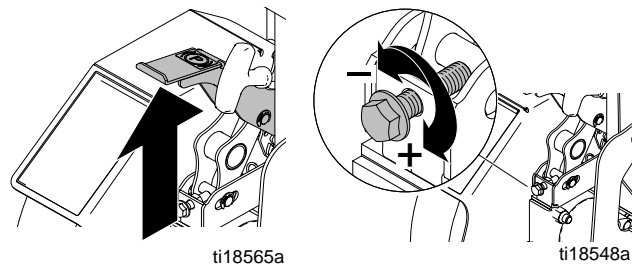

**NOTE:** Adjust screw for more or less braking force.

## Drive Engagement

The wheel motor bypass valve allows the operator to disengage the wheel tension and push the unit around. Rotate one complete turn counter-clockwise to disengage.

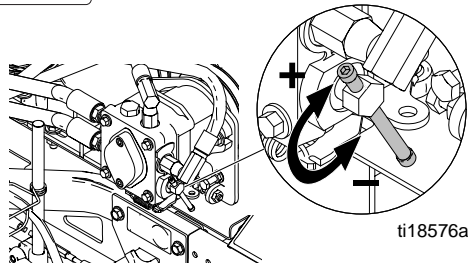
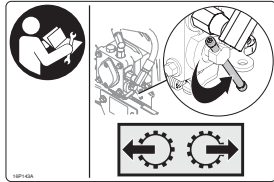

ti18576a

## Straight Line Adjustment

The front wheel is set to center the unit and allow the operator to form straight lines. Over time, the wheel may become misaligned and will need to be readjusted. To re-center the front wheel, perform the following steps:

1. Loosen two bolts on the wheel alignment plate.

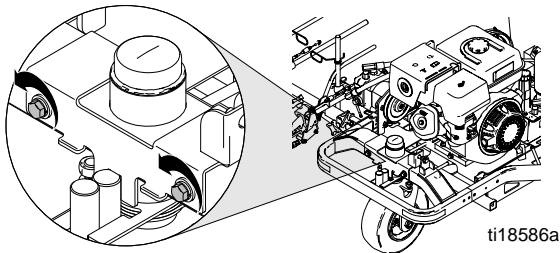

ti18586a

2. If striper arcs to the right, turn adjuster screw clockwise.

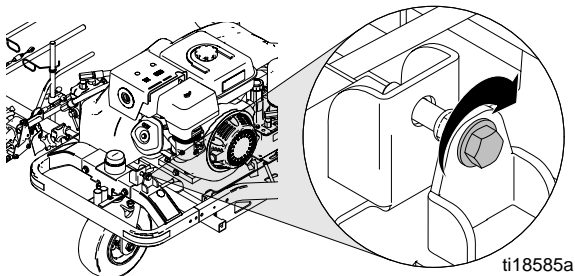

ti18585a

3. If striper arcs to the left, turn adjuster screw counter-clockwise.

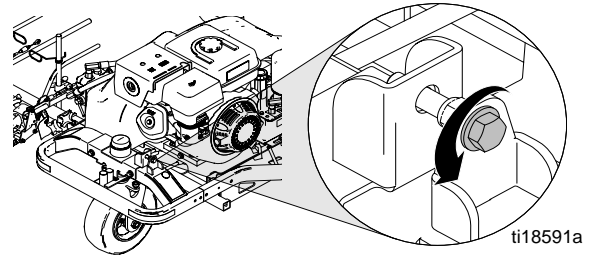

ti18591a

4. Test-drive the striper. Repeat steps 2 and 3 until striper drives straight. Tighten two bolts on wheel alignment plate to lock the new wheel setting.

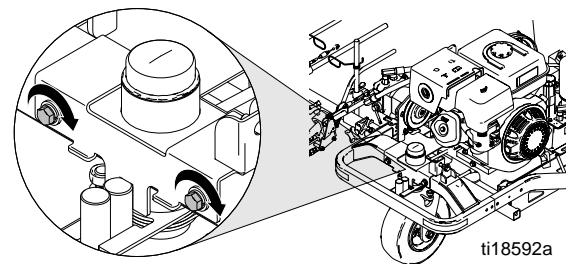

ti18592a

## Handle Bar Height Adjustment

1. Loosen handlebar height adjuster lock.

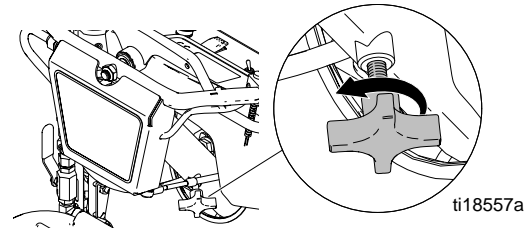

ti18557a

2. Raise or lower handlebars to desired height.

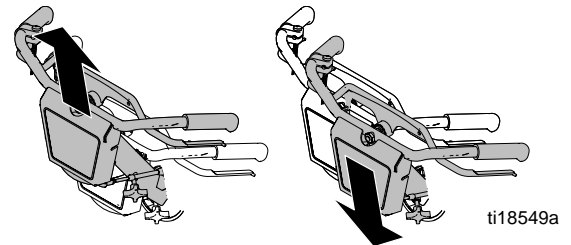

ti18549a

3. Tighten handlebar height adjuster lock.

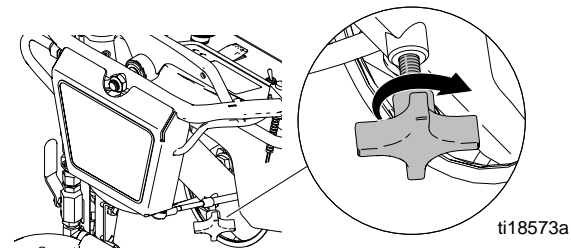

ti18573a

## Platform Storage Position

1. Raise stand and pin self-locks.

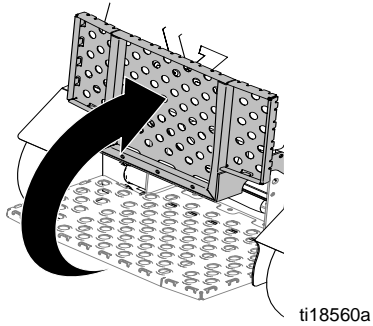

2. To lower stand, pull pin and lower stand.

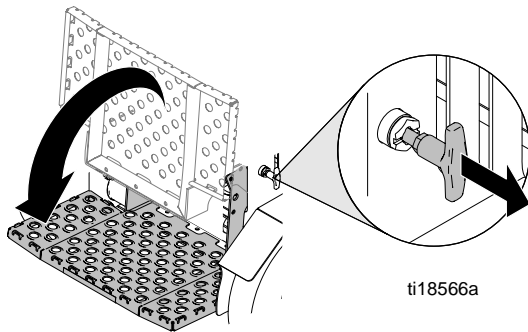

## Front Pad Adjustment

1. Loosen four bolts.
2. Slide pad up or down to desired position.

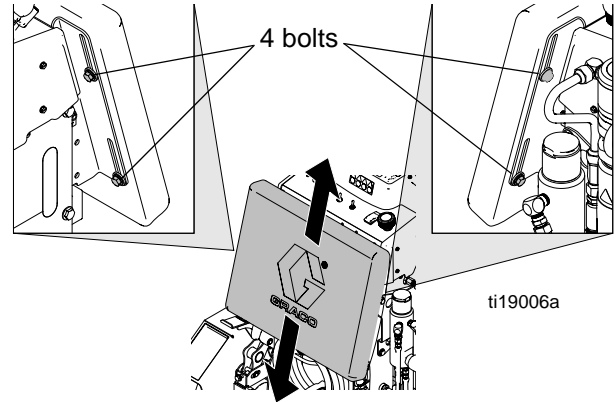

3. Tighten four bolts.

# Smart Control Overview

## Quick Guide

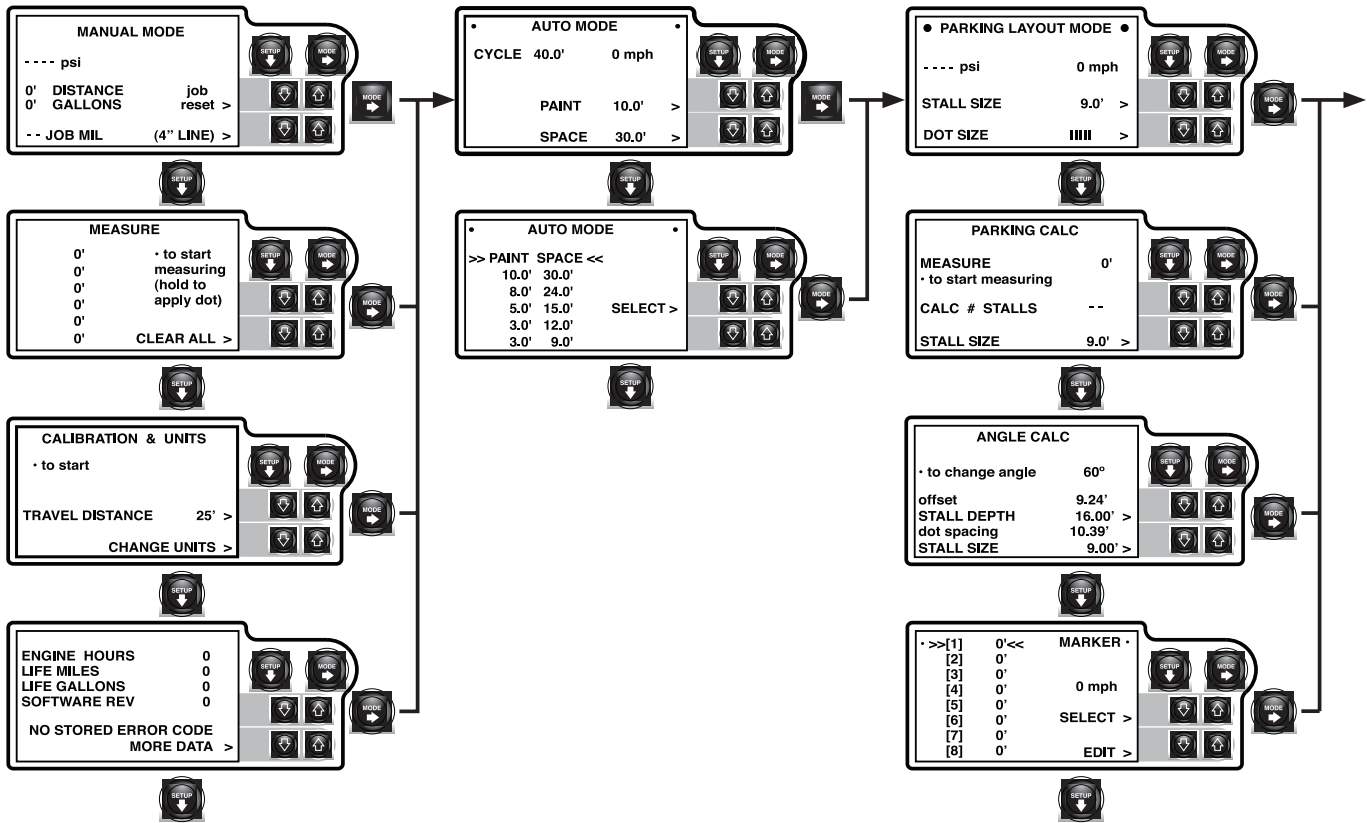

# Smart Control Operation

## Initial Setup

1. Select appropriate language.

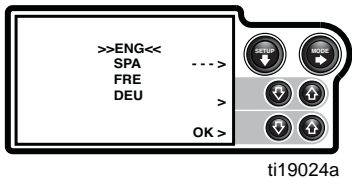

ti19024a

ENG = English  
 SPA = Spanish  
 FRE = French  
 DEU = German

**NOTE:** Languages can also be changed later.

2. Select appropriate units of measure.

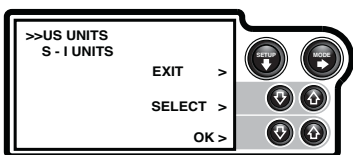

ti19025a

### US Units

Pressure = psi  
 Volume = gallons  
 Distance = feet  
 Line Thickness = mil  
 Speed = mph

### SI Units

Pressure = bar (MPa available)  
 Volume = liters  
 Distance = meters  
 Line thickness = micron (g/m<sup>2</sup> available)  
 Paint Specific gravity = 1.6  
 Speed = Kph

**NOTE:** All units can be changed individually at any time.

## Calibration

1. Check tire pressure and fill if necessary.
2. Rotate calibration bar.

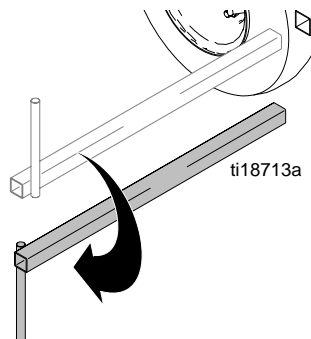

ti18713a

3. Insert calibration bar face down.

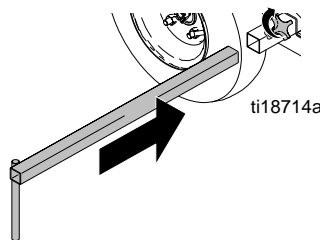

ti18714a

4. Tighten knob.

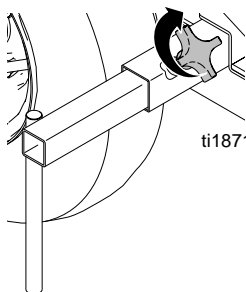

ti18715a

5. Extend steel tape to distance greater than 26 ft.

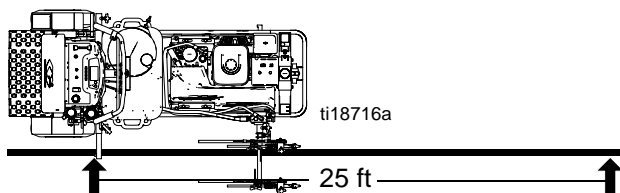

ti18716a

- Press **SETUP** twice to move to **CALIBRATION & UNITS** display. Set **TRAVEL DISTANCE** to 25 ft. Longer distances ensure better accuracy, depending on conditions.

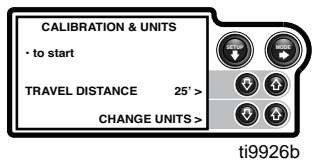
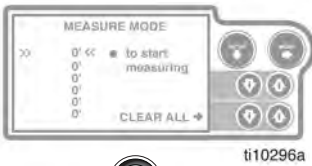
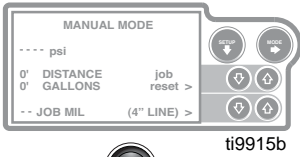

- Align calibration bar rear edge with 1 foot on steel tape.

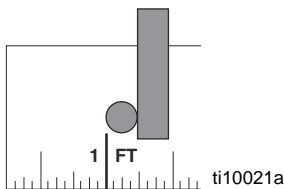

- Push gun trigger control to start calibration.

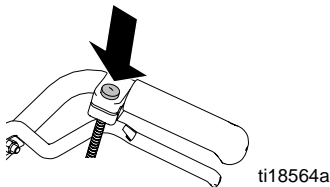

- Move striper forward. Keep calibration bar over steel tape.

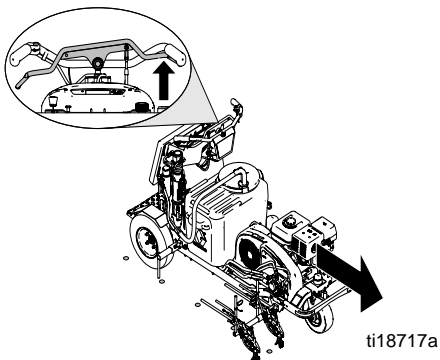

- Stop when calibration bar rear edge aligns with 26-ft. on steel tape (25-ft. distance).

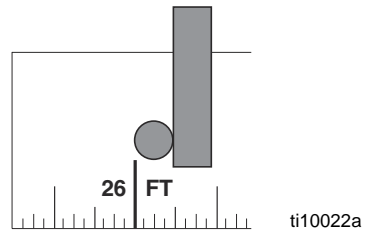

- Push gun trigger control to complete calibration.

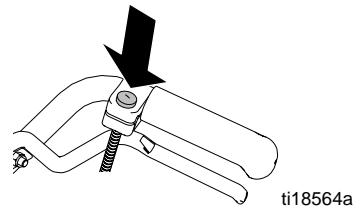

- NEW CALIBRATION STORED** displays. Press **EXIT**. Calibration is now complete.

- Go to **MEASURE** mode and verify accuracy by measuring the tape (see **MEASURE MODE**).

### Calibration Error Displays

This message is displayed if striper has rolled beyond calibration length when gun trigger control is pressed to end calibration.



This message is displayed if striper has rolled less than calibration length when gun trigger control is pressed to end calibration.



## Change Units or Language

1. Press **SETUP** twice to move to **CALIBRATION & UNITS** display. Select **CHANGE UNITS**.

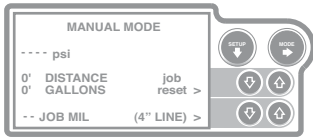

ti19107a

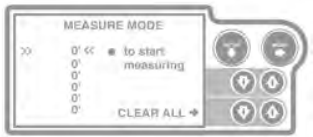

ti10296a

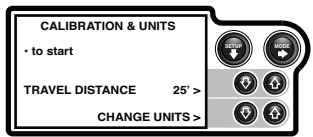

ti9926b

2. While in **CHANGE UNITS** display, press **CHANGE** to change units or **NEXT** to move to the next unit of measure. Press **SETUP** to exit **CHANGE UNITS** mode.

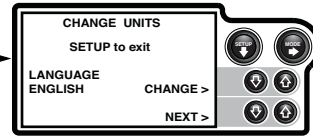

ti19031a

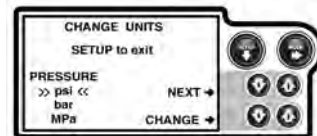

ti9931a

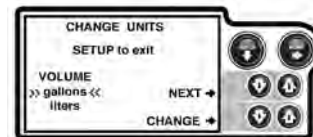

ti9930a

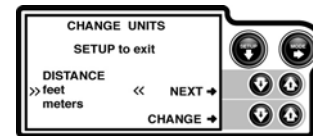

ti9929a

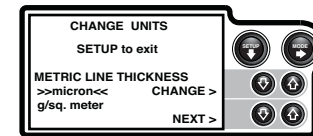

ti18508a

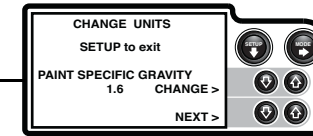

ti18509a



## Operation in Manual Mode

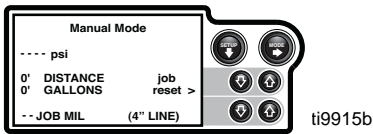

1. Make sure engine is running and main power switch is on.

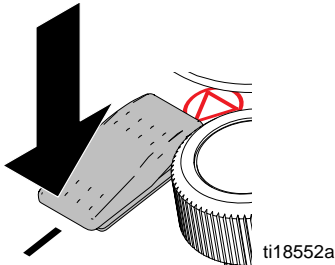

2. Use Gun Selector Switches to select guns and line type.

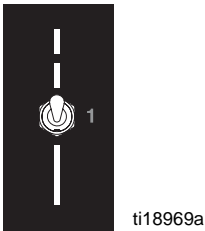

3. Press and hold Gun Trigger Control button to spray a line. Release button to stop spraying.

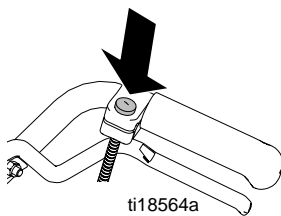

## Operation in Automatic Mode

### Preset Skip Patterns

1. In the **AUTOMATIC MODE**, the striper is equipped with Preset Skip Patterns. To select a preset skip pattern, press **MODE** button to move to **AUTOMATIC MODE**.

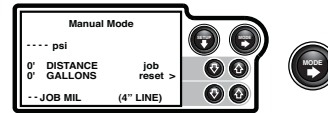

2. Press **SETUP** button to view preset skip patterns.

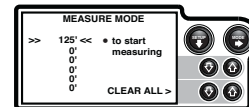

3. Use **SELECT** arrows to mark desired pattern. Press **SETUP** key to save and return to **AUTOMATIC MODE** display.
4. Use Gun Selector Switches to select guns and line type.

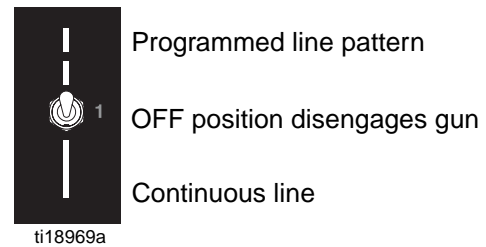

- NOTE:** Striper must be moving for guns to activate.
5. With the striper moving faster than 0.3 mph (0.5 kph) press Gun Trigger Control Button to stripe. Press button again to stop striping or reduce speed to below 0.3 mph (0.5 kph).

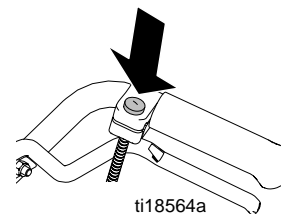

## Advanced: Preset Skip Patterns

1. A Preset Skip Pattern can be modified for a custom pattern. From **AUTO MODE** press **SETUP** key to get preset patterns.

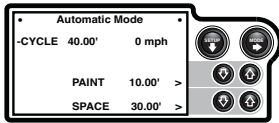

ti9923b

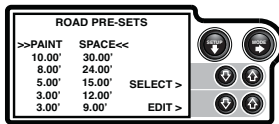

ti9936b

2. Use **SELECT** arrow keys to choose which preset pattern you wish to modify. Use **EDIT** arrow keys to get **PAINT** and **HOSE** lengths.

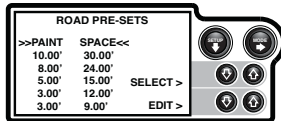

ti9936b

3. Use **EDIT** arrows to change the **PAINT** line length. Use **SELECT** arrows to scroll down to **SPACE** length. Use **EDIT** arrows to change the **SPACE** length. Press **SETUP** key to save and return to **AUTOMATIC MODE** display.



**NOTE:** When travel speeds exceed 0.3 mph (0.5 Kph) in **MANUAL** or **AUTOMATIC** modes, the display will change to large speed display format.

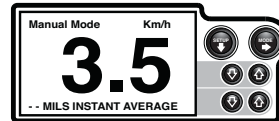

ti19026a

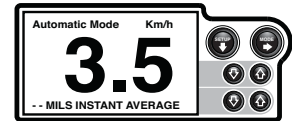

ti19027a

## Parking Layout Mode

**NOTE:** Please use the 286111 tip provided with striper for parking lot layout work. For best performance set pressure to 1000 psi (68.9 bar, 6.89 MPa) and reverse tip.

## Parking Mode

### Basic Stalls

From **MANUAL MODE** press **MODE** button twice for **PARKING LAYOUT MODE**. This display allows you to change stall size and dot size. It also shows speed. The two dots before and after **PARKING MODE** flash alternately when Gun Trigger Control is pressed to signal mode is active.

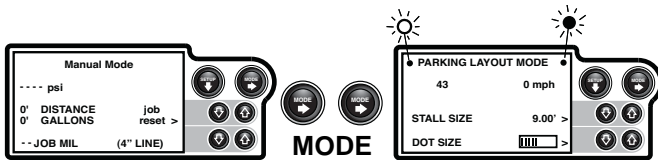

1. Press down arrow opposite **DOT SIZE** to decrease dot size. Press up arrow to increase dot size.

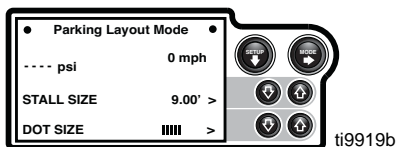

2. Press down arrow opposite **STALL SIZE** to decrease stall width. Press up arrow to increase stall width.

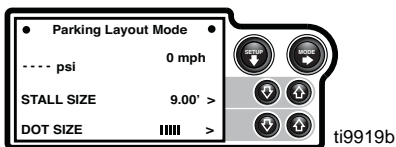

3. Press Gun Trigger Control button and move striper forward. Striper marks dots every 9.0 ft (or stall size you have set) until Gun Trigger Control button is pressed again.

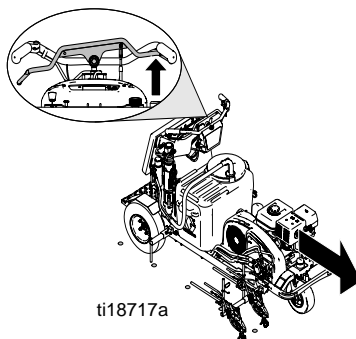
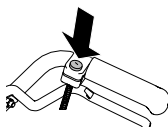

## Advanced: Parking Calc

1. Press **SETUP** and move to **PARKING CALC**. The striper divides the stall size into the measurement taken here to determine the number of stalls that can be striped in this space.

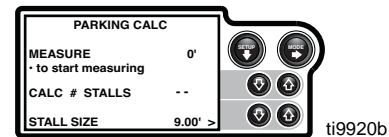
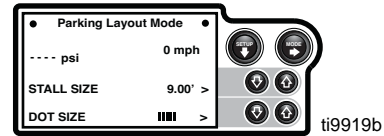

2. The last length measured in the **MEASURE MODE** is transmitted to this display, or press Gun Trigger Control to start measuring (press Gun Trigger Control again to stop measuring). You can change **STALL SIZE** (wider or narrower) or **CALC # STALLS** (total number of stalls).

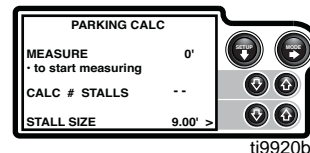

3. Press **SETUP** three times to return to **PARKING LAYOUT MODE**. Press Gun Trigger Control button, move forward and start to mark dots. Press Gun Trigger Control button again to end dots.

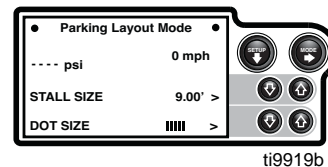

## Angle Stalls

1. Angle stalls require the operator to input stall angle and depth. The Auto-Layout System calculates the offset distance based on this input.

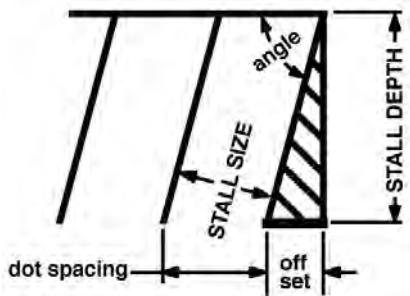

ti10059a

2. From **PARKING LAYOUT MODE** press **SETUP** two times for **ANGLE CALC**.

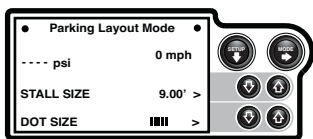

ti9919b

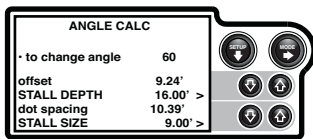

ti9921b

3. **ANGLE:** Press and hold Gun Trigger Control button to change stall angle. Angle increases up to 90° and wraps around and starts over at 45°.

**STALL DEPTH:** Press down arrow to decrease or up arrow to increase stall depth.

**STALL SIZE:** Press down arrow to decrease or up arrow to increase stall size.

4. Measure and mark the offset distance for the first stall.

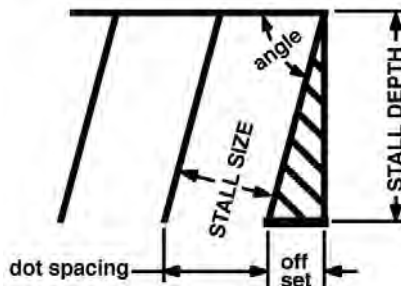

ti10059a

5. Press **SETUP** two times to save angled stall dot spacing to **PARKING LAYOUT MODE**.

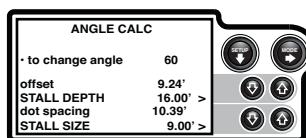

ti9921b

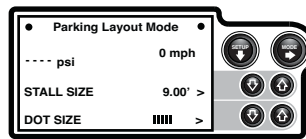

ti9919b

# Marker Mode

1. Press the **MODE** key to select Parking Layout Mode.
2. Press **SETUP** three times to select Marker Layout Mode.

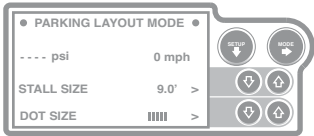

ti19136a

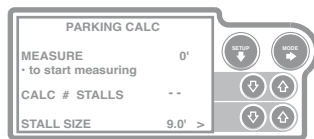

ti19137a

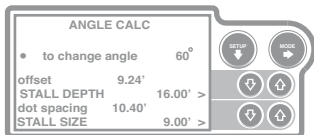

ti10291b

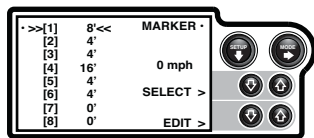

ti18507a

3. Use **SELECT** and **EDIT** keys to set up reflective marker pattern.

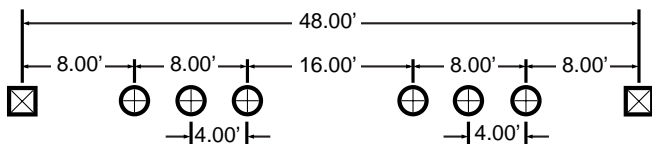

Automatic marker layout example shows typical lane line layout for reflective markers. Set space sizes up to 8 consecutive measurements. By leaving zeros in any space, AutoLayout will skip to the next measurement in a continuous loop.

### OTHER USES:

- Multiple spaced handicap stall layout
- Double line stalls

4. Press gun trigger control and move striper forward to mark dots. Press gun trigger control again to stop marking dots.

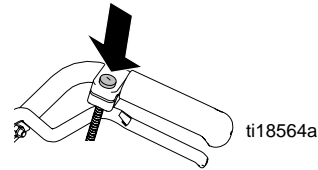

ti18564a

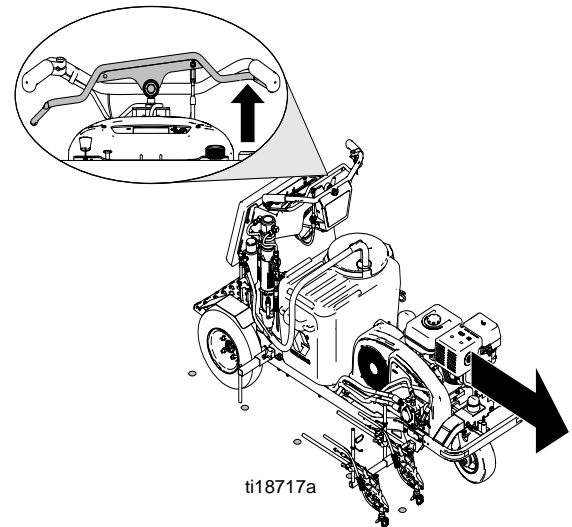

ti18717a

## Measure Mode

1. Press **SETUP** once from Manual Mode display.

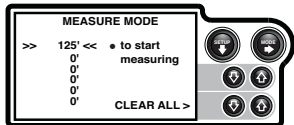
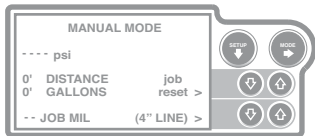

ti9942a

2. Press Gun Trigger Control and move striper forward or backward (back ward is a negative distance).

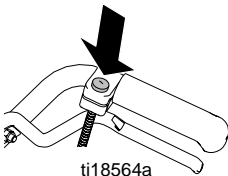

3. Press Gun Trigger Control to end measured length. Up to six lengths are viewable.

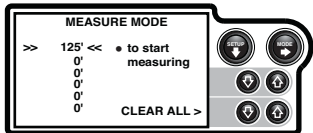
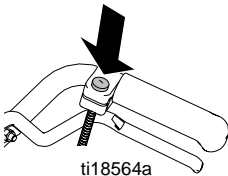

ti9942b

**NOTE:** The last measured length is also saved as the length in **PARKING CALC** display.

**NOTE:** Press and hold Gun Trigger Control at any time to apply a dot.

## Machine Information

1. Press **SETUP** button three times from Manual Mode display.

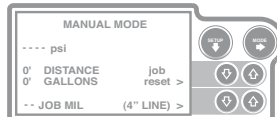

ti19107a

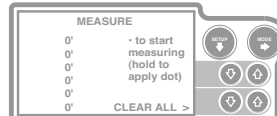

ti19108a

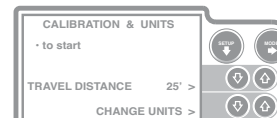

ti19106a

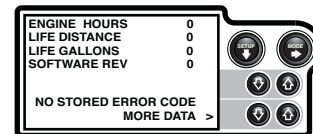

ti9918b

2. Press arrow keys to toggle between more data screens.

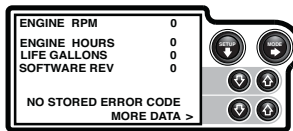



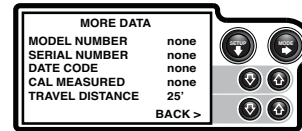

ti9933b



ti9934b

# Cleanup

						
<p>This equipment stays pressurized until pressure is manually relieved. To help prevent serious injury from pressurized fluid, such as skin injection, splashing fluid and moving parts, follow the Pressure Relief Procedure when you stop spraying and before cleaning, checking, or servicing the equipment.</p>						

1. Perform **Pressure Relief Procedure**, page 8.
2. Remove guard and SwitchTip.

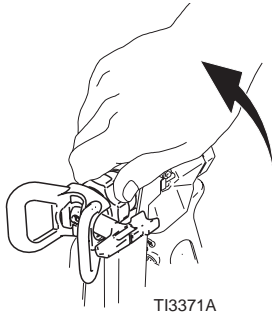

3. Unscrew cap, remove filter. Assemble without filter.

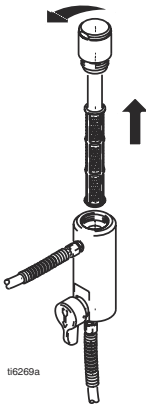

4. Clean filter, guard and SwitchTip in flushing fluid.



5. Place siphon tube set in grounded metal pail partially filled with flushing fluid. Attach ground wire to true earth ground. Perform Startup steps 1 - 6 (see page 9) to flush out paint in sprayer. Use water to flush water-base paint and mineral spirits solvent (also called white spirit) to flush oil-base paint.
6. Hold gun against paint bucket and pull trigger until water or solvent appears.

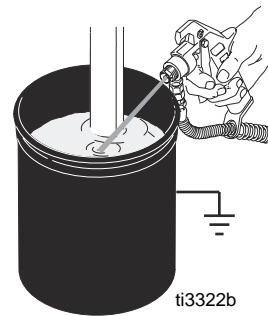

7. Move gun to solvent or water bucket. Hold gun against bucket and pull trigger until the system is thoroughly flushed.
8. Fill pump with Pump Armor and reassemble filter, guard and SwitchTip.
9. Each time you spray and store, fill throat packing nut with TSL to decrease packing wear.

# Hydraulic Oil/Filter Change

## Removal



This equipment stays pressurized until pressure is manually relieved. To help prevent serious injury from pressurized fluid, such as skin injection, splashing fluid and moving parts, follow the Pressure Relief Procedure when you stop spraying and before cleaning, checking, or servicing the equipment.

1. **Relieve pressure**, page 8.
2. Place drip pan or rags under sprayer to catch hydraulic oil that drains out.
3. Remove drain plug. Allow hydraulic oil to drain.
4. Unscrew filter (227) slowly - oil runs into groove and drains out rear.

## Installation

1. Apply a light film of oil on filter gasket. Install drain plug and oil filter (227). Tighten oil filter 3/4 turn after gasket contacts base.
2. Fill with five quarts of Graco hydraulic oil 169236 (5 gallon/20 liter) or 207428 (1 gallon/3.8 liter).
3. Check oil level.

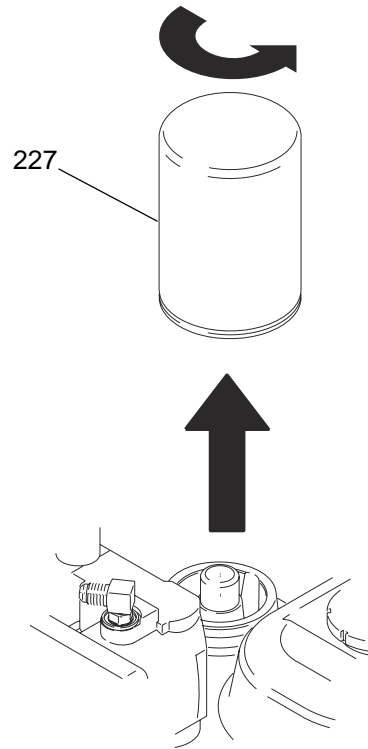



# Technical Specifications

<b>LineLazer IV 250SPS (Models 24F307, 24K960, 24K961, 24K962, 24M608)</b>		
	<b>U.S.</b>	<b>Metric</b>
<b>Dimensions</b>		
Height (with handle bar down)	Unpackaged - 47.25 in. Packaged - 54.25 in.	Unpackaged - 120.0 cm Packaged - 137.8 cm
Width	Unpackaged - 33.0 in. Packaged - 40.0 in.	Unpackaged - 83.8 cm Packaged - 101.6 cm
Length (with platform down)	Unpackaged - 73.5 in. Packaged - 78.0 in.	Unpackaged - 186.7 cm Packaged - 198.1 cm
Weight	Unpackaged - 627.0 lb Packaged - 730.0 lb	Unpackaged - 284.4 kg Packaged - 331.1 kg
<b>Noise (dBA)</b>		
Sound Power per ISO 3744:	97.1	
Sound Pressure measured at 3.1 feet (1m):	81.2	
<b>Vibration (sq m/sec) (8 hours daily exposure)</b>		
Hand Arm (per ISO 5349)	1.2	
Whole Body (per ISO 2631)	0.0	
<b>Power Rating (Horse Power)</b>		
Power Rating (Horse Power) per SAE J1349	8.5 @ 3600 rpm	6.3 @ 3600 rpm
Maximum Delivery	2.5 gpm	9.5 lpm
Maximum Tip Size 1 gun 2 gun	.055 in. tip .039 in. tip	
Inlet paint strainer	16 mesh	1190 micron
Outlet paint strainer	60 mesh	250 micron
Pump inlet size	1 in. NSPM (m)	
Pump outlet size	3/8 NPT (f)	
Hydraulic reservoir capacity	1.25 gallons	4.73 liters
Maximum hydraulic pressure	1825 psi	124 bar
Maximum working pressure	3300 psi	228 bar, 22.8 MPa
Maximum forward speed	10 mph	16 kph
Maximum reverse speed	6 mph	9.7 kph
Electrical Capacity	14 A @ 3600 rpm	

**Wetted Parts:**

PTFE, Nylon, polyurethane, V-Max, UHMWPE, fluoroelastomer, acetal, leather, tungsten carbide, stainless steel, chrome plating, nickel-plated carbon steel, ceramic





# Graco Standard Warranty

Graco warrants all equipment referenced in this document which is manufactured by Graco and bearing its name to be free from defects in material and workmanship on the date of sale to the original purchaser for use. With the exception of any special, extended, or limited warranty published by Graco, Graco will, for a period of twelve months from the date of sale, repair or replace any part of the equipment determined by Graco to be defective. This warranty applies only when the equipment is installed, operated and maintained in accordance with Graco's written recommendations.

This warranty does not cover, and Graco shall not be liable for general wear and tear, or any malfunction, damage or wear caused by faulty installation, misapplication, abrasion, corrosion, inadequate or improper maintenance, negligence, accident, tampering, or substitution of non-Graco component parts. Nor shall Graco be liable for malfunction, damage or wear caused by the incompatibility of Graco equipment with structures, accessories, equipment or materials not supplied by Graco, or the improper design, manufacture, installation, operation or maintenance of structures, accessories, equipment or materials not supplied by Graco.

This warranty is conditioned upon the prepaid return of the equipment claimed to be defective to an authorized Graco distributor for verification of the claimed defect. If the claimed defect is verified, Graco will repair or replace free of charge any defective parts. The equipment will be returned to the original purchaser transportation prepaid. If inspection of the equipment does not disclose any defect in material or workmanship, repairs will be made at a reasonable charge, which charges may include the costs of parts, labor, and transportation.

**THIS WARRANTY IS EXCLUSIVE, AND IS IN LIEU OF ANY OTHER WARRANTIES, EXPRESS OR IMPLIED, INCLUDING BUT NOT LIMITED TO WARRANTY OF MERCHANTABILITY OR WARRANTY OF FITNESS FOR A PARTICULAR PURPOSE.**

Graco's sole obligation and buyer's sole remedy for any breach of warranty shall be as set forth above. The buyer agrees that no other remedy (including, but not limited to, incidental or consequential damages for lost profits, lost sales, injury to person or property, or any other incidental or consequential loss) shall be available. Any action for breach of warranty must be brought within two (2) years of the date of sale.

**GRACO MAKES NO WARRANTY, AND DISCLAIMS ALL IMPLIED WARRANTIES OF MERCHANTABILITY AND FITNESS FOR A PARTICULAR PURPOSE, IN CONNECTION WITH ACCESSORIES, EQUIPMENT, MATERIALS OR COMPONENTS SOLD BUT NOT MANUFACTURED BY GRACO.** These items sold, but not manufactured by Graco (such as electric motors, switches, hose, etc.), are subject to the warranty, if any, of their manufacturer. Graco will provide purchaser with reasonable assistance in making any claim for breach of these warranties.

In no event will Graco be liable for indirect, incidental, special or consequential damages resulting from Graco supplying equipment hereunder, or the furnishing, performance, or use of any products or other goods sold hereto, whether due to a breach of contract, breach of warranty, the negligence of Graco, or otherwise.

## Graco Information

For the latest information about Graco products, visit [www.graco.com](http://www.graco.com).

**TO PLACE AN ORDER**, contact your Graco distributor or call 1-800-690-2894 to identify the nearest distributor.

*All written and visual data contained in this document reflects the latest product information available at the time of publication. Graco reserves the right to make changes at any time without notice.*

*For patent information, see [www.graco.com/patents](http://www.graco.com/patents).*

Original instructions. This manual contains English. MM 3A2090

**Graco Headquarters:** Minneapolis

**International Offices:** Belgium, China, Japan, Korea

**GRACO INC. P.O. BOX 1441 MINNEAPOLIS, MN 55440-1441**

**Copyright 2010, Graco Inc. is registered to ISO 9001**

[www.graco.com](http://www.graco.com)

Revision A - May 2012

## Free Manuals Download Website

<http://myh66.com>

<http://usermanuals.us>

<http://www.somanuals.com>

<http://www.4manuals.cc>

<http://www.manual-lib.com>

<http://www.404manual.com>

<http://www.luxmanual.com>

<http://aubethermostatmanual.com>

Golf course search by state

<http://golfingnear.com>

Email search by domain

<http://emailbydomain.com>

Auto manuals search

<http://auto.somanuals.com>

TV manuals search

<http://tv.somanuals.com>