

ProMix[®] 2KE

3A0868G

Pump-Based Plural Component Proportioner

EN

Self-contained, electronic two-component paint proportioner. For professional use only.



Important Safety Instructions

Read all warnings and instructions in this manual. Save these instructions.

See pages 3-4 for model information, including maximum working pressure and approvals.

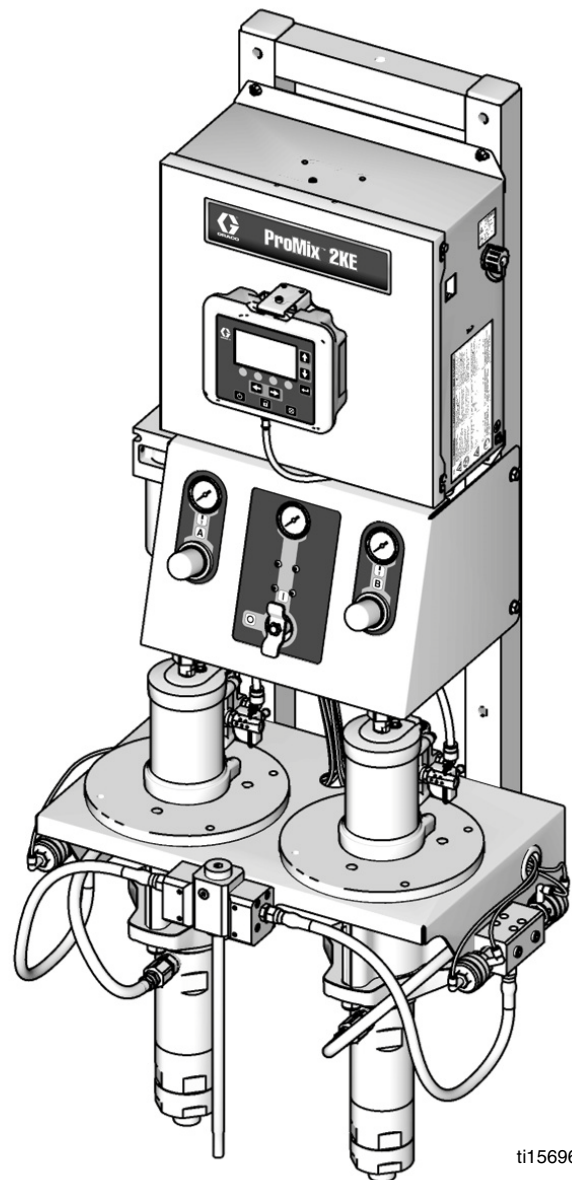

ti15696a









PROVEN QUALITY. LEADING TECHNOLOGY.

Contents

| | | | |
|---|-----------|---|-----------|
| Models | 3 | Run Mode Details | 39 |
| Warnings | 5 | Run Mix Spray (Screen 2) | 39 |
| Important Two-Component Material Information . | 8 | Run Home (Screen 1) | 39 |
| Isocyanate Conditions | 8 | Run Mix Batch (Screen 3) | 39 |
| Material Self-ignition | 8 | Run Mix Totals (Screen 4) | 40 |
| Keep Components A and B Separate | 8 | Run Job Number (Screen 38) | 40 |
| Moisture Sensitivity of Isocyanates | 8 | Run Log Errors (Screens 5-14) | 40 |
| Changing Materials | 8 | Run Pump Control (Screen 15) | 41 |
| Glossary of Terms | 9 | Setup Mode Details | 42 |
| Overview | 10 | Password (Screen 16) | 42 |
| Usage | 10 | Setup Home (Screen 17) | 42 |
| Component Identification and Definition | 10 | Configure 1-4 (Screens 18-21) | 43 |
| Installation | 10 | Recipe 1-1 (Screen 28) | 44 |
| General Information | 10 | Recipe 1-2 (Screen 29) | 44 |
| Intrinsically Safe Installation Requirements . . . | 11 | Maintenance 1-3 (Screens 24-26) | 45 |
| Display Module | 13 | Maintenance Recommendations | 45 |
| Air Supply | 13 | Calibration 1 and 2 (Screens 22 and 23) | 46 |
| Fluid Supply | 14 | Troubleshooting (Screens 35-37) | 46 |
| Tubing Chart and Diagrams | 16 | Dynamic Dosing | 48 |
| Electrical | 18 | System Errors | 50 |
| Grounding | 19 | System Alarms | 50 |
| Display Module | 21 | System Advisory/Record Codes | 50 |
| Display | 21 | To Clear Error and Restart | 50 |
| Icon Key | 22 | Air Flow Switch (AFS) Function | 50 |
| Screen Summary | 23 | System Idle Warning (IDLE) | 51 |
| Ranges for User Inputs | 24 | Error Codes | 52 |
| Basic Operation | 29 | Alarm Troubleshooting | 53 |
| Pre-Operation Tasks | 29 | Dynamic Dosing Restrictor Selection Graphs . . | 60 |
| Power On | 29 | Schematics | 66 |
| Initial System Setup | 29 | Dimensions and Mounting | 72 |
| Prime the System | 30 | Technical Data | 73 |
| Pump Calibration | 31 | Graco Standard Warranty | 74 |
| Spraying | 32 | | |
| Purging | 32 | | |
| Pressure Relief Procedure | 35 | | |
| Lock Mode | 35 | | |
| Valve Settings | 35 | | |
| Shutdown | 35 | | |
| Use of Optional USB Module | 36 | | |
| USB Logs | 36 | | |
| Setup | 37 | | |
| Download Procedure | 38 | | |
| Recommended USB Flash Drives | 38 | | |

Models



| | | | |
|--|---|---|--|
|  |  |  | |
| ProMix 2KE systems are not approved for use in hazardous locations unless the base model, all accessories, all kits, and all wiring meet local, state, and national codes. | | | |

| Approved for Hazardous Location Class 1, Div 1, Group D (North America); Class 1, Zones 1 and 2 (Europe) | | | | | | |
|---|--------|-------|-------------------------------|--|----------|--|
| Part No. | Series | Ratio | Pumps | Maximum Working Pressure psi (MPa, bar) | USB Port | Approvals* |
| 24F102 | A | 3:1 | Merkur, A and B | 300 (2.1, 21) | |  II 2 G Ex ia px IIA T3 Ta = 0°C to 54°C FM10 ATEX 0025 X  APPROVED Intrinsically safe and purged equipment for Class I, Division 1, Group D, T3 Ta = 0°C to 54°C  0359 See Special Conditions for Safe Use in Warnings , page 5. |
| 24F103 | A | 23:1 | Merkur, A and B | 2300 (15.8, 158) | | |
| 24F104 | A | 30:1 | Merkur, A and B | 3000 (20.6, 206) | | |
| 24F105 | A | 45:1 | Merkur, A and B | 4500 (31.0, 310) | | |
| 24F106 | A | 3:1 | Merkur A, Merkur Bellows B | 300 (2.1, 21) | | |
| 24F107 | A | 23:1 | Merkur A, Merkur Bellows B | 2300 (15.8, 158) | | |
| 24F108 | A | 35:1 | Merkur A, Merkur Bellows B | 3500 (24.1, 241) | | |
| 24F109 | A | 3:1 | Merkur, A and B | 300 (2.1, 21) | ✓ | |
| 24F110 | A | 23:1 | Merkur, A and B | 2300 (15.8, 158) | ✓ | |
| 24F111 | A | 30:1 | Merkur, A and B | 3000 (20.6, 206) | ✓ | |
| 24F112 | A | 45:1 | Merkur, A and B | 4500 (31.0, 310) | ✓ | |
| 24F113 | A | 3:1 | Merkur A, Merkur Bellows B | 300 (2.1, 21) | ✓ | |
| 24F114 | A | 23:1 | Merkur A, Merkur Bellows B | 2300 (15.8, 158) | ✓ | |
| 24F115 | A | 35:1 | Merkur A, Merkur Bellows B | 3500 (24.1, 241) | ✓ | |

* ProMix 2KE hazardous location equipment manufactured in the United States, with serial number beginning with A or 01, has ATEX, FM, and CE approvals, as noted. Equipment manufactured in Belgium, with serial number beginning with M or 38, has ATEX and CE approvals, as noted.

See page 4 for models approved for non-hazardous locations.

Models (continued)

| Approved for Non-Hazardous Location | | | | | | |
|-------------------------------------|--------|-------|-------------------------------|--|----------|--|
| Part No. | Series | Ratio | Pumps | Maximum Working Pressure psi (MPa, bar) | USB Port | Approvals* |
| 24F088 | A | 3:1 | Merkur, A and B | 300 (2.1, 21) | |   |
| 24F089 | A | 23:1 | Merkur, A and B | 2300 (15.8, 158) | | |
| 24F090 | A | 30:1 | Merkur, A and B | 3000 (20.6, 206) | | |
| 24F091 | A | 45:1 | Merkur, A and B | 4500 (31.0, 310) | | |
| 24F092 | A | 3:1 | Merkur A, Merkur Bellows B | 300 (2.1, 21) | | |
| 24F093 | A | 23:1 | Merkur A, Merkur Bellows B | 2300 (15.8, 158) | | |
| 24F094 | A | 35:1 | Merkur A, Merkur Bellows B | 3500 (24.1, 241) | | |
| 24F095 | A | 3:1 | Merkur, A and B | 300 (2.1, 21) | ✓ | |
| 24F096 | A | 23:1 | Merkur, A and B | 2300 (15.8, 158) | ✓ | |
| 24F097 | A | 30:1 | Merkur, A and B | 3000 (20.6, 206) | ✓ | |
| 24F098 | A | 45:1 | Merkur, A and B | 4500 (31.0, 310) | ✓ | |
| 24F099 | A | 3:1 | Merkur A, Merkur Bellows B | 300 (2.1, 21) | ✓ | |
| 24F100 | A | 23:1 | Merkur A, Merkur Bellows B | 2300 (15.8, 158) | ✓ | |
| 24F101 | A | 35:1 | Merkur A, Merkur Bellows B | 3500 (24.1, 241) | ✓ | |

* ProMix 2KE non-hazardous location equipment manufactured in the United States, with serial number beginning with A or 01, has FM and CE approvals. Equipment manufactured in Belgium, with serial number beginning with M or 38, has CE approval.





Related Manuals

| Manual | Description |
|--------|--|
| 3A0870 | ProMix 2KE, Repair/Parts |
| 312781 | Fluid Mix Manifold, Instructions/Parts |
| 312782 | Dosing Valve, Instructions/Parts |
| 312784 | Gun Flush Box Kit 15V826 |
| 312792 | Merkur Displacement Pump |
| 312793 | Merkur Bellows Displacement Pump |
| 312796 | NXT Air Motor |
| 406714 | Rebuild Kit for High Pressure Dispense Valve |

| Manual | Description |
|--------|---|
| 406823 | Dispense Valve Seat Kit |
| 3A1244 | Graco Control Architecture Module Programming |
| 3A1323 | 16G353 Alternator Conversion Kit |
| 3A1324 | 16G351 Electric Power Conversion Kit |
| 3A1325 | ProMix 2KE Stand Kits |
| 3A1333 | 24H253 USB Module Kit |
| 313542 | Beacon Tower |

Warnings

The following warnings are for the setup, use, grounding, maintenance, and repair of this equipment. The exclamation point symbol alerts you to a general warning and the hazard symbols refer to procedure-specific risks. When these symbols appear in the body of this manual, refer back to these Warnings. Product-specific hazard symbols and warnings not covered in this section may appear throughout the body of this manual where applicable.

|  WARNING | |
|--|---|
|  | <p>FIRE AND EXPLOSION HAZARD</p> <p>Flammable fumes, such as solvent and paint fumes, in work area can ignite or explode. To help prevent fire and explosion:</p> <ul style="list-style-type: none"> • Use equipment only in well ventilated area. • Eliminate all ignition sources; such as pilot lights, cigarettes, portable electric lamps, and plastic drop cloths (potential static arc). • Keep work area free of debris, including solvent, rags and gasoline. • Do not plug or unplug power cords, or turn power or light switches on or off when flammable fumes are present. • Ground all equipment in the work area. See Grounding instructions. • Use only grounded hoses. • Hold gun firmly to side of grounded pail when triggering into pail. • If there is static sparking or you feel a shock, stop operation immediately. Do not use equipment until you identify and correct the problem. • Keep a working fire extinguisher in the work area. |
|  | <p>SPECIAL CONDITIONS FOR SAFE USE</p> <ul style="list-style-type: none"> • To prevent the risk of electrostatic sparking, the equipment's non-metallic parts should be cleaned only with a damp cloth. • The aluminum adapter plate may spark upon impact or contact with moving parts, which may cause fire or explosion. Take precautions to avoid such impact or contact. |
|  | <p>ELECTRIC SHOCK HAZARD</p> <p>This equipment must be grounded. Improper grounding, setup, or usage of the system can cause electric shock.</p> <ul style="list-style-type: none"> • Turn off and disconnect power at main switch before disconnecting any cables and before servicing equipment. • Connect only to grounded power source. • All electrical wiring must be done by a qualified electrician and comply with all local codes and regulations. |



WARNING



INTRINSIC SAFETY

Intrinsically safe equipment that is installed improperly or connected to non-intrinsically safe equipment will create a hazardous condition and can cause fire, explosion, or electric shock. Follow local regulations and the following safety requirements.









- Only models with model numbers 24F102-24F115, utilizing the air-driven alternator, are approved for installation in a Hazardous (explosive atmosphere) Location. See **Models**, page 3.
- Be sure your installation complies with national, state, and local codes for the installation of electrical apparatus in a Class I, Group D, Division 1 (North America) or Class I, Zones 1 and 2 (Europe) Hazardous Location, including all of the local safety fire codes, NFPA 33, NEC 500 and 516, and OSHA 1910.107.
- To help prevent fire and explosion:
 - Do not install equipment approved only for a non-hazardous location in a hazardous location. See model ID label for the intrinsic safety rating of your model.
 - Do not substitute system components as this may impair intrinsic safety.
- Equipment that comes in contact with the intrinsically safe terminals must be rated for Intrinsic Safety. This includes DC voltage meters, ohmmeters, cables, and connections. Remove the unit from the hazardous area when troubleshooting.
- The equipment is intrinsically safe when no external electrical components are connected to it.
- Do not connect, download, or remove USB device unless unit is removed from the hazardous (explosive atmosphere) location.



SKIN INJECTION HAZARD





High-pressure fluid from gun, hose leaks, or ruptured components will pierce skin. This may look like just a cut, but it is a serious injury that can result in amputation. **Get immediate surgical treatment.**

- Do not spray without tip guard and trigger guard installed.
- Engage trigger lock when not spraying.
- Do not point gun at anyone or at any part of the body.
- Do not put your hand over the spray tip.
- Do not stop or deflect leaks with your hand, body, glove, or rag.
- Follow the **Pressure Relief Procedure** when you stop spraying and before cleaning, checking, or servicing equipment.
- Tighten all fluid connections before operating the equipment.
- Check hoses and couplings daily. Replace worn or damaged parts immediately.

|  <h1 style="margin: 0;">WARNING</h1> | |
|--|--|
|   | <p>EQUIPMENT MISUSE HAZARD Misuse can cause death or serious injury.</p> <ul style="list-style-type: none"> • Do not operate the unit when fatigued or under the influence of drugs or alcohol. • Do not exceed the maximum working pressure or temperature rating of the lowest rated system component. See Technical Data in all equipment manuals. • Use fluids and solvents that are compatible with equipment wetted parts. See Technical Data in all equipment manuals. Read fluid and solvent manufacturer’s warnings. For complete information about your material, request MSDS from distributor or retailer. • Do not leave the work area while equipment is energized or under pressure. Turn off all equipment and follow the Pressure Relief Procedure when equipment is not in use. • Check equipment daily. Repair or replace worn or damaged parts immediately with genuine manufacturer’s replacement parts only. • Do not alter or modify equipment. • Use equipment only for its intended purpose. Call your distributor for information. • Route hoses and cables away from traffic areas, sharp edges, moving parts, and hot surfaces. • Do not kink or over bend hoses or use hoses to pull equipment. • Keep children and animals away from work area. • Comply with all applicable safety regulations. |
|   | <p>MOVING PARTS HAZARD Moving parts can pinch, cut or amputate fingers and other body parts.</p> <ul style="list-style-type: none"> • Keep clear of moving parts. • Do not operate equipment with protective guards or covers removed. • Pressurized equipment can start without warning. Before checking, moving, or servicing equipment, follow the Pressure Relief Procedure and disconnect all power sources. |
|   | <p>TOXIC FLUID OR FUMES HAZARD Toxic fluids or fumes can cause serious injury or death if splashed in the eyes or on skin, inhaled, or swallowed.</p> <ul style="list-style-type: none"> • Read MSDSs to know the specific hazards of the fluids you are using. • Store hazardous fluid in approved containers, and dispose of it according to applicable guidelines. • Always wear chemically impermeable gloves when spraying, dispensing, or cleaning equipment. |
|  | <p>PERSONAL PROTECTIVE EQUIPMENT You must wear appropriate protective equipment when operating, servicing, or when in the operating area of the equipment to help protect you from serious injury, including eye injury, hearing loss, inhalation of toxic fumes, and burns. This equipment includes but is not limited to:</p> <ul style="list-style-type: none"> • Protective eyewear, and hearing protection. • Respirators, protective clothing, and gloves as recommended by the fluid and solvent manufacturer. |

Important Two-Component Material Information

Isocyanate Conditions

| | | | | | | |
|--|---|---|---|---|--|--|
|  |  |  |  |  | | |
|--|---|---|---|---|--|--|



Spraying or dispensing materials containing isocyanates creates potentially harmful mists, vapors, and atomized particulates.

Read material manufacturer's warnings and material MSDS to know specific hazards and precautions related to isocyanates.

Prevent inhalation of isocyanate mists, vapors, and atomized particulates by providing sufficient ventilation in the work area. If sufficient ventilation is not available, a supplied-air respirator is required for everyone in the work area.



To prevent contact with isocyanates, appropriate personal protective equipment, including chemically impermeable gloves, boots, aprons, and goggles, is also required for everyone in the work area.

Material Self-ignition

| | | | | | | |
|--|---|--|--|--|--|--|
|  |  | | | | | |
|--|---|--|--|--|--|--|

Some materials may become self-igniting if applied too thickly. Read material manufacturer's warnings and material MSDS.

Keep Components A and B Separate

| | | | | | | |
|--|---|---|--|--|--|--|
|  |  |  | | | | |
|--|---|---|--|--|--|--|

Cross-contamination can result in cured material in fluid lines which could cause serious injury or damage equipment. To prevent cross-contamination of the equipment's wetted parts, **never** interchange component A (resin) and component B (isocyanate) parts.

Moisture Sensitivity of Isocyanates

Isocyanates (ISO) are catalysts used in two component coatings. ISO will react with moisture (such as humidity) to form small, hard, abrasive crystals, which become suspended in the fluid. Eventually a film will form on the surface and the ISO will begin to gel, increasing in viscosity. If used, this partially cured ISO will reduce performance and the life of all wetted parts.

NOTE: The amount of film formation and rate of crystallization varies depending on the blend of ISO, the humidity, and the temperature.

To prevent exposing ISO to moisture:

- Always use a sealed container with a desiccant dryer in the vent, or a nitrogen atmosphere. **Never** store ISO in an open container.
- Use moisture-proof hoses specifically designed for ISO, such as those supplied with your system.
- Never use reclaimed solvents, which may contain moisture. Always keep solvent containers closed when not in use.
- Never use solvent on one side if it has been contaminated from the other side.
- Always lubricate threaded parts with ISO pump oil or grease when reassembling.

Changing Materials

- When changing materials, flush the equipment multiple times to ensure it is thoroughly clean.
- Always clean the fluid inlet strainers after flushing.
- Check with your material manufacturer for chemical compatibility.

Glossary of Terms

Dose Size - the amount of resin (A) and catalyst (B) that is dispensed into an integrator.

Dose Time Alarm - the amount of time that is allowed for a dose to occur before an alarm occurs.

Dynamic Dosing - Component A dispenses constantly. Component B dispenses intermittently in the necessary volume to attain the mix ratio.

Grand Total - a non-resettable value that shows the total amount of material dispensed through the system.

Intrinsically Safe (IS) - refers to the ability to locate certain components in a hazardous location.

Idle - if the gun is not triggered for 2 minutes the system enters Idle mode. Trigger the gun to resume operation.

Batch Total - a resettable value that shows the amount of material dispensed through the system for one batch. A batch is complete when the user resets the batch counter to zero.

Mix - when cross-linking of the resin (A) and catalyst (B) occurs.

Overdose Alarm - when either the resin (A) or catalyst (B) component dispenses too much material and the system cannot compensate for the additional material.

Potlife Time - the amount of time before a material becomes unsprayable.

Potlife Volume - the amount of material that is required to move through the mix manifold, hose, and applicator before the potlife timer is reset.

Pump Calibration Factor - the amount of material dispensed per inch of pump travel.

Purge - when all mixed material is flushed from the system.

Purge Time - the amount of time required to flush all mixed material from the system.

Ratio Tolerance - the settable percent of acceptable variance that the system will allow before a ratio alarm occurs.

Standby - refers to the status of the system.

Overview

Usage

The ProMix 2KE is an electronic two-component paint proportioner. It can blend most two-component paints. It is not for use with quick-setting paints (those with a pot life of less than 5 minutes).

- Has dynamic dosing capabilities. It dispenses material A, monitors fluid flow, and dispenses material B in doses to cause the mixture to stay on ratio.
- Can proportion at ratios from 0.1:1 to 30.0:1.
- Will display the last 50 errors with date, time, and event. The optional USB upgrade kit will log 500 errors and up to 2000 jobs.
- For systems with one gun, an optional Gun Flush Box provides an automated flushing system for a manual spray gun.

Component Identification and Definition



| Component | Description |
|----------------|---|
| Control Box | <ul style="list-style-type: none"> • Advanced Fluid Control Module • Power supply or alternator • Solenoid valves • Air flow switch(es) • Optional USB Module • Audible alarm • Optional pressure switch for gun flush box |
| Fluid Module | <ul style="list-style-type: none"> • Mix manifold, which includes the fluid integrator and static mixer. • Color/catalyst valve stacks, includes pneumatically operated dose valves for material A and B, as well as solvent valves. • Pumps |
| Display Module | Used to set up, display, operate, and monitor the system. Used for daily painting functions including choosing recipes, reading/clearing errors, and placing the system in Spray, Standby, or Purge mode. |

Installation

General Information

- Reference numbers and letters in parentheses in the text refer to numbers and letters in the illustrations.
- Be sure all accessories are adequately sized and pressure-rated to meet system requirements.
- To protect the Display Module screens from paints and solvents, clear-plastic protective shields are available in packs of 10 (Part No. 24G821). Clean the screens with a dry cloth if necessary.

Intrinsically Safe Installation Requirements

| | | | | | | |
|---|---|--|--|--|--|--|
|  |  | | | | | |
| <p>Do not substitute or modify system components as this may impair intrinsic safety. For installation, maintenance, or operation instructions, read instruction manuals. Do not install equipment approved only for non-hazardous location in a hazardous location. See the identification label for the intrinsic safety rating for your model.</p> | | | | | | |

1. The installation must meet the requirements of the National Electric Code, NFPA 70, Article 504 Resp., Article 505, and ANSI/ISA 12.06.01.
2. Multiple earthing of components is allowed only if high integrity equipotential system realized between the points of bonding.
3. For ATEX, install per EN 60079-14 and applicable local and national codes.

Hazardous (Classified) Locations Class 1, Div 1, Group D, T3 (US and Canada) Class 1, Zone 1, Group IIA, T3 (ATEX only)

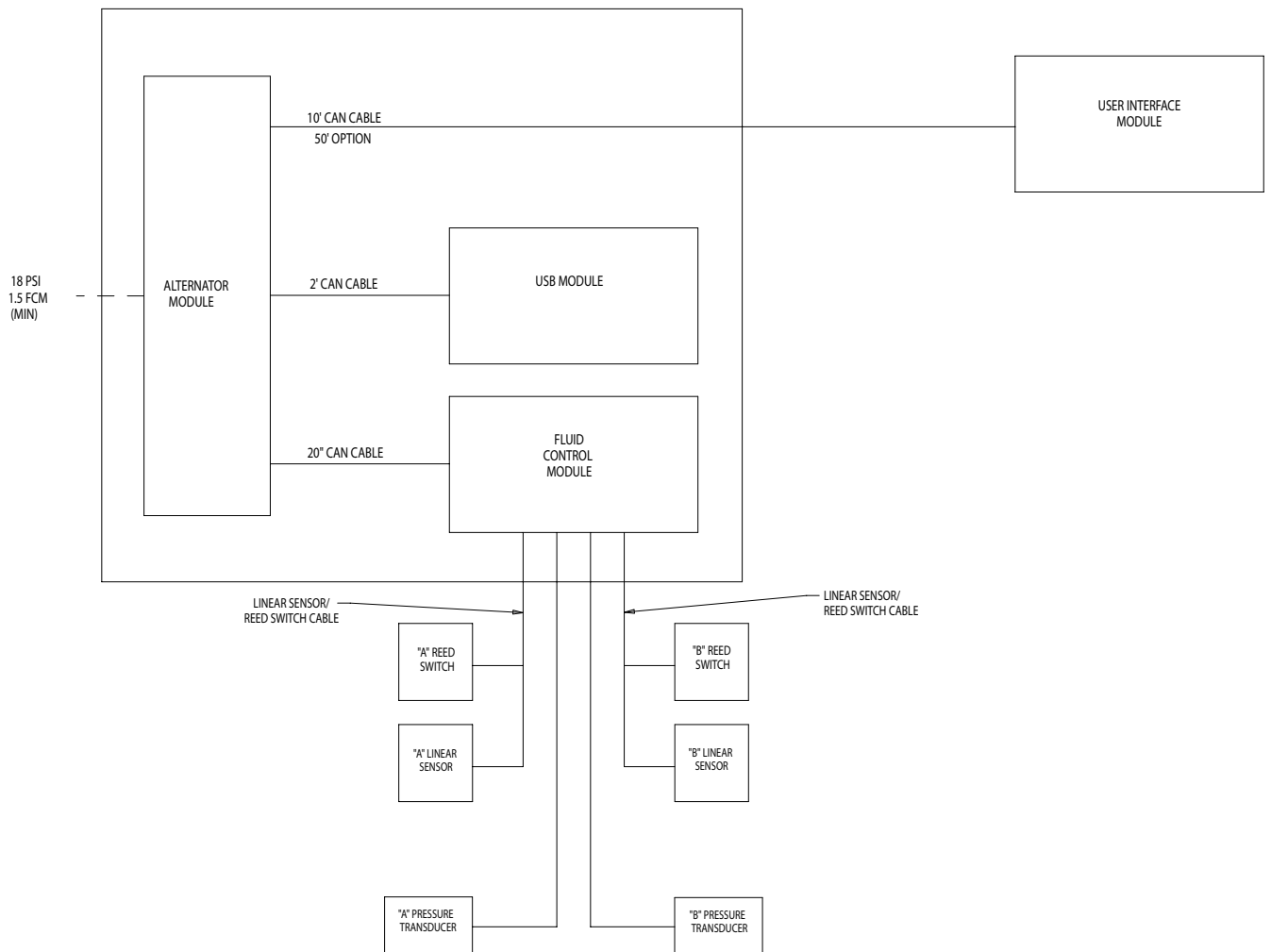

FIG. 1. Hazardous Location Installation

Non-Hazardous Locations

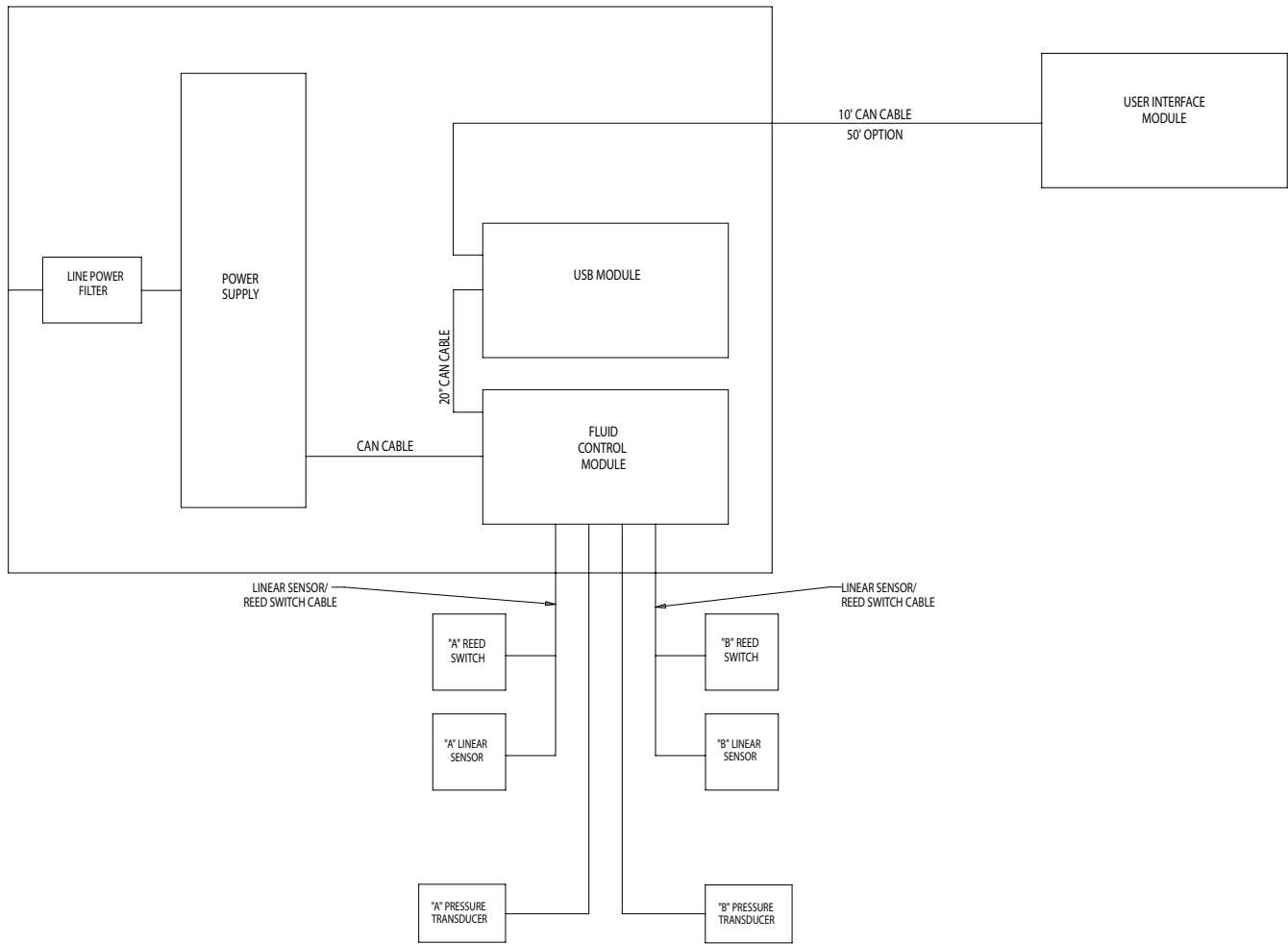
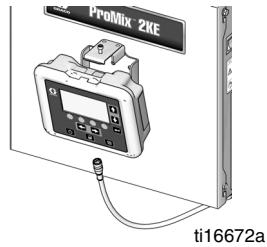

FIG. 2. Non-Hazardous Location Installation

Display Module

1. Use the screws provided to mount the bracket for the Display Module on the front of the Control Box or on the wall, as you prefer.
2. Snap the Display Module into the bracket.



3. Connect one end of the CAN cable (provided) to J6 on the Display Module (either port).

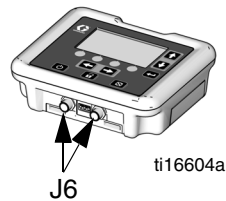

4. The other end of the cable comes from the factory connected as shown, depending on the configuration of your system:

- **Wall Power Systems with USB Module:**

Connect the CAN cable to P3 on the USB Module.

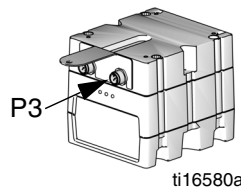

- **Wall Power Systems without USB Module:**

Connect CAN cable to J8 on the Advanced Fluid Control Module.

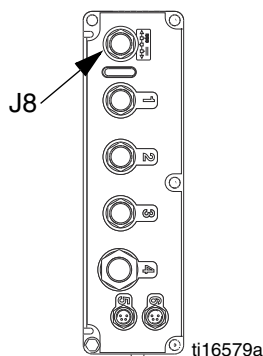

- **Alternator Power Systems (with or without USB Module):** Connect CAN cable to J3 on the alternator.

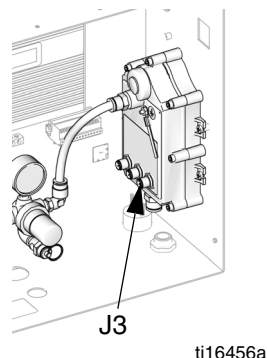

Air Supply

Requirements

- **Compressed air supply pressure:** 75-100 psi (517-700 kPa, 5.2-7 bar).
- **Air hoses:** use grounded hoses that are correctly sized for your system.

| | | | | | | |
|--|--|--|--|--|--|--|
| | | | | | | |
| <p>Trapped air can cause a pump or dispense valve to cycle unexpectedly, which could result in serious injury from splashing or moving parts. Use bleed-type shutoff valves.</p> | | | | | | |

- **Air regulator and bleed-type shutoff valve:** include in each air line to fluid supply equipment. Install an additional shutoff valve upstream of all air line accessories to isolate them for servicing.

| | | | | | |
|---|--|--|--|--|--|
| | | | | | |
| <p>If using a Graco electrostatic PRO™ Gun, a shutoff valve must be installed in the gun air line to shutoff the atomizing and turbine air to the gun. Contact your Graco distributor for information on air shutoff valves for electrostatic applications.</p> | | | | | |

- **Air line filter:** a 10 micron or better air filter is recommended to filter oil and water out of the air supply and help avoid paint contamination and clogged solenoids.

Air Connections

See the **System Pneumatic Schematic** on page 66 (hazardous location) or page 67 (non-hazardous location).

1. Tighten all ProMix 2KE system air and fluid line connections as they may have loosened during shipment.
2. Connect the main air supply line to the main air inlet. This air line supplies the solenoids, valves, and pumps. See FIG. 3.

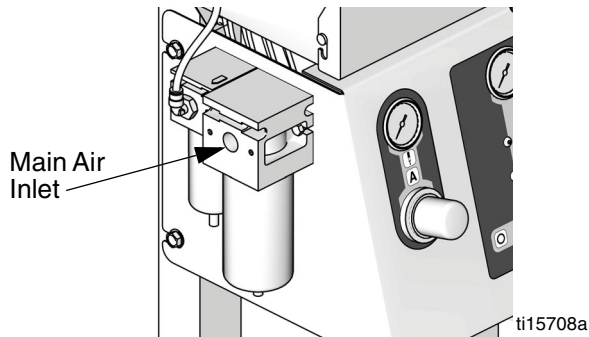

FIG. 3. Air Supply Inlet

3. For each gun in the system, connect a separate clean air supply line to the air inlet of the air flow switch. This air supplies gun atomizing air. The air flow switch detects air flow to the gun and signals the controller when the gun is being triggered.

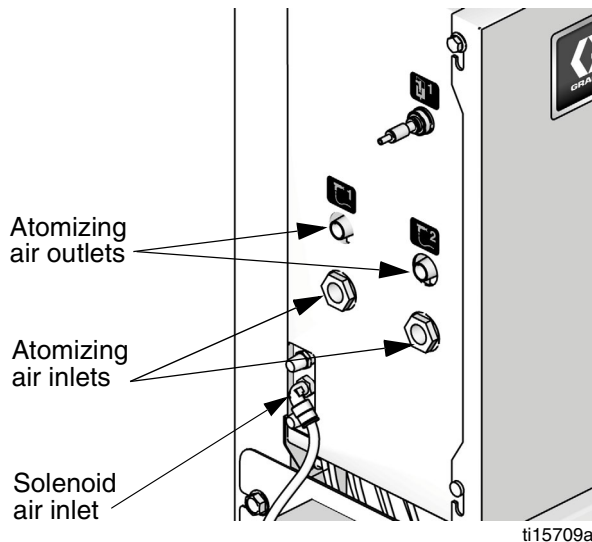

FIG. 4. Connect atomizing air

Fluid Supply

Requirements

| | | | | | | |
|---|--|--|--|--|--|--|
| | | | | | | |
| <ul style="list-style-type: none"> • Do not exceed the pressure rating of the lowest rated component. See the identification label. • To reduce the risk of injury, including fluid injection, you must install a shutoff valve between each fluid supply line and the mix manifold. Use the valves to shut off fluid during maintenance and service. | | | | | | |

ProMix 2KE models are available to operate airless (high pressure, 50 cc pumps only), air spray, or air-assisted systems with a capacity of up to 3800 cc/min.

- Fluid supply pressure tanks, feed pumps, or circulating systems can be used.
- Materials can be transferred from their original containers or from a central paint recirculating line.

NOTE: The fluid supply must be free of pressure spikes, which are commonly caused by pump stroke change-over. If necessary, install pressure regulators or a surge tank on the ProMix 2KE fluid inlets to reduce pulsation. Contact your Graco distributor for additional information.

Fluid Connections

1. See FIG. 5, page 15. Connect the solvent supply line to the 1/4 npt(f) solvent valve inlets (SVA and SVB).
2. Connect the component A supply line(s) to the component A dose valve inlet (DVA).

NOTE: Paint Recirculating System Only

- If you are recirculating paint, use the standard inlet on Dose Valve A or Dose Valve B. Remove the plug directly opposite it on the dose valve for the recirculation outlet. See FIG. 5.
3. Connect the component B line to the component B dose valve inlet (DVB).
 4. Connect the gun fluid supply line between the mix manifold (MM) outlet and the gun fluid inlet.

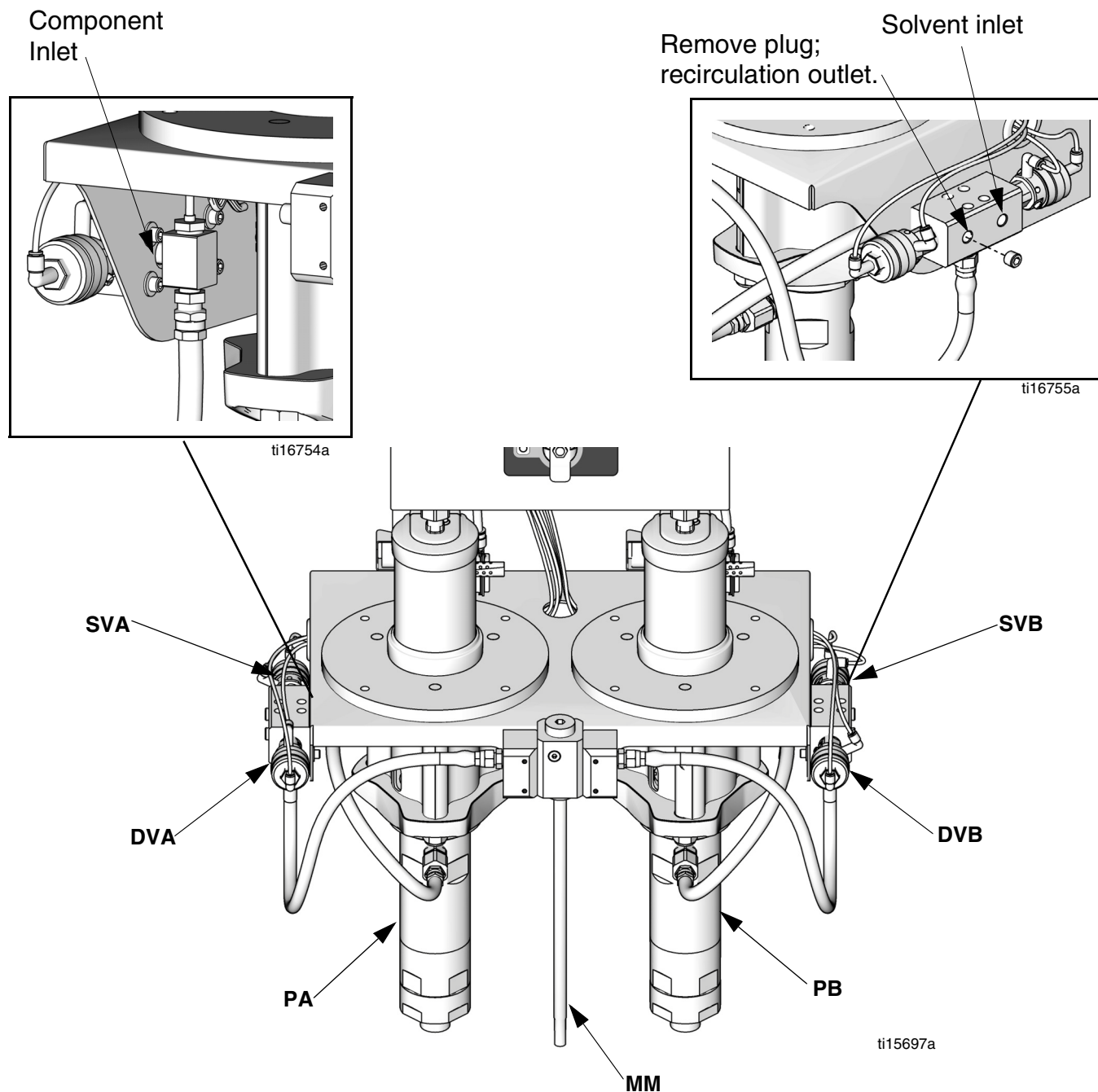

Key:

PA Component A Pump
 DVA Component A Dose Valve
 SVA Solvent Valve A

PB Component B Pump
 DVB Component B Dose Valve
 SVB Solvent Valve B
 MM Mix Manifold

FIG. 5. Fluid Connections

Tubing Chart and Diagrams

| Type | Color | Description | Starting Point | Ending Point | Tube OD in. (mm) |
|-------|---------|-------------------------------|----------------|--------------|------------------|
| Air | Green | Solvent Valve A On | 1G | 1G | 0.156 (4.0) |
| Air | Green | Dose Valve A On | 2G | 2G | 0.156 (4.0) |
| Air | Green | Solvent Valve B On | 3G | 3G | 0.156 (4.0) |
| Air | Green | Dose Valve B On | 4G | 4G | 0.156 (4.0) |
| Air | Red | Solvent Valve A Off | 1R | 1R | 0.156 (4.0) |
| Air | Red | Dose Valve A Off | 2R | 2R | 0.156 (4.0) |
| Air | Red | Solvent Valve B Off | 3R | 3R | 0.156 (4.0) |
| Air | Red | Dose Valve B Off | 4R | 4R | 0.156 (4.0) |
| Air | Natural | Solenoid Air | A1 | A1 | 0.25 (6.3) |
| Air | Natural | Air Regulator to Pump B | A2 | A2 | 0.375 (9.5) |
| Air | Natural | Air Regulator to Pump A | A3 | A3 | 0.375 (9.5) |
| Fluid | ---- | Pump B to Valve Stack B | A4 | A4 | ---- |
| Fluid | ---- | Pump A to Valve Stack A | A5 | A5 | ---- |
| Fluid | ---- | Valve Stack A to Mix Manifold | A6 | A6 | ---- |
| Fluid | ---- | Valve Stack B to Mix Manifold | A7 | A7 | ---- |
| Air | Natural | Air Regulator to Alternator* | A8 | A8 | 0.375 (9.5) |
| Air | Black | Alternator Air Exhaust* | A9 | A9 | 0.5 (12.7) |

* Used only on IS models.

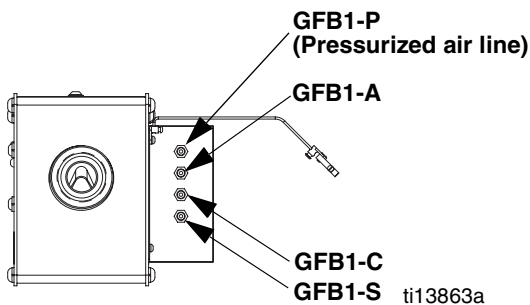
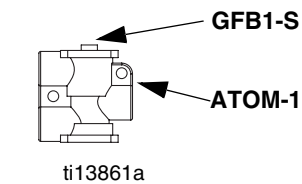
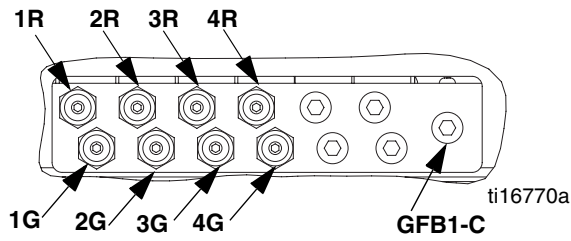

* IS Models

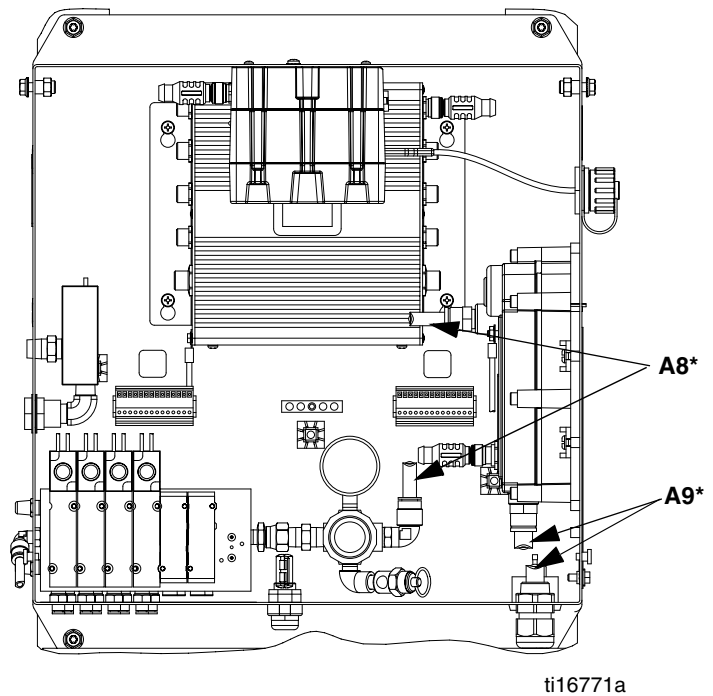

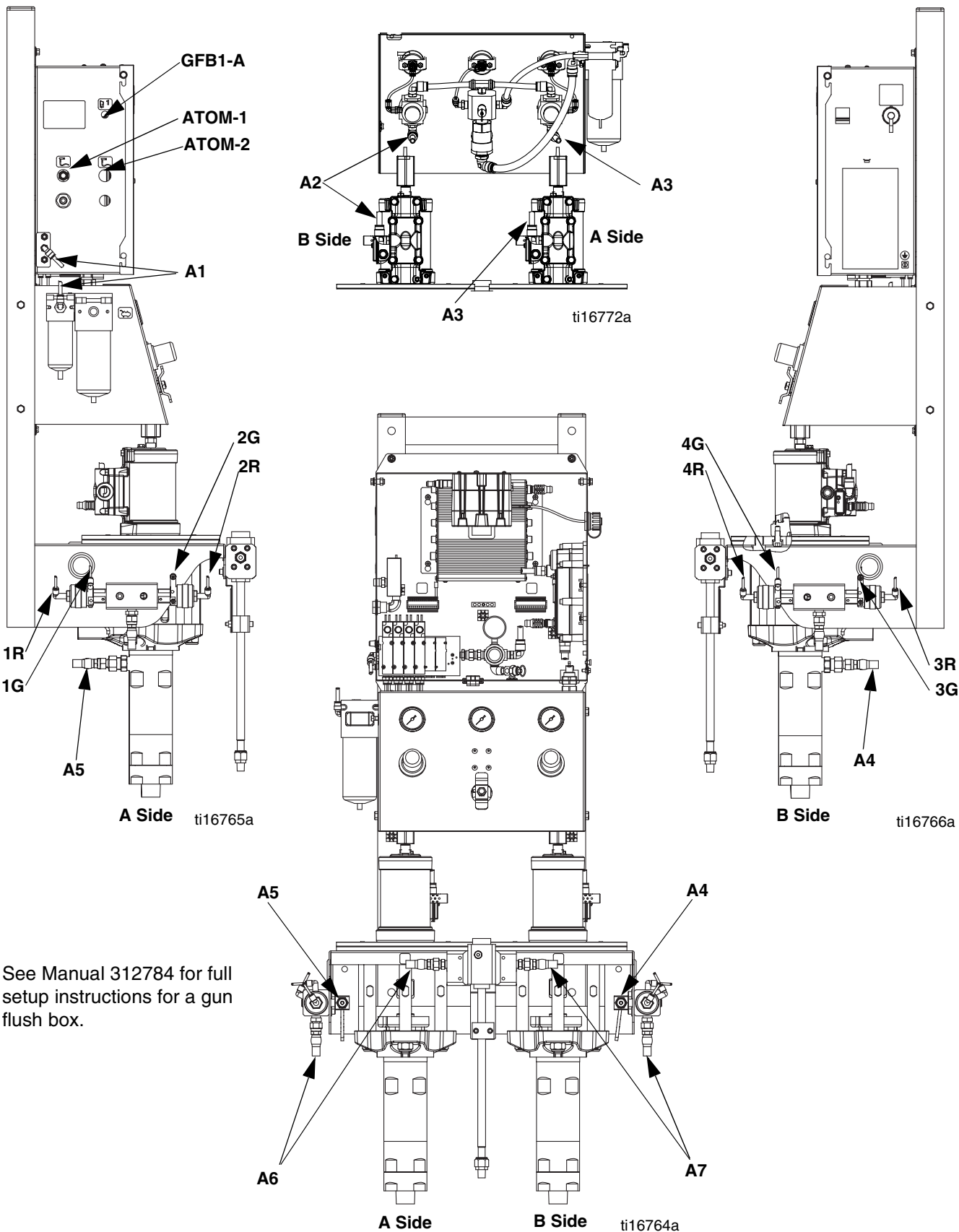

See Manual 312784 for full setup instructions for a gun flush box.

Electrical

Power Connection (non-IS units only)

| | | | | | | |
|---|---|---|--|--|--|--|
|  |  |  | | | | |
| All electrical wiring must be completed by a qualified electrician and comply with all local codes and regulations. | | | | | | |

Enclose all cables routed in the spray booth and high traffic areas in conduit to prevent damage from paint, solvent, and traffic.

The ProMix 2KE operates with 85-250 VAC, 50/60 Hz input power, with a maximum of 2 amp current draw. The power supply circuit must be protected with a 15 amp maximum circuit breaker.

Not included with system:

- Power supply cord compatible to your local power configuration. Wire gauge size must be 8-14 AWG.
 - The input power access port is 22.4 mm (0.88 in.) in diameter. It accepts a bulkhead strain relief fitting or conduit.
1. Verify that electrical power at the main panel is shut off. Open Control Box cover.
 2. Connect electrical cord to the terminal block as shown in FIG. 6.
 3. Close the Control Box. Restore power.
 4. Follow instructions in **Grounding**, page 19.

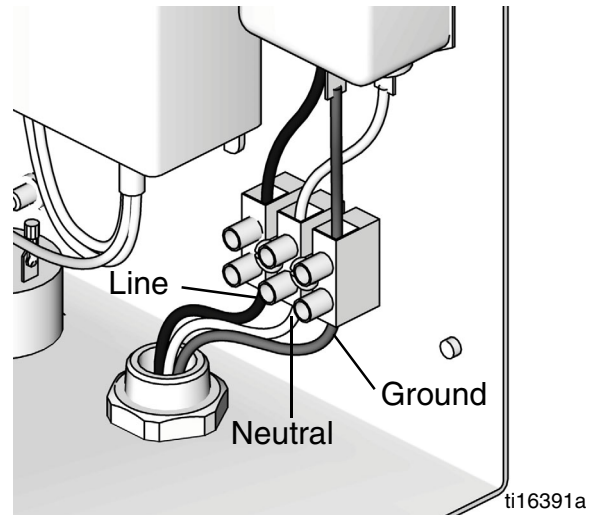

FIG. 6. Control Box Electrical Connection

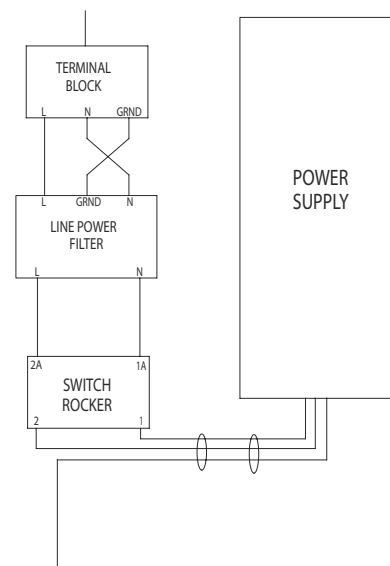





FIG. 7. Electrical Schematic

Grounding

| | | | | | | |
|--|---|---|---|--|--|--|
|  |  |  |  | | | |
| <p>The equipment must be grounded. Grounding reduces the risk of static and electric shock by providing an escape wire for the electrical current due to static build up or in the event of a short circuit.</p> | | | | | | |

Connect the ProMix 2KE ground wire to the ground screw. Connect the clamp to a true earth ground. If wall power is used to power controls, ground electrical connection according to local codes.

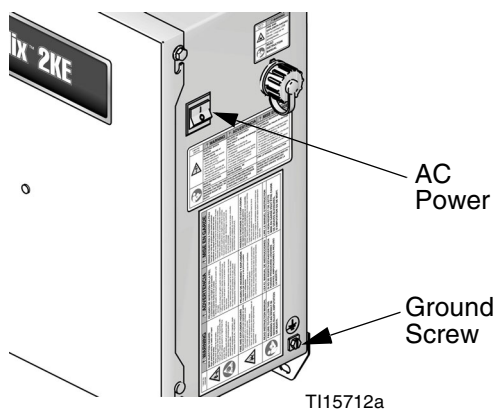

FIG. 8. Ground Screw and Power Switch

Gun Flush Box

Connect a ground wire from the Gun Flush Box ground lug to a true earth ground.

Feed Pumps or Pressure Pots

Connect a ground wire and clamp from a true earth ground to the pumps or pots. See pump or pressure pot manual.

Air and Fluid Hoses

Use grounded hoses only.

Spray Gun

Follow the grounding instructions in your gun manual.

- **Non-Electrostatic:** Ground the spray gun through connection to a Graco-approved grounded fluid supply hose.
- **Electrostatic:** Ground the spray gun through connection to a Graco-approved grounded air supply hose. Connect the air hose ground wire to a true earth ground.

Fluid Supply Container

Follow local code.





Object Being Sprayed

Follow local code.

All Solvent Pails Used When Purging

Follow local code. Use only conductive metal pails/containers placed on a grounded surface. Do not place the pail/container on a nonconductive surface, such as paper or cardboard, which interrupts the grounding continuity.

Check Resistance

| | | | | | | |
|--|--|---|---|--|--|--|
|  |  |  |  | | | |
| <p>To ensure proper grounding, resistance between components and true earth ground must be less than 1 ohm.</p> | | | | | | |

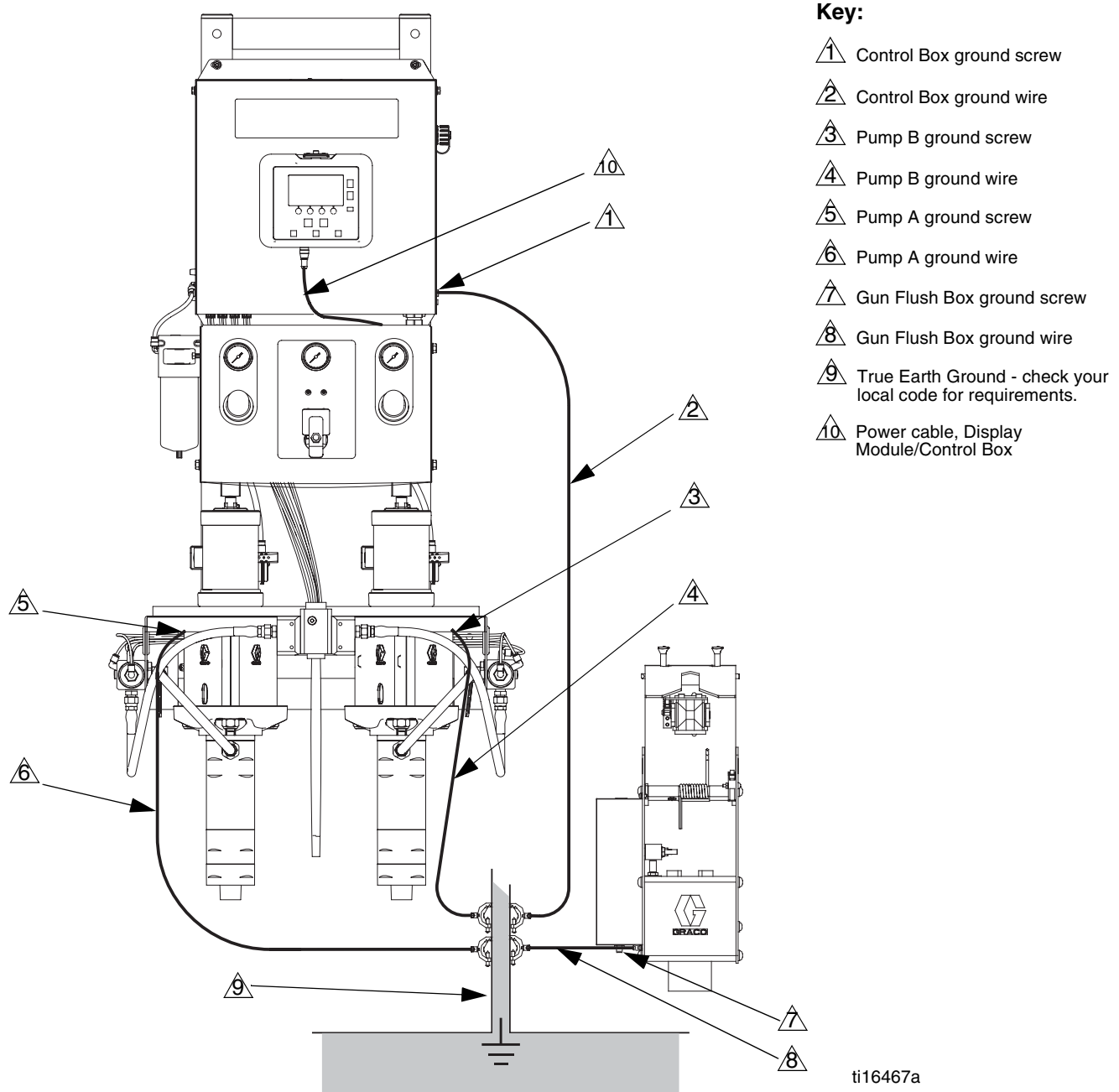

FIG. 9. Grounding

Display Module

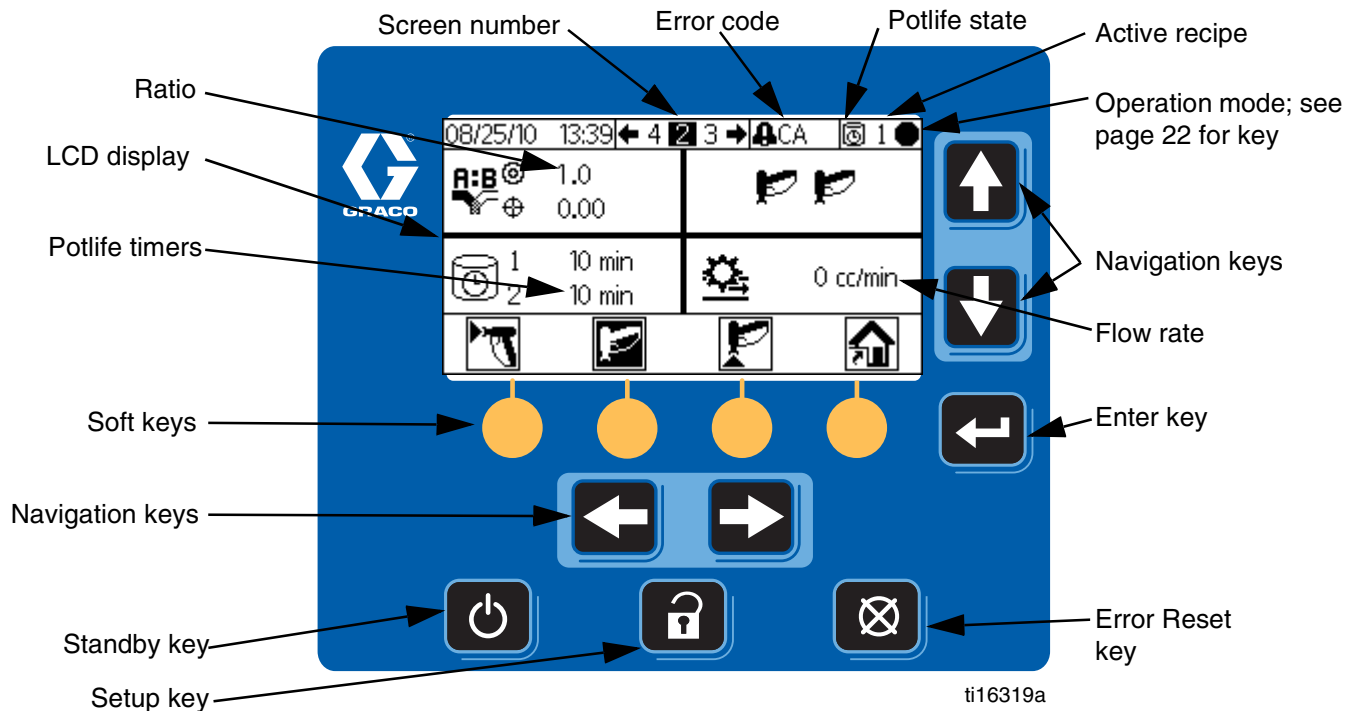

FIG. 10. Display Module

Display

Shows graphical and text information related to setup and spray operations. The screen backlight is factory set to remain on. The user may set a number of minutes the screen can be inactive before the backlight dims. See **Configure 3 (Screen 20)**, page 44. Press any key to restore.

NOTE: The Display Module and bracket can be removed from the cover of the electrical box and mounted remotely, if preferred.

Keys are used to input numerical data, enter setup screens, navigate within a screen, scroll through screens, and select setup values.

NOTICE

To prevent damage to the soft key buttons, do not press the buttons with sharp objects such as pens, plastic cards, or fingernails.





















| Key | Function |
|-----|--|
| | <i>Setup:</i> Press to enter or exit Setup mode. |
| | <i>Enter:</i> Press to choose a field to update, to make a selection, or to save a selection or value. |
| | <i>Left/Right Arrows:</i> Use to move from screen to screen. |

| | |
|--|---|
| | <i>Up/Down Arrows:</i> Use to move among fields on a screen, items on a dropdown menu, or digits in a settable field. |
| | <i>Error Reset:</i> Use to clear alarm so cause can be fixed. Also use to cancel a data entry field. |
| | <i>Standby:</i> Stops the current operation and puts the system into standby. |
| | <i>Soft keys:</i> Press to select the specific screen or operation shown on the display directly above each key. |

Icon Key

The following tables present a printable version of the information on the ProMix 2KE icon card. See Table 3, page 52, for a printable version of the error code information on the reverse side of the card.











General Icons

| Icon | Description |
|---|--------------------|
|  | Pump |
|  | Meter |
|  | Dose Valve |
|  | Solvent Valve |
|  | Air Filter |
|  | Fluid Filter |
|  | Gun Flush Box |
|  | Park Pumps |
|  | Flush Time |
|  | Hose Length |
|  | Hose Diameter |
|  | Ratio |
|  | Potlife |
|  | Length |
|  | Volume |
|  | Pressure |
|  | Air Flow Switch |
|  | Flow Rate High/Low |
|  | Job Number |
|  | User Number |









Spray Gun States

| Icon | Description |
|---|--------------------|
|  | Mix |
|  | Mix Spray |
|  | In Flush Box |
|  | Purge |
|  | Purge in Flush Box |
|  | Standby |
|  | Idle |
|  | Locked |







Operation Modes

| Icon | Description |
|---|--------------|
|  | Standby |
|  | Mix |
|  | Purge |
|  | Color Change |
|  | Dispense A |
|  | Dispense B |
|  | Batch |
|  | Calibrate |
|  | Forced |
|  | Park |
|  | Locked |

Screen Shortcuts

| Icon | Description |
|---|----------------------|
|  | Home |
|  | Spray |
|  | Alarm Log |
|  | Run Pumps |
|  | System Configuration |
|  | Recipes |
|  | Maintenance |
|  | Calibrate |

Softkeys

| Icon | Description |
|---|---------------|
|  | Mix/Spray |
|  | Standby |
|  | Purge |
|  | Reset Counter |
|  | Start |
|  | Stop/Standby |

Screen Summary

NOTE: This summary is a one-page guide to the ProMix 2KE screens, followed by screen maps. For operating instructions, see **Basic Operation**, page 29. For further detail on individual screens, see **Run Mode Details**, page 39, or **Setup Mode Details**, page 42.

Run Mode

The run mode has three screen sections that control the mixing operations.

Mix (Screens 2-4, 38)

- Spray (Screen 2) controls most mixing operations.
- Batch (Screen 3) controls dispense of a set volume.
- Totals (Screen 4) displays grand and batch totals for materials A and B.
- Job Number (Screen 38) displays job number and user number

Error Log (Screens 5-14)

- 10 screens, 5 errors per page.
- Displays date, time, and error.

Pump Control (Screen 15)

- Manually start or stop a pump.
- Park pumps for brief shutdowns.

Setup Mode

The setup mode has four screen sections that allow an authorized user to choose the exact settings needed for the system:

Configure (Screens 18-21)

- Configure 1 (Screen 18) controls system type (pump or meter), gun flush box enable, and number of guns (1 or 2).
- Configure 2 (Screen 19) controls hose length and diameter for one or two guns, flow rate region setting, and air flow switch enable or disable.
- Configure 3 (Screen 20) controls language (for optional USB Module), date format, date, time, password setting, and backlight timer.
- Configure 4 (Screen 21) controls units for distance, volume and pressure.

Recipe (Screens 28 and 29)

- Recipe 1-1 (Screen 28) and 1-2 (Screen 29) control Material 1/Color 1 parameters and flush.

Maintenance (Screens 24-26)

- Maintenance 1 (Screen 24) controls maintenance timer actual and target for Pump A, Pump B, Solvent Valve A, and Solvent Valve B.
- Maintenance 2 (Screen 25) controls dose valves A and B maintenance timers, actual and target.
- Maintenance 3 (Screen 26) controls fluid and air filter maintenance timers, actual and target.

Calibration (Screens 22 and 23)

- Calibration 1 (Screen 22) controls pump factors for Pump A and Pump B.
- Calibration 2 (Screen 23) allows the user to perform a calibration.

Troubleshooting

The troubleshooting mode has three screen sections that allow an authorized user to troubleshoot system operation. See FIG. 14, page 28.

System Inputs (Screen 35)

Membrane Test (Screen 36)

System Outputs and Manual Activation (Screen 37)

Ranges for User Inputs

This table is a one-sheet reference of the data range/options accepted for each user input and the default setting. See the page indicated in the table for further screen information, if needed.

| Page | Screen | User Input | Range/Options | Default |
|------|---------------------|---|--|---|
| 39 | Run Mix Batch (3) | Target Volume | 1 to 9999 cc | 0 cc |
| 40 | Run Job Number (38) | User Number | 000000000 to 999999999 | 000000000 |
| 42 | Password (16) | Password | 0000 to 9999 | 0000 (disabled) |
| 43 | Configure 1 (18) | System Type | Meters; 50cc Pump; 75cc Pump; 100cc Pump; 125cc Pump; 150cc Pump | Meters |
| 43 | Configure 1 (18) | Gun Flush Box Enable | On or Off | Off |
| 43 | Configure 1 (18) | Number of Guns | 1 or 2 guns | 1 gun |
| 43 | Configure 2 (19) | Gun 1 or Gun 2 hose length | 0.1 to 45.7 m / 0.3 to 150 ft | 1.53 m / 5.01 ft |
| 43 | Configure 2 (19) | Gun 1 or Gun 2 hose diameter | 0.1 to 1 inch | 0.25 inches |
| 43 | Configure 2 (19) | Flow Rate Region | High (250 cc/min or higher) or Low (<250 cc/min) | High |
| 43 | Configure 2 (19) | Air Flow Switch | On or Off | On |
| 44 | Configure 3 (20) | USB Log Language | Chinese; Dutch; English; French; German; Italian; Japanese; Korean; Portuguese; Russian; Spanish; Swedish; | English |
| 44 | Configure 3 (20) | Date Format | mm/dd/yy; dd/mm/yy; yy/mm/dd | mm/dd/yy |
| 44 | Configure 3 (20) | Date | 01/01/00 to 12/31/99 | Set at factory |
| 44 | Configure 3 (20) | Time | 00:00 to 23:59 | Set at factory |
| 44 | Configure 3 (20) | Password | 0000 to 9999 | 0000 (disabled) |
| 44 | Configure 3 (20) | Backlight Timer | 0 to 99 minutes | 0 minutes |
| 44 | Configure 4 (21) | Distance Units | Feet/inches or Meters/cm | Feet/inches |
| 44 | Configure 4 (21) | Volume Units | Liters; Gallons US; Gallons Imperial | Gallons US |
| 44 | Configure 4 (21) | Pressure Units | psi; Bar; MPA | psi |
| 44 | Recipe 1-1 (28) | Ratio | 0:1 to 30:1 Note: Enter 0 to dispense A only. | 1:1 |
| 44 | Recipe 1-1 (28) | Ratio Tolerance | 1 to 99 percent* | 5 percent |
| 44 | Recipe 1-1 (28) | Potlife Timer | 0 to 240 minutes Note: If set to 0, potlife alarm is disabled. | 60 minutes |
| 44 | Recipe 1-2 (29) | Flush Times- First (A purge), Second (B purge), or Third (using A or B, chosen by user) | 0 to 240 seconds Note: If set to 0, the valve(s) will not flush. | 60 seconds |
| 45 | Maintenance 1 (24) | Pump A or Pump B | 0 to 9,999,999 | 0 |
| 45 | Maintenance 1 (24) | Solvent Valve A or Solvent Valve B | 0 to 9,999,999 | 0 |
| 45 | Maintenance 2 (25) | Dose Valve A or Dose Valve B | 0 to 9,999,999 | 0 |
| 45 | Maintenance 3 (26) | Fluid Filter A or B, or Air Filter | 0 to 9999 days | 0 days |
| 46 | Calibration 1 (22) | Pump A or Pump B Factor | 5 to 50 cc/in | 50cc: 10 cc/in. 75cc: 15 cc/in. 100 cc: 20 cc/in. 125cc: 25 cc/in. 150cc: 30 cc/in. |
| 46 | Calibration 2 (23) | Actual Dispensed Volume | 1 to 9999 cc | 0 cc |

* The system will attempt to hold whatever accuracy is entered. For some ratios and applications, testing shows that actual system accuracy may be $\pm 2\%$ or $\pm 5\%$. See **Technical Data**, page 73.

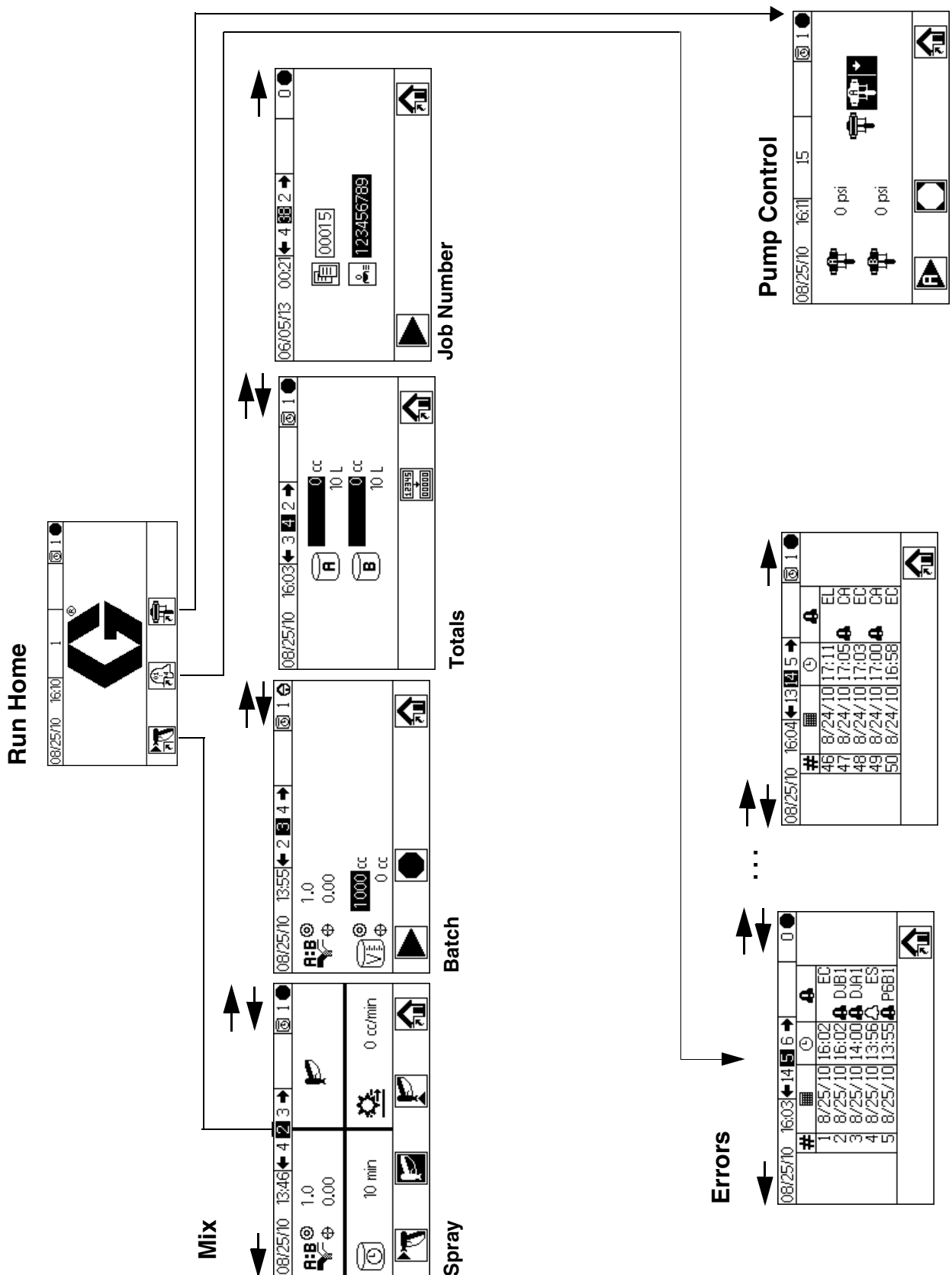

FIG. 11. Run Mode Screen Map

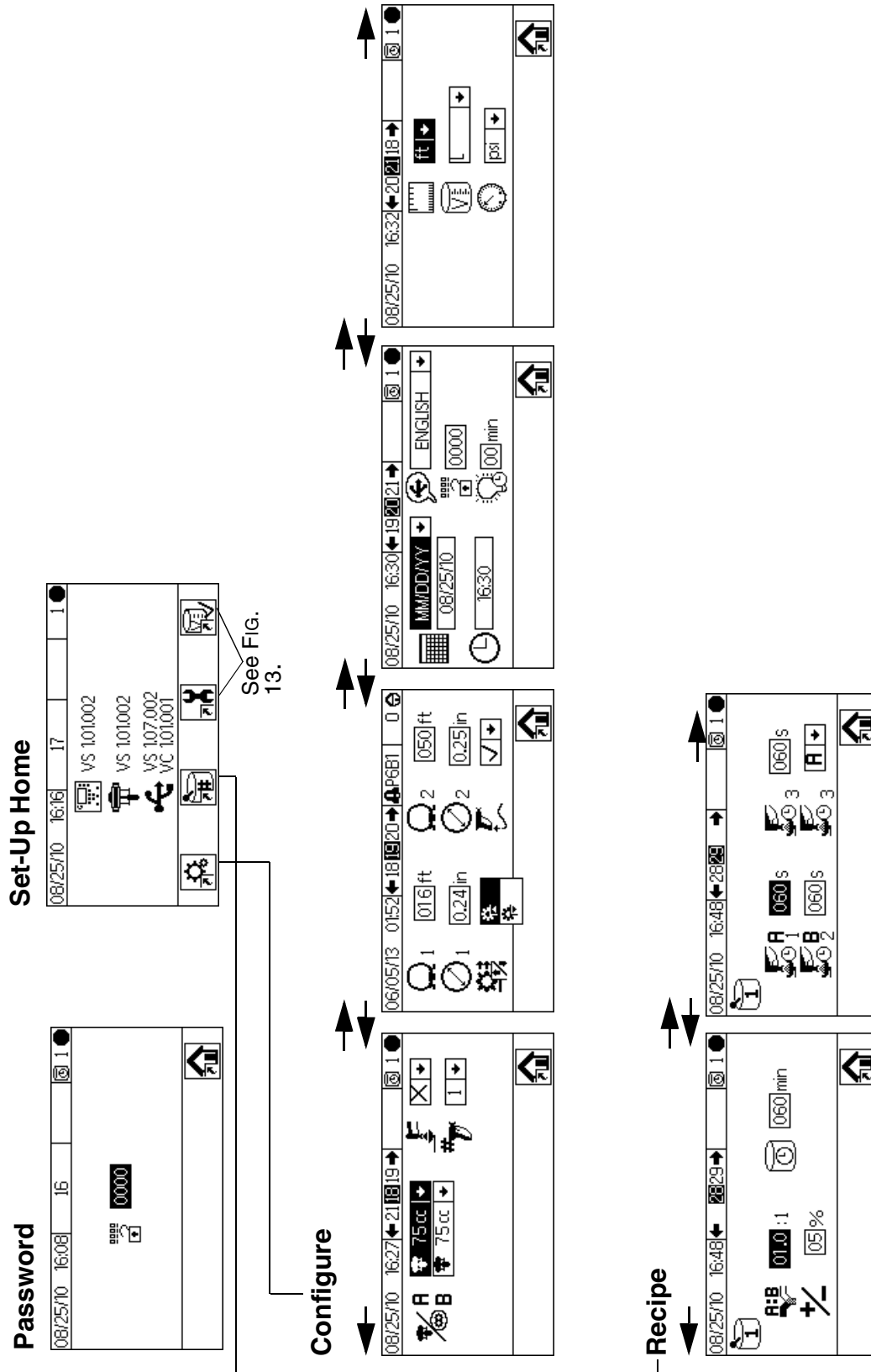

FIG. 12. Setup Mode Screen Map, page 1

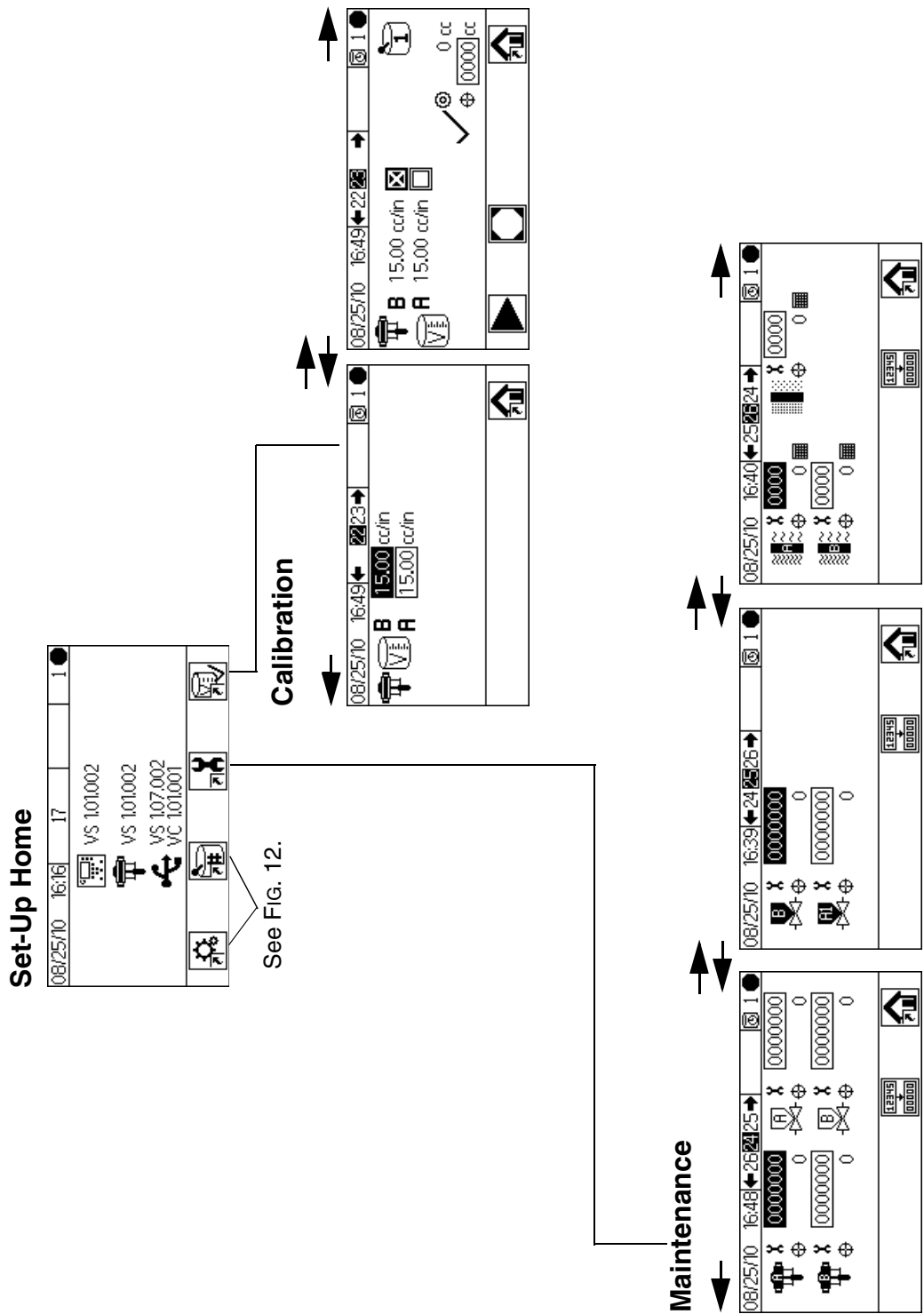

FIG. 13. Setup Mode Screen Map, page 2

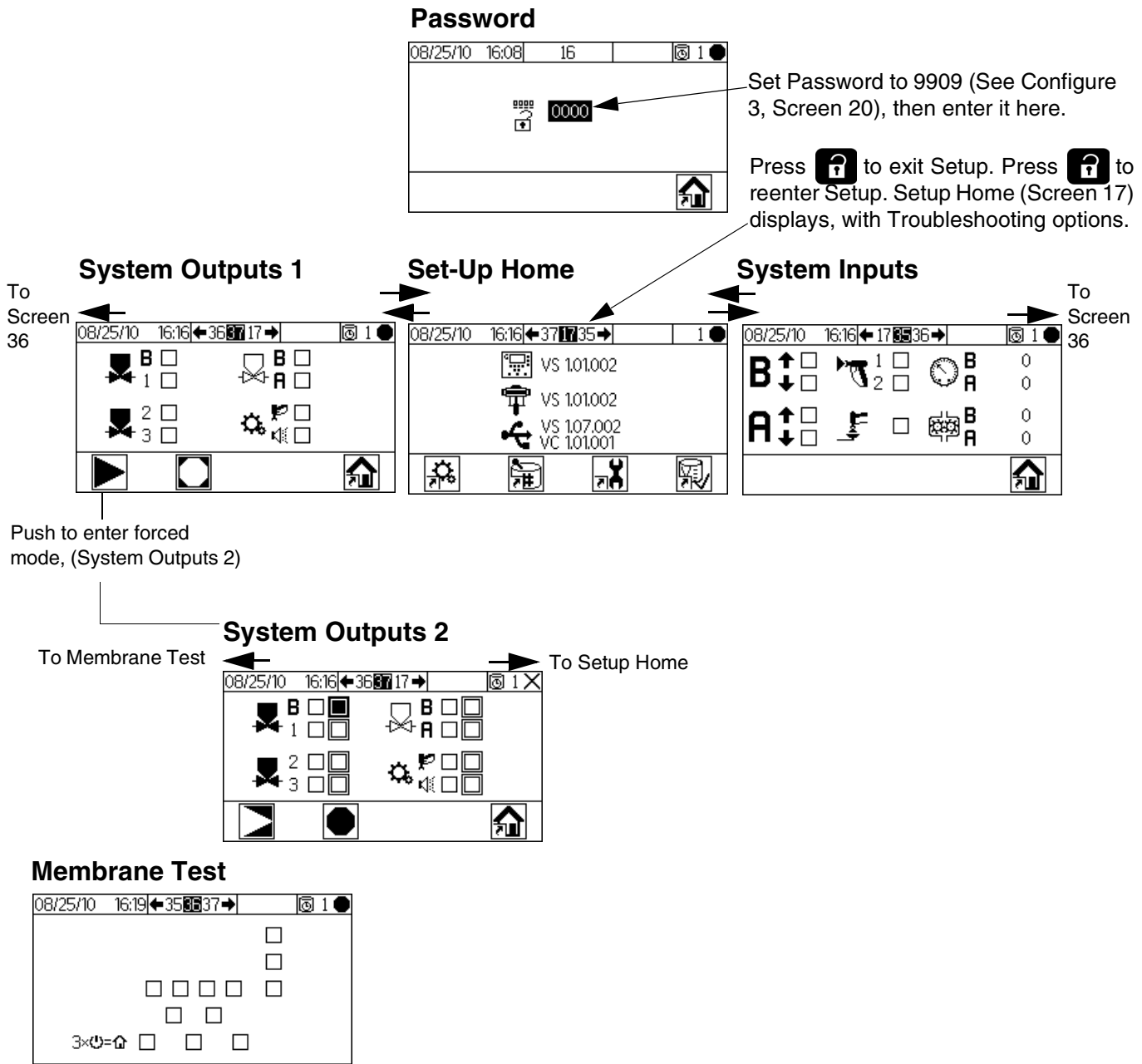

FIG. 14. Troubleshooting Screen Map

Basic Operation

Pre-Operation Tasks

Go through the Pre-Operation Checklist in Table 1.

Table 1: Pre-Operation Checklist

| ✓ | Checklist |
|---|---|
| | System grounded Verify all grounding connections were made. See Grounding , page 19. |
| | All connections tight and correct Verify all electrical, fluid, air, and system connections are tight and installed according to the manual instructions. |
| | Fluid supply containers filled Check component A and B and solvent supply containers. |
| | Dose valves set Check that dose valves are set correctly. Start with the settings recommended in Valve Settings , page 35, then adjust as needed. |
| | Fluid supply valves open and pressure set Component A and B fluid supply pressures should be equal unless one component is more viscous and requires a higher pressure setting. |
| | Solenoid pressure set 75-100 psi inlet air supply (0.5-0.7 MPa, 5.2-7 bar) |

Power On

1. **IS Systems (Alternator Power Supply):** Set pump air regulators to minimum setting. Open main air valve to start air-powered alternator. Main air pressure is displayed on gauge.

Non-IS Systems (Wall Power Supplied): Turn the AC Power Switch ON (I = ON, 0 = OFF).

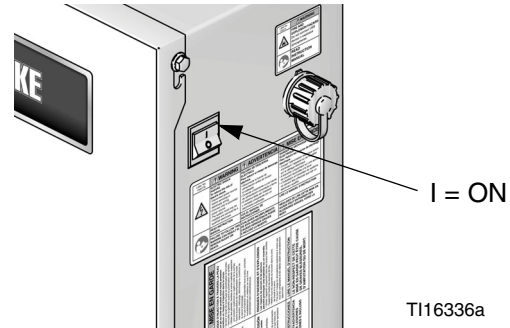

FIG. 15. Power Switch

2. Graco logo will display after five seconds, followed by Run Mix Spray (Screen 2).

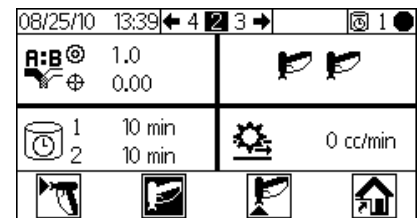

FIG. 16. Run Mix Spray (Screen 2)

Initial System Setup

1. Change optional setup selections to desired parameters, as described in **Configure 1-4 (Screens 18-21)**, page 43.
2. Set recipe and flush information as described in **Recipe 1-1 (Screen 28)** and **Recipe 1-2 (Screen 29)**, page 44.
3. Set maintenance timers for pumps, valves, fluid filters and air filters, as described in **Maintenance 1-3 (Screens 24-26)**, page 45.

Prime the System

NOTE: See **Run Mode Details**, pages 39-41, for further screen information, if needed.



1. Adjust the main air pressure. Most applications require about 80 psi (552 kPa, 5.5 bar) air pressure to operate properly. Do not use less than 75 psi (517 kPa, 5.2 bar).
2. If this is the first time starting up the system, or if lines may contain air, purge as instructed in **Purging**, page 32. The equipment was tested with light-weight oil, which should be flushed out to avoid contaminating your material.
3. From Run Home (Screen 1), press . Make sure that the system is in Standby mode.

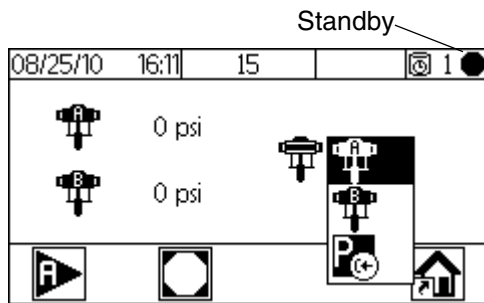

4. Press to show the dropdown menu.
5. Press to highlight Pump A, then press .
6. Put Pump A into supply pail.
7. Adjust air pressure to component A pump for your application. Use lowest pressure possible.

NOTE: Do not exceed the maximum rated working pressure shown on the system identification label or the lowest rated component in the system.

8. Open the fluid supply valve to the pump.

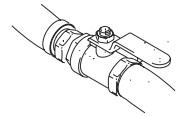

NOTE: If using an electrostatic gun, shut off the electrostatics before spraying.

9. If using a gun flush box, place the gun in the box and close the lid. Press . The pump will run 12 cycles.

If the gun flush box is not used, trigger the gun into a grounded metal pail until the system returns to Standby.



10. Press to stop the pump before 12 cycles are completed. If the pump is not fully primed after 12 cycles, press again.
11. Repeat for Pump B.

Pump Calibration







NOTE: See **Calibration 1 and 2 (Screens 22 and 23)**, page 46, for further screen information, if needed.





Calibrate the pump:

- The first time the system is operated.
- Whenever new materials are used in the system, especially if the materials have viscosities that differ significantly.
- At least once per month as part of regular maintenance.
- Whenever a pump is serviced or replaced.

NOTE:

- Pump factors on Calibration 1 (Screen 22) are updated automatically after the calibration procedure is completed. You also may manually edit them if desired.
 - All values on this screen are in cc or cc/in., regardless of the units set in Configure 4 (Screen 21).
 - During each calibration the dispense valve will close during an up stroke and a down stroke (in either order). This test is to verify that the pump ball checks are seating properly and not leaking. If leaking occurs, the system will alarm after the calibration for that particular valve.
1. Before calibrating pump A or B, prime the system with material. See **Prime the System**, page 30.
 2. If the display is on a Run Mode screen, press  to access setup screens.
 3. Press  to display Calibration1 (Screen 22). Pump calibration factors are shown for Pump A and Pump B.
 4. Press   to move to Calibration 2 (Screen 23).
 5. Press   to highlight the pump you wish to calibrate. Press . An X displays in the box.

6. Press  to start the calibration on the checked pump (A or B). Press  to cancel the calibration.

7. Trigger gun into a graduated cylinder. Dispense a minimum of 200-300cc of material.

NOTE: Stop triggering the gun when desired amount is reached. **Do not** press , as it will cancel the calibration.

8. The volume that the ProMix measured displays on the Display Module.

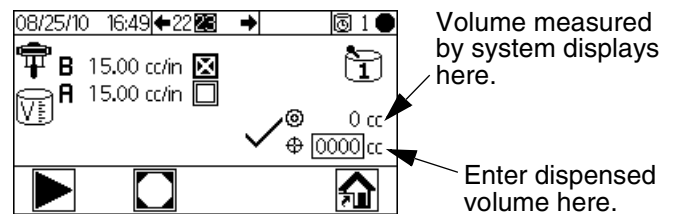









FIG. 17. Dispensed Volume Comparison

9. Compare the amount on the Display Module to the amount in the graduated cylinder.

NOTE: For maximum accuracy, use a gravimetric (mass) method to determine the actual volumes dispensed.

- If the screen and actual volumes are different, press   to highlight the dispense volume field. Press . Press   to move between digits. Press   to change a digit. Press  when field is correct.

NOTE: If the value is substantially different, repeat the calibration process until the dispensed volume and measured volume match.

10. After the volume for A or B is entered, the ProMix 2KE controller calculates the new pump factor and shows it on Calibration 1 (Screen 22) and Calibration 2 (Screen 23).
11. Before you begin production, clear the system of solvent and prime it with material.
 - a. Go to Mix mode.
 - b. Trigger the gun into a grounded metal pail until mixed material flows from the gun nozzle.

If the fluid flow rate is too low: increase air pressure to component A and B fluid supplies or increase the regulated fluid pressure of mixed material.



If the fluid flow rate is too high: reduce the air pressure to component A and B fluid supplies, close the dose valves further, or decrease the regulated fluid pressure of mixed material.

4. Turn on atomizing air to the gun. Check the spray pattern as instructed in your spray gun manual.

Spraying

NOTE: See **Run Mode Details**, pages 39-41, for further screen information, if needed.



1. Calibrate the pumps as described in **Pump Calibration**, page 31. Pump factors will update automatically based on calibration results. Make additional manual changes, if desired, as described in **Calibration 1 and 2 (Screens 22 and 23)**, page 46. Adjust the flow rate.
2. Press . The system will load the correct potlife volume based on hose length and diameter entered on Configure 2 (Screen 19). Once material is loaded, the system returns to Standby. Press  again to spray the loaded recipe.
3. Adjust the flow rate. The fluid flow rate shown on the Display Module screen is for either component A or B, depending on which dose valve is open.

NOTE:

- Pressure adjustments of each component will vary with fluid viscosity. Start with the same fluid pressure for component A and B, then adjust as needed.
- Do not use the first 4-5 oz. (120-150 cc) of material as it may not be thoroughly mixed due to errors while priming the system.

NOTICE

Do not allow a fluid supply tank to run empty. It is possible for air flow in the supply line to turn gear meters in the same manner as fluid. This can damage the meters and lead to the proportioning of fluid and air that meets the ratio and tolerance settings of the equipment. This can further result in spraying uncatalyzed or poorly catalyzed material.

Purging

NOTE: See **Run Mode Details**, pages 39-41, for further screen information, if needed.



There are 2 purging procedures in this manual:

- **Purging Mixed Material**
- **Purging Fluid Supply System**

Use the criteria listed for each procedure to determine which procedure to use.





FIG. 18. Flow Rate Display

Purging Mixed Material

There are times when you only want to purge the fluid manifold, such as:

- end of potlife
- breaks in spraying that exceed the potlife
- overnight shutdown or end of shift
- before servicing the fluid manifold assembly, hose or gun.

1. Press  on Run Mix Spray (Screen 2) or  from any screen to put the system in Standby.
2. Trigger the gun to relieve pressure.
3. If you are using a high pressure gun, engage the trigger lock. Remove spray tip and clean tip separately.
4. If using an electrostatic gun shut off the electrostatics before flushing the gun.
5. Set the solvent supply pressure regulator at a pressure high enough to completely purge the system in a reasonable amount of time but low enough to avoid splashing or an injection injury. Generally, a setting of 100 psi (0.7 MPa, 7 bar) is sufficient.
6. If using a gun flush box, place the gun into the box and close the lid.
7. Press  on Run Mix Spray (Screen 2). The purge sequence automatically starts.

If the gun flush box is not used, trigger the gun into a grounded metal pail until the purge sequence is complete.



When done purging, the system automatically switches to Standby mode.

8. If the system is not completely clean, repeat step 6.

NOTE: If necessary, adjust purge sequence times so only one cycle is required.

9. Trigger the gun to relieve pressure. Engage trigger lock.
10. If spray tip was removed, reinstall it.
11. Adjust the solvent supply regulator back to its normal operating pressure.



NOTE: The system remains full of solvent.

NOTE: If your system uses 2 guns, you must trigger both guns simultaneously during a purge to purge both guns and lines. Verify that clean solvent flows from each gun. If not, repeat purge or clear clog/blockage in system.

Purging Fluid Supply System

Follow this procedure before:

- the first time material is loaded into equipment
- servicing
- shutting down equipment for an extended period of time
- putting equipment into storage

1. Press  on Run Mix Spray (Screen 2) or  from any screen to put the system in Standby.
2. Trigger the gun to relieve pressure.
3. If you are using a high pressure gun, engage the trigger lock. Remove spray tip and clean tip separately.
4. If using an electrostatic gun, shut off the electrostatics before flushing the gun.
5. Disconnect the component A and B fluid supplies at the pump inlets, and connect solvent supply lines.
6. Adjust the solvent fluid supply pressure. Use the lowest possible pressure to avoid splashing.
7. Remove the Control Box cover to access the solenoid valves. See FIG. 19.

8. Purge as follows:

- Purge component A side. Press the manual override on the Dose Valve A solenoid valve and trigger the gun into a grounded metal pail.
- Purge component B side. Press the manual override on the Dose Valve B solenoid valve and trigger the gun into a grounded metal pail until clean solvent flows from the gun.
- Repeat to thoroughly clean the mix manifold.

9. Reinstall the Control Box cover.

10. Shut off the solvent fluid supply.

11. Disconnect the solvent supply lines and reconnect the component A and B fluid supplies.

NOTE: The system remains full of solvent.

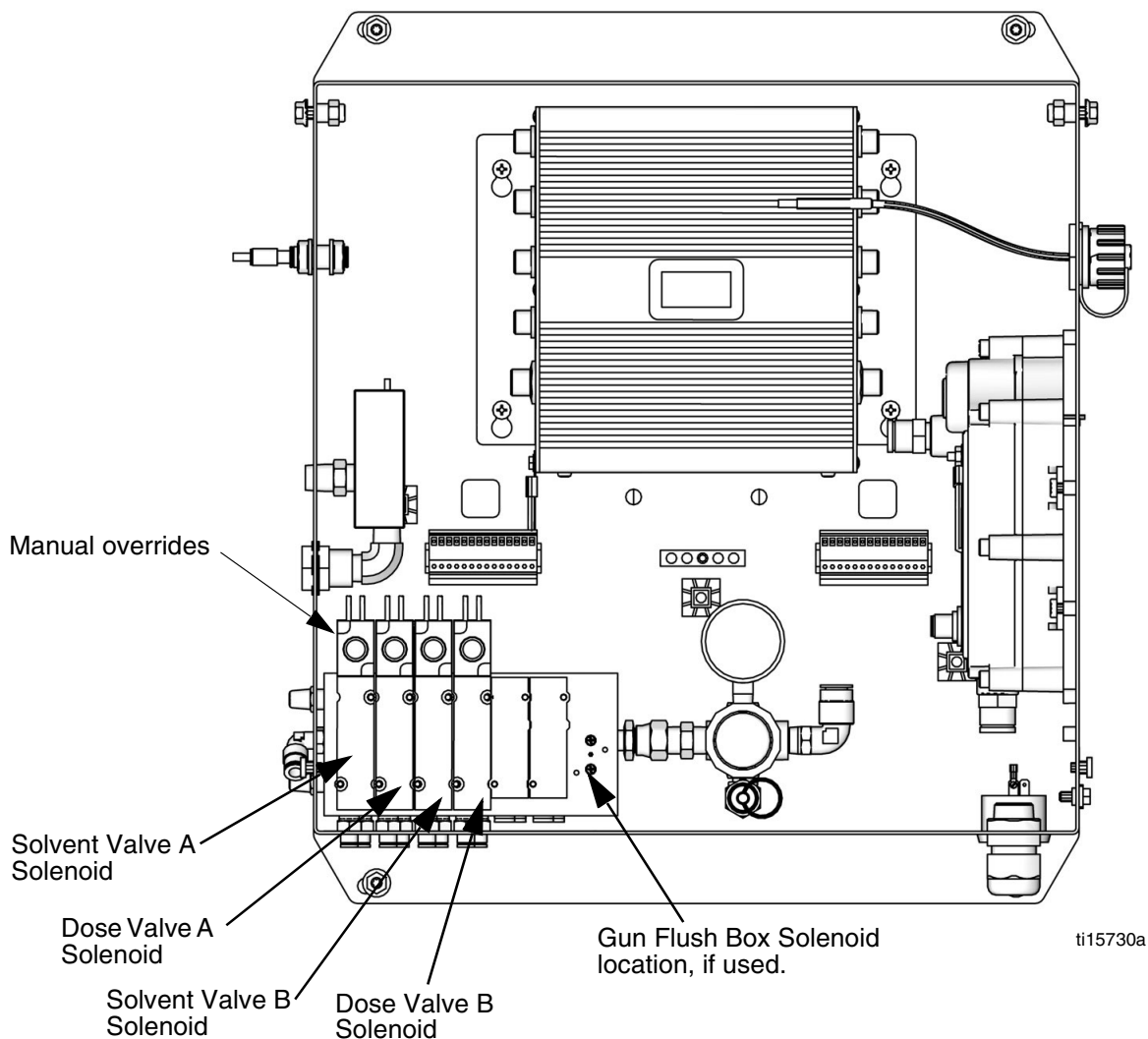
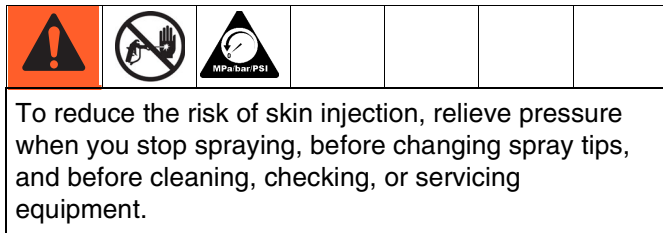



FIG. 19. Solenoid Valves in Control Box

Pressure Relief Procedure



NOTE: The following procedure relieves all fluid and air pressure in the ProMix 2KE system.

1. Press  on Run Mix Spray (Screen 2) or  from any screen to put the system in Standby.
2. Follow procedure for **Purging Fluid Supply System**, page 33, if desired or necessary.
3. Shut off air supply to A and B pumps and solvent supply pumps.
4. With the gun triggered, push the manual override on the A and B dose and solvent valve solenoids to relieve pressure. See FIG. 19. Verify that fluid pressure is reduced to 0.
5. Reinstall the Control Box cover.

Lock Mode

NOTE: Do not change system type, number of guns, hose length or hose diameter when material is loaded in the system. Change these inputs only if system hardware is changed.

If you change one of these inputs, the system locks so that you cannot spray or mix. If you have changed to a meter system, the system also locks if you change the dosing type or the number of colors. The lock icons display.

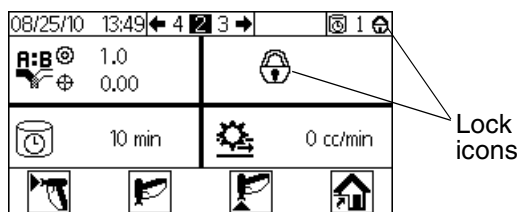
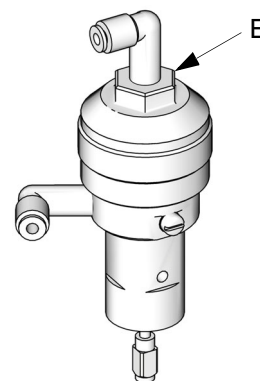

FIG. 20. System Lock Mode

Power down and power back up again to clear the lock and put the new settings into effect. The lock ensures that the selection was intended and prevents the user from attempting to operate with incorrect settings.

Valve Settings

Dose valves and purge valves are factory set with the hex nut 1-1/4 turns out from fully closed. This setting limits maximum fluid flow rate into integrator and minimizes valve response time. To open dose or purge valves (for high viscosity materials), turn hex nut (E) *counterclockwise*. To close dose or purge valves (for low viscosity materials), turn *clockwise*. See FIG. 21.



TI11581a

FIG. 21. Valve Adjustment

Shutdown

1. Follow **Purging**, on page 32.
2. Close main air shutoff valve on air supply line and on ProMix 2KE.
3. **Non-IS Systems:** Shut off ProMix 2KE power (0 position).

Use of Optional USB Module

USB Logs

Job Log 1

See example in FIG. 22. The job log records total volumes for each job that the system performs, up to 2000. It records the date, time, user number, job number, total A volume, total B volume, and mix ratio. Job total volumes are in cubic centimeters. A log entry is made when a new job is initiated, which occurs when batch totals are cleared, or when the job number is incremented from Run Job Number (Screen 38). Job information is displayed on the Display Module **only** through use of the optional USB Module.

NOTE: User Number, Ratio, and Alarm 1-5 are displayed as of 2KE System Software version 1.03.001 (USB Cube Software version 1.10.001).

Error Log 2

See example in FIG. 23. The error log records all errors generated by the system, up to 500. It records the date, time, error number, error code, and error type for each error that occurs. Without the USB, the user can access the 50 most recent errors via the Display Module.

NOTE: For both the Job Log and the Error Log, when the log is full, new data automatically overwrites old data. When data in either log is downloaded via the USB, it remains in the module until it is overwritten.

| | A | B | C | D | E | F | G | H | I | J | K | L | M |
|----|------------------------------|----------|-------------|---------|-------|--------------|--------------|----------------|---------|---------|---------|---------|---------|
| 1 | Job Log | | | | | | | | | | | | |
| 2 | USB Serial Number: 09001088 | | | | | | | | | | | | |
| 3 | Software Part Number: 15W201 | | | | | | | | | | | | |
| 4 | Software Revision: 1.10.001 | | | | | | | | | | | | |
| 5 | ##### | | | | | | | | | | | | |
| 7 | Date | Time | User Number | Job No. | Ratio | Job Total: A | Job Total: B | Job Recipe No. | Alarm 1 | Alarm 2 | Alarm 3 | Alarm 4 | Alarm 5 |
| 8 | 8/12/13 | 16:32:10 | 300000010 | 633 | 1 | 502 | 488 | 1 | - | - | - | - | - |
| 9 | 8/12/13 | 16:37:54 | 300000010 | 634 | 30 | 0 | 0 | 2 | SFA2 | - | - | - | - |
| 10 | 8/12/13 | 16:41:49 | 300000010 | 635 | 0 | 360 | 0 | 3 | - | - | - | - | - |
| 11 | 8/12/13 | 16:42:22 | 300000010 | 636 | 1 | 0 | 0 | 1 | - | - | - | - | - |
| 12 | 8/12/13 | 17:54:51 | 300000010 | 637 | 30 | 0 | 0 | 2 | QLBX | SAD1 | SAD1 | SFA2 | SFA2 |
| 13 | | | | | | | | | | | | | |
| 14 | | | | | | | | | | | | | |
| 15 | | | | | | | | | | | | | |
| 16 | | | | | | | | | | | | | |
| 17 | | | | | | | | | | | | | |
| 18 | | | | | | | | | | | | | |
| 19 | | | | | | | | | | | | | |
| 20 | | | | | | | | | | | | | |
| 21 | | | | | | | | | | | | | |
| 22 | | | | | | | | | | | | | |
| 23 | | | | | | | | | | | | | |
| 24 | | | | | | | | | | | | | |
| 25 | | | | | | | | | | | | | |
| 26 | | | | | | | | | | | | | |
| 27 | | | | | | | | | | | | | |
| 28 | | | | | | | | | | | | | |
| 29 | | | | | | | | | | | | | |
| 30 | | | | | | | | | | | | | |
| 31 | | | | | | | | | | | | | |
| 32 | | | | | | | | | | | | | |
| 33 | | | | | | | | | | | | | |
| 34 | | | | | | | | | | | | | |
| 35 | | | | | | | | | | | | | |
| 36 | | | | | | | | | | | | | |
| 37 | | | | | | | | | | | | | |
| 38 | | | | | | | | | | | | | |
| 39 | | | | | | | | | | | | | |
| 40 | | | | | | | | | | | | | |
| 41 | | | | | | | | | | | | | |
| 42 | | | | | | | | | | | | | |
| 43 | | | | | | | | | | | | | |
| 44 | | | | | | | | | | | | | |
| 45 | | | | | | | | | | | | | |
| 46 | | | | | | | | | | | | | |
| 47 | | | | | | | | | | | | | |
| 48 | | | | | | | | | | | | | |
| 49 | | | | | | | | | | | | | |

FIG. 22. Sample Job Log

| | A | B | C | D | E | F | G | H | I | J | K |
|----|------------------------------|----------|--------------|-------|---------------|---|---|---|---|---|---|
| 1 | Alarm Log | | | | | | | | | | |
| 2 | USB Serial Number: 09001088 | | | | | | | | | | |
| 3 | Software Part Number: 15W201 | | | | | | | | | | |
| 4 | Software Revision: 1.10.001 | | | | | | | | | | |
| 5 | ##### | | | | | | | | | | |
| 6 | | | | | | | | | | | |
| 7 | Date | Time | Alarm Number | Alarm | Type of Alarm | | | | | | |
| 8 | 7/26/13 | 0:00:10 | 618 | MGA1 | ADVISORY | | | | | | |
| 9 | 7/26/13 | 0:00:11 | 619 | MGB1 | ADVISORY | | | | | | |
| 10 | 7/29/13 | 12:03:38 | 620 | EL | RECORD | | | | | | |
| 11 | 7/29/13 | 12:03:39 | 621 | MESA | ADVISORY | | | | | | |
| 12 | 7/29/13 | 12:03:40 | 622 | MGA1 | ADVISORY | | | | | | |
| 13 | 7/29/13 | 12:03:41 | 623 | MGB1 | ADVISORY | | | | | | |
| 14 | 218569986 | 12:03:48 | 624 | EL | RECORD | | | | | | |
| 15 | 218569986 | 12:03:49 | 625 | CA | ALARM | | | | | | |
| 16 | 218569986 | 12:03:50 | 626 | MESA | ADVISORY | | | | | | |
| 17 | 218569986 | 12:03:51 | 627 | MGA1 | ADVISORY | | | | | | |
| 18 | 218569986 | 12:03:52 | 628 | MGB1 | ADVISORY | | | | | | |
| 19 | 218569986 | 12:03:53 | 629 | MGP1 | ADVISORY | | | | | | |
| 20 | 218569987 | 12:04:00 | 1617 | EL | RECORD | | | | | | |
| 21 | 218569987 | 12:04:01 | 1618 | CA | ALARM | | | | | | |
| 22 | 218569988 | 12:04:08 | 624 | EL | RECORD | | | | | | |
| 23 | 218569988 | 12:04:09 | 625 | CA | ALARM | | | | | | |
| 24 | 218569988 | 12:04:10 | 626 | MESA | ADVISORY | | | | | | |
| 25 | 218569988 | 12:04:11 | 627 | MGA1 | ADVISORY | | | | | | |
| 26 | 218569988 | 12:04:12 | 628 | MGB1 | ADVISORY | | | | | | |
| 27 | 218569988 | 12:04:13 | 629 | MGP1 | ADVISORY | | | | | | |
| 28 | 8/8/13 | 12:08:00 | 624 | EL | RECORD | | | | | | |
| 29 | 8/8/13 | 12:08:01 | 625 | MESA | ADVISORY | | | | | | |
| 30 | 8/8/13 | 12:08:02 | 626 | MGA1 | ADVISORY | | | | | | |
| 31 | 8/8/13 | 12:08:03 | 627 | MGB1 | ADVISORY | | | | | | |
| 32 | 8/8/13 | 12:08:19 | 628 | EQU1 | RECORD | | | | | | |
| 33 | 8/8/13 | 12:22:23 | 1617 | EL | RECORD | | | | | | |
| 34 | 8/8/13 | 12:26:25 | 1689 | EL | RECORD | | | | | | |
| 35 | 8/8/13 | 12:26:57 | 1690 | EL | RECORD | | | | | | |
| 36 | 8/8/13 | 12:27:19 | 1691 | EL | RECORD | | | | | | |
| 37 | 8/8/13 | 12:28:33 | 1692 | EL | RECORD | | | | | | |
| 38 | 8/8/13 | 12:29:01 | 1693 | EL | RECORD | | | | | | |
| 39 | 8/8/13 | 12:29:28 | 1694 | EL | RECORD | | | | | | |
| 40 | 8/8/13 | 14:50:45 | 1695 | EL | RECORD | | | | | | |
| 41 | 8/8/13 | 14:52:15 | 1696 | EL | RECORD | | | | | | |
| 42 | 8/8/13 | 15:19:49 | 1697 | EL | RECORD | | | | | | |
| 43 | 8/8/13 | 15:33:55 | 1703 | EL | RECORD | | | | | | |
| 44 | 8/8/13 | 15:35:28 | 1706 | EL | RECORD | | | | | | |
| 45 | 8/8/13 | 15:39:48 | 1707 | EL | RECORD | | | | | | |
| 46 | 8/8/13 | 15:50:46 | 1710 | EL | RECORD | | | | | | |
| 47 | 8/8/13 | 15:52:14 | 1711 | EL | RECORD | | | | | | |
| 48 | 8/12/13 | 16:22:05 | 631 | EL | RECORD | | | | | | |
| 49 | 8/12/13 | 16:22:06 | 632 | MESA | ADVISORY | | | | | | |
| 50 | 8/12/13 | 16:22:07 | 633 | MGA1 | ADVISORY | | | | | | |
| 51 | 8/12/13 | 16:22:08 | 634 | MGB1 | ADVISORY | | | | | | |
| 52 | 8/12/13 | 16:33:18 | 635 | SFA2 | ALARM | | | | | | |
| 53 | 8/12/13 | 16:43:30 | 636 | SFA2 | ALARM | | | | | | |
| 54 | 8/12/13 | 16:45:27 | 637 | EQU1 | RECORD | | | | | | |
| 55 | 8/12/13 | 17:51:42 | 638 | SFA2 | ALARM | | | | | | |
| 56 | 8/12/13 | 17:52:33 | 639 | SAD1 | ALARM | | | | | | |
| 57 | 8/12/13 | 17:53:37 | 640 | SAD1 | ALARM | | | | | | |
| 58 | 8/12/13 | 17:54:07 | 641 | QLBX | ALARM | | | | | | |
| 59 | | | | | | | | | | | |

Fig. 23. Sample Error Log

Setup

The only setup required is to select the language in which you want to view the downloaded data. (Screens are icon-based and do not change.) Navigate to Config-ure 3 (Screen 20). Select your language from the language dropdown.

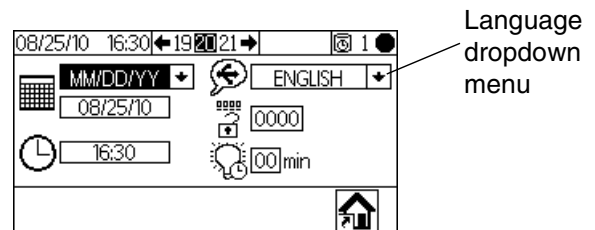
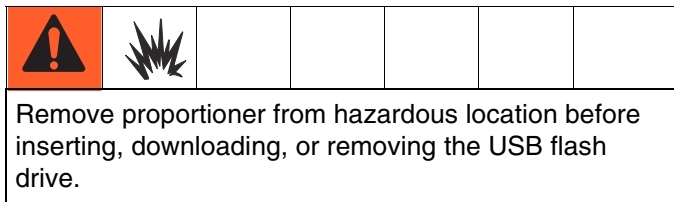



Fig. 24. Select Language for USB Logs

Download Procedure



1. Press  on Run Mix Spray (Screen 2) or  from any screen to place the system in Standby.

NOTE: The system will not operate with a USB flash drive in the port. If you insert the flash drive while spraying, the system will stop and an alarm error will occur.

2. Insert USB flash drive into USB port. Use only Graco-recommended USB flash drives; see **Recommended USB Flash Drives**, page 38.
3. Data download begins automatically. An LED on the flash drive blinks until the download is complete.

NOTE: If you use a flash drive that does not have an LED, open the Control Box. An LED near the USB module flashes until the download is complete.

4. Remove flash drive from USB port.

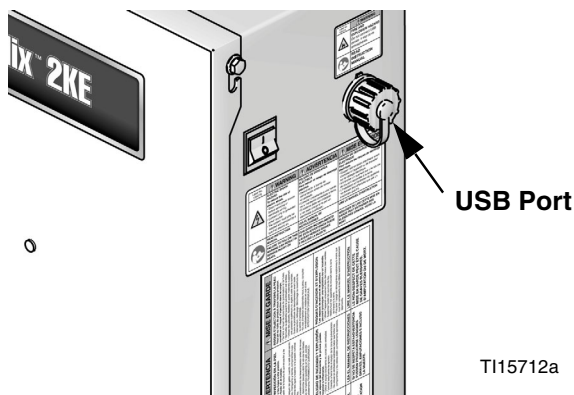
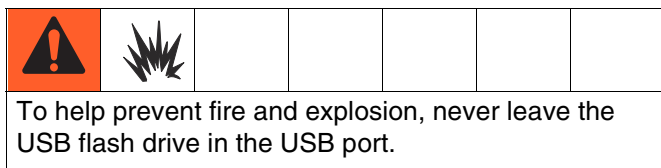

FIG. 25. USB Port

5. Insert USB flash drive into USB port of computer.

6. The USB flash drive window automatically opens. If it does not, open USB flash drive from within Windows® Explorer.
7. Open Graco folder.
8. Open sprayer folder. If downloading data from more than one sprayer, there will be more than one sprayer folder. Each sprayer folder is labeled with the corresponding USB serial number.
9. Open DOWNLOAD folder.
10. Open folder labeled with the highest number. The highest number indicates the most recent data download.
11. Open log file. Log files open in Microsoft® Excel® by default. However, they can also be opened in any text editor or Microsoft® Word.

NOTE:

All USB logs are saved in Unicode (UTF-16) format. If opening the log file in Microsoft Word, select Unicode encoding.

Recommended USB Flash Drives

It is recommended that users use the 4GB USB flash drive (16A004) available for purchase separately from Graco. If preferred, users may use one of the following 4 GB or less USB flash drives (not available from Graco).

- Crucial Gizmo!™ 4GB USB flash drive (model JDO4GB-730)
- Transcend JetFlash® V30 4GB USB flash drive (model TS4GJFV30)
- OCZ Diesel™ 4GB USB flash drive (model OCZUSBDSL4G)

Run Mode Details

Run Mix Spray (Screen 2)

Run Mix Spray (Screen 2) displays at startup or if  is selected from Run Home (Screen 1). Use the Mix Spray screen to control most mixing operations.

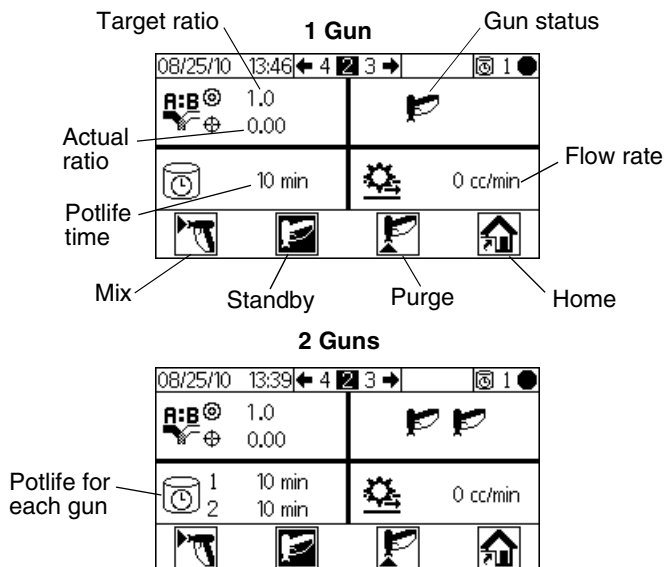





FIG. 26. Run Mix Spray (Screen 2)

- Press   to toggle between Run Mix Spray (Screen 2), Run Mix Batch (Screen 3), Run Mix Totals (Screen 4), and Run Job Number (Screen 38).
- Press  to access Run Home (Screen 1).

Run Home (Screen 1)

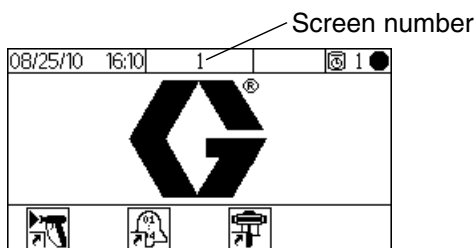







FIG. 27. Run Home (Screen 1)

- Press a soft key button to select one of the main Run Mode screen sections: Mix , Errors , or Pump Control .
- Press  to enter the Setup screens.

Run Mix Batch (Screen 3)

Run Mix Batch (Screen 3) displays if   is selected from the Run Mix Spray Screen. Use the Mix Batch screen to dispense set volumes. Target volume can be set from 1 to 9999 cc.

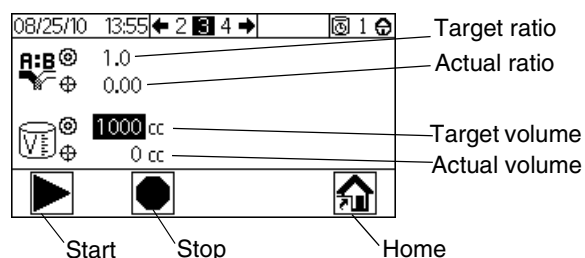









FIG. 28. Run Mix Batch (Screen 3)

- Press  to set the target dispense volume. Use   to change each digit, then   to move to the next digit. Press  when finished.
- Press   to toggle between Run Mix Spray (Screen 2), Run Mix Batch (Screen 3), Run Mix Totals (Screen 4), and Run Job Number (Screen 38).

Run Mix Totals (Screen 4)

Run Mix Totals (Screen 4) displays if **← →** is selected from the Run Mix Batch Screen. Use this screen to view grand and batch totals for material A and material B, and to clear batch totals if desired.

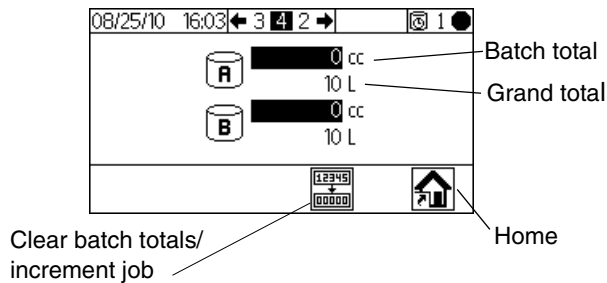

FIG. 29. Run Mix Totals (Screen 4)

- Press **12345** to clear all batch totals. A verification screen appears. Use **↓ ↑** to highlight and press **←** on the **✓** to clear the batch totals, or on the **×** to return to Run Totals (Screen 4) without clearing.

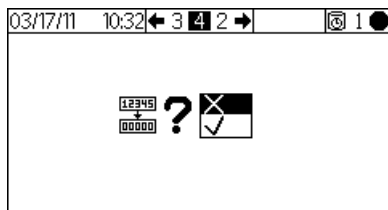

FIG. 30. Confirm Clear Batch Totals

- Press **← →** to toggle between Run Mix Spray (Screen 2), Run Mix Batch (Screen 3), Run Mix Totals (Screen 4), and Run Job Number (Screen 38).

Run Job Number (Screen 38)

Run Job Number (Screen 38) displays if **← →** is selected from the Run Mix Totals Screen. Use this screen to view and increment the job number as well as view and assign a 9-digit user number to the job.

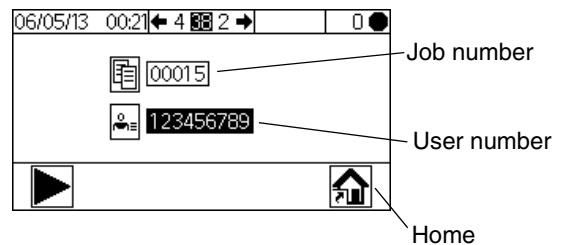

FIG. 31. Run Job Number (Screen 38)

- Press **←** to set the user number. Use **↓ ↑** to change each digit, then **← →** to move to the next digit. Press **←** when finished.
- Press **▶** increment the job number.
- Press **← →** to toggle between Run Mix Spray (Screen 2), Run Mix Batch (Screen 3), Run Mix Totals (Screen 4), and Run Job Number (Screen 38).

Run Log Errors (Screens 5-14)

Run Log Errors (Screens 5-14) display if **01** is selected from Run Home (Screen 1). It displays the last 50 errors in the log. (Screen 5 displays errors 1-5; Screen 6 displays errors 6-10, etc.).

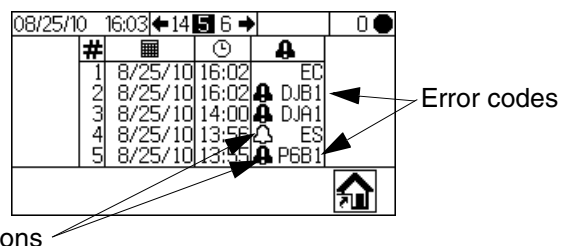



FIG. 32. Run Log Errors (Screen 5)

- Use **← →** to view the next page. See FIG. 54, page 50, for an explanation of the different error icons. See Table 3, page 52, for an explanation of the different error codes.

Run Pump Control (Screen 15)

Run Pump Control (Screen 15) displays if  is selected from the Run Home Screen. Use this screen to manually start and stop a pump.

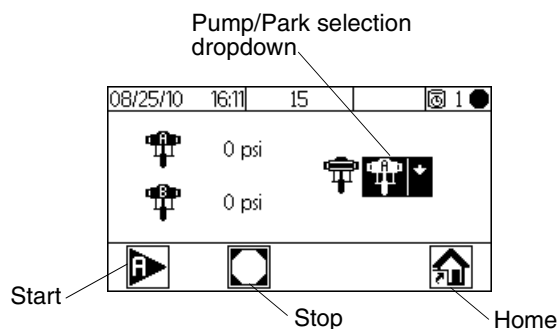











Fig. 33. Run Pump Control (Screen 15)

- Press  to show the dropdown menu.
- Press   to highlight, then press  to select a pump or the Park option.
- If Pump A or Pump B is selected, use  or  to start. The selected pump will run for 12 cycles. To stop before the 12 cycles are completed, press .
- If Park is selected, use  to move the pump to the bottom of the stroke to park it so pump rod is fully enclosed in the lower and material can't dry on shaft during break or overnight.

Setup Mode Details

Press  on any screen to enter the Setup screens. If the system has a password lock, Password (Screen 16) displays. If the system is not locked (password is set to 0000), Setup Home (Screen 17) displays.

Password (Screen 16)

From any Run screen, press  to access the password screen. The Password Screen displays if a password has been set. Set the password to 0000 to prevent Password (Screen 16) from displaying. See Configure 3 (Screen 20), page 44, to set or change the password.

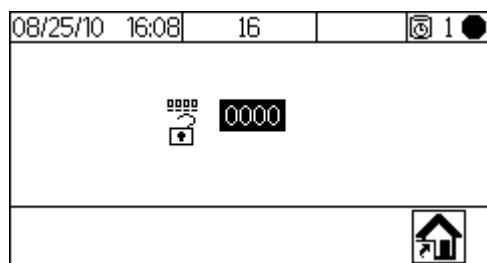











FIG. 34. Password (Screen 16)

- Press  to enter the password (0000 to 9999). Press   to move between digits. Press   to change a digit. Press  when field is correct. Setup Home (Screen 17) displays.
- Press  to toggle between Run Mode and Setup Mode.
- Select  to display Run Home (Screen 1). Entering an incorrect password also displays Run Home (Screen 1).

Setup Home (Screen 17)

Setup Home (Screen 17) displays if  is selected on any screen and the system is not locked, or when a correct password is entered on the Password Screen. The Setup Home screen displays the software versions of the boards in the Display Module, Advanced Fluid Control Module, and the USB Module (if applicable).

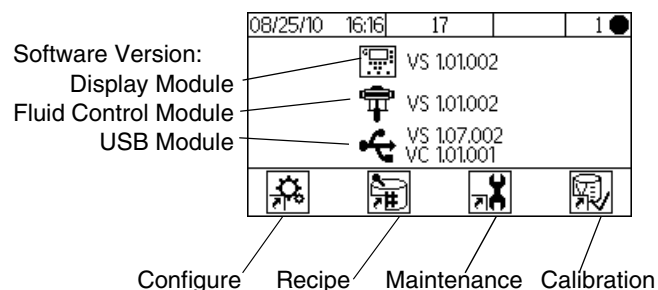







FIG. 35. Setup Home (Screen 17)

- Press a soft key button to select one of the four Setup Mode screen sections:
Configure , Recipe , Maintenance , or Calibration .
- Press  to toggle between Run Mode and Setup Mode.

Configure 1-4 (Screens 18-21)

Configure 1 (Screen 18) displays if  is selected on Setup Home (Screen 17). This screen allows users to set up the system type (pump or meter) and number of guns (1 or 2).

NOTE: If 1 gun is selected, users can enable a gun flush box (✓=yes; X=no). The gun flush box option is available only for 1-gun systems.

For all pump systems, the type of dosing is dynamic, and the number of colors is 1. See **Dynamic Dosing**, page 48, for more information.

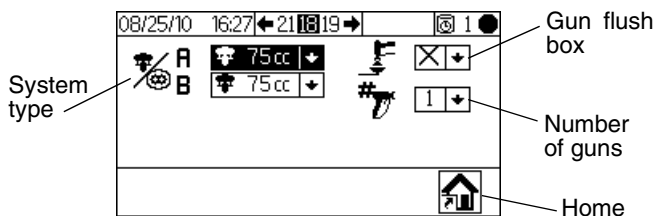















FIG. 36. Configure 1 (Screen 18)

- Press   to highlight the desired field. Press  to display the dropdown menu for that field. Press   to choose from the menu options and  to set. Press   to move to the next field.
- Press   to move through Configure 2 (Screen 19), Configure 3 (Screen 20), and Configure 4 (Screen 21).

NOTE: If you change system type (pump to meter) or number of guns, a verification screen appears. Use   to highlight and press  on the ✓ to make the change, or on the X to return to Configure 1 (Screen 18) without making a change. If a change is made, the system locks so that you cannot spray or mix. Power down and power back up again to clear the lock and put the new settings into effect. The lock ensures that the selection was intended, and prevents the user from attempting to operate with incorrect settings.

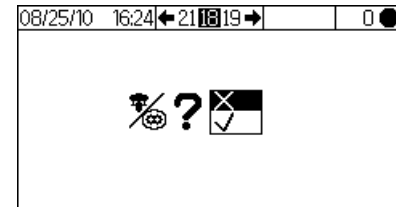



FIG. 37. Confirm Change of System Type

Configure 2 (Screen 19) allows users to set for each gun the hose length (0.1 to 45.7 m, 0.3 to 150 ft) and hose diameter (0.1 to 1 inch). The system uses this information to calculate pot life volume. The pot life volume tells the system how much material must be moved to trigger a reset of the pot life timer. It also tells the system the volume needed to fill during a load sequence.

Users also can configure the flow rate region and the air flow switch. The flow rate region (High/Low) determines the sensitivity of the overdose alarm:

- Select the High  setting if your flow rate is 250 cc/min or higher. The High setting has a 100cc overdose volume.
- Select the Low  setting if your flow rate is less than 250 cc/min. The Low setting has a 50 cc overdose volume.

The air flow switch can be disabled here for airless applications. Select ✓ to enable or X to disable.

A change in any of these fields will trigger the lock. See **NOTE** in previous paragraph.

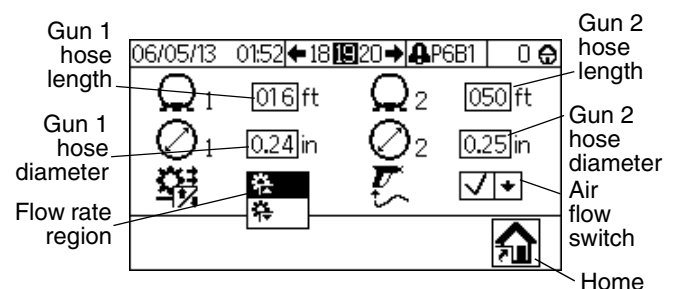

FIG. 38. Configure 2 (Screen 19)

Configure 3 (Screen 20) allows users to set preferred language (for optional USB Module), date format, date, time, password (0000 to 9999), and number of minutes (0 to 99) of inactivity required before the backlight turns off. Configure 4 (Screen 21) allows users to set preferred units for distance, volume, and pressure.

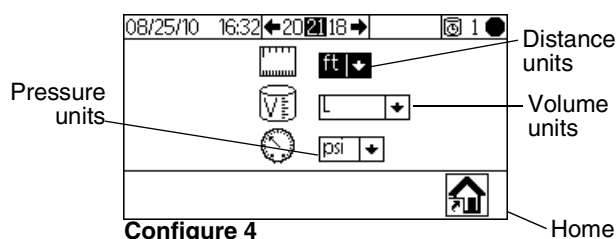
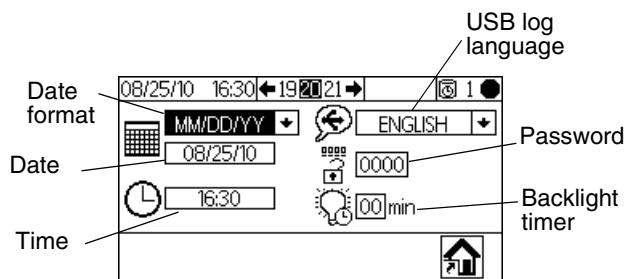

FIG. 39. Configure 3 (Screen 20) and Configure 4 (Screen 21)

Recipe 1-1 (Screen 28)

Note about Settings of 0: If Ratio is set to 0, the system will dispense the A material only. If Potlife Time is set to 0, the potlife alarm is disabled.

Recipe 1-1 (Screen 28) displays if is selected on Setup Home (Screen 17). The Recipe Screens allow the user to set up the basic recipe. Recipe 1-1 (Screen 28) includes the ratio of Material A to Material B (0 to 30), ratio tolerance (1 to 99 percent), and potlife time (0 to 240 minutes).

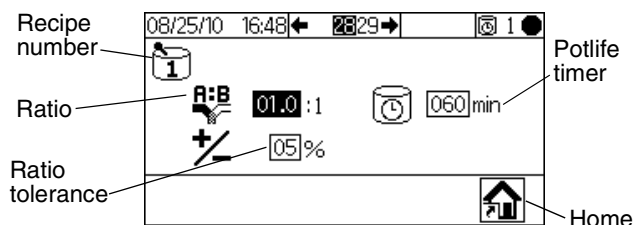

FIG. 40. Recipe 1-1 (Screen 28)

Recipe 1-2 (Screen 29)

Note about Settings of 0: If a Flush time is set to 0, that valve will not flush.

Recipe 1-2 (Screen 29) includes timers for first, second and third flush:

- First flush: Always an A side purge, using the A side flush material from the A purge valve.
- Second flush: Always a B side purge, using the B side flush material from the B purge valve.
- Third flush: User settable to run the A purge valve or the B purge valve for any required additional flush, as selected in the dropdown for the third flush source (A or B).

All flush times are settable from 0 to 240 seconds. Set flush time to 0 seconds to skip a flush in the sequence. For example, to skip the first flush (A side purge), enter 0 seconds. The system goes immediately to the second flush, followed by the third flush as user defined.

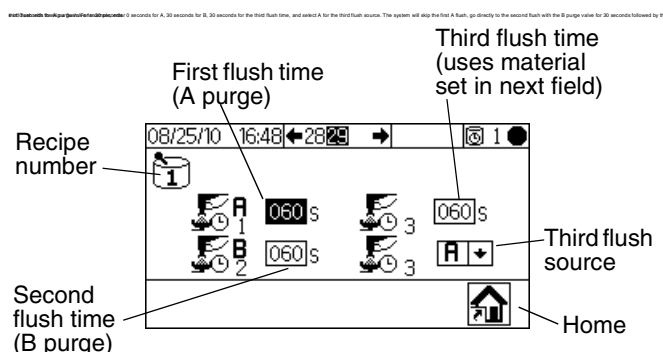



FIG. 41. Recipe 1-2 (Screen 29)

- Press to highlight the desired field and press to select. Press to move between digits. Press to change a digit. Press when field is correct.
- Press to toggle between the Recipe screens.
- Press to return to Setup Home (Screen 17).

Maintenance 1-3 (Screens 24-26)

Maintenance 1 (Screen 24) displays if  is selected on Setup Home (Screen 17). The Maintenance Screens display actual and target maintenance timers for pumps and solvent valves (Maintenance 1, Screen 24), dose valves (Maintenance 2, Screen 25), and fluid filters and air filters (Maintenance 3, Screen 26). Maintenance timers for pumps and valves are settable from 0 to 9999999. Timers for filters are settable from 0 to 9999 days.

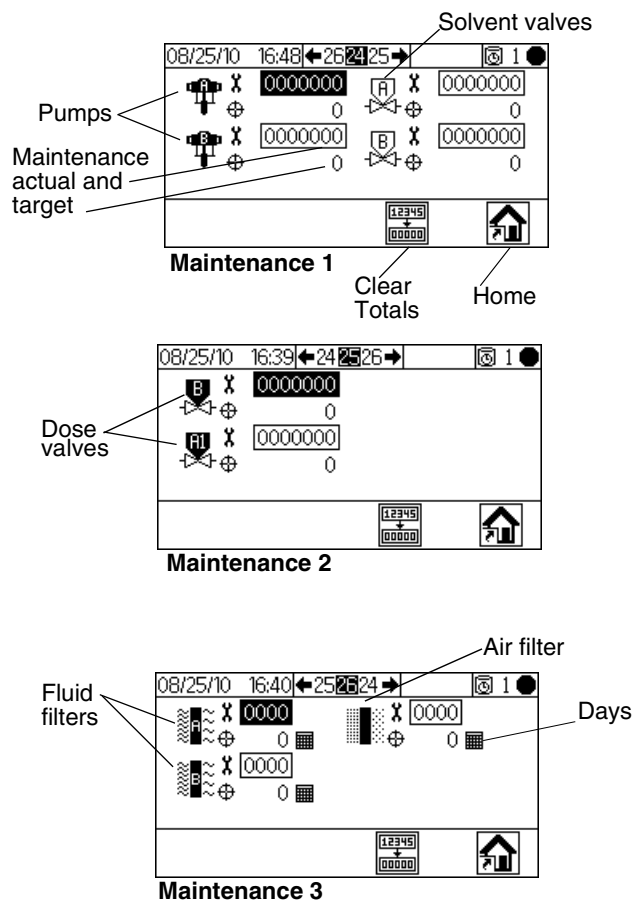











FIG. 42. Setup Maintenance 1-3 (Screens 24-26)

- Press   to move through the three maintenance screens.
- Press  to clear the maintenance total that is highlighted. A verification screen appears. Use   to highlight and press  on the  to clear the batch totals. No other button press will clear the totals. Press  on the  to return to the active Maintenance Screen without clearing.

Maintenance Recommendations

The following table shows recommended starting values for maintenance. Maintenance needs will vary based on individual applications and material differences.

| Component | Recommended Maintenance Frequency |
|----------------|-----------------------------------|
| Solvent Valves | 1,000,000 cycles |
| Fluid Filter | daily |
| Air Filter | monthly |
| Pumps | 250,000 cycles |
| Dose Valves | 1,000,000 cycles |

Calibration 1 and 2 (Screens 22 and 23)

NOTE: See **Pump Calibration**, page 31, for detailed instructions.

Calibration 1 (Screen 22) displays if  is selected on Setup Home (Screen 17). This screen displays the pump factor for Pump A and Pump B. The factor is the pump displacement per inch. The system starts at the default factor for the pump size chosen on Configure 1 (Screen 18, page 43). Factor values update automatically as needed based on calibration results from Calibration 2 (Screen 23). Factor values also can be set on this screen, from 5 to 50 cc/in.

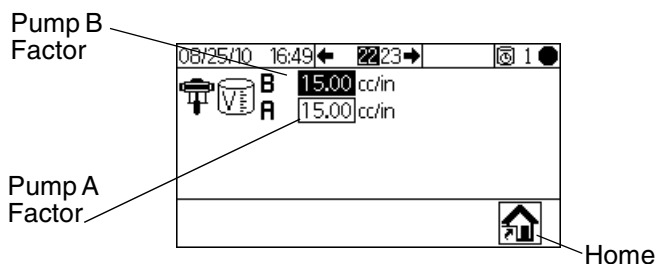



FIG. 43. Calibration 1 (Screen 22)

Press   to display Calibration 2 (Screen 23). This screen allows the user to perform a calibration. It displays Pump A and Pump B factors, the target dispense volume, the actual dispense volume (0 to 9999 cc), and the material to dispense.

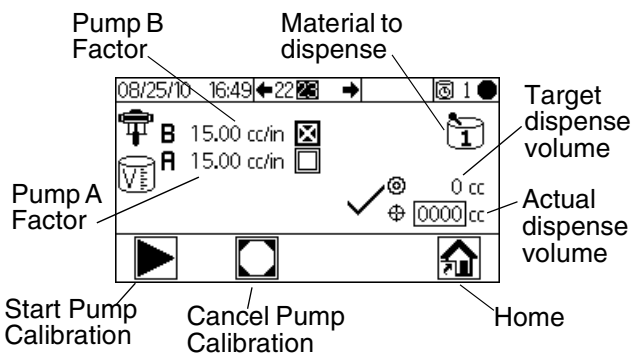

















FIG. 44. Calibration 2 (Screen 23)



- Press   to highlight the pump you wish to calibrate. Press . An X displays in the box.
- Press  to start the calibration on the highlighted pump (A or B). Press  to cancel the calibration.

NOTE: If you press  but calibration does not begin, check to be sure that you have selected Pump A or Pump B.

- Press   to highlight the actual dispense volume field. Press  to set the volume (from 0 to 9999 cc). Press   to move between digits. Press   to change a digit. Press  when field is correct.
- Use   to toggle between Calibration 1 (Screen 22) and Calibration 2 (Screen 23).

Troubleshooting (Screens 35-37)

Screens for testing system controls can be accessed by setting the password to 9909. See **Configure 3 (Screen 20)**, page 44, to set or change the password.

After setting the password to 9909, press  to exit Setup. Press  to reenter Setup. Setup Home (Screen 17) displays, with troubleshooting screen options.

Troubleshooting screen options appear here.

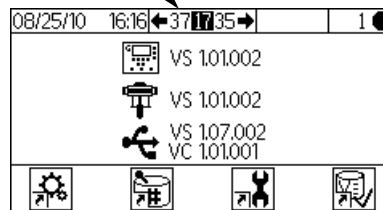

FIG. 45. Setup Home with Troubleshooting

Troubleshooting System Inputs (Screen 35)

From Setup Home (Screen 17) with Troubleshooting active, press to display Troubleshooting System Inputs (Screen 35). An X displays in the box to indicate if Pump B is up or down, if Pump A is up or down, if Air Flow Switch 1 or 2 is on, and if the gun is in the Gun Flush Box. This screen also displays the pressure of Pump A and Pump B. The fields relating to meter function can be ignored.

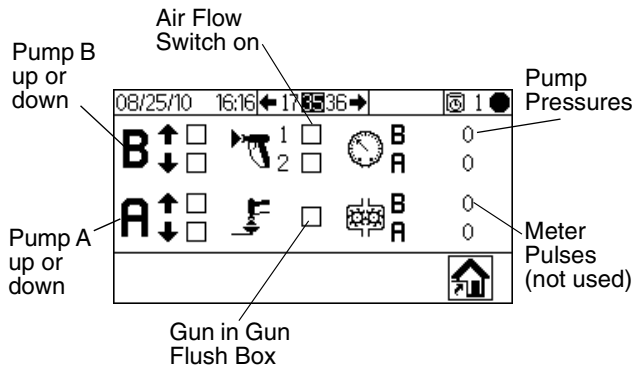

FIG. 46. Troubleshooting System Inputs (Screen 35)

- Press , then again to move to Troubleshooting System Outputs (Screen 37). Press to move to the Membrane Test (Screen 36).

Membrane Test (Screen 36)

From Setup Home (Screen 17) with Troubleshooting active, press , then again. Membrane Test (Screen 36) displays. You could also press , then again. This screen allows an authorized user to test the buttons on the Display Module membrane. When in this screen, all buttons lose their predefined functions, and the soft keys are not defined. When a properly working button is pressed, an X appears in the box.

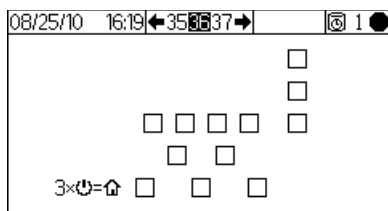

FIG. 47. Membrane Test (Screen 36)

- Press three times to return to Setup Home (Screen 17). Direct access to any other screen is not possible.

Troubleshooting System Outputs (Screen 37)

From Setup Home (Screen 17) with Troubleshooting active, press to display Troubleshooting System Outputs (Screen 37). An X displays in the box to show an electrical state of On for the dose valves B and A1 (A2 and A3 are used only for meter systems), solvent valves (B and A), the gun flush box, and the alarm.

Press to start Forced Mode. A second set of check boxes displays. Use to highlight an output to test. Manually actuate the valve, alarm, or gun trigger corresponding to the highlighted box. For properly working components, an X will display in the second box upon actuation. Press to exit Forced Mode. Moving to any other screen also will exit Forced Mode.

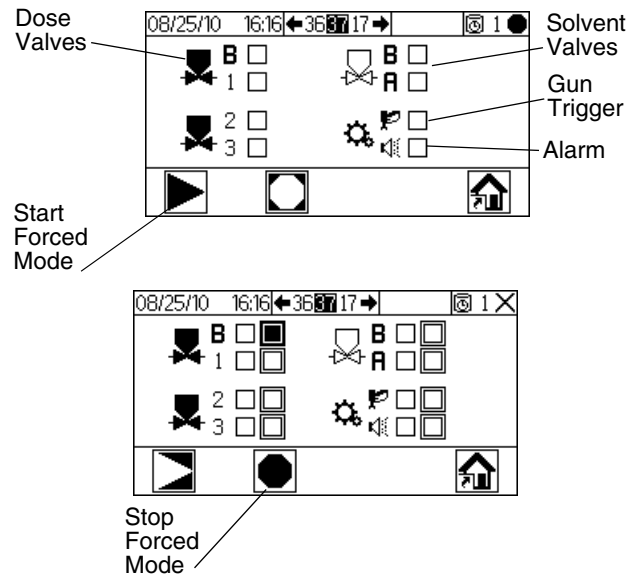

FIG. 48. Troubleshooting Screen Outputs (Screen 37)

Dynamic Dosing

In typical operation (ratios 1:1 and above), component A dispenses constantly. Component B dispenses intermittently in the necessary volume to attain the mix ratio.

General Operating Cycle, Dynamic Dosing

Overview

Dynamic Dosing provides on-demand proportioning, eliminating the need for an integrator and therefore minimizing undesired material contact. This feature is especially useful with shear-sensitive and waterborne materials.

A restrictor injects component B into a continuous stream of component A. The software controls the duration and frequency of each injection. See FIG. 52 for a schematic diagram of the process.

Dynamic Dosing System Parameters

The following parameters affect dynamic dosing performance:

- **Component A Flow:** Ensure that the supply pump is sized to provide sufficient and uninterrupted flow. Note that component A provides majority of system flow at higher mix ratios.
- **Component B Flow:** Ensure that the supply pump is sized to provide sufficient and uninterrupted flow.
- **Component A Pressure:** Ensure precise pressure regulation. It is recommended that the component A pressure be 5-15% **lower** than the component B pressure.
- **Component B Pressure:** Ensure precise pressure regulation. It is recommended that the component B pressure be 5-15% **higher** than the component A pressure.

NOTE: When using dynamic dosing it is very important to maintain a constant, well-regulated fluid supply. To obtain proper pressure control and minimize pump pulsation, install a fluid regulator on the A and B supply lines upstream of the meters.

Select a Component B Restrictor Size

If you cannot maintain the desired flow and spraying ratio, you may need to select a different restrictor. Use the charts on pages 61 to 65 to select an appropriate restrictor size based on the desired flow and mix ratio.

Balancing A/B Pressure

If component B pressure is too high, it will push the component A stream aside during B injection. The valve will not open long enough, causing a Ratio High error.

If component B pressure is too low, it will not be injected in sufficient volume. The valve will stay open too long, causing a Ratio Low error.

Selecting the correct component B restrictor size and balancing the A/B pressures will keep the system in the proper pressure range, resulting in a consistent mix ratio.

FIG. 50 shows the A to B pressure balance, read at the proportioner inlet. It is recommended that the component B pressure be 5-15% higher than the component A pressure to keep the system in the control range, and obtain properly mixed material. If pressures are not balanced (“B Pressure Too High” or “B Pressure Too Low”), it may not be possible to hold the desired mix ratio. The system will generate an off ratio alarm and stop operation.

NOTE: In multi-flow rate systems, it is recommended that you set up the system to run properly at the highest flow rate, to ensure adequate fluid supply across the flow rate range.

In dynamic dosing, component A dose valve is constantly on. Component B dose valve will cycle on and off; one cycle every 0.5 – 1.0 seconds indicates proper balance.

Monitor system performance by watching the pressure readings for each pump on Run Pump Control (Screen 15).

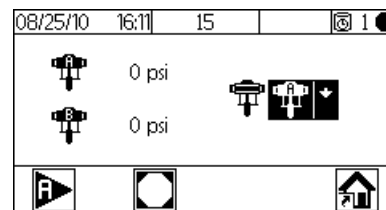

FIG. 49. Monitor Pump Pressures

Warning messages also provide information on system performance. Adjust pressures accordingly. See Table 2 on page 49.

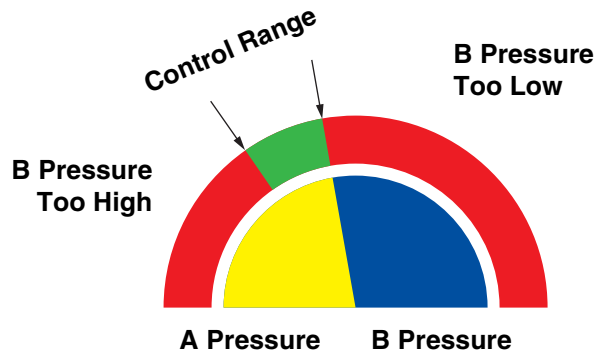
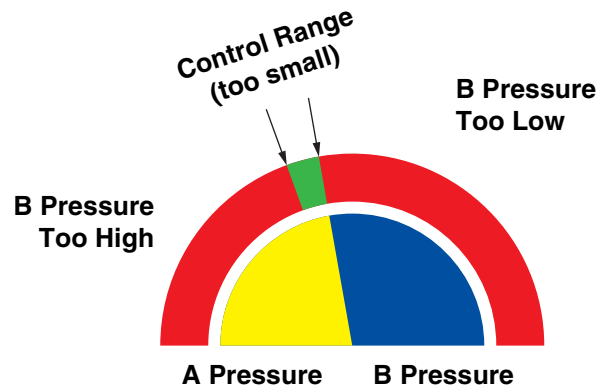

FIG. 50. A/B Control Range with Properly Sized Restrictor



NOTE: If the restrictor is too small, it may be necessary to supply more differential pressure than is available in your system.

FIG. 51. A/B Control Range with Too Large a Restrictor

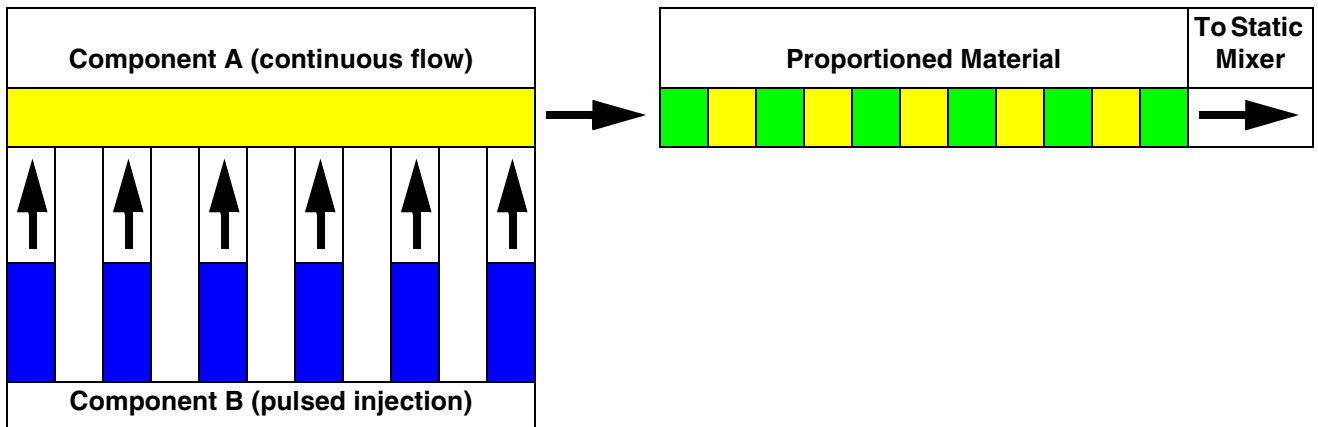

FIG. 52. Schematic Diagram of Dynamic Dosing Operation

Table 2: Dynamic Dosing Troubleshooting Guide
(for complete system troubleshooting, see Table 3 beginning on page 52)

| Error Message | Solution |
|-----------------------|---|
| Ratio Low Error (R1) | <ul style="list-style-type: none"> • Increase A pressure or decrease B pressure. • Use a smaller restrictor. |
| Ratio High Error (R4) | <ul style="list-style-type: none"> • Increase B pressure. • Clean restrictor or use a larger size. • Verify B valve is opening properly. |

System Errors

NOTE: Do not use the fluid in the line that was dispensed off ratio as it may not cure properly.

System Alarms

System alarms alert you of a problem and help prevent off-ratio spraying. If an alarm occurs, operation stops and the following occurs:

- Alarm buzzer sounds.
- Status bar on the Display Module shows the alarm code.
- Alarm is saved in the date/time stamped log.

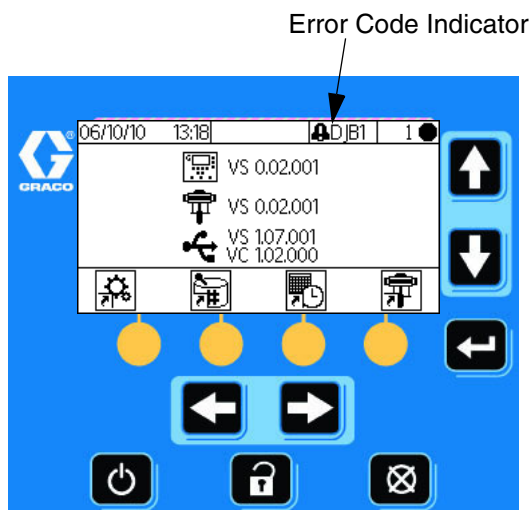

FIG. 53. Display Module Alarm Codes

System Advisory/Record Codes

TABLE 3 lists the advisory and record codes. Advisories and records do not stop operation or sound an alarm. If an advisory occurs, the Status bar on the Display Module shows the advisory icon and code. System records do not display on the Status bar. Both advisories and records are saved in the date/time stamped log, which can be viewed on the display or saved to a flash drive using optional USB port.

| # | Date | Time | Code | Icon |
|---|---------|-------|------|------------------|
| 1 | 8/25/10 | 16:02 | QTA1 | Record - no icon |
| 2 | 8/25/10 | 16:02 | QTB1 | Alarm icon |
| 3 | 8/25/10 | 14:00 | DJA1 | Alarm icon |
| 4 | 8/25/10 | 13:56 | ES | Advisory icon |
| 5 | 8/25/10 | 13:55 | P6B1 | Alarm icon |

FIG. 54. Error Log Icons

To Clear Error and Restart

NOTE: When an error occurs be sure to determine the error code before resetting it. If you forget which code occurred, use **Run Log Errors (Screens 5-14)**, page 40, to view the last 50 errors, with date and time stamps.

To reset alarms, see Table 3, and Alarm Troubleshooting, page 53. Many errors can be cleared by simply

pressing .

Air Flow Switch (AFS) Function

Air or Air-assisted Guns

The air flow switch (AFS) detects air flow to the gun and signals the ProMix 2KE controller when the gun is triggered. The gun icon on the Display Module shows spray when the AFS is activated.

If a pump fails, pure resin or catalyst could spray indefinitely if the ProMix 2KE does not detect the condition and intervene, which is why the AFS is so important.

If the ProMix 2KE detects through the AFS signal that the gun is triggered, yet one or both of the pumps are not running, a Dose Time Alarm (QTA1 or QTB1) occurs after 40 seconds and the system goes into Standby.

NOTE: Systems with a 45:1 pump ratio are designed for use with an airless gun. These systems contain no air flow switch and are set up so that they do not trigger a System Idle Warning.

NOTE: For airless applications with other pump ratios, the air flow switch can be disabled on Configure 2 (Screen 19).

System Idle Warning (IDLE)

This warning occurs if the ProMix is set to Mix , and 2 minutes have elapsed since the system last received the air flow switch signal (gun trigger). The Gun

Idle icon  is displayed. This warning is not active in systems with a 45:1 pump ratio, using an airless gun.

In applications using the AFS, triggering the gun clears the warning and you can start spraying again.

Without the AFS, triggering the gun does not clear the alarm. To start spraying again, you must press ,

then , then trigger the gun.

Error Codes

Table 3: System Alarm/Advisory/Record Codes

| Code | Description | Details |
|--|--|---------|
| Alarm Codes - Alarm sounds, system stops, icon displays until problem is solved and alarm is cleared. | | |
| CA | Communication Error | 53 |
| CAU1 | USB Communication Error | 53 |
| EQU2 | USB Installed when not in Standby | 54 |
| SG | Gun Flush Box Error | 54 |
| SAD1 SAD2 | Atomizing Air During Purge - Gun 1 Atomizing Air During Purge - Gun 2 | 54 |
| SFA1 SFB1 | PreMix Error - Color PreMix Error - Catalyst | 55 |
| SHA1 SHB1 | PreFill Error - Color PreFill Error - Catalyst | 55 |
| SM | MixFill Start Error | 55 |
| SN | MixFill Complete Error | 55 |
| QPD1 QPD2 | Potlife Error - Gun 1 Potlife Error - Gun 2 | 55 |
| R1 | Ratio Low Error | 56 |
| R4 | Ratio High Error | 57 |
| QDA1 QDB1 | Overdose A, B Dose too Short Overdose B, A Dose too Short | 57 |
| QTA1 QTB1 | Dose Time A Error Dose Time B Error | 58 |
| QLAX QLBX | Leak Error A Leak Error B | 58 |
| DJA1 DJB1 | Linear Sensor Error - Pump A Linear Sensor Error - Pump B | 58 |
| DKA1 DKB1 | Reed Switch Error - Pump A Reed Switch Error - Pump B | 58 |
| P4A1 P4B1 | Pressure High Error - Pump A Pressure High Error - Pump B | 58 |
| P6A1 P6B1 | Pressure Transducer Error - Pump A Pressure Transducer Error - Pump B | 58 |
| DDA1 DDB1 | Diving/Cavitation Error - Pump A Diving/Cavitation Error - Pump B | 59 |
| EFA1 EFB1 | Park Error - Pump A Park Error - Pump B | 59 |
| DFA1 DFB1 | Stall Up Error - Pump A Stall Up Error - Pump B | 59 |
| DGA1 DGB1 | Stall Down Error - Pump A Stall Down Error - Pump B | 59 |
| DHA1 DHB1 | No Stall Error - Pump A No Stall Error - Pump B | 59 |

Table 3: System Alarm/Advisory/Record Codes

| Code | Description | Details |
|--|--|---------|
| Advisory Codes - No alarm, system continues operating, icon displays on active screen until cleared | | |
| MAA1 | Pump A maintenance due | N/A |
| MAB1 | Pump B maintenance due | N/A |
| MEA1 | Mix valve A maintenance due | N/A |
| MEB1 | Mix valve B maintenance due | N/A |
| MESA | Solvent valve A maintenance due | N/A |
| MESB | Solvent valve B maintenance due | N/A |
| MGA1 | Fluid Filter A maintenance due | N/A |
| MGB1 | Fluid Filter B maintenance due | N/A |
| MGP1 | Air Filter maintenance due | N/A |
| ES | System defaults loaded | N/A |
| Record Codes - No alarm, system continues operating, no icon displays on active screen. | | |
| EL | System powered on | N/A |
| EC | System setup changed | N/A |
| EP | Pump park operation completed | N/A |
| ET | System performed an autodump after a potlife | N/A |
| EQU1 | USB Drive connected while in Standby | N/A |

Alarm Troubleshooting

| Alarm and Description | Cause | Solution |
|---|---|---|
| CA Communication Error The Display Module is not communicating with the Advanced Fluid Control Module. | The CAN cable between the Display Module and the Advanced Fluid Control Module is not connected. | Verify that the cable is correctly connected. |
| | The CAN cable is cut or bent. | Verify that the cable has not been cut or bent at a radius smaller than 1.6 in. (40 mm). |
| | The cable or connector failed. | Replace cable. |
| | Alternator Powered Systems: Check that the Advance Fluid Control Module (AFCM), Display Module (DM), and USB Module have power (green LED) and are communicating (amber LED blinking) | <ol style="list-style-type: none"> For any module that does not have power, disconnect and check the voltage on the cable produced by the alternator module (See Alternator Module Power Output). If the proper voltage is not detected, troubleshoot the Alternator Module. If the proper voltage is detected, verify the cable connecting the two modules is good. If the cable is good, replace the module. |
| | There may be a short in one of the solenoid/meter cables connected to the AFCM. | Replace the cable (16E890) |
| | The AFCM power supply may be bad, as indicated by the status LEDs (red, yellow, green) being off. Verify the power supply works by disconnecting from the AFCM and connecting to another module, either the Display Module or USB Module. | Replace the module. |
| | The DM and the AFCM have different versions of software installed. | Install the latest software from token kit 16D922 on all modules. |
| | The red LED on the AFCM is on. | If on solid, replace module. If blinking, contact your distributor. |
| | NOTE: <ol style="list-style-type: none"> If the AFCM loses communication (no flickering amber LED) but then comes back on the alarm will auto clear and will not log the alarm. If the DM loses communication (no flickering amber LED) but then comes back on you will have to manually clear the alarm and there will be an alarm log. If the USB module loses communication (no flickering amber LED) but then comes back on you will not get an alarm. | |
| CAU1 USB Communication Error The system detected a USB Module at last power up, but does not detect it currently. | The module has been removed. | Put system in standby and install the USB Module. |
| | The cable is disconnected or broken. | Put system in standby and reconnect or replace the USB cable. |

| Alarm and Description | Cause | Solution |
|--|--|---|
| <p>EQU2 USB Drive Error The USB drive has been inserted when the system is not in Standby.</p> | <p>Most USB drives do not conform to IS standards, so it is hazardous to use one while the system is running.</p> | <p>Put system in Standby. Insert the USB drive only in a non-hazardous environment.</p> |
| <p>SG Gun Flush Box Error A gun flush box is enabled, but the system does not detect a gun in the gun flush box during purge, color change, or auto-dump.</p> | <p>The cover of the gun flush box is not closed.</p> <p>For systems with a gun flush box, the gun is not in the box when purge is active.</p> <div style="border: 1px solid black; background-color: #0000FF; color: white; text-align: center; padding: 2px;">NOTICE</div> <p>To prevent mixed material from curing in the equipment, do not shut off power. Follow one of the solutions at right.</p> | <p>Close the cover and clear the alarm.</p> <p>Purge the system with solvent or fresh mixed material:</p> <ul style="list-style-type: none"> • Solvent Purge - See Purging Mixed Material on page 33. The system purges until the preset purge time is complete. • New Mixed Material Purge - Go to Mix mode and spray the required volume to restart the potlife timer. |
| <p>SAD1 or SAD2 Atomizing Air During Purge Atomizing air to Gun 1 (SAD1) or Gun 2 (SAD2) is detected when purge is selected or during purge sequence.</p> | <p>Atomizing air is stuck on.</p> | <p>Replace air flow switch.</p> |
| | <p>Gun is not in Gun Flush Box.</p> | <p>Insert the gun into the Gun Flush Box.</p> |
| | <p>Gun Flush Box air shutoff is not working.</p> | <p>Test using Troubleshooting Screens. See page 46. Repair/replace air shutoff valve as needed.</p> |
| | <p>Air leak in atomizing air line.</p> | <p>Inspect air line for kinks, damage, or loose connections. Repair or replace as needed.</p> |

| Alarm and Description | Cause | Solution |
|--|--|--|
| SFA1 or SFB1 PreMix Error In systems with a gun flush box, insufficient quantity of resin/color (SFA1) or catalyst (SFB1) is detected during the 10-second PreMix sequence. SHA1 or SHB1 PreFill Error Total PreFill sequence volume is not reached for color (SHA1) or catalyst (SHB1) during the 5-minute PreFill sequence. | Gun, line, or valve is plugged or stuck. | Check components and clean, repair, or replace as necessary. |
| | Pump(s) not working or out of fluid. | Refill fluid supply. Check and repair pump. See pump manual for repair procedures and replacement parts. |
| | Air lines or solenoids are plumbed incorrectly or solenoids are not working. | Check air line path. See System Pneumatic Schematic , page 66 or 67. Verify that solenoid is working. |
| | Flow rate is too low. | Increase fluid pressure. |
| SM MixFill Start Error In systems with a gun flush box, insufficient volume of mixed material is detected during the 10-second mixed fill sequence. SN MixFill Complete Error Insufficient volume of mixed material is detected during the 5-minute mixed fill sequence. | Gun Flush Box is not triggering gun. | Verify trigger is being pulled. Adjust as needed. |
| | Line or gun is plugged or restricted. | Clean line, tip, or filter. |
| | Flow rate is too low. | Increase fluid pressure or decrease restriction. |
| | Valve is stuck. | Clean valve or verify that solenoid is triggering valve properly. |
| QPD1 or QPD2 Potlife Error Potlife has been exceeded for the mixed material for Gun 1 (QPD1) or Gun 2 (QPD2). | Have not sprayed enough volume to keep fresh mixed fluid in the mix manifold, hose, and gun. | Purge the mixed material line. See page 33. Check that hose length and diameter have been entered correctly. See Configure 2 (Screen 19) , page 43. Spray the required volume to restart the potlife timer. |

| Alarm and Description | Cause | Solution |
|--|---|--|
| <p>R1 Ratio Low Error The mix ratio is lower than the set tolerance for an A to B component volume comparison.</p> | <p>There is too much restriction in the system.</p> | <ul style="list-style-type: none"> • Check that the system is fully loaded with material. • Check that the supply pump's cycle rate is set properly. • Check that the spray tip/nozzle is properly sized for the flow and application, and that it is not clogged. • Check that the fluid regulator is set properly. |
| | <p>If the alarm occurs during start up, after purging, the flow rate was probably too high.</p> | <p>Restrict gun needle travel to slow down the initial fluid delivery rate until fluid hoses are loaded with material.</p> |
| | <p>If the alarm occurred after you were spraying for some time, the pressures from the fluid supplies could be unbalanced.</p> | <p>Adjust component A and B fluid supply regulator pressures until they are about equal. <i>If the pressures are already about equal</i>, verify that component A and B dose valves are operating properly.</p> |
| | <p>Slow actuation of the component A or B valves. This can be caused by:</p> | <p>Manually operate the Dose Valve A and B solenoid valves as instructed in the ProMix 2KE Repair-Parts manual to check operation.</p> |
| | <ul style="list-style-type: none"> • Air pressure to the valve actuators is too low. | <ul style="list-style-type: none"> • Increase air pressure. Air pressure must be 75-120 psi (0.52-0.84 MPa, 5.2-8.4 bar); 120 psi is recommended. |
| | <ul style="list-style-type: none"> • Something is restricting the solenoid or tubing and interrupting valve actuation air. | <ul style="list-style-type: none"> • There may be dirt or moisture in the air supply. Filter appropriately. Verify that solenoids are operational. |
| | <ul style="list-style-type: none"> • Dose Valve B is turned in too far. Dose Valve A is open too far. | <ul style="list-style-type: none"> • Refer to Valve Settings, page 35, for adjustment guidelines. |
| | <ul style="list-style-type: none"> • Fluid pressure is high and air pressure is low. | <ul style="list-style-type: none"> • Adjust air and fluid pressure. See recommended air pressure above. |

| Alarm and Description | Cause | Solution |
|---|---|---|
| <p>R4 Ratio High Error The mix ratio is higher than the set tolerance for an A to B component volume comparison.</p> | There is too little restriction in the system. | <ul style="list-style-type: none"> • Check that the system is fully loaded with material. • Check that the supply pump's cycle rate is set properly. • Check that the spray tip/nozzle is properly sized for the flow and application, and that it is not worn. • Check that the fluid regulator is set properly. |
| | If the alarm occurs during start up, after purging, the flow rate was probably too high. | Restrict gun needle travel to slow down the initial fluid delivery rate until fluid hoses are loaded with material. |
| | If the alarm occurred after you were spraying for some time, the pressures from the fluid supplies could be unbalanced. | Adjust component A and B fluid supply regulator pressures until they are about equal. <i>If the pressures are already about equal</i> , verify that component A and B dose valves are operating properly. |
| | Slow actuation of the component A or B valves. This can be caused by: | Manually operate the Dose Valve A and B solenoid valves to check operation. |
| | <ul style="list-style-type: none"> • Air pressure to the valve actuators is too low. | <ul style="list-style-type: none"> • Increase air pressure. Air pressure must be 75-120 psi (0.52-0.84 MPa, 5.2-8.4 bar); 120 psi is recommended. |
| | <ul style="list-style-type: none"> • Something is restricting the solenoid or tubing and interrupting valve actuation air. | <ul style="list-style-type: none"> • There may be dirt or moisture in the air supply. Filter appropriately. |
| | <ul style="list-style-type: none"> • Dose Valve B is turned in too far. Dose Valve A is open too far. • Fluid pressure is high and air pressure is low. | <ul style="list-style-type: none"> • Refer to Valve Settings, page 35, for adjustment guidelines. • Adjust air and fluid pressure. See recommended air pressure above. |
| <p>QDA1 Overdose A The A dose has overshot and, when combined with B, is too large for the mix manifold capacity.</p> <p>QDB1 Overdose B The B dose has overshot, forcing an A dose that, when combined with B, is too large for the mix manifold capacity.</p> | Valve seal or needle/seat are leaking. | Repair the valve. |
| | Slow actuation of component A or B valves. | See Ratio Low Error and Ratio High Error , pages 56-57. |
| | Running a high mix ratio and a high flow rate. | It may be necessary to restrict the flow rate through the component B dose valve by adjusting its hex nut. |

| Alarm and Description | Cause | Solution |
|--|---|--|
| QTA1 or QTB1 Dose Time Error The gun trigger is active, but no A pump (QTA1) or B pump (QTB1) movement is detected during the dose time selected. | System is in Mix mode and gun is only partially triggered, allowing air but no fluid to pass through gun. | Fully trigger the gun. |
| | Fluid flow rate is too low. | Increase flow rate. |
| | Slow actuation of component A or B valves. | See Ratio Low Error and Ratio High Error , pages 56-57. |
| | A or B pump has no air pressure. | Verify that main air supply is turned on and valves are open. |
| | There is an air leak downstream from the air flow switch. | Check the air lines for leaks and repair. |
| | The air flow switch is stuck open. | Clean or replace air flow switch. |
| QLAX or QLBX Leak Error Pump A (QLAX) or Pump B (QLBX) is running with all valves closed. | A or B dose valve leak | Replace valve needle and seat. |
| | A or B pump is not seating and continues to move/creep. | Replace pump packings, balls, and seats. |
| DJA1 or DJB1 Linear Sensor Error System does not detect the pump A (DJA1) or pump B (DJB1) linear position sensor, or has an invalid position reading. | Sensor not recognized by system. | Verify that sensor is plugged in. Verify that sensor and AFCM are operational. Verify cable connections. Replace any malfunctioning component. |
| | Magnet fell off. | Replace magnet and holder on top side of air motor piston. |
| | Sensor readings are out of range. | Verify that the sensor is threaded down completely. |
| DKA1 or DKB1 Reed Switch Error System does not detect the pump A (DKA1) or Pump B (DKB1) reed switch sensor, or detects an invalid state. | Reed switch installed backward. | Flip reed switch 180 degrees to align with magnet in air valve. |
| | Reed switches are stuck, or both reed switches are on at once | Verify cable is connected on both ends. Verify that reed switch, cable, and AFCM are operational. Replace any malfunctioning component. |
| | Magnet in air valve not functioning properly. | Verify that magnet is installed properly and is operational. |
| P4A1 or P4B1 Pressure High Error System detects a high pressure reading on pump A (P4A1) or pump B (P4B1). | Pump air pressure is set too high. | Reduce pressure on air supply to system or pumps. |
| | Thermal expansion occurring in lines. | Relieve pressure if system has been idle. Decrease environmental temperature. |
| | Pressure transducer malfunction. | Replace transducer. Verify that cable and AFCM are operational. |
| P6A1 or P6B1 Pressure Transducer Error System does not detect pressure transducer A (P6A1) or pressure transducer B (P6B1). | Pressure transducer malfunction. | Replace transducer. Verify that cable and AFCM are operational. |

| Alarm and Description | Cause | Solution |
|--|--|---|
| DDA1 or DDB1 Diving/Cavitation Error Pump A (DDA1) or Pump B (DDB1) is diving or cavitating. | Fluid supply is empty. | Refill fluid supply system. |
| | Displacement pump is not seating properly. | Rebuild displacement pump and replace packings, balls, and seats. |
| | Air in fluid supply system. | Tighten all fittings. |
| EFA1 or EFB1 Park Error Pump A (EFA1) or Pump B (EFB1) does not park (does not reach bottom change-over). | Gun not open. | Trigger gun and allow fluid to flow while pump is attempting to park. |
| | Fluid lines plugged. | Check and clear all fluid lines, gun tip, and the mix manifold. |
| | Dispense valve malfunction. | Clean or rebuild dispense valve. Verify that solenoid is operational. Clear air lines to valve. |
| DFA1 or DFB1 Stall Up Error Pump A (DFA1) or Pump B (DFB1) does not stall up during the pump calibration and stall test (keeps moving up when dosing valve is closed). | Displacement pump is not seating properly. | Rebuild displacement pump and replace packings, balls, and seats. |
| | Dispense valve not seating/sealing. | Replace needle/seat on dispense valve. |
| DGA1 or DGB1 Stall Down Error Pump A (DGA1) or Pump B (DGB1) does not stall down during the pump calibration and stall test (keeps moving down when dosing valve is closed). | Displacement pump is not seating properly. | Rebuild displacement pump and replace packings, balls, and seats. |
| | Dispense valve not seating/sealing. | Replace needle/seat on dispense valve. |
| DHA1 or DHB1 No Stall Error Pump A (DHA1) or Pump B (DHB1) does not stall in either direction during the pump calibration and stall test (keeps moving when dosing valve is closed). | Displacement pump is not seating properly. | Rebuild displacement pump and replace packings, balls, and seats. |
| | Dispense valve not seating/sealing. | Replace needle/seat on dispense valve. |

Dynamic Dosing Restrictor Selection Graphs

Use the graphs on pages 61- 65 as a guide to determine the correct restrictor size for your desired flow and material viscosity. Table 4 lists the available restrictor sizes.

Example:

Application: air spray system with a 5:1 mix ratio

Fluid Supply: 1:1 pumps at 100 psi (7 bar, 0.7 MPa)

Flow Rate: 300 cc/min at the gun

Select the Restrictor Size: choose either the 0.040 or 0.070 orifice, to ensure that the pressure differential is not more than 10-20 psi (0.7-1.4 bar, 0.07-0.14 MPa), provided the fluid viscosities are similar to those tested.

- If the viscosity of component B is lower than the viscosity of the chart used for selection you may need to use a smaller restrictor or decrease the pressure differential.
- If the viscosity of component B is higher than the viscosity of the chart used for selection you may need to use a larger restrictor or increase the pressure differential.
- In systems using an air-assisted gun, if the fluid pressure of component A is higher than the component A pressure from the charts you may need to use a larger restrictor or increase the pressure differential.

Table 4: Restrictor Sizes

| Size Code | Orifice Size | Part No. |
|-----------|--------------|----------|
| 2* | 0.020 | 15U936 |
| 3* | 0.030 | 15U937 |
| 4* | 0.040 | 15U938 |
| 5✓ | 0.050 | 15U939 |
| 6✓ | 0.060 | 15U940 |
| 7* | 0.070 | 15U941 |
| 8✓ | 0.080 | 16D554 |

* These restrictors are included in Injection Kit 15U955.

✓ These restrictors are optional sizes, not included in the Injection Kit.

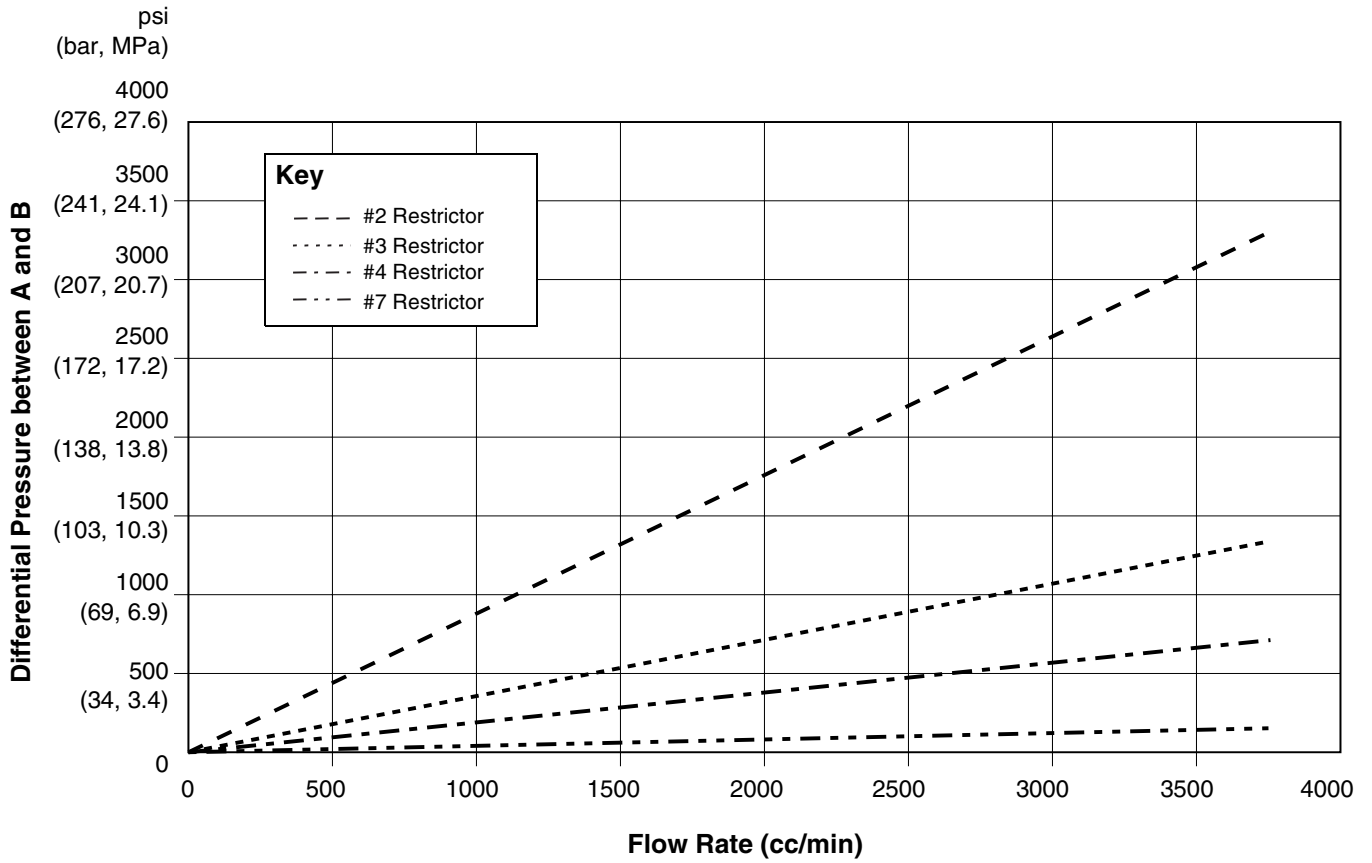

Detail View

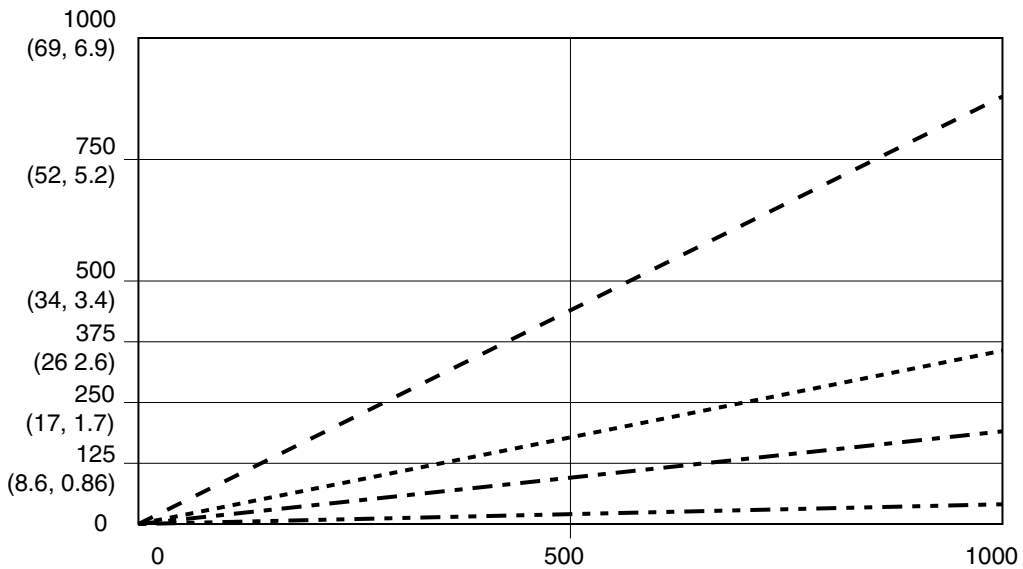
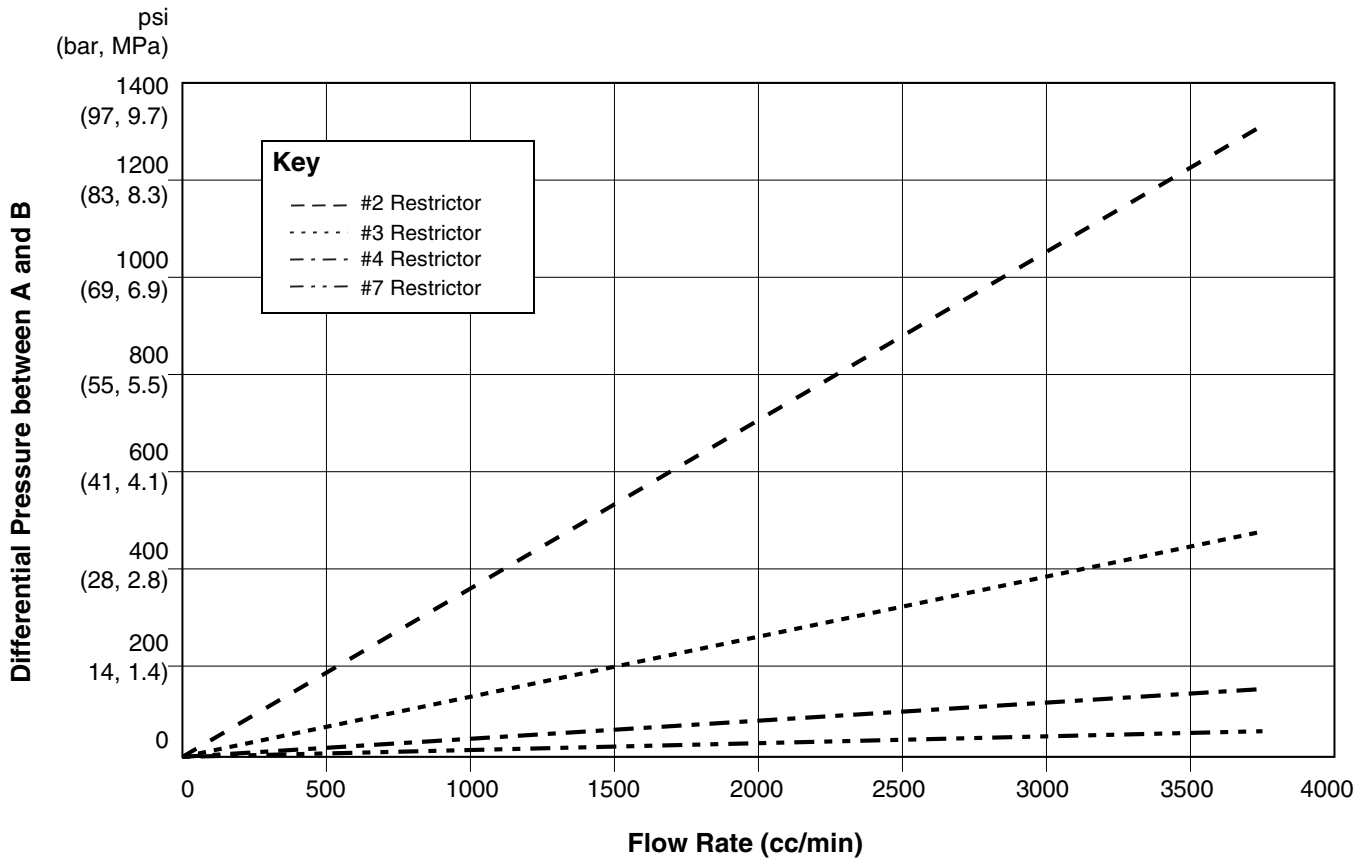

FIG. 55. Dynamic Dosing Performance (1:1 Ratio, 90 centipoise fluid, 100 psi A side pressure)



Detail View

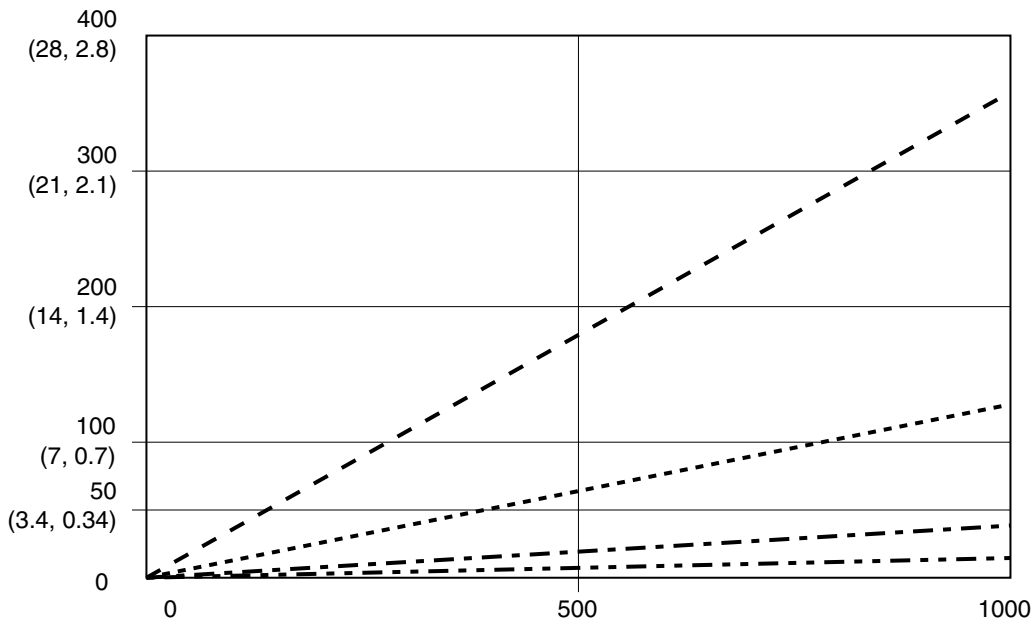
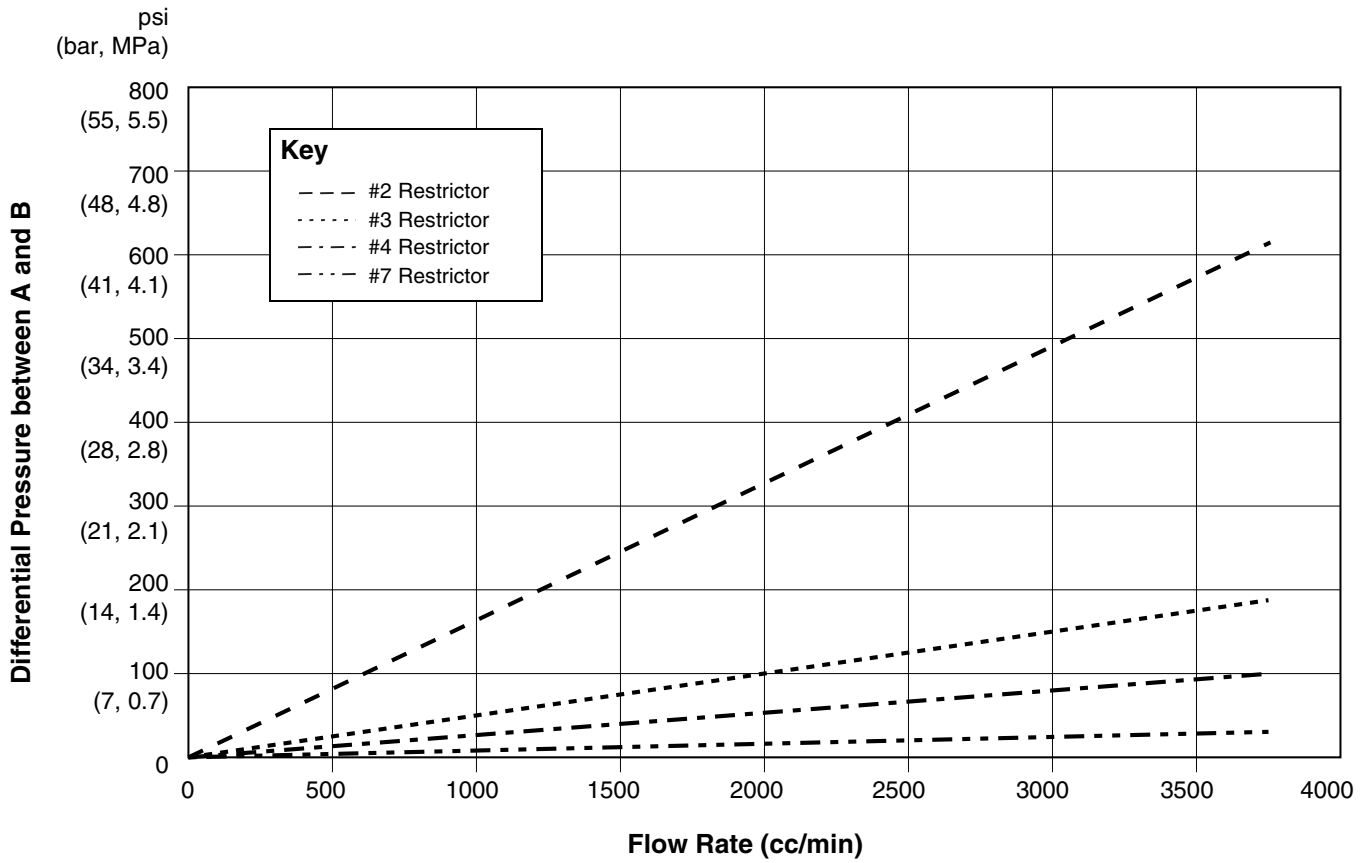

FIG. 56. Dynamic Dosing Performance (5:1 Ratio, 90 centipoise fluid, 100 psi A side pressure)



Detail View

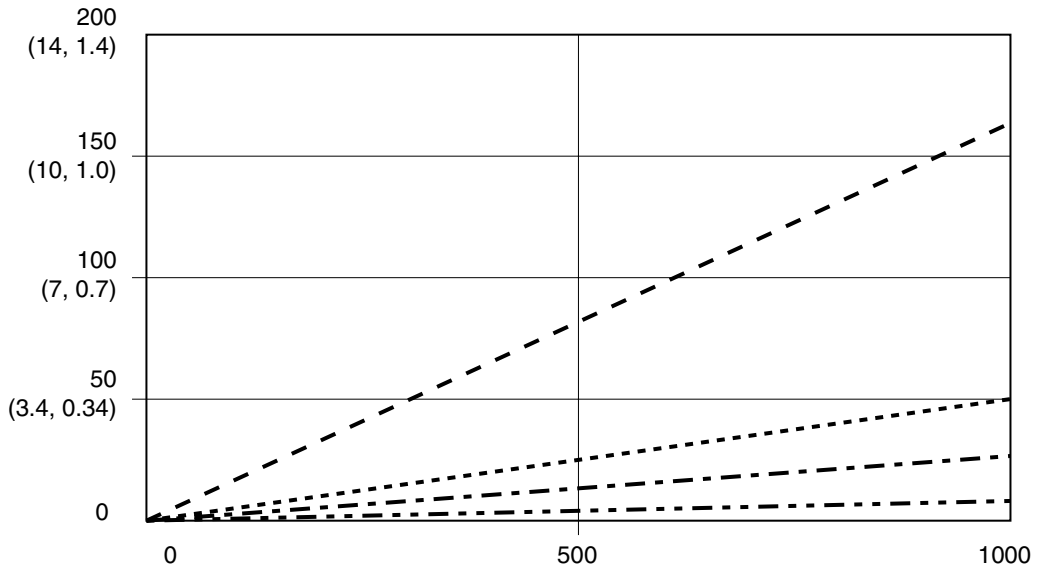
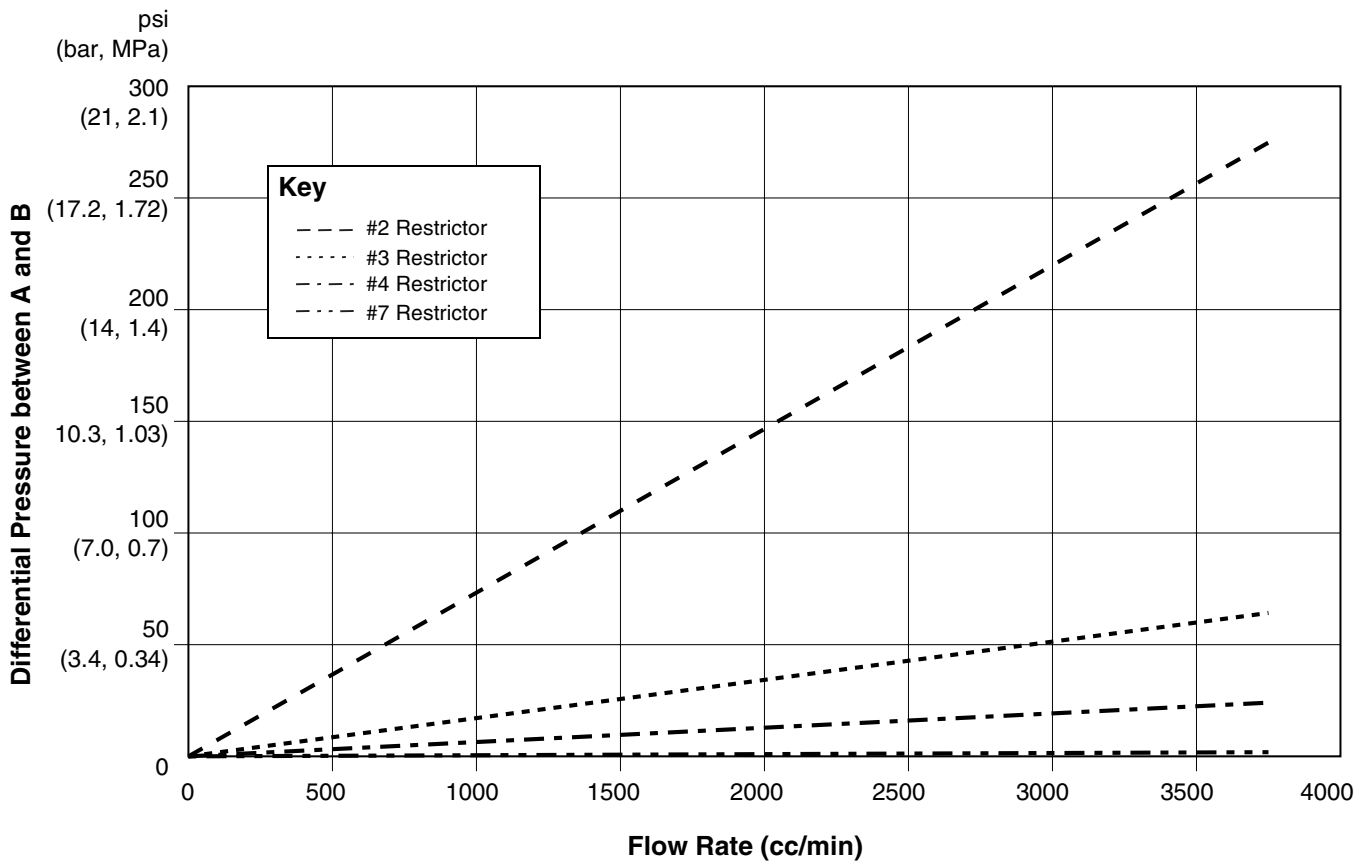

FIG. 57. Dynamic Dosing Performance (10:1 Ratio, 90 centipoise fluid, 100 psi A side pressure)



Detail View

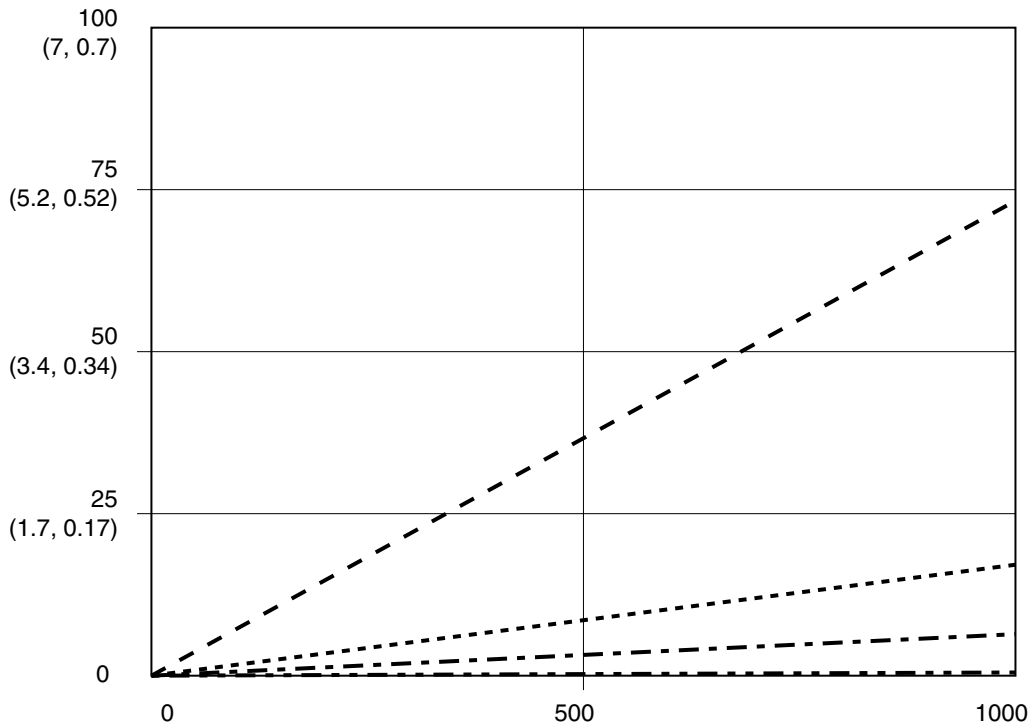
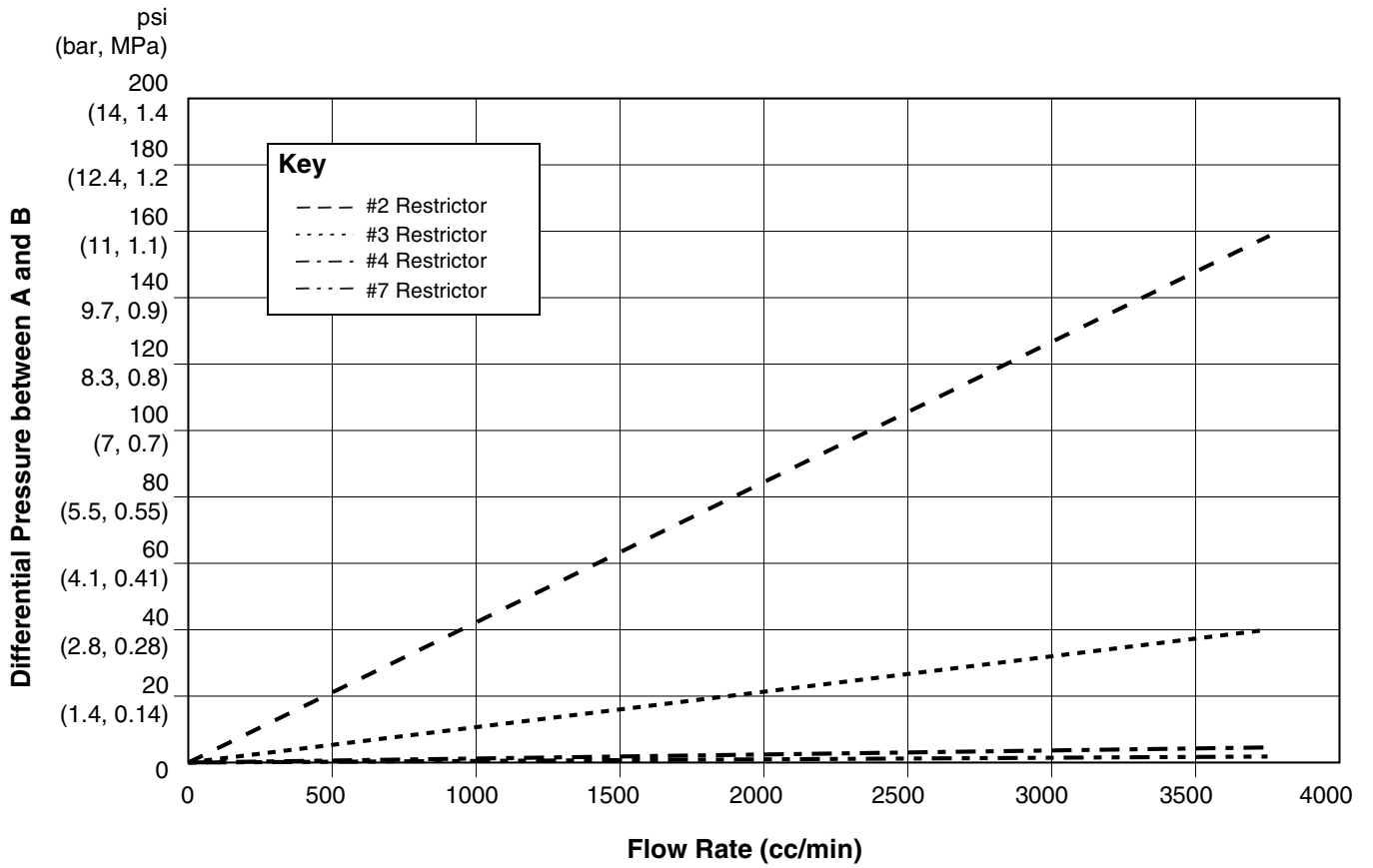

FIG. 58. Dynamic Dosing Performance (20:1 Ratio, 90 centipoise fluid, 100 psi A side pressure)



Detail View

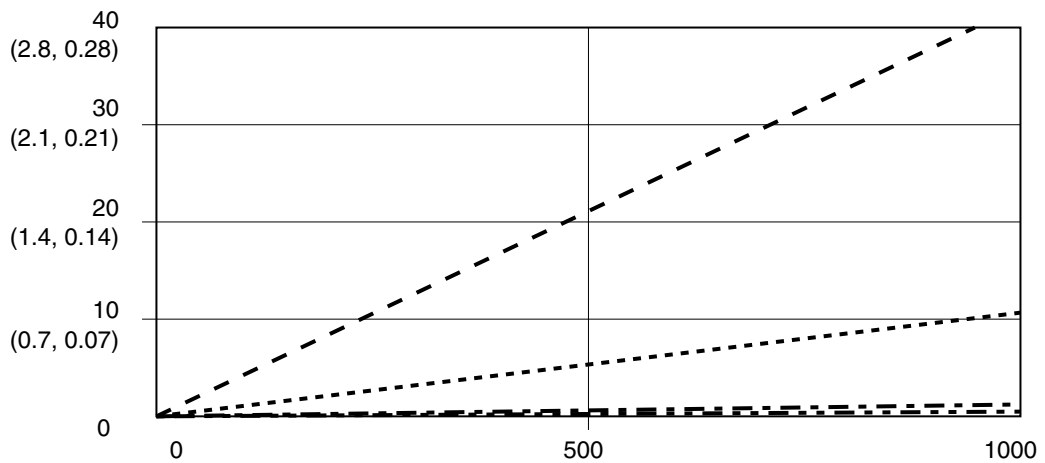
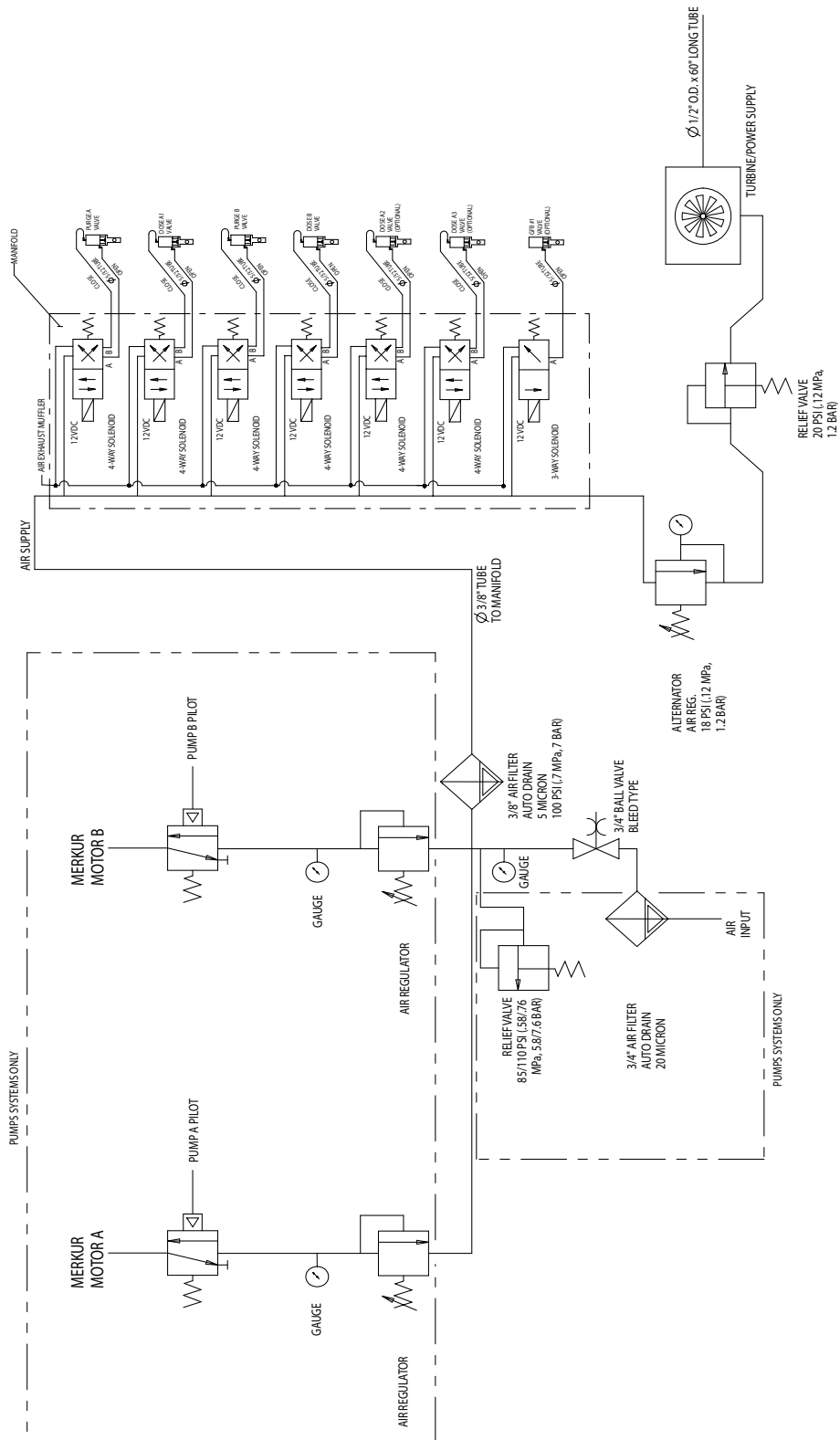

FIG. 59. Dynamic Dosing Performance (30:1 Ratio, 90 centipoise fluid, 100 psi A side pressure)

Schematics

Hazardous Location System Pneumatic Schematic



Non-Hazardous Location Pneumatic Schematic

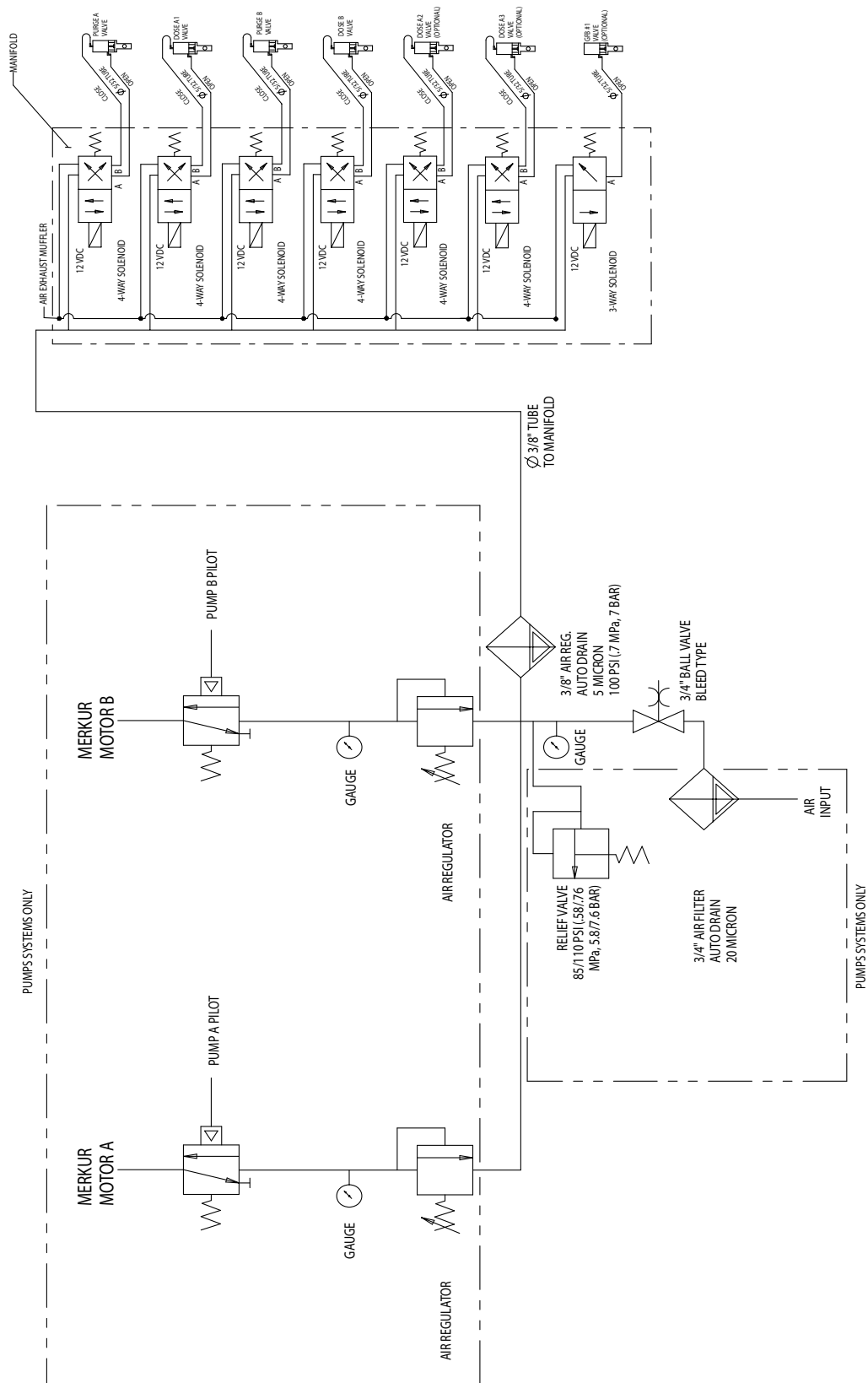

Hazardous Location Electrical Schematic

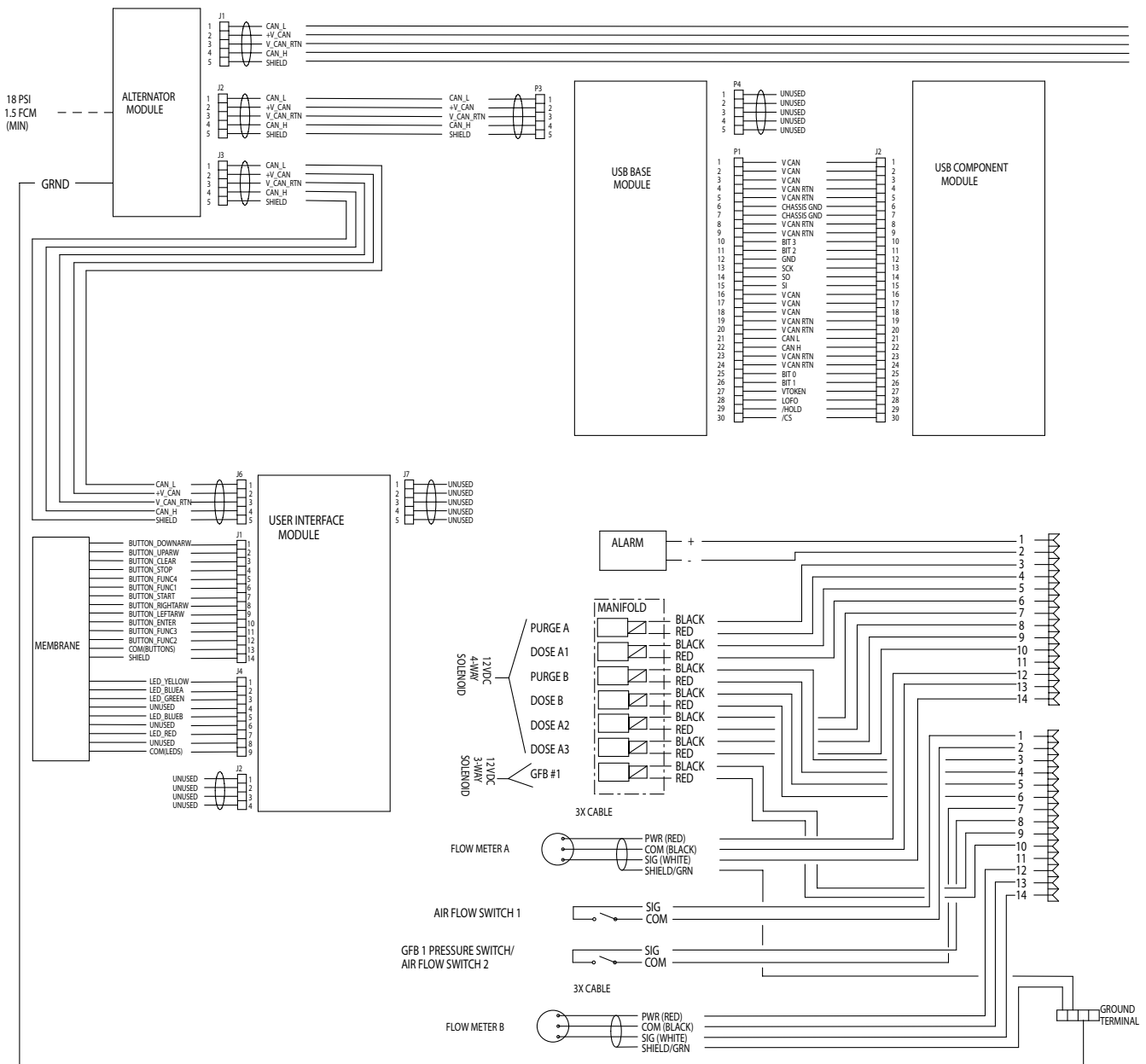

Hazardous Location Electrical Schematic (continued)

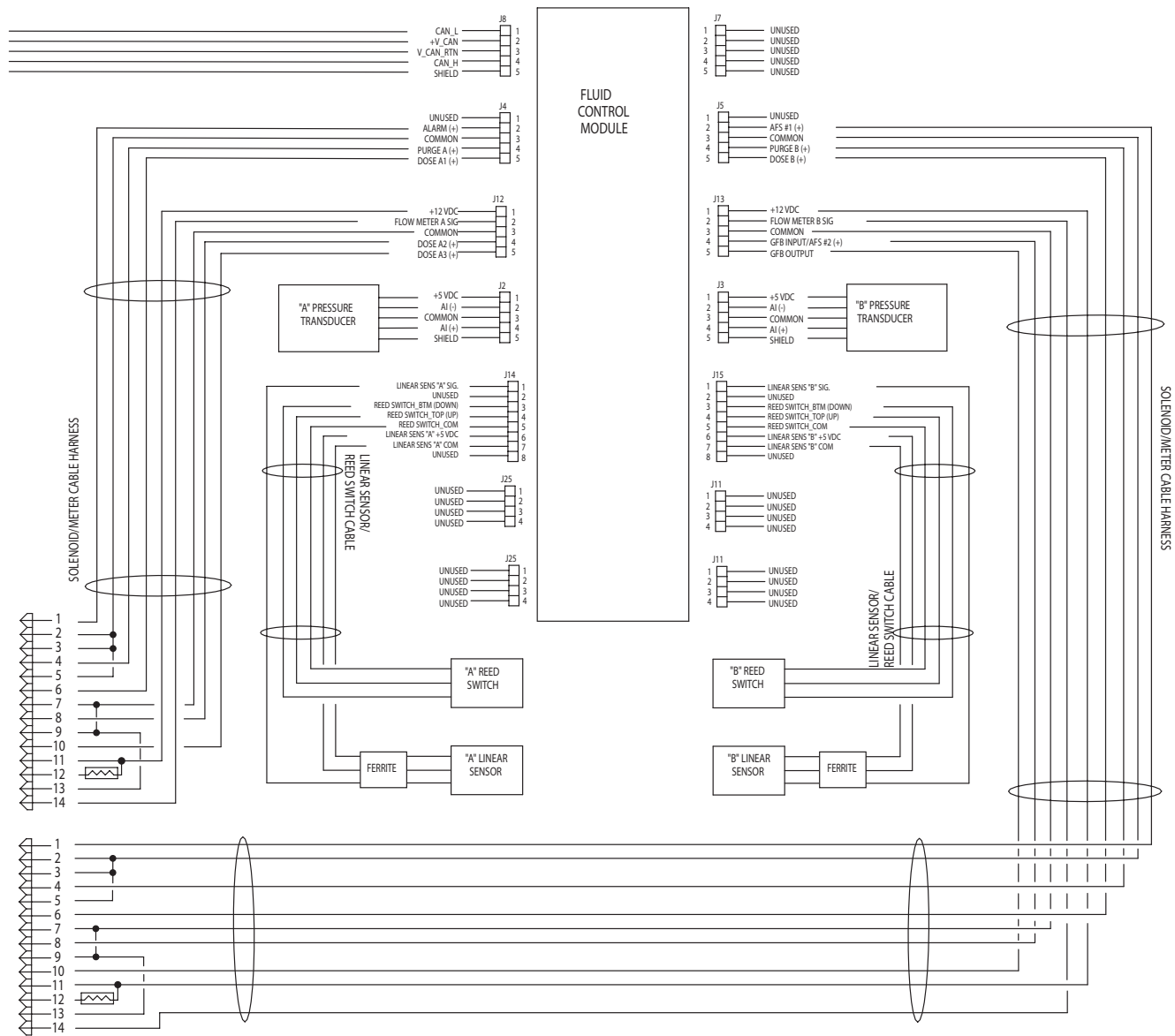

Non-Hazardous Location Electrical Schematic

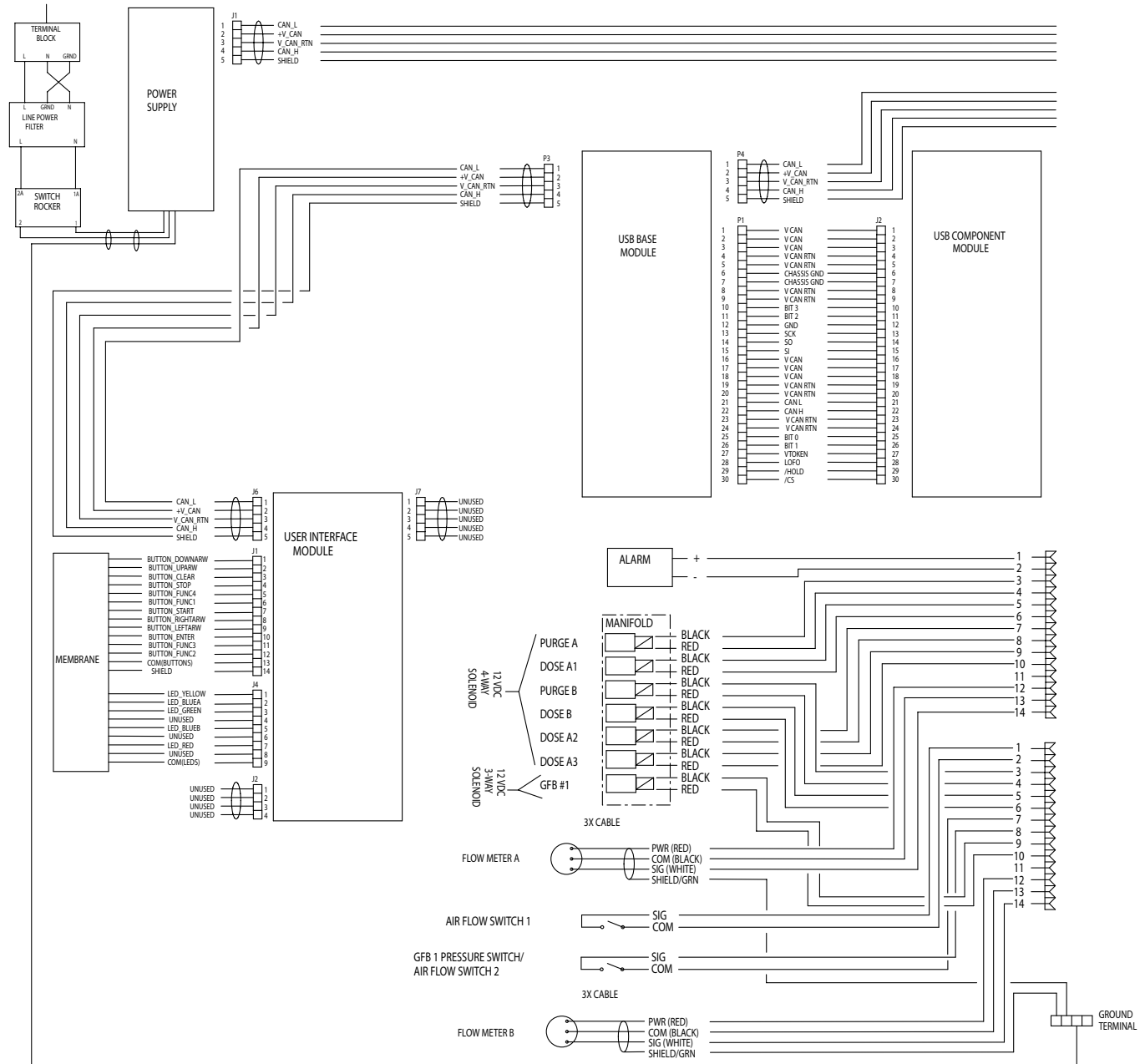

Non-Hazardous Electrical Schematic (continued)

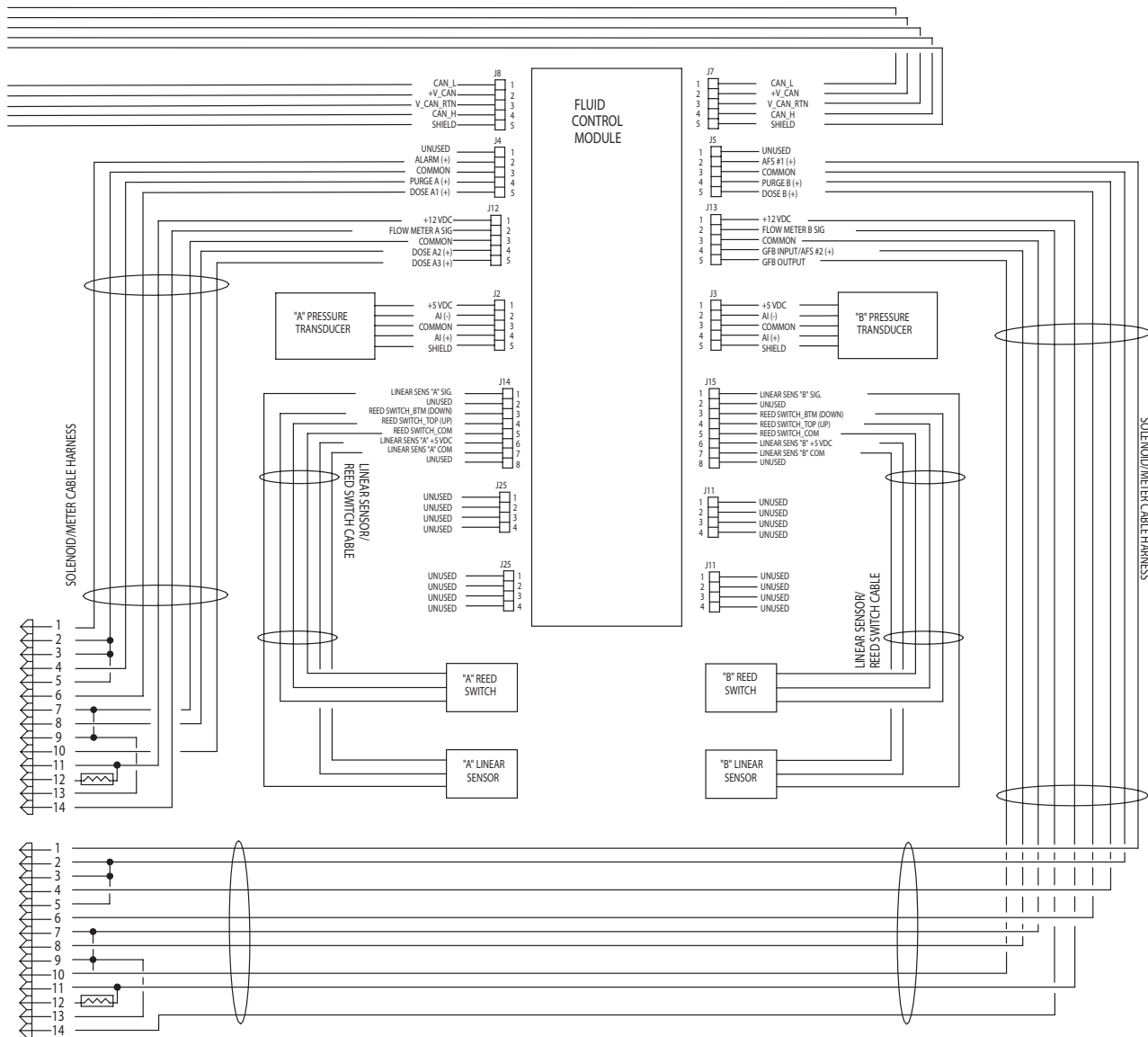

Dimensions and Mounting

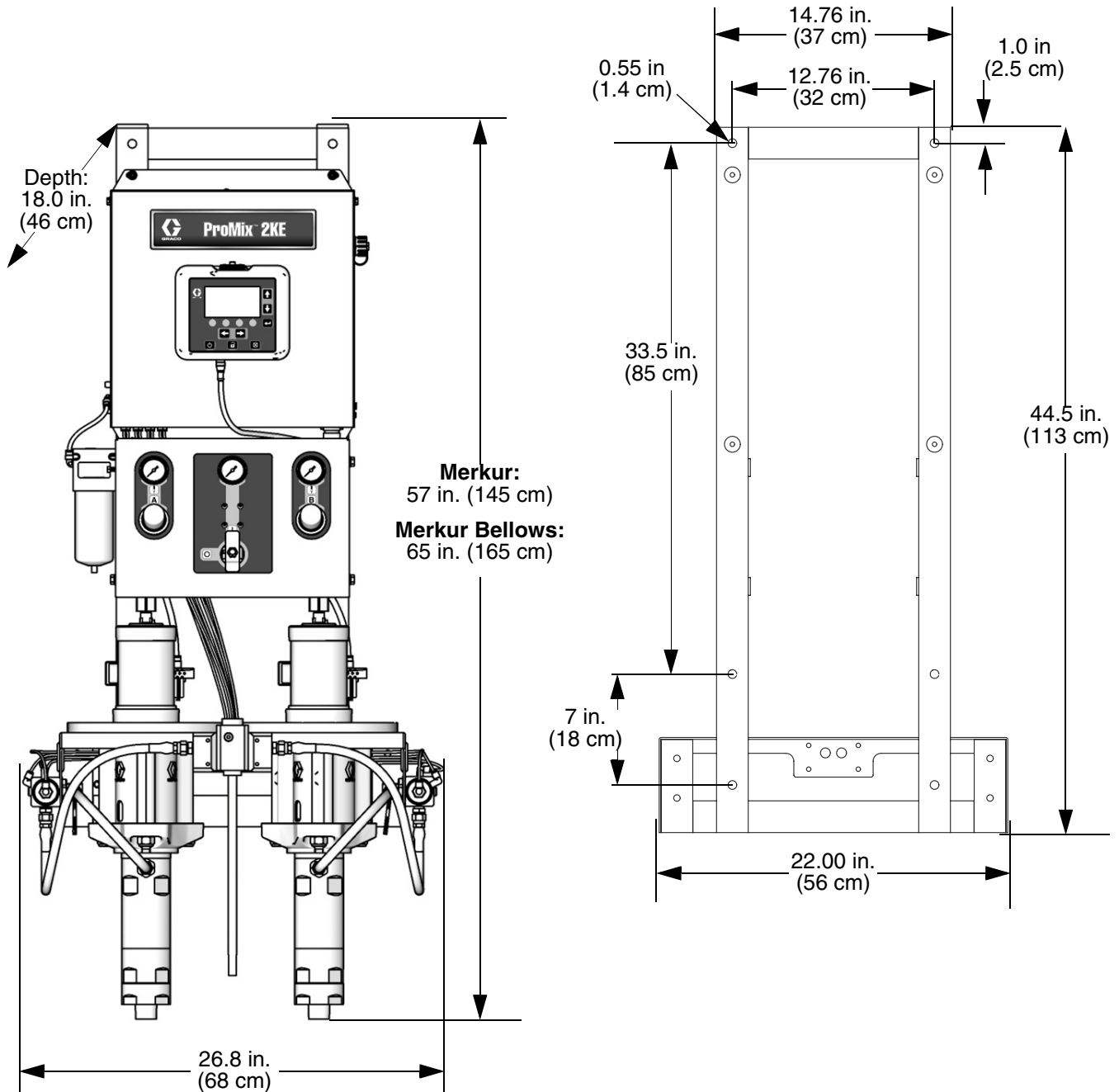

Technical Data

| ProMix 2KE | | |
|--|---|------------------------------|
| | US | Metric |
| Maximum fluid working pressure | See Models , pages 3 and 4. | |
| Maximum working air pressure | 100 psi | 0.7 MPa, 7 bar |
| Air supply | 75 to 100 psi | 0.5 to 0.7 MPa, 5.2 to 7 bar |
| Air filter inlet size | 3/8 npt(f) | |
| Air filtration for air logic (Graco-supplied) | 5 micron (minimum) filtration required; clean and dry air | |
| Air filtration for atomizing air (user-supplied) | 30 micron (minimum) filtration required; clean and dry air | |
| Mixing ratio range | 0.1:1 to 30:1 | |
| Viscosity range of fluid | 20 to 5000 cps | |
| Fluid filtration (user-supplied) | 100 mesh minimum | |
| Fluid outlet size (static mixer) | 1/4 npt(f) | |
| External power supply requirements | 85 - 250 Vac, 50/60 Hz, 2 amps maximum draw 15 amp maximum circuit breaker required 8 to 14 AWG power supply wire gauge | |
| Operating temperature range | 41° to 122°F | 5° to 50°C |
| Approximate weight | 300 lb | 136 kg |
| Environmental conditions rating | indoor use, pollution degree (2), installation category II | |
| Fluids handled | one or two component: <ul style="list-style-type: none"> • solvent and waterborne paints • polyurethanes • epoxies • acid catalyzed varnishes • moisture sensitive isocyanates | |
| On-ratio accuracy | | |
| 1:1 to 10:1 Mixing Ratio | ± 2% | |
| 10.1:1 to 30:1 Mixing Ratio | ± 5% | |
| Noise level | | |
| Sound pressure level | below 70 dBA | |
| Sound power level | Below 85 dBA | |
| Materials of construction | | |
| Wetted materials on all models | 303, 304 SST; Tungsten carbide (with nickel binder); perfluoroelastomer; PTFE | |

Graco Standard Warranty

Graco warrants all equipment referenced in this document which is manufactured by Graco and bearing its name to be free from defects in material and workmanship on the date of sale to the original purchaser for use. With the exception of any special, extended, or limited warranty published by Graco, Graco will, for a period of twelve months from the date of sale, repair or replace any part of the equipment determined by Graco to be defective. This warranty applies only when the equipment is installed, operated and maintained in accordance with Graco's written recommendations.

This warranty does not cover, and Graco shall not be liable for general wear and tear, or any malfunction, damage or wear caused by faulty installation, misapplication, abrasion, corrosion, inadequate or improper maintenance, negligence, accident, tampering, or substitution of non-Graco component parts. Nor shall Graco be liable for malfunction, damage or wear caused by the incompatibility of Graco equipment with structures, accessories, equipment or materials not supplied by Graco, or the improper design, manufacture, installation, operation or maintenance of structures, accessories, equipment or materials not supplied by Graco.

This warranty is conditioned upon the prepaid return of the equipment claimed to be defective to an authorized Graco distributor for verification of the claimed defect. If the claimed defect is verified, Graco will repair or replace free of charge any defective parts. The equipment will be returned to the original purchaser transportation prepaid. If inspection of the equipment does not disclose any defect in material or workmanship, repairs will be made at a reasonable charge, which charges may include the costs of parts, labor, and transportation.

THIS WARRANTY IS EXCLUSIVE, AND IS IN LIEU OF ANY OTHER WARRANTIES, EXPRESS OR IMPLIED, INCLUDING BUT NOT LIMITED TO WARRANTY OF MERCHANTABILITY OR WARRANTY OF FITNESS FOR A PARTICULAR PURPOSE.

Graco's sole obligation and buyer's sole remedy for any breach of warranty shall be as set forth above. The buyer agrees that no other remedy (including, but not limited to, incidental or consequential damages for lost profits, lost sales, injury to person or property, or any other incidental or consequential loss) shall be available. Any action for breach of warranty must be brought within two (2) years of the date of sale.

GRACO MAKES NO WARRANTY, AND DISCLAIMS ALL IMPLIED WARRANTIES OF MERCHANTABILITY AND FITNESS FOR A PARTICULAR PURPOSE, IN CONNECTION WITH ACCESSORIES, EQUIPMENT, MATERIALS OR COMPONENTS SOLD BUT NOT MANUFACTURED BY GRACO. These items sold, but not manufactured by Graco (such as electric motors, switches, hose, etc.), are subject to the warranty, if any, of their manufacturer. Graco will provide purchaser with reasonable assistance in making any claim for breach of these warranties.

In no event will Graco be liable for indirect, incidental, special or consequential damages resulting from Graco supplying equipment hereunder, or the furnishing, performance, or use of any products or other goods sold hereto, whether due to a breach of contract, breach of warranty, the negligence of Graco, or otherwise.

FOR GRACO CANADA CUSTOMERS

The Parties acknowledge that they have required that the present document, as well as all documents, notices and legal proceedings entered into, given or instituted pursuant hereto or relating directly or indirectly hereto, be drawn up in English. Les parties reconnaissent avoir convenu que la rédaction du présente document sera en Anglais, ainsi que tous documents, avis et procédures judiciaires exécutés, donnés ou intentés, à la suite de ou en rapport, directement ou indirectement, avec les procédures concernées.

Graco Information

For the latest information about Graco products, visit www.graco.com.

For patent information, see www.graco.com/patents.

TO PLACE AN ORDER, contact your Graco distributor or call to identify the nearest distributor.

Phone: 612-623-6921 **or Toll Free:** 1-800-328-0211 **Fax:** 612-378-3505

All written and visual data contained in this document reflects the latest product information available at the time of publication. Graco reserves the right to make changes at any time without notice.

Original instructions. This manual contains English. MM 3A0868

Graco Headquarters: Minneapolis

International Offices: Belgium, China, Japan, Korea

GRACO INC. AND SUBSIDIARIES • P.O. BOX 1441 • MINNEAPOLIS MN 55440-1441 • USA

Copyright 2010, Graco Inc. All Graco manufacturing locations are registered to ISO 9001.

www.graco.com

Revision G, June 2014

Free Manuals Download Website

<http://myh66.com>

<http://usermanuals.us>

<http://www.somanuals.com>

<http://www.4manuals.cc>

<http://www.manual-lib.com>

<http://www.404manual.com>

<http://www.luxmanual.com>

<http://aubethermostatmanual.com>

Golf course search by state

<http://golfingnear.com>

Email search by domain

<http://emailbydomain.com>

Auto manuals search

<http://auto.somanuals.com>

TV manuals search

<http://tv.somanuals.com>