

2.5 and 5.0 Gallon Pressure Tank

309926G

- Not for use with highly abrasive, corrosive, or rust inducing materials -

Model	Capacity	Regulation
234414	2.5 gal. (9.5 liter)	single
234415	2.5 gal. (9.5 liter)	dual
234416	5 gal. (19 liter)	single
234417	5 gal. (19 liter)	dual

*50 psi (345 kPa, 3.5 bar) Maximum Fluid Pressure**

**Air pressure loads that are higher than design loads or alterations to the pressure feed tank, can result in tank rupture or explosion.*



Important Safety Instructions

Read all warnings and instructions in this manual.
Save these instructions.



PROVEN QUALITY. LEADING TECHNOLOGY.

Manual Conventions

 **WARNING**









WARNING indicates a potentially hazardous situation which, if not avoided, could result in death or serious injury.

CAUTION

CAUTION indicates a potentially hazardous situation which, if not avoided, may result in property damage or destruction of equipment.

Note

 A note indicates additional helpful information.

 WARNING	
	<p>FIRE AND EXPLOSION HAZARD</p> <p>Flammable fumes, such as solvent and paint fumes, in work area can ignite or explode. To help prevent fire and explosion:</p> <ul style="list-style-type: none"> • Use equipment only in well ventilated area. • Eliminate all ignition sources, such as pilot lights, cigarettes, portable electric lamps, and plastic drop cloths (potential static arc). • Keep work area free of debris, including solvent, rags, and gasoline. • Do not plug or unplug power cords or turn lights on or off when flammable fumes are present. • Ground equipment and conductive objectives. See Grounding in your sprayer manual. • Use only grounded hoses. • Hold gun firmly to side of grounded pail when triggering into pail. • If there is static sparking or you feel a shock, stop operation immediately. Do not use equipment until you identify and correct the problem.
	<p>EQUIPMENT MISUSE HAZARD</p> <p>Misuse can cause death or serious injury.</p> <ul style="list-style-type: none"> • Do not exceed maximum working pressure or temperature rating of the lowest rated system component. See Technical Data in all equipment manuals. • Use fluids and solvents that are compatible with equipment wetted parts. See Technical Data in all equipment manuals. Read fluid and solvent manufacturer's warnings. • Check equipment daily. Repair or replace worn or damaged parts immediately. • Do not alter or modify equipment. • Use equipment only for its intended purpose. Call your Graco distributor for information. • For professional use only. • Route hoses and cables away from traffic areas, sharp edges, moving parts, and hot surfaces. • Comply with all applicable safety regulations.
	<p>TOXIC FLUID OR FUMES HAZARD</p> <p>Toxic fluids or fumes can cause serious injury or death if splashed in the eyes or on skin, inhaled, or swallowed.</p> <ul style="list-style-type: none"> • Read MSDS's to know the specific hazards of the fluids you are using. • Store hazardous fluid in approved containers, and dispose of it according to applicable guidelines.
	<p>PERSONAL PROTECTIVE EQUIPMENT</p> <p>You must wear appropriate protective equipment when operating, servicing, or when in the operating area of the equipment to help protect you from serious injury, including eye injury, inhalation of toxic fumes, burns, and hearing loss. This equipment includes but is not limited to:</p> <ul style="list-style-type: none"> • Protective eye wear • Gloves, clothing and respirator as recommended by the fluid and solvent manufacturer • Hearing protection

Set-Up

Pressure Relief Procedure



WARNING



Pressure tanks remain pressurized until pressure is manually relieved. To reduce the risk of serious injury from pressurized fluid or accidental spray from gun, always follow this procedure to relieve pressure in the tank:

- Before you check or service any part of the spray system.
- Before you loosen or remove the pressure tank cover or fill port.
- Whenever you stop spraying.

1. Shut off air supply to the tank by closing air valve.
2. Pull ring on safety valve until pressure bleeds down.

Material Preparation

Follow manufacturer's directions for mixing and preparing material.

Strain material using a fine mesh screen to prevent foreign matter from entering and clogging passageways.

Tank Assembly

1. Install tank handle and lock nut by turning handle clockwise 4-5 turns. Position handle so it is parallel to safety valve branch tee.
2. Secure in place by tightening lock nut using a 9/16 in. open end wrench.



Tank handle must be attached before installing regulator.

3. Install regulator 234393 by tightening swivel adapter nut 288804 onto nipple 288778. Position unit so gauge is facing the same direction as safety valve ring. Use 11/16 in. open end wrench to tighten swivel adapter nut.

Installation

⚠ WARNING

- A safety valve protects tank from over pressurization. During each use, pull ring on safety valve to check if it operates freely and relieves air pressure. If the valve is stuck, does not operate freely, or does not relieve air pressure, it must be replaced.
- Do not discard or make any alterations or substitutions to safety valve.
- Do not make any changes to the pressure tank. Tampering in the form of drilling, welding, etc., will weaken the tank.

 The following information is for a typical installation.

1. Follow **Pressure Relief Procedure**, page 3.
2. Slowly loosen thumb screws, tip lid clamps back and remove lid assembly.

3. Pour material into tank.

 Use part no. 289136 2.5 Gallon Disposable Tank Liners for easy clean-up. Not available for 5 Gallon Tank.

4. Replace lid assembly and tighten clamps and thumb screws securely.
5. Pass air supply line through Air Control Unit to filter dirt from air and extract water and oil. Connect air supply hose to air inlet fitting on tank regulator.
6. Attach atomization air hose to the air outlet fitting which is directly opposite air inlet fitting on tank pressure regulator.
7. Connect material hose to fluid outlet fitting on top of tank lid.

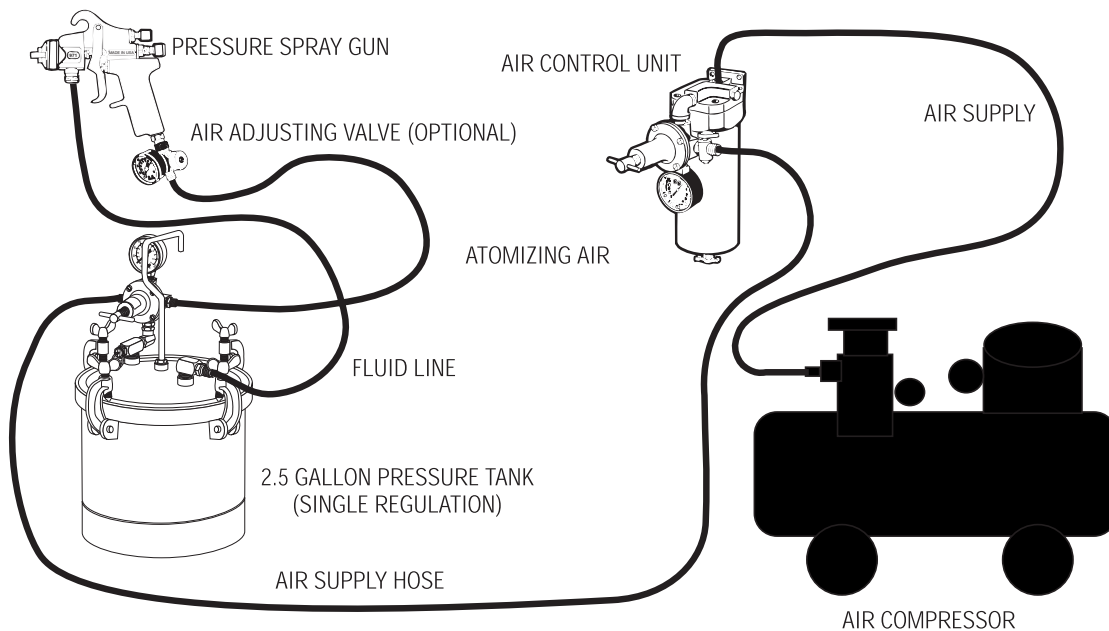

Operation

1. Turn on air supply.
2. Turn T-handle adjusting screw clockwise on the tank pressure regulator, while pulling the gun trigger fully back to start material flow.
3. Continue turning T-handle clockwise until desired material flow is achieved. To decrease pressure turn T-handle counter-clockwise to a lower setting. Then relieve pressure in tank by pulling the ring on the safety valve.
4. Atomization air for the spray gun can be adjusted using the air adjusting valve on the spray gun or at the air regulator assembly (Model 234415 only) on the pressure tank.
5. Operate spray gun according to instructions accompanying gun.

9. Pour solvent into tank.
10. Replace lid and tighten thumb screws and clamps.
11. Turn T-handle on tank regulator clockwise while pulling gun trigger fully back and spray until clean solvent appears.
12. Repeat steps 1-3.

 Decorative powder coating may be affected by solvent contact. Avoid prolonged exposure of solvents to powder coated areas. Tank has been zinc plated underneath the decorative coating for rust protection.

Maintenance

Cleaning the Tank

1. Turn off main air supply to tank.
2. Follow **Pressure Relief Procedure**, page 3.
3. Turn T-handle adjusting screw on regulator, counter-clockwise until no spring tension is felt.
4. Slowly loosen thumb screws, tip clamps back and tip tank lid to one side.
5. Loosen spray gun air cap ring about three turns.
6. Turn on air supply.
7. Hold a cloth over air cap on gun and pull trigger. This forces material back through the hose, into the tank.
8. Empty and clean tank and parts using a suitable solvent.

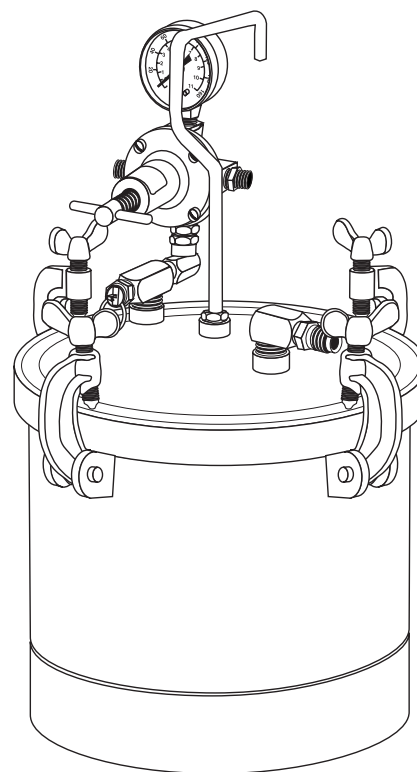

Parts

2.5 and 5 Gallon Pressure Tanks, Models: 234414, 234415, 234416, 234417

Part No.	Description
157350	ADAPTER, 3/8 npt x 1/4 npt
234393	REGULATOR, air pressure
289134	TUBE fluid (234414 & 234415 only)
289141	TUBE, fluid (234416 & 234417 only)
289144	LID, assembly
288803	LID, gasket, thiokol
116306	VALVE, safety
288804	ADAPTER, swivel
289161	TEE, branch
288805	HANDLE, tank
288806	NUT, hex, handle
289145	NIPPLE, fluid, 3/8 in.
289146	ELBOW, street
289147	YOKE, assembly, with thumbscrew
289148	PIN, hinge with "E" clip
234392	REGULATOR, air pressure (234415 & 234417 only)
160430	GAUGE, air pressure
289149	PLUG
157350	ADAPTER, 3/8npt x 1/4 npt

234393 Regulator

Part No.	Description
160430	GAUGE, fluid pressure
288778	NIPPLE, 1/4 in.
289150	REGULATOR, body
289151	REGULATOR, bonnet
289152	SEAT, valve
289153	SPRING, valve
289154	BODY, valve
288779	STEM, valve
289155	SCREEN, wire
288780	DIAPHRAGM, assembly
289156	SPRING, pressure
289157	WASHER, spring
289158	DAMPER, vibration
289159	SCREW, adjusting
289160	SCREW

Accessories

289136	TANK LINER, not shown (234414 and 234415 only), 2.5 gal. only
--------	---

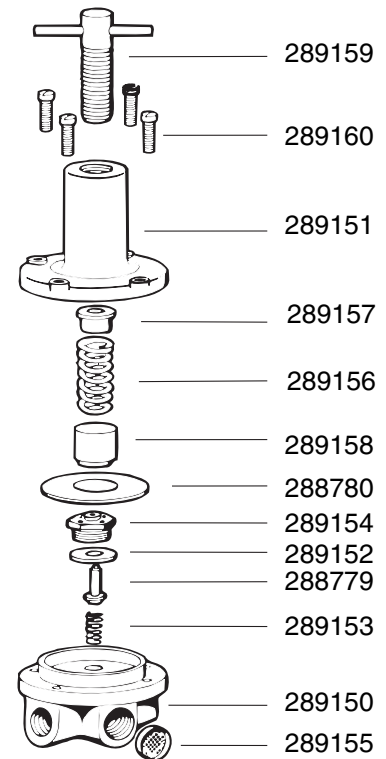
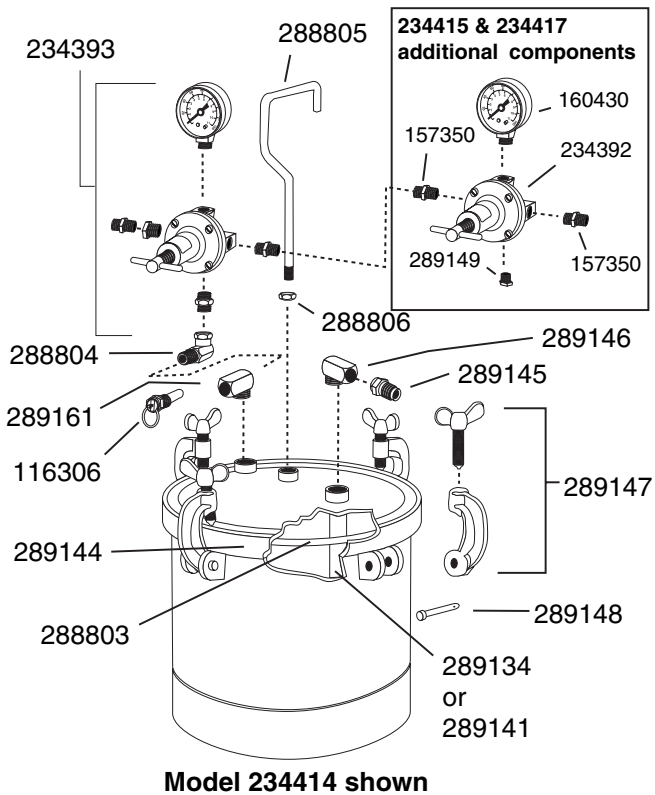

Graco Standard Warranty

Graco warrants all equipment referenced in this document which is manufactured by Graco and bearing its name to be free from defects in material and workmanship on the date of sale to the original purchaser for use. With the exception of any special, extended, or limited warranty published by Graco, Graco will, for a period of twelve months from the date of sale, repair or replace any part of the equipment determined by Graco to be defective. This warranty applies only when the equipment is installed, operated and maintained in accordance with Graco's written recommendations.

This warranty does not cover, and Graco shall not be liable for general wear and tear, or any malfunction, damage or wear caused by faulty installation, misapplication, abrasion, corrosion, inadequate or improper maintenance, negligence, accident, tampering, or substitution of non-Graco component parts. Nor shall Graco be liable for malfunction, damage or wear caused by the incompatibility of Graco equipment with structures, accessories, equipment or materials not supplied by Graco, or the improper design, manufacture, installation, operation or maintenance of structures, accessories, equipment or materials not supplied by Graco.

This warranty is conditioned upon the prepaid return of the equipment claimed to be defective to an authorized Graco distributor for verification of the claimed defect. If the claimed defect is verified, Graco will repair or replace free of charge any defective parts. The equipment will be returned to the original purchaser transportation prepaid. If inspection of the equipment does not disclose any defect in material or workmanship, repairs will be made at a reasonable charge, which charges may include the costs of parts, labor, and transportation.

THIS WARRANTY IS EXCLUSIVE, AND IS IN LIEU OF ANY OTHER WARRANTIES, EXPRESS OR IMPLIED, INCLUDING BUT NOT LIMITED TO WARRANTY OF MERCHANTABILITY OR WARRANTY OF FITNESS FOR A PARTICULAR PURPOSE.

Graco's sole obligation and buyer's sole remedy for any breach of warranty shall be as set forth above. The buyer agrees that no other remedy (including, but not limited to, incidental or consequential damages for lost profits, lost sales, injury to person or property, or any other incidental or consequential loss) shall be available. Any action for breach of warranty must be brought within two (2) years of the date of sale.

GRACO MAKES NO WARRANTY, AND DISCLAIMS ALL IMPLIED WARRANTIES OF MERCHANTABILITY AND FITNESS FOR A PARTICULAR PURPOSE, IN CONNECTION WITH ACCESSORIES, EQUIPMENT, MATERIALS OR COMPONENTS SOLD BUT NOT MANUFACTURED BY GRACO. These items sold, but not manufactured by Graco (such as electric motors, switches, hose, etc.), are subject to the warranty, if any, of their manufacturer. Graco will provide purchaser with reasonable assistance in making any claim for breach of these warranties.

In no event will Graco be liable for indirect, incidental, special or consequential damages resulting from Graco supplying equipment hereunder, or the furnishing, performance, or use of any products or other goods sold hereto, whether due to a breach of contract, breach of warranty, the negligence of Graco, or otherwise.

FOR GRACO CANADA CUSTOMERS

The Parties acknowledge that they have required that the present document, as well as all documents, notices and legal proceedings entered into, given or instituted pursuant hereto or relating directly or indirectly hereto, be drawn up in English. Les parties reconnaissent avoir convenu que la rédaction du présente document sera en Anglais, ainsi que tous documents, avis et procédures judiciaires exécutés, donnés ou intentés, à la suite de ou en rapport, directement ou indirectement, avec les procédures concernées.

Graco Phone Numbers

TO PLACE AN ORDER, contact your Graco distributor or call to identify the nearest distributor.

Phone: 612-623-6921 **or Toll Free:** 1-800-328-0211, **Fax:** 612-378-3505

*All written and visual data contained in this document reflects the latest product information available at the time of publication.
Graco reserves the right to make changes at any time without notice.*

This manual contains English. MM 309926

Graco Headquarters: Minneapolis

International Offices: Belgium, China, Japan, Korea

GRACO INC. P.O. BOX 1441 MINNEAPOLIS, MN 55440-1441

www.graco.com

309926G 6/2003, Rev. 9/2007

Download from www.Somanuals.com. All Manuals Search And Download.

Free Manuals Download Website

<http://myh66.com>

<http://usermanuals.us>

<http://www.somanuals.com>

<http://www.4manuals.cc>

<http://www.manual-lib.com>

<http://www.404manual.com>

<http://www.luxmanual.com>

<http://aubethermostatmanual.com>

Golf course search by state

<http://golfingnear.com>

Email search by domain

<http://emailbydomain.com>

Auto manuals search

<http://auto.somanuals.com>

TV manuals search

<http://tv.somanuals.com>