



Home Theater Scaler Plus

USER MANUAL

www.gefen.com

ASKING FOR ASSISTANCE

Technical Support:

Telephone (818) 884-6294
(800) 545-6900

Fax (818) 884-3108

Technical Support Hours:

8:00 AM to 5:00 PM Monday through Friday.

Write To:

Gefen Inc.
C/O Customer Service
6265 Variel Ave.
Woodland Hills, CA 91367-9897

Notice

Gefen Inc. reserves the right to make changes in the hardware, packaging and any accompanying documentation without prior written notice.

The Home Theater Scaler Plus is a trademark of Gefen Inc.

© 2007 Gefen Inc., All Rights Reserved

TABLE OF CONTENTS

- 1** Introduction / Operation Notes
- 2** Features
- 3** Panel Layout
- 4** Operation Controls and Functions
- 5** Operation Controls and Functions
- 6** Operation Controls and Functions / Color Settings
- 7** Output Settings / OSD Adjustment / Information
- 8** Using the Home Theater Scaler Plus
- 9** RMT-SR-IR Installation
- 10** Pin Configuration
- 11** Specifications
- 12** Terminology
- 13** Warranty

INTRODUCTION

Thank you for purchasing the Home Theater Scaler Plus.

The Gefen Home Theater Scaler Plus allows you to upscale and switch your standard definition or high definition component and HDMI sources to resolutions up to 1080p. Anything from set-top boxes, DVD players to the next generation of gaming consoles including the Xbox 360 and PS3 can be plugged into the Home Theater Scaler.

The Home Theater Scaler Plus supports one component source with analog audio, one composite or S-video source with analog audio, and two HDMI sources with digital audio. The analog audio from the analog sources is digitized and outputted to the HDMI connection as well as the digital audio outs. The HDMI inputs also have separate digital audio inputs, so you can use DVI sources and separate digital audio and the Home Theater Scaler Plus will embed the digital audio into the HDMI output as well as the digital audio outs.

Easy to use on-screen menus accessible through the IR remote control allow for effortless setup and image adjustment to accommodate different viewing modes and screen sizes.

Note: The switching is done by using the the RMT-SR-IR remote control. Any HDTV with DVI inputs can be connected to the HDMI output of the Home Theater Scaler by using a HDMI to DVI adapter, if the cable being used is DVI.

OPERATION NOTES

READ THESE NOTES BEFORE INSTALLING OR OPERATING THE HOME THEATER SCALER PLUS

- The Home Theater Scaler Plus works with all DVI and HDMI displays.
- The Home Theater Scaler Plus is fully HDCP compliant.

FEATURES

Features

- Both digital and analog inputs are format converted and pixel re-scaled through the Home Theater Scaler. It outputs a large range of formats and resolutions that will easily match the native resolution/ format of your display to ensure highest picture quality.
- DVI/HDCP/HDMI compliant input: Operates up to 165Mhz (Up to UXGA @60Hz)
- Supports digital HD output up to 1080p.
- Dual high quality scaling engines.
- Dual 3-D motion video adaptive de-interlacers with smooth low-angle edge.
- Option to select Audio input from HDMI or TOSlink/SPDIF audio source.
- Supports HDCP compliant devices
- Integrated 8-bit triple-ADC/PLL.
- Integrated DVI/HDCP/HDMI compliant receiver.
- Automatic 3:2 pull-down & 2:2 pull-down detection and recovery.
- High performance frame rate conversion engine.
- Option to select Audio input from HDMI or TOSlink/SPDIF audio source.
- 3D noise reduction on analog inputs only.
- Aspect Ratio Control
- Digital Audio Delay to match audio/video timing
- Less then one frame delay allowing for gaming
- The Proprietary Advanced Color Engine technology gives: Brilliant and fresh color, Intensified contrast and details, Vivid skin tone, Sharp edge, Accurate and independent color control

Includes:

- (1) Home Theater Scaler Plus
- (1) 6 ft HDMI cable (M-M)
- (1) 5V Power Supply
- (1) IR Remote control
- (1) User's Manual

PANEL LAYOUT

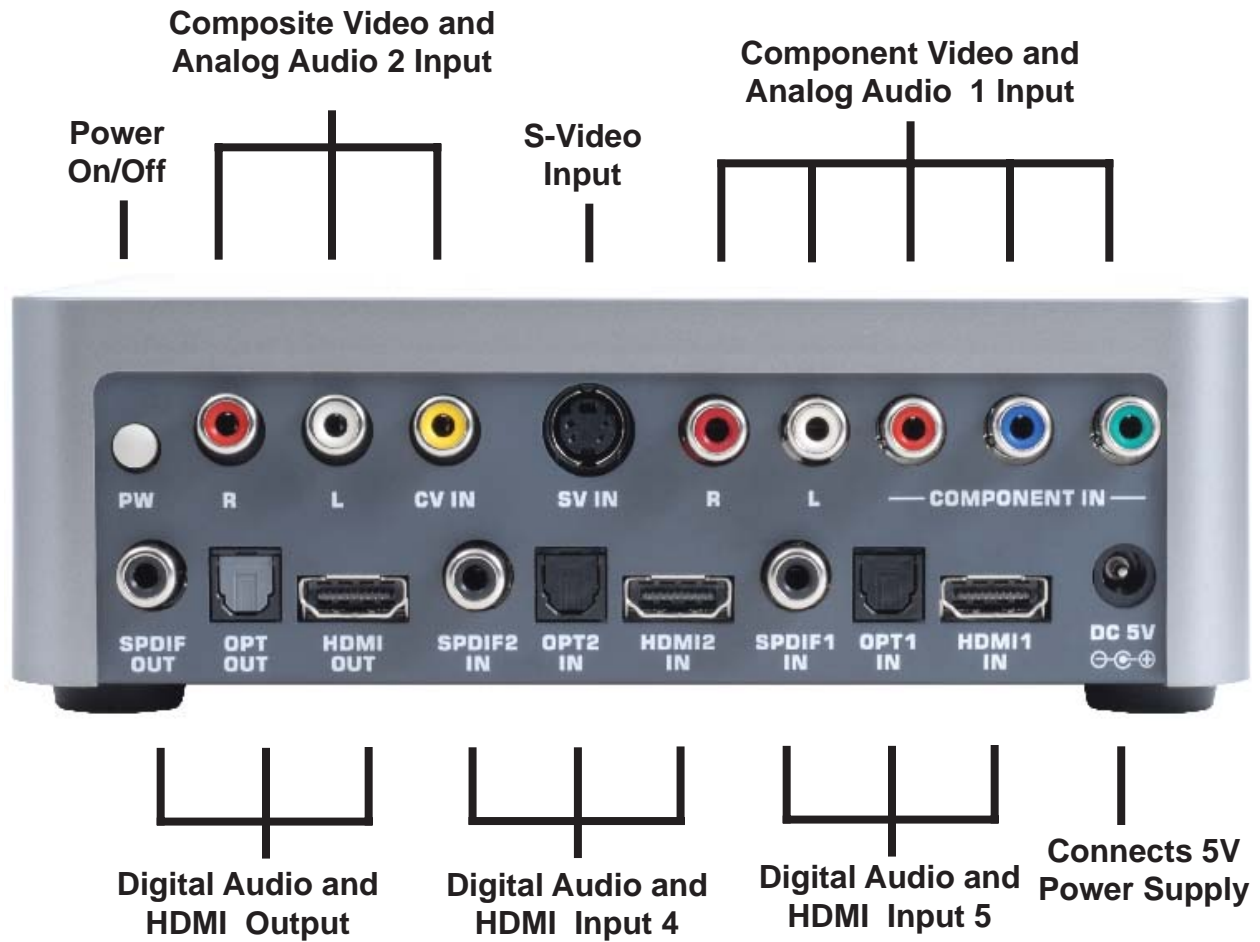

OPERATION CONTROLS AND FUNCTIONS

The Home Theater Scaler Plus accepts component, PC and HDMI inputs with audio on each. The formats supported by these inputs are as follows:

PC INPUT:	RGBHV	VGA/SVGA/XGA/SXGA/UXGA/WXGA/WSXGA/WUXGA VGA @ (60/72/75/85)/SVGA @ (56/60/72/75/85) XGA @ (60/70/75/85)/SXGA @ (60/75/85)/UXGA @ 60/ WXGA @ 60(1280x800)/WSXGA @ 60(1680x1050) WUXGA @ 60(1920x1200)/1360x768
HDMI INPUT:	Digital	VGA @ (60/72/75/85)/SVGA @ (56/60/72/75/85) XGA @ (60/70/75/85) / SXGA @ (60/75/85) / UXGA @ 60/WXGA @ (1280x800) WSXGA @ 60(1680x1050) WUXGA @ 60(1920x1200)/1360x768 480i/p @ 50/60Hz 576i/p @ 50Hz 720p @ 50/60Hz 1080i @ 50/60Hz 1080p @ 50//60Hz
COMPONENT	YPbPr	480p @ 50/60Hz 576 @ 50Hz 720p @ 50/60Hz 1080i @ 50/60Hz 1080p @ 50//60Hz
	YCbCr	480i @ 60Hz 576i @ 50Hz
Composite / S-Video	YUV / Y-C	480i @ 60Hz

When connecting to a component source (either SD or HD resolution) use a 3RCA to 3RCA cable to connect the YPbPr or YCbCr output of a DVD or Set Top Box to the y-Cb/Pb-Cr/Pr input connector of the Home Theater Scaler Plus.

When connecting to an DVI source, use an DVI to HDMI cable (or adaptor) to connect the DVI output of a STB or DVD to the HDMI input connector of the Home Theater Scaler Plus.

The Home Theater Scaler Plus can automatically detect the input resolution of all three inputs.

When connecting to a HDMI source, use an HDMI cable to connect the HDMI output of a STB or DVD to the HDMI input connector of the Home Theater Scaler Plus.

The Home Theater Scaler Plus can automatically detect the input resolution of all four inputs.

OPERATION CONTROLS AND FUNCTIONS

After you power on the unit, press the menu button and it will bring up the main menu as follows:

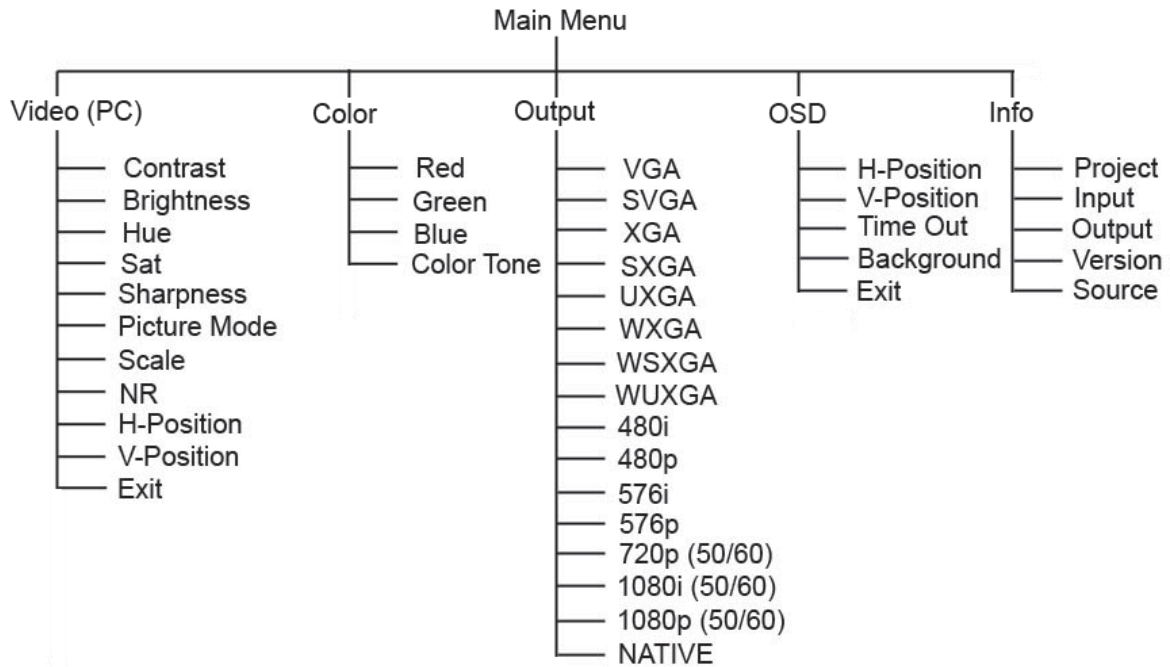

Video (or PC): When Video is selected, a sub menu as shown below, will come up.

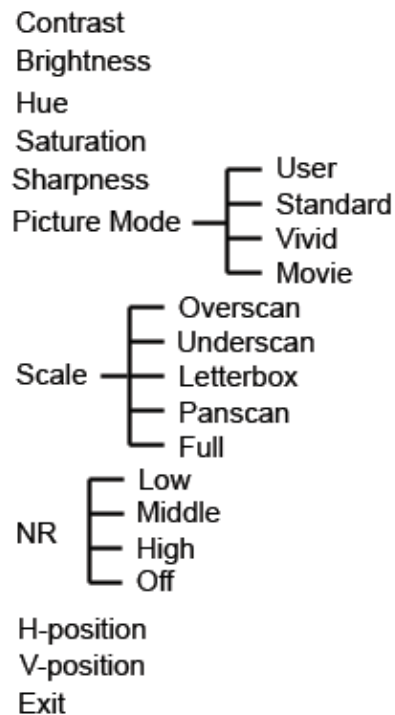

OPERATION CONTROLS AND FUNCTIONS

Picture mode: There are 4 picture modes for customer to choose from.

User: Select to adjust to your favorite setting and store it.

Standard: Standard factory default setting for optimal display in a normal environment.

Vivid: High saturation picture for optimal display in a bright room.

Movie: Picture for comfortable low brightness display in a dark room.

Scale: Select overscan when input source is SD or HD video to ensure no black band around screen border. Select underscan when input source is PC signal to ensure full picture content will fall within screen border.

Noise Reduction: This function only works when input is analog RGB or component, It will not work for DVI input. There are four settings that will Noise Reduction-Off, Low, Middle, and High. The Noise Reduction will remove the noise that results from the analog to digital conversion and digital scaling process.

H & V position: To adjust for the best horizontal and vertical position of the picture in the screen.

COLOR SETTINGS

User: Select to adjust to your favorite color temperature setting.

Normal: Normal color tone setting where white is pure white.

Warm: Warm color tone makes white a little reddish.

Cool: Cool color tone makes white a little bluish.

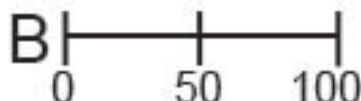
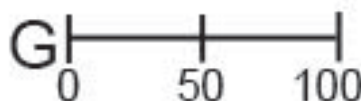
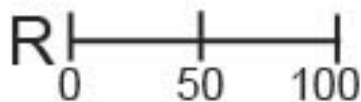

Value of normal setting

OUTPUT SETTINGS

Output: The Home Theater Scale Plus can output a wide variety of PC and HD \ resolutions as follows:

DVI/HDMI (up to 165 MH)	Resolution	1/p*	Format
480i	720x480	i	RGBHV
480p	720x480	p	RGBHV
576i	720x576	i	RGBHV
576p	720x576	p	RGBHV
720p @ (50/60)	1280x720	p	RGBHV
1080i @ (25/30)	1920x1080	i	RGBHV
1080p @ (50/60)	1920x1080	p	RGBHV
VGA @ 60	640x480	p	RGBHV
SVGA @ 60	800x600	p	RGBHV
XGA @ 60	1024x768	p	RGBHV
SXGA @ 60	1280x1024	p	RGBHV
UXGA	1600x1200	p	RGBHV
WXGA @ 60	1280x800	p	RGBHV
WSXGA @ 60	1680x1050	p	RGBHV
WUXGA @ 60	1920x1200	p	RGBHV

* i: interlaced p; progressive

Native: When it is selected, the Home Theater Scaler will automatically adjust its output timing to match the native timing of the display.

OSD ADJUSTMENT

H. Position: Adjust the horizontal position of the OSD graphic.

V. Position: Adjust the vertical position of the OSD graphic.

Time out: Set a predetermined Time to turn off OSD menu on the screen.

Background: To select transparent or solid background of OSD graphic.

INFORMATION

Project: Show product model number.

Input: Show input resolution i.e XGA.

Output: Show output resolution i.e 720p.

Date: Show date of firmware version.

USING THE HOME THEATER SCALER PLUS

1. Connect all the sources to the DVI and/or Component Inputs to the Home Theater Scaler Plus.
2. Connect the HDMI/DVI displays to the DVI output, with the proper cable and/or adapter, on the HD Mate.
3. Connect the 5VDC powersupply to the Home Theater Scaler Plus.
4. Controlling the Home Theater Scaler Plus using the RMT-SR-IR:

By Pressing Buttons...	Does...
input select	changes between sources
output select	changes between display outputs
power	power the scaler on/off
menu	bring up the on screen menu
exit	allows user to exit the on screen menu
up,down,left,right	allow user to navigate through menu
ok (enter)	allows user to confirm their selection
reset	press the button to reset the unit's firmware setting to the factory default value.
auto adjust	press the button to optimize the position of the picture (picture centering) on the screen.

***Note for computers connected to the Home Theater Scaler Plus-** When your computer boots up, it looks for an EDID (extended display identification data) from the display to tell it what monitor is connected and what resolution to output. During boot up of the computer you should have the DVI input selected so that the computer gets the EDID of the display that is selected.

This step can also be eliminated by using a DVI Detective.

RMT8-IR INSTALLATION

1. Remove battery cover from the back of the RMT-SR-IR remote.
2. Verify that dip switches 1 & 2 are in the down (OFF) position.
3. Insert the battery, hold the battery so that you can see the positive side facing up. The side that is not marked must be facing down.
4. Test the RMT-SR-IR remote by pressing ONLY one button at a time. The indicator light on the remote will flash once each time you press a button. **WARNING:** Do not press multiple buttons simultaneously and do NOT press buttons rapidly. These actions will cause the remote to reset and steps 1-4 will have to be repeated.

Note* The RMT-SR-IR ships with two batteries. One battery is required for operation, the second battery is complimentary.



PIN CONFIGURATION

HDMI Output Pin Assignment

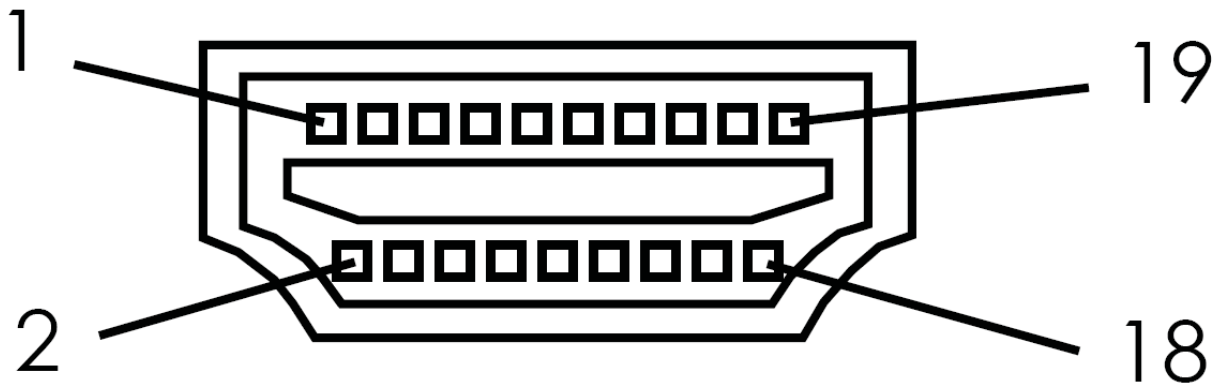

Pin #	Function Assignment	Pin #	Function Assignment
1	TMDS Data2+	2	TMDS Data2 Shield
3	TMDS Data2-	4	TMDS Data1+
5	TMDS Data1 Shield	6	TMDS Data1-
7	TMDS Data0+	8	TMDS Data0 Shield
9	TMDS Data0-	10	TMDS Clock+
11	TMDS Clock Shield	12	TMDS Clock-
13	CEC	14	Reserved (N.C. on device)
15	SCL	16	SDA
17	DDC/CEC Ground	18	+5V Power
19	Hot Plug Detect		

SPECIFICATIONS

Digital Video Amplifier Bandwidth.....	1.65 Gbps
Component Video Bandwidth.....	350 Mhz
Input DDC Signal.....	5 volts p-p (TTL)
Input Video Signal.....	1.2 volts p-p
Single Link Range.....	1080p/1920 x 1200
Input/Output HDMI Connector.....	Type A 19 pin female
Analog Video Connector 1.....	3 RCA Component
Analog Video Connector 2.....	1 RCA Composite
Analog Video Connector 3.....	S-video
Digital Audio Connector.....	Optical TOSlink and Coax SPDIF
Analog Audio Connector.....	2 RCA
Power Supply.....	5V DC
Power Consumption.....	20 watts (max)
Dimensions.....	6.875"W x 2.125"H x 6.875"D
Shipping Weight.....	6 lbs.

TERMINOLOGY

DDC

Short form for Display Data Channel. It is a VESA standard for communication between a monitor and a video adapter. Using DDC, a monitor can inform the video card about its properties, such as maximum resolution and color depth. The video card can then use this information to ensure that the user is presented with valid options for configuring the display.

DDWG

Digital Display Working Group DDWG are the creators of the DVI specification.

DVI

Digital Visual Interface. Connection standard developed by Intel for connecting computers to digital monitors such as flat panels and DLP projectors. A consumer electronics version, not necessarily compatible with the PC version, is used as a connection standard for HDTV tuners and displays. Transmits an uncompressed digital signal to the display. The latter version uses HDCP copy protection to prevent unauthorized copying.

HDCP

High-Bandwidth Digital Content Protection. Created by Intel, HDCP is used with HDTV signals over DVI and HDMI connections and on D-Theater D-VHS recordings to prevent unauthorized duplication of copy written material.

HDMI

The High-Definition Multi-media Interface (HDMI) is an industry-supported, uncompressed, all-digital audio/video interface. HDMI provides an interface between any compatible digital audio/video source, such as a set-top box, DVD player, and A/V receiver and a compatible digital audio and/or video monitor, such as a digital television (DTV).

HDTV

High-Definition Television. The high-resolution subset of our DTV system. The ATSC defines HDTV as a 16:9 image with twice the horizontal and vertical resolution of our existing system, accompanied by 5.1 channels of Dolby Digital audio. The CEA defines HDTV as an image with 720 progressive or 1080 interlaced active (top to bottom) scan lines. 1280:720p and 1920:1080i are typically accepted as high-definition scan rates.

RS-232

Recommended Standard 232. This is the de facto standard for communication through PC serial ports. It can refer to cables and ports that support the RS232 standard.

VESA

Video Electronic Standards Association, a consortium of manufacturers formed to establish and maintain industry wide standards for video cards and monitors. VESA was instrumental in the introduction of the Super VGA and Extended VGA video graphics standards with a refresh rate of 70 Hz, minimizing flicker and helping to reduce user eyestrain and fatigue.

WARRANTY

Gefen Inc. warrants the equipment it manufactures to be free from defects in material and workmanship.

If equipment fails because of such defects and Gefen Inc. is notified within two (2) year from the date of shipment, Gefen Inc. will, at its option, repair or replace the equipment, provided that the equipment has not been subjected to mechanical, electrical, or other abuse or modifications.

Equipment that fails under conditions other than those covered will be repaired at the current price of parts and labor in effect at the of repair. Such repairs are warranted for ninety (90) days from the day of reshipment to the Buyer.

This warranty is in lieu of all other warranties expressed or implied, including without limitation, any implied warranty or merchantability or fitness for any particular purpose, all of which are expressly disclaimed.

1. Proof of sale may be required in order to claim warranty.
2. Customers outside the US are responsible for shipping charges to and from Gefen.
3. Copper cables are limited to a 30 day warranty and cable must be free from any scratches, markings, and neatly coiled.

The information in this manual has been carefully checked and is believed to be accurate. However, Gefen Inc. assumes no responsibility for any inaccuracies that may be contained in this manual. In no event will Gefen Inc., be liable for direct, indirect, special, incidental, or consequential damages resulting from any defect or omission in this manual, even if advised of the possibility of such damages. The technical information contained herein regarding the Home Theater Scaler Plus features and specifications is subject to change without notice.

Free Manuals Download Website

<http://myh66.com>

<http://usermanuals.us>

<http://www.somanuals.com>

<http://www.4manuals.cc>

<http://www.manual-lib.com>

<http://www.404manual.com>

<http://www.luxmanual.com>

<http://aubethermostatmanual.com>

Golf course search by state

<http://golfingnear.com>

Email search by domain

<http://emailbydomain.com>

Auto manuals search

<http://auto.somanuals.com>

TV manuals search

<http://tv.somanuals.com>