

C 1030 plus Art. 1862

- GB** **Operating Instructions**
Water Computer
-
- F** **Mode d'emploi**
Programmateur d'arrosage
-
- NL** **Instructies voor gebruik**
Besproeiingscomputer
-
- S** **Bruksanvisning**
Bevattningscomputer
-
- DK** **Brugsanvisning**
Vandingscomputer
-
- RUS** **Инструкция по эксплуатации**
Компьютер для полива

GARDENA Water Computer C 1030 plus

Welcome to the Garden of GARDENA...



Translation of the original instructions from German.

Please read these operating instructions carefully and observe the notes given. Use these instructions to familiarise yourself with the Water Computer and its proper use as well as the notes on safety.



For safety reasons, children and young people under 16 as well as anyone who is not familiar with these operating instructions should not use the Water Computer. Persons with reduced physical or mental abilities may use the product only if they are supervised or instructed by a responsible person.

→ Please keep these operating instructions in a safe place.

Contents

1. Where to Use Your GARDENA Water Computer	2
2. Safety Instructions	2
3. Function	3
4. Putting Your Water Computer into Operation	5
5. Programming	6
6. Putting Your Water Computer out of Operation	10
7. Maintenance	10
8. Troubleshooting	11
9. Available Accessories	11
10. Technical Data	12
11. Service / Warranty	12

1. Where to Use Your GARDENA Water Computer

Intended use:

The GARDENA Water Computer is intended for private use in domestic and hobby gardens, exclusively for outdoor use, to control sprinklers and watering systems.

The Water Computer can be used for automatic watering during holidays.

Please note:



The GARDENA Water Computer must not be used for industrial purposes or in conjunction with chemicals, foodstuffs, easily flammable and explosive materials.

2. Safety Instructions

Battery:

To ensure the Water Computer runs safely, only a 9V alkaline manganese battery (alkaline) type IEC 6LR61 must be used.

In order to stop the Water Computer from failing because of a weak battery if you are away for a long time, the battery must be replaced when the battery display still shows only 1 bar.

Setting up

Warning!

The Water Computer must not be used indoors.

→ Only use the Water Computer outdoors.

The Water Computer may only be set up vertically with the sleeve nut to the top to prevent water penetrating into the battery compartment.

The minimum water output to ensure that the Water Computer functions correctly is 20 - 30 l/h.

For example, at least 10 x 2-litre Drip Heads are required to control the Micro-Drip-System.

At high temperatures (over 60 °C at the display) the LCD display may extinguish. This does not affect the program in any way.

When the computer cools down the LCD display illuminates again.

The max. temperature for the water flow is 40 °C.

→ Only use clear fresh water.

The minimum operating pressure is 0.5 bar, the maximum operating pressure is 12 bar.

Avoid tensile strain.

→ Do not pull the hose connected to the Water Computer.

Programming

→ Program the Water Computer with the tap turned off.

In this way you can avoid getting wet when trying out the manual On/Off function (man. On/Off). You can remove the control unit from the housing to program the Water Computer.

If the controller is removed when the valve is open, the valve remains open until the controller is fitted again.

3. Function

With the Water Computer, the garden can be watered fully automatically up to 3 times a day at any time of day (every 8 hours). Sprinklers, a sprinkler system or a drip head watering system can be used for watering.

The Water Computer carries out watering fully automatically according to the set program and can therefore also be used during holidays. Early in the morning or late in the evening, evaporation and therefore water consumption is lowest.

Controls :

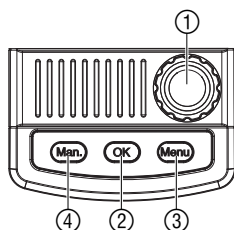

The watering programme is easily entered using the controls.

Control

- ① **Rotary button**
- ② **OK button**
- ③ **Menu button**
- ④ **Man. button**

Function

- Changes the adjustable values.
- Applies the values set with the rotary button.
- Changes to the next programme level.
- For switching the water throughput on or off manually.

Display levels :

The 6 display levels,

- Level 1 : **Normal display**
- Level 2 : **Current time and day of the week**
- Level 3 : **Watering start time**
- Level 4 : **Watering duration**
- Level 5 : **Watering frequency**
- Level 6 : **Switches programme on and off**

can be selected one after the other by pressing the **Menu** key.

You can change the display level at any time, even during programming. All the programme data which have been confirmed up to that point with the OK key are stored.

Display

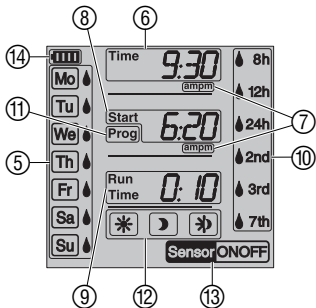

Display	Description
⑤ Weekdays (Mo), (Tu), ...	Current weekday or programmed watering days.
⑥ Time	Flashes when in input mode for the current data (hours, minutes, day of the week).
⑦ am / pm	Display for 12 hour clock (e. g. in USA, Canada).
⑧ Start	Flashes when in input mode for watering start time.
⑨ Run Time	Watering duration (flashes when in input mode).
⑩ 8h, 12h, 24h, 2nd, 3rd, 7th	Watering cycle (with drop symbol activated). Every 8 / 12 / 24 hours; every 2nd / 3rd / 7th day.
⑪ Prog ON / OFF	Watering programme on (ON) / off (OFF).
⑫ Automatic mode sensor	Watering is controlled automatically via the sensor.
⑬ Sensor ON / OFF	Sensor ON (watering) / Sensor OFF (watering is not carried out).
⑭ Battery 	Indicates 5 battery levels: 3 bars: Battery fully charged 2 bars: Battery half full 1 bar: Battery low 1 bar flashing: Battery almost flat 0 bar: Battery flat

If no bars are displayed, the valve is no longer opened. **A valve opened by the programme will also close again if the battery is flat.** The battery display is reset when the battery is changed.

2 Bars	1 Bar	1 Bar flashing	0 Bar
Battery half full	Battery low	Battery almost flat	Battery flat
Valve opens.	Valve opens.	Valve still opens.	Valve does not open.
The Water Computer is guaranteed to work for a minimum of 4 more weeks.	The Water Computer will continue to work for no more than 4 weeks.	The Water Computer stops working soon.	The Water Computer stops working.
	It is advisable to change the battery.	The battery must be changed soon.	The battery must be changed.
	→ Replace battery (see 4. Putting Your Water Computer into Operation "Inserting battery").		

4. Putting Your Water Computer into Operation

Insert battery:

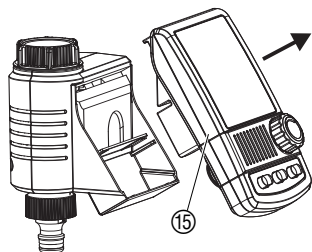

The Water Computer must only be operated with a 9 V alkali-manganese (alkaline) battery type IEC 6LR61.

1. Remove controller ⑮ from the housing of the Water Computer.
2. Insert battery in the battery compartment ⑯. **Observe correct polarity P.** *The display shows all the LCD-symbols for 2 seconds and then moves to the time/day of week level.*

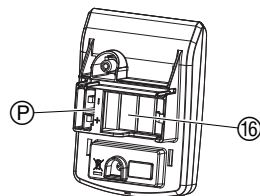

3. Install controller ⑮ on the housing again.

Connect Water Computer:

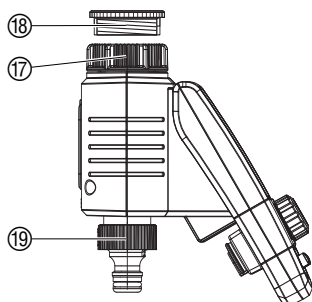

The Water Computer is fitted with a sleeve nut ⑰ for taps with (G 1") (33.3 mm) thread. The adaptor supplied ⑱ allows the Water Computer to be connected to taps with a (G ¾") thread (26.5 mm).

1. **For tap with a G ¾" (26.5 mm) thread:**
Screw adaptor ⑱ on to the tap manually (do not use pliers).
2. Screw sleeve nut ⑰ of the Water Computer on to the adaptor thread by hand (do not use pliers).
3. Screw tap connector ⑲ on to the Water Computer.

Connect soil moisture or rain sensor (optional):

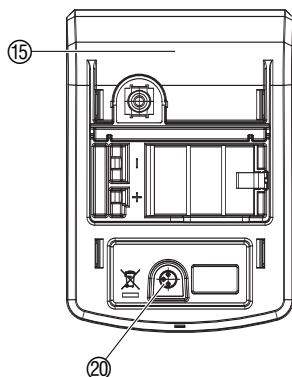

Apart from scheduled watering there is also the option of including how damp the soil is or rainfall into the watering programme.

If the soil is damp enough, the programme will be stopped, or a programme will be prevented from starting. Manual operation via Man. **On / Off** is unaffected by this.

The "Soil moisture sensor-controlled watering" mode can only be selected when using a soil moisture sensor.

1. Remove controller ⑮ from the housing of the Water Computer.
2. Place soil moisture sensor **in** the watered area
– or –
place rain sensor (with extension cable if necessary) **outside** the watered area.
3. Insert the sensor in the sensor connection ⑳ of the Water Computer.

An adapter cable may be required to connect older sensors, which can be purchased from GARDENA Service, **GARDENA Adapter cable Art. No. 1189-00.600.45.**

Fit anti-theft device (optional):

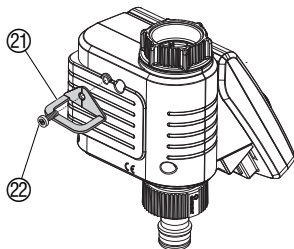

To secure your Water Computer against theft, you can obtain the **GARDENA Anti-theft device Art. No. 1815-00.791.00** from GARDENA Service.

1. Screw clamp ②① with screw ②② firmly to the back of the Water Computer.
2. Use clamp ②① e.g. for fixing a chain.

It is no longer possible to remove the screw after it has been screwed in.

5. Programming

Set current time and day of week:

[Level 2]

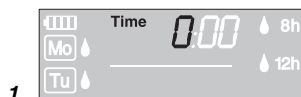

1.

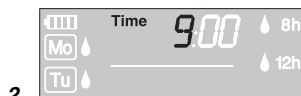

2.

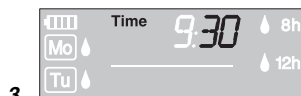

3.

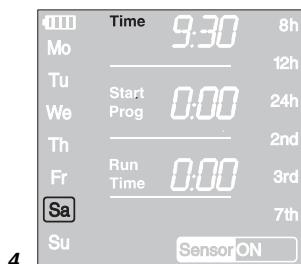

4.

To set the programme, the controller can be removed and mobile programming can be carried out (see 4. Putting Your Water Computer into Operation "Inserting battery").

1. Press **Menu**-key (not necessary if the battery has just been inserted).

*The hours display and **Time** flash.*

2. Set the time in hours with the rotary button (example: **9** hours) and confirm with the **OK**-key.

***Time** and the minutes display flash.*

3. Set the time in minutes with the rotary button (example: **30** minutes) and confirm with the **OK**-key.

***Time** and the day of the week display flash.*

4. Set the day of the week with the rotary button (example: **Sa** Saturday) and confirm with the **OK**-key.

The display moves to the message

Insert watering programme.

Start and the hour display will flash on the screen.

Watering modes:

The water computer has 2 watering modes:

- **Scheduled watering** using the input programmes (watering starts depending on the watering start time)
– or –
- **Soil moisture sensor-controlled watering** using a GARDENA soil moisture sensor (watering begins when the soil moisture sensor registers dry).

Entering watering programme:

[Level 3]



[Level 4]

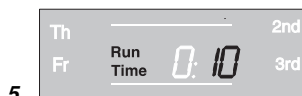

[Level 5]

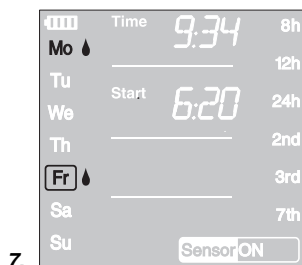
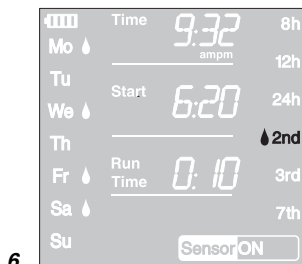

Scheduled watering:

1. Press **Menu**-key twice (not necessary if the current time and day of the week has been entered).
Start Prog and the hours section flash on the display.
2. Set the watering start time hours with the rotary button (E.g. **6**) and confirm with the **OK**-key.
Start Prog and the minute display flashes on the screen.
3. Set the minutes for starting the watering time with the rotary button (example: **20** minutes) and confirm with the **OK**-key.
Run Time and the hours for the watering time flash on the display.
4. Set the hours for the watering time with the rotary button (example: **0** hours) and confirm with the **OK**-key.
Run Time and minutes for the watering time flash on the display.
5. Set watering time minutes with the rotary button (example: **10** minutes) and confirm with the **OK**-key.
Watering cycle **8h** flashes on the display.

The watering frequency can be selected by:

- the **(6.) watering cycle** (right hand column of the display)
– or –
- the **(7.) watering days** (left hand column of the display).

6. Select **watering cycle** with the rotary button (E.g. **2nd**) and confirm by pressing **OK**.

8h / 12h / 24h: Watering every 8 / 12 / 24 hours
2nd / 3rd / 7th: Watering every 2nd / 3rd / 7th day

The display jumps to the watering programme on the screen.

– or –

7. Select each watering day with the rotary button

(E.g. **Mo**, **Fr** Monday and Friday) and confirm by pressing **OK**. Press the **Menu** button.

The display jumps to the watering programme on the screen.

Starting watering programmes:

[Level 6]



The **Prog ON** must be selected so that the watering programme can start.

1. Press the **Menu** button 5 times (not necessary if the programme has been created before).
2. Select the **Prog ON** with the rotary button and confirm by pressing **OK**.

The Prog OK appears for 2 seconds and then the Normal display returns.

The water computer has now been programmed, i.e. the inbuilt valve opens and closes completely automatically and thus waters at the programmed time.

Even if **Prog OFF** is selected watering can be done manually.

Soil moisture sensor-controlled watering

Condition: the GARDENA Soil Moisture Sensor **Art. 1188** is connected.

A previously set scheduled watering programme is retained but not carried out.

1. Hold the **Menu** button down for 5 seconds. *The watering cycle flashes.*
2. Select the required watering cycle with the rotary button (e.g. ☀ Day) and confirm with the **OK**-key.

Day
☀ Watering during the day (6 a.m. – 8 p.m.) when the soil moisture sensor registers dry.

Night
☾ Watering during the night (8 p.m. – 6 a.m.) when the soil moisture sensor registers dry.

Day & Night
☀☾ Watering when the soil moisture sensor registers dry.

3. Set the watering duration in minutes (0 – 59 minutes) with the rotary button (E.g. 40 minutes) and confirm by pressing **OK**. *Watering starts in the set watering cycle as soon as the soil moisture sensor registers dry (Sensor ON).*

The watering duration set in the sensor-controlled watering mode also applies to manual watering.

In the case of soil moisture sensor-controlled watering, a two hour watering pause is triggered after every watering cycle in order for the soil moisture sensor to record the soil moisture.

Example:

Watering cycle = ☀ (Day),
watering duration = 40 minutes.

Watering begins when the sensor registers dry (Sensor ON) during the day (between 6 a.m. and 8 p.m.) and ends up to 40 minutes later depending on the amount of moisture in the soil.



The watering duration is preset to 30 minutes at the factory.

Emergency programme: If no sensor is inserted in sensor-controlled watering mode or if the connection cable is faulty, watering will take place every 24 hours. The watering duration depends on the run time but is limited to a maximum of 30 minutes.

Exit soil moisture sensor-controlled watering again:

→ Hold the **Menu** button down for 5 seconds.

The normal display appears on the screen again.

Read / modify watering programmes:

If a value in the programme is to be changed, this can be changed without changing the other values in the programme.



1. Press the **Menu** key twice.

Start and the hours flash on the display.

2. Press the **Menu** button to jump to the next programme level

– or –

change the programme data with the rotary button and confirm by pressing the **OK** button.

When the watering duration is changed while a program is running, the current watering cycle is ended.

Manual operation:

The valve can be **opened or closed manually at any time.**

A program-controlled open valve can also be closed early without changing the program data (watering start time, watering duration and watering frequency).

The controller must be fitted.

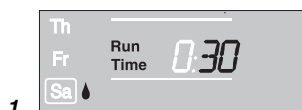

1. Press **Man.**-key to open the valve manually (or to close an open valve).

Run Time and the watering time in minutes (set to **30** minutes in the works) flash for 10 seconds on the display.

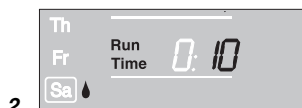

2. Whilst the watering time in minutes is flashing, the watering duration can be modified with the rotary button (between **0:00** and **0:59**) (example: **10** minutes) and confirm with the **OK**-key.

3. Press **Man.**-key to close the valve early.

The valve is closed.

The amended manual opening period is stored, i.e. each time the valve is opened manually in future the modified opening period is preset. If the manual opening period is amended to **0:00**, the valve is closed and also remains closed after the **Man.**-key is pressed (child lock).

If the valve has been opened manually and a programmed start of a watering period overlaps the manual opening period, the programmed starting time is suppressed.

Example:

The valve is **opened** at **9.00 a.m. manually**, the opening period is 30 minutes. A program with a **start time (START)** between **9.00 and 9.30 a.m.** will not be undertaken in this case.

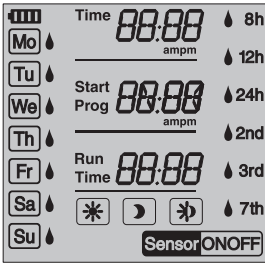
Reset:

The factory settings are restored.

→ Press **Man.-**key and **Menu-**key simultaneously for 3 seconds.
All the LCD symbols are displayed for 2 seconds and the display moves to the normal display.

- All the program data are set to zero.
- The manual watering period is set to **0:30** again.
- The time and day of the week are retained.

Important information:

If no entry is made during programming for a period of more than 60 seconds, the normal display reappears. In this case all changes made up till now will be applied.

When a sensor installed in the water computer registers damp (**OFF**), the programmed watering is not carried out.

6. Putting Your Water Computer out of Operation

Storage / Overwintering:

1. Press **Menu-**key 5 times, select **Prog. OFF** with the rotary button and confirm with the **OK-**key.

The watering program is not run.

2. Store your Water Computer in a dry place where it is protected from frost.

Disposal:

(in accordance with
RL2002/96/EC)



The product must not be added to normal household waste. It must be disposed of in line with local environmental regulations.

→ Important: Make sure that the unit is disposed of via your municipal recycling collection centre.

Disposing of flat batteries:

→ Please return flat batteries to a GARDENA dealer or dispose of them properly at your nearest recycling centre.

Only dispose of batteries when they are **flat**.

7. Maintenance

Clean filter:

The filter ⑳ should be checked regularly and cleaned when necessary.

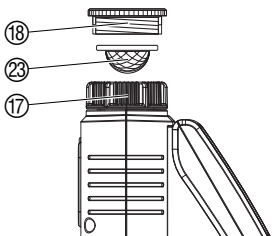

1. Unscrew sleeve nut ⑰ of the Water Computer by hand from the tap thread (do not use pliers).
2. If necessary unscrew the adaptor ⑱.
3. Remove filter ⑳ from sleeve nut ⑰ and clean.
4. Fit the Water Computer again (see 4. Putting Your Water Computer into Operation "Connecting Water Computer").

8. Troubleshooting

Fault	Possible Cause	Remedy
No display appears	Battery inserted incorrectly.	→ Check polarity markings match (+/-).
	Flat battery.	→ Insert new (alkaline) battery.
	Temperature on the display is higher than 60 °C.	Display appears after temperature has dropped.
Manual watering is not possible using the Man. button	Battery flat (1 bar flashes).	→ Insert new (alkaline) battery.
	Manual watering period is set to 0:00 .	→ Set manual watering period to a figure greater than 0:00 (see 5. Programming).
	Tap turned off.	→ Turn tap on.
Watering program is not being undertaken (no watering)	Watering program has not been entered completely.	→ Read off watering program and modify if necessary.
	Programs deactivated (Prog. OFF).	→ Activate program (Prog. ON).
	Program entry/modification during or just before the start pulse.	→ Make program entry/modification outside the programmed start times.
	Valve was opened manually previously.	→ Avoid possible program overlaps.
	Tap turned off.	→ Turn tap on.
	Soil moisture or rain sensor registers damp.	→ If dry, check setting/location of soil moisture/rain sensor.
	Battery flat (1 bar flashing).	→ Insert new (alkaline) battery.
Water Computer does not close	Minimum quantity of water drawn is less than 20 l/h.	→ Connect more drip heads.
All 3 watering cycle symbols flash (☼ ☼ ☼)	Sensor not correctly connected.	→ Check connection cable and sensor.



In the event of other faults please contact **GARDENA Service**.
Repairs should only be carried out by **GARDENA service centres or dealers** authorised by **GARDENA**.

9. Available accessories

GARDENA
Soil Moisture Sensor

Art. No. 1188

GARDENA
Rain Sensor electronic

Art. No. 1189

GARDENA
Anti-theft device

Art. No. 1815-00.791.00
From GARDENA Service

GARDENA
Adapter cable

To connect older GARDENA
sensors

Art. No. 1189-00.600.45
From GARDENA Service

GARDENA
Cable Adapter

For simultaneous connection of
rain and soil moisture sensor

From GARDENA Service

10. Technical Data

Min./max. operating pressure:	0.5 bar / 12 bar
Flow medium:	Clear fresh water
Max. liquid temperature:	40 °C
Number of program-controlled watering cycles per day:	3 x (every 8 hrs.), 2 x (every 12 hrs.), 1 x (every 24 hrs.)
Number of program-controlled watering cycles per week:	Every day, every 2, 3 or 7 days; or individual selection of weekdays
Watering duration:	1 min. to 7 hours 59 min.
Battery required:	1 x 9V alkaline manganese (alkaline) battery type IEC 6LR61
Operating time of the battery:	approx. 1 year

11. Service / Warranty

GARDENA guarantees this product for 2 years (from date of purchase). This guarantee covers all serious defects of the unit that can be proved to be material or manufacturing faults.

Under warranty we will either replace the unit or repair it free of charge if the following conditions apply:

- The unit must have been handled properly and in keeping with the requirements of the operating instructions.
- Neither the purchaser or a non-authorized third party have attempted to repair the unit.
- Faults which occur as a result of incorrectly installed or leaking batteries are not covered by the guarantee.
- Damage caused by frost is not covered by the warranty.

This manufacturer's guarantee does not affect the user's existing warranty claims against the dealer/seller.

If you have any problems with your Water Computer, please contact our Customer Service or return the defective unit together with a short description of the problem directly to one of the GARDENA Service Centres listed on the back of this leaflet.

- Порча в результате замерзания также исключается из обязательств по гарантии.

Эта гарантия производителя не касается существующих требований по гарантийному обслуживанию продавца.

Быстроизнашивающиеся детали исключены из гарантийного обслуживания.

GB Product Liability

We expressly point out that, in accordance with the product liability law, we are not liable for any damage caused by our units if it is due to improper repair or if parts exchanged are not original GARDENA parts or parts approved by us, and, if the repairs were not carried out by a GARDENA Service Centre or an authorised specialist. The same applies to spare parts and accessories.

F Responsabilité

Nous vous signalons expressément que GARDENA n'est pas responsable des dommages causés par ses appareils, dans la mesure où ces dommages seraient causés suite à une réparation non conforme, dans la mesure où, lors d'un échange de pièces, les pièces d'origine GARDENA n'auraient pas été utilisées, ou si la réparation n'a pas été effectuée par le Service Après-Vente GARDENA ou l'un des Centres SAV agréés GARDENA. Ceci est également valable pour tout ajout de pièces et d'accessoires autres que ceux préconisés par GARDENA.

NL Productaansprakelijkheid

Wij wijzen er nadrukkelijk op, dat wij op grond van de wet aansprakelijkheid voor producten niet aansprakelijk zijn voor schade ontstaan door onze apparaten, indien deze door onvakkundige reparatie veroorzaakt zijn, of er bij het uitwisselen van onderdelen geen gebruik gemaakt werd van onze originele GARDENA onderdelen of door ons vrijgegeven onderdelen en de reparatie niet door de GARDENA technische dienst of de bevoegde vakman uitgevoerd werd. Ditzelfde geldt voor extra-onderdelen en accessoires.

S Produktansvar

Tillverkaren är inte ansvarig för skada som orsakats av produkten om skadan beror på att produkten har reparerats felaktigt eller om, vid reparation eller utbyte, andra än Original GARDENA reservdelar har använts. Samma sak gäller för kompletteringsdelar och tillbehör.

DK Produktansvar

Vi gør udtrykkeligt opmærksom på at i henhold til produktansvarsloven er vi ikke ansvarlige for skader forårsaget af vores udstyr, hvis det skyldes uautoriserede reparationer eller hvis dele er skiftet ud og der ikke er anvendt originale GARDENA dele eller dele godkendt af os, eller hvis reparationerne ikke er udført af GARDENA-service eller en autoriseret fagmand. Det samme gælder for ekstra udstyr og tilbehør.

<p>D EG-Konformitätserklärung</p> <p>Der Unterzeichnete Husqvarna AB, 561 82 Huskvarna, Sweden bestätigt, dass die nachfolgend bezeichneten Geräte in der von uns in Verkehr gebrachten Ausführung die Anforderungen der harmonisierten EU-Richtlinien, EU-Sicherheitsstandards und produktspezifischen Standards erfüllen. Bei einer nicht mit uns abgestimmten Änderung der Geräte verliert diese Erklärung ihre Gültigkeit.</p>	<p>Description of the unit: Water Computer Désignation du matériel : Programmeur d'arrosage Omschrijving van het apparaat: Besproeiingscomputer Produktbeskrivning: Bevattningscomputer Beskrivelse af enhederne: Vandingscomputer</p>
<p>GB EU Declaration of Conformity</p> <p>The undersigned Husqvarna AB, 561 82 Huskvarna, Sweden, hereby certifies that, when leaving our factory, the units indicated below are in accordance with the harmonised EU guidelines, EU standards of safety and product specific standards. This certificate becomes void if the units are modified without our approval.</p>	<p>Type: Art. No.: Type : Référence : Typ: C 1030 plus Art. nr.: 1862 Typ: Art. nr.: Type: Varenr.:</p>
<p>F Certificat de conformité aux directives européennes</p> <p>Le constructeur, soussigné : Husqvarna AB, 561 82 Huskvarna, Sweden, déclare qu'à la sortie de ses usines le matériel neuf désigné ci-dessous était conforme aux prescriptions des directives européennes énoncées ci-après et conforme aux règles de sécurité et autres règles qui lui sont applicables dans le cadre de l'Union européenne. Toute modification portée sur ce produit sans l'accord express de Husqvarna supprime la validité de ce certificat.</p>	<p>EU directives : Directives européennes : 2004/108/EC EU-richtlijnen : 93/68/EC EU direktiv : EU Retningslinier :</p>
<p>NL EU-overeenstemmingsverklaring</p> <p>Ondergetekende Husqvarna AB, 561 82 Huskvarna, Sweden, bevestigt, dat het volgende genoemde apparaat in de door ons in de handel gebrachte uitvoering voldoet aan de eis van, en in overeenstemming is met de EU-richtlijnen, de EU-veiligheidsstandaard en de voor het product specifieke standaard. Bij een niet met ons afgestemde verandering aan het apparaat verliest deze verklaring haar geldigheid.</p>	<p>Hinterlegte Dokumentation: GARDENA Technische Dokumentation E. Renn 89079 Ulm Deposited Documentation: GARDENA Technical Documentation E. Renn 89079 Ulm Documentation déposée : Documentation technique GARDENA E. Renn 89079 Ulm</p>
<p>S EU Tillverkarintyg</p> <p>Undertecknad firma Husqvarna AB, 561 82 Huskvarna, Sweden, intygar härmed att nedan nämnda produkter överensstämmer med EU:s direktiv, EU:s säkerhetsstandard och produktspecifikation. Detta intyg upphör att gälla om produkten ändras utan vårt tillstånd.</p>	<p>Year of CE marking: Date d'apposition du marquage CE : Installatiejaar van de CE-aanduiding: CE-Märkningsår: 2007 CE-Mærkningsår: Год разрешения маркировки</p>
<p>DK EU Overensstemmelse certifikat</p> <p>Undertegnede Husqvarna AB, 561 82 Huskvarna, Sweden bekræfter hermed, at enheder listet herunder, ved afsendelse fra fabrikken, er i overensstemmelse med harmoniserede EU retningslinier, EU sikkerhedsstandarder og produkt-specifikationsstandarder. Dette certifikat træder ud af kraft hvis enhederne er ændret uden vor godkendelse.</p>	<p>Ulm, 01.08.2007 Fait à Ulm, le 01.08.2007 Ulm, 01-08-2007 Ulm, 2007.08.01. Ulm, 01.08.2007</p> <p>Authorised representative Représentant légal Gemachtigde Behörig Firmatecknare Teknisk direktor</p> <p> Peter Lameli Vice President</p>

Deutschland / Germany

GARDENA GmbH
Central Service
Hans-Lorenser-Straße 40
D-89079 Ulm
Produktfragen:
(+49) 731 490-123
Reparaturen:
(+49) 731 490-290
service@gardena.com

Albania

COBALT Sh.p.k.
Rr. Sirti Kodra
1000 Tirana
Argentina
Husqvarna Argentina S.A.
Av.del Libertador 5954 –
Piso 11 – Torre B
(C142ZARP) Buenos Aires
Phone: (+54) 11 5194 5000
info.gardena@
ar.husqvarna.com

Armenia

Garden Land Ltd.
61 Tigran Mets
0005 Yerevan

Australia

Husqvarna Australia Pty. Ltd.
Locked Bag 5
Central Coast BC
NSW 2252
Phone: (+61) (0) 2 4352 7400
customer.service@
husqvarna.com.au

Austria / Österreich

Husqvarna Austria GmbH
Consumer Products
Industriezeile 36
4010 Linz
Tel.: (+43) 732 77 01 01-90
consumer.service@
husqvarna.at

Azerbaijan

Firm Progress a.
Aliyev Str. 26A
10522 Baku

Belgium

GARDENA Belgium NV/SA
Sterrebeekstraat 163
1930 Zaventem
Phone: (+32) 2 720 92 12
Mail: info@gardena.be

Bosnia / Hercegovina

SILK TRADE d.o.o.
Industrijska zona Bukva bb
74260 Tešanj

Brazil

Husqvarna do Brasil Ltda
Av. Francisco Matrazzo,
1400 – 19º andar
São Paulo – SP
CEP: 05001-903
Tel: 0800-112252
marketing.br.husqvarna@
husqvarna.com.br

Bulgaria

Хускварна България ЕООД
Бул. „Андрей Липчев“ № 72
1799 София
Tel.: (+359) 02/9753076
www.husqvarna.bg

Canada / USA

GARDENA Canada Ltd.
100 Summerlea Road
Brampton, Ontario L6T 4X3
Phone: (+1) 905 979 9330
info@gardena.canada.com

Chile

Maquinarias Agroforestales
Ltda. (Maga Ltda.)
Santiago, Chile
Avda. Chesterton
8355 comuna Las Condes
Phone: (+56) 2 202 4417
Dalton@мага.cl
Zipcode: 7560330

Temuco, Chile

Avda. Valparaiso # 01466
Phone: (+56) 45 222 126
Zipcode: 4780441

China

Husqvarna (China) Machinery
Manufacturing Co., Ltd.
No. 1355, Jia Xin Rd.
Ma Lu Zhen, Jia Ding Dist.,
Shanghai
201801
Phone: (+86) 21 59159629
Domestic Sales
www.gardena.com.cn

Colombia

Husqvarna Colombia S.A.
Calle 18 No. 68 D-31, zona
Industrial de Montevideo
Bogotá, Cundinamarca
Tel. 571 2922700 ext. 105
jairo.salazar@
husqvarna.com.co

Costa Rica

Consumer Exim
Euroiberamericana S.A.
Los Colegios, Moravia,
200 metros al Sur del Colegio
Saint Francis – San José
Phone: (+506) 297 6883
exim_euro@racsa.co.cr

Croatia

SILK ADRIA d.o.o.
Josipa Lončara 3
10090 Zagreb
Phone: (+385) 1 3794 580
silk.adria@zg-t-com.hr

Cyprus

Med Marketing
17 Digeni Akritas Ave
P.O. Box 27017
1641 Nicosia

Czech Republic

Husqvarna Česko s.r.o.
Türkova 2319/5b
149 00 Praha 4 – Chodov
Bežplatná infolinika:
800 100 425
servis@cz.husqvarna.com

Denmark

GARDENA / Husqvarna
Consumer Outdoor Products
Salgsafdelning Danmark
Box 9003
S-200 39 Malmö
info@gardena.dk

Dominican Republic

BOSQUESA, S.R.L.
Carretera Santiago Licey
Km. 5 ½
Esquina Copal II.
Santiago, Dominican Republic
Phone: (+809) 736-0333
joserbosquesa@claro.net.do

Ecuador

Husqvarna Ecuador S.A.
Arujos E1-181 y 10 de Agosto
Quito, Pichincha
Tel. (+593) 22800739
francisco.jacome@
husqvarna.com.ec

Estonia

Husqvarna Eesti OÜ
Consumer Outdoor Products
Kesk tee 10, Aaviku küla
Rae vald
Harju maakond
75005 Estonia
kontakt.etj@husqvarna.ee

Finland

Oy Husqvarna Ab
Consumer Outdoor Products
Lauttarhankatu 8 B / PL 3
00581 HELSINKI
info@gardena.fi

France

GARDENA France
Inmécible Expositif
9-11 allée des Pierres Mayettes
ZAC des Barbanniers, B.P. 99
F- 92232 GENNEVILLIERS
cedex
Tél. (+33) 01 40 85 30 40
service.consommateurs@
gardena.fr

Georgia

AJD Group
Beliashevli 8
1159 Tbilisi

Great Britain

Husqvarna UK Ltd
Preston Road
Aycliffe Industrial Park
Newton Aycliffe
County Durham
DL5 6UP
info.gardena@
husqvarna.co.uk

Greece

HUSQVARNA ΕΛΛΑΣ Α.Ε.Β.Ε.
Υπ. /μυ Ηρώδιου 33Α
Βρ. Πλ. Κορωπίου
194 00 Κορωπί Αττικής
V.A.T. EL09409640
Phone: (+30) 210 6620 225
info@husqvarna-consumer.gr

Hungary

Husqvarna Magyarországt Kft.
Ezred u. 1-3
1044 Budapest
Telephone: (+36) 1 251-4161
vevozsolgalat.husqvarna@
husqvarna.hu

Iceland

O. Johnson & Kaaber
Tunguhalsi 1
110 Reykjavik
ooj@oik.is

Ireland

Husqvarna UK Ltd
Preston Road
Aycliffe Industrial Park
Newton Aycliffe
County Durham
DL5 6UP
info.gardena@
husqvarna.co.uk

Italy

Husqvarna Italia S.p.A.
Via Como 72
23868 VALMADRERA (LC)
Phone: (+39) 0341.203.111
info@gardenaitalia.it

Japan

KAKIUCHI Co. Ltd.
Sumitomo Realty &
Development Kojimachi
BLDG., 8F
5-1 Nibanncyo
Chiyoda-ku
Tokyo 102-0084
Phone: (+81) 33 264 7271
m_ishihara@kaku-ichi.co.jp

Kazakhstan

LAMED Ltd.
155/11, Tazhibayevy Str.
050060 Almaty
IP Schmidt
Abayavenue 3B
110 005 Kostanay

Kyrgyzstan

Alye Maki
av. Molodaya Guardir J 3
720014
Bishkek

Latvia

Husqvarna Latvija
Consumer Outdoor Products
Bakūži iela 6
LV-1024 Rīga
info@husqvarna.lv

Lithuania

UAB Husqvarna Lietuva
Consumer Outdoor Products
Ateities pl. 77C
LT-52104 Kaunas
centras@husqvarna.lt

Luxembourg

Magasins Jules Neuberg
39, rue Jacques Stas
Luxembourg-Gasperich 2549
Case Postale No.12
Luxembourg 2010
Phone: (+352) 40 140 101
api@neuberg.lu

Mexico

AFOSA
Av. Lopez Mateos Sur # 5019
Col. La Calma 45070
Zapopan, Jalisco
Mexico
Phone: (+52) 33 3818-3434
icornejo@afosa.com.mx

Moldova

Convel S.R.L.
290A Muncesti Str.
2002 Chisinau

Netherlands

GARDENA Nederland B.V.
Postbus 50176
1305 AD ALMERE
Phone: (+31) 36 521 00 00
info@gardena.nl

Neth. Antilles

Jonka Enterprises N.V.
Sta. Rosa Weg 196
P.O. Box 8200
Curaçao
Phone: (+599) 9 767 66 55
pgm@jonka.com

New Zealand

Husqvarna New Zealand Ltd.
PO Box 76-437
Manukau City 2241
Phone: (+64) (0) 9 9202410
support.nz@husqvarna.co.nz

Norway

GARDENA
Husqvarna Consumer
Outdoor Products
Salgskontor Norge
Kleveveien 6
1540 Vestby
info@gardena.no

Peru

Husqvarna Perú S.A.
Jr. Ramón Cárcamo 710
Lima 1
Tel.: (+51) 1 3320400 ext. 416
juan_remuigo@
husqvarna.com

Poland

Husqvarna
Poland Spółka z o.o.
ul. Wysockiego 15 b
03-371 Warszawa
Phone: (+48) 22 330 96 00
gardena@husqvarna.com.pl

Portugal

Husqvarna Portugal, SA
Lagoa - Albarraque
2635 - 595 Rio de Mouro
Tel.: (+351) 21 922 85 30
Fax: (+351) 21 922 85 36
info@gardena.pt

Romania

Madex International Srl
Soseaua Odaii 117- 123,
RO 013603
București, S1
Phone: (+40) 21 352.76.03
madex@mes.ro

Russia

ООО „Хускварна“
141400, Московская обл.,
г. Химки,
улица Ленинградская,
владение 39, стр.6
Бизнес Центр
„Химки Бизнес Парк“,
помещение ОВ02_04

Serbia

Domel d.o.o.
Autoput za Novi Sad bb
11273 Belgrade
Phone: (+381) 11 848 88 12
miroslav.jejina@domel.rs

Singapore

Hy-Ray PRIVATE LIMITED
40 Jalan Pemimpin
02-08 Tat Ann Building
Singapore 577185
Phone: (+65) 6253 2277
shiyang@hyray.com.sg

Slovak Republic

Husqvarna Česko s.r.o.
Türkova 2319/5b
149 00 Praha 4 – Chodov
Bežplatná infolinika:
800 154 044
servis@sk.husqvarna.com

Slovenia

Husqvarna Austria GmbH
Consumer Products
Industriezeile 36
4010 Linz
Tel.: (+43) 732 77 01 01-90
consumer.service@
husqvarna.at

South Africa

Husqvarna
South Africa (Pty) Ltd
Postnet Suite 250
Private Bag X6,
Cascades, 3202
South Africa
Phone: (+27) 33 846 9700
info@gardena.co.za

Spain

Husqvarna España S.A.
C/ Basauri, nº 6
La Florida
28023 Madrid
Phone: (+34) 91 708 05 00
atencioncliente@gardena.es

Suriname

Agrofix n.v.
Verlengde Hogestraat #22
Phone: (+597) 472426
agrofix@sr.net
Pobox : 2006
Paramaribo
Suriname – South America

Sweden

Husqvarna AB
S-561 82 Huskvarna
se info@gardena.se

Switzerland / Schweiz

Husqvarna Schweiz AG
Consumer Products
Industriestrasse 10
5506 Mägenwil
Phone: (+41) (0) 848 800 464
info@gardena.ch

Turkey

GARDENA Dost Diş Ticaret
Mimensekili A.Ş.
Sanayi Cad. Adil Sokak
No: 1/B Kartal
34873 Istanbul
Phone: (+90) 216 389 9399
info@gardena-dost.com.tr

Ukraine / Україна

ТОВ «Хусарна Україна»
вул. Васильківська, 34,
офіс 204-г
03022, Київ
Tel: (+380) 444 498 39 02
info@gardena.ua

Uruguay

FELI SA
Entre Rios 1083 CP 11800
Montevideo – Uruguay
Tel: (+598) 22 03 18 44
info@felisa.com.uy

Venezuela

Corporación Casa y Jardín C.A.
Av. Caroní, Edif. Trezmen, PB.
Colinas de Bello Monte,
1050 Caracas.
Tlf: (+58) 212 992 33 22
info@casayjardin.net.ve

1862-28.960.05/0212

© GARDENA

Manufacturing GmbH

D-89070 Ulm

http://www.gardena.com

Free Manuals Download Website

<http://myh66.com>

<http://usermanuals.us>

<http://www.somanuals.com>

<http://www.4manuals.cc>

<http://www.manual-lib.com>

<http://www.404manual.com>

<http://www.luxmanual.com>

<http://aubethermostatmanual.com>

Golf course search by state

<http://golfingnear.com>

Email search by domain

<http://emailbydomain.com>

Auto manuals search

<http://auto.somanuals.com>

TV manuals search

<http://tv.somanuals.com>