

V1 Art. 1252

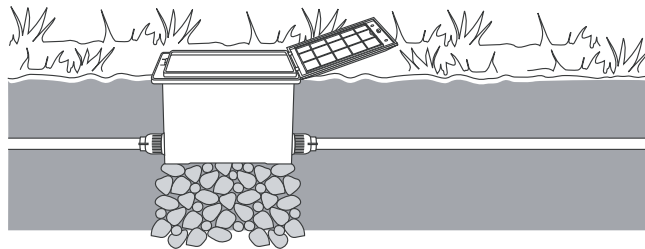

V2 Art. 1253

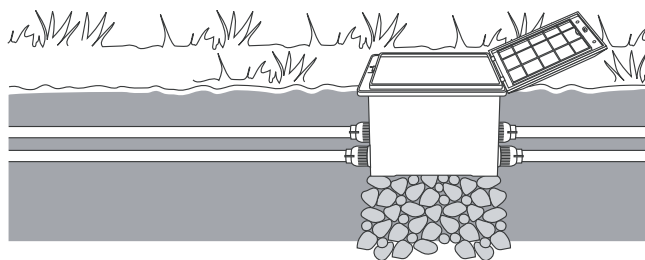

- D** **Gebrauchsanweisung**
Bewässerungsventil
-
- GB** **Operating Instructions**
Irrigation Valve
-
- F** **Mode d'emploi**
Bloc-vanne
-
- NL** **Gebruiksaanwijzing**
Beregeningsventiel
-
- S** **Bruksanvisning**
Ventildosa
-
- I** **Istruzioni per l'uso**
Valvola cordless
-
- E** **Manual de instrucciones**
Válvula de riego
-
- P** **Instruções de utilização**
Válvula de Irrigação
-
- DK** **Brugsanvisning**
Vandingsventil

D

GB

F

NL

S

I

E

P

DK

GARDENA Irrigation Valve V1 / V2

Welcome to the Garden of GARDENA...



Please read these operating instructions carefully and observe the notes given. Use these operating instructions to familiarise yourself with the Irrigation Valve, its correct use and the notes on safety.



For safety reasons, children under 16 as well as persons not familiar with these operating instructions should not use this Irrigation Valve.

→ Please keep these operating instructions in a safe place.

Contents

1. Where to Use Your GARDENA Irrigation Valve	10
2. For Your Safety	11
3. Assembly	11
4. Operation	14
5. Maintenance	14
6. Trouble-Shooting	15
7. Protection against Frost	15
8. Accessories	16
9. Technical Data	16
10. Service	16

1. Where to Use Your GARDENA Irrigation Valve

Intended use

This Irrigation Valve, in conjunction with the Programming Unit **1242** and the Control Unit **1250** or with the Central Radio Control Unit **1243** and the Radio Receiver **1244/1245**, forms part of a watering system for your garden.

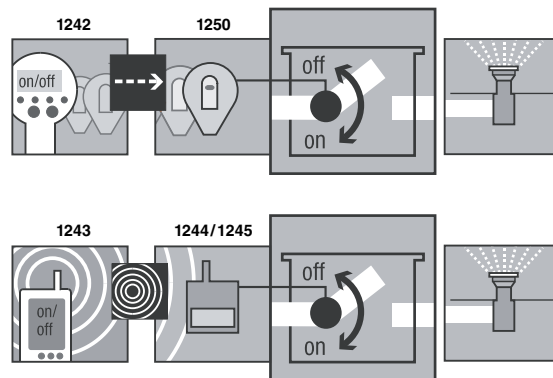

The Watering Valves are intended solely for outdoor use for fully automatic control of individual irrigation systems. It is a benefit to arrange a watering system into separate sections in case of varying watering needs for different plant areas or if there is insufficient water available for simultaneous operation of the entire watering system.

The Irrigation Valve is installed upstream in the watering system (e.g. Pop-up Sprinklers; Micro-Drip-System), for example, in the ground.

Compliance with the enclosed operating instructions provided by GARDENA is a prerequisite for proper use of the Irrigation Valve.

Please note



The Irrigation Valve must only be used in conjunction with the Control Units / Radio Receivers approved by GARDENA.

2. For Your Safety



→ Pay attention to the safety notes on the valve box.

Warning!

→ Please read the operating instructions before using the Irrigation Valve for the first time.

Winter Storage

→ Before the frost period starts: see point 7. Protection against Frost, "Winter storage".

→ Please observe the notes on safety in the operating instructions.

→ In the case of dirty, sandy or contaminated water, the GARDENA Central Filter Art. No. 1506 must be installed upstream in the watering system.

Blocking the Irrigation Valve

Water pressure

The function of your watering system depends on the available water pressure. Therefore, care should be taken not to overlap watering cycles of the various watering circuits and to ensure that the watering circuits you have planned will be supplied with sufficient water at an adequate pressure.

Please refer to the planning instructions in the packaging of Pop-up Sprinklers or the special brochure entitled "Watering Systems – Sprinkler System Planning Guide" available from GARDENA.

3. Assembly

Install the valve box:

The Irrigation Valve is installed below ground level, however it can also be used above the ground.

1. Draw up a plan (an example is shown in the figure below).

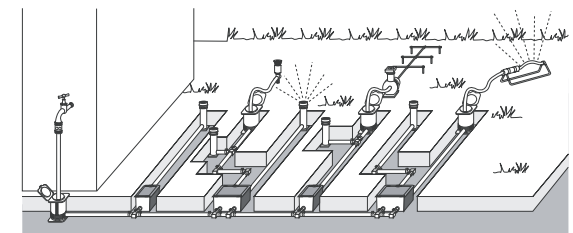

Additional information is provided in the GARDENA Sprinkler System Planning Guide which is available from your GARDENA dealer.

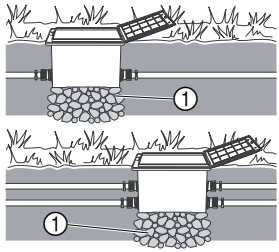

Connect GARDENA connecting pipes to valve box:

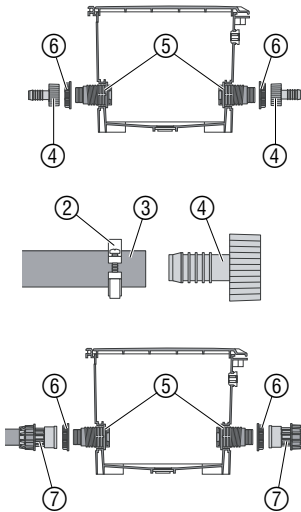

2. For underground installation, place a layer of coarse gravel ① approx. 20 x 30 x 10 cm³ (V1) / 30 x 35 x 10 cm³ (V2) underneath the valve box. *This ensures proper drainage of the box.*
3. Install the valve box with the top edge of the box at ground level. *This avoids damage when mowing the lawn.*

You can use the **GARDENA Connecting Pipe Art. No. 1580/1582** ③ and **GARDENA Hose Clips Art. No. 1591** ② to connect the valve box.

1. Push the nipples ⑤ from the inside into the box openings.
2. Fasten the nipples ⑤ to the valve box from the outside using the nuts ⑥.
3. Screw a tap connector ④ on each nipple ⑤.
4. Push a hose clip ② over each pipe end ③.

Tip: Place the pipe ends ③ in warm water to make it easier to push the ends of the pipes ③ onto the tap connectors ④.

5. Push the connecting pipes ③ onto the tap connectors ④ and secure with the hose clips ②.

Note: You can also attach a **GARDENA Connector Art. No. 2745/2749** ⑦ (1" = 25 mm / 5/4" = 32 mm) to the nipples ⑤ for connecting hard connecting pipes or other commercially available connecting pipes.

After connecting the pipes to the valve box, the system must be flushed.

Flush the system:

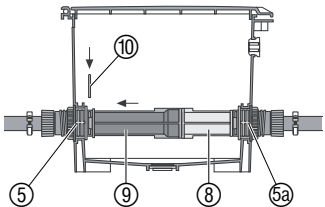

Flushing the system after routing the pipes prevents contaminating the valves.

1. Push the long telescopic pipe ⑧ all the way into the nipple on the outlet-side ⑤a.
2. Push the flushing pipe ⑨ into the nipple on the inlet-side ⑤.
3. Push the bracket ⑩ into the elongated holes of the nipple on the inlet-side ⑤. *The flushing pipe ⑨ is fixed in place.*
4. Screw the long telescopic pipe ⑧ onto the flushing pipe ⑨.
5. Turn on the water supply at the nipple ⑤. *The system is flushed.*
6. Remove the flushing pipe ⑨.

Close off nipple on inlet-side:

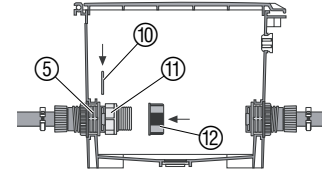

Assemble the Irrigation Valve:

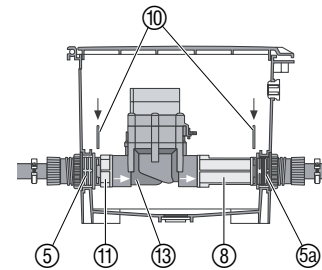

If you connect several Irrigation Valves to one water supply, then each pipe must be flushed separately in order to obtain an adequate flushing pressure. To do this:

1. Push the short telescopic pipe ⑪ into the nipple on the inlet-side ⑤ which is not to be flushed.
2. Push the bracket ⑩ into the elongated holes of the nipple on the inlet-side ⑤. *The short telescopic tube ⑪ is fixed in place.*
3. Screw the end cap ⑫ onto the short telescopic pipe ⑪.

The integrated solenoid valve only works correctly with the Irrigation Valve connected in flow direction.

Flow direction
→ Pay attention to the flow direction (arrows) when assembling the Irrigation Valve ⑬.

1. Push the long telescopic pipe ⑧ all the way into the nipple on the outlet-side ⑤a.
2. Screw the short telescopic pipe ⑪ into the inlet side of the Irrigation Valve ⑬. *The arrows on the Irrigation Valve point in the flow direction.*
3. Push the short telescopic pipe ⑪ into the nipple on the inlet-side ⑤.
4. Screw the long telescopic pipe ⑧ into the outlet-side of the Irrigation Valve ⑬.
5. Push the bracket ⑩ into the elongated holes of the nipples ⑤/⑤a. *The telescopic pipes ⑧/⑪ are fixed in place.*

When you open the box lid ⑭ you can see the flow direction marked by the arrows on the Irrigation Valve ⑬.

Lock the box lid:

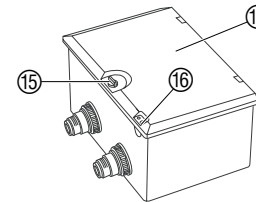

→ The box lid ⑭ can be locked by turning the lever ⑮ by 90°.

The box lid ⑭ can be locked as a protection against theft.

→ Overlap the holes ⑯ of the valve box and the box lid and lock using a small padlock
– or –
alternatively, the lid ⑭ can be safeguarded against theft using a sheet metal screw (4.2 x 19).

Connect Soil Moisture Sensor or Rain Sensor electronic (optional):

In conjunction with the programmed watering time, the moisture level of the soil or the natural precipitation can be taken into account for each Irrigation Valve.

When a sufficient moisture content of the soil is reached, a programme may be interrupted or activation of a programme may be suppressed.

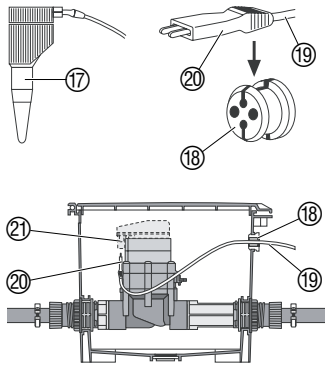

- Place the Soil Moisture Sensor ⑰ in the area to be irrigated – or – the Rain Sensor electronic (if necessary with an extension cable) **outside** of the area to be irrigated
- Thread the connecting cable ⑱ of the sensor ⑰ through one of the two stopper slits ⑱.
- Adjust the cable length ⑲ in the box as required.
- Press the stopper ⑱ back into box wall.
- Plug the connector ⑳ into the sensor socket ㉑ of the Control Unit / Radio Receiver.

4. Operation

Adjusting valve control:

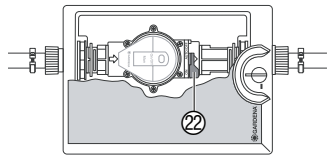

Fully Automatic Control:

- Set selection lever ㉒ to “**AUTO/OFF**”.
- Programme-controlled water flow to the watering system according to the programming in the Control Unit / Radio Receiver.*
- An automatically opened valve cannot be closed manually.

Manual Control:

- Set selection lever ㉒ to “**ON**”. *Permanent water flow, independent of the programming.*

5. Maintenance

Replacing the foam inlay:

- The foam inlay ㉔ of the draining outlet prevents insects (especially ants) from entering.
- Please contact your nearest GARDENA Service Centre for replacing the foam inlay ㉔.

Replacing the box lid:

- The box lid is step-proof and attached to the box by hinges.
- Open the box lid ⑭.
 - Push the lid ⑭ backwards and out of the hinges ㉕.
 - Fit the new lid in the reverse order.

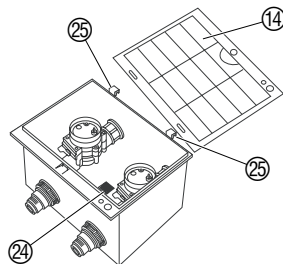

6. Trouble-Shooting

Fault	Possible Causes	Remedy
Solenoid valve does not open, no water flow	Control Unit / Radio Receiver not connected correctly to solenoid valve.	→ Connect Control Unit / Radio Receiver correctly to solenoid valve.
	No water supply.	→ Turn on water supply.
	Pipe closed.	→ Remove end cap ⑫.
Solenoid valve does not close, continuous water flow	Solenoid valve installed opposite to flow direction.	→ Turn solenoid valve in box (observe the flow direction).
	Selection lever ㉒ set to “ ON ”.	→ Set selection lever ㉒ to “ AUTO/OFF ”.
Pipe slides off nipple	Hose clips ② are too loose.	→ Tighten hose clips ② (see “3. Assembly”).

If other faults occur, please contact GARDENA Customer Service.

7. Protection against Frost

Winter storage

Valves can be easily removed from the box.

The following precautions must be taken – especially before the frost period starts – to prevent damage to the Irrigation Valves and the entire watering system:

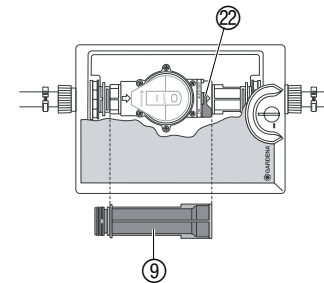

- Close the water tap and disconnect the hose from the **GARDENA Water Connection Point Art. No. 1594**. *This allows air to flow freely.*
- If the watering system is directly connected to the water tap, turn off the water supply and open the venting tap.
- Set the selection lever ㉒ of all valves to the “**ON**” position.
- Empty the system (e.g. using compressed air)
 - or –
 - on slopes remove the valve located at the lowest level and store safe from frost
 - or –
 - remove all valves and store safe from frost.
- After removing the valve, install the flushing pipe ⑨ (see “3. Assembly”, “*Flush the system*”). *Prevents dirt collecting in the system.*
- Remove the battery from the Control Unit / Radio Receiver.
- Lock the box lid (see “3. Assembly”, “*Lock the box lid*”).

8. Accessories

Connection	GARDENA Connecting Pipe	• Art. No. 1580 / 1582
	GARDENA Hose Clip	• Art. No. 1591
Control	GARDENA Radio Receiver R2/R4	• Art. No. 1244 / 1245
	GARDENA Control Unit	• Art. No. 1250
	GARDENA Soil Moisture Sensor	• Art. No. 1187
	GARDENA Rain Sensor electronic	• Art. No. 1189
	GARDENA Extension Cable for Soil Moisture Sensor and Rain Sensor electronic	• Art. No. 1186
Filter	GARDENA Central Filter	• Art. No. 1506

9. Technical Data

Solenoid Valve	Operating pressure	1 to 12 bar
	Flow medium	clean fresh water
	Max. water temperature	40 °C

10. Service

Warranty

GARDENA guarantees this product for 2 years (from date of purchase). This guarantee covers all serious defects of the unit that can be proved to be material or manufacturing faults. Under warranty we will either replace the unit or repair it free of charge if the following conditions apply:

- The unit must have been handled properly and in keeping with the requirements of the operating instructions.
- Neither the purchaser or a non-authorized third party have attempted to repair the unit.

Faults with the Irrigation Valve caused by incorrectly installed batteries or leaking batteries in the Control Unit / Radio Receiver are not covered by the guarantee.

This manufacturer's guarantee does not affect the user's existing warranty claims against the dealer/seller.

If a fault occurs with your Irrigation Valve, please return the faulty unit together with a copy of the receipt and a description of the fault, with postage paid to one of the GARDENA Service Centres listed on the back of these operating instructions.

Product Liability

We expressly point out that, in accordance with the product liability law, we are not liable for any damage caused by our units if it is due to improper repair or if parts exchanged are not original GARDENA parts or parts approved by us, and, if the repairs were not carried out by a GARDENA Service Centre or an authorised specialist. The same applies to spare parts and accessories.

Deutschland

GARDENA Kress + Kastner GmbH
GARDENA Service
Hans-Lorensen-Straße 40
D-89079 Ulm
Produktfragen: (07 31) 490-123
Reparaturen: (07 31) 490-290

Argentina

Argensem S.A.
Venezuela 1075
(1618) El Talar - Buenos Aires

Australia

NYLEX Consumer Division
76-88 Mills Road
P.O. Box 722
Braeside 3195
Melbourne, Victoria

Austria

GARDENA Österreich Ges. m.b.H.
Stettnerweg 11-15
2100 Korneuburg

Belgium

MARKT (Belgium) NV/SA
Sterrebeekstraat 163
1930 Zaventem

Brazil

M. Cassab
Av. das Nações Unidas, 20.882
Santo Amaro, CEP 04795-000
São Paulo - S.P.

Bulgaria / България

ДЕНЕКС ООД
Бул. "Г.М.Димитров" 16 ет.4
София 1797

Canada

GARDENA Canada Ltd.
100 Summerlea Road
Brampton, Ontario
Canada L6T 4X3

Chile

Antonio Martinic Y CIA. LTDA.
Gilberto Fuenzalida 185 Loc.
Las Condes - Santiago de Chile

Costa Rica

Compania Exim
Euroiberoamericana S.A.
Av. 12 bis Calle 16 y 18
Bodegas Keith y Ramirez
San José

Cyprus

FARMOKIPIKI LTD
P.O. Box 7098
74, Digeni Akrita Ave.
1641 Nicosia

Czech Republic

GARDENA spol. s.r.o.
Řípská 20a, č.p. 1153
62700 Brno

Denmark

GARDENA Danmark A/S
Naverland 8
2600 Glostrup

Finland

Habitec Oy
Martinkyläntie 52
01720 Vantaa

France

GARDENA France
Service Après-Vente
BP 50080
95948 ROISSY CDG Cedex

Great Britain

GARDENA UK Ltd.
27-28 Brenkley Way
Blezard Business Park
Seaton Burn
Newcastle upon Tyne NE13 6DS

Greece

Agrokip G. Psomadopoulos & Co.
33a, Ifestou str.
Koropi 194 00
Athens

Hungary

GARDENA Magyarország Kft.
Késmárk utca 22
1158 Budapest

Iceland

Heimilistaeki hf
Saetun 8
P.O. Box 5340
125 Reykjavik

Republic of Ireland

Michael McLoughlin & Sons
Hardware Limited
Long Mile Road
Dublin 12

Italy

GARDENA Italia S.r.l.
Via Donizetti 22
20020 Lainate (Mi)

Japan

KAKUDAI Mfg. Co. Ltd.
1-4-4, Itachibori Nishi-ku
Osaka 550

Luxembourg

Magasins Jules Neuberg
Grand Rue 30
Case Postale No. 12
Luxembourg 2010

Netherlands

GARDENA Nederland B.V.
Postbus 50176
1305 AD ALMERE

Neth. Antilles

Jonka Enterprises N.V.
Sta. Rosa Weg 196
P.O. Box 8200
Curaçao

New Zealand

NYLEX New Zealand Limited
Private Bag 94001
South Auckland Mail Centre
10 Offenhauser Drive
East Tamaki, Manukau

Norway

GARDENA Norge A/S
Postboks 214
2013 Skjetten

Poland

GARDENA Polska Sp. z o.o.
Szymanów 9 d
05-532 Baniocza

Portugal

GARDENA, Lda.
Recta da Granja do Marquês
Edif. GARDENA
Algueirão
2725-596 Mem Martins

Russia / Россия

АО АМИДА ТТЦ
ул. Мосфильмовская 66
117330 Москва

Singapore

Variware
Holland Road Shopping Centre
227-A 1st Fl., Unit 29
Holland Avenue
Singapore 1027

Slovenia / Croatia

Silk d.o.o. Trgovina
Brodišče 15
1236 Trzin

South Africa

GARDENA South Africa (Pty.) Ltd.
P.O. Box 11534
Vorna Valley 1686

Spain

ANMI Andreu y Miriam S.A.
Calle Pere IV, 111
08018 Barcelona

Sweden

GARDENA Svenska AB
Box 9003
20039 Malmö

Switzerland

GARDENA Kress + Kastner AG
Bitziberg 1
8184 Bachenbülach

Ukraine / Украина

АОЗТ АЛЬЦЕСТ
ул. Гайдара 50
г. Киев 01033

Turkey

Dost Diş Ticaret Müessesilik A.Ş.
Yeşilbağlar Mah. Başkent
Cad. No. 26
Pendik - İstanbul

USA

GARDENA
3085 Shawnee Drive
Winchester, VA 22604

1252-20.960.04/0021

© GARDENA Kress + Kastner GmbH
Postfach 27 47, D-89070 Ulm
<http://www.gardena.com>

Free Manuals Download Website

<http://myh66.com>

<http://usermanuals.us>

<http://www.somanuals.com>

<http://www.4manuals.cc>

<http://www.manual-lib.com>

<http://www.404manual.com>

<http://www.luxmanual.com>

<http://aubethermostatmanual.com>

Golf course search by state

<http://golfingnear.com>

Email search by domain

<http://emailbydomain.com>

Auto manuals search

<http://auto.somanuals.com>

TV manuals search

<http://tv.somanuals.com>