

WIDE PLASMA DISPLAY
P42VHA40E
P42VHA40Z



Plasmavision™



Contents

	Page
Before Use	
• INFORMATION	E-2
• CHECKING ACCESSORIES	E-3
• INSTALLATION	E-4
Others	
• OPTIONS	E-5
• SPECIFICATION	E-6

Before using the display, read this manual carefully so that you know how to use the display correctly.

Refer to this manual whenever questions or problems about operation arise. Be sure to read and observe the safety precautions (see the separate "Safety Precautions" manual).

Keep this manual where the user can see it easily.

** Installation and removal require special expertise. Consult your product dealer for details.*

** When "English" is selected at "Language" of the on-screen display, "colour" will be displayed in the case of the E model and "color" will be displayed for all other models.*

The notation used in this user's manual is "color".

** The last digit of MODEL NO. (10 digit alphanumeric characters) indicated on the product means the body color indication alphabet or the management number.*

INFORMATION

- Receptacle

Make sure that the power cable's grounding wire is grounded.

The display comes with a 3-prong power plug; one prong is connected to the grounding wire. If you have only a 2-hole receptacle, you will need to have it replaced. Contact your dealer for more information.

- Have the display inspected and cleaned by your dealer at regular intervals.
- Pictures may become "burnt" into the screen phosphors if the screen is left on for extended periods. To ensure that the display has a prolonged service life, be sure to use a screen orbiter, white screen. This will ensure the same picture or pattern is not constantly displayed for long periods.
- Extremely high-precision technology has been used in the manufacture of the plasma display panel, with the effective pixel elements exceeding 99.99%. Please be aware, however, that fewer than 0.01% of the pixels may be missing or remain constantly lit.
- Some models are fitted with a radiator fan to prevent the display's internal temperature from rising during operation. Be careful of the air emitted by the radiator fan, as it may be hot.
- Contact your dealer if you find that the display does not seem to function properly when used with other audio-visual equipment.
You may need to move your display if it produces degraded pictures or noise due to electromagnetic radiation, or if the infrared remote control does not function properly.
- Pictures may not be displayed properly if you connect a non-standard PC to the RGB input terminal. In this case, contact your dealer for more information.
- The protective circuit, built into the display, automatically turns off the power if the display has a problem. In this case, you will see that the power indicator lamp flashes red or green.



Warning

If the power indicator lamp flashes red or green, this signifies that the display has developed a problem. When this happens, be sure to remove the power plug from the receptacle to prevent fire or electric shock. Then contact your dealer.

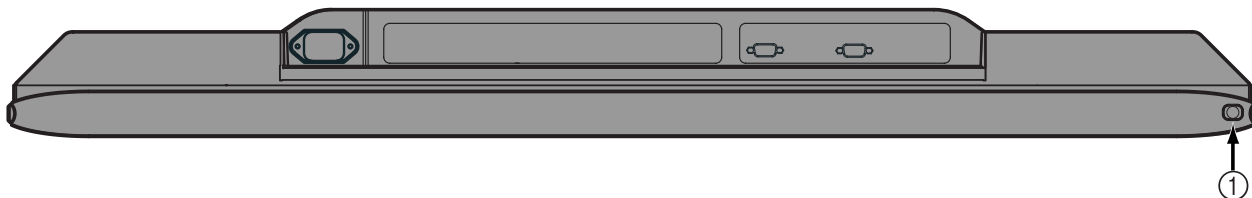
- Install the display in a location close to a main power supply outlet, and where the emergency stop button can be easily reached.



① power switch

- When pressed while in the "OFF" state, the power indicator lamp lights and the display is placed in the "ON " state, and the power can be turned "ON" or "OFF" by the remote control or on the control panel of the display. When pressed while in the "ON " state, the power indicator lamp goes out and the display is placed in the "OFF" state where power is still partly supplied.

Note

- Cables for connecting the display to external equipment are not supplied. Contact your dealer for more information on these products.
- In order to facilitate the explanations, pictures and diagrams in this manual may differ slightly from the actual items.

CHECKING ACCESSORIES

Display Section

Two user's manuals

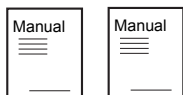

One remote control



Two AA batteries



One power cable

One ferrite core



No.:SFT-72SN
Mfr.:TKK

CONNECTING THE DISPLAY TO EXTERNAL EQUIPMENT

Carefully check the terminals for position and type before making any connections.

Loose connectors can result in picture or color problems. Make sure that all connectors are securely inserted into their terminals.

Ferrite core

Ferrite core is used to attenuate undesired signals.

When connecting a cable to the power input terminal, attach the ferrite core to the cable near the terminal.

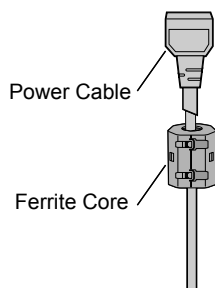

INSTALLATION

To prevent the display's internal components from overheating, make sure that the display is installed in a well-ventilated location.

Be sure to use the optional stand, wall-mounting unit or the other unit when installing the display. Also, be also sure that your dealer performs the installation.

See the appropriate instruction manual for more information on the installation hardware you select.

To prevent an accident and ensure safety in the event of an earthquake, fix the display securely into position as described below.

To ensure proper heat radiation, provide at least as much space around the display as shown below.

* Make sure that the display is installed in a location where the temperature can be maintained between 0°C and 40°C.

* Never attempt to tilt the display sideways or backward.

* To prevent the power and other cables from being accidentally pulled, make sure that they run along the wall or through corners.

* To prevent accidents and ensure safety in the event of an earthquake, secure the display to prevent it from tipping over.

Display Section

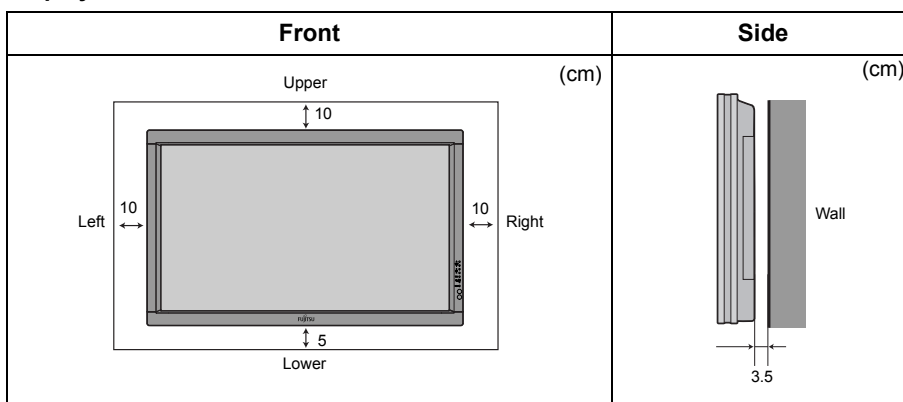

Note

The display is a highly precise piece of equipment and therefore must be packed properly before transportation. Be sure to use only those packing materials originally supplied with the display when repacking it.

Reference

See P. E-5 for more information on options.

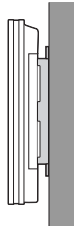
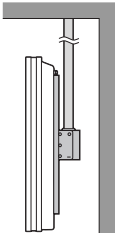
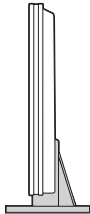
Wall-mounting Bracket	0° to 15° mounting angle	P-WB4201	
Ceiling unit	0° to 15° mounting angle	P-CT4200	
Desktop Stand unit		P-TT4202	

- * When installing an option, make sure that all installation requirements for that option (as given in the relevant instruction manual) are met.
- * The colors of options do not match the display colors perfectly.
- * To improve the function and performance of optional accessories, specifications and part names may change. Consult your local dealer before purchasing.

Warning

To prevent injury, fire, and electric shock, arrange for options to be initially installed (or installed at a different location) by your dealer.

CAUTION

This display (P42VHA40) is for use only with Fujitsu General Limited's option (P-WB4201, P-CT4200, P-TT4202).
Using this display with other option can cause instability resulting in possible injury.

SPECIFICATION

WIDE PLASMA DISPLAY

Model	P42VHA40E/Z
Screen size	42" wide screen: 92.1 cm (W) x 51.8 cm (H) (105.7 cm diagonal) 36.3 inch (W) x 20.4 inch (H) (41.6 inch diagonal)
Aspect ratio	16:9 (wide)
Number of pixels	852 (H) x 480 (V)
Weight	31.5 kg / 69 lbs
Outer dimensions	103.9 (W) x 64.0 (H) x 8.7 (D) cm 40.9 (W) x 25.2 (H) x 3.4 (D) inch (does not include outer projections)
Power supply	110-240 VAC 50/60 Hz
Current rating	4.2-1.7 A
Operating conditions	Temperature: 0 to 40 °C / 32 to 104 °F Humidity: 20 to 80 %
Accessories	2 user's manual, 1 power cable, 1 remote control, 2 AA batteries, 1 ferrite core

Regulation

- UL, CSA Safety: UL6500, C-UL
EMC: FCC Part 15 Class B, ICES-003 Class B
- CE Safety: EN60065
EMC: EN55022 1998, Class B
EN61000-3-2 1995
EN61000-3-3 1995
EN55024 1998
EN61000-4-2 1995
EN61000-4-3 1996
EN61000-4-4 1995
EN61000-4-5 1995
EN61000-4-6 1996
EN61000-4-8 1993
EN61000-4-11 1994
- AS Safety: IEC60065
EMC: AS/NZS 3548

Note

- Specifications and external appearance may be change for the sake of improvement.
- Viewing the screen constantly for extended periods can strain your eyes. Be sure to stay at a proper distance (at least 1.5 m or 5 feet for 42") from the screen and to look occasionally away while working.
- **Plasmavision**™ is a worldwide trademark of Fujitsu General Limited and is a registered trademark in Japan, the U.S.A. and other countries or areas.

Free Manuals Download Website

<http://myh66.com>

<http://usermanuals.us>

<http://www.somanuals.com>

<http://www.4manuals.cc>

<http://www.manual-lib.com>

<http://www.404manual.com>

<http://www.luxmanual.com>

<http://aubethermostatmanual.com>

Golf course search by state

<http://golfingnear.com>

Email search by domain

<http://emailbydomain.com>

Auto manuals search

<http://auto.somanuals.com>

TV manuals search

<http://tv.somanuals.com>