

ELECTRONIC OVEN CONTROL

Control Pad Features

READ THE INSTRUCTIONS CAREFULLY BEFORE USING THE OVEN. For satisfactory use of your oven, become familiar with the various features and functions of the oven as described below. **Detailed instructions for each feature and function follow later in this Use & Care Guide.**

Convection Bake— Use to select the Convection Bake feature.

Speed Clean— Use to select the Speed Clean feature.

Oven Interior Light— Used to turn oven interior light ON and OFF.

Convection Convert— Use to select the Convection Convert feature.

Clean— Use to select the Self-Clean feature.

ClearOff— Used to clear any function previously entered except the time of day and minute timer. Press STOP CLEAR to stop cooking. Also the STOP CLEAR pad is used to activate oven lockout setting.

Preheat—Used to preheat the oven.

Bake Time— Used to enter the length of the baking time.

Clock— Used to set the time of day.

Bake—Used to select the bake function.

Convection Roast— Use to select the convection roasting mode.

Maxx Clean— Use to select the Maxx Clean feature.

Start— Use to start all oven features (not used with Oven Light).

Timer On/Off— Used to set or cancel the minute timer. The minute timer does not start or stop cooking. Also, TIMER SET/OFF Pad is used to set the Continuous Bake Feature.

Broil— Used to select the variable broil function.

Warm & Hold— Used to set the Warm & Hold feature.

0 Thru 9 Number Pads— Use to enter temperature and times.

Start Time— Used to set the desired start time for baking. May be used with COOK TIME to program a delayed bake cycle.

Minimum and Maximum Control Pad Settings

All of the features listed below have minimum and maximum time or temperature settings that may be entered into the control. An ENTRY acceptance beep will sound each time a control pad is touched (the Oven Lockout pad is delayed 3 seconds). An ENTRY ERROR tone (3 short beeps) will sound if the entry of the temperature or time is below the minimum or above the maximum settings for the feature.

FEATURE		MINIMUM VALUE	MAXIMUM VALUE
PREHEAT TEMP.		170°F/77°C	550°F/288°C
BAKE TEMP.		170°F/77°C	550°F/288°C
BROIL TEMP.		400°F/204°C	HI-550°F/288°C
KITCHEN TIMER	12 Hr.	0:01 Min.	11:50 Hr./Min.
	24 Hr.	0:01 Min.	11:50 Hr./Min.
CLOCK TIME	12 Hr.	1:00 Hr./Min.	12:59 Hr./Min.
	24 Hr.	0:00 Hr./Min.	23:59 Hr./Min.
OVEN COOK TIME	12 Hr.	0:01 Min.	11:50 Hr./Min.
	24 Hr.	0:01 Min.	11:50 Hr./Min.
CONVECTION BAKE		325°F/163°C	550°F/288°C
CONVECTION ROAST		300°F/149°C	550°F/288°C

Versión en español

Si desea obtener una copia en español de este Manual del Usuario, sírvase escribir a la dirección que se incluye a continuación. Solicite la P/N **318200133E**.

Spanish Owner's Guides
Frigidaire Company
P. O. Box 9061
Dublin, Ohio 43017-0961

Setting the Clock

Setting the Clock

The **CLOCK** (Clock) pad is used to set the clock. The clock may be set for 12 or 24 hour time of day operation. The clock has been preset at the factory for the 12 hour operation. When the range is first plugged in, or when the power supply to the range has been interrupted, the timer in the display will flash with "PF" (power failure, See Figure 1).

When **PF** appears in the display, press **Clear/Off**. A beep will sound and PF will disappear.



Figure 1

INSTRUCTIONS

To set the clock (example below for 1:30)

1. Press **Clock**. "TIME" will appear in the display (Figure 2).
2. Press **1** **3** **0** pads to set the time of day to 1:30 (Figure 3).

"TIME" will stay in the display. Press **START**. "TIME" will disappear and the clock will start (Figure 4).

PRESS

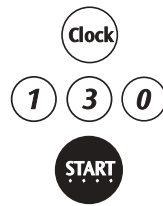

DISPLAY



Figure 2

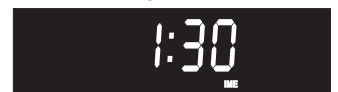

Figure 3



Figure 4

Changing between 12 or 24 hour time of day display

1. Press and hold **Clock** for 7 seconds (Figure 3). After 7 seconds, "12Hr" (Figure 5) or "24Hr" (Figure 6) will appear in the display and the control will beep once.
2. Press **Clean** to switch between the 12 and 24 hour time of day display. The display will show either "12Hr" (Figure 5) or "24Hr" (Figure 6).
3. Press **START** or **Clear/Off** or wait 5 seconds to accept the change.
4. Reset the correct time as described in **To set the Clock** above. Please note that if the 24 hour time of day mode was chosen, the clock will now display time from 0:00 through 23:59 hours.





Figure 5



Figure 6





Setting the Clock

Setting Continuous Bake or 12 Hour Energy Saving

The **KITCHEN TIMER**  and **CLEAN**  pads control the Continuous Bake or 12 Hour Energy Saving features. The oven control has a factory preset built-in 12 Hour Energy Saving feature that will shut off the oven if the oven control is left on for more than 11 hours and 59 minutes. The oven can be programmed to override this feature for Continuous Baking.

INSTRUCTIONS

To set the control for Continuous Bake or 12 Hour Energy Saving features

1. Press and hold  for 7 seconds (Figure 1). After 7 seconds "Off 12Hr Off" will appear in the display (Figure 2).
2. Press  to switch between the 12 Hour Energy Saving and continuous bake features. Note: "On 12Hr On" (Figure 3) in the display indicates the control is set for the 12 Hour Energy Saving mode and "Off 12Hr Off" indicates the control is set for the Continuous Bake feature (Figure 2).
3. Press  or  or wait 5 seconds to accept the change. (Figure 4; display will return to time of day).

PRESS

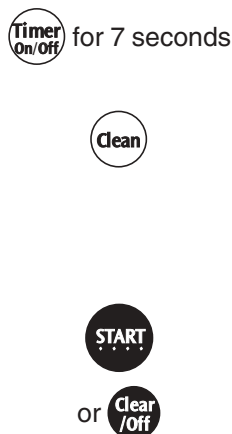

DISPLAY







Setting Kitchen Timer

The **KITCHEN TIMER**  pad controls the Kitchen Timer feature. The Kitchen Timer serves as an extra timer in the kitchen that will beep when the set time has run out. It does not start or stop cooking. The Kitchen Timer feature can be used during any of the other oven control functions. Refer to "Minimum and Maximum Control Pad Settings" for time amount settings.

INSTRUCTIONS

To set the Kitchen Timer (example: 5 minutes)

1. Press . "0:00" will appear and "TIMER" will flash in the display (Figure 5).
2. Press the number pads to set the desired time in the display (example ). Press . The time will begin to count down with "5:00" and "TIMER" will stay in the display (Figure 6). Note: If  is not pressed the timer will return to the time of day.
3. When the set time has run out, ":00" and "TIMER" will show in the display (Figure 7). The oven will beep until  is pressed.

PRESS



DISPLAY



To cancel the Kitchen Timer before the set time has run out

Press  twice until the clock displays ":0:00" and "TIMER". The display will return to the time of day.

Consumer Defined Control

Note: The Consumer Defined Control features are adjustments to the control that will not affect cooking results. These include the Oven Lockout, Temperature Display and Silent Control Operation features

Setting Oven Lockout Feature

The  pad controls the Oven Lockout feature. The Oven Lockout feature automatically locks the oven door and prevents the Oven from being turned on. It does not disable the interior oven lights.

INSTRUCTIONS

To activate the Oven Lockout feature

1. Press and hold  for 3 seconds (Figure 1).
2. After 3 seconds "Off" will appear in the display and a beep will sound. Once the oven door is locked "LOCK" will appear in the display (Figure 1).

To reactivate normal oven operation:

1. Press and hold  for 3 seconds. A beep will sound. "Off" will disappear from the display and "LOCK" will stay until the oven door has completely unlocked (Figure 2).
2. The wall oven is again fully operational (Figure 3).

PRESS

 for 3 seconds

 for 3 seconds

DISPLAY



Figure 1





Figure 2





Figure 3

Setting Silent Control Operation

The **STARTTIME**  and **CLEAN**  pads control the Silent Control operation feature. The Silent Control operation feature allows the oven control to be operated without sounds or beeps whenever necessary. If desired the control can be programmed for silent operation and later returned to operating with all the normal sounds and beeps.

INSTRUCTIONS

To change control from normal sound operation to silent control operation

1. To tell if your range is set for normal or silent operation press and hold  for 7 seconds. "On bEEp On" will appear in the display (Figure 4).
2. Press  to switch between normal sound operation and silent operation mode. The display will show either "On bEEp On" (Figure 4) or "Off bEEp Off" (Figure 5).
If "On bEEp On" appears (Figure 4), the control will operate with normal sounds and beeps. If "Off bEEp Off" appears (Figure 5), the control is in the silent operation mode.
3. Press  or wait 5 seconds to accept the change.

PRESS

 for 7 seconds





DISPLAY





Figure 4



Figure 5





Consumer Defined Control Features

Setting Temperature Display — Fahrenheit or Celsius

The **BROIL**  and **FLEX CLEAN**  pads control the Fahrenheit or Celsius temperature display modes. The oven control can be programmed to display temperatures in Fahrenheit or Celsius. The oven has been preset at the factory to display in Fahrenheit.

INSTRUCTIONS

To change display from Fahrenheit to Celsius or Celsius to Fahrenheit

1. To tell if the display is set for Fahrenheit or Celsius press  (figure 1) and hold for 7 seconds; Wait until "F" or "C" appears. If "F" appears, the display is set to show temperatures in Fahrenheit (Figure 2). If "C" appears, the display is set to show temperatures in Celsius (Figure 3).
2. Press  to switch between Fahrenheit or Celsius display modes. The display will show either "F" (Figure 2) or "C" (Figure 3).
3. Press  or  or wait 5 seconds to accept the change.

PRESS

for 7seconds



 or 

DISPLAY



Figure 1



Figure 2



Figure 3





Setting Oven Controls

Setting Preheat

The **PREHEAT**  pad controls the Preheat feature. The Preheat feature will bring the oven up to temperature and then indicate when to place the food in the oven. Use this feature when recipes call for preheating. Preheating is not necessary when roasting or cooking casseroles. The oven can be programmed to preheat at any temperature between 170°F to 550°F (77°C to 288°C).

INSTRUCTIONS

To set the Preheat temperature for 350°F







1. Arrange the interior oven racks.
2. Press . "- - - °" and "BAKE" will appear in the display (Figure 1).
3. Press   . "350°" and "BAKE" will appear in the display (Figure 2).
4. Press . "PRE", "BAKE" and "ON" will appear in the display as the oven heats and reaches 350°F (Figure 3).

Note: After the oven has reached the desired temperature (this example, 350°F) the control will beep and the "PRE" light will turn off and oven temperature will be displayed (Figure 4). If you missed hearing the beep, you can tell that oven has reached preheat temperature if "PRE" has disappeared from the display. Once the oven has preheated, **PLACE FOOD IN THE OVEN**. The "BAKE" light will stay on.

Press  when baking is complete or to cancel the preheat feature.

To change Preheat temperature while oven is preheating (example: changing from 350 to 425°F)

If it is necessary to change the preheat temperature while the oven is preheating to the original temperature:

1. While preheating, press . "BAKE" will flash in the display (Figure 5)
2. Enter the new preheat temperature. Press   . "425°" and "BAKE" will appear in the display.
3. Press . "PRE" and "ON" will appear in the display as the oven heats to 425°F (Figure 6). A beep will sound once the oven temperature reaches 425°F and the display will show "425°" and "BAKE" (Figure 7).
4. When baking is complete press .

PRESS



DISPLAY



Figure 1



Figure 2



Figure 3



Figure 4



Figure 5



Figure 6

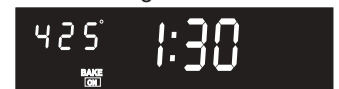



Figure 7

Setting Oven Controls

Setting Bake





The **BAKE**  pad controls normal baking. If preheating is necessary, refer to the **Pre Heat**  Preheat Feature for instructions. The oven can be programmed to bake at any temperature from 170° F to 550° F (The sample shown below is for 350°F).

INSTRUCTIONS

PRESS





DISPLAY

To set the Bake Temperature to 350°F

1. Arrange interior oven racks and place food in oven.
2. Press , "--- °" will appear and "BAKE" will flash in the display (Figure 1).
3. Press    (Figure 2). "BAKE" will continue to flash and "350°" will appear in the display.
4. Press . "PRE", "BAKE" and "ON" will appear in the display as the oven heats to 350°F (Figure 3). A beep will sound once the oven temperature reaches 350°F. The display will show "350°" and "BAKE" (Figure 4).

Pressing  will cancel the Bake feature at any time.

To change the Bake Temperature (example: changing from 350° to 425°F)

1. After the oven has already been set to bake at 350°F and the oven temperature needs to be changed to 425°F, press  (Figure 4) and "BAKE" will flash in the display.
2. Press    (Figure 5). "BAKE" will continue to flash "425°" and "ON" will appear in the display.
3. Press . "BAKE" and "425°" will stay in the display (See Figure 6).

Pressing  will cancel the Bake feature at any time.



Figure 1



Figure 2



Figure 3



Figure 4



Figure 5



Figure 6

Setting Oven Controls

Setting Convection Bake

The **CONVECTION BAKE**  pad controls the Convection Bake feature. Use the Convection Bake feature when cooking speed is desired. The oven can be programmed for Convection baking at any temperature between 325° F (149° C) to 550° F (288° C).

Convection baking uses a fan to circulate the oven's heat evenly and continuously within the oven. This improved heat distribution allows for fast, even cooking and browning results. It also gives better baking results when using 2 or 3 racks at the same time. Breads and pastries brown more evenly. Convection Bake cooks most foods faster and more evenly than conventional baking.

General Convection Bake Instructions

1. When using Convection Bake, decrease your normal cooking times as shown aside. Adjust the cook time for desired doneness as needed. Time reductions will vary depending on the amount and type of food to be cooked. Cookies and biscuits should be baked on pans with no sides or very low sides to allow heated air to circulate around the food. Food baked on pans with a dark finish will cook faster.
2. Preheating is not necessary when cooking casseroles with Convection Bake.
3. When using Convection Bake with a single rack, place oven rack in position 2 or 3. If cooking on multiple racks, place the oven racks in positions 2 and 3.

Benefits of Convection Bake:

- Some foods cook up to 30% faster, saving time and energy.
- Multiple rack baking.
- No special pans or bakeware needed.

Foods for CONVECTION BAKE pad *Decrease normal cook time by:





Frozen foods, pies,	15-25 %
pastries and pizza	
Refrigerator cookies	15-35 %
Refrigerator biscuits	15-30 %
Rolls & Breads	20-25%
Fresh Pies/Pastries	10-20 %

Begin with the maximum reduction in cook times and adjust as needed.

*Recommended reduction in cook times based on brands of food items tested. Cook times may vary with your specific brand of food item.

INSTRUCTIONS

To set the oven for Convection Bake and temperature to 350°F

1. Arrange interior oven racks and place food in oven.
2. Press . "CONV BAKE" will flash and "-- --" will appear in the display (Figure 1).
3. Press   . "CONV BAKE" and "350°" will appear in the display (Figure 2).
4. Press . "CONV BAKE", "PRE" and "ON" will appear in the display (Figure 3). The temperature will be decreased to 325° F. A beep will sound once the oven temperature reaches 325° F and the display will show "325°", "CONV BAKE" and "ON" (Figure 4).

Note: The convection fan will start AS SOON AS the oven is set for Convection Bake.

Press  to stop Convection Bake or cancel Convection Bake at any time.

Note: As soon as the  pad is pressed the set temperature will be decreased by 25° F (14° C).

PRESS

DISPLAY



Figure 1



Figure 2



Figure 3



Figure 4







Setting Oven Controls

Setting Convection Roast







This method of cooking enables you to obtain the best results when roasting. Allow your oven to preheat before roasting. A beep will let you know when the convection roast temperature is reached. The oven can be programmed to convection roast at any temperature from 300°F to 550°F (149°C to 288°C). Remember to use tested recipes with times adjusted for convection roasting when using the convection mode. Times may be reduced by as much as 30% when using the convection feature.

INSTRUCTIONS

To Set the oven to Convection Roast at 350°F

1. Arrange oven racks.
2. Press , "-- °" will be displayed; "CONV" will flash (Figure 1).
3. Enter    using the number pads. "CONV" and "350°" will be displayed (Figure 2).
4. Press , "CONV", "PRE" and  will be displayed. A beep will sound once the oven temperature reaches 350° (Figure 3).

To change the preset Convection Roast Temperature (example: 425°F)

1. Press , "CONV" will flash.
2. Enter the desired roasting temperature using the number pads    (Figure 4).
3. Press , the current oven temperature, "CONV", "PRE" and  will be displayed.

After the oven has reached the desired temperature, "PRE" will disappear the control will beep and "CONV" light will stay on. The  light will turn on and off as the oven maintains its temperature.

When convection roasting is complete press .

INSTRUCTIONS

Setting Convection Convert

This function is used to convert a normal baking to a convection baking.

Be sure your oven is baking in a normal baking mode (Figure 5).

Press , "CONV" should now be displayed and the temperature decreased to convection baking temperature (Figure 6).

Note: For a timed convection convert.

After 75% of the cook time, the control will beep 3 times and "CF" (check food) will appear in the display (Figure 7). At this time the oven control will sound 3 long beeps at regular intervals until baking has finished.

PRESS



PRESS



DISPLAY



Figure 1



Figure 2



Figure 3



Figure 4



Figure 5







Figure 6



Figure 7

Setting Oven Controls

Setting Timed Bake, Timed Convection Bake or Timed Convection Roast









The **BAKE**  or **CONVECTION BAKE**  or **CONVECTION ROAST**  and **BAKE TIME**  pads control the Timed Bake feature. The automatic timer of the Timed Bake feature will turn the oven OFF after cooking for the desired amount of time you selected.

INSTRUCTIONS

PRESS

DISPLAY

To program the oven to begin baking immediately and to shut off automatically (example : Bake at 350°F for 30 minutes)

1. Be sure the clock is set for the correct time of day.
2. Arrange interior oven rack(s) and place the food in the oven.
3. Press , "- - - °" will appear and "BAKE" will flash in the display (Figure 1).
4. Press    (Figure 2). "BAKE" will continue to flash and "350°" will appear in the display.
5. Press . "PRE", "BAKE" and "350°" will appear in the display (See Figure 3).
6. Press . "OVEN 1" and "TIME" will flash; The current time will change to 0 hr :00 (Figure 4).
7. Enter the desired baking time by pressing  .
Note: Baking time can be set for any amount of time between 1 minute to 11 hours and 50 minutes.
8. Press . "PRE", "TIMED", "BAKE" and "ON" should now be displayed. Once the Timed Bake feature has started, the current time remaining will be displayed (Figure 6).

Press  when baking has finished or at any time to cancel the Timed Bake feature.

When the timed bake finishes:

1. "End" and the time of day will show in display. The oven will shut off automatically (Figure 7).
2. The control will beep 3 times. And "End" will remain in the display until  is pressed.

NOTE: Remember that the lowest **BAKE** temperature is 170°F and that the lowest **CONVECTION BAKE** temperature is 325°F.

CAUTION Use caution with the **TIMED BAKE** or **DELAYED TIME BAKE** features. Use the automatic timer when cooking cured or frozen meats and most fruits and vegetables. Foods that can easily spoil such as milk, eggs, fish, meat or poultry, should be chilled in the refrigerator first. Even when chilled, they should not stand in the oven for more than 1 hour before cooking begins, and should be removed promptly when cooking is completed. Eating spoiled food can result in sickness from food poisoning.



Figure 1



Figure 2



Figure 3



Figure 4



Figure 5



Figure 6



Figure 7

Setting Oven Controls

Setting Delayed Timed Bake or Delayed Timed Convection Bake

The **BAKE** (Bake) or **CONVECTION BAKE** (Conv bake), **CONVECTION ROAST** (Conv roast), **BAKE TIME** (Bake time) and **START TIME** (Start time) pads control the Delayed Time Bake feature. The automatic timer of the Delayed Time Bake will turn the oven **on and off** at the time you select in advance. **Note:** If your clock is set for normal 12 hour display mode the Delayed Timed Bake or Delayed Timed Convection Bake cycle can never be set to start more than 12 hours in advance. To set for Delayed Timed Bake or Delayed Timed Convection Bake 12-24 hours in advance set the control for the 24 hour time of day display mode.

INSTRUCTIONS

PRESS

DISPLAY

To program the oven for a delayed BAKE start time and to shut off automatically (example: baking at 350°F, starting at 5:30 and baking for 30 minutes)

1. Be sure that the clock is set with the correct time of day.
 2. Arrange interior oven rack(s) and place the food in the oven.
 3. Press **Bake**. "-- °" will appear and **"BAKE"** will flash in the display (Figure 1).
 4. Press **3** **5** **0** (Figure 2). **"BAKE"** will continue to flash and **"350°"** will appear in the display.
 5. Press **START**. **"BAKE"**, **"ON"** and **"350°"** will stay in the display. (See Figure 3).
 6. Press **Bake time**. **"OVEN 1"** and **"TIME"** will flash, the current time will change to **"0 hr : 00"** and **"350°"** will remain in the display (Figure 4).
 7. Enter the desired baking time using the number pads by pressing **3** **0**. **"OVEN 1"** and **"TIME"** will flash; (Figure 5). Note: Baking time can be set for any amount of time from 1 minute to 11 hours and 50 minutes.
 8. Press **START**. **"TIMED"**, **"BAKE"**, **"ON"** and **"350°"** will remain in the display (Figure 6).
 9. Press **Start time**. **"OVEN 1"** and **"TIME"** will flash in the display. Enter the desired start time using the number pads **5** **3** **0** (Figure 7).
 10. Press **START**. **"PRE"** and **"ON"** will disappear and **"DELAY"** will appear in the display (Figure 8). When Delayed Time Bake starts, **"DELAY"** will disappear and the display clock will switch to the countdown of the oven cook time. The oven will start to bake at the previously selected temperature (Figure 8).
- Press **Clear /Off** when baking has completed or at any time to cancel the Delayed Time Bake feature.

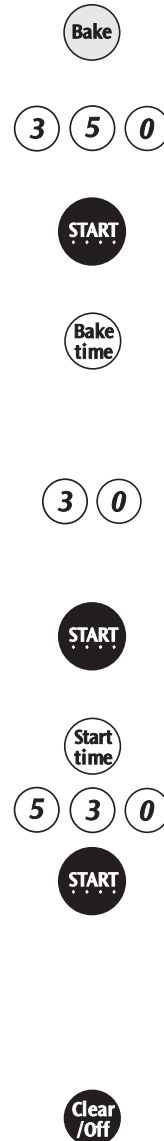

Figure 1



Figure 2



Figure 3



Figure 4



Figure 5



Figure 6



Figure 7



Figure 8



Figure 9

When the set bake time runs out:

1. **"End"** will appear in the display and the oven will shut off automatically (Figure 9).
2. The control will beep 3 times. And **"End"** will remain in the display until **Clear /Off** is pressed.

Setting Oven Controls



Setting the Keep Warm Feature

The **Keep Warm**  pad turns ON the Keep Warm feature and will maintain an oven temperature of 170°F (77°C). The Keep Warm feature will keep oven baked foods warm for serving up to 3 hours after cooking has finished. After 3 hours the Keep Warm feature will shut the oven OFF. The Keep Warm feature may be used without any other cooking operations or can be used after cooking has finished using BAKE, CONVECTION BAKE or CONVECTION ROAST.



The Keep Warm feature may be used with TIMED BAKE if you wish to have the Keep Warm feature turn ON automatically when cooking has finished. The Timed Bake features require you to set start time and the amount of cooking time. With this information the control can calculate the time when cooking will complete and can then start the Keep Warm feature automatically.

INSTRUCTIONS

To set Keep Warm:

1. Arrange interior oven racks and place food in oven.
2. Press . " - - - °" will appear in the display (Figure 1).
Note: If no pad is touched within 5 seconds the request to turn ON Keep Warm feature will be cancelled.
3. Press . "HLd" and "ON" will appear in the display (Figure 2).
4. To turn the Keep Warm OFF at any time press .
Note: The Keep Warm feature will automatically turn OFF after 3 hours.

To set Keep Warm to turn ON automatically:

1. Arrange interior oven racks and place food in oven. Set the oven properly for **Timed Bake** or **Delayed Timed Bake**.
2. Press . (Figure 3)
3. Press . The "HLd" will appear in the display after Timed Bake has finished (See Figure 4).
4. To turn the Keep Warm feature OFF at any time press .
Note: The Keep Warm feature will automatically turn OFF after 3 hours.

Pressing  at any time will stop all oven baking operations.

PRESS



DISPLAY



Figure 1



Figure 2



Figure 3



Figure 4

Setting Oven Controls

Setting Broil

The **BROIL**  pad controls the Broil feature. When broiling, heat radiates downward from the oven broiler for even coverage.







The Broil feature is preset to start broiling at 550°F; however, the Broil feature temperature may be set between 400°F and 550°F. This range includes a Searing Grill for searing meats.

The broil pan and broil pan insert used together allow dripping grease to drain and be kept away from the high heat of the oven broiler. **DO NOT** use the broil pan without the insert (See Figure 5). **DO NOT cover the broil pan insert with foil.** The exposed grease could catch fire.

⚠ WARNING Should an oven fire occur, leave the oven door closed and turn off the oven. If the fire continues, throw baking soda on the fire or use a fire extinguisher. **DO NOT** put water or flour on the fire. Flour may be explosive and water can cause a grease fire to spread and cause personal injury.

INSTRUCTIONS

To set the oven to broil at the default setting (550°F):

- Place the broiler pan insert on the broiler pan. Then place the food on the broiler pan insert. **DO NOT** use the broiler pan without the insert. **DO NOT** cover the broiler insert with foil. The exposed grease could ignite.
- Arrange the interior oven rack and place the broiler pan on the rack. Be sure to center the broiler pan directly under the broiler element. **Make sure the oven door is in the broil stop position (See Figure 4).**
- Press . "BROIL" will flash and "--°" will appear (Figure 1).
- press   . "BROIL" will continue to flash (Figure 2).
- If a lower broil temperature is desired (minimum broil temperature setting is 400°F (204°C)), press the desired temperature before continuing to step 6.
- Press . The oven will begin to broil. "BROIL", "550°" and "ON" will appear in the display (Figure 3).
- Broil on one side until food is browned; turn and cook on the second side. Season and serve. **Note:** Always pull the rack out to the stop position before turning or removing food.
- To cancel broiling or if finished broiling press .

PRESS

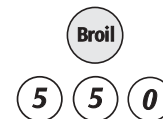

DISPLAY



Figure 1



Figure 2



Figure 3

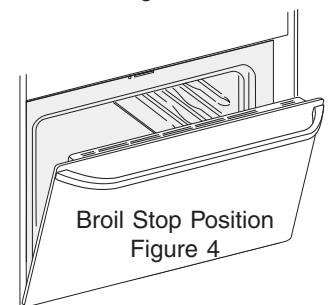

Broil Stop Position
Figure 4

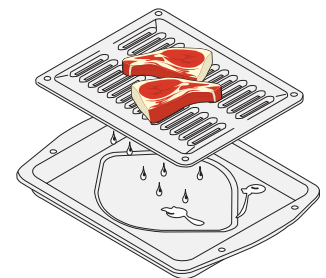

Figure 5

Broiling Times



Use the following table for approximate broiling times. Increase or decrease broiling times, or move the broiling pan to a different rack position to suit for doneness. If the food you are broiling is not listed in the table, follow the instructions provided in your cookbook and watch the item closely.

Electric Range Broiling Table Recommendations





Food Item	Rack Position	Temp Setting	Cook Time		Doneness
			1st side	2nd side	
Steak 1" thick	2nd	550° F	6:00	4:00	Rare
	2nd	550° F	7:00	5:00	Medium
Pork Chops 3/4" thick	2nd	550° F	8:00	6:00	Well
Chicken - Bone In	3rd	450° F	20:00	10:00	Well
Chicken - Boneless	2nd	450° F	8:00	6:00	Well
Fish	2nd	500° F	13:00	n/a	Well
Shrimp	3rd	550° F	5:00	n/a	Well
Hamburger 1" thick	2nd	550° F	9:00	7:00	Medium
	3rd	550° F	10:00	8:00	Well

Setting Oven Controls

To Set the Sabbath Feature (for use on the Jewish Sabbath & Holidays)

The **BAKE TIME**  and **START TIME**  pads are used to set the Sabbath feature. The Sabbath feature may only be used with the **Bake**  pad. The oven temperature may be set higher or lower after setting the Sabbath feature (the oven temperature adjustment feature should be used only during Jewish Holidays), however the display will not visibly show or provide any audible tones indicating whether the change occurred correctly. Once the oven is properly set using Bake with the Sabbath feature active, the oven will remain continuously ON until cancelled. This will override the factory preset 12-Hour Energy Saving feature.

If the oven light will be needed during the Sabbath, press **Oven light**  before activating the Sabbath feature. Once the oven light is turned ON and the Sabbath feature is active, the oven light will remain ON until the Sabbath feature is turned OFF. If the oven light needs to be OFF, be sure to turn the oven light OFF before activating the Sabbath feature.







IMPORTANT NOTES: It is not advised to attempt to activate any other program feature other than **BAKE** while the Sabbath feature is active. ONLY the following key pads will function after setting the Sabbath feature;  to , ,  & . ALL OTHER KEYPADS will not function once the Sabbath feature is properly activated.

INSTRUCTIONS

PRESS

DISPLAY





To Program the Oven to Begin Baking Immediately & activate the Sabbath feature (example: baking at 350°F)

1. Be sure that the clock is set with the correct time of day.
2. Place the food in the oven.
3. Press . "- - - °" appears in the display (Figure 1).
4. Within 5 seconds, press the , , . The display will show "350°F (177°C)." (Figure 2).
5. Press . The "ON" indicator light will be displayed (Figure 3).
6. If you desire to set the oven control for a **Timed Bake** or **Delayed Start Bake** do so at this time. If not, skip this step and continue to step 6. Refer to the **Timed Bake** (complete steps 6-8) / **Delayed Start Bake** (complete steps 6-10) section for complete instructions. Remember the oven will shut down after using **Timed Bake** or **Delay Start Bake** and therefore may only be used once during the Sabbath/ Jewish Holidays. The maximum **Delayed Start Bake** time is 11 hours & 59 minutes.
7. The oven will turn ON and begin heating.
8. Press and hold both the  and  pads for at least 3 seconds. "- -" will appear in the display (Figure 4). Press

Setting Oven Controls

To Set the Sabbath Feature (for use on the Jewish Sabbath & Holidays) (continued)

INSTRUCTIONS

Note: You may change the oven temperature once baking has started by pressing , the numeric key pads for the temperature you want (example for 425°C press , , ) and then pressing  (for Jewish Holidays only). Remember that **the oven control will no longer beep or display any further changes** once the oven is set for the Sabbath feature.

9. The oven may be turned OFF at any time by first pressing  pad (this will turn the oven and the Sabbath feature OFF). **SAb** will disappear from the display.

PRESS



DISPLAY

Should you experience a power failure or interruption, the oven will shut off. When power is returned the oven will not turn back on automatically. The oven will remember that it is set for the Sabbath and the food may be safely removed from the oven while still in the Sabbath feature, however the oven cannot be turned back on until after the Sabbath.

After the Sabbath observance turn OFF the Sabbath feature by pressing  pad. **SAb** will disappear from the display and the oven may be used with all normal functions. For further assistance, guidelines for proper usage, and a complete list of models with the Sabbath feature, please visit the web at <http://www.star-k.org>.

Self-Cleaning

To Start the Self-Clean Cycle

The **SPEEDCLEAN** (Speed clean), **CLEAN** (Clean) and **MAXXCLEAN** (Maxx clean) pads control the Self-Cleaning feature. If you are planning to use the oven directly after a self-clean cycle remember to allow time for the oven to cool down and the oven door to unlock. This normally takes about one hour. So a 3 hour self-clean cycle will actually take about 4 hours to complete.

*It is recommend to use a (Speed clean) cycle (2 hour) for **light soils**, a (Clean) cycle (3 hour) for **average soils**, and a (Maxx clean) cycle (4 hour) for **heavy soils** (to assure satisfactory results).

NOTE: During a Self-Cleaning cycle the second oven will be disabled.

INSTRUCTIONS

To set the controls for a 3 hour Self-Cleaning cycle to start immediately and shut off automatically

1. Be sure the clock is set with the correct time of day and the oven door is closed.
2. Press (Clean). "CLEAN", "1" and "TIME" will flash in the display (Figure 1). The control will automatically clean for a 3 hour period (default self-cleaning cycle time). Note: If a 2 or 4 hour clean time is desired, press (Speed clean) for 2 hour or press (Maxx clean) for a 4 hour clean time. Set the cleaning time based on the amount of soil: light, medium or heavy (* See above).
3. Press (START). Once the door has locked, "CLEAN", "LOCK" and "ON" will appear in the display (Figure 3).
4. When flex clean finishes, lock will remain in the display until the door has unlocked (Figure 4).

Note: Allow about 15 seconds for the oven door lock to close.

When the Self-Clean Cycle is Completed

1. The time of day and "LOCK" will remain in the display (Figure 4).
2. Once the oven has cooled down for approximately 1 HOUR, and "LOCK" is no longer displayed, the oven door can then be opened (Figure 5).

Stopping or Interrupting a Self-Cleaning Cycle

If it becomes necessary to stop or interrupt a self-cleaning cycle due to excessive smoke or fire in the oven:

1. Press (Clear /Off).
2. The oven door can only be opened after the oven has cooled down for approximately 1 HOUR, and "LOCK" is no longer displayed (Figure 5).

CAUTION To avoid possible burns use care when opening the oven door after the Self-Cleaning cycle. Stand to the side of the oven when opening the door to allow hot air or steam to escape.

CAUTION DO NOT force the oven door open. This can damage the automatic door locking system. Use caution and avoid possible burns when opening the door after the Self-Cleaning cycle has completed. The oven may still be VERY HOT.

NOTE: A smoke eliminator in the oven vent converts most of the soil into a colorless vapor.

PRESS

DISPLAY



Figure 1



Figure 2



Figure 3



Figure 4



Figure 5



Oven Cleaning

To Start the delayed Self-Clean Cycle

The **SPEED CLEAN** (Speed clean), **CLEAN** (Clean), **MAXX CLEAN** (Maxx clean) and **DELAY START** (Start time) pads and length of clean cycle, controls the Delayed Self-Clean operation. The automatic timer will turn the oven **on and off** at the time you select in advance. Be sure to review TO START THE SELF-CLEAN CYCLE for recommended clean times.

INSTRUCTIONS

To set the control for the Self-Cleaning Cycle to start at a delayed time and shut off automatically (example: 3 hour self-clean cycle to start at 4:30)

1. Be sure the clock is set with the correct time of day and the oven door is closed.
2. Press **Clean**. "**CLEAN**", "**ON**" and "**TIME**" will flash in the display (Figure 1). The control will automatically clean for a 3 hour period (default self-cleaning cycle time)(Figure 2). Note: If a 2 or 4 hour clean time is desired, press **Speed clean** for 2 hour or press **Maxx clean** for a 4 hour clean time. Set the cleaning time based on the amount of soil: light, medium or heavy.
4. Press **START**. "**OVEN**" will appear in the display. Once the door has locked "**CLEAN**", "**LOCK**" and "**ON**" will be displayed (Figure 3).
5. Press **Start time**. Time will be displayed. "**OVEN 1**" and "**TIME**" will flash (Figure 4). Enter the desired start time using the number pads **4** **3** **0** (Figure 4).
6. Press **START**. "**CLEAN**", "**DELAY**", "**LOCK**", "**OVEN1**" and "**TIME**" will be displayed (Figure 5).
7. As soon as the control is set, the motor driven oven door lock will begin to close automatically. Once the door has been locked the "**LOCK**" indicator light will go on.
8. The control will start the self-cleaning at the set start time, for the period of time previously selected. At that time, the icon "**DELAY**" will go out.

PRESS



DISPLAY

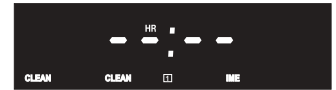

Figure 1



Figure 2



Figure 3



Figure 4



Figure 5



Figure 6

When the Self-Clean Cycle is Completed

1. The display will return to the time of day (Figure 6).
2. Once the oven has cooled down for approximately 1 HOUR, the oven door can then be opened (Figure 7).

Stopping or Interrupting a Self-Cleaning Cycle:

If it becomes necessary to stop or interrupt a self-cleaning cycle due to excessive smoke or fire in the oven:

1. Press **Clear / Off**.
2. Once the oven has cooled down for approximately 1 HOUR and the "**LOCK**" is no longer displayed, the oven door can then be opened (Figure 6).

Note: If your clock is set for normal 12 hour display mode the Delayed Self-Clean cycle can never be set to start more than 12 hours in advance. To set for Delayed Self-Clean Cycle 12-24 hours in advance set the control for the 24 hour time of day display mode.

Adjusting Oven Temperature

The temperature in the oven has been pre-set at the factory. When first using the oven, be sure to follow recipe times and temperatures. If you think the oven temperature is cooking too hot or too cool for the temperature you select, you can adjust the actual oven temperature to be more or less than what is displayed. Before adjusting, test a recipe by using a temperature setting that is higher or lower than the recommended temperature. The baking results should help you to decide how much of an adjustment is needed.

Note: The oven temperature adjustments made with this feature will not change the Self-Clean cycle temperature or the Broil temperature.

INSTRUCTIONS

To adjust the oven temperature higher

1. Press **Bake** for 6 seconds (Figure 1).
2. To increase the temperature use the number pads to enter the desired offset temperature. (Example 30°F) **3** **0** (Figure 2). The temperature may be increased as much as 35°F (19°C).
3. Press **START** or **Clear/Off** to accept the temperature change and the display will return to the time of day (Figure 3).

To adjust the oven temperature lower

1. Press **Bake** for 6 seconds (Figure 1).
2. To decrease the temperature use the number pads to enter the desired offset temperature. (Example -30°F) **3** **0** and then press **Clean** (Figure 4). The temperature may be decreased as much as -35°F (-19°C).
3. Press **START** or **Clear/Off** to accept the temperature change and the display will return to the time of day (Figure 3).

PRESS



DISPLAY



Figure 1



Figure 2



Figure 3



Figure 4

Notes

Notes

Free Manuals Download Website

<http://myh66.com>

<http://usermanuals.us>

<http://www.somanuals.com>

<http://www.4manuals.cc>

<http://www.manual-lib.com>

<http://www.404manual.com>

<http://www.luxmanual.com>

<http://aubethermostatmanual.com>

Golf course search by state

<http://golfingnear.com>

Email search by domain

<http://emailbydomain.com>

Auto manuals search

<http://auto.somanuals.com>

TV manuals search

<http://tv.somanuals.com>