

Frigidaire[®]



Frigidaire Side Burner Built-In Usage



USE AND CARE MANUAL

FOR OUTDOOR USE ONLY
MADE IN THE USA

General Safety Instructions

IMPORTANT SAFETY INFORMATION

- Read this manual carefully before using your grill to reduce the risk of fire, burn hazard or other injury.
- Extreme care should be used because of the high temperatures produced by this appliance. **CHILDREN SHOULD NOT BE LEFT UNATTENDED IN AN AREA WHERE THE GRILL IS BEING OPERATED.**
- This appliance must be kept clear from combustible materials, gasoline or other flammable vapors and liquids. Do not allow flammable materials to come in contact with grate, burner or hot surfaces.
- Do not repair or replace any part of this appliance unless it is specifically recommended in this manual. A qualified service technician should conduct all other service.
- Follow the installation and servicing instructions provided with this product. Have your grill installed by a qualified service technician. Locate the main gas supply valve so that you know how to shut the gas off to your grill. If you smell gas, make sure all gas connections are tight before operation. If you continue to smell gas call a qualified technician.
- When lighting the burners, always pay close attention to what you are doing. Be certain you are pushing the igniter to light the burners you intend on using.

WARNING

If you smell gas:

1. Shut off gas to the appliance.
2. Extinguish any open flames.
3. Open lid.
4. If odor continues, immediately call your gas supplier.

CALIFORNIA PROPOSITION 65 -

WARNING: The Burning of gas cooking fuels generates some by products which are on the list of substances which are known by the State of California to cause cancer or reproductive harm. California law requires businesses to warn customers of potential exposure to such substances. To minimize exposure to these substances, always operate this unit according to the use and care manual, ensuring you provide good ventilation when cooking with gas.

This appliance is not intended to be installed in or on recreational vehicles or boats.

TESTED IN ACCORDANCE WITH ANSI Z21.58a-1998/CGA 1/6a-M98 STANDARD FOR OUTDOOR COOKING GAS APPLIANCES. THIS GRILL IS FOR OUTDOOR USE ONLY.

Check your local building codes for the proper method of installation. In the absence of local codes, this unit should be installed in accordance with the National Fuel Gas Code No. Z223.1 and the National Electrical Code ANSI/NFPA No. 70

FOR YOUR SAFETY

DO NOT store or use gasoline or other flammable vapors and liquids in the vicinity of this grill.

FOR YOUR SAFETY

DO NOT try lighting this grill without reading the “**LIGHTING INSTRUCTIONS**” section of this manual.

Built-In Instructions

The Frigidaire side burner is designed to be installed as a built-in side burner, in conjunction with a Frigidaire & Frigidaire Gallery grills. If installed as a built-in Grill, the Grill surround **must be** constructed of **Non-combustible** material.

PLANNING AND DESIGN

Start by identifying the number and size of components you want to include in your outdoor cooking center. Countertops must be constructed of non-combustible, outdoor-safe materials. Consider outdoor lighting to illuminate after-dark grilling. For assistance in designing and building your outdoor cooking center, contact a landscape architect or general contractor. Review the drawings on the following pages to determine the exact dimensions and items needed for an outdoor cooking center. Keep in mind that the gas line hook-up is on the right hand side of the main built in-grill. The structure, grill and support items must be kept level throughout the installation to ensure proper operation.

LOCATION

Take into account convenience and visual impact as well as traffic flow, wind exposure, and the site's structural suitability. The grill should never be placed in an enclosed area without an approved ventilation system, or beneath a combustible overhang. Because the grill exhausts to the rear, it should never be located in front of a window or less than 12" from hard-to-clean surfaces. We recommend keeping your gas supply lines as short as possible for best performance. To ensure a perfect fit, we strongly recommend that you have all components on hand prior to final construction.

CLEARANCE TO NON-COMBUSTIBLE CONSTRUCTION

For your safety a minimum of 3" clearance from the back of the grill to non-combustible construction is required. You should allow at least 6" side clearance to non-combustible construction. The side vents on this unit can be covered for built in installations without danger of fire or without impairing the operation of the grill.

UTILITIES

For natural gas grills, consult your local gas utility company for hook-up requirements. All gas connections should be made by a certified technician or a gas supply company. For natural gas installation, the supply line must be at least 1/2" diameter. The rotisserie requires a 110/120 volt electric supply and GFI receptacle. (6.5 amp min.) that should be installed by a qualified electrical technician. If your plan includes a sink, arrange for a certified plumbing technician to run a water line to the site.

Built-In Instructions

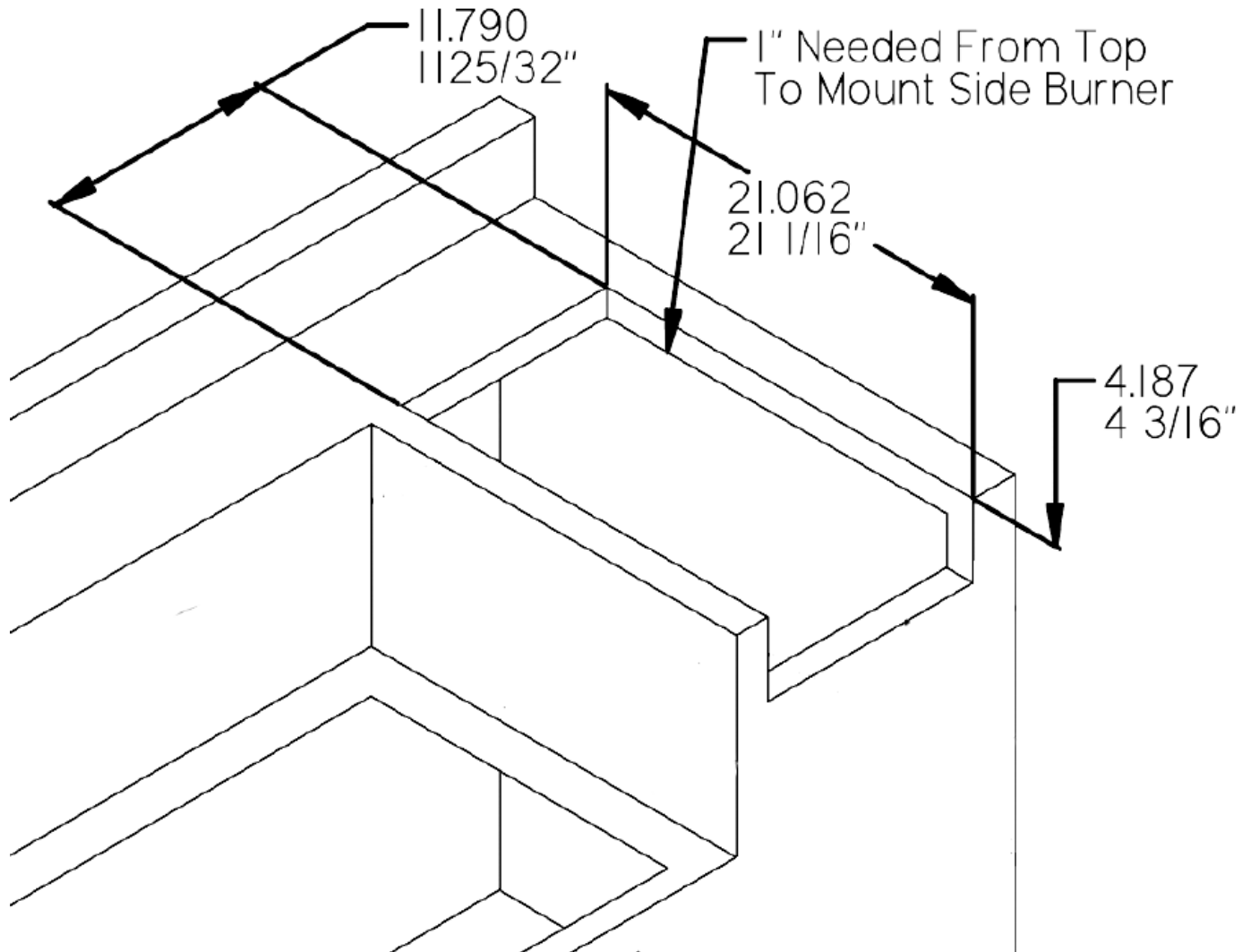

Additional Requirements:

- If using a backsplash apron or rear wall, locate electrical service on the left hand side for rotisserie motor construction.
- A minimum clearance of 12" from the back of the outdoor cooking center must be maintained between the grill and any combustible construction such as wood siding of residence, 3" minimum for non-combustible construction.
- The side vents on this unit can be covered for built in installations without danger of fire or without impairing the operation of the grill.

Natural Gas Installation

1. Under the grill, remove the NG gas regulator assembly from the main gas pipe. Once the NG gas regulator is removed, the main gas pipe will be showing under grill. (See Fig 1)
2. Using pipe sealant, attach the "T" Fitting to the main gas pipe coming out of the bottom of the grill. (See Fig 2)
3. Using pipe sealant, attach a 3/8" flared fitting to the side of the "T" fitting. (See Fig 3)
4. Attach the one end of the flex line to the fitting on the side of the "T" fitting. Connect the other end of the flex line to the side burner valve. (See Fig 4)

Note: This line can be extended using a 3/8" flared coupling and an additional flex line if necessary.

5. Using pipe sealant, attach a 3/8" nipple to the bottom of the "T" fitting. (See Fig 5)
6. Using pipe sealant, attach the NG gas regulator to the 3/8" nipple. (See Fig 6)
7. Attach the NG gas line to the bottom flared fitting. (See Fig 7)

Note: Make sure all fittings are tightened with a wrench.

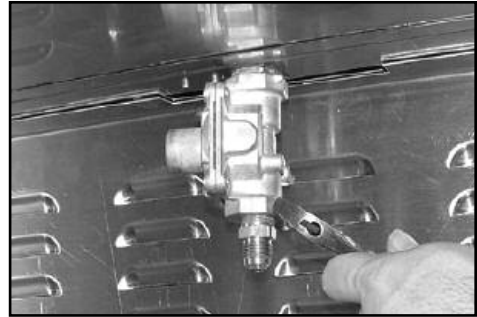

Fig. 1



Fig. 2



Fig. 3

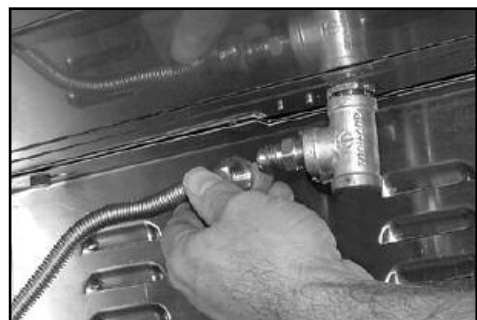

Fig. 4



Fig.6



Fig.7



Fig. 5

LP Side Burner Conversion

1. Loosen the flex line attached to the side burner valve using an adjustable wrench. (See Fig. 1)
2. Remove the flex line completely from the side burner valve. (See Fig. 2)
3. Remove the control knob from the front of the side burner. (See Fig. 3)
4. Remove the screw holding the bezel in place on the side burner and remove bezel from front of side burner. (See Fig. 4)
5. Grasp and remove NG valve assembly from the side burner tube assembly and remove from the side burner. (See Fig. 5)
6. Install LP valve assembly into the side burner. (See Fig. 6)

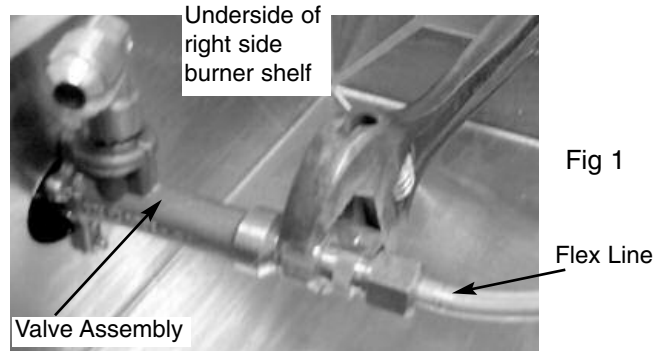

Fig 1

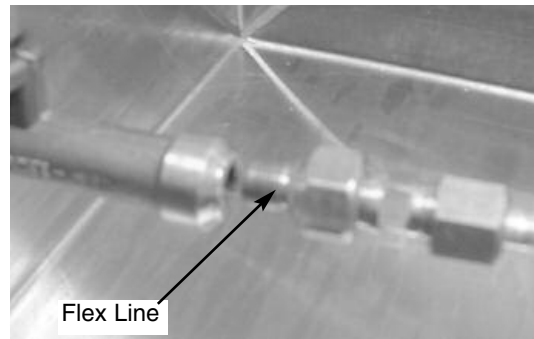

Fig 2



Fig 3

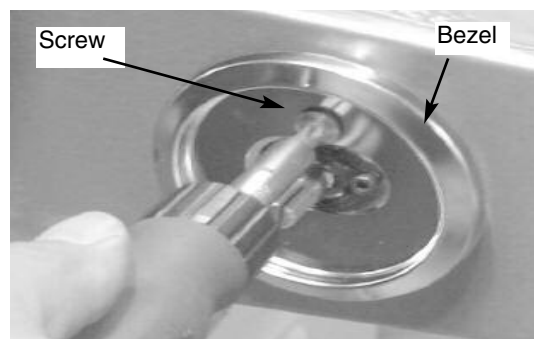

Fig 4



Fig 6

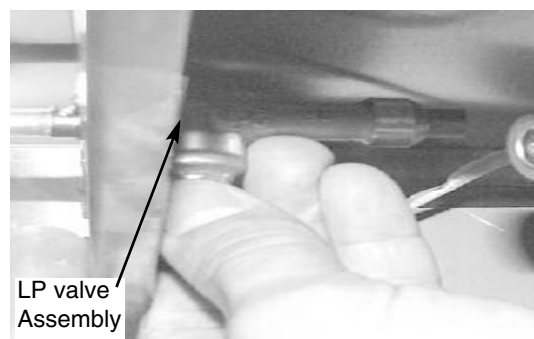

Fig 5

LP Side Burner Conversion

7. Reattach bezel and screw new LP valve onto front of side burner. (See Fig 4, again)
8. Reattach the flex line to the LP valve assembly and tighten securely. (See Fig. 7)
9. Reattach the control knob onto the manifold stem. (See Fig. 3, again)
10. Looking down at top of side burner, use a 7mm nut driver to remove the NG. (See Fig. 8)
16. Install the new LP orifice (See Fig. 9)
17. From the bottom of the side burner place the LP orifice into the main burner assembly, finger tighten. (See Fig. 10)
18. Using the 7mm nut driver tighten the LP orifice in the main burner assembly. (See Fig. 11)
19. This completes the side burner conversion.

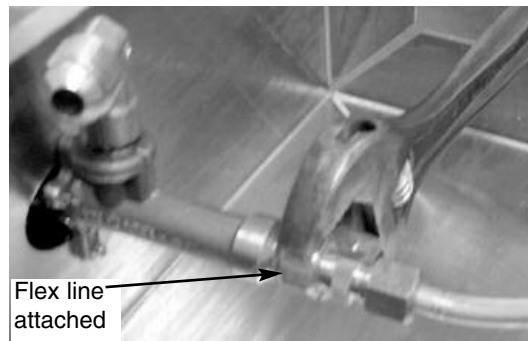

Fig 7

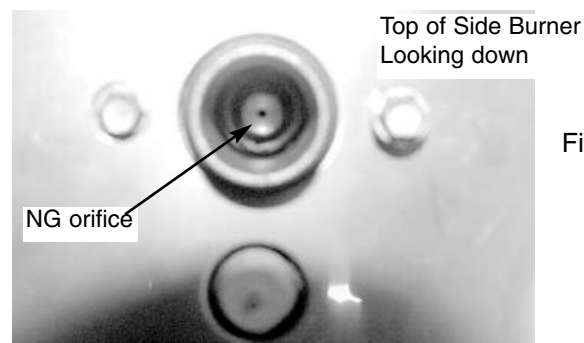

Fig 8

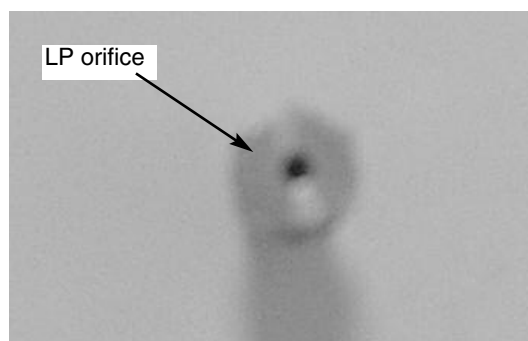

Fig 9

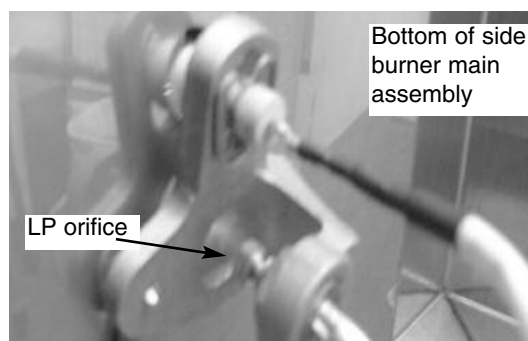

Fig 10

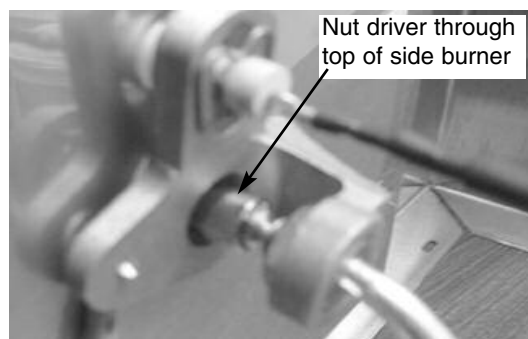

Fig 11

LP Grill Conversion

IMPORTANT: Make sure you have converted the side burner to Liquid Propane prior to completing the following steps.

1. Remove the LP gas hose assembly from the flare fitting. (this has the regulator attached to it.) (See Fig. 12)
2. Using an adjustable wrench remove the flare fitting coming out of the bottom of the grill. Once the flare fitting is removed the main gas pipe will be showing under grill. (See Fig. 13)
4. Using pipe sealant, attach the "T" Fitting to the main gas pipe coming out of the bottom of the grill and tighten with a wrench. (See Fig. 14)
5. Using pipe sealant, attach a 3/8" flared fitting to the side and bottom of the "T" fitting. (See Fig. 15)
6. Attach the Flex Line to the fitting on the side of the "T" fitting. Connect the other end of the flex line to the side burner valve. (See Fig. 16)

Note: This line can be extended using a 3/8" flared coupling and an additional flex line if necessary.

7. Attach the LP gas hose assembly to the bottom flared fitting. (See Fig. 17)

Be sure your L.P. cylinder has an overfill protection device on it. Max inlet pressure cannot exceed 10"-11" water column.

LP hose/
regulator
supplied
with grill.

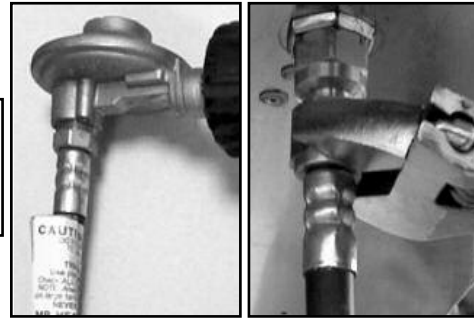

Fig. 12



Fig. 13

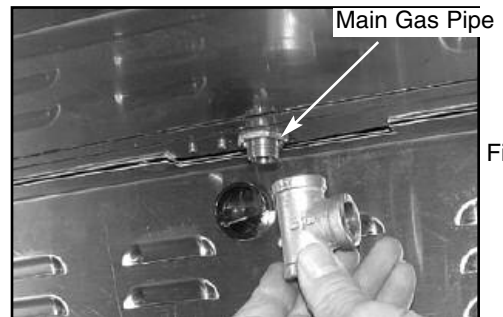

Fig. 14



Fig. 15

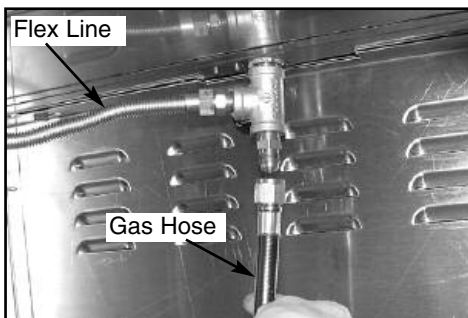

Fig. 17

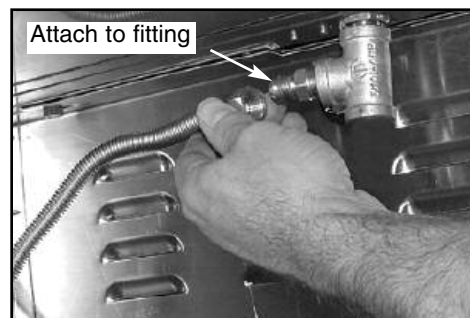

Fig. 16

Installation Instructions

Tools Required: Adjustable wrench, flat head screwdriver and a 1/4" socket wrench

Please use the built in information on the following pages for the exact dimensions needed to fit the side burner into the structure. Once installed into the structure use the following steps to complete the side burner installation.

INSTALLATION OF SIDE BURNER PARTS

1. Install burner into side burner tray lining up the three cutouts on the underside of the burner. (See Fig. 1)
2. Install burner cap onto burner (See Fig. 2)
3. Install grate into burner. (See Fig. 3)

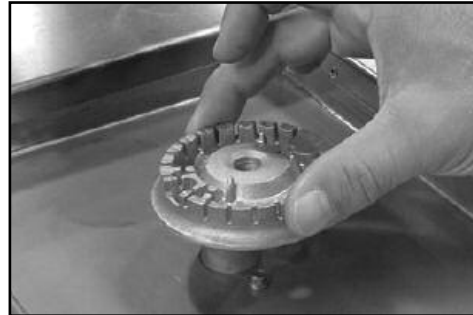

Fig. 1



Fig. 2



Fig. 3

Lighting The Side Burner

LEAK TESTING

Make sure all burners are turned to "OFF". Turn on the gas at the cylinder (LP models) or main valve (Natural models). DO NOT turn on the side burner. Perform a leak test at all connections and fittings by spraying a 50/50 solution of water and soap. If any bubbles appear, correct the leak before attempting to light the grill or side burner.

LIGHTING INSTRUCTIONS

Push and turn the control knob to the "HIGH" position and immediately press and hold the electronic igniter button. You'll hear a snapping sound. It may be necessary to hold the electronic starter button for about 4 seconds. If the burner does not light in 4 seconds, turn the knob to the "OFF" position and wait 5 minutes before trying again. Repeat above steps to light remaining burners. (See Fig. 5)

Match Lighting

If by chance the electronic igniter does not light the burner, the burner may be lit with a match. Keep your face as far away from the burner as possible and place a lit, long stem match through the spaces in the grate to the ports of the burner. Position the match near the burner ports and push and turn the control knob to the "HIGH" position.



Fig. 5

Warranty

LIMITED LIFETIME WARRANTY

Electrolux Icon Grills have a limited lifetime warranty on all stainless steel panels, a limited 3 year warranty on stainless steel burners, including labor within one year of the date of purchase; and a limited 1 year warranty on all other parts, labor included.

In the U.S.A., your appliance is warranted by Electrolux Home Products North America. We authorize no person to change or add to any of our obligations under this warranty. Our obligations for service and parts under this warranty must be performed by an authorized Electrolux Home Products North America qualified service technician.

	WARRANTY PERIOD:	THROUGH OUR AUTHORIZED SERVICERS, WE WILL:	THE CONSUMER WILL BE RESPONSIBLE FOR:
LIMITED ONE YEAR WARRANTY *	One Year from original purchase date	Pay all costs for repairing or replacing any parts of this appliance which prove to be defective in materials or workmanship.	Cost of service calls that are listed under NORMAL RESPONSIBILITIES OF THE CONSUMER.
LIMITED 3 YEAR WARRANTY ON STAINLESS STEEL BURNERS *	2nd through 3rd years from original purchase date	Provide a replacement for any defective stainless steel burner which prove to be defective in materials or workmanship.	Diagnostic and any transportation and labor costs which are required because of service.
LIMITED LIFETIME WARRANTY ON STAINLESS PANELS *	From original date of purchase	All of the provisions of the full and limited warranties above and the exclusions listed below apply.	Costs of the technicians travel to the home and any costs for pick up and delivery of the appliance required because of service.

* Some restrictions apply

NORMAL RESPONSIBILITIES OF THE CUSTOMER

This warranty applies only to products in ordinary household use, and the consumer is responsible for the items listed below:

1. Proper use of the appliance in accordance with instructions provided with the product.
2. Proper installation by an authorized servicer in accordance with instructions provided with the appliance and in accordance with all local plumbing, electrical and/or gas codes.
3. Expenses for making the appliance accessible for servicing, such as removal of trim, cupboards, shelves, etc., which are not a part of the appliance when it was shipped from the factory.
4. Damages to finish after installation.

EXCLUSIONS

This warranty does not cover the following:

1. CONSEQUENTIAL OR INCIDENTAL DAMAGES SUCH AS PROPERTY DAMAGE AND INCIDENTAL EXPENSES RESULTING FROM ANY BREACH OF THIS WRITTEN OR ANY IMPLIED WARRANTY.
NOTE: Some states do not allow the exclusion or limitation of incidental or consequential damages, so this limitation or exclusion may not apply to you.
2. Service calls which do not involve malfunction or defects in workmanship or material, or for appliances not in ordinary household use. The consumer shall pay for such service calls.
3. Damages caused by services performed by servicers other than Electrolux Home Products North America or its authorized servicers; use of parts other than genuine Electrolux Home Products parts or parts obtained from persons other than authorized servicers; or external causes such as abuse, misuse, inadequate power supply or acts of God.
4. Products with original serial numbers that have been removed or altered and cannot be readily determined.
5. All other warranties, including implied warranties of merchantability and fitness for a particular purpose, which are expressly excluded. consequential or incidental damages resulting from breach of warranty which are expressly excluded.
6. This limited warranty does not cover corrosion or discoloring due to lack of maintenance, misuse, hostile environments, alterations, accidents or abuse or neglect.
7. This limited warranty does not cover any scratches, dents, corrosion or discoloring by heat, abrasive and chemical cleaners nor any components used in the installation of the appliance.

IF YOU NEED SERVICE

Keep your bill of sale, delivery slip, or some other appropriate payment record. The date on the bill establishes the warranty period should service be required. If service is performed, it is in your best interest to obtain and keep all receipts. This written warranty gives you specific legal rights. You may also have other rights that vary from state to state. Service under this warranty must be obtained by contacting Electrolux Home Products.

This warranty only applies in the 50 states of the U.S.A., Puerto Rico, and Canada. Product features or specifications as described or illustrated are subject to change without notice. In the U.S. A., all warranties are made by Electrolux Home Products North America. In Canada, your appliance is warranted by Electrolux Canada Corp.

**If you have any other questions, please contact the Customer Service Hotline at
1-800-320-0859**

Because of continuing product improvement, these specifications are subject to change without notice

RMP-122-FSSBIM
01/18/05

Free Manuals Download Website

<http://myh66.com>

<http://usermanuals.us>

<http://www.somanuals.com>

<http://www.4manuals.cc>

<http://www.manual-lib.com>

<http://www.404manual.com>

<http://www.luxmanual.com>

<http://aubethermostatmanual.com>

Golf course search by state

<http://golfingnear.com>

Email search by domain

<http://emailbydomain.com>

Auto manuals search

<http://auto.somanuals.com>

TV manuals search

<http://tv.somanuals.com>