



Operation Instruction



HDcctv Megapixel 720p 3-Axis Outdoor IR Vandal-Proof Bullet Camera

EZH5040



EVERFOCUS ELECTRONICS CORPORATION

Operation Instruction

© 2011 EverFocus Electronics Corp

Please read this manual first for correct installation and operation. This manual should be retained for future reference. The information in this manual was current when published. The manufacturer reserves the right to revise and improve its products. All specifications are therefore subject to change without notice.

All rights reserved. No part of the contents of this manual may be reproduced or transmitted in any form or by any means without written permission of the EverFocus Electronics Corporation.

PRECAUTIONS

- 1. Do not install the camera near electric or magnetic fields.**
Install the camera away from TV/radio transmitters, magnets, electric motors, transformers and audio speakers since the electromagnetic fields generated from these devices may distort the video image or otherwise interfere with camera operation.
- 2. Never disassemble the camera beyond the recommendations in this manual nor introduce materials other than those recommended herein.** Improper disassembly or introduction of corrosive materials may result in equipment failure or other damage.
- 3. Try to avoid facing the camera toward the sun.**
In some circumstances, direct sunlight may cause permanent damage to the sensor and/or internal circuits, as well as creating unbalanced illumination beyond the capability of the camera to compensate.
- 4. Keep the power cord away from water and other liquids and never touch the power cord with wet hands.** Touching a wet power cord with your hands or touching the power cord with wet hands may result in electric shock.
- 5. Never install the camera in areas exposed to oil, gas or solvents.**
Oil, gas or solvents may result in equipment failure, electric shock or, in extreme cases, fire.
- 6. Cleaning**
For cameras with interchangeable lenses, do not touch the surface of the sensor directly with the hands. Use lens tissue or a cotton tipped applicator and ethanol to clean the sensor and the camera lens. Use a damp soft cloth to remove any dirt from the camera body. Please do not use complex solvents, corrosive or abrasive agents for cleaning of any part of the camera.
- 7. Do not operate the camera beyond the specified temperature, humidity or power source ratings. This camera is suitable for indoor and outdoor operation.** Use the camera at temperatures within -10°C~50°C (14°F~122°F) and in an IP67 compliant environment; this device is not rated as submersible. The input power source is 12VDC/24VAC. **The use of properly fused or Class 2 power limited type supplies is highly recommended.**
- 8. Mounting**
Use care in selecting a solid mounting surface which will support the weight of the camera plus any wind, snow, ice or other loading, and securely attach the camera to the mounting surface using screws and anchors which will properly support the camera. If necessary (e.g. when mounting to drop ceilings) use a safety wire to provide additional support for the camera.



ATTENTION! This is a class A product which may cause radio interference in a domestic environment; in this case, the user may be urged to take adequate measures.



Federal Communication Commission Interference Statement

This equipment has been tested and found to comply with the limits for a Class B digital device, pursuant to Part 15 of the FCC Rules. These limits are designed to provide reasonable protection against harmful interference in a residential installation. This equipment generates, uses and can radiate radio frequency energy and, if not installed and used in accordance with the instructions, may cause harmful interference to radio communications. However, there is no guarantee that interference will not occur in a particular installation. If this equipment does cause harmful interference to radio or television reception, which can be determined by turning the equipment off and on, the user is encouraged to try to correct the interference by one of the following measures :

- Reorient or relocate the receiving antenna.
- Increase the separation between the equipment and receiver.
- Connect the equipment into an outlet on a circuit different from that to which the receiver is connected.
- Consult the dealer or an experienced radio/TV technician for help.

FCC Caution: Any changes or modifications not expressly approved by the party responsible for compliance could void the users' authority to operate this equipment.

Table of Contents

1. PRODUCT OVERVIEW.....	6
1.1 FEATURES	6
1.2 ACCESSORY PARTS LIST.....	7
1.3 SPECIFICATIONS	8
1.4 DIMENSIONS.....	9
2. INSTALLATION	100
3. OSD MENU & CONFIGURATION.....	133

1. Product Overview

The EZH5040 is an HDcctv 3-Axis outdoor bullet camera with True Day/Night capability in an IP67 vandal resistant housing. Based on a Sony 1.3 megapixel progressive scan sensor for HD 720p resolution 100% digital images, it delivers vastly superior video quality compared to traditional CCTV images. This superior resolution not only captures more critical evidentiary information, but the inherent ability for megapixel video also extends the area of coverage, expedites completion of investigations, resolves complaints and reduces both capital and operational costs. Designed with long lifespan IR LEDs, the EZH5040 can capture images at up to 45m (~150 ft.) in low or no light environments.

No major upgrade to the IT network is required to deploy this powerful technology; HDcctv cameras communicate at digital speeds up to 1.5Gb/s over existing or new coaxial cable (RG59 or other types for longer distances), using industry standard BNC connectors. With its 3-Axis positioning and vari-focal 3-9mm megapixel auto iris lens the EZH5040 delivers flexible, robust coverage in a wide range of demanding surveillance environments while delivering stunning HD image quality.

1.1 Features

- HDcctv Alliance Base Line Compliance
- HDcctv Megapixel real time 1280x720 HD video over coax
- Supports video outputs of 720p25/30/50/60 (field select)
- True day/night operation with automatic ICR module
- Includes DNR to improve picture clarity while enabling DVRs to improve disk storage utilization
- 3-Axis positioning for flexible mounting and aiming
- 3~9mm AI VF megapixel lens captures the desired field of view
- Extended IR range of up to 45m (~150 ft.)
- Easy to use OSD setup menu
- SD TV Out for aim and focus using a standard hand held test monitor
- Dual Voltage Power Source 12VDC/24VAC
- Vandal Resistant
- Weather Proof IP67 rated

The HDcctv Alliance states





Look for the unique HDcctv logo to be sure:

- 100m transmission over even low-grade RG59
- Plug-and-play interoperability with other compliant products
- Forward compatibility with future versions of the standard
- See www.hidefctv.org for details

1.2 Accessory Parts List

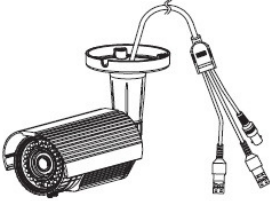

Please be careful when you unpack the box due to the electronics devices inside. Check and make sure that you have all the items listed below inside the original box:

HD CCTV Digital Video Camera	
SERVICE VIDEO OUTPUT TEST CABLE	
L WRENCH	
OPERATION MANUAL	
SCREW - 4ea Plastic anchors - 4ea	

Please Note: If an item appears to have been damaged in shipment, replace it properly in its carton and notify the shipper. If any items are missing, notify your EverFocus Electronics Corp. Sales Representative or Customer Service. The shipping carton is the safest container in which the unit may be transported. Save it for possible future use.

1.3 Specifications

Pickup Device	1/3" Sony Megapixel Color Progressive CMOS Sensor
Sensitivity	1lux/F=1.4; 0lux(IR LED ON)
S/N Ratio	Max. 50dB
Video Format Main Output	HDcctv 1.5Gb/s digital system
Resolution Main Output	1280x720
Video Mode Main Output	Field select 720p25, 720p30, 720p50, 720p60
Main Output Connector	BNC
Video Format Test Output	NTSC/PAL selectable
Test Output Connector	Pin header; adapter cable to BNC supplied
Exposure Control	via lens DC iris
Lens Type	Vari-focal lens, Auto Iris, f=3~9mm
True Day/Night Control	Yes (Auto IR cut filter removal)
Back Light Compensation	On/Off selectable
Auto Gain Control	Yes (level 0~150)
Auto White Balance	ATW/Push/Manual
DNR	Off/Low/Mid/High selectable
OSD Menu	Yes (controlled from 5-Axis joystick control)
Image Flip	Off/H Flip/V Flip/HV Flip
IR Wavelength	850nm
IR Range	Up to 45m (~150 ft.)
Power Source & Consumption	24VAC: 12W max. (~500mA) 12VDC: 1.1A max.
Dimensions	196mm(L) x 83mm(H) x 110mm Diameter(W) 12.9in.(L) x 3.26in.(H) x 4.33in. Diameter(W)
Weight	2kg /4.4 lbs
Operating Temperature	-10°C~50°C ; 14°F~122°F
Weather Proof	IP67 rated
Vandal Resistant	Yes
Certifications	FCC/CE; HDcctv Alliance Base Line Compliance

1.4 Dimensions

Unit: mm(inch)

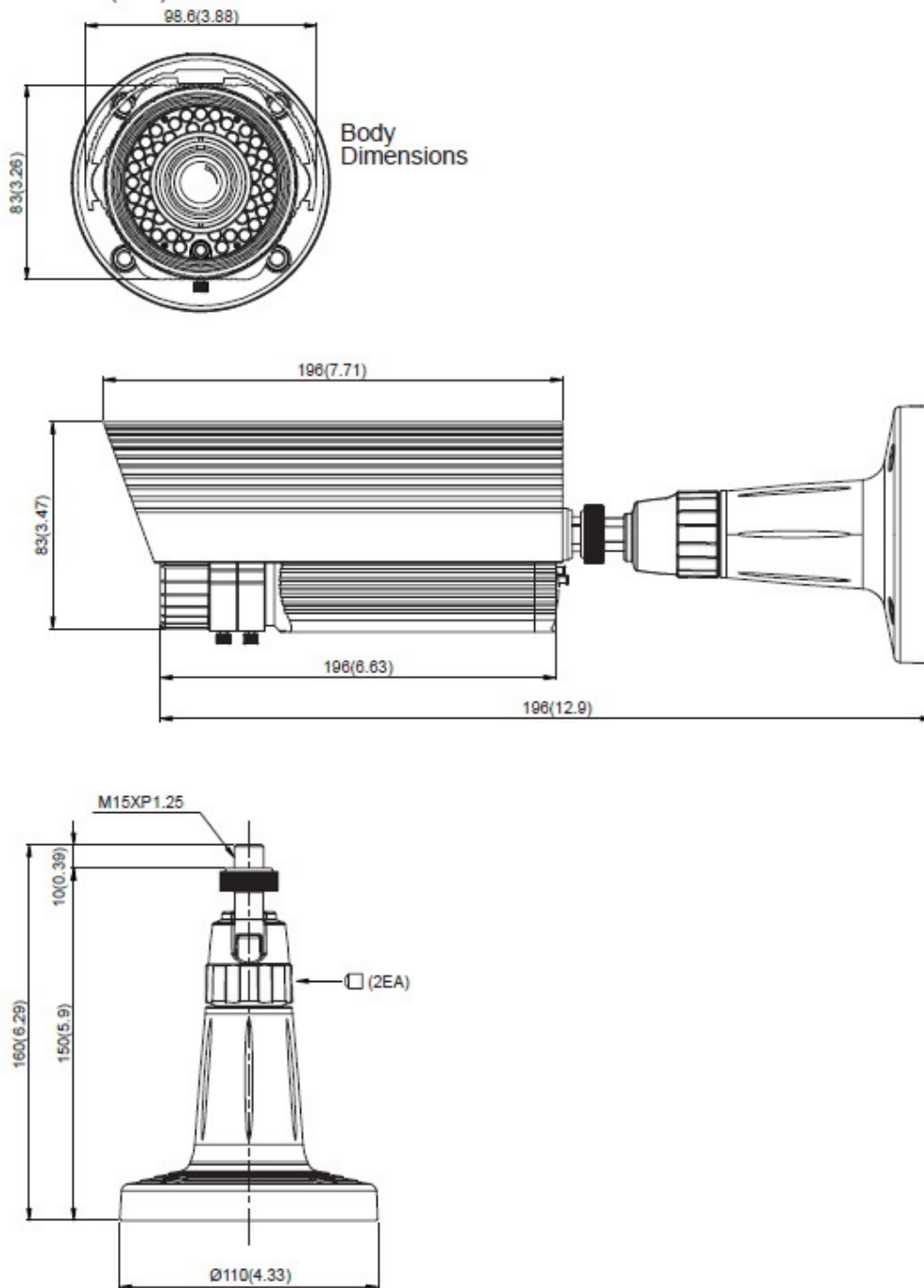

Chapter 2

2. Installation

Adjusting camera mounting position

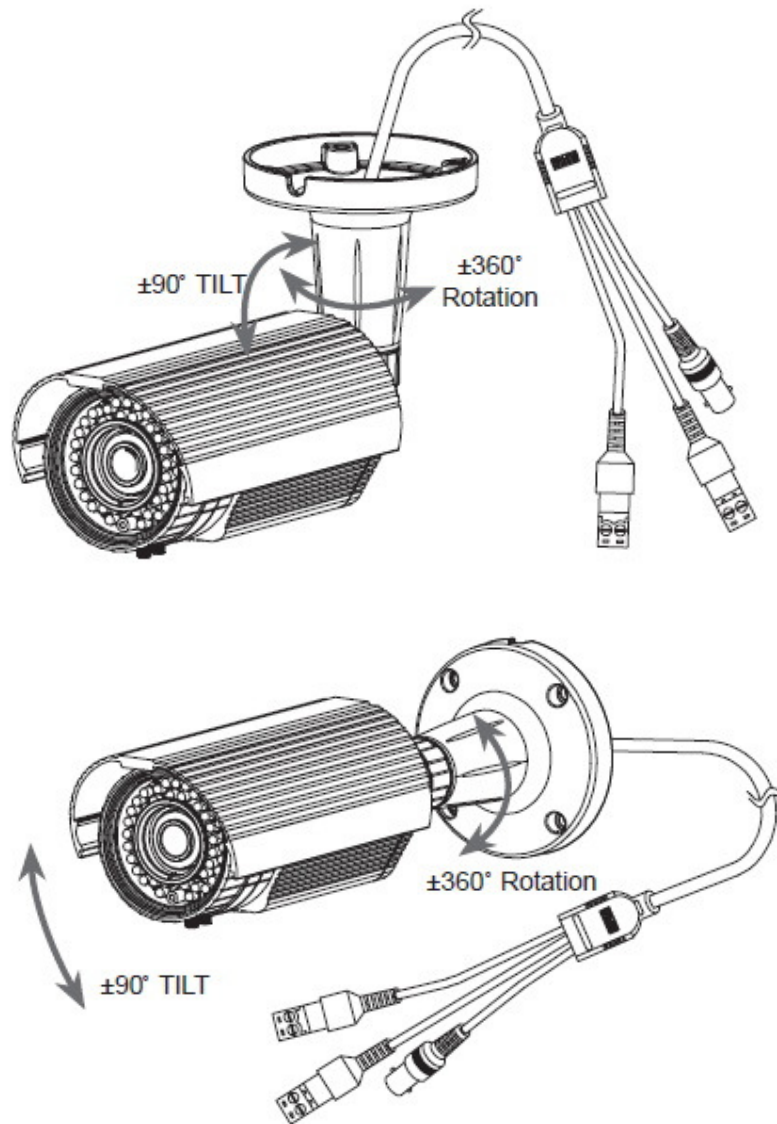

<Cable Concealed Inside Bracket>

External Zoom & Focus Adjustment

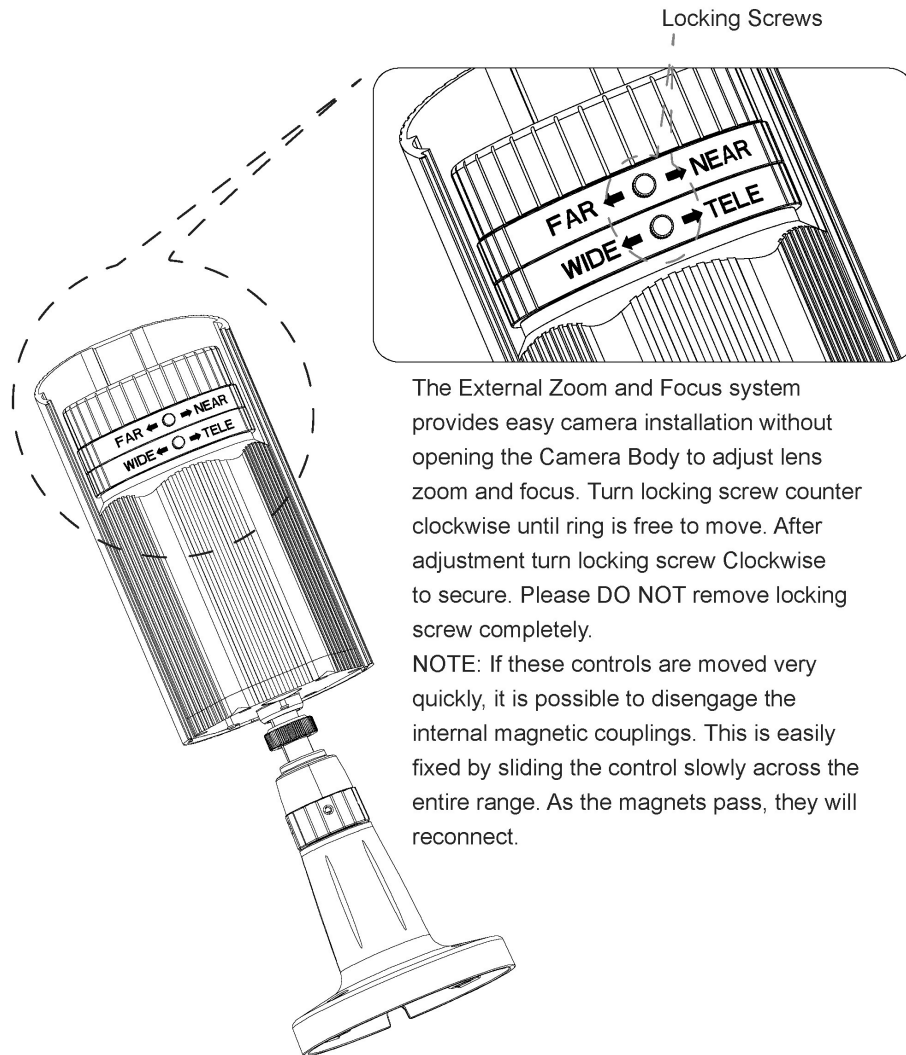

The External Zoom and Focus system provides easy camera installation without opening the Camera Body to adjust lens zoom and focus. Turn locking screw counter clockwise until ring is free to move. After adjustment turn locking screw Clockwise to secure. Please **DO NOT** remove locking screw completely.

NOTE: If these controls are moved very quickly, it is possible to disengage the internal magnetic couplings. This is easily fixed by sliding the control slowly across the entire range. As the magnets pass, they will reconnect.

Service Video Out & OSD Control

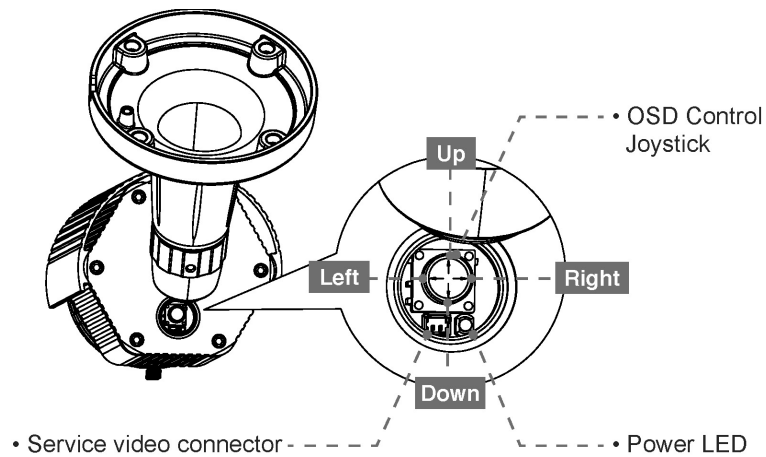

• CONNECTION

NOTE: We recommend that for convenience the service Video Output BNC Cable be plugged in prior to mounting

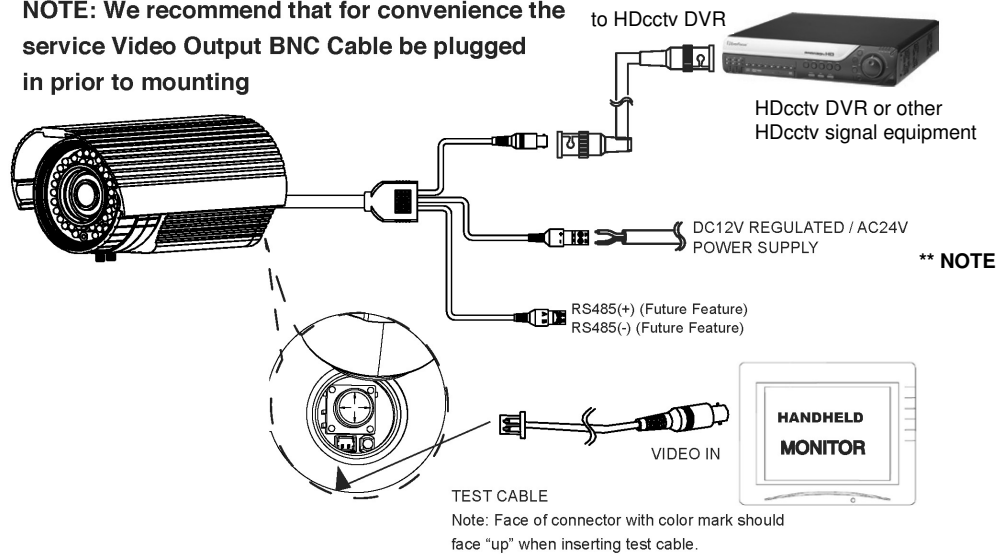

! When you install the camera, please seal the ends of cables to protect the camera connections from humidity problems.

****NOTE:**

1. Separate two parts of the power adaptor
2. Remove the part with the screws
3. Attach it to the wire
4. Reconnect to end of cable

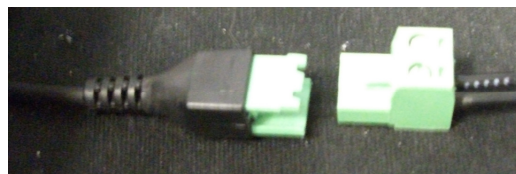
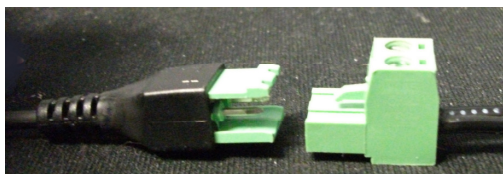

3. OSD Menu & Configuration

This chapter introduces how to configure the camera OSD menu.

- **Menu structure**

- **Main Menu**

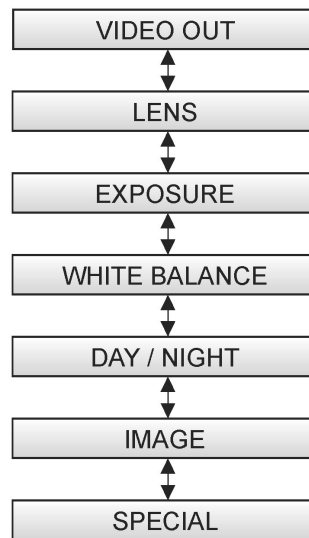

- **VIDEO OUT Menu**

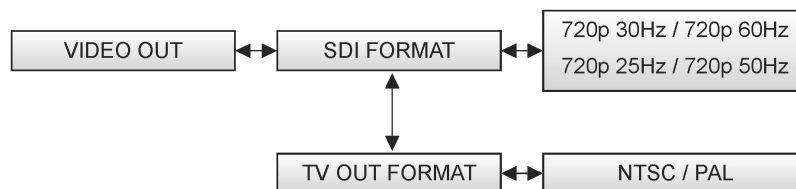

- LENS Menu

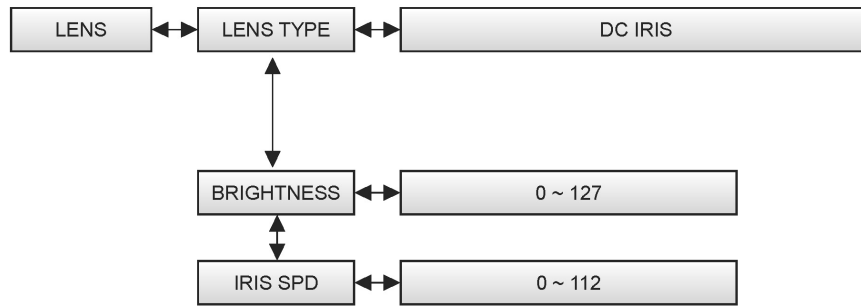

- EXPOSURE Menu

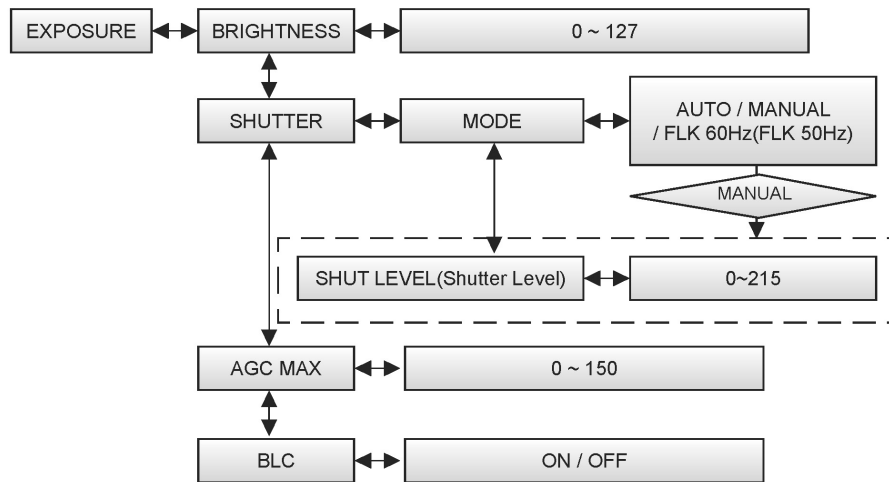

- WHITE BALANCE Menu

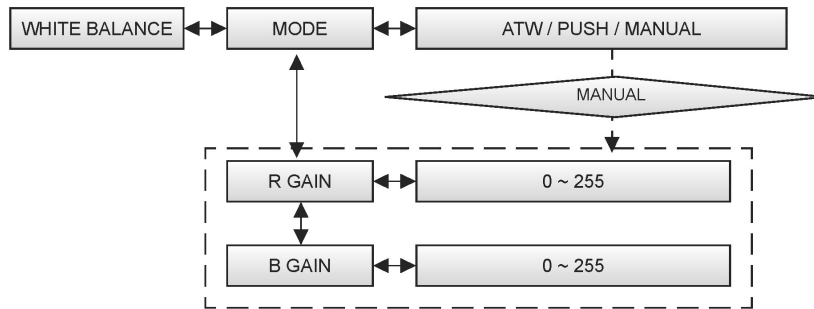

- DAY / NIGHT Menu

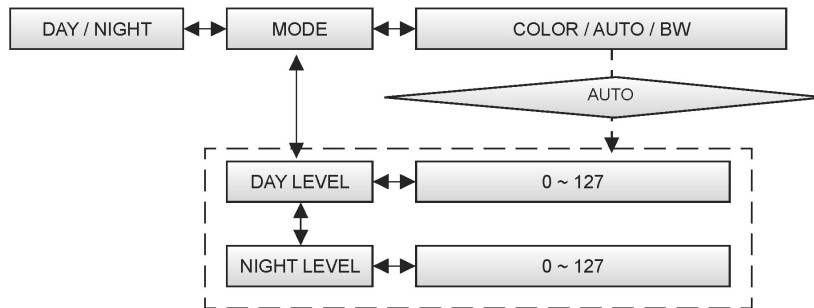



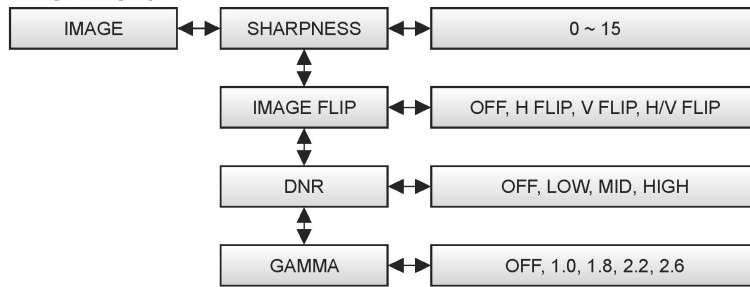

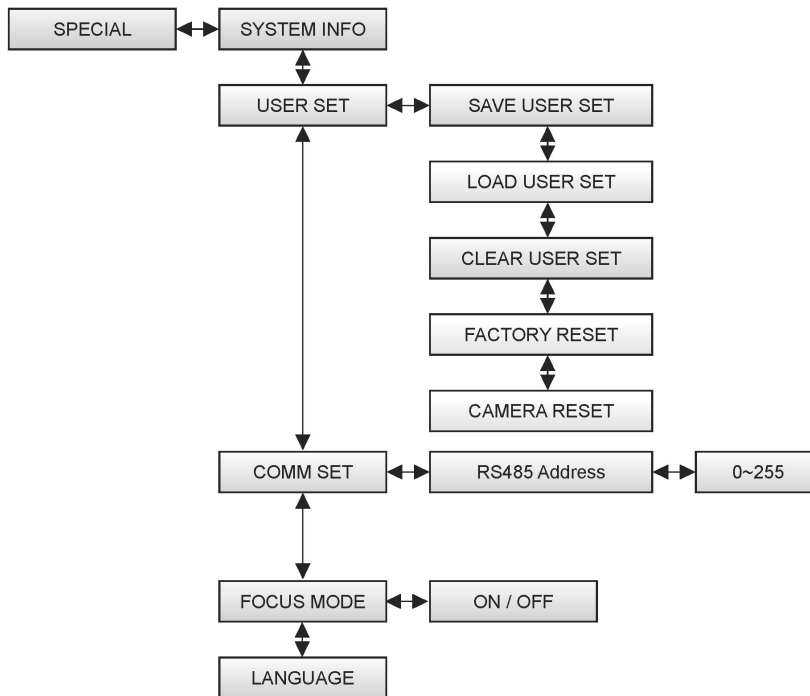

- IMAGE Menu



- SPECIAL Menu



• ICONS

-  : Value adjustment(use LEFT/RIGHT button).
-  : Select Sub Menu(use SET button).
-  : Execution command(use SET button).
-  : Return to previous menu.
-  : Menu OFF.
-  : Information.

The [SETUP] menu will show up when you push the SET button

• Main Menu

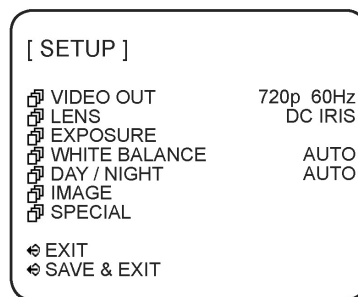

- **VIDEO OUT** : Select SDI Out format and TV Out format.
- **LENS** : Select the IRIS TYPE and adjust IRIS control value.
- **EXPOSURE** : Adjust Exposure control.
- **WHITE BALANCE** : Adjust White balance control.
- **DAY / NIGHT** : Day / Night control.
- **IMAGE** : Apply Image processing effects.
- **SPECIAL** : System setting, IO setting, USER SET setting
- **EXIT** : Close OSD Menu.
- **SAVE & EXIT** : Save and Close OSD Menu. These settings are loaded and applied automatically when the Camera is power on

• Video Out

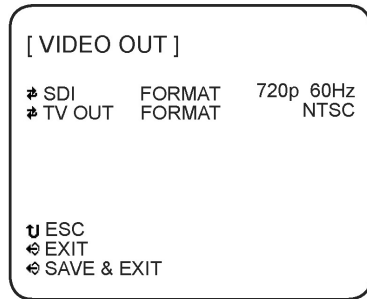

- SDI Format

Select SDI output Formats – 720p 30Hz, 720p 60Hz, 720p 25Hz and 720p 50Hz.

- TV Out Format

Select NTSC / PAL.

Note : NTSC or PAL Video Format can be selected by pressing the RIGHT Button even when the OSD Menu is turned off

- ESC

Back to the previous

• LENS

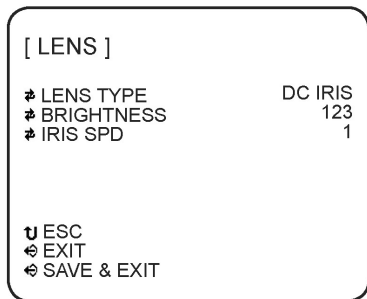

- LENS TYPE

DC IRIS.

- BRIGHTNESS

Using Left / Right button, adjust Brightness value.

- IRIS SPD

Using Left / Right button, adjust Iris speed value.

• **EXPOSURE**

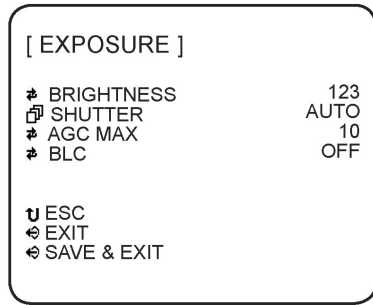

- **BRIGHTNESS**

Same as the BRIGHTNESS value in LENS Menu. Using Left / Right button, adjust Brightness value.

- **SHUTTER**

Using Set button, go to the SHUTTER sub menu.

- **AGC MAX**

Using Left / Right button, adjust AGC Max value.

- **BLC**

Using Left / Right button, select on/off of Back-Light Compensation Control.

• **SHUTTER (Sub Menu)**

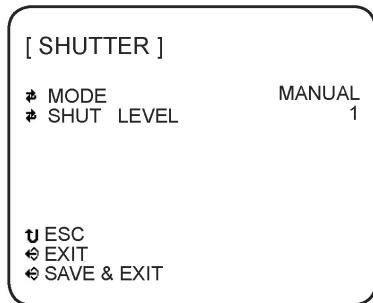

-- **MODE**

Using Left / Right button, select Shutter Control modes – AUTO, MANUAL and FLK 60Hz (FLK 50Hz).

AUTO	Auto Exposure mode
MANUAL	Manual Exposure mode
FLK 60Hz (FLK 50Hz)	Flickerless mode (Default)

- **SHUT LEVEL (Shutter Level)**

This menu can be accessed when the Shutter Speed is set to MANUAL.

Use the Left / Right button to adjust the shutter speed control level.

Instead of using the default conventional shutter speed of 1/60, you may choose other speeds. The speeds corresponding to the value of shutter level are listed below.

Shutter Speed	1/50	1/60	1/100	1/120	1/250	1/500	1/700	1/1000	1/1600	1/2500	1/5000	1/7000	1/10000
Level	178	169	142	135	105	65	46	32	20	12	6	4	3

• WHITE BALANCE

[WHITE BALANCE]	
⌘ MODE	MANUAL
⌘ R GAIN	100
⌘ B GAIN	100
⏏ ESC	
⏏ EXIT	
⏏ SAVE & EXIT	

- MODE

Using Left / Right button, select White balance modes – ATW, PUSH and MANUAL.

ATW	Auto Trace White Balance mode
PUSH	White Balance Push Lock mode (Auto White Balance Control & Lock)
MANUAL	Manual White Balance mode

- R GAIN

This menu appears on screen when MANUAL is selected.
Using Left / Right button, adjust Red Gain.

-B GAIN

This menu appears on screen when MANUAL is selected.
Using Left / Right button, adjust Blue Gain.

* NOTE

R GAIN and B GAIN is correlated with the G GAIN internally, so the R GAIN and B GAIN may increase or decrease with the other color gain.

• Day / Night

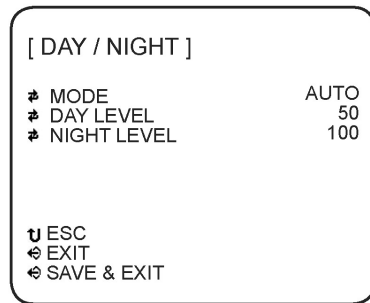

- MODE

Using Left / Right button, select modes – AUTO, COLOR, and BW.

AUTO	Controlled by Signal from CDS sensor. (Photocell)
COLOR	Fixed Day State. Color Image.
BW	Fixed Night State. BW Image.

- DAY/Night Levels

This menu can be displayed by selecting AUTO or EXT in the MODE Menu.
 The Day Level and Night Level thresholds function independently from each other.

- DAY LEVEL

The threshold of change from B&W Mode to Color Mode can be adjusted with values between 0 - 127. A lower value will prevent the camera from switching to Color until the scene becomes brighter.

- NIGHT LEVEL

The threshold of change from Color Mode to B&W Mode can be adjusted with values between 0 - 127. A higher value will prevent the camera from switching to B&W until the scene becomes darker.

Note: There is a built in offset between the Day and Night Level to prevent a switching level conflict. The effective Day level can not be set lower than the Night level

• **IMAGE**

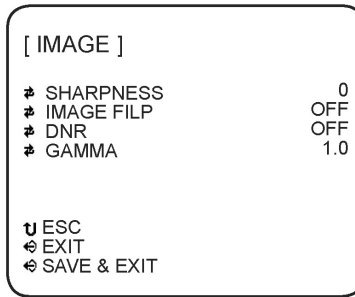

- **SHARPNESS:** Using Left / Right button, adjust sharpness value.
- **IMAGE FLIP:** Using Left / Right button, select Flip modes – OFF, H FLIP, V FLIP and HW FLIP.
- **DNR:** Using Left / Right button, select Digital Noise Reduction Modes - OFF, LOW, MID, HIGH.
- **GAMMA:** Using Left / Right button, adjust gamma control setting.

• **SPECIAL**

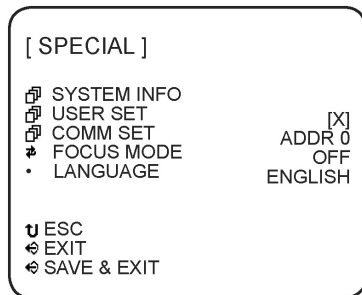

SYSTEM INFO

Display Camera Version, SDI IF F/W Version & other information.

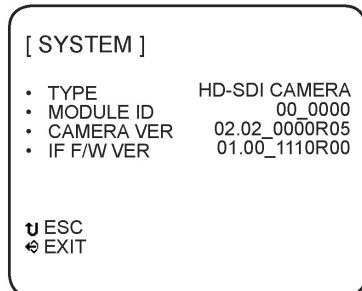

- USER SET

Using Set button, display [USER SET] sub menu.

- FOCUS MODE

In focus mode, the iris becomes fully open, electronic shutter controls the light level, and the TV out screen zooms into the center in order to make focusing easier. When in Focus Mode, the OSD Menu is not displayed. The OSD Menu can be toggled ON and OFF using the Left / Right button.

> TV Out Image



FOCUS MODE OFF



FOCUS MODE ON

- LANGUAGE

Select OSD Language. (Only English is available, currently)

• USER SET (Sub Menu)

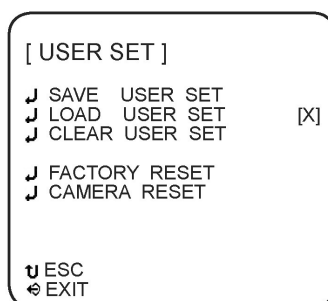

- SAVE USER SET

Saves a copy of the current configuration set by the user into a separate memory area. If user set data has been saved, an [O] mark is displayed and if not, an [X] mark is displayed.

User Set settings can NOT be loaded automatically when the camera is powered on. They can only be loaded manually via the "LOAD USER SET" OSD choice. To make the values in a User Set become the configuration loaded when the camera is powered on, first load that User set, then choose "SAVE AND EXIT" in any of the OSD Screens; the current User Set OSD Settings will be written to the power on configuration. These steps effectively copy a User Set to the power on configuration.

- LOAD USER SET

Load the saved user set, and applies to Camera.

- CLEAR USER SET

Clear all saved user set.

- FACTORY RESET

Clear all setting and initialize to factory setting.

Clear user set.

- CAMERA RESET

Reboot the Camera

• COMM SET(Sub Menu)

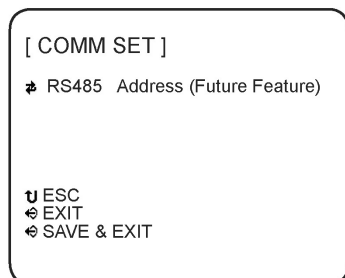

- RS485 Address

Future Feature.

EverFocus Electronics Corp.

EverFocus Taiwan:

12F, No.79, Sec. 1, Shin-Tai Wu Road,
Hsi-Chih, Taipei, Taiwan
TEL: +886 2 2698 2334
FAX: +886 2 2698 2380
www.everfocus.com.tw
marketing@everfocus.com.tw

EverFocus China - Beijing:

Room 609, Technology Trade Building,
Shangdi Information Industry Base,
Haidian District, Beijing 100085, China
TEL: +86 10 6297 3336~39
FAX: +86 10 6297 1423
www.everfocus.com.cn
marketing@everfocus.com.cn

EverFocus USA - California:

1801 Highland Avenue, Unit A, Duarte, CA
91010, USA
TEL: +1 626 844 8888
FAX: +1 626 844 8838
www.everfocus.com
sales@everfocus.com

EverFocus Japan:

5F, Kinshicho City Building, 2-13-4 Koto-
Bashi, Sumida-Ku, Tokyo, 130-0022, Japan
TEL: +81 3 5625 8188
FAX: +81 3 5625 8189
www.everfocus.co.jp
info@everfocus.co.jp

EverFocus India:

Suite 803, Housefin Bhavan, C-21,
Bandra Kurla Complex, Bandra (East),
Mumbai 400051, India
TEL: +91 22 6128 8700
FAX: +91 22 6128 8705
www.everfocus.in
sales@everfocus.in

EverFocus Europe - Germany:

Albert-Einstein-Strasse 1, D-46446
Emmerich, Germany
TEL: +49 2822 93940
FAX: +49 2822 939495
www.everfocus.de
info@everfocus.de

EverFocus China - Shenzhen:

4F, No. 2, D4 Building, Wan Yelong
Industrial Park, Tangtou Road, Shiyan,
Baoan, Shenzhen, Guangdong 518101, China
TEL: +86 755 2765 1313
FAX: +86 755 2765 0337
www.everfocus.com.cn
marketing@everfocus.com.cn

EverFocus USA - New York:

415 Oser Avenue, Unit S, Hauppauge, NY 11788,
USA
TEL: +1 631 436 5070
FAX: +1 631 436 5027
www.everfocus.com
sales@everfocus.com

EverFocus Europe - UK:

Unit 12, Spitfire Business Park,
Hawker Road, Croydon Surrey, CR0 4WD, UK
TEL: +44 (0) 20 8649 9757 / 0845 430 9999
FAX: +44 (0) 20 8649 9907
www.everfocus.com
salesuk@everfocus.com

	<p>Your EverFocus product is designed and manufactured with high quality materials and components which can be recycled and reused.</p> <p>This symbol means that electrical and electronic equipment, at their end-of-life, should be disposed of separately from your household waste.</p> <p>Please, dispose of this equipment at your local community waste collection/recycling centre.</p> <p>In the European Union there are separate collection systems for used electrical and electronic product.</p> <p>Please, help us to conserve the environment we live in!</p>	<p>Ihr EverFocus Produkt wurde entwickelt und hergestellt mit qualitativ hochwertigen Materialien und Komponenten, die recycelt und wieder verwendet werden können.</p> <p>Dieses Symbol bedeutet, dass elektrische und elektronische Geräte am Ende ihrer Nutzungsdauer vom Hausmüll getrennt entsorgt werden sollen.</p> <p>Bitte entsorgen Sie dieses Gerät bei Ihrer örtlichen kommunalen Sammelstelle oder im Recycling Centre.</p> <p>Helfen Sie uns bitte, die Umwelt zu erhalten, in der wir leben!</p>
---	--	---



Free Manuals Download Website

<http://myh66.com>

<http://usermanuals.us>

<http://www.somanuals.com>

<http://www.4manuals.cc>

<http://www.manual-lib.com>

<http://www.404manual.com>

<http://www.luxmanual.com>

<http://aubethermostatmanual.com>

Golf course search by state

<http://golfingnear.com>

Email search by domain

<http://emailbydomain.com>

Auto manuals search

<http://auto.somanuals.com>

TV manuals search

<http://tv.somanuals.com>