



EverFocus®

Indoor DWDR 3-Axis Varifocal 700TVL IR Dome Camera Operation Instructions

Model No. **ED640**

Please read this manual first for correct installation and operation. This manual should be retained for future reference. The information in this manual was current when published. The manufacturer reserves the right to revise and improve its products. All specifications are therefore subject to change without notice.

PRECAUTIONS

1. Do not install the camera near electric or magnetic fields.

Install the camera away from TV/radio transmitters, magnets, electric motors, transformers and audio speakers since the electromagnetic fields generated from these devices may distort the video image or otherwise interfere with camera operation.

2. Never disassemble the camera beyond the recommendations in this manual nor introduce materials other than those recommended herein. Improper disassembly or introduction of corrosive materials may result in equipment failure or other damage.

3. Try to avoid facing the camera toward the sun.

In some circumstances, direct sunlight may cause permanent damage to the sensor and/or internal circuits, as well as creating unbalanced illumination beyond the capability of the camera to compensate.

4. Keep the power cord away from water and other liquids and never touch the power cord with wet hands. Touching a wet power cord with your hands or touching the power cord with wet hands may result in electric shock.

5. Never install the camera in areas exposed to oil, gas or solvents.

Oil, gas or solvents may result in equipment failure, electric shock or, in extreme cases, fire.

6. Cleaning

For cameras with interchangeable lenses, do not touch the surface of the sensor directly with the hands. Use lens tissue or a cotton tipped applicator and ethanol to clean the sensor and the camera lens. Use a damp soft cloth to remove any dirt from the camera body. Please do not use complex solvents, corrosive or abrasive agents for cleaning of any part of the camera.

7. Do not operate the camera beyond the specified temperature, humidity or power source ratings. This camera is suitable for indoor operation only. Use the camera at temperatures within $-10^{\circ} \sim +50^{\circ}$ ($14^{\circ}\text{F} \sim 122^{\circ}\text{F}$) and humidity between 30% and 90%. The input power source is 12VDC. Regulated power supply required.

8. Mounting

Use care in selecting a solid mounting surface which will support the weight of the camera plus any wind, snow, ice or other loading, and securely attach the camera to the mounting surface using screws and anchors which will properly support the camera. If necessary (e.g. when mounting to drop ceilings) use a safety wire to provide additional support for the camera.

Table of Contents

Product Overview	2
Main Features	2
Box Contents	2
Specifications.....	3
Dimensions	4
Installation	5
OSD Menu Controls and Test Point	5
Lens Adjustment.....	5
Menu Setting	6

Product Overview

Get superior performance and high resolution images in bright light or *no* light. The EverFocus ED640 uses a Sony Super HAD II Color CCD to produce high quality color images with a minimum of 630 horizontal TV lines of resolution. Combine this with digital day/night, a native low light sensitivity of 0.01 lux, and 24 IR LEDs with a range of 82 feet (depending on scene IR reflectivity), a 3-axis wall or ceiling mount indoor plastic housing and you have a cost effective camera that fits a wide variety of indoor applications. The ED640 comes with a 2.8~12mm VF AI lens that covers a field of view up to 82° wide, or can magnify images for increased detail. With low 12VDC current draw, this is the camera that you have been waiting for to create analog CCTV systems that deliver superior image clarity in a wide range of indoor applications at virtually any light level.

Features

- 1/3" Sony Super HAD II Color CCD with high resolution of 700TVL for high image clarity
- Full OSD with features like DWDR, HLC/BLC, DNR, Anti-Color-Roll and more
- 2.8~12mm VF AI lens covers from wide angle of 82° to moderate telephoto field of view
- 3-Axis camera mount for flexible mounting and positioning
- 24 *smart* IR LEDs with range of 82 feet for long distance coverage
- *Smart* LEDs avoid over exposure of close in objects
- Digital Day/Night for color in bright light, IR illuminated B/W in low light
- DC12V only 320mA draw

Box Contents

Camera
User Guide
Mounting Screw (3)
Power adaptor pigtail
Housing Opener
Mounting template
Video Test Point Cable

Specifications

TV System	NTSC	
Image Sensor	1/3" Sony Super HAD II Color CCD	
Effective Pixels	768Hx494V	
Resolution	700 TV Lines	
Lens	2.8~12mm VF AI	
Scanning System	525Lines, 2:1Interlace	
Scanning Frequency	15.734KHz(H),59.94Hz	
Auto Shutter Speed	1/60 to 1/100,000sec.	
Sync. System	Internal	
S/N Ratio	More than 52dB (AGC off)	
OSD	5 Button Navigation. Multiple options	
OSD Language	English, Spanish, French, Portuguese, German, Polish, Japanese, Chinese	
Day & Night	Auto/Color Black & White; Digital Day/Night with programmable switch levels and delays	
Min. Illumination	0.01 lux nominal; 0 lux with IR LEDs on	
IR LEDs	24 <i>smart</i> LEDs, 850nm	
IR Range	82 feet (depends on scene IR reflectivity)	
Smart IR Control	Off/On with programmable area of interest and gain	
Auto Gain Control	Off, Low, Middle, High	
DWDR	Off/On with adjustable weight	
BLC/HLC	BLC	Off/On for two areas with programmable area of interest and gain
	HLC	Off/Night Only/Always with adjustable level
Gamma Correction	0.45; Display compensation option for CRT or LCD with adjustable levels	
DNR	2D DNR Off/On	
Lens Shading Compensation	Off/On, adjustable for level and image center	
Mirror	Off/On	
Negative Image	Off/On	
White Balance	AWB (2,100°k ~ 9,100°k)	
Digital Pixel Correction	Manual operation; programmable threshold and area	

Motion Detection	On screen indication; up to 4 programmable areas
Privacy Zones	Up to 8 areas programmable for location and color
Video Output	NTSC CVBS, 1Vp-p, 75Ω
Power Supply	DC 12V±10%
Power Consumption	160mA Nominal / 320mA IR ON
Operating Temperature	14°F ~ 122°F ; -10°C~50°C
Storage Temperature	-4°F ~ 140°F ; -20°C~60°C
Operating Humidity	to 90% RH max.
Dimension	4.41"/112mm diameter, 3.43"/87mm high
Weight	7.2oz/205g
Certifications	CE/FCC

Dimensions

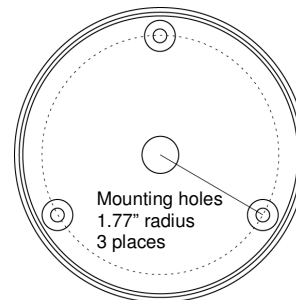
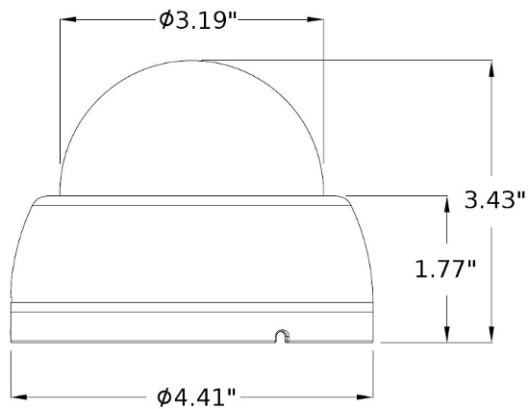

UPPER

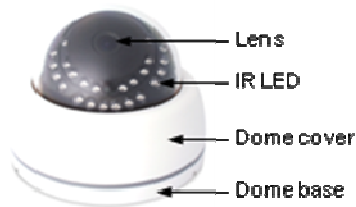

BOTTOM

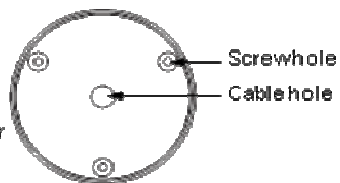

Installation

Warning: To prevent electrical shock, turn off the electrical power before making electrical connections. OBSERVE POLARITY when connecting 12VDC power to the camera.

1. Select mounting location. Open cover using tool provided.
2. Place template and drill holes (5/8" minimum for wires, ~1/4" for hollow wall anchors; ~3/32" pilot hole for screws alone). Insert wall anchors if used.
3. Mount camera to ceiling with 3 screws and adjust camera direction.
4. Replace dome cover on base (snaps on).

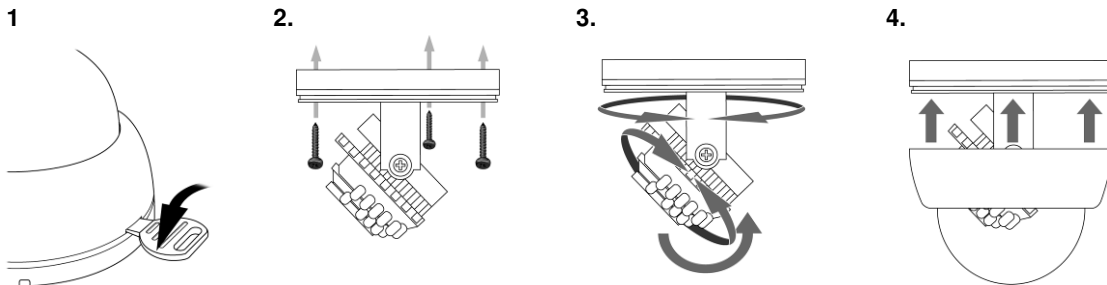

OSD Menu Controls and Video Test Point

Press the Menu/Enter button to bring up the OSD menu. Navigate the menu with the direction keys. Select RETURN to move back to the previous level menu. When exiting the main menu, choose SAVE, NOT SAVE or RESET (factory defaults) as desired.

Use adapter cable supplied to connect test monitor to video test point.

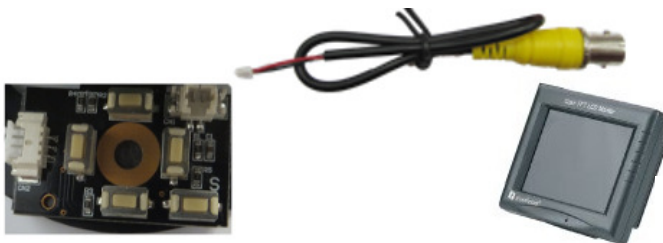
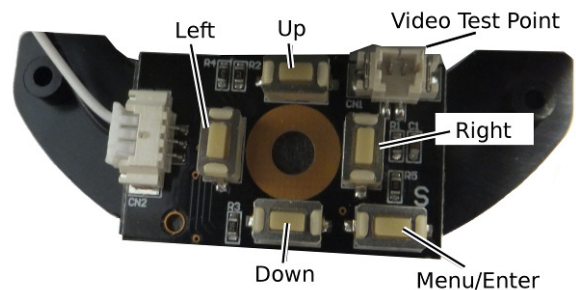

Lens Adjustment

Use fingers or screwdriver to adjust field of view (zoom) and focus.

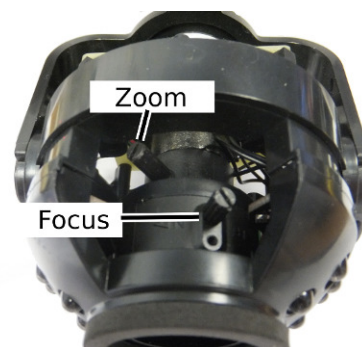

Menu Setting (Default values shown in parentheses).

(Rev. 1.1)

MENU	SUB MENU AND FACTORY SETTING PARAMETERS				
LENS (DC)	DC	BRIGHTNESS	0 ~ 255	(50)	
		IRIS SPEED	0 ~ 15	(5)	
	MANUAL	BRIGHTNESS	0 ~ 255	(50)	
EXPOSURE	SHUTTER	AUTO, 1/60(50), FLK, 1/250, 1/500, 1/1000, 1/2000, 1/4000, 1/5000, 1/10000, 1/100000 (1/60)			
	AGC	OFF, LOW, MIDDLE, HIGH (MIDDLE)			
	DWDR (OFF)	LEVEL	0 ~ 63	(32)	
WHITE BAL (ATW1)	ATW1				
	ATW2				
	AWC→SET				
	ANTI.CRL				
	MANUAL	COLOR TEMP	MANUAL, INDOOR, OUTDOOR		
		BLUE (MANUAL)	0 ~ 255	(65)	
		RED (MANUAL)	0 ~ 255	(26)	
BACKLIGHT (OFF)	(OFF)				
	BLC	AREA SEL.	AREA1, AREA2		
		AREA STATE	ON, OFF		
		GAIN	0 ~ 255	(128)	
		HEIGHT	0 ~ 10	(005)	
		WIDTH	0 ~ 10	(005)	
		LEFT/RIGHT	0 ~ 15	(005)	
		TOP/BOTTOM	0 ~ 15	(005)	
	HLC	D=>N LEVEL	0 ~ 255	(177)	
		MODE	NIGHT ONLY, ALL DAY (NIGHT ONLY)		
		MASK SKIP	OFF, ON	(OFF)	
DAYNIGHT (AUTO)	AUTO	D=>N LEVEL	160~255	(192)	
		D-->N DELAY	1 ~ 30	(1) SEC	
		N=> D LEVEL	0 ~ 64	(032)	
		N-->D DELAY	0 ~ 30	(5) SEC	
	COLOR				
	B/W	BURST	ON,OFF (OFF)		
		IR SMART	ON, OFF (ON)		
			IR GAIN	0 ~ 255	(122)
			HEIGHT	0 ~ 015	(006)
			WIDTH	0 ~ 015	(010)
LEFT/RIGHT			0 ~ 015	(002)	
TOP/DOWN			0 ~ 015	(007)	
IR LEVEL	HIGH, LOW (HIGH)				

MENU		SUB MENU AND DEFAULT SETTING				
DAYNIGHT (AUTO)	EXT	D=>N DELAY	0 ~ 30		(1)	
		N=>D DELAY	0 ~ 30		(1)	
DPC	START	(Cover the lens then press enter key) → Process now				
	DPC VIEW	OFF, ON		(OFF)		
	LS VALUE	0 ~ 63		(015)		
	DIFF.	0 ~ 63		(010)		
	AREA HS	0 ~ 255		(021)		
	AREA HE	0 ~ 255		(255)		
	AREA VS	0 ~ 255		(008)		
	AREA VE	0 ~ 255		(118)		
SPECIAL	CAM TITLE	OFF, ON		(ON)		
	MOTION (OFF)	AREA	1~4		(AREA1)	
		AREA STATE	ON,OFF		(OFF)	
		HEIGHT	0~15		(4)	
		WIDTH	0~15		(4)	
		LEFT/RIGHT	0~15		(3)	
		TOP/BOTTOM	0~15		(2)	
		DEGREE	0~255		(32)	
	VIEW	ON,OFF		(ON)		
	PRIVACY (OFF)	AREA	1~8		(1)	
		AREA STATE	ON,OFF		(ON)	
SPECIAL	PRIVACY	HEIGHT	0 ~ 125		(032)	
		WIDTH	0 ~ 215		(032)	
		LEFT/RIGHT	0 ~ 220		(032)	
		TOP/BOTTOM	0 ~ 105		(016)	
		COLOR	0~15		(014)	
IMAGE ADJ.	LENS SHAD. (OFF)	LEVEL	0~255		(157)	
		H-CENTER	0~255		(074)	
		V-CENTER	0~255		(053)	
	2DNR	ON, OFF		(ON)		
	MIRROR	ON, OFF		(OFF)		
	FONT COLOR	FONT	0 ~ 15		(003)	
		ID & TITLE	0 ~ 15		(003)	
	CONTRAST	0 ~ 255		(137)		
	SHARPNESS	0 ~ 31		(016)		

MENU		SUB MENU AND DEFAULT SETTING			
		DISPLAY	CRT	PED LEVEL	0~63 (028)
				COLOR GAIN	0~255 (192)
			LCD	GAMMA	0.3~1.0 (0.55)
				PED LEVEL	0~63 (028)
				COLOR GAIN	0~255 (192)
				GAMMA	0.3~1.0 (0.45)
SPECIAL	IMAGE ADJ.	DISPLAY	USER	PED LEVEL	0~63 (028)
				COLOR GAIN	0~255 (176)
			NEG.IMAGE	ON, OFF	(OFF)
	LANGUAGE (ENGLISH)	ENGLISH,CHINESE1, ESPANOL, POLISH, DEUTSCH, PORTU FRANCAIS,JAPANESE			
	VERSION	00 00 00			
EXIT	SAVE, NOT SAVE, RESET				

*Depending on setting of sub menu, the default value may be changed.

EverFocus Electronics Corp.

Corporate Headquarters:

12F, No.79 Sec. 1 Shin-Tai Wu Road,
Hsi-Chih, Taipei, Taiwan
TEL: +886-2-26982334
FAX: +886-2-26982380
www.everfocus.com.tw
marketing@everfocus.com.tw

China Office:

Room 609, Technology Trade Building,
Shangdi Information Industry Base,
Haidian District, Beijing, China 100085
TEL: +86-10-62973336~39
FAX: +86-10-62971423
www.everfocus.com.cn
marketing@everfocus.com.cn

U.S.A - California Office:

1801 Highland Avenue Units A & B
Duarte, CA 91010
TEL: +1-626-844-8888
FAX: +1-626-844-8838
www.everfocus.com
sales@everfocus.com

U.S.A - New York Office:

415 Oser Avenue Unit S
Happauge, NY 11788
TEL: +1-631-436-5070
FAX: +1-631-436-5027
www.everfocus.com
sales@everfocus.com

Europe - Germany Office:

Albert-Einstein-Strasse 1,
D-46446 Emmerich, Germany
TEL: +49-2822-93940
FAX: +49-2822-939495
www.everfocus.de
info@everfocus.de

Japan Office:

5F Kinshicho city Building,
2-13-4 Koto-Bashi,
Sumida-Ku, Tokyo, 130-0022 Japan
TEL: +81-3-5625-8188
FAX: +81-3-5625-8189
www.everfocus.co.jp
info@everfocus.co.jp

India Office:

Suite 803, Housefin Bhavan, C-21,
Bandra Kurla Complex, Bandra (East),
Mumbai 400051. India.
TEL: +91-222-444-8791
FAX: +91-222-444-8790
www.everfocus.in

UK Office:

Unit 12 Spitfire Business Park
Hawker Road
Croydon, CR0 4WD
London: 0845 430 9999
Telford: 0845 430 8888
Fax: 020 8649 9907
uk.support@EverFocus.com

	<p>Your EverFocus product is designed and manufactured with high quality materials and components which can be recycled and reused. This symbol means that electrical and electronic equipment, at their end-of-life, should be disposed of separately from your household waste. Please, dispose of this equipment at your local community waste collection/recycling centre. In the European Union there are separate collection systems for used electrical and electronic product. Please, help us to conserve the environment we live in!</p>	<p>Ihr EverFocus Produkt wurde entwickelt und hergestellt mit qualitativ hochwertigen Materialien und Komponenten, die recycelt und wieder verwendet werden können. Dieses Symbol bedeutet, dass elektrische und elektronische Geräte am Ende ihrer Nutzungsdauer vom Hausmüll getrennt entsorgt werden sollen. Bitte entsorgen Sie dieses Gerät bei Ihrer örtlichen kommunalen Sammelstelle oder im Recycling Centre.</p>
---	--	--



Free Manuals Download Website

<http://myh66.com>

<http://usermanuals.us>

<http://www.somanuals.com>

<http://www.4manuals.cc>

<http://www.manual-lib.com>

<http://www.404manual.com>

<http://www.luxmanual.com>

<http://aubethermostatmanual.com>

Golf course search by state

<http://golfingnear.com>

Email search by domain

<http://emailbydomain.com>

Auto manuals search

<http://auto.somanuals.com>

TV manuals search

<http://tv.somanuals.com>