INSTALLATION / OPERATION

EDR-920

9-channel Digital Video Recorder



EDR-1640

16-channel Digital Video Recorder



Rev 1.00

Safety warnings

Safety warnings

To avoid any damage, please consider the following safety warnings:



Never place the recorder near to heaters, furnaces, other heat sources or under direct solar irradiation.
Operate the device only in locations providing the tolerable operating temperature range 0°C~40°C.



Make sure that the device's ventilation slots are not covered or sheeted.



For cleaning, make sure the device is plugged off and only use a damp cloth without acid detergent.



Install the device only in dry and dustproof surroundings. Protect the device against any liquid's penetration.



Avoid the penetration of any artefacts, e.g. through ventilation slots.



Do not open the recorder yourself. In case of malfunction, contact your local installer or dealer. Unauthorized opening of the device will annul the warranty claim!



Avoid any affection of the device through vibrations or mechanical shock at the recorder's installation location.



Never remove harddisks during playback or recording operation.

	<p>Your EverFocus product is designed and manufactured with high quality materials and components which can be recycled and reused. This symbol means that electrical and electronic equipment, at their end-of-life, should be disposed of separately from your household waste. Please, dispose of this equipment at your local community waste collection/recycling centre. In the European Union there are separate collection systems for used electrical and electronic product. Please, help us to conserve the environment we live in!</p>	<p>Ihr EverFocus Produkt wurde entwickelt und hergestellt mit qualitativ hochwertigen Materialien und Komponenten, die recycelt und wieder verwendet werden können. Dieses Symbol bedeutet, dass elektrische und elektronische Geräte am Ende ihrer Nutzungsdauer vom Hausmüll getrennt entsorgt werden sollen. Bitte entsorgen Sie dieses Gerät bei Ihrer örtlichen kommunalen Sammelstelle oder im Recycling Centre. Helfen Sie uns bitte, die Umwelt zu erhalten, in der wir leben!</p>
---	--	--



ATTENTION! This is a class A product which may cause radio interference in a domestic environment; in this case, the user may be urged to take adequate measures.

The information in this manual was current upon publication. The manufacturer reserves the right to revise and improve his products. Therefore, all specifications are subject to change without prior notice. Misprints reserved.

Please read this manual carefully before installing and using this unit. Be sure to keep it handy for later reference.

TABLE OF CONTENTS

1. Introduction	4
1.1 Features	4
1.2 Delivery scope	4
1.3 Technical data	5
1.4 Front panel operating elements	7
1.5 Connections	10
1.6 Screen displays	12
2. Installation	15
2.1 Delivery scope	15
2.2 Video connection installation, DVR cascading	15
2.3 Audio connection installation	17
2.4 RS-485 keyboard installation	18
2.4.1 General RS-485 bus installation	18
2.4.2 RS-485 connection assignment	20
2.4.3 EKB-500 connection through network patch cable	20
2.4.4 EKB-500 connection to several DVRs	21
2.5 Speed dome installation	22
2.6 Installation alarm inputs / outputs	23
2.7 PS2 mouse installation	24
2.8 Installation EDA800s harddisk expansion unit	24
2.9 Network connection	25
2.9.1 Direct PC connection through crossover cable	25
2.9.2 Network connection through patch cable	25
2.9.3 Network system requirements	25
2.10 Harddisks	26
2.11 Power connection	26
2.12 Start-up	26
3. Setup menu	27
3.1 Time / date	28
3.2 Camera	31
3.3 Recording	34
3.4 Alarm	36
3.5 Motion detection	38
3.6 Video loss	41
3.7 Network	42
3.8 Timer	46
3.9 HDD (harddisk)	47
3.10 RS232/RS485	48
3.11 Warning	49
3.12 System	53

TABLE OF CONTENTS

4. Recording	56
4.1 Normal recording	56
4.2 Timer – scheduled recording	56
4.3 Event recording	57
5. Playback	58
5.1 Playback without search function	58
5.2 Recording search	60
6. Video export	62
7. Call- / matrix monitor setup	64
8. Display settings	65
9. Screen display	66
10. EDA 966 infrared remote control (optional)	67
11. Network access	68
Appendix A: EDR viewer software	73
Appendix B: Interface specification	75
Appendix C: Serial remote control protocol	76
Appendix D: Recording times	81

1. INTRODUCTION

The latest EverFocus digital video recorder generation is based on MPEG-4 compression technology, resulting in enhanced recording capacity and improved network image transmission speed with high image quality.

Comprehensive features and extended event recording settings enable the almost universal application of this DVR series.

1.1 FEATURES

- Duplex operation: simultaneous recording and playback
- MPEG4 compression method with configurable quality
- variable recording rate up to 400/200 images / second (EDR1640/920)
- 4-channel audio recording
- motion detection
- 2 x 3,5" HDD, expandable to max. 50 HDD with EDA800S (optional)
- network interface for image transmission
- RS232 and RS485 interfaces for remote control
- Jog/shuttle for convenient recording evaluation
- 5 additional monitors
- cascading function for keyboard administration of several EDR on one main monitor
- easy-to-use front panel operation
- multilingual on-screen display
- real-time live display
- facile video export function via USB stick or CF card

1.2 DELIVERY SCOPE

1. Ordered type of EDR 920/1640 digital video recorder
2. 2 x harddisk tray with harddisk according to order
3. 2 x installation frames for 19" installation
4. 2 x harddisk tray keys
5. Adaptor board for alarm and control contacts
6. Mains supply
7. 120 Ohm termination with RJ-45 plug for RS-485 bus termination
8. Manual and quick reference guide

1.3 TECHNICAL DATA

Video format	PAL/CCIR	
Video input	EDR920: 9 x 1 Vpp FBAS, BNC, 75 Ohm EDR1640: 16 x 1 Vpp FBAS, BNC, 75 Ohm	
Video output	Main monitor: 1 Vpp FBAS, BNC at 75 Ohm CALL/MATRIX monitor: 5 x 1 Vpp FBAS, BNC at 75 Ohm 9/16 x loop-through outputs 1 Vpp FBAS, BNC at 75 Ohm	
Video compression	MPEG4	
Recording resolution	720x288, 720x576 or 360x288	
Display modes	Main monitor: full screen, PiP, 4,7,9,10*,13*,16* , 2 x zoom, sequence Call/matrix monitor: full screen, sequence (*only EDR1640)	
Alarm inputs	EDR920: 9 x NO/NC, EDR1640: 16 x NO/NC	
Alarm outputs	4 x relay contacts 100 VDC max, 0, 3 ADC max, 5 W max.	
Harddisk	3,5" IDE harddisk	
Recording rate	EDR920	EDR1640
	360x288: 200 images / second	400 images / second
	720x288: 100 images / second	200 images / second
	720x576: 50 images / second	100 images / second
Recording modes	Continuous recording, schedule or event recording	
Playback rate	Real-time playback in full screen, PiP and 4x screen	
Playback search functions	Via time / date or event (alarm / motion)	
Motion detection	Adjustable per channel with 10 sensitivity steps and 20x24 sensor fields each	
Video loss detection	Adjustable per camera	
Event log	10240 entries per harddisk	
Setup	On-screen display	
Operation	Via front panel or optional IR or RS-485 operation	
Real-time clock	Internal with network synchronisation option (NTP server)	
Watchdog function	For processing, ventilation, harddisk, harddisk temperature	

Title generator	Max. 12 characters per camera
Network	RJ45 socket
Image export	USB 2.0 interface
RS-232	9-pin Sub-D socket
RS-485	2 x RJ45
Audio	4 x input 500 mV max /10KOhm, 1 x output 500 mV max at 10KOhm
Power source	100 ~ 240 VAC
Power consumption	185 W max.
Dimensions	430 (W) x 88 (H) x 300 (D) mm
Weight	6,24 KG
Ambient temperature	0°C ~ +40°C
Remote control	optional: IR remote control, RS-485 keyboard

1.4 FRONT PANEL OPERATING ELEMENTS

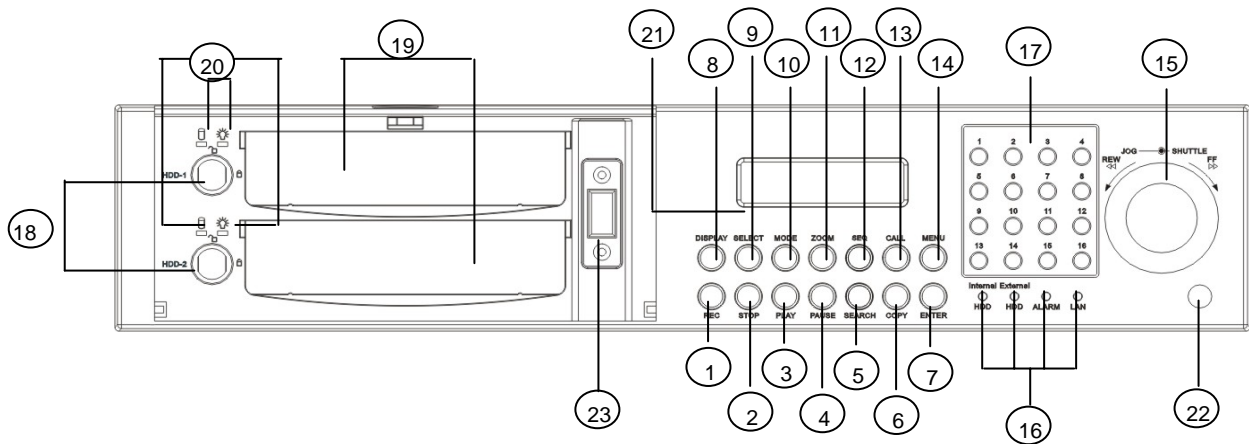

Keys

- ① **REC:** recording key
- ② **STOP:** recording / playback stop
- ③ **PLAY:** playback
- ④ **PAUSE:** image freeze, stops playback for freeze mode
- ⑤ **SEARCH:** opens on-screen display for playback search
- ⑥ **COPY:** opens image export menu. In playback mode, the current playback position is stored as image export start position.
- ⑦ **ENTER:** Enter key for input confirmation
- ⑧ **DISPLAY:** main monitor status display switching:

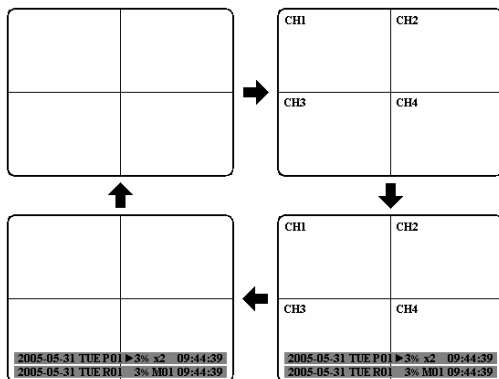

- 9) **SELECT:** In multiscreen mode: selection of the camera to be displayed in a partial screen. **ENTER** switches to the following partial screen.
In full screen mode: brightness, contrast and colour adjustment for this video channel.
- 10) **MODE:** Multiscreen display switching, repeated actuation switches between the individual displays.
- 11) **ZOOM:** In full screen mode: 2x electrical zoom. Zoom screen can be moved through **JOG**. **ENTER** key changes the direction. Further zoom key actuation switches the electrical zoom off.

In multiscreen mode: Image orientation adjustment. Use the **JOG** to adjust the image to the respective monitor type. **ENTER** switches between horizontal and vertical adjustment .

Further **ZOOM** key actuation switches the adjustment off.
- 12) **SEQ:** Sequence operation, automatic image switching
- 13) **CALL:** On-screen display start for call and matrix monitor setup
- 14) **MENU:** Setup menu start

15) **Jog / Shuttle**

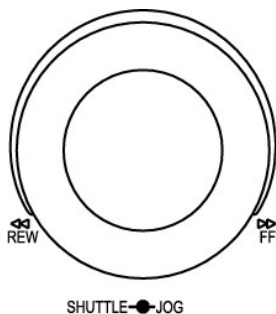

Shuttle (outward): In playback mode, use the **SHUTTLE** for fast forward / reverse playback.

In **PAUSE** mode, turn the shuttle to the right for slow forward playback (1/2 up to 1/8).

In **SEARCH MENU**, use the shuttle to page down the event log list.

JOG: In **PAUSE** mode, use the jog to switch freeze images forwards / backwards.

Within menu functions, use the jog to adjust the values / parameters.

- 16) **System LEDs:** Status LEDs for LAN activity, alarm, internal / external HDD access
- 17) **Channel keys:** Video channel key to select a single camera for full screen display
- 18) **HDD lock:** HDD lock and switch
- 19) **Harddisk tray:** Trays for 3,5" HDD

-
-
- ⑳ **HDD LEDs:** LEDs for HDD power (green) and HDD activity (red)
 - ㉑ **LCD display:** Status, time/date display
 - ㉒ **IR receiver:** Receiver for infrared remote control
 - ㉓ **USB socket:** USB-2.0 port for image export via USB stick resp. external DVD-R EPR200

1.5 CONNECTIONS

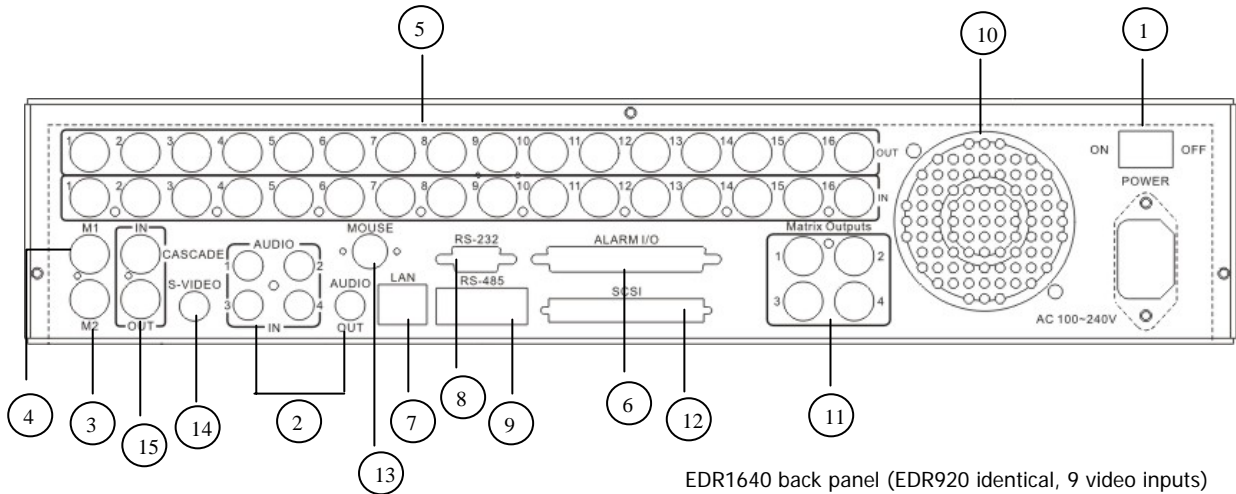

EDR1640 back panel (EDR920 identical, 9 video inputs)

- ① **Main switch:** Power switch, below IEC socket for 100~240 VAC power source
- ② **Audio inputs:** Audio inputs 1 ~ 4
Audio output: Audio output
- ③ **MAIN monitor:** Main monitor for live and playback display and on-screen display
- ④ **CALL monitor:** CALL monitor output. Spotmonitor for full screen live display, sequence mode and alarm camera switching
- ⑤ **Video inputs:**
EDR920:
VIDEO IN(1~9): BNC video inputs for 1 Vpp Composite video signals, automatic 75 Ohm termination (high impedance switching upon loop-through output load)
EDR1640:
VIDEO IN (1~16): BNC video inputs for 1 Vpp Composite video signals, automatic 75 Ohm termination (high impedance switching upon loop-through output load)
- ⑥ **Alarm and control inputs / outputs (for connection assignment, refer to appendix C)**
ALM-INPUT: 9 (EDR920) resp. 16 (EDR1640) alarm inputs for dry contacts, programmable NO or NC in the menu.
ALM-OUTPUT: 4 x NO/NC alarm output relay
REC-IN: Input contact for recording start, NO, for dry contacts

-
-
- ⑦ **LAN:** RJ45 network socket
 - ⑧ **RS232 socket:** 9-pin Sub-D control input for RS-232 remote control
 - ⑨ **RS485 socket:** 2 x RJ45 socket (equal) for remote control via RS-485 keyboards and telemetry control (network-controlled)
 - ⑩ **Fan:** Fan air outlet, please do not cover
 - ⑪ **Matrix monitors 1~4:** Matrix monitor outputs 1~4
 - ⑫ **SCSI-socket:** EDA800s HDD expansion unit connection
 - ⑬ **Mouse:** PS-2 mouse connection (optional)
 - ⑭ **S-Video:** Main monitor Y/C output
 - ⑮ **Cascade IN / OUT:** Monitor input / output for EDR cascading. This function allows one monitor to be used for MAIN monitor display of several DVRs. Function is only available upon DVR control through RS-485 keyboards.

1.6 SCREEN DISPLAYS

Here's an overview of the screen displays appearing on the MAIN monitor:

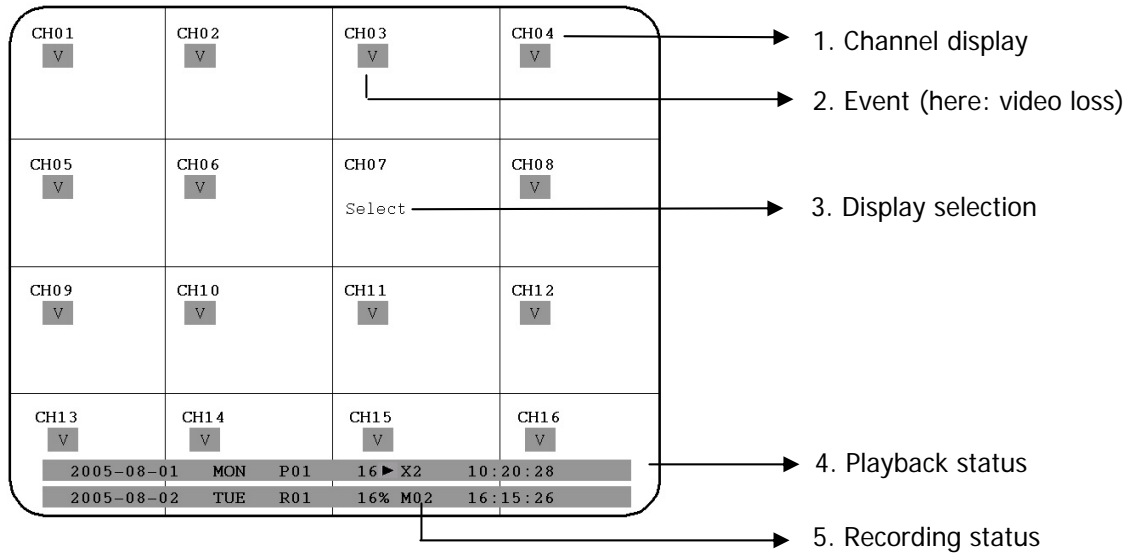

① **Channel display:** shows the selected video channel's description

② **Event:** Event display, may be channel-related or global
Channel-related types of event:

A **Alarm:** Display of an alarm triggered by alarm input contact

M **Motion:** Motion detection of the respective camera

V **Video loss:** Video signal loss of the respective camera

S **Sequence:** Sequential operation of the respective video channel

* - In multiscreen display, this icon indicates the channel selected for sequential display. Selection via SELECT key. Upon sequence activation, the "*" icon is replaced by **S**

Global types of event:

OT

OT - Over Temperature HDD: Alarm message upon HDD over temperature, displayed in red on all video channels. The device should immediately be switched off. In case the „FAN“ (fan damage) message occurred previously, contact the technical service for trouble shooting. If the fan works properly, check the device's position as regard to ambient temperature (max. 40°C, fan must not be covered, ensure the sufficient ventilation if device is installed in cabinet or rack).

- 3 **SELECT:** Within a multiscreen view, the SELECT key activates the camera selection mode. The active camera field shows "S".
Use the JOG to switch between the camera fields. Use the channel keys 1~9 or 1~16 to switch the channel..

- 4 **PLAYBACK STATUS:** The playback-relevant information are displayed in this status bar.

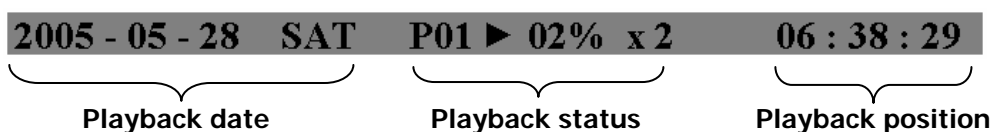

1. **Playback date :** Current playback date

2. **Playback status:** Playback operation mode

"PAUSE": Freeze image mode

">": normal playback speed

"<": reverse playback, normal speed

">> x N" : forward playback, Nx speed

"<< x N": reverse playback, Nx speed

"XX%": playback position in XX percent of total HDD capacity

3. **Playback position:** current playback position, display format depends on time/date menu settings

- 5 **RECORDING STATUS:** The recording-relevant information are displayed in this status bar.

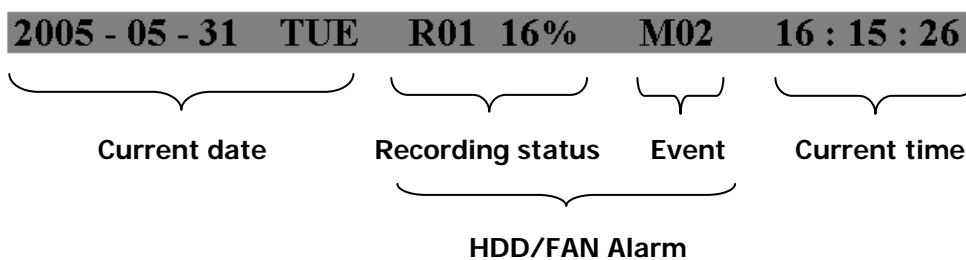

-
-
1. **Current date:** as set in time/date menu
 2. **Recording status:** In case of activated recording, "R" + current HDD no. is displayed
 "R01": R - RECORD, figure shows the currently recording HDD no., here: No. 1
 3. **Event:** current event display
 4. **Current time:** as set in time/date menu
 5. **HDD fan message:**
 - "No Disk":** no HDD available or detected
 - "No Fan":** fan malfunction
 - "HDD OT":** HDD over temperature

2. INSTALLATION

ATTENTION: The installation should be effected by qualified personnel only. Connect power source only after having finished the further installation.

2.1 Delivery scope

Check the delivery scope (see 4.) before starting the installation.

2.2 Video connection installation, DVR cascading

Sample installation with maximum camera and monitor configuration:

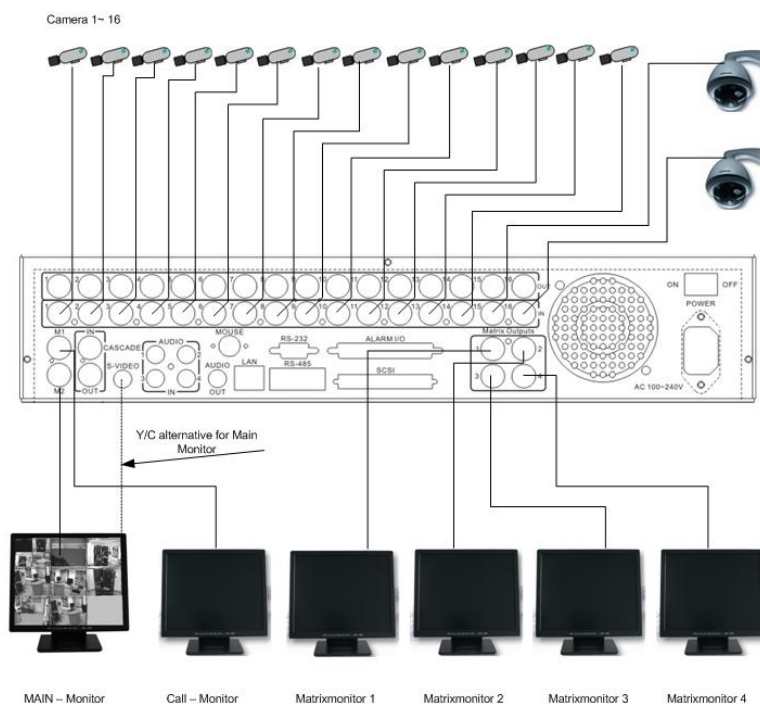

Cameras and monitors have to be cabled with 75 Ohm video cable, e.g. RG-59, RG-12 and suitable BNC plugs.

Due to inappropriate absorbability, 50 Ohm coax cable (e.g. RG58), antenna cable and further types of coax cable are not suitable.

All connected video sources must provide a 1 Vpp PAL/CCIR standard video signal.

When interconnecting transmission lines (twisted pair, fibre optics, radio) to the video inputs, ensure the accurate receiver calibration.

The MAIN monitor may optionally be connected through a Y-C (S-Video) cable to achieve an improved image quality.

For local DVR operation, MAIN monitor connection is compulsory. Call and matrix monitors can be connected optionally.

ATTENTION: Make sure that there's a video signal on video input 1 upon start-up, as this input is required for video system auto detection (PAL/NTSC)!

DVR cascading

The digital video recorders provide "CASCADE IN" and "CASCADE OUT" video connections.

In combination with RS-485 remote control, up to 8 EDR920/1640 can be cascaded and administrated via one single main monitor. Cascading is effected by connecting the DVRs „CASCADE OUT“ to the „CASCADE IN“ of the following DVR, while the last „CASCADE OUT“ is connected to the monitor input.

By means of the RS-485 address sent from the keyboard, the respective DVR is switched on the monitor.

This function is available for main monitor only.

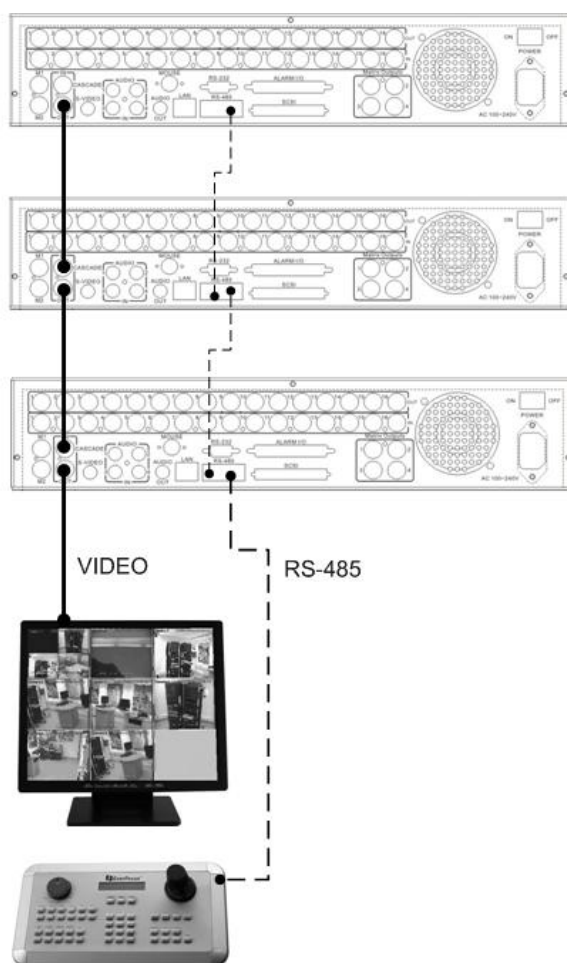

Installation with 3 cascaded EDR and EKB-500

2.3 Audio connection installation

Sample installation with audio connection to video cameras providing audio output:

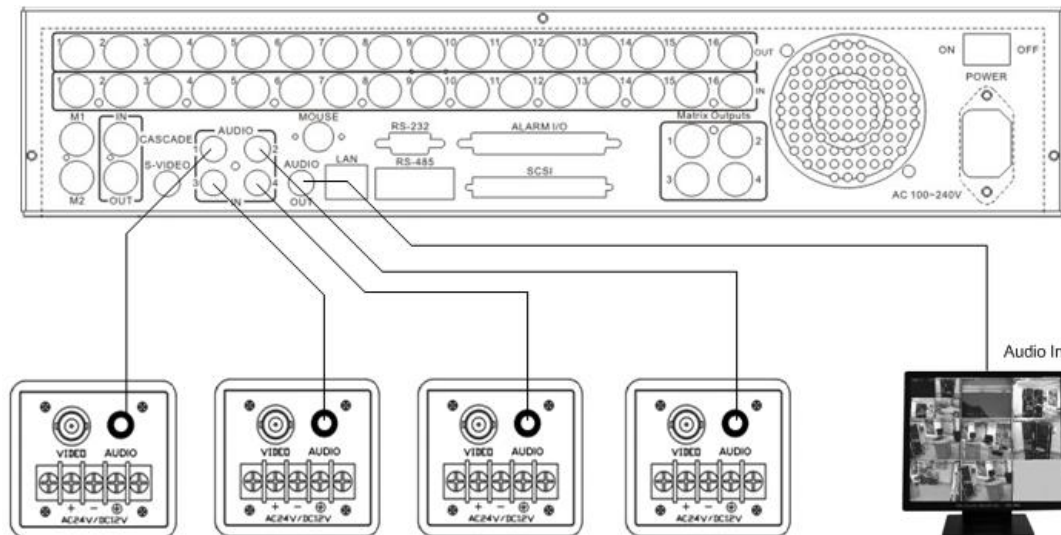

The EDR920/1640 DVRs provide 4 audio inputs and 1 audio output.

The inputs are designed for max. 500 mV to 10 KOhm line audio signals.

ATTENTION: The direct connection of a non-amplified microphone is not supported (a microphone amplifier is required).

The installation has to be effected with audio coax cable and RCA plugs.

The output provides a max. 500 mV to 10 KOhm line audio signal and may be connected to e.g. a monitor's audio input. The direct connection of (passive) speakers is not supported.

AUDIO RECORDING FUNCTIONALITY:

Audio recording is activated / deactivated in the RECORDING menu for all channels.

Audio of all channels is always recorded together with (each) video and is independent of the image recording rate. There is no specific camera allocation.

During playback, use the JOG to select the requested playback channel 1~4 (active channel is indicated in playback on-screen display).

2.4 RS-485 keyboard installation

All EDR920/1640 functions can be remote-controlled by the EKB 500 universal keyboard. Using the EEPbus protocol, digital video recorders, keyboards and speed domes can be installed on one single RS-485 bus. One system can comprise up to 8 keyboards.

2.4.1 General RS-485 bus installation

EKB-500 uses an RS-485 simplex wiring; the signal is transferred via a single twisted pair line. CAT5 network cable is recommended, UPT version (unshielded) is sufficient for normal application. A shielded cable should be used if the installed cables are expected to be highly susceptible to interferences.

The number of devices installed in one bus is limited to 32 (expandable through signal distributors).

Basically, the bus should be created by serial wiring, star wiring is only permitted using signal distributors.

Maximum RS-485 bus cable length is 1200 m. Both the first and the last device are normally 120 Ohm terminated in order to minimize line reflexions.

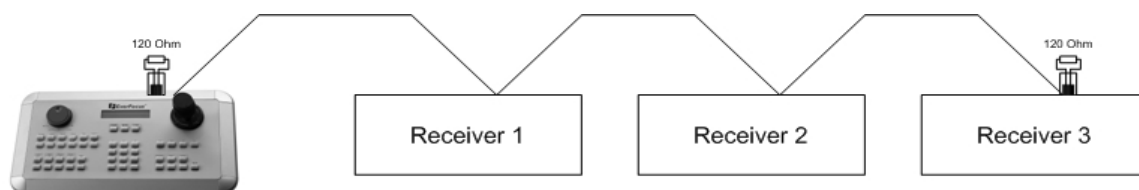

RS-485 bus serial wiring

Cable length from box to device („Stubs“) has to be limited to 2m using connector boxes.

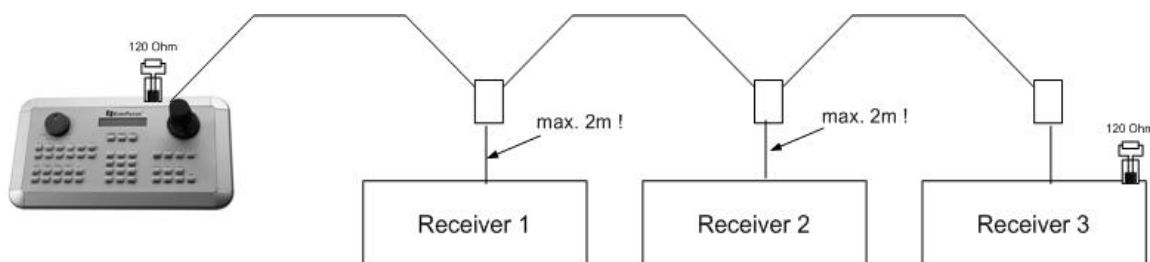

RS-485 bus serial wiring with connector boxes and connection cable

A direct RS-485 bus star wiring is not supported; star wiring requires the use of signal distributors.

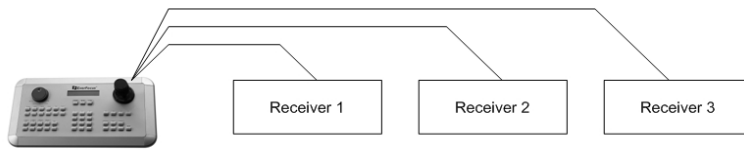

Improper RS-485 bus star wiring

If star wiring is inevitable, EDA 997A RS-485 signal distributors may be used. The maximum system cable length can also be expanded by using these distributors, physically providing a new RS-485 bus with 1200 m cable length each at every distributor output.

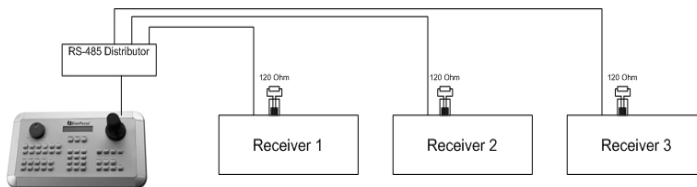

Star wiring with RS-485 signal distributor

In case the maximum number of 32 bus participants is exceeded, the number of connected devices can be increased by using RS-485 distributors. Each distributor output physically provides one RS-485 bus which enables the additional connection of 31 further devices (the distributor output represents one bus participant itself). The maximum system expandability depends on the RS-485 address range of the installed devices.

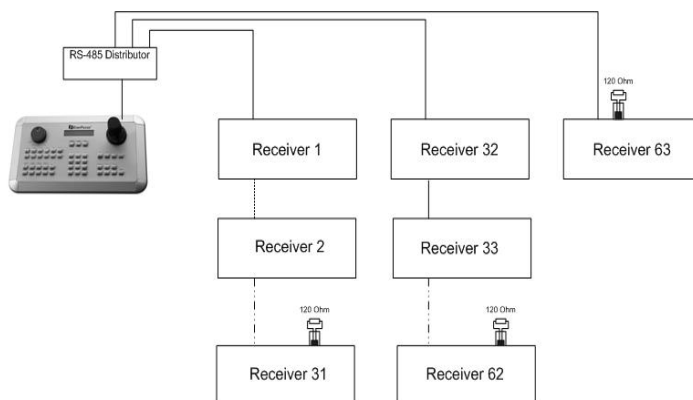

System expansion with RS-485 signal distributor

ATTENTION: The RS-485 signal distributor EDA997A is unidirectional! This means that the signal only flows from the input towards the outputs. Therefore, e.g. the interconnection of several keyboards is not possible with this signal distributor!

2.4.2 RS-485 plug connection assignment

The two RS-485 input RJ-45 plugs are looped through and pin-compatible. The following RJ-45 plug assignment has to be considered for connection:

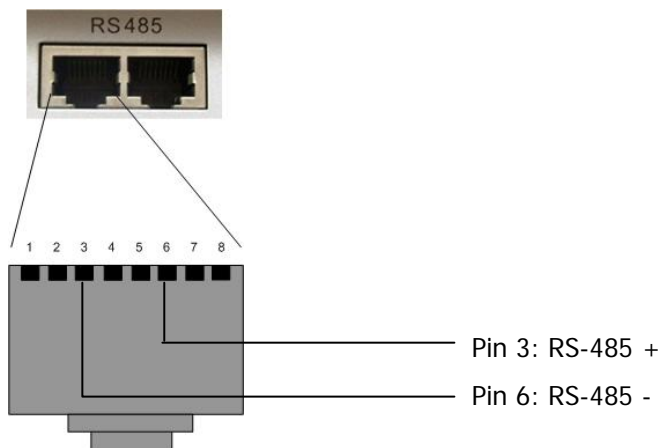

The following illustration shows the connector box assignment of the optional EDA998 connection kit (connector box, patch cable):

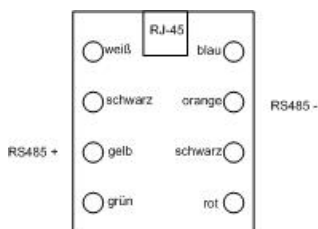

2.4.3 EKB-500 connection with network patch cable

For a simple, short distance installation, recorder and keyboard can directly be connected using a standard network cable (patch cable, uncrossed!).

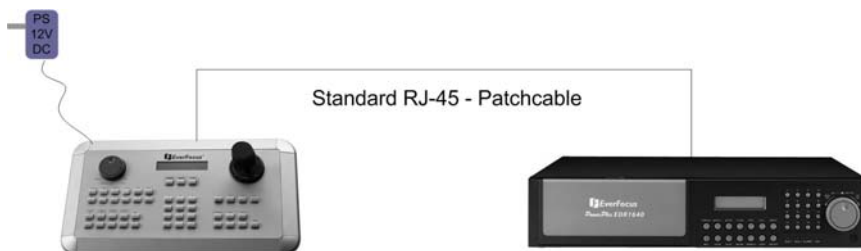

2.4.4 EKB-500 connection to several DVRs

For long distance installations connecting several DVRs, the use of the optional EDA998 connection kit is recommended:

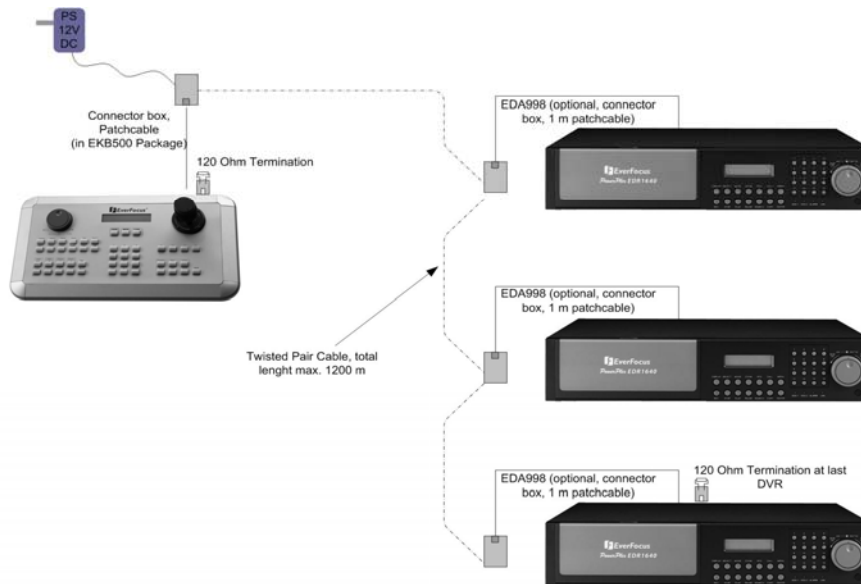

EKB 500 installation with several DVRs and EDA998 connection kit

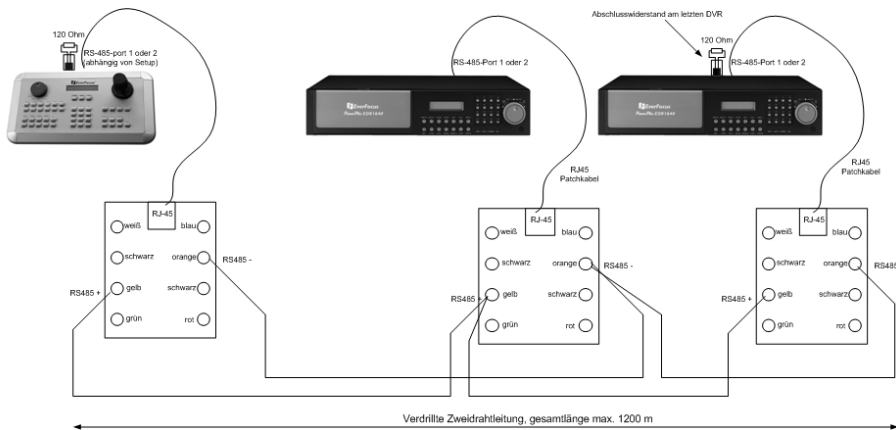

For further details on keyboard connection, please refer to the EKB 500 manual. RS-485 port communication settings are configured in the **RS-232/485** menu.

2.5 Speed dome installation

Speed dome or telemetry receiver pan/tilt/zoom control is available through web browser or the optional PowerCon software if the DVR is connected to a network. Local telemetry control is provided by the optional EKB 500 keyboard.

ATTENTION: The basic RS-485 wiring rules described in chapter 2.3.1. also apply to the connection of speed domes or telemetry receivers.

Supported protocols: EverFocus, ED2200/2250, Pelco-D, Pelco-P

The optional RS-485 connection kit is recommended for easy installation.

For RS-485 port pin assignment, please refer to chapter 2.3.2.

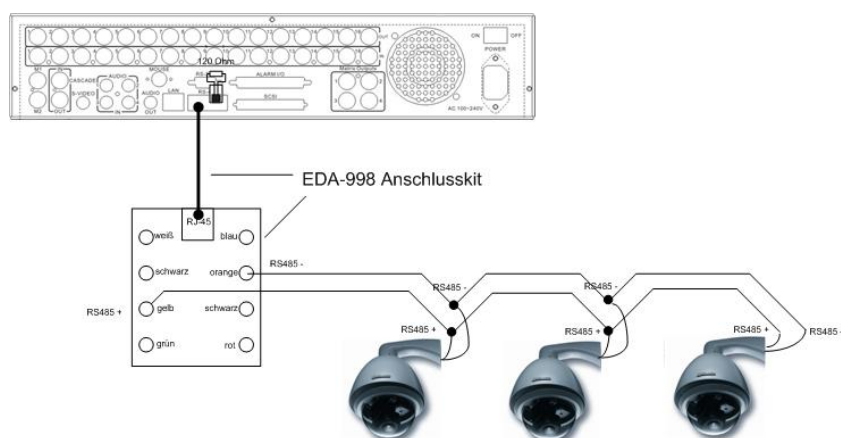

Sample installation with 3 EPTZ1000 speed domes and EDA998

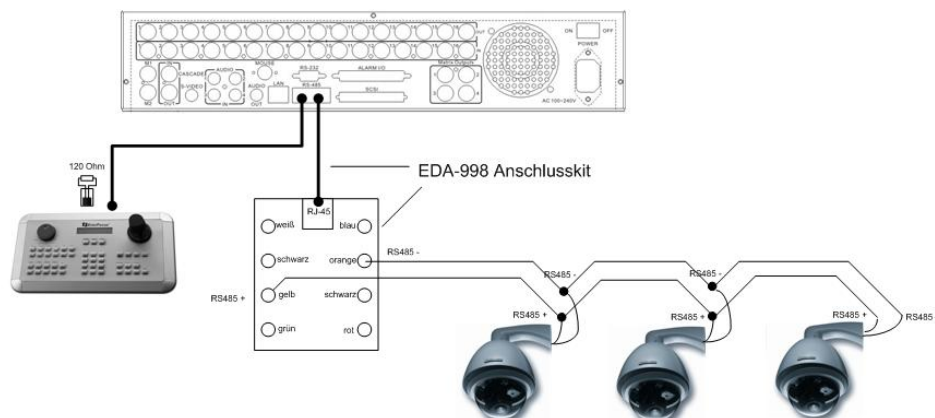

Sample installation with 3 EPTZ1000 speed dome, EDA998 and local EKB 500 operation

Required DVR settings: RS-485 receiver address in **CAMERA** menu

RS-485 parameters and protocol in **RS232/485** menu

ATTENTION: Some Pelco-D / -P protocol domes and receivers require an address offset of -1, i.e. the address assigned to the dome / receiver in the DVR camera menu must be 1 below the address set in the dome / receiver itself!

2.6 Alarm input / output installation

The EDR920/1640 alarm inputs can be used for recording start or recording rate adjustment. Furthermore, alarm reactions such as camera switching to monitors, buzzer, e-mail and network alarm are available. An alarm output relay can be switched if required.

EDR920 provides 9 alarm inputs, EDR1640 provides 16. All inputs are programmable NO/NC.

Inputs have to be switched through dry contacts.

The 4 output relays provide a dry NO/NC contact.

All settings are programmed in the **ALARM** menu.

Use either the 37-pin Sub-D plug or the included adaptor board for connection.

Pin assignment Sub-D plug

DVR			
PIN #	NAME	PIN #	NAME
1	GND	19	GND
2	ALM 1	20	ALMNC0
3	ALM 2	21	ALMNO0
4	ALM 3	22	ALMCOM0
5	ALM 4	23	ALMNC1
6	ALM 5	24	ALMNO1
7	ALM 6	25	ALMCOM1
8	ALM 7	26	ALMNC2
9	ALM 8	27	ALMNO2
10	ALM 9	28	ALMCOM2
11	ALM 10	29	ALMNC3
12	ALM 11	30	ALMNO3
13	ALM 12	31	ALMCOM3
14	ALM 13	32	ALMRSTO
15	ALM 14	33	REC
16	ALM 15	34	GINIO
17	ALM 16	35	DISKFULL
18	GND	36	GO1

Pin assignment adaptor board

HOST			
PIN #	NAME	PIN #	NAME
1	GND	21	GND
2	ALMIN 1	22	ALM_NC1
3	ALMIN 2	23	ALM_NO1
4	ALMIN 3	24	ALM_COM1
5	ALMIN 4	25	ALM_NC2
6	ALMIN 5	26	ALM_NO2
7	GND	27	ALM_COM2
8	ALMIN 6	28	GND
9	ALMIN 7	29	ALM_NC3
10	ALMIN 8	30	ALM_NO3
11	ALMIN 9	31	ALM_COM3
12	ALMIN 10	32	ALM_NC4
13	GND	33	ALM_NO4
14	ALMIN 11	34	ALM_COM4
15	ALMIN 12	35	GND
16	ALMIN 13	36	ALMRST
17	ALMIN 14	37	REC_IN
18	ALMIN 15	38	SPARE_IN
19	ALMIN 16	39	DISK_FULL
20	GND	40	SPARE_OUT

Descriptions:

ALMINxx: Alarm input xx (1~16)

GND: common ground for alarm inputs

ALM_COMx: output relay x , contact root

ALM_NOx: output relay x , NO contact

ALM_NCx: output relay x , NC contact

ALMRST: Alarm reset, control input for alarm reset, for dry NO contact towards GND

DISKFULL: OC output contact for signal „HDD full“, switches to GND

REC_IN: Control contact for recording start

SPARE_IN / OUT: reserved

NO contact alarm input connection:

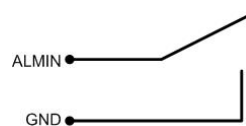

NC contact alarm input connection:

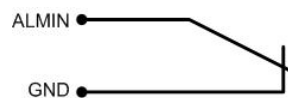

Output relay in idle state:

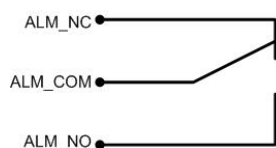

2.7 PS/2 mouse installation

EDR920/1640 may optionally be controlled through PS/2 wheelmouse which must be connected before system start-up.

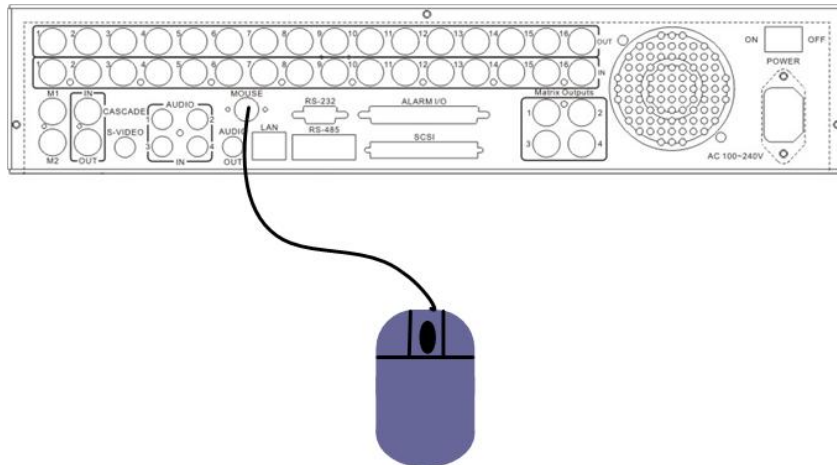

2.8 Installation EDA800s harddisk expansion unit

The EDR920/1640 image storage capacity can be expanded using EDA800s harddisk expansion units. Max. 6 EDA800s with 8 harddisks each can be connected via SCSI bus.

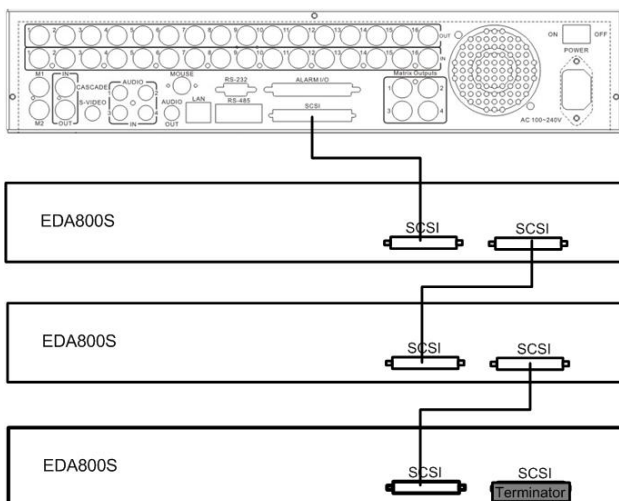

For installation details of the EDA-800S harddisk expansion unit, please refer to the EDA800s manual.

2.9 Network connection

EDR920/1640 DVRs provide fast MPEG-4 format image transmission and network remote configuration.

This chapter doesn't go into basic network technique details. For further information, especially about router installation and internet connection, please refer to the publication "EverFocus network technique".

Physically, two basic types of connection are possible:

2.9.1. Direct PC connection through crossover network cable

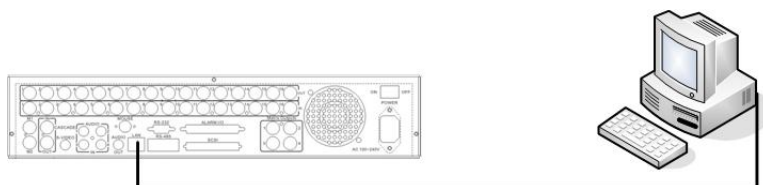

The point-to-point connection of DVR and PC requires a crossover (crossed) network cable. This type of connection does not allow the connection of several PCs or DVRs. Make sure that the PC is equipped with a 100 MBit compatible network connection.

2.9.2. Network connection through patch cable

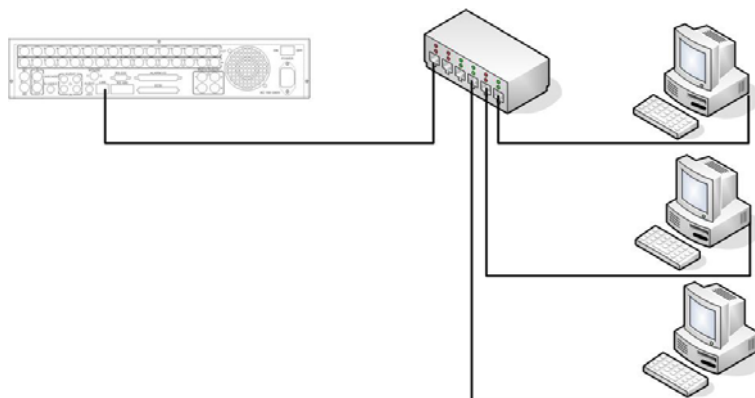

The connection to an existing network requires a normal patch cable (wired 1:1). The illustration shows the connection to a network switch.

2.9.3. Network system requirements

Connection type: 100Base-T

Max. required network bandwidth: 10 MBit

Protocol types: TCP, UDP, SMTP, HTTP, NTP

Required ports: for port configuration, please refer to **NETWORK** menu

2.10 Harddisks

Insert the pre-assembled harddisks incl. frames into the HDD tray. Both harddisks must be jumpered as „CS – Cable Select“.

Make sure that both harddisks have reached the stop position and use the key switch to lock the harddisk tray.

ATTENTION: Use only harddisks approved for the use with EDR920/1640 DVRs.

ATTENTION: Harddisk shutdown and removal during recording and playback operation and upon DVR system start is inadmissible!

ATTENTION: Upon harddisk shutdown through key switch, the harddisk is signed off from the system. Do not remove the harddisk until the green power source LED at the harddisk tray is extinguished.

2.11 Power connection

Connect the DVR to the power source (100~240 VAC 50/50 Hz) using the included IEC cable. To ensure the secure DVR operation, the use of an uninterruptible power supply (UPS) in online version with sufficient operating time is recommended.

2.12 Start-up

After having finished the installation work, switch on the power using the main power switch. Depending on harddisk type and fill level, the start-up sequence might take up to 2 minutes. The next step is the system menu setup.

3. SETUP MENU

All EDR DVR settings are carried out in the on-screen display.



The **MENU** key starts the main menu.
Press the **MENU** key again to leave the menu or to change from sub menu to a higher menu level.

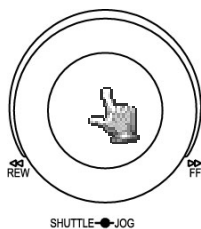

Use the **JOG** to select a menu item.

Use the **ENTER** key to confirm a selection and to proceed to the next entry in sub menus.

Use the **DISPLAY** key to return to the previous entry in sub menus.

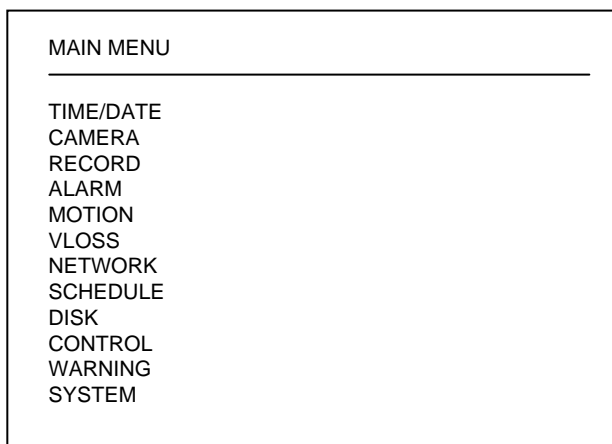

3.1 TIME / DATE MENU

TIME/DATE	
TIME FORMAT	24 HOUR
TIME	12:22:34
DATE FORMAT	DD-MM-YYYY
DATE	12-11-2005
DAYLIGHT SAVING	ON
START ON	MAR LAST SU
FROM	02:00 TO 03:00
END ON	OCT LAST SU
FROM	03:00 TO 02:00
TIME SYNCHRONIZE	ON
TIME SERVER	64.109.43.141
TIME ZONE	GMT+1
TIME UPDATE BY	DAY

Define the following settings in the TIME / DATE menu:

(1) TIME FORMAT: Select either 12-hour or 24-hour format for time display

(2) TIME: Current time
Hour: 00 ~ 23 (1 ~ 12 for 12-hour format)
Minute : 00 ~ 59
Second: 00 ~ 59

(3) DATE FORMAT: Select the date display format: **YYYY-MM-DD**, **MM-DD-YYYY** or **DD-MM-YYYY**

(4) DATE: Current date
Day: 01~31
Month:01~12
Year: 2000 ~ 2099
Weekday (autom.): MO ~ SU

(5) DAYLIGHT SAVING TIME ADJUSTMENT: Activate the daylight saving time switching by selecting "ON".

If daylight saving time adjustment is activated, the next step is the definition of switching terms.

(6) START DATE: Start daylight saving time

Select month: Use the JOG to adjust the month:

JAN	FEB	MAR	APR	MAY	JUN
JUL	AUG	SEP	OCT	NOV	DEC

Select week: Use the JOG to adjust the week of the selected month:

1 .	2 .	3 .	4 .	LAST
-----	-----	-----	-----	------

Select day: Use the JOG to adjust the weekday:

SU	MO	TU	WE	TH	FR	SA
----	----	----	----	----	----	----

Adjust switching time: Select the switching time (FROM) and the new time (TO).

(7) END DATE: End of daylight saving time

Select month: Use the JOG to adjust the month:

JAN	FEB	MAR	APR	MAY	JUN
JUL	AUG	SEP	OCT	NOV	DEC

Select week: Use the JOG to adjust the week of the selected month:

1 .	2 .	3 .	4 .	LAST
-----	-----	-----	-----	------

Select day: Use the JOG to adjust the weekday:

SU	MO	TU	WE	TH	FR	SA
----	----	----	----	----	----	----

Adjust switching time: Select the switching time (FROM) and the new time (TO).

Central Europe daylight saving time adjustment:

- Last Sunday of March: Adjustment from 02:00 a.m. to 03:00 a.m.
- Last Sunday of October: Adjustment from 03:00 a.m. to 02:00 a.m.

(8) TIME SYNCHRONISATION:

The DVR offers time synchronisation via NTP server.

ATTENTION: The synchronisation should be activated by selecting "ON" only after defining the daylight saving time, time zone and NTP server IP address.

(9) TIME SERVER:

The NTP server time synchronisation requires a TCP/IP connection to this server. For information about the required settings, please refer to "NETWORK" menu.

NTP server identification:

Time servers available on the internet can be identified as follows:

1. Connect your PC to the internet.
2. Open the "DOS prompt" (directory ACCESSORIES or path START>RUN>command)
3. Enter the command:" ping pool.ntp.org " (see screenshot)
4. If the connection is successful, the server IP address is displayed.

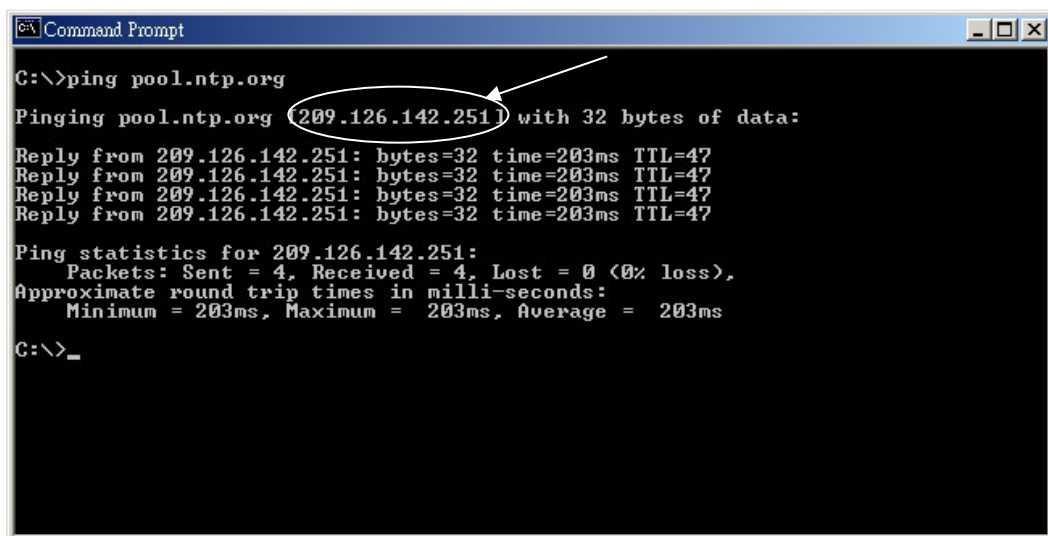

```
C:\>ping pool.ntp.org
Pinging pool.ntp.org (209.126.142.251) with 32 bytes of data:
Reply from 209.126.142.251: bytes=32 time=203ms TTL=47
Reply from 209.126.142.251: bytes=32 time=203ms TTL=47
Reply from 209.126.142.251: bytes=32 time=203ms TTL=47
Reply from 209.126.142.251: bytes=32 time=203ms TTL=47

Ping statistics for 209.126.142.251:
    Packets: Sent = 4, Received = 4, Lost = 0 (0% loss),
    Approximate round trip times in milli-seconds:
        Minimum = 203ms, Maximum = 203ms, Average = 203ms

C:\>_
```

(10) TIME ZONE:

Enter your local time zone (Germany, Austria, Switzerland: GMT+1).

ATTENTION: The correct entry is compulsory for NTP synchronisation.

(11) UPDATE INTERVAL: Time synchronisation interval

DAY

WEEK

MONTH

3.2 CAMERA MENU

CAMERA				
CAMERA1	TITLE		CH1	
CAMERA2	PTZ ID		01	
CAMERA3	INSTALL/COVERT		ON/OFF	
CAMERA4	SEQ (MAIN/CALL)		03/03 SECS	
CAMERA5	REC QUALITY		HIGH	
CAMERA6	REC SPEED ON TIME ZONE			
CAMERA7	TP	NORMAL	EVENT	SET
CAMERA8	1	5 IPS	25 IPS	OFF
CAMERA9	2	5 IPS	25 IPS	OFF
	3	5 IPS	25 IPS	OFF
SUMMARY	4	5 IPS	25 IPS	OFF
	5	5 IPS	25 IPS	OFF
	6	5 IPS	25 IPS	OFF
	7	5 IPS	25 IPS	OFF
	8	5 IPS	25 IPS	OFF
	N	5 IPS	25 IPS	OFF

Menu display for EDR-920, EDR1640 identical, but with 16 cameras.

The most important recording operation settings are defined in the CAMERA menu.

Before changing the settings in this menu, recording has to be stopped.

Each camera is set individually:

(1) NAME: Enter the video channel description with max. 12 characters each.

Available characters are (select with JOG):

0,1,2,3,4,5,6,7,8,9,

A,B,C,D,E,F,G,H,I,J,K,L,M,N,O,P,Q,R,S,T,U,V,W,X,Y,Z,

() . , + - / and space

(2) PTZ ID: Enter the RS-485 receiver address of a speed dome or telemetry receiver camera connected to this video channel.

(3) INSTALL / COVERT:

INSTALL (first position) All connected cameras have to be set to **ON**, all not connected cameras are set to **OFF**.

ATTENTION: The manual setting is compulsory, autodetection for connected cameras is not available!

COVERT (second position): A camera programmed COVERT "ON" will not be displayed, but recorded at defined parameters.

(4) SEQ(MAIN/CALL): Camera dwell time in sequence operation (automatic switching) for main (first position) and call (second position) monitor

ATTENTION: Some Pelco-D / -P protocol domes and receivers require an address offset of -1, i.e. the address assigned to the dome / receiver in the DVR camera menu must be 1 below the address set in the dome / receiver itself!

(5) REC QUALITY: Individual recording quality setting for this camera (within the resolution defined in RECORDING menu):

SUPERIOR
HIGH
STANDARD
BASIC
LOW
LOWER

Using the VBR (Variable Bit Rate) method, the storage requirement per image depends on the image's colour and contrast content and captured motion.
For recording time sample tables, please refer to **Appendix D**.

(6) REC SPEED ON TIME ZONE:

The EDR DVR offers 8 different timers for scheduled recording. The settings of the last row "N" (normal) apply to those periods not captured by a timer schedule (setup in TIMER menu)

For recording rate, the following steps are available: 1;2;3;4;5;6;8;10;12,5;25 images/s.

In case no timer is activated, the DVR only operates according to the settings of row "N".

TP: Timer program 1–8, schedule setup and activation are defined in the TIMER menu.

N: (Normal) all periods not captured by a timer schedule.

In case no timer is activated, the DVR only operates according to these settings.

NORMAL: IPS recording rate for manual or scheduled recording and recording controlled through "REC IN" input contact. The maximum image rate is limited to:

Max. image rate per camera = max. DVR recording rate / number of installed cameras.

Max. DVR recording rate depends on recording resolution:

EDR920: 360x288: 200 image / second

720x288: 100 images / second

720x576: 50 images / second

EDR1640: 360x288: 400 images / second

720x288: 200 images / second

720x576: 100 images / second

Example: EDR1640 with 12 installed cameras, resolution 720x288:

200 IPS : 12 = 16,6 IPS > maximum adjustable recording rate per camera: 12,5 IPS

EVENT: IPS recording rate for event recordings (alarm contacts, motion detection), maximum adjustable recording rate is 25 IPS.

ACT (active): Indication of whether the individual timer is activated. Settings are carried out in TIMER menu. ON: timer activated; OFF: timer deactivated

(7) SUMMARY:

CAMERA		
CAMERA	ITEM	TITLE
CAMERA1		
CAMERA2	1	CH1_____
CAMERA3	2	CH2_____
CAMERA4	3	CH3_____
CAMERA5	4	CH4_____
CAMERA6	5	CH4_____
CAMERA7	6	CH4_____
CAMERA8	7	CH4_____
CAMERA9	8	CH4_____
SUMMARY	9	CH4_____

Menu display for EDR-920, EDR1640 identical, but with 16 cameras

The SUMMARY menu item gives a summary on the settings for control purpose.

Use the JOG to browse the individual settings.

ATTENTION: This menu does not allow any editing of settings.

(8) COPY function

Besides camera title, PTZ ID and INSTALLED/COVERT, the settings can be copied from one camera to another.

Select the camera to be copied from the camera list on the left and press the COPY key. The message "COPIED" appears at the top screen margin.

Select the camera which shall apply the settings from the camera list.

Press the SEARCH key to assign the copied settings to the camera.

The message "PASTED" appears at the top screen margin.

3.3 RECORDING MENU

RECORDING	
RECORD AUDIO	YES
TIME STAMP	OFF
TIME STAMP POS.	BOTTOM
WATERMARK	OFF
WATERMARK POS.	TOP
RESOLUTION	720X288
RECORD MODE	REWRITE

Define the following settings in the recording menu:

(1) RECORD AUDIO:

YES: Audio is recorded together with video. Audio recording is effected independent of image recording rate.

NO: Audio recording is deactivated.

(2) TIME STAMP:

ON: Recording is overlaid by time and date.

OFF: Recording doesn't provide time/date stamp.

(3) TIME STAMP POS.:

TOP: Time / date is displayed at the top screen margin.

BOTTOM: Time / date is displayed at the bottom screen margin.

(4) WATERMARK :

ON: Recording is overlaid by a visible watermark ("W").

OFF: No watermark.

(5) RESOLUTION:

DVR PAL recording resolution is adjustable as follows:

	720x288 (Half D1),	Default setting,	total recording rate 100 IPS for EDR920
			total recording rate 200 IPS for EDR1640
	720x576 (D1) ,		total recording rate 50 IPS for EDR920
			total recording rate 100 IPS for EDR1640
or	360x288 (CIF) ,		total recording rate 200 IPS for EDR920
			total recording rate 400 IPS for EDR1640

(6) RECORD MODE:

REWRITE: If the harddisk is full, the DVR starts to overwrite the harddisk, previous recordings are deleted automatically.

STOP: If the harddisk is full, the DVR stops recording (for signalling, refer to WARNING menu).

3.4 ALARM MENU

ALARM		
ALARM 1	ALARM	ENABLE
ALARM 2	ALARM TYPE	N.O.
ALARM 3		
ALARM 4	ACTIVE CAMERA	01
ALARM 5	DURATION	05 SEC
ALARM 6	ALARM OUTPUT	NONE
ALARM 7	ALARM EMAIL	NO
ALARM 8	BUZZER	OFF
ALARM 9	ALARM NETWORK	NO
SUMMARY		
	MAIN MON	NO CHANGE
	CALL MON	NO CHANGE
	MATRIX 1	NO CHANGE
	MATRIX 2	NO CHANGE
	MATRIX 3	NO CHANGE
	MATRIX 4	NO CHANGE

Menu display for EDR-920, EDR1640 identical, but with 16 alarm inputs.

Define the dry alarm contacts' attributes and the alarm reactions in the ALARM menu.

For alarm contact pin assignment, please refer to appendix D.

Each contact is adjusted individually and selected from the list on the left:

(1) ALARM:

ENABLE: Contact is activated.

DISABLE: Contact is deactivated.

(2) ALARM TYPE:

N.O. : Normally open, contact reacts on being connected to ground (GND). Define the alarm duration within menu item DURATION.

N.C.: Normally closed, contact reacts on being disconnected from ground (GND). Define the alarm duration within menu item DURATION.

N.O. + Trans.: Transparent mode, similar to normally open but: alarm is active as long as input contact (but minimal as defined in DURATION)

N.C. + Trans.: Transparent mode, similar to normally closed but: alarm is active as long as input contact (but minimal as defined in DURATION)

(3) ACTIVE CAMERA:

Alarm camera being recorded and displayed in full screen on the main monitor (see (10) MAIN MONITOR). Recording is carried out according to the settings defined for EVENT within the **CAMERA** menu.

COPY function

Alarm settings can be copied from one contact to another. Select the contact to be copied from the contact list on the left and press the **COPY** key. The message "COPIED" appears at the top screen margin. Select the contact which shall apply the settings from the contact list. Press the **SEARCH** key to assign the copied settings to the contact. The message "PASTED" appears at the top screen margin

(4) **DURATION:** Alarm duration for N.O. and N.C. contact types. Duration applies to recording, screen change, buzzer and output contact and is adjustable from 1~99 seconds.

(5) **ALARM OUTPUT:** Output relay activation.

1: Output relay 1~4 (selection) is switched in case of alarm

NONE: Output relay is deactivated.

(6) **ALARM EMAIL:** By selecting "ON", an email is sent in case of alarm, containing the alarm message, the camera's alarm image and the DVR IP address as sender.

Define the email recipient's details in the NETWORK menu.

(7) **BUZZER:** Alarm buzzer activation

ENABLE: Alarm buzzer is activated.

DISABLE: Alarm buzzer is deactivated.

(8) **ALARM NETWORK:** Network alarm function activation. Network alarm reception requires installation of the optionally available PowerCon software. The network alarm transmits both the alarm message and the DVR IP address as sender to up to 3 recipients.

YES: Network alarm is activated.

NO: Network alarm is deactivated.

(10) **MAIN MON:** Alarm reaction on MAIN monitor in case of alarm.

NO CHANGE: The currently selected main monitor display does not change.

FULL SCREEN: Monitor displays the alarm camera (see (3)) image in full screen.

(11) **CALL MON:** Alarm reaction on CALL monitor in case of alarm.

NO CHANGE: The currently selected call monitor display does not change.

Camera 1~9 (16): Monitor displays full screen image of the camera defined within the menu item.

(12) **MATRIX 1 ~ 4:** Alarm reaction on MATRIX monitor in case of alarm.

NO CHANGE: The currently selected matrix monitor display does not change.

Camera 1~9 (16): Monitor displays full screen image of the camera defined within the menu item.

(13) **SUMMARY**

The SUMMARY menu item gives a summary on the settings for control purpose. Use the JOG to browse the individual settings.

ATTENTION: This menu does not allow any editing of settings.

3.5 MOTION DETECTION

MOTION SETUP MENU		
CAMERA 1	MOTION	ENABLE
CAMERA 2	SENSITIVITY	07
CAMERA 3		
CAMERA 4	DURATION	05 SEC
CAMERA 5	ALARM OUTPUT	01
CAMERA 6	E-MAIL	NO
CAMERA 7	NETWORK	NO
CAMERA 8	BUZZER	DISABLE
CAMERA 9		
SUMMARY	MAIN MON	NO CHANGE
	CALL MON	NO CHANGE
	MATRIX 1	NO CHANGE
	MATRIX 2	NO CHANGE
	MATRIX 3	NO CHANGE
	MATRIX 4	NO CHANGE

Menu display for EDR-920, EDR1640 identical, but with 16 cameras.

Define all motion detection settings for the individual cameras in the MOTION DETECTION menu. Use the JOG to select the cameras from the list on the left.

(1) MOTION:

ENABLE: Motion detection is activated.

DISABLE: Motion detection is deactivated.

ATTENTION: Motion detection is automatically deactivated upon opening an on-screen display!

(2) SENSITIVITY:

Define the trigger sensitivity in 10 steps (1 – lowest, 10 – highest). Check the setting by carrying out a moving test within the zone setting.

(3) DURATION: Alarm duration upon motion detection. Duration applies to recording, screen change, buzzer and output contact and is adjustable from 1~99 seconds.

(4) ALARM OUTPUT:

Output relay activation.

1 ~ 4: Output relay 1~4 (selection) is switched in case of motion detection.

NONE: Output relay is deactivated.

COPY function

Motion detection settings can be copied from one camera to another. The zone settings cannot be copied.

Select the camera to be copied from the camera list on the left and press the COPY key.

The message "COPIED" appears at the top screen margin.

Select the camera which shall apply the settings from the camera list.

Press the SEARCH key to assign the copied settings to the camera.

The message "PASTED" appears at the top screen margin.

(5) EMAIL:

By selecting "ON", an email is sent in case of motion alarm, containing the alarm message, the camera's alarm image and the DVR IP address as sender. Define the email recipient's details in the NETWORK menu.

(6) BUZZER: Alarm buzzer activation

ENABLE: Alarm buzzer is activated.

DISABLE: Alarm buzzer is deactivated.

(7) NETWORK: Network alarm function activation. Network alarm reception requires installation of the optionally available PowerCon software. The network alarm transmits both the alarm message and the DVR IP address as sender to up to 3 recipients.

YES: Network alarm is activated.

NO: Network alarm is deactivated.

(8) MAIN MON: Alarm reaction on MAIN monitor in case of motion alarm.

NO CHANGE: The currently selected main monitor display does not change.

FULL SCREEN: Monitor displays the alarm camera image in full screen.

(9) CALL MON: Alarm reaction on CALL monitor in case of motion alarm.

NO CHANGE: The currently selected call monitor display does not change.

FULL SCREEN: Monitor displays the alarm camera image in full screen.

(10) MATRIX 1 ~4: Alarm reaction on MATRIX monitor in case of motion alarm.

NO CHANGE: The currently selected matrix monitor display does not change.

FULL SCREEN: Monitor displays the alarm camera image in full screen.

(11) SUMMARY: The SUMMARY menu item gives a summary on the settings for control purpose.

Use the JOG to browse the individual settings.

This menu does not allow any editing of settings.

ATTENTION: The DVR's motion detection has been developed for recording control, not for use as central alarm station, especially with connection to security services.

The manufacturer is not liable for loss or charges resulting from such application, e.g. through false alarm triggering.



(10) AREA SETUP

With activated motion detection, the sub menu for setting up detection areas can be entered by pressing the SELECT key.

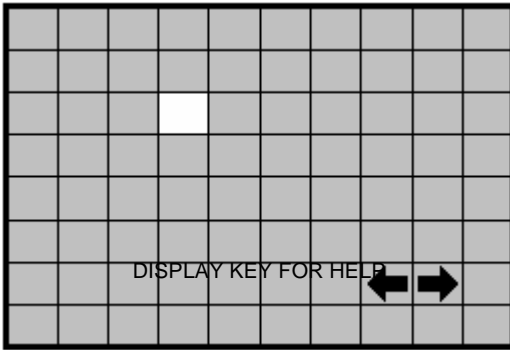
Use the DISPLAY key to show all function keys available for this menu at any time.



Active areas are shown in green.

Press the **COPY** key to start the selection. Use the **JOG** to raise a window and use the ENTER key to switch the jog direction between vertical  and horizontal .

Having selected the requested window, use the **SEARCH** key to activate the selected areas.

Use the **PAUSE** key to deactivate the selected areas.

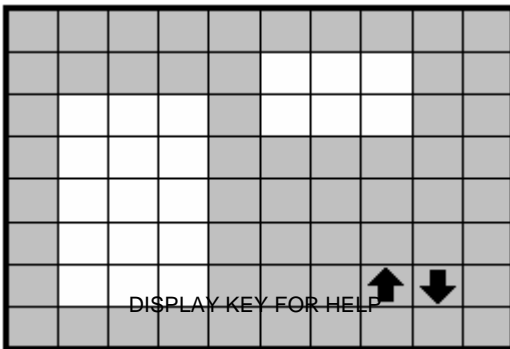

If several or combined detection areas are required, this procedure kann be repeated as often as necessary.

Press the **MENU** key to leave this sub menu.

- **Moving test:** The triggered areas are shown in red. Adjust the sensitivity settings if required.
- **Delete all areas:** Press the **PLAY** key to delete all areas.
- On-screen help menu (start with **DISPLAY**):

MENU	- EXIT
COPY	- SELECT AREAS
ENTER	- DIRECTION
SEARCH	- ACTIVATE AREAS
PAUSE	- DEACTIVATE AREAS

3.6 VIDEO LOSS MENU

VLOSS SETUP MENU		
CAMERA 1	VLOSS	ENABLE
CAMERA 2		
CAMERA 3	DURATION	05 SEC
CAMERA 4	ALARM OUTPUT	01
CAMERA 5	ALARM EMAIL	NO
CAMERA 6	BUZZER	DISABLE
CAMERA 7	ALARM NETWORK	NO
CAMERA 8		
CAMERA 9		
SUMMARY		

Menu display for EDR-920, EDR1640 identical, but with 16 cameras.

Define the reaction upon video signal loss for each camera in this menu:

(1) VLOSS:

ENABLE: Video loss detection is activated.

DISABLE: Video loss detection is deactivated.

(2) DURATION: Alarm duration. Duration applies to buzzer and output contact and is adjustable from 1~99 seconds.

(3) ALARM OUTPUT: Output relay activation.

1: Output relay 1 ~ 4 (selection) is switched in case of alarm

NONE: Output relay is deactivated.

(4) ALARM EMAIL: By selecting "ON", an email is sent in case of alarm, containing the alarm message and the DVR IP address as sender.

Define the email recipient's details in the NETWORK menu.

(5) BUZZER: Alarm buzzer activation

ENABLE: Alarm buzzer is activated.

DISABLE: Alarm buzzer is deactivated.

(6) ALARM NETWORK: Network alarm function activation. Network alarm reception requires installation of the optionally available PowerCon software. The network alarm transmits both the alarm message and the DVR IP address as sender to up to 3 recipients.

YES: Network alarm is activated.

NO: Network alarm is deactivated.

(10) SUMMARY: The SUMMARY menu item gives a summary on the settings for control purpose. Use the JOG to browse the individual settings.

ATTENTION: This menu does not allow any editing of settings.

3.7 NETWORK MENU

Define all network-related settings in this menu.

These settings should only be carried out by skilled personnel qualified for network installation; if the DVR is implemented in existing networks, the network administrator should be consulted.

This chapter doesn't go into basic network technique details. For further information, especially about router installation and internet connection, please refer to the publication "EverFocus network technique".

3.7.1 NETWORK

NETWORK SETUP MENU		
CONFIG	DHCP	NO
ALARM	IP ADDRESS	192.168.001.200
EMAIL	SUBNET MASK	255.255.255.0
PASSWORD	GATEWAY	192.168.001.100
	DNS SERVER	192.168.001.110
	HTTP PORT	00080
	CONTROL PORT	01600
	DATA PORT	37260
	MAC ADDR	00:11:14:01:83:2A

Define the basic DVR TCP/IP settings in the NETWORK menu:

(1) DHCP: DHCP (Dynamic Host Communication Protocol), automatic IP number assignment (if supported by the network).

YES: DHCP activated

NO: DHCP deactivated.

(2) IP ADDRESS: Enter the DVR's IP address.

If DHCP is activated, IP address is assigned automatically.

(3) SUBNET MASK: Local network subnet mask:

If DHCP is activated, subnet mask is assigned automatically.

(4) GATEWAY: Network gateway IP address for external access.

If DHCP is activated, gateway address is assigned automatically.

(5) DNS SERVER: Local network DNS server IP address.

If DHCP is activated, DNS server address is assigned automatically.

(6) HTTP PORT: Default setting for this port is: 80. The port can be changed if necessary.

(7) CONTROL PORT: Default setting for this port is: 1600. The port can be changed if necessary.

(8) DATA PORT: Default setting for this port is: 37260. The port can be changed if necessary.

ATTENTION: If several users simultaneously access the DVR via network, each user requires a DATA PORT (max. 4 users). Upon activating ports, e.g. in firewalls, the following ports have to be opened additionally:

DATA PORT +1

DATA PORT +2

DATA PORT +3

Example: Dataport 37260 > ports to be opened : 37260, 37261, 37262, 37263

(9) MAC ADDR: Display of network interface MAC address (cannot be changed).

3.7.2 ALARM (Network alarm)

NETWORK SETUP MENU		
CONFIG	PROTOCOL	UDP
ALARM	PORT NUMBER	01600
EMAIL	UNIQUE ID	-----
PASSWORD	SERVER1	192.168.001.122
	SERVER2	192.168.001.123
	SERVER3	192.168.001.124

Having installed the optionally available PowerCon software, the DVR can transmit a network alarm to up to 3 recipients in case of event.

(1) PROTOCOL: Network alarm transmission protocol type

TCP: TCP protocol transmission

UDP: UDP protocol transmission

(2) PORT : Network port through which the alarm is transmitted. This port must be set at the client's side (recipient) correspondingly.

(3) UNIQUE ID: DVR ID number, used for identification by the recipient's software.

(4) **SERVER 1** : Alarm server 1 IP address (recipient)

(5) **SERVER 2** : Alarm server 2 IP address (recipient)

(6) **SERVER 3** : Alarm server 3 IP address (recipient)

3.7.3 EMAIL (Email alarm)

NETWORK SETUP MENU		
CONFIG	SMTP	-----
ALARM	SERVER	-----
EMAIL		-----
PASSWORD	PORT NUMBER	00025
	AUTHENTICATION	NO
	USER	-----

	PASSW.	-----

	EMAIL	-----
	ADR	-----

Define the recipient's email account settings for email alarm in the EMAIL menu item. Email alarms can be sent upon motion, alarm contact and technical alarms (WARNING menu).

An *.arv file format alarm image is transmitted upon motion and alarm contact alarms. The visibility of these images requires installation of the EDR viewer software on the recipient's PC. The software may either be copied to USB stick in the COPY menu or be downloaded from the EDR browser through network connection (mouse click on EverFocus logo).

- (1) **SMTP SERVER:** Email recipient's SMTP server
- (2) **PORT:** SMTP server port number
- (3) **AUTHENTICATION:** "YES" if SMTP server requires login with user name / password.
"NO" if SMTP server doesn't require login.
- (4) **USER:** SMTP server user name
- (5) **PASSW:** SMTP server password
- (6) **EMAIL ADDR:** Alarm recipient's email address

3.7.4 PASSWORD

NETWORK SETUP MENU			
CONFIG	NAME	PASSWORD	LEVEL
ALARM	1 ADMIN__	*****	PLAY
EMAIL	2 USER2__	*****	LIVE
PASSWORD	3 USER3__	*****	LIVE
	4 USER4__	*****	LIVE
	5 USER5__	*****	LIVE
	6 USER6__	*****	LIVE

Define user names, passwords and user rights for network access in the PASSWORD menu item. Up to 6 different users can be defined:

(1) NAME: User name for network login

(2) PASSWORD: Password for network login

(3) LEVEL: Define the administrative rights for network access.

LIVE: only live view is possible, no playback, no event list retrieval.

PLAY: live and playback view is possible, playback search via event list or time/date search

3.8 TIMER MENU

SCHEDULE SETUP MENU				
TP	DAY	START	END	SET
1	DLY	00:00	00:00	OFF
2	DLY	00:00	00:00	OFF
3	DLY	00:00	00:00	OFF
4	DLY	00:00	00:00	OFF
5	DLY	00:00	00:00	OFF
6	DLY	00:00	00:00	OFF
7	DLY	00:00	00:00	OFF
8	DLY	00:00	00:00	OFF

DLY = DAILY
 WDAY = MONDAY TO FRIDAY
 WEND = SATURDAY + SUNDAY

Define the time frames for scheduled recording in the TIMER menu:

(1) DAY:

MO (Monday), **TU** (Tuesday), **WE** (Wednesday), **TH** (Thursday), **FR** (Friday),
SA (Saturday), **SU** (Sunday).

WDAY: Monday to Friday.

WEND: Weekend, Saturday and Sunday.

DLY: Daily.

(2) START: Recording start time

(3) END: Recording end time

ATTENTION: The start time must be before the end time. I.e. if a recording schedule comprises two consecutive days, both days require a separate schedule!

Example: Task: Daily recording from 8 pm to 6.30 am the next morning.

WRONG !:

TP	DAY	START	END	SET
1	DLY	20:00	06:30	ON

CORRECT:

TP	DAY	START	END	SET
1	DLY	20:00	00:00	ON
2	DLY	00:00	06:30	ON

(4) SET (activation) :

ON: Schedule is activated.

OFF: Schedule is deactivated.

3.9 HDD (harddisk) MENU

DISK SETUP MENU				
<hr/>				
DISK INFORMATION	1-4			
DISK VIDEO DELETE	01			
THERMOMETRIC SCALE	CELSIUS			
NO.	SIZE(GB)	°C	START/END TIME	
01	152	42	13.11.2005	14:55:45
			15.11.2005	16:59:40
02	152	43	15.11.2005	16:59:40
			16.11.2005	09:23:11
03	NO EXIST			
04	NO EXIST			
PRESS SELECT/MIDDLE TO START DELETE				

Check harddisk status and delete harddisk indexes in the HDD menu.

(1) DISK INFORMATION: Harddisk number in blocks of 4 HDD (more than 2 HDD only in combination with harddisk expansion EDA800), use the JOG for selection

(2) DISK VIDEO DELETE: After confirmation with SELECT and a further security request, the harddisk's index is deleted.

ATTENTION: Deleting the index does not comprise the secure erasure of video data in terms of data protection. The secure erasure is not possible in the DVR, but on a PC, requiring a specific tool provided by the HDD manufacturer!

(3) THERMOMETRIC SCALE: Select the temperature unit °CELSIUS or °FAHRENHEIT for display of the current HDD temperature.

(4) TABLE:

SIZE(GB): Total HDD capacity in Gigabyte

°C (or °F): current HDD temperature, readout through the HDD S.M.A.R.T. interface

The temperature is readout cyclically. After restarting the recording, allow some minutes for initial temperature display.

START/END TIME: Time and date of the first and last recording available on the HDD.

3.10 RS232/RS485 MENU

CONTROL SETUP MENU	
<hr/>	
RS232	
BAUD RATE	9600 BPS
STOP BIT	1
PARITY	NONE
DATA BIT	8
RS485	
BAUD RATE	9600 BPS
STOP BIT	1
PARITY	NONE
DATA BIT	8
RS232/RS485 ID	1
PTZ PROTOCOL	EVERFOCUS

Define the settings for DVR remote control through serial interface in the **RS232/RS485** menu. Pin assignment and remote control protocol are described in appendix B and C.

- (1) **RS232 BAUD RATE:** RS-232 interface transmission speed. 1200, 2400, 4800, 9600, 19200 and 3840 baud can be selected.
Default setting: 9600 baud
- (2) **RS232 STOP BIT:** Number of stop bits: 1 or 2
- (3) **RS232 PARITY:** Parity mode: NONE / EVEN / ODD
- (4) **RS232 DATA BIT:** Number of data bits: 8 or 7
- (5) **RS485 BAUD RATE:** RS-485 interface transmission speed. 1200, 2400, 4800, 9600, 19200 and 3840 baud can be selected.
Default setting: 9600 baud
- (6) **RS485 STOP BIT:** Number of stop bits: 1 or 2
- (7) **RS485 PARITY:** Parity mode: NONE / EVEN / ODD
- (8) **RS485 DATA BIT:** Number of data bits: 8 or 7
- (9) **RS232/RS485 ID:** RS232/RS485 address. Addressable range: 1~255.
This address complies with the device number for remote control through keyboards EKB 500, KS KBK and KS KBJ (DEVICE No.).
- (10) **PTZ-PROTOCOL:** Protocol type setting for network telemetry control, available protocols:
EVERFOCUS1 (EPTZ1800 Dome),
EVERFOCUS2 (EPTZ1000/3000 Dome),
ED2200/2250 (complies with Samsung protocol SCC-641/643),
Pelco-D, Pelco-P

NOTE: Standard setting for EKB500 keyboard connection:

RS-485 Baud Rate: 9600, 1 stop bit, **Parity** NONE, **RS232/RS485 ID** = Device/DVR Nr. at keyboard

3.11 WARNING MENU

The EDR provides warning functions allowing signalling upon operation failure. Define the alarm reactions in the WARNING menu.

3.11.1 FAN FAILURE

WARNING SETUP MENU		
FAN FAULT	BUZZER	ENABLE
HDD TEMP.	ALARM OUTPUT	1
NO HDD	ALARM DURATION	PERMANENT
HDD FULL	NETWORK ALARM	NO
	EMAIL	NO

Both fans provide failure detection. Define the alarm reactions upon fan failure in this menu item:

(1)BUZZER: By selection "ENABLE", the buzzer is activated upon fan failure.

(2)ALARM OUTPUT: Output relay activation.

1 – Output relay 1 (for EDR410/810, only one output relay is available)
NONE – no relay reaction upon alarm.

(3) ALARM DURATION: PERMANENT - This value cannot be changed, alarm is automatically switched off after problem has been solved (fan replacement).

(4) NETWORK ALARM:

YES: Network alarm activated (for settings refer to NETWORK menu)
Network alarm reception requires optional PowerCon software.

NO: No network alarm transmission

(5) EMAIL:

YES: Alarm email transmission (for settings refer to NETWORK menu).

NO: No email alarm transmission.

3.11.2 HDD TEMP.

WARNING SETUP MENU		
FAN FAULT	BUZZER	ENABLE
HDD TEMP.	ALARM OUTPUT	1
NO HDD	ALARM DURATION	PERMANENT
HDD FULL	NETWORK ALARM	NO
	EMAIL	NO
	STOP RECORD	YES

The enduring HDD temperature surveillance guarantees an alarm reaction in case the threshold value is exceeded.

There may be several reasons for HDD temperature excess:

- Exceedance of the max. tolerable ambient temperature (40°C), e.g. upon installation in an electrical cabinet with inadequate ventilation
- After-effect upon fan failure
- HDD defect

(1) BUZZER: By selecting "ENABLE", the buzzer is activated upon HDD temperature excess.

(2) ALARM OUTPUT: Output relay activation.

1 – Output relay 1 ~ 4 (selection) switches upon alarm.

NONE – no output relay reaction upon alarm.

(3) ALARM DURATION: PERMANENT - This value cannot be changed, alarm is automatically switched off after problem has been solved.

(4) NETWORK ALARM:

YES: Network alarm activated (for settings refer to NETWORK menu)

Network alarm reception requires optional PowerCon software.

NO: No network alarm transmission

(5) EMAIL:

YES: Alarm email transmission (for settings refer to NETWORK menu).

NO: No email alarm transmission.

(6) STOP RECORD

YES: Recording process is stopped to avoid further temperature rise and HDD damage.

NO: Recording process continues.

3.11.3 NO HDD

WARNING SETUP MENU		
FAN FAULT	BUZZER	ENABLE
HDD TEMP.	ALARM OUTPUT	1
NO HDD	ALARM DURATION	PERMANENT
HDD FULL	NETWORK ALARM	NO
	EMAIL	NO

The DVR detects when both harddisks are removed, switched off or not detected. Define the alarm reactions in this menu item:

- (1) **BUZZER:** By selecting "ENABLE", the buzzer is activated.
- (2) **ALARM OUTPUT:** Output relay activation.
1 – Output relay 1 ~ 4 (selection) switches upon alarm.
NONE – no output relay reaction upon alarm.
- (3) **ALARM DURATION:** Alarm duration adjustment from 1~99 seconds or permanent.
- (4) **NETWORK ALARM:**
YES: Network alarm activated (for settings refer to NETWORK menu)
Network alarm reception requires optional PowerCon software.
NO: No network alarm transmission
- (5) **EMAIL:**
YES: Alarm email transmission (for settings refer to NETWORK menu).
NO: No email alarm transmission.

3.11.4 HDD FULL

WARNING SETUP MENU		
FAN FAULT	BUZZER	ENABLE
HDD TEMP.	ALARM OUTPUT	1
NO HDD	ALARM DURATION	PERMANENT
HDD FULL	NETWORK ALARM	NO
	EMAIL	NO

In operation mode **HDD FULL: STOP** (setting in RECORDING menu), the recording process is stopped if the harddisk is full. Define the alarm reactions in this menu item:

- (1)**BUZZER:** By selecting "ENABLE", the buzzer is activated.
- (2)**ALARM OUTPUT:** Output relay activation.
1 – Output relay 1 ~ 4 (selection) switches upon alarm.
NONE – no output relay reaction upon alarm.
- (3) **ALARM DURATION:** Alarm duration adjustment from 1~99 seconds or permanent
- (4) **NETWORK ALARM:**
menu) **YES:** Network alarm activated (for settings refer to NETWORK menu)
Network alarm reception requires optional PowerCon software.
NO: No network alarm transmission
- (5) **EMAIL:**
menu). **YES:** Alarm email transmission (for settings refer to NETWORK menu).
NO: No email alarm transmission.

3.12 SYSTEM MENU

SYSTEM SETUP MENU		
SYSTEM VERSION		V1.22
SYSTEM VIDEO FORMAT		PAL
LOAD/SAVE CONFIGURATION		NO
UPDATE SYSTEM SOFTWARE		NO
LANGUAGE		ENGLISH
QUICK PLAY	ON	10 MINUTES AGO
SYSTEM PASSWORD ENABLE		NO
	PASSWORD	RIGHTS
LEVEL-3	*****	ADMINISTRATOR
LEVEL-2	*****	OPERATOR
LEVEL-1	*****	GENERAL

Define the following settings in the SYSTEM menu:

(1) SYSTEM VERSION: Display of the installed firmware version.

(2) SYSTEM VIDEO FORMAT: Display of the detected video system PAL or NTSC. The EDR automatically detects the video system upon system startup.

ATTENTION: Auto detection checks video input 1 upon system startup. Therefore, it is compulsory to start the DVR with video signal connected to channel 1. Otherwise, default setting NTSC is loaded!

(3) SAVE/LOAD CONFIGURATION:

Selecting **YES** opens a sub menu showing the following items (use the **JOG** for selection):

CANCEL: Return to system menu

DEFAULT: Load default setting after security request **YES/NO**

ATTENTION: The network settings remain stored despite loading default setting!

SAVE: Save the current configuration to CF card / USB stick.

LOAD: Load a configuration from CF card / USB stick.

(4) UPDATE SYSTEM SOFTWARE: DVR update with latest firmware version through USB-stick or CF card. At first, place the CF card or the USB stick into the respective interface.

YES: After confirmation with SELECT, the firmware update is run. Update is carried out in 3 phases (display at bottom screen margin) and can take up to 5 minutes.

ATTENTION:

1. Before starting the update, stop the recording process.
2. Do not switch the DVR off while update is run.
3. Do not remove CF card or USB stick while update is run.

NO: Cancel, return to SYSTEM menu

ATTENTION: After updating the system, restart, loading of default settings and further restart are required. Furthermore, HDD should be deleted.

(5) LANGUAGE: System language selection.

(6) QUICK PLAY: The "QuickPlay" function is a convenient playback function allowing the immediate playback of video recorded 5~60 minutes ago by pressing the PLAY key.

ON: QuickPlay function activated.

OFF: QuickPlay function deactivated. Pressing the PLAY key starts the playback at the last playback position.

xx MINUTES AGO: Enter the time in minutes, adjustable from 5~60 minutes.

ATTENTION: If the DVR operates with low recording rates, the playback may overlap into the active (not yet closed) recording segment in case the QuickPlay time is not long enough, resulting in black images and the message "?????" in the status bar.
If this happens, choose a longer QuickPlay time.

(7) SYSTEM PASSWORD:

By selecting "ENABLE", different EDR operations require password input for local use.

3 different levels of user rights are available. Passwords can be modified in the list.

Default settings are:

Level 1: 111111

Level 2: 222222

Level 3: 333333

ATTENTION: If a password applies to different levels, login is carried out in the higher level.

User rights, version 1.22				
LEVEL RIGHT	LEVEL-3	LEVEL-2	LEVEL-1	WITHOUT
	ADMINISTRATOR	OPERATOR	GENERAL	----
DISPLAY	OK	OK	OK	OK
MODE	OK	OK	OK	OK
ZOOM	OK	OK	OK	OK
FULL	OK	OK	OK	OK
SELECT	OK	OK	OK	NO
SEQ	OK	OK	OK	NO
CALL	OK	OK	NO	NO
MENU	OK	NO	NO	NO
COPY	OK	NO	NO	NO
SEARCH	OK	NO	NO	NO
PLAY	OK	NO	NO	NO
STOP	OK	NO	NO	NO
REV.PLAY	OK	NO	NO	NO
REC	OK	NO	NO	NO
PAUSE	OK	NO	NO	NO

4. RECORDING

4.1 RECORDING

ATTENTION: The following instructions as regard to the EDR DVR recording and recording standby have to be followed thoroughly. Some of the DVR's functions significantly differ from previous models.



REC

Actuate the REC key to switch the DVR to recording resp. recording standby mode. The red LED within the REC key is illuminated. Alternatively, the DVR can be switched to recording / recording standby mode through the REC IN input contact.

ATTENTION: The DVR must be switched to recording standby mode (LED in REC key ON!), even if only motion- or alarm-triggered recording is selected (no continuous recording), otherwise no recording will be processed! This doesn't apply to scheduled recordings (TIMER) which switch to recording mode even if recording standby mode is switched off.



STOP

Press the STOP key to stop the recording resp. recording standby.

- To stop scheduled recordings, the timer must be deactivated in the TIMER menu.
- First STOP key actuation in playback mode stops the playback, second actuation stops the recording resp. recording standby.

ATTENTION: HDD shutdown and removal is not admissable during recording and playback mode and upon DVR system startup!

ATTENTION: Switching off the harddisk with the key switch will logoff the harddisk from the system. Remove the harddisk only after the green power source LED at the harddisk tray is extinguished.

4.2 TIMER – scheduled recording

- Define the scheduled recording settings in the TIMER menu.
With activated timer, recording starts and stops automatically.

SCHEDULE SETUP MENU				
SCH	DAY	START	END	SET
1	WEND	08:00	12:00	ON
2	WDAY	08:00	17:00	ON
3	DLY	17:00	23:00	ON
4	DLY	00:00	00:00	OFF
5	DLY	00:00	00:00	OFF
6	DLY	00:00	00:00	OFF
7	DLY	00:00	00:00	OFF
8	DLY	00:00	00:00	OFF

DLY = DAILY
WDAY = MON to FRI
WEND = SAT and SUN

4.3 Event recording

If event-triggered recordings are programmed in the ALARM and/or MOTION menu, the respective cameras are recorded at the "EVENT" recording rate (programming in CAMERA menu).

ATTENTION:

For this recording mode, the DVR must be in recording standby mode (REC-LED ON).

The DVR can be switched to standby mode either manually (through REC key), via TIMER configuration or through the REC-IN contact.

ATTENTION: HDD shutdown and removal is not admissible during recording and playback mode and upon DVR system startup!

ATTENTION: Switching off the harddisk with the key switch will logoff the harddisk from the system. Remove the harddisk only after the green power source LED at the harddisk tray is extinguished.

5. PLAYBACK

5.1 PLAYBACK WITHOUT SEARCH FUNCTION

(1) Playback



PLAY

Press the PLAY key to switch the DVR to playback mode. Depending on the "QuickPlay" function settings (see SYSTEM menu), playback starts at one of the following positions:

QuickPlay OFF: playback starts at the last playback position

QuickPlay ON: playback starts 5 ~ 60 min (definition in SYSTEM menu) before current recording position

(2) STOP



STOP

Press the STOP key to stop the playback mode.

(3) Fast forward / reverse



PLAY

Use the JOG/SHUTTLE to control the playback speed in playback mode.

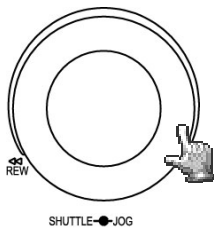

Turn the **SHUTTLE** clockwise for fast forward playback. Depending on the shuttle speed, the playback speed increases to 2, 4, 6, 8, 16 or 32x.

Turn the **SHUTTLE** counter-clockwise for normal or fast reverse playback. Depending on the shuttle speed, the playback speed increases to 2, 4, 6, 8, 16 or 32x.

Use the **ENTER** key to lock the fast playback search and the **SHUTTLE** or **PLAY** key to unlock the fast playback search.

ATTENTION: HDD shutdown and removal is not admissible during recording and playback mode and upon DVR system startup!

ATTENTION: Switching off the harddisk with the key switch will logoff the harddisk from the system. Remove the harddisk only after the green power source LED at the harddisk tray is extinguished.

(4) Slow forward playback



PAUSE

Press the **PAUSE** key during playback to freeze the image at the current playback position.

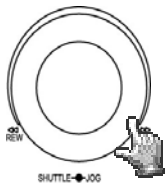

Turn the **SHUTTLE** clockwise for slow forward playback. Depending on the shuttle speed, the playback speed is reduced to 1/2, 1/4, 1/8, 1/10, 1/16, 1/32 of the normal speed.

This playback mode is not available for reverse playback.

(4) Single image playback

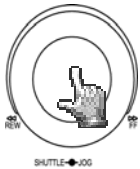

Press the **PAUSE** key during playback.

Turn the **JOG** for single image playback. Increasing the rotational speed will increase the playback speed.

ATTENTION: Upon simultaneous playback and recording, first actuation of the **STOP** key will stop the playback, second actuation will stop the recording.

ATTENTION: HDD shutdown and removal is not admissible during recording and playback mode and upon DVR system startup!

ATTENTION: Switching off the harddisk with the key switch will logoff the harddisk from the system. Remove the harddisk only after the green power source LED at the harddisk tray is extinguished.

5.2 PLAYBACK SEARCH

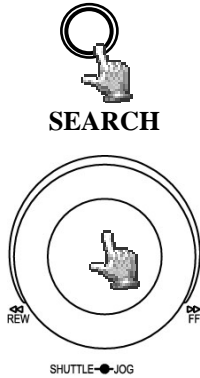

Press the **SEARCH** key to enter the search menu.

NAVIGATION:

Use the **JOG** to select values or entries.

Use the **ENTER** key to go to the next menu item and the **DISPLAY** key to go to the previous menu item.

Press the **SELECT** key to confirm a selection.

Press the **MENU** key to leave the search menu.

(1) TIME / DATE SEARCH

Select **TIME/DATE** in the first row of the search menu to enter the requested playback position in the following rows.

The period available on the connected harddisks is indicated in the **START/END TIME** field. Select the respective harddisk in the **DISK NO** field.

SEARCH MENU				
METHOD		TIME / DATE		
DATE		11-09-2005	FR	
TIME		00:33:23		
EVENT		A/M/V		
DISK NO		01		
NO	SIZE(GB)	°C	START / END TIME	
01	152	42	10-09-2005	07:33:23
			14-09-2005	06:53:11

The values in the **EVENT** row cannot be changed upon time/date search.

The bottom table further shows the total capacity of the used harddisk, its current temperature and the timeframe of available recordings.

ATTENTION: When searching for a playback position just before current recording position, it may occur that this position isn't available for playback yet (in case the recording segment hasn't been closed yet). Playback then starts at the next possible position.

(2) EVENT SEARCH

Enter **EVENT** in the first row of the search menu if you search for specific events such as alarm, motion detection or video loss.

Preselect the type of event to be listed in the **EVENT** row. The following types of event are available:

Display	Description
ALARM	Alarm events (alarm contacts and system alarms)
MOTION	Motion detection
VLOSS	Video loss
A / B	Alarm and motion detection
A / V	Alarm and video loss
B / V	Motion detection and video loss
A / B / V	All events (alarm, motion detection, video loss)

The **TIME** and **DATE** rows are inactive for this search mode.

The period available on the connected harddisks is indicated in the **START / END TIME** field at the bottom. Select the requested harddisk in the **DISK NO** field.

Having selected the type of event, press **SELECT** to start the event list showing 16 entries per page (640 pages max.).

Use either the **Shuttle** (clockwise) or the **COPY** key to browse the pages; use either the **SHUTTLE** (counter-clockwise) or the **DISPLAY** key to browse backwards.

After selecting the type of event with the **JOG** and having confirmed your selection with the **ENTER** key, the DVR switches to playback mode.

SEARCH LIST			
00001	M08	10-09-2005	10:11:33
00002	M01	10-09-2005	12:13:34
00003	M08	10-09-2005	12:13:39
00004	M04	10-09-2005	10:14:55
00005	M08	10-09-2005	10:15:33
00006	M03	10-09-2005	10:23:34
00007	V01	10-09-2005	10:22:12
00008	TN	10-09-2005	10:50:45
00009	M01	10-09-2005	10:54:35
00010	M03	10-09-2005	11:13:35
00011	M03	10-09-2005	11:15:24
00012	M04	10-09-2005	11:18:37
00013	M08	10-09-2005	12:11:34
00014	M01	10-09-2005	13:33:25
00015	M01	10-09-2005	14:09:11
00016	M08	10-09-2005	15:11:27

The type of event is indicated next to the consecutive number:

A: Alarm (Alarm contact) + contact number;

M: Motion detection + camera number;

V: Video loss + camera number;

TN: Start normal recording;

Tn: Scheduled recording, n=1~8;

PL: Power loss;

RTN: Automatic recording restart after power loss;

RTn: Automatic scheduled recording restart after power loss, Timer n=1~8.

PH (Physical Head): Physical HDD initial position;

LH (Logical Head): Logical HDD initial position upon rewriting.

F1, F2: Fan failure fan 1 / 2

OT: HDD overtemperature

6. VIDEO EXPORT

Video data can be exported as *.arv format movie file to both a USB stick or the external USB DVD drive EPR200. PC playback requires the dedicated viewer software which may be copied to USB stick through the COPY menu described below or which can be downloaded via the browser web applet in case a network connection is provided.

Single *.jpg format images can be created with the EDR viewer software. A direct single image export from EDR is not supported.

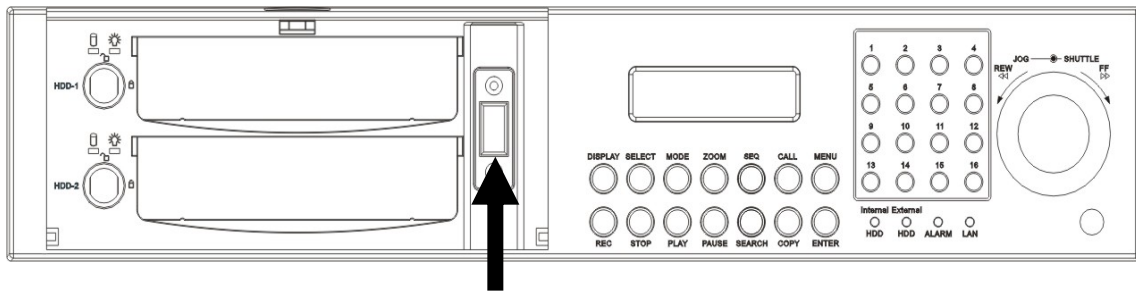

USB socket



COPY

Insert the CF card resp. the USB stick.
Press the **COPY** key to open the video export menu.

COPY MENU			
COPY	VIDEO		
DISK NO	01	CAMERA NO 04	
START DATE	10-09-2005	FR	
TIME	12:22:34		
END DATE	10-09-2005	FR	
TIME	12:27:34		
NO	SIZE(GB)	°C	START/END TIME
01	152	42	10-09-2005 07:33:23
			14-09-2005 06:53:11
PRESS MENU TO EXIT			
PRESS SELECT/MIDDLE TO START COPY			

Define the following settings in the COPY menu:

COPY: Select "VIDEO" to export video data.

Select "VIEWER" to copy the EDR viewer playback software.

DISK NO: Harddisk number; the respective harddisk's recording timeframes are indicated in the bottom list.

CAMERA NO: Number of the camera channel from which the video is to be exported.

START DATE / TIME: Video export start position.

END DATE / TIME: Video export final position.

ATTENTION: The video export start position can also be selected by pressing the COPY key during playback.

The buffered time is automatically transferred as start time in the COPY menu, the end time is automatically defined as START TIME + 5 minutes. Both values can be changed manually.

Having selected the camera number and start / end time, start the export by pressing the **SELECT** key.

7. CALL / MATRIX MONITOR SETUP

Enter the call and matrix monitor setup menu by pressing the **CALL** key:

CALL MENU			
MONITOR	SEQ	OSD	CAMERA
CALL MON	OFF	ON	01
MATRIX MON 1	OFF	ON	01
MATRIX MON 2	OFF	ON	01
MATRIX MON 3	OFF	ON	01
MATRIX MON 4	OFF	ON	01

PRESS SEQ/MIDDLE TO ON/OFF SEQ
PRESS DISPLAY TO ON/OFF OSD
PRESS CHANNEL NO/WHEEL TO SET CAMERA

Define the following settings in the CALL menu:

Press **ENTER** to select the respective monitor and the selection options:

- (1) **SEQ:** "ON" activates the monitor's sequence mode (automatic sequential switch).
- (2) **OSD:** "ON" activates the monitor's status display including camera number, monitor number and active alarms for this monitor.
- (3) **CAMERA:** Select the camera to be displayed with the channel keys 1~9 (EDR920) resp. 1~16 (EDR1640).

8. DISPLAY SETTINGS

8.1. BRIGHTNESS, CONTRAST, COLOUR

Press **SELECT** to adjust brightness, contrast and colour for each video channel in full screen mode of the respective camera (**channel keys 1 ~ 9 resp. 1 ~ 16**):

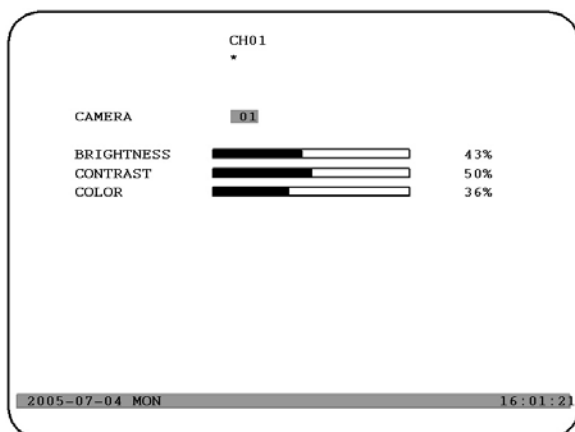

Press **ENTER** to switch between the settings and use the **JOG** to adjust the values on the sliders.

(1) **BRIGHTNESS:** Adjust the image brightness from 0 ~ 100%.

(2) **CONTRAST:** Adjust the image contrast from 0 ~ 100%.

(3) **COLOUR:** Adjust the colour saturation from 0 ~ 100%.

The current value is indicated both on the sidebar and as percentage.

Press **MENU** or **SELECT** to leave the menu.

8.2 IMAGE POSITION ADJUSTMENT ON MONITOR

If the monitor display is not centre positioned, the horizontal and vertical image position can be adjusted.

Press the **ZOOM** key in any multiscreen display (not full screen mode).

Use the **JOG** to horizontally centre the image position and press **ENTER** to switch to vertical direction.

Further **ZOOM** key actuation switches the adjustment off.

9. SCREEN DISPLAY

Press the **MODE** key to switch between 4x, 7x, 9x, 10x, 13x, 16x and PiP (Picture-in-Picture) main monitor display. 10x, 13x and 16x display are available for EDR1640 only.

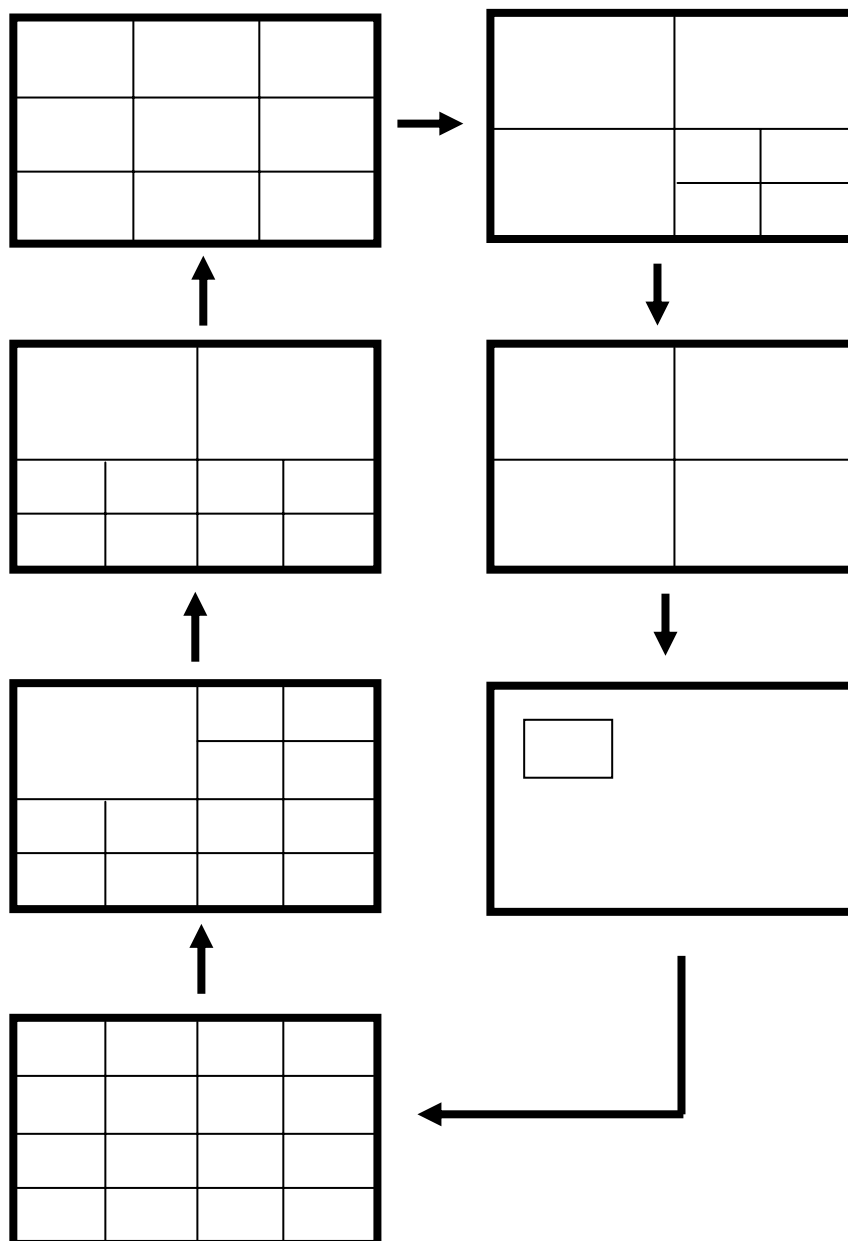

10. EDA 966 INFRARED REMOTE CONTROL (optional)

The optional EDA966 IR remote control allows the EDR remote control covering a maximum distance of 10m.

Basically, the keys comply with the EDR DVR front panel keys.

Key assignment differing to EDR front panel:

JOG  : JOG clockwise.

JOG  : JOG counter-clockwise.

SHUTTLE 

- 1: 2x fast search or 1/2x slow search (in PAUSE)
- 2: 4x fast search or 1/4x slow search (in PAUSE)
- 3: 8x fast search or 1/8x slow search (in PAUSE)
- 4: 16x fast search or 1/10x slow search (in PAUSE)
- 5: 32x fast search or 1/16x slow search (in PAUSE) .

SHUTTLE 

- 1: 2x reverse search
- 2: 4x reverse search
- 3: 8x reverse search
- 4: 16x reverse search
- 5: 32x reverse search

NOTE: Keys 10–16 are active for EDR1640 only.

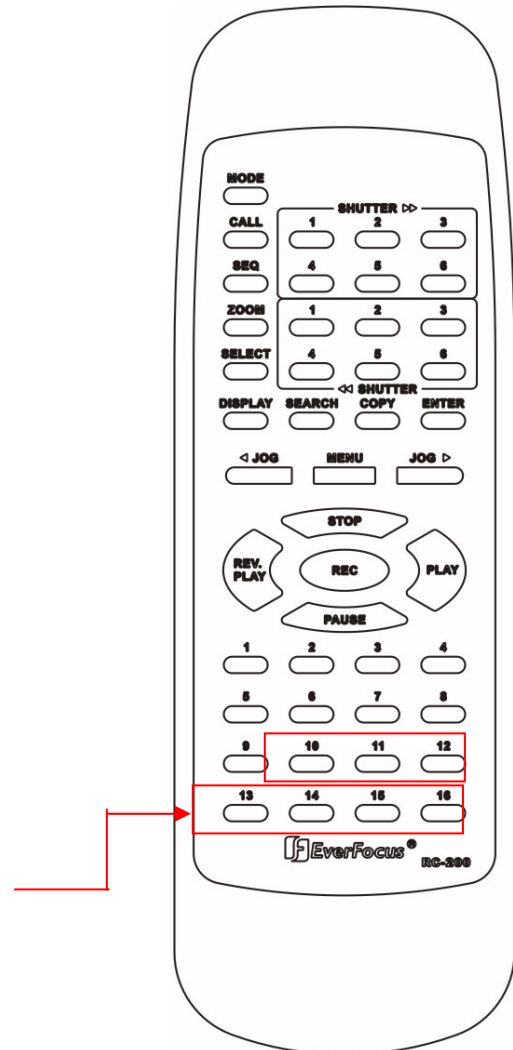

11. NETWORK ACCESS

PC SYSTEM REQUIREMENTS:

Operating system Windows XP SP2 / Windows 2000 SP6, DirectX 9.0c, Internet Explorer min. 6.x.
ActiveX applications must be permitted in the Internet Explorer settings.
The loading and installation of ActiveX components during initial installation require local PC administration rights.

The following elaborations assume the proper DVR network connection installation.

ACCESS VIA INTERNET EXPLORER

Enter the DVR IP address in the Internet Explorer address line:

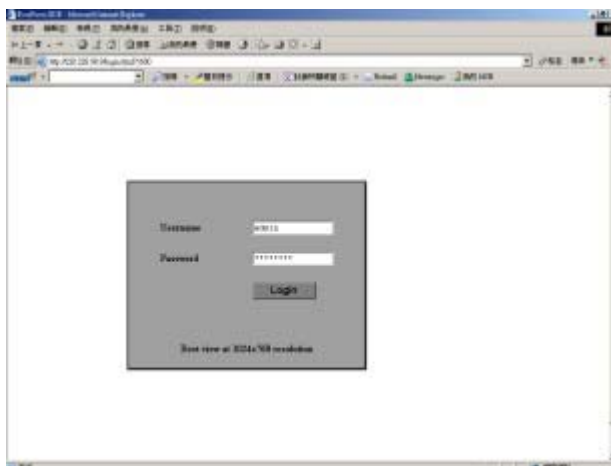





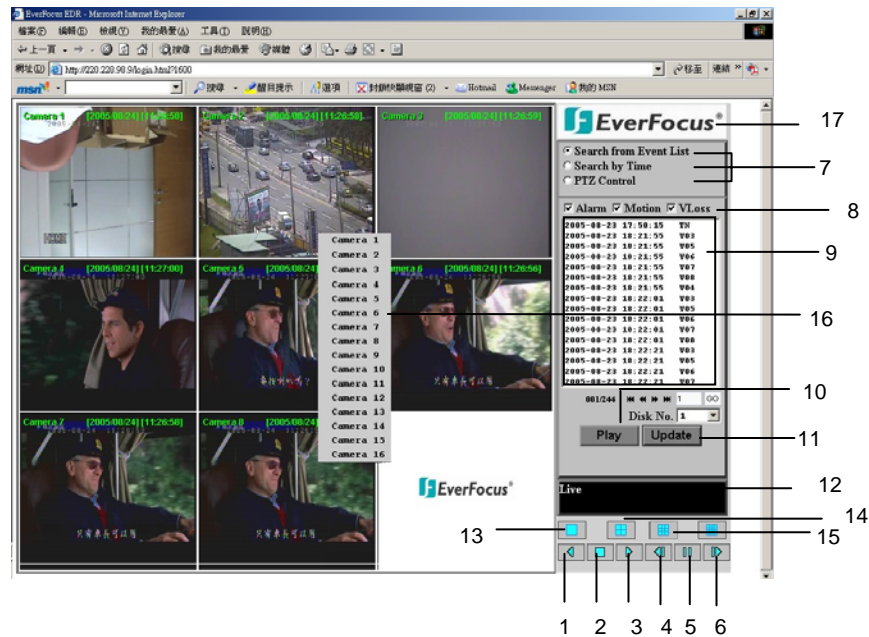

Enter user name and password in the LOGIN screen.

SCREEN ELEMENTS



The illustration shows the screen user interface with the following icons and operating elements:

1.  **REVERSE PLAYBACK**
2.  **STOP:** Stop playback mode and switch to live mode.
3.  **PLAYBACK**
4.  **SINGLE IMAGE FORWARD:** Switch to next image in PAUSE mode.
5.  **PAUSE:** Stop playback, freeze image.
6.  **SINGLE IMAGE REVERSE:** Switch to previous image in PAUSE mode.
7. Playback search, PTZ control
8. Types of event
9. Event list
10. **Play** start event playback
11. **Update** start / refresh event list
12. Connection status (PLAY or LIVE), in playback mode: playback position indication
13. Full screen display
14. 4x screen display (quad)
15. 9x screen display
16. Click right into a camera screen to open the context menu showing a list of all cameras available
17. Download EDR viewer software for export file playback (click in logo)

PLAYBACK SEARCH

Select search mode either by time/date or by event list.

Event list search mode

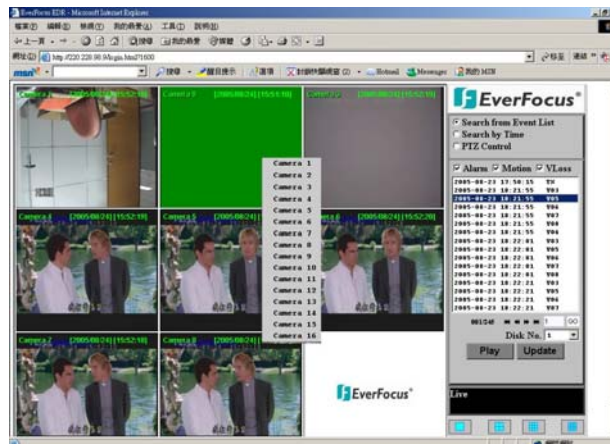

Select the types of event to be displayed: **ALARM**, **MOTION** (motion detection), **VLOSS** (video loss).

Press **UPDATE** to start / refresh the event list.

The load time depends on both the event list size and the network speed.

Events are displayed with type of event, time and date indication.

The number of pages available (max. 640) is indicated below the list. Use the following keys to browse the pages:

>> next page,

<< previous page,

>>| last page,

|<< first page.

Alternatively, the page number can also be entered directly, press **GO** to switch to the selected page.

Press **PLAY** to start the playback after selecting an entry.

TIME / DATE SEARCH

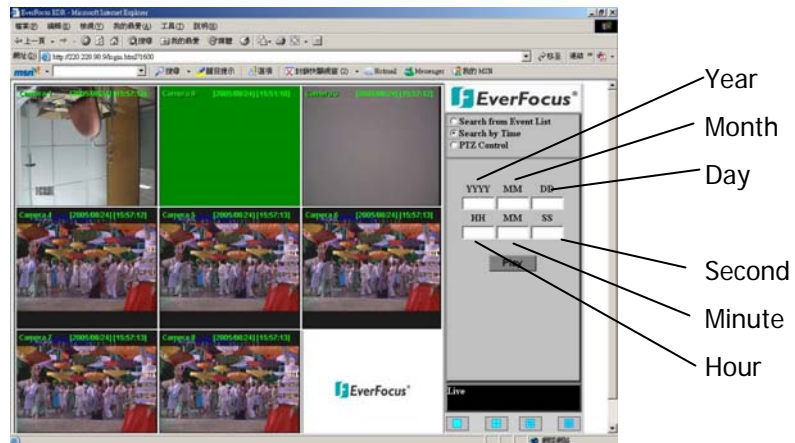

Selecting "Search by Time" opens an entry mask for playback position date and time input. Press the **PLAY** key to start the playback after data input.

PTZ CONTROL

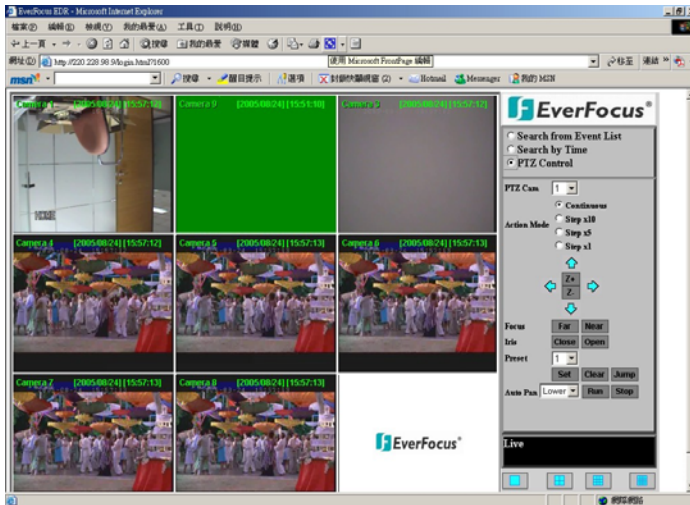

The EDR DVR allows the speed dome and PTZ device control via network.
 Select "PTZ CONTROL" to activate the telemetry mode.
 Select the camera in the PTZ CAM field.

The following control functions are available:

1. Camera selection

2. Key mode:

Pan/tilt/zoom key reaction type

Continuous – control command is sent continuously

Step x 10 – 10 single commands per keystroke are sent

Step x 5 - 5 single commands per keystroke are sent

Step x 1 – 1 single command per keystroke is sent

3. Directional arrows:

Pan / tilt control keys

4. Z+ / Z-:

Zoom function Z+: Tele, Z-: Wide

5. Focus:

manual focus

NEAR: near range,

FAR: tele range

6. IRIS:

manual iris control

OPEN: open iris

CLOSE: close iris

7. PRESET:

Preset selection

SET: Save current PTZ position as selected preset number

CLR: Delete the selected preset position

JUMP: Approach the selected preset position

8. AUTO PAN:

Automatic pan function

RUN: start AUTO PAN

STOP: stop AUTO PAN

APPENDIX A: EDR VIEWER SOFTWARE

EDR video data exported with the COPY function are saved as *.arv files, an MPEG-4 file format which cannot be run with common software, but requires a special viewer software.

This „EDR viewer“ software (freeware, no licensing required) is available in the DVR memory and may be copied anytime by one of the following methods:

1. Export to USB stick: Select „VIEWER“ in the first row of the COPY menu. Press the SELECT key to copy the software to the inserted USB stick.
2. Download via network: If the DVR is connected to a PC via network, the EDR viewer software can also be downloaded via Internet Explorer. Click the EverFocus logo to start the download.

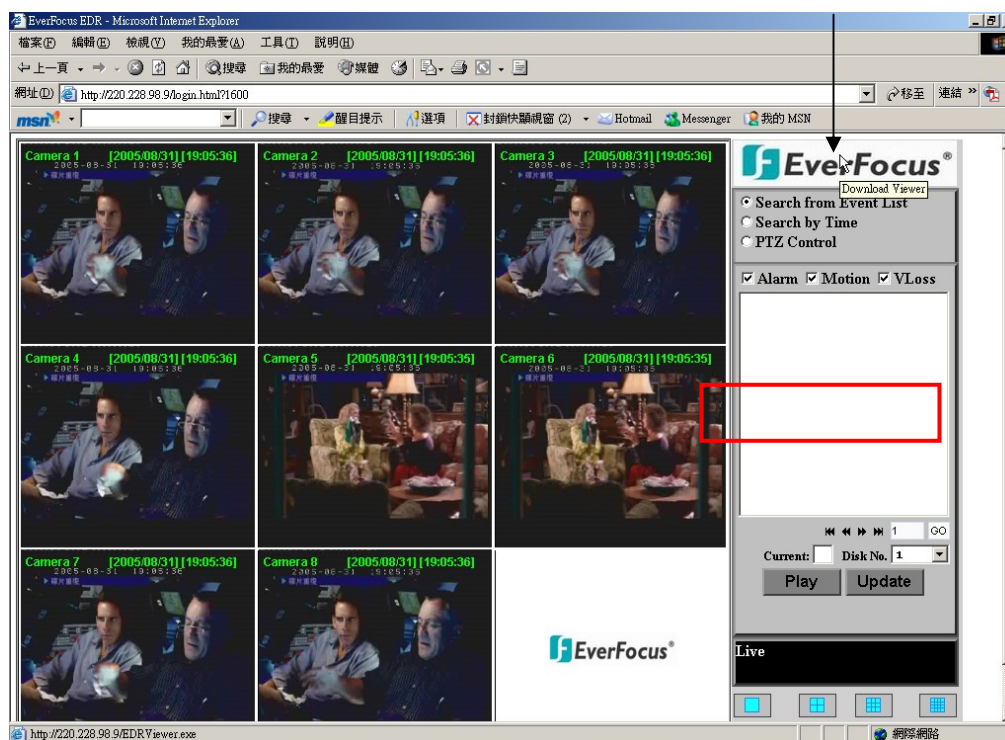

EDR VIEWER INSTALLATION

PC SYSTEM REQUIREMENTS:

Operating system Windows XP SP2 / Windows 2000 SP6, DirectX 9.0c (free download on www.microsoft.com/directx), Internet Explorer min. 6.x, DivX codec (for AVI export, free download on e.g. www.divx.com).

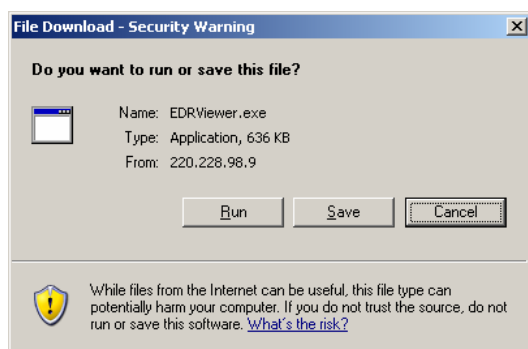

The EDR viewer consists of one file only: EDRViewer.exe. Save this file to your PC and run the exe file.

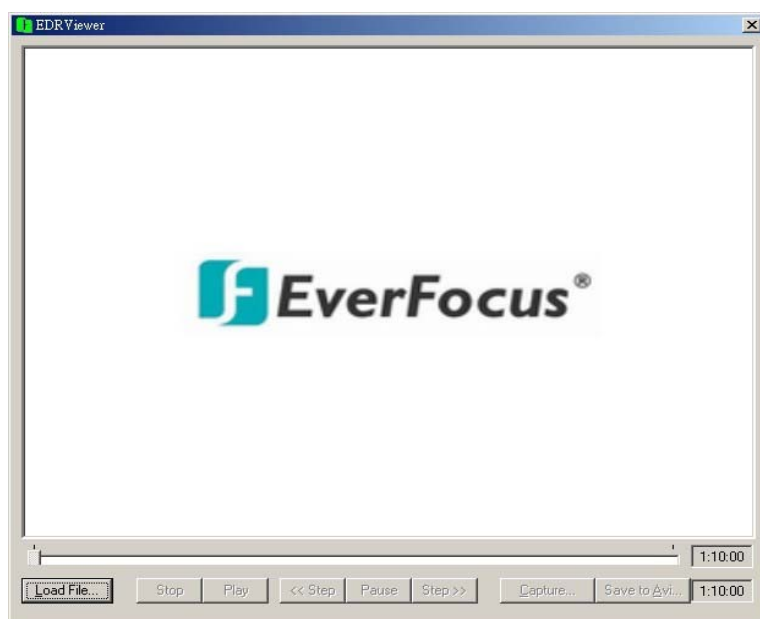

The EDR viewer enables ARV file playback, JPG format single image storage and video file conversion to AVI format (with DivX codec, see PC SYSTEM REQUIREMENTS).

ATTENTION: The conversion of video files recorded with 720x288 recording resolution will result in AVI files with half the image height. For these files, it is recommended to make use of playback software able to correct the aspect ratio (e.g. MediaPlayer Classic, freeware, download on www.everfocus.de).

INTERFACE SPECIFICATION

1. RS-232 Pin assignment

EDR1640/920 can be controlled by external devices through RS-232 interface.

■ Pin assignment 9-pin RS-232 plug

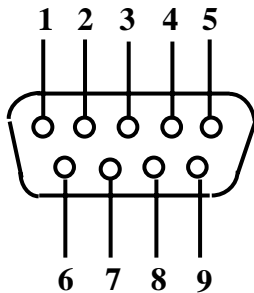

DVR			HOST	
PIN	NAME		PIN #	NAME
1	FREE		1	FREE
2	TXD	→	2	RXD
3	RXD	←	3	TXD
4	FREE		4	FREE
5	SIGNAL GROUND	—	5	SIGNAL GROUND
6	FREE		6	FREE
7	FREE		7	FREE
8	FREE		8	FREE
9	FREE		9	FREE

RS-485 pin assignment

Both RS-485 sockets are equally wired.

Pin 1: GND

Pin 3: RS485 + (A)

Pin 6: RS485 - (B)

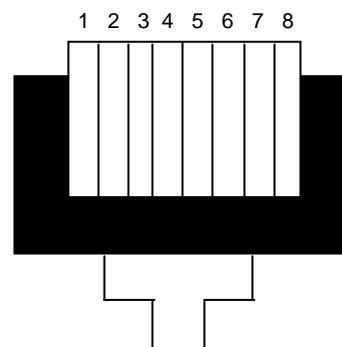

Illustration: contact side RJ-45 plug

2. Interface settings

For the RS232/485 port, 6 different speeds are available: 1200, 2400, 4800, 9600, 19200 and 38400 baud. Define the port settings in the RS232/RS485 menu.

APPENDIX C: Remote control protocol

3. Remote control protocol

The following remote control protocol applies to RS232 and RS485 remote control. The EEPBus protocol is a universal control protocol for EDSR and EDR (MPEG4) series' digital video recorders. Therefore, it may occur that some of the following commands are not available for all DVR types.

1-1. Sample control code packets

Example 1 : A packet that sends "**REC**" key to DVR (ID=5)

0x85	(length)
0x00	(Receiver ID high byte)
0x05	(Receiver ID low byte)
0x4B	(OPcode = key)
0x08	(DATA1 = "Rec" keycode)
0x5D	(checksum)

Example 2 : A packet that sends "**PAUSE**" key to DVR (ID=4999)

0x85	(length)
0x27	(Receiver ID high byte)
0x07	(Receiver ID low byte)
0x4B	(OPcode = key)
0x0C	(DATA1 = "Pause" keycode)
0x0A	(checksum)

Example3 : A packet that sends "**PLAY**" key to all DVR (broadcast)

0x85	(length)
0x7f	(Receiver ID high byte)
0x7f	(Receiver ID low byte)
0x4B	(OPcode = key)
0x0B	(DATA1 = "Play" keycode)
0x59	(checksum)

APPENDIX C: Remote control protocol

2-1. The format of message packet is as follows:

Length Byte (Prefix: 0x86, 0x87, or 0x88)

Receiver ID high byte

Receiver ID low byte

Opcode Byte

Data Byte1

Data Byte2

Data Byte3

Checksum Byte

2-2. Length Byte

This Length Byte is also a prefix. Bit7 must be 1.

EX: 0x87 ==> this packet has 7 bytes length. (not included length byte itself)

APPENDIX C: Remote control protocol

2-3. Receiver ID

1.) Individual receiver ID

Decimal	14bit binary value	Hbyte	Lbyte	Receiver ID (EDSR)
0	0000000 0000000	00	00	ID = 0
1	0000000 0000001	00	01	ID = 1
2	0000000 0000010	00	02	ID = 2
....				
126	0000000 1111110	00	7e	ID = 126
127	0000000 1111111	00	7f	ID = 127
128	0000001 0000000	01	00	ID = 128
129	0000001 0000001	01	01	ID = 129
255	0000001 1111111	01	7f	ID = 255
256	0000010 0000000	02	00	ID = 256
....				
511	0000011 1111111	03	7f	ID = 511
....				
16382	1111111 1111110	7f	7e	ID = 16382

2.) Broadcast ID

Decimal	14bit binary value	Hbyte	Lbyte	Receiver ID
16383	1111111 1111111	7f	7f	all DVR connect to RS485/RS232

APPENDIX C: Remote control protocol

2-4. Opcode Byte & Data bytes

2-4-1. Opcode

OPcode	Data1	Function
0x4B	Keycode	A remote key pressed
0x4D	command	Matrix command

2-4-2. Remote keys (OPcode=0x4B)

Data1	Key	Data1	Key
0x00	CH1	0x1e	JOG<
0x01	CH2	0x1f	JOG>
0x02	CH3	0x20	CH5
0x03	CH4	0x21	CH6
0x04	MODE	0x22	CH7
0x05	ZOOM	0x23	CH8
0x06	SEQ	0x24	CH9
0x07	MENU	0x25	CH10
0x08	REC	0x26	CH11
0x09	REV.PLAY	0x27	CH12
0x0A	STOP	0x28	CH13
0x0B	PLAY	0x29	CH14
0x0C	PAUSE	0x2a	CH15
0x0D	SEARCH	0x2b	CH16
0x0E	COPY	0x2c	SELECT
0x0F	DISPALY	0x2d	CALL
0x10	SHUTTLE<<x1	0x2e	ENTER
0x11	SHUTTLE<<x2	0x2f	(reserve)
0x12	SHUTTLE<<x4	0x30	(reserve)
0x13	SHUTTLE<<x8	0x31	(reserve)
0x14	SHUTTLE<<x16	0x32	(reserve)
0x15	SHUTTLE<<x32	0x33	(reserve)
0x16	SHUTTLE<<x600	0x34	(reserve)
0x17	SHUTTLE>>x1		
0x18	SHUTTLE>>x2		
0x19	SHUTTLE>>x4		
0x1a	SHUTTLE>>x8		
0x1b	SHUTTLE>>x16		
0x1c	SHUTTLE>>x32		
0x1d	SHUTTLE>>x600		

APPENDIX C: Remote control protocol

2-4-3. Matrix command (OPcode=0x4D)

Data1	Matrix function	Data1	Matrix function	Data1	Matrix function
0x00	Matrix monitor0 - ch01 spot	0x21	Matrix monitor2 - ch02 spot	0x42	Matrix monitor4 - ch03 spot
0x01	Matrix monitor0 - ch02 spot	0x22	Matrix monitor2 - ch03 spot	0x43	Matrix monitor4 - ch04 spot
0x02	Matrix monitor0 - ch03 spot	0x23	Matrix monitor2 - ch04 spot	0x44	Matrix monitor4 - ch05 spot
0x03	Matrix monitor0 - ch04 spot	0x24	Matrix monitor2 - ch05 spot	0x45	Matrix monitor4 - ch06 spot
0x04	Matrix monitor0 - ch05 spot	0x25	Matrix monitor2 - ch06 spot	0x46	Matrix monitor4 - ch07 spot
0x05	Matrix monitor0 - ch06 spot	0x26	Matrix monitor2 - ch07 spot	0x47	Matrix monitor4 - ch08 spot
0x06	Matrix monitor0 - ch07 spot	0x27	Matrix monitor2 - ch08 spot	0x48	Matrix monitor4 - ch09 spot
0x07	Matrix monitor0 - ch08 spot	0x28	Matrix monitor2 - ch09 spot	0x49	Matrix monitor4 - ch10 spot
0x08	Matrix monitor0 - ch09 spot	0x29	Matrix monitor2 - ch10 spot	0x4a	Matrix monitor4 - ch11 spot
0x09	Matrix monitor0 - ch10 spot	0x2a	Matrix monitor2 - ch11 spot	0x4b	Matrix monitor4 - ch12 spot
0x0a	Matrix monitor0 - ch11 spot	0x2b	Matrix monitor2 - ch12 spot	0x4c	Matrix monitor4 - ch13 spot
0x0b	Matrix monitor0 - ch12 spot	0x2c	Matrix monitor2 - ch13 spot	0x4d	Matrix monitor4 - ch14 spot
0x0c	Matrix monitor0 - ch13 spot	0x2d	Matrix monitor2 - ch14 spot	0x4e	Matrix monitor4 - ch15 spot
0x0d	Matrix monitor0 - ch14 spot	0x2e	Matrix monitor2 - ch15 spot	0x4f	Matrix monitor4 - ch16 spot
0x0e	Matrix monitor0 - ch15 spot	0x2f	Matrix monitor2 - ch16 spot	0x50	Matrix monitor0 - sequence
0x0f	Matrix monitor0 - ch16 spot	0x30	Matrix monitor3 - ch01 spot	0x51	Matrix monitor1 - sequence
0x10	Matrix monitor1 - ch01 spot	0x31	Matrix monitor3 - ch02 spot	0x52	Matrix monitor2 - sequence
0x11	Matrix monitor1 - ch02 spot	0x32	Matrix monitor3 - ch03 spot	0x53	Matrix monitor3 - sequence
0x12	Matrix monitor1 - ch03 spot	0x33	Matrix monitor3 - ch04 spot	0x54	Matrix monitor4 - sequence
0x13	Matrix monitor1 - ch04 spot	0x34	Matrix monitor3 - ch05 spot	0x60	Matrix monitor0 - turn OSD on
0x14	Matrix monitor1 - ch05 spot	0x35	Matrix monitor3 - ch06 spot	0x61	Matrix monitor1 - turn OSD on
0x15	Matrix monitor1 - ch06 spot	0x36	Matrix monitor3 - ch07 spot	0x62	Matrix monitor2 - turn OSD on
0x16	Matrix monitor1 - ch07 spot	0x37	Matrix monitor3 - ch08 spot	0x63	Matrix monitor3 - turn OSD on
0x17	Matrix monitor1 - ch08 spot	0x38	Matrix monitor3 - ch09 spot	0x64	Matrix monitor4 - turn OSD on
0x18	Matrix monitor1 - ch09 spot	0x39	Matrix monitor3 - ch10 spot	0x70	Matrix monitor0 - turn OSD off
0x19	Matrix monitor1 - ch10 spot	0x3a	Matrix monitor3 - ch11 spot	0x71	Matrix monitor1 - turn OSD off
0x1a	Matrix monitor1 - ch11 spot	0x3b	Matrix monitor3 - ch12 spot	0x72	Matrix monitor2 - turn OSD off
0x1b	Matrix monitor1 - ch12 spot	0x3c	Matrix monitor3 - ch13 spot	0x73	Matrix monitor3 - turn OSD off
0x1c	Matrix monitor1 - ch13 spot	0x3d	Matrix monitor3 - ch14 spot	0x74	Matrix monitor4 - turn OSD off
0x1d	Matrix monitor1 - ch14 spot	0x3e	Matrix monitor3 - ch15 spot		
0x1e	Matrix monitor1 - ch15 spot	0x3f	Matrix monitor3 - ch16 spot		
0x1f	Matrix monitor1 - ch16 spot	0x40	Matrix monitor4 - ch01 spot		
0x20	Matrix monitor2 - ch01 spot	0x41	Matrix monitor4 - ch02 spot		

2-5. Checksum Byte

Checksum is computed as the sum of all previous bytes (including the length byte), then mask with 0x7f.

APPENDIX D: Recording times

Average recording times, based on 100GB harddisk capacity.

Using the VBR (Variable Bit Rate) method, the storage requirement per image depends on the image's colour and contrast content and captured motion.

The following calculations represent sample values for continuous recording. Actually achieved values may differ and can be calculated by means of test recordings if required.

The value IMAGES/S refers to the total DVR recording rate (all installed cameras).

CALCULATION BASE: **100 GB** harddisk capacity

RESOLUTION: **720x288 (Half-D1)**

RECORDING	IMAGE SIZE (KB)					
RATE	LOWER	LOW	BASIC	STANDARD	HIGH	SUPERIOR
Images / s	3,5	3,9	4,2	4,9	5,6	6,4
	RECORDING TIME (HOURS)					
200	39	35	33	28	24	21
100	79	71	66	56	49	43
50	159	142	132	113	99	87
25	317	285	265	227	198	174
8	992	890	827	709	620	543
4	1984	1781	1653	1417	1240	1085
1	7937	7123	6614	5669	4960	4340

RESOLUTION: **720x576 (D1)**

RECORDING	IMAGE SIZE (KB)					
RATE	LOWER	LOW	BASIC	STANDARD	HIGH	SUPERIOR
Images / s	7	8	8,5	10	11,2	12,5
	RECORDING TIME (HOURS)					
100	39	34	33	27	24	22
50	79	69	66	55	49	44
25	159	139	131	111	99	89
8	496	434	408	347	310	278
4	992	868	817	694	620	556
1	3968	3472	3268	2778	2480	2222

RESOLUTION: **360x288 (CIF)**

RECORDING	IMAGE SIZE (KB)					
RATE	LOWER	LOW	BASIC	STANDARD	HIGH	SUPERIOR
Images / s	2	2,3	3	3,8	4,3	4,6
	RECORDING TIME (HOURS)					
400	35	30	23	18	17	15
200	69	60	46	36	33	30
100	139	121	93	73	65	60
50	278	242	185	146	129	121
25	556	483	370	292	258	242
8	1736	1510	1157	914	807	755

EverFocus Electronics Corp.

Head Office:

12F, No.79 Sec. 1 Shin-Tai Wu Road,
Hsi-Chih, Taipei, Taiwan
www.everfocus.com.tw

USA Office:

1801 Highland Ave. Unit A
Duarte, CA 91010, U.S.A.
www.everfocus.com

European Office:

Albert-Einstein-Straße 1
D-46446 Emmerich, Germany
www.everfocus.de

China Office:

Room 609, Technology Trade Building,
Shandgdi Information Industry Base,
Haidian District, Beijing, China
www.everfocus.com.cn

Japan Office:

1809 WBG MARIBU East 18F,
2-6 Nakase.Mihama-ku.
Chiba city 261-7118, Japan
www.everfocus.com



EDR920_1640_de_rev1.01

Free Manuals Download Website

<http://myh66.com>

<http://usermanuals.us>

<http://www.somanuals.com>

<http://www.4manuals.cc>

<http://www.manual-lib.com>

<http://www.404manual.com>

<http://www.luxmanual.com>

<http://aubethermostatmanual.com>

Golf course search by state

<http://golfingnear.com>

Email search by domain

<http://emailbydomain.com>

Auto manuals search

<http://auto.somanuals.com>

TV manuals search

<http://tv.somanuals.com>