



User Manual



ENDEAVOR SD+HD DVR (EDR HD-2H14 / 4H4)

EVERFOCUS ELECTRONICS CORPORATION
ENDEAVOR SD+HD DVR

Instruction Manual

© 2010 EverFocus Electronics Corp
www.everfocus.com

All rights reserved. No part of the contents of this manual may be reproduced or transmitted in any form or by any means without written permission of the Everfocus Electronics Corporation.

Release Date: Feb. 2011

QuickTime is a registered trademark of the Apple Computer, Inc.

Windows is a registered trademark of the Microsoft Corporation.

Linksys is a registered trademark of the Linksys Corporation.

D-Link is a registered trademark of the D-Link Corporation.

DynDNS is a registered trademark of the DynDNS.org Corporation.

Other product and company names mentioned herein may be the trademarks of their respective owners.

Safety Precautions

- Refer all work related to the installation of this product to qualified service personnel or system installers.
- Do not block the ventilation openings or slots on the cover.
- Do not drop metallic parts through slots. This could permanently damage the appliance. Turn the power off immediately and contact qualified service personnel for service.
- Do not attempt to disassemble the appliance. To prevent electric shock, do not remove screws or covers. There are no user-serviceable parts inside. Contact qualified service personnel for maintenance. Handle the appliance with care. Do not strike or shake, as this may damage the appliance.
- Do not expose the appliance to water or moisture, nor try to operate it in wet areas. Do take immediate action if the appliance becomes wet. Turn the power off and refer servicing to qualified service personnel. Moisture may damage the appliance and also may cause electric shock.
- Do not use strong or abrasive detergents when cleaning the appliance body. Use a dry cloth to clean the appliance when it is dirty. When the dirt is hard to remove, use a mild detergent and wipe gently.
- Do not overload outlets and extension cords as this may result in a risk of fire or electric shock.
- Do not operate the appliance beyond its specified temperature, humidity or power source ratings. Do not use the appliance in an extreme environment where high temperature or high humidity exists. Use the DVR at indoor type temperatures within 0°C~40°C (32°F~104°F) and at relative humidity between 20%~80%. The input power source for this device is 12VDC though a power supply which operates from 100~240VAC.
- **Read Instructions**
All the safety and operating instructions should be read before the unit is operated.
- **Retain Instructions**
The safety and operating instructions should be retained for future reference.
- **Heed Warnings**
All warnings on the unit and in the operating instructions should be adhered to.
- **Follow Instructions**
All operating and use instructions should be followed.
- **Cleaning**

Unplug the unit from the outlet before cleaning. Do not use liquid cleaners, abrasive or aerosol cleaners. Use a damp cloth for cleaning

➤ **Attachments**

Do not use attachments not recommended by the product manufacturer as they may cause hazards.

➤ **Water and Moisture**

Do not use this unit near water-for example, near a bath tub, wash bowl, kitchen sink, or laundry tub, in a wet basement, near a swimming pool, in an unprotected outdoor installation, or any area which is classified as a wet location.

➤ **Servicing**

Do not attempt to service this unit by yourself as opening or removing covers may expose you to dangerous voltage or other hazards. Refer all servicing to qualified service personnel.

➤ **Power Cord Protection**

Power supply cords should be routed so that they are not likely to be walked on or pinched by items placed upon or against them, paying particular attention to cords and plugs, convenience receptacles, and the point where they exit from the appliance.

➤ **Object and Liquid Entry**

Never push objects of any kind into this unit through openings as they may touch dangerous voltage points or short-out parts that could result in a fire or electric shock. Never spill liquid of any kind on the unit.

"Rack Mount Instructions - The following or similar rack-mount instructions are included with the installation instructions:

A) Elevated Operating Ambient - If installed in a closed or multi-unit rack assembly, the operating ambient temperature of the rack environment may be greater than room ambient. Therefore, consideration should be given to installing the equipment in an environment compatible with the maximum ambient temperature (T_{ma}) specified by the manufacturer.

B) Reduced Air Flow - Installation of the equipment in a rack should be such that the amount of air flow required for safe operation of the equipment is not compromised.

C) Mechanical Loading - Mounting of the equipment in the rack should be such that a hazardous condition is not achieved due to uneven mechanical loading.

D) Circuit Overloading - Consideration should be given to the connection of the equipment to the supply circuit and the effect that overloading of the circuits might have on overcurrent protection and supply wiring. Appropriate consideration of equipment nameplate ratings should be used when addressing this concern.

E) Reliable Earthing - Reliable earthing of rack-mounted equipment should be maintained. Particular attention should be given to supply connections other than direct connections to the branch circuit (e.g. use of power strips)."



ATTENTION! This is a class A product which may cause radio interference in a domestic environment; in this case, the user may be urged to take adequate measures.



Federal Communication Commission Interference Statement

This equipment has been tested and found to comply with the limits for a Class B digital device, pursuant to Part 15 of the FCC Rules. These limits are designed to provide reasonable protection against harmful interference in a residential installation. This equipment generates, uses and can radiate radio frequency energy and, if not installed and used in accordance with the instructions, may cause harmful interference to radio communications. However, there is no guarantee that interference will not occur in a particular installation. If this equipment does cause harmful interference to radio or television reception, which can be determined by turning the equipment off and on, the user is encouraged to try to correct the interference by one of the following measures :

- Reorient or relocate the receiving antenna.
- Increase the separation between the equipment and receiver.
- Connect the equipment into an outlet on a circuit different from that to which the receiver is connected.
- Consult the dealer or an experienced radio/TV technician for help.

FCC Caution: Any changes or modifications not expressly approved by the party responsible for compliance could void the users' authority to operate this equipment.



WEEE



This Product is RoHS compliant.

The information in this manual was current upon publication. The manufacturer reserves the right to revise and improve his products. Therefore, all specifications are subject to change without prior notice. Manufacturer is not responsible for misprints or typographical errors.

Please read this manual carefully before installing and using this unit. Be sure to keep it handy for later reference.

TABLE OF CONTENTS

1	PRODUCT OVERVIEW	1
1.1	FEATURES	1
1.2	PACKAGE CONTENTS.....	3
1.3	SPECIFICATIONS	4
1.4	FRONT PANEL	6
1.5	REAR PANEL.....	9
2	INSTALLATION.....	11
2.1	HD-CCTV WIRING FOR VIDEO INPUTS	11
2.1.1	<i>Understanding HD-CCTV signals and wiring</i>	<i>11</i>
2.1.2	<i>HD-CCTV signal.....</i>	<i>11</i>
2.1.3	<i>Cable types</i>	<i>12</i>
2.1.4	<i>Cable installation</i>	<i>13</i>
2.1.5	<i>BNC-plug.....</i>	<i>13</i>
2.1.6	<i>Extended cable lengths with repeater EHA-RPT / converter EHA-SRX</i>	<i>13</i>
2.1.7	<i>Extended cable lengths with fiber optics transmission.....</i>	<i>14</i>
2.1.8	<i>MONITOR INSTALLATION.....</i>	<i>15</i>
2.2	AUDIO INSTALLATION	15
2.3	ALARM CONTACTS INSTALLATION	16
2.3.1	<i>Alarm Input Contacts</i>	<i>16</i>
2.3.2	<i>Alarm Output Relay.....</i>	<i>16</i>
2.4	RS-485 KEYBOARD / PTZ INSTALLATION.....	16
2.4.1	<i>General RS-485 bus installation</i>	<i>17</i>
2.4.2	<i>RS-485 ports.....</i>	<i>18</i>
2.4.3	<i>EKB-500 connection with network patch cable.....</i>	<i>18</i>
2.4.4	<i>EKB-500 connection to several DVRs.....</i>	<i>18</i>
2.4.5	<i>Speed Dome Installation</i>	<i>18</i>
2.5	USB-MOUSE INSTALLATION	19
2.6	NETWORK CONNECTION	19
2.6.1	<i>Direct PC Connection through Crossover Network Cable</i>	<i>19</i>
2.6.2	<i>Network Connection through Patch Cable.....</i>	<i>20</i>
2.7	FINAL INSTALL PROCESS.....	21
3	MOUSE AND FRONT PANEL OPERATION	22
3.1	GENERAL USB MOUSE OPERATION	22
3.1.1	<i>How to select a channel / Enable audio</i>	<i>22</i>
3.1.2	<i>OSD Root Menu.....</i>	<i>22</i>
3.1.3	<i>Operation in the Configuration Menus</i>	<i>23</i>
3.1.4	<i>Field Input Options</i>	<i>23</i>
2.2	GENERAL FRONT PANEL OPERATION	25
2.2.1	<i>How to select a channel / Enable audio</i>	<i>25</i>
2.2.2	<i>OSD Root Menu</i>	<i>25</i>
2.2.3	<i>Front Panel Key Review.....</i>	<i>25</i>

2.2.4	Operation in Configuration Menu.....	25
2.2.5	Field Input Options	26
3.	GENERAL DVR OPERATIONS.....	28
3.1	RECORD.....	28
3.2	LOGIN.....	28
3.3	SELECT CAMERA OPERATION.....	29
3.5	PLAYBACK.....	30
3.6	PTZ.....	31
3.6.1	General PTZ control (if PTZ cameras are installed).....	31
3.6.2	Express Control of PTZ.....	32
3.7	LAYOUT.....	34
3.7.1	Bring a camera to full screen mode.....	34
3.8	CHANNEL SWITCHING.....	34
3.9	DISPLAY	35
3.10	SEQUENCE.....	35
3.11	ZOOM.....	35
3.12	SEARCH.....	36
3.12.1	Time Search.....	37
3.12.2	Event Search.....	37
3.12.3	Smart Search.....	38
3.12.4	Snapshot Search.....	41
3.13	COPY	43
3.14	LOGOUT	44
4	DVR CONFIGURATION.....	45
4.1	CONFIGURATION MENU.....	45
4.2	EXPRESS	45
4.3	CAMERA SETTING	48
4.3.1	Basic Setting.....	48
4.3.2	Video Adjust (apply to analog camera only).....	50
4.3.3	Motion	51
4.3.4	Video Loss	54
4.4	RECORD & PLAY SETTING.....	56
4.4.1	Record	56
4.4.2	Built-in Calculator	57
4.4.3	Play	58
4.5	ALARM & EVENT SETTING.....	59
4.5.1	Alarm.....	59
4.5.2	Event.....	61
4.6	SCHEDULE SETTING.....	69
4.6.1	Express Setup	69
4.6.2	Holidays	70
4.6.3	Schedule	71
4.6.4	Alarm Action	76
4.7	NETWORK SETTING.....	80
4.7.1	LAN	80
4.7.2	EMAIL.....	82

4.7.3	<i>DDNS</i>	83
4.7.4	<i>Alarm Server</i>	85
4.7.5	<i>Network Test</i>	86
4.8	DISK INFORMATION	87
4.8.1	<i>Disk</i>	87
4.8.2	<i>Lock/Format</i>	88
4.9	DISPLAY SETTING	89
4.9.1	<i>Monitor OSD</i>	89
4.9.2	<i>Main M/T SEQ</i>	90
4.10	SYSTEM SETTING	91
4.10.1	<i>Date/Time</i>	91
4.10.2	<i>Daylight Saving</i>	92
4.10.3	<i>User</i>	93
4.10.4	<i>I/O Control</i>	96
4.10.5	<i>Misc</i>	97
4.11	INFORMATION	99
4.11.1	<i>System</i>	99
4.11.2	<i>Log</i>	100
5	NETWORKING OVERVIEW	102
5.1	INTRODUCTION TO TCP/IP	102
5.2	SUBNET MASKS	102
5.3	GATEWAY ADDRESS.....	102
5.4	VIRTUAL PORTS.....	103
5.5	PRE-INSTALLATION	103
5.6	WHAT IS YOUR NETWORK SETUP?.....	104
5.7	SIMPLE ONE TO ONE CONNECTION.....	105
5.8	DIRECT HIGH SPEED MODEM CONNECTION	110
5.9	ROUTER OR LAN CONNECTION	112
6	REMOTE OPERATION FROM BROWSER	115
6.1	CONNECTING TO ENDEAVOR SD+HD	115
6.2	BROWSER SECURITY SETTING	116
6.2.1	<i>Installing ActiveX controls</i>	116
6.2.1	<i>Enabling ActiveX Controls</i>	119
6.3	REMOTE LIVE VIEW	122
6.4	REMOTE PLAYBACK	124
7	EVERFOCUS DDNS SETUP	125
8	LINKSYS & D-LINK PORT FORWARDING	127
8.2	TYPICAL LINKSYS PORT FORWARDING	127
8.3	TYPICAL D-LINK PORT FORWARDING	129
9	TROUBLESHOOTING	132
	APPENDIX A: TIMING OF ALARM MODES	134
	APPENDIX B: EXPRESS SETUP RECORDING VALUE SELECTION RULES	137

APPENDIX C: REMOTE CONTROL..... 139

1 PRODUCT OVERVIEW

Begin your migration to the High Definition revolution in CCTV technology *without changing your installation methods. For definitive identification in critical areas, capture scenes with stunning HD clarity*; for traditional applications connect standard definition analog CCTV cameras. Carry uncompressed full motion MEGAPIXEL DIGITAL and analog NTSC video back to their respective inputs on the ENDEAVOR HD+SD DVR over standard coaxial cable*! *Attach familiar BNC connectors* to both HD-CCTV and analog cameras and to the ENDEAVOR HD+SD DVR, then display live and recorded images in astounding detail on the HDMI main monitor screen. HD-CCTV with up to *6 times the resolution* of the analog cameras delivers the ability to *zoom with clarity*. HD images are so detailed, each sends a 1.5Gb/s uncompressed *digital video* signal over the coax; the Endeavor HD – 2H14 DVR can process that total of 3Gb/s from 2 HD-CCTV cameras, as well as the video from 14 analog cameras, for live viewing and H.264 recording at HD resolutions of 1080p (~2 megapixel @ 15 fps/camera) or 720p (~1 megapixel @ real time 30fps/camera), plus *real time 30FPS at D1 recording capability on all 14 analog cameras*. Dedicated mega-bandwidth coax signal paths from each HD camera to this HD Hybrid DVR eliminate the need for compression, addressing, and complex network design.

The ENDEAVOR HD+SD DVR is a powerful, full featured, embedded DVR with all the capabilities, familiar front panel controls, user friendly mouse driven Graphical User Interface, plug-and play ease of installation and setup and proven, reliable Linux based operating system that you expect from a state of the art EverFocus DVR. More than that, it is designed and built in our factory, backed by our Support Team, and carries our standard three year DVR warranty (including the hard drives). Start adding some High Definition Security Surveillance to your systems at your own pace, with a name you know and trust: the **ENDEAVOR HD+SD DVR** from Everfocus Electronics puts the future in your hands – TODAY!

*Up to 500' nominal for digital signals on RG59; more with lower loss cable and/or optional repeaters.

1.1 FEATURES

- Both HD-CCTV Megapixel Video Inputs and Analog Video Inputs
- Choose 720p or 1080p HD resolution recording for HD-CCTV Video Inputs up to 30 FPS/camera
- H.264 Compression format to minimize optimize disk space consumption
- Dual streaming to optimize remote viewing bandwidth utilization
- Real time recording rate and playback rate – up to 30fps@D1 on analog and 30fps@HD on HD-CCTV
- Recording resolution and rate can be set independently for each camera, and changed via user defined schedule
- Multiple Main Monitors : HDMI 1080p / VGA (1920x1080) output for stunning image clarity
- Pentaplex Operation (Simultaneous live, recording, playback, archiving and remote viewing)

- User friendly GUI with graphical icons and visual indicators
- Free EverFocus DDNS Service static IP address is not required for reliable remote access
- Supports eSATA external HDD array (EDA450)
- Supports remote/mobile monitoring via PC browsers, SmartPhones and iPhone/Android apps
- Multiple Control Inputs: mouse/front panel/ IR remote control/EKB500 keyboard
- Express Setup: A unique menu option for quick & easy installation and setup
- Express Playback: Simply point, click and drag the playback bar to view desired recordings
- Express Archive: Archive video instantly (to USB) while playing back
- Express Search: Use the intuitive playback bar with simple drag & drop operations
- Smart Search: Review recorded video to identify motion in area(s) of interest
- Snapshot search: choose an interval and direction, view a series of snapshots to quickly isolate incidents
- Remote configuration support from built-in web interface
- Gigabit Ethernet interface for remote network viewing and control
- Audio recording capabilities
- Up to 4 internal HDDs
- Built-in DVD burner
- 2 USB 2.0 ports for video archive and mouse usage
- Multi-language support
- Watermark capabilities to identify intentional modifications of recorded data
- Compatible with FREE EverFocus Central Management Software
- USB Mouse and IR remote control included
- 19" Rack mountable – rack ears included

1.2 PACKAGE CONTENTS

Standard Package

- Digital Video Recorder x1
- User Manual x 1
- Power Cord x1
- Mouse x 1
- 19" Rack mounting adapters (pair) x 1
- Terminal Block x 5
- IR Remote Control x 1
- Battery x 2
- Audio-in connector (D-sub to RCA) x 1
- HDD Fixing Bracket x 4 set
- SATA cable x 4
- Screws x 16 for HDD
- Screws x 8 for HDD fixing bracket

1.3 SPECIFICATIONS

ENDEAVOR HD+SD DVR			
		EDR HD-2H14	EDR HD-4H4
HD-CCTV Camera Inputs		2 BNC SMPTE292m compliant	4 BNC SMPTE292m compliant
Analog Camera Inputs		14 BNC	4 BNC
Looping Analog Camera Outputs		14 BNC	4 BNC
Compression Format		H.264	
Dual Streaming		Yes (Configurable)	
HD Recording Rate/Resolution <small>Choose one resolution for both channels</small>	1080p	30fps NTSC / 25ps PAL	60fps NTSC / 50ps PAL
	720p	60fps NTSC / 50ps PAL	120fps NTSC / 100ps PAL
Analog Recording Rate/Resolution <small>Resolution and rate can be set independently per camera up to the total D1 recording capacity</small>	D1	420fps NTSC / 350ps PAL	120fps NTSC / 100ps PAL
HD Playback Rate/Resolution	1080p	Up to 30fps NTSC / 25fps PAL	Up to 60fps NTSC / 50fps PAL
	720p	Up to 60fps NTSC / 50fps PAL	Up to 120fps NTSC / 100fps PAL
Analog Playback Rate/Resolution	D1	Up to 420fps NTSC / 350fps PAL	Up to 120fps NTSC / 100fps PA
Mobile View	Live view on PDA or Smart Phones (MobleFocus FREE app for iPhone® and Android™) plus various web browsers		
Pentaplex Operation	Simultaneous Live, Recording, Playback, Archive and Remote Viewing		
Main Monitor Outputs <small>(simultaneous display)</small>	1080p HDMI (socket Type A 19 pin female) and VGA 1920 x 1080 @ 60 Hz (D-Sub socket 15 pin female)		
Audio Inputs	16 Inputs (RCA, line level)	8 Inputs (RCA, line level)	
Audio Outputs	2 Outputs (RCA, line level)		
Recording Modes	Manual, Schedule and Event		
Playback Search	Date/Time, Event, Tex, Smart, Snapshot		
Alarm Inputs	16	8	
Alarm Outputs	4 Alarm Outputs – Form "C" rated at 30VDC, 1A		
Video Pause	Yes		
Video Loss Detection	Yes		
Motion Detection	Yes		
Event Log	Yes		
Watch Dog Timer	Yes		
Internal HDD Support	4 Internal HDD (up to 8Tb max at time of printing)		
External HDD Support	1 eSATA		
DVD Drive	DVD RW Built In		
User Interface	Color GUI (Graphical User Interface)		
OS	Embedded Linux		
Network/Protocol	Gigabit Ethernet; TCP-IP / DHCP/ PPPoE / DDNS / UDP / SMTP / SSL / HTTP / NTP/ ICMP / ARP		
Control PTZ via OSD	Local and via web interface		

USB	2 Front Panel USB 2.0 port
Schedule Setting	Support Express and Advanced Schedule Setting
User Access	3 Levels of User Access Support
RS-232	9-pin D-Sub socket (male)
RS-485	1 RS485 (2 RJ45 connector)
Power Source	100VAC~240VAC
Power Consumption	110W max. with 4 x HDD
Dimensions (L x W x H)	423 x 430 x 79.5 mm / 16.6" x 16.9" x 3.2"
Temperature	0°C~40°C / 32°F~104°F (20~80% humidity)
Certificates	CE, FCC, UL (pending)
Supported PTZ Protocols	EverFocus, Pelco D, Pelco P, Samsung, Transparent

1.4 FRONT PANEL

Your primary interaction with your new DVR will be through the Front Panel buttons and their corresponding buttons on the included IR Remote Control. Take a moment to learn where the keys are as the remainder of the manual will refer to them often.

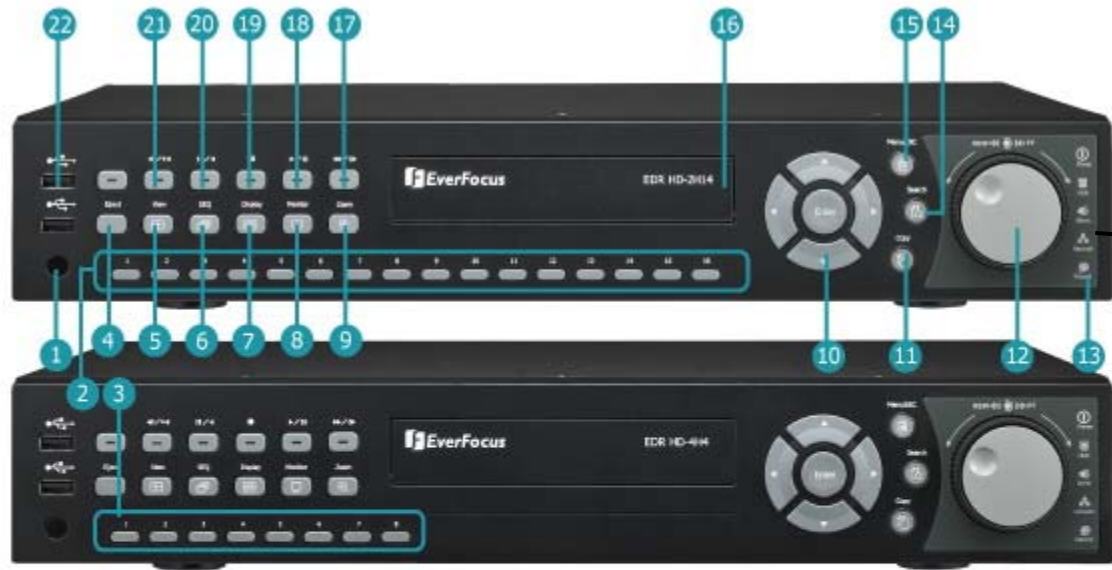

- | | | |
|--|-------------------------|-------------------------|
| 1 Remote Control Receiver | 9 Zoom | 17 FF / Next Step |
| 2 Channel Key (1~16 CH) (2H14 CH only) | 10 Menu Navigation Keys | 18 Play / Pause |
| 3 Channel Key (1~8 CH) (4H4 CH only) | 11 Copy | 19 Stop |
| 4 DVD Eject | 12 Jog/Shuttle Dials | 20 Pause / Reverse Play |
| 5 View | 13 System LEDs | 21 Prev Step / FR |
| 6 Sequence | 14 Search | 22 USB Ports |
| 7 Display | 15 Menu/ESC | |
| 8 Monitor Control | 16 DVD Burner | |

Figure 1-1 Front Panel

23

1) **Remote Control Receiver:** Receiver for IR remote control

2) **Channel keys 1~16:** Press channel key (**CH1~CH16**) to display that channel in full screen view. CH1~CH14 are analog video. CH15 and CH16 are HD-CCTV video.

3) **Channel keys 1~8:** Press channel key (**CH1~CH8**) to display that channel in full screen view. CH1~CH14 are analog video.

4) **DVD Eject:** Press this button to eject the DVD.

5) **View:** Press this key to switch between 4x, PiP (Picture In Picture), full screen, 6x, 7x, 8x, 9x, 10x, 13x and 16x.

6) **SEQ:** Press this key to enter the auto sequential switching mode. The sequence dwell time can be set in "Display Setting" tab of the Menu.

7) **Display:** Press this key to switch display of channels and status bar.

8) **Monitor:** Switch between Main monitor and Call monitor (Function reserved).

9) **Zoom:** In full screen mode, 2x and 4x electronic zoom. Zoom screen can be moved through arrow keys. Pressing the Menu/ESC key again switches the electronic zoom off.

10) **Menu Navigation Keys:** Instead of or in combination with a mouse, you can use these keys to change the Menu settings.

11) **Copy:** Press this key to enter **Copy Menu**

12) **JOG/SHUTTLE:** Shuttle (outer wheel): In playback mode, use the SHUTTLE for fast forward / fast reverse playback.

JOG (inner wheel): In PAUSE mode, use the jog to move frame by frame. Within menu functions, use the jog to adjust the values / parameters. Use Jog to highlight individual cameras. Use either Shuttle or Jog to switch between MENU parameters.

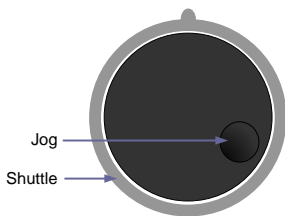

13) System LED

POWER: LED indicating power on

HDD: LED indicating HDD active

Alarm: LED indicating Alarm active

Network: LED for network traffic

Record: LED indicating Record active

14) Search: Press this key to enter Search Menu

15) Menu/ESC: Press this key to enter/exit **MAIN SETUP MENU**

16) DVD burner: DVD+RW burner

17) ►►► /►► : Fast Forward playback or step forward playback depending on playback mode

18) ► /|| : Forward playback or pause

19) ■ : Stop playback

20) ||| /◀ : Reverse playback or pause

21) ◀| /◀◀ : Fast reverse playback or step reverse playback depending on playback mode

22) USB ports: Use one port for connecting USB-Flash-Drive to copy/archive video or for firmware upgrades. Use the other port for connecting the mouse.

23) Ear-mount: Use two M3 screws (φ 6.8) to fix the ear-mount.

1.5 REAR PANEL

During initial setup you will be connecting your DVR to multiple input and output devices. This is done through the rear panel.

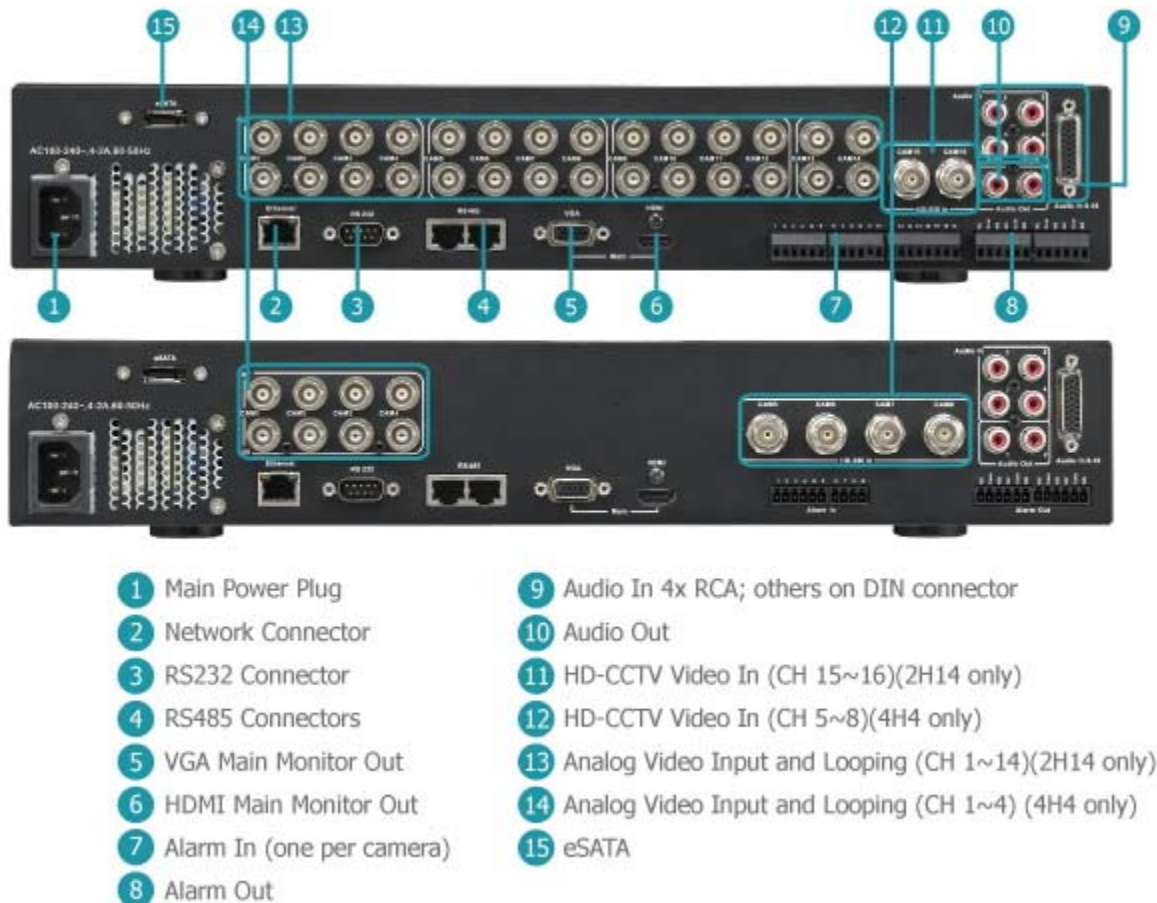

Figure 1-2 Rear Panel

- 1) **Main POWER:** Plug the 120~240VAC power source provided into the power socket.
- 2) **ETHERNET:** RJ-45 network connection 10/100Mbps Ethernet. There are two LEDs on the LAN jack; Green LED means network is connected, amber LED flickers when data is being exchanged.
- 3) **RS232 Connector:** 9-pin D-Sub control input for RS-232.
- 4) **RS485 Connectors:** For remote control via RS-485 keyboards and telemetry control for attached PTZ devices

- 5) **VGA Main Monitor Out:** Connect a VGA monitor to the VGA output connection. DVR can auto detect the best resolution from the connected VGA monitor. If DVR detection fails, the default resolution will be 1920x1080 60Hz vertical, 68 KHz horizontal.
- 6) **HDMI Main Monitor Out:** Provides an uncompressed all-digital video interface between the HD DVR and HDMI-compatible monitor. HDMI output format is 1920x1080p 60Hz vertical, 68 KHz horizontal.
- 7) **Alarm In:** Connect up to 16 alarm inputs, selectable between N.O./N.C. contacts.
- 8) **Alarm Out:** N.C or N.O type alarm out (form "C").
- 9) **Audio In 4x RCA, others on DIN connector:** Connect line level output of an audio preamplifier to the audio input connection corresponding to the appropriate camera.
- 10) **Audio Out:** Connect to the line level input of an audio amplifier.
- 11) **HD-CCTV Video In (CH15~16) (2H14 only):** Connect HD-SDI camera's video output (CH15~16) or other HD-SDI video source to the video input connection.
- 12) **HD-CCTV Video In (CH5~8) (4H4 only):** Connect HD-SDI camera's video output (CH5~8) or other HD-SDI video source to the video input connection.
- 13) **Analog Video Input and looping (CH1~14) (2H14 only):** Connect camera's video output (CH1~14) or other composite video source to the video input connection.
- 14) **Analog Video Input and looping (CH1~4) (4H4 only):** Connect camera's video output (CH1~4) or other composite video source to the video input connection.
- 15) **eSATA:** Used for external SATA HDD bay. *Note: Hot-swappable model does not support eSATA.*

2 Installation

2.1 HD-CCTV wiring for video inputs

2.1.1 Understanding HD-CCTV signals and wiring

Even if EverFocus HD-CCTV equipment uses coaxial cable and BNC type plugs similar to standard CCTV technology - the requirements for wiring and cable types are some different.

This chapter explains some basic facts for HD-CCTV signals and cable requirements.

2.1.2 HD-CCTV signal

In result to the high resolution and uncompressed image transmission from the camera high frequencies are used for HD-CCTV signal transmission.

EverFocus HD-CCTV technology is mostly based on the SMPTE-292M standard, which defines HD-SDI (**H**igh **D**efinition - **S**erial **D**igital Interface) video transmission.

In classic CCTV video standards PAL/NTSC the frequency bandwidth is < 6MHz for high resolution cameras.

HD-CCTV works with up to 1.5 GHz, so this technology requires ~ 250 times higher frequency than PAL/NTSC based CCTV.

The figure below shows the basic timing and signal levels of a full HD (1920x1080) signal:

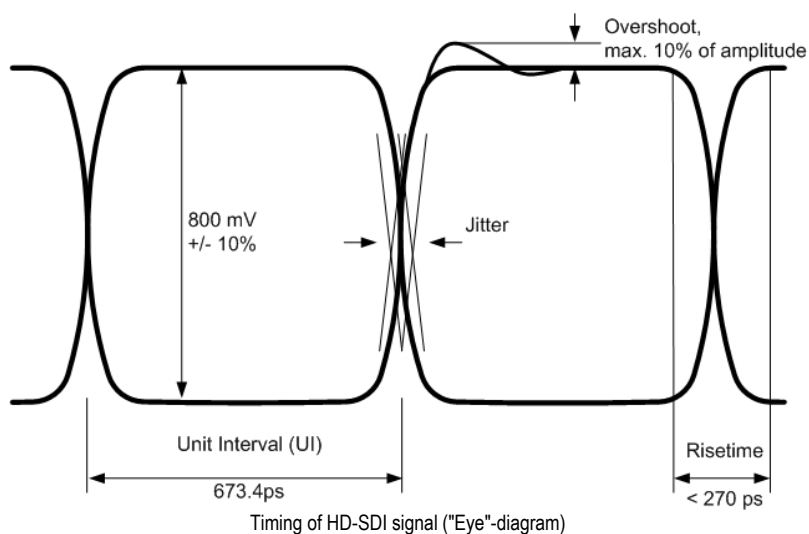

The diagram shows the total difference of HD-CCTV signals to classic NTSC or PAL signals.

Well known signal parts such as Sync, Burst and others do not exist here.

The high frequencies do not allow a signal evaluation by standard oscilloscopes or other standard video measurement tools. Only quite expensive HD-SDI analyzers and upscale HF - oscilloscopes could be used here. In most cases such equipment is not available at installation site.

For this reason a careful specification of the cable type is mandatory for system planning, especially in applications with long cable distances.

2.1.3 Cable types

The short description of HD-SDI signals above explains, why high frequency attenuation of the used video cable has a high influence on the achievable maximum cable length. Further on also the Return Loss of the coaxial cable and plug influences signal stability.

The standard RG-59 cable types - the most common in the CCTV industry - are originally designed for lower frequencies.

However, due to the new optimized receiver interfaces of EverFocus HD-CCTV equipment it is also possible to use standard RG-59 cable for distances of over 100m.

High quality, low loss RG-59 cable types allow distances up to 160m.

Longer cable distances can be achieved with low loss RG-6 or RG-11 type coaxial cables. Generally are cable types with 75 Ω impedance required.

Attenuation at 1 GHz: < 32 dB per 100m (328 feet)

Return Loss attenuation: > 20 dB

Impedance: 75 Ω

The table below gives an orientation for achievable cable distances:

Cable Type	Attenuation in dB at 1 GHz per 100 m / 328 ft	Max. Cable distance in	
		m	ft
RG-59	24 ~ 40 *	70 ~ 160	230~520
RG-6	15 ~ 35 *	100 ~ 190	330~620
RG-11, CATV-lowloss cables	8 ~ 16 *	180 ~< 250	590~<820

* Low quality cable may have higher attenuation

2.1.4 Cable installation

Please make sure, that the coaxial cable is not squeezed at any position.
Also the max. bending radius defined by the cable manufacturer should be considered.

General rule: maximum bending radius = 10 x outer cable diameter

Bending creates pressure on the center conductor, causing it to move through the dielectric toward the inside of the bend. This affects impedance and return loss and reduces the maximum possible cable length.

Please try to avoid any BNC - adapter or any connectors in the BNC cable.
Looping HD-SDI signals by BNC T-connectors to other devices is not possible.

2.1.5 BNC-plug

Also the BNC - plug plays an important role for clear HD-CCTV signal transmission.
Standard BNC plugs for CCTV have a quite high attenuation and may cause return losses due to reflection effects.

We recommend using of HD-Video approved BNC plugs.

2.1.6 Extended cable lengths with repeater EHA-RPT / converter EHA-SRX

The maximum cable distance between camera and DVR and DVR / repeater can be doubled by installing EHA-RPT in the video line. EHA-SRX is a combined HD-SDI cable extender and HD-SDI to HDMI converter.

The HD-SDI output of EHA-SRX allows adding one more complete coaxial cable length.

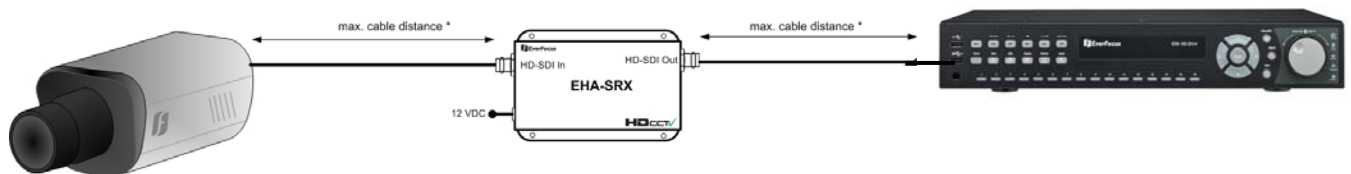

* max. coaxial cable depends on installed cable type

2.1.7 Extended cable lengths with fiber optics transmission

The maximum distance between camera and receiving device can be extended by fiber optics cable. The transmitters and receivers are available for multi-mode and single-mode fiber cables:

- EHA-FTX-MM: Fiber optics transmitter multi-mode, max. transmission distance 500 m
- EHA-FTX-SM: Fiber optics transmitter single-mode, max. transmission distance 21 Km
- EHA-RTX-MM: Fiber optics receiver multi-mode, max. transmission distance 500 m
- EHA-RTX-SM: Fiber optics receiver single-mode, max. transmission distance 21 Km

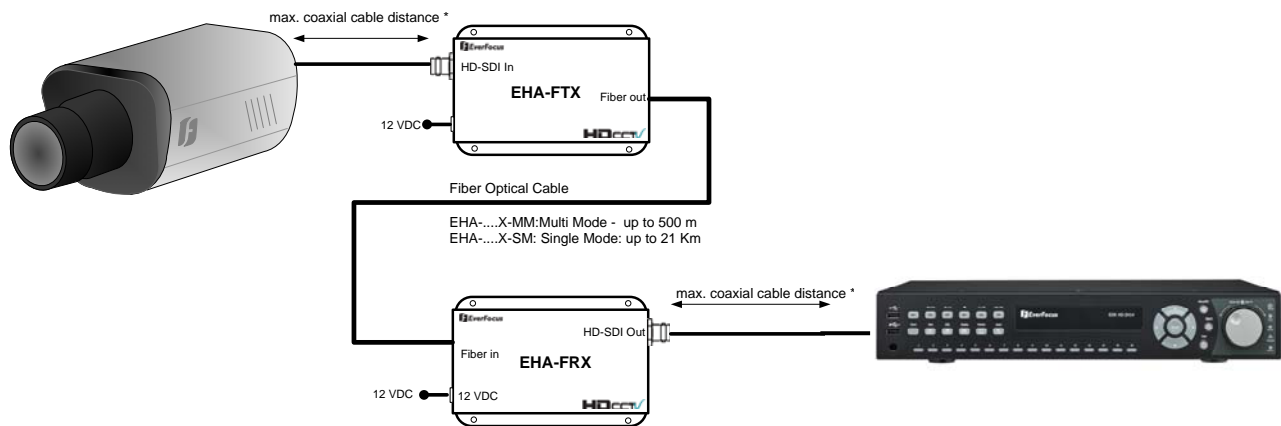

* max. coaxial cable depends on installed cable type

The fiber optics interface of EHA-FTX / EHA-FRX requires LC type plugs for the fiber optics cable.

2.1.8 MONITOR INSTALLATION

The ENDEAVOR SD+HD DVR provides 2 main monitor outputs with identical functionality - VGA and HDMI. Both outputs can be used simultaneously and deliver full HD output resolution (1920x1080, progressive, 60 Hz. vert., 68 KHz hor.).

Make sure that the connected monitor's specifications comply with these resolution requirements.



Please do not exceed the max. HDMI cable length of 15 m.

For cable length up to 3 m standard HDMI cables mostly work well, for longer distances (especially in the 15m range) please use only high quality HDMI cable.

2.2 AUDIO INSTALLATION

EDR HD-2H14 DVR provides 16 line level audio inputs and 2 line level audio outputs. EDR HD-4H4 provides 8 line level audio inputs and 2 line level audio outputs. The first 4 audio outputs are RCA connectors, the rest are on DIN connectors.

Audio out 1 is for local audio output, whereas Audio out 2 is reserved for the audio transmitted from the remote site back to the DVR.

ATTENTION: The direct connection of a non-amplified microphone is not supported (a microphone amplifier is required). The audio output requires an amplifier to drive a speaker or headphones.

The installation must be connected with audio coax cable and RCA plugs.

AUDIO RECORDING FUNCTIONALITY:

Audio recording is activated / deactivated in the Camera Menu for Camera #1~16 respectively. Please check and always comply with local laws and regulations when using audio recording.

The audio channel is always recorded together with video and is independent of the image recording rate. Though the audio record control is done in the Camera #1~16 screen, there is no specific camera allocation.

2.3 ALARM CONTACTS INSTALLATION

The alarm inputs can be used to start recording or for recording rate adjustment. In addition, alarm reactions such as camera display on the monitor, buzzer, e-mail and network alarm are available. The alarm output relay can be switched if required. Alarm input response actions can be controlled according to a flexible schedule.

2.3.1 Alarm Input Contacts

This DVR provides one alarm input per camera. All inputs are programmable N.O. (Normal Open) or N.C. (Normal Closed) Inputs have to be switched by dry contacts.

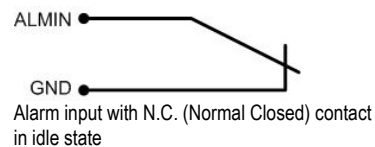
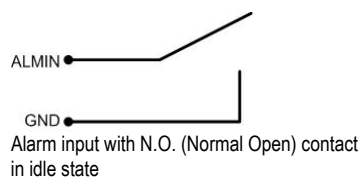

All settings are programmed in the ALARM menu (Section 0).

2.3.2 Alarm Output Relay

The relay output provides either Normally Open or Normally Closed dry contacts.

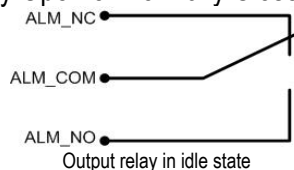

2.4 RS-485 keyboard / PTZ Installation

All functions can be remote-controlled by the EKB-500 universal keyboard. Using the EEPbus protocol, digital video recorders, keyboards and speed domes can be installed on one single RS-485 bus. One system can comprise up to 8 keyboards.

2.4.1 General RS-485 bus installation

The EKB-500 keyboard uses a RS-485 simplex wiring; the signal is transferred via a single twisted pair line. CAT5 network cable is recommended, UTP version (unshielded) is sufficient for normal applications. A shielded cable should be used if the installed cables are expected to be highly susceptible to interference. The number of devices installed in one bus is limited to 32, and the maximum cable length is 3,900 feet. Both of these can be expanded using a signal distributor EverFocus Model EDA997A (see below).

Both the first and the last device in series should be terminated with 120 Ohm resistance in order to minimize line reflections.

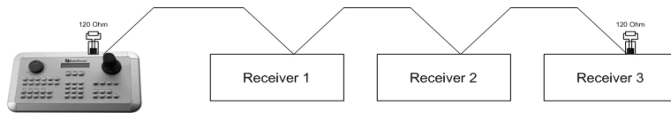

RS-485 bus serial wiring

Cable length from box to device („Stubs“) has to be limited to 2m using connector boxes.

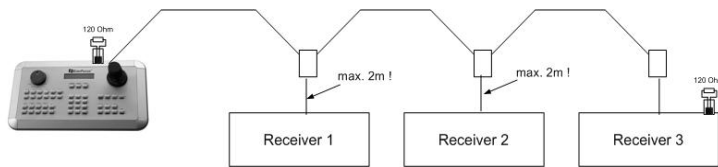

RS-485 bus serial wiring with connector boxes and connection cable

Direct RS-485 bus star wiring is not supported unless using an EverFocus Model EDA997A (see below).

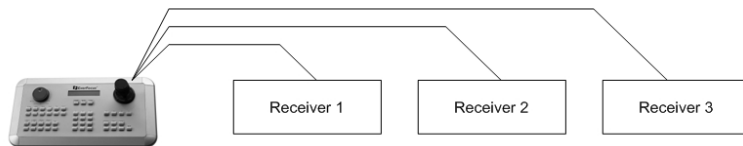

Improper RS-485 bus star wiring

An EDA997A RS-485 signal distributor may be used to use a star wiring configuration.

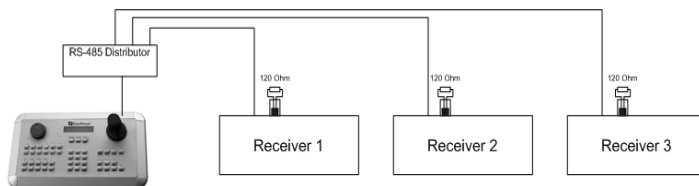

Star wiring with RS-485 signal distributor

A RS-485 distributor can also be used to increase the maximum number of devices on the bus as well as the total range. Each distributor output provides another RS-485 bus. This allows each output to extend an additional 1200m, and it also enables the additional connection of 31 further devices to each output (the output itself represents one device).

The maximum system expandability depends on the RS-485 address range of the installed devices.

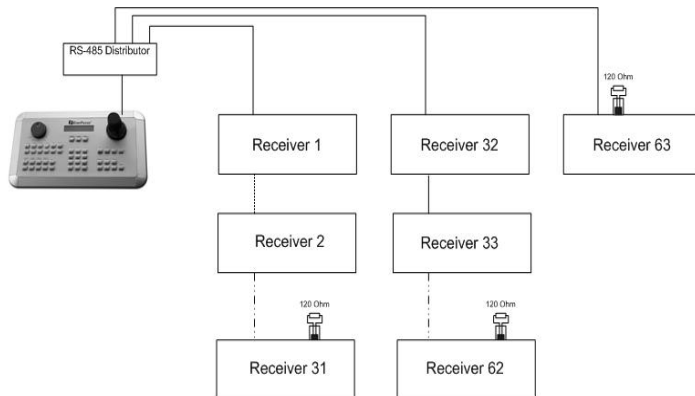

System expansion with RS-485 signal distributor

ATTENTION: EDA997A signal distributors are unidirectional! This means that the signal only flows from the input towards the outputs. Therefore, e.g. the interconnection of several keyboards is not possible with these types of signal distributor!

2.4.2 RS-485 ports

This DVR provides two independent RS-485 ports with 2 RJ-45 plugs each (loop-through).

2.4.3 EKB-500 connection with network patch cable

For a simple, short distance installation, recorder and keyboard can be connected directly using a standard CAT5 network cable with an 8-pin connector at only one end, and at the other end the Pin 3 wire connected to RS485 "+" (plus) and the pin 6 wire connected to RS-485 "-" (minus).

2.4.4 EKB-500 connection to several DVRs

For long distance installations connecting several DVRs, please use an EDA997A signal distributor to connect. For further details on keyboard connection, please refer to the EKB-500 manual.

RS-485 port communication settings are configured in the *I/O CONTROL* menu (Section 5.10.4 System Setup: I/O - control).

2.4.5 Speed Dome Installation

Speed dome or telemetry receiver pan/tilt/zoom control is available through web browser or the optional PowerCon software if the DVR is connected to a network. Local telemetry control is provided by USB - mouse control or by the optional EKB-500 keyboard.

Supported protocols: EverFocus, Pelco-D, Pelco-P, Samsung, Transparent

Required DVR settings: RS-485 receiver address in *CAMERA* menu
(Section 4.3)

RS-485 parameters and protocol in the *I/O CONTROL* menu
(Section 5.10.4)

ATTENTION: Some Pelco-D / -P protocol domes and receivers require an address offset of -1, i.e. the address assigned to the dome / receiver in the DVR camera menu must be 1 below the address set in the dome / receiver itself!

2.5 USB-Mouse installation

Connect the USB mouse to one of the 2 USB ports. (This can be done while DVR is powered on) The rear USB V1.0 port is recommended to reserve the higher speed front USB V2.0 port for video copy/export.

NOTE: Recommended mouse types are Logitech® and Microsoft® wired USB wheel-mouse. Wireless USB mouse is not supported.

2.6 NETWORK CONNECTION

This section only describes physical connection to an Ethernet network. This step must be completed before the DVR can connect to the network. There are two basic types of connection:

2.6.1 Direct PC Connection through Crossover Network Cable

The point-to-point connection of DVR and PC requires a crossover (crossed) network cable. This type of connection is **ONLY** used for direct connection to a single PC. Make sure that the PC is equipped with a 10/100Mbps compatible network connection.



Figure 2-1 Direct PC Connection

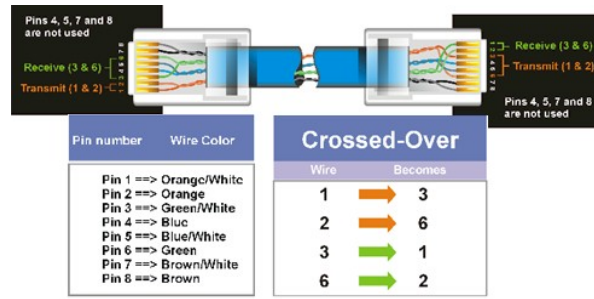

Pinout of crossover-cable

2.6.2 Network Connection through Patch Cable

The connection to an existing network requires a normal patch cable (straight-through). The illustration shows the connection to a network switch or router.

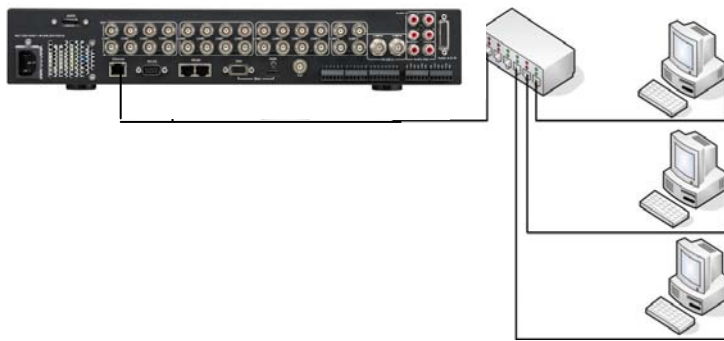
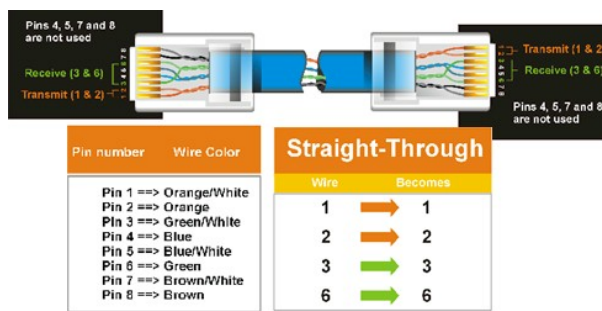

Figure 2-2 Network Connection through Patch Cable



Pinout of straight patch cable

2.7 FINAL INSTALL PROCESS

Once you have completed the basic wiring connections, you are ready to turn on the DVR. Simply plug in the power source. The POWER LED will light up if power is normal. Once the system has finished loading, you can begin to set up the menu options for the DVR.

3 MOUSE AND FRONT PANEL OPERATION

ENDEAVOR SD+HD DVRs support multiple sources to control the DVR. It can be controlled with a mouse, the front panel, an EKB500, and the handheld IR remote control.

This chapter will cover the basic operation using the mouse and the front panel buttons.

3.1 GENERAL USB MOUSE OPERATION

3.1.1 How to select a channel / Enable audio

1. In a view consisting of more than one channel, users can select a channel by clicking once on the desired channel screen. The selected screen will be highlighted by a white frame.
2. Double clicking on a channel screen will display full screen for this channel.
3. To enable audio out, click the audio icon (ex: ) at lower side of the screen. This system has only one audio out. Click this button to enable or disable the audio-out mode.

3.1.2 OSD Root Menu

1. Right-click the mouse to obtain the DVR menu bar (see Figure 3-1 OSD Root Menu). When you move the mouse over each icon, its title will be displayed at the top of the control bar.



Figure 3-1 OSD Root Menu

2. Click on any icon to perform that action. These actions are covered in detail in Chapter 3.
3. Click the "X" in the top-right corner to close the DVR control bar.

3.1.3 Operation in the Configuration Menus

Click on the  icon to access the Configuration Menu.

The Configuration menu screens (shown in Figure 3-2 OSD Menu) are divided into 3 main sections.



Figure 3-2 OSD Menu

1. In section 1, there are ten setup options available. Move the mouse over an icon and click to select it.
2. In section 2, the choices for the selected icon will be displayed. Click on a choice to select it.
3. In section 3, all the options for the selected choice will be available. Click on a field to make changes.

3.1.4 Field Input Options

The following are examples of different types of fields available in the Configuration menu.

Title **Textbox:** Click on the box and an on-screen keyboard will appear*. (see note about the on-screen keyboard below)

Record Mode **Dropdown box:** Click on the down arrow to see all selections, then directly click on an option to select it.

Install **Check box:** Click on the box to enable it (checked) or disable it (unchecked).

Edit Motion Grid **Button:** Click the button to execute the function.

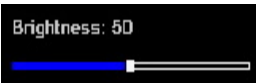





Bar: Click and hold on the bar to adjust the set point Left or Right.

*** Note about on-screen keyboard:**

Click on a button to input that character.

The buttons on the right and bottom have the following functions:



Space	Enter a space
Caps	Switch to capital letters
	Delete the letter
	Confirm the selection
	Move to right
	Move to left

2.2 General Front Panel Operation

2.2.1 How to select a channel / Enable audio

1. In a view consisting of more than one channel, press the arrow keys (Up/Down/Right/Left) to scroll through each channel that is displayed. The selected channel will be highlighted by white frame. Pressing the “left” or “right” arrow when the last/first camera (1,4, 9 or 16) is highlighted will select all cameras.
2. While channel #1 is selected, press the “Enter” button to turn Audio On/ Off.

2.2.2 OSD Root Menu

1. Press “Menu” key to display the DVR menu bar. Use the left/right arrows to scroll over each icon. The title for each icon will be displayed on top of the menu bar.
2. Press “Enter” key on any icon to perform that action. These actions are covered in detail in Chapter 3
3. Press “Menu” to close the DVR menu bar.

2.2.3 Front Panel Key Review



The basic principle of front panel operation is to use arrow keys to navigate among the menu items. Use the “Enter” key to confirm a selection or enter the next level menu. Press the “Menu” key to enter the Main Menu or exit from the current level of the menu.

2.2.4 Operation in Configuration Menu

Press “Menu”, use the arrow keys to highlight the “Configuration” icon, and press “Enter” with “Configuration” icon highlighted to bring up the Configuration menu.

NOTE: If the require password option is active, you will need to log in first. Refer to “Section 3.2 LOGIN” for information on logging in. The menu (shown in Figure 3-3 OSD Menu) is divided into 3 main sections.



Figure 3-3 OSD Menu

1. In section 1, there are ten setup options available. Use arrow keys to highlight an icon and press “Enter” to select it.

2. In section 2, the main choices for the selected icon will be displayed. Use Up/Down arrow keys to highlight a choice and press “Enter” to select it.

3. In section 3, all the options for the selected choice will be available here. Use arrow keys to move between items and press “Enter” to make changes to that item.

Note: press the “Menu” button to go back to the previous menu section/level.

2.2.5 Field Input Options

Title **Textbox:** Press **Enter** key and an on-screen keyboard will appear*. (see note about on-screen keyboard below)

Record Mode **Dropdown box:** Press “Enter” key to show the available options. Use arrow keys to highlight the desired option and press “Enter” again to select it.

Install **Check box:** Press “Enter” key on a setting to enable it (checked) or disable it (unchecked).

Edit Motion Grid **Button:** Press “Enter” key to execute the function.







Bar: Press “**Enter**” key to activate the slider, then use arrow keys to adjust the setting. Press “**Enter**” again to finalize the changes.

*** Note about on-screen keyboard:**

Use the arrow buttons to highlight each character and press the “**Enter**” key on the front panel to input the selected characters. When finished, highlight “*Done*” and press the “**Enter**” key on the front panel to confirm. The buttons on the right and bottom have the following functions:



Space	Enter a space
Caps	Switch to capital letters
	Delete the letter
	Confirm the selection
	Move to right
	Move to left

3. GENERAL DVR OPERATIONS

This chapter introduces the operations on major functions including playback, layout change, sequence, triplex operations, copy, and search.

3.1 RECORD

By default, the DVR will always be in record mode. When the DVR is turned on, it will start to record. The exceptions are:

1. DVR will not record any uninstalled cameras (Refer to Section 4.3.1 for more details)
2. If a schedule is active, the DVR will follow the record settings of the schedule.

3.2 LOGIN

In order to access ENDEAVOR SD+HD options, users may be asked to log in for authority identification. To log in, follow these steps.

1. Right click on the screen or press the Menu Key to display the Main Menu
2. Choose or click (or press “**Enter**” key) on the Configuration icon to bring up the following screen:



Figure 3-1 Login page

3. Select the user name from the drop-down list and input the password. The defaults are:

User name: admin (lower case)

Password: 11111111

- + To input password by mouse: click the password field to bring up the on-screen keyboard (see Figure 3-2 On-screen Keyboard). Click on each button to input the desired characters for the password. When finished, click “Done” on the on-screen keyboard to confirm the password.
- + To input password using front panel: use the arrow keys to select the password field, then press the “Enter” key to show the on-screen keyboard (see Figure 3-2 On-screen Keyboard). Use the arrow buttons to highlight each character and press the “Enter” key on the front panel to input the selected characters. When finished, highlight “Done” and press the “Enter” key on the front panel to confirm the password.
- + Click (or press “Enter” key when highlighted) on the “Login” button to log in to the system.



Figure 3-2 On-screen Keyboard

3.3 SELECT CAMERA OPERATION

ENDEAVOR SD+HD is a pentaplex DVR; users can control each camera individually by selecting that camera. For camera selection:

Mouse: Right-click the screen, the image will show a white frame on screen if the camera has been selected. When in quad display mode, press the quad layout icon in layout menu to select all four cameras.

Front panel: Use the arrows to change the selection. Pressing the “right” or “left” arrow when the last/first camera (1, 4, 9 or 16) is highlighted will select all cameras.

3.4 CHANGE AUDIO OUTPUT OPERATION

Use the arrow keys to select camera #1 and press “Enter” key to switch audio output on and off. An audio icon  will appear on the screen. Please make sure “Record Audio” option under Camera 1 Basic Settings setup menu is ON if audio recording is required. Also, the audio source and/or audio output amplifier have to be connected properly in order to utilize the audio functions. **Note:** Only Cam#1 controls audio, all others do not control audio.

3.5 PLAYBACK

The playback bar is the fastest way to show video from the exact time which users want to see. The playback bar allows a user to see both a time line and the current playback indicator. The user can then click the time line to move the indicator to the position which they want to see. The operation is as follows:

To playback:

By mouse: Right-click to bring up the menu bar and click on  to enter **Playback Menu**.

By front panel: Press  key to enter **Playback Menu**.

The playback bar will show (see figure below):

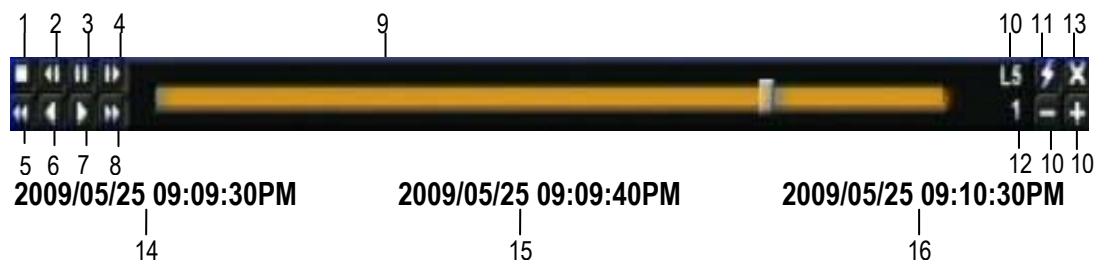

1. Stop key: press to stop playback
2. Slow Reverse key: press to start slow reverse playback
3. Pause key: press to pause playback
4. Slow Forward key: press to start slow forward playback
5. Fast Reverse key: press to start fast reverse playback
6. Reverse key: press to start reverse playback
7. Forward key: press to start forward playback
8. Fast Forward key: press to start fast forward playback
9. Time bar: Move the slider on the time bar to the select time to playback (The start time and end time for time bar appears below the bar). The status of each camera is represented by different colors on the time bar. Green means normal; orange indicates a Motion; blue indicates Video Loss, red indicates an alarm event.
10. "+" and "-" signs are used to adjust the time scale range for the bar. Press "+" or "-" to select between scale levels L1 ~ L5. When changing level, the start time and end time of the time bar will change
 - L1: Entire time bar is 2 days
 - L2: Entire time bar is 30 hours.
 - L3: Entire time bar is 1 hour.

- L4: Entire time bar is 10 minutes.
- L5: Entire time bar is 1 minute.
- 11. Express copy: Press to start express copy when camera during playback (only one camera)
- 12. Playback speed indicator
- 13. Press "X" to close the playback bar.
- 14. Start time for bar (the left-most point of the time bar)
- 15. Current playback time (the time indicated by the slider)
- 16. End time for time bar (the right-most point of the time bar)

3.6 PTZ

3.6.1 General PTZ control (if PTZ cameras are installed)

Right-click to bring up the menu bar and click on  to display **PTZ Controls**.

The following actions can be performed using the PTZ Menu:

1. Use Direction Arrows (up, down, left, right) to move the camera to the desired direction and angle.
2. To **Zoom**, Click "**Z+**" to zoom closer or "**Z-**" to zoom farther away.
3. To **Focus**, click "**F+**" to focus far or click "**F-**" to focus near.
4. With **Iris**, you can increase the amount of light by clicking "**I+**" or decrease it by clicking "**I-**".
5. To program a preset position (if supported by the camera)
 - a. Move PTZ camera to the specified position
 - b. Click "**Preset**" button
 - c. Click the number of the desired position (This will be displayed in the box)
 - d. Click "**Set**" button
6. To jump to a preset position
 - a. Click "**Preset**" button
 - b. Click the number of the desired position
 - c. Click "**Go**" button
7. Shortcut for presets #1-9
 - a. Click digit 1-9 button without clicking any other buttons
 - b. The camera will seek that preset position
8. Steps to delete a preset position (if supported by the camera)
 - a. Click "**Preset**" button
 - b. Click the number of the desired position
 - c. Click "**Delete**" button
9. For Auto Pan
 - a. Click "**Auto Pan**" button



10. Pattern Operation (Pattern is the “0” Tour in Everfocus and Pelco PTZ cameras)
 - a. Click “**Pattern**” button
11. Steps to run a tour
 - a. Click “**Tour**” button
 - b. Click the number of the desired tour
 - c. Click “**Go**” button
12. Steps to remove a tour (if supported by the camera)
 - a. Click “**Tour**” button
 - b. Click the number of the desired tour
 - c. Click “**Delete**” button

Click “**C**” to clear the digit in the number display

Click “**X**” at the top-right corner to hide the PTZ menu (see Express control below)

Click “**Exit**” to leave PTZ function.

REMEMBER:

Click “**X**” at the top-right corner to hide the PTZ menu (see Express control below)

Click “**Exit**” to leave PTZ function.

“**X**” only HIDES the PTZ control panel. “**EXIT**” closes the panel *and* exits PTZ mode!! Other controls will not respond until you EXIT the PTZ mode!!

3.6.2 Express Control of PTZ

If the PTZ control panel/menu has first been opened and then hidden, the mouse can be used to control basic PTZ functions (Quick Mouse Control). The mouse cursor will change to different icons in different areas of the screen. With Quick Mouse Control, the user can control PTZ direction, zoom, and focus by clicking directly on screen. The screen is divided into 16 areas, with the outer ring is divided into 12 zones used to control movement direction. The inner square of 4 areas is used to control zoom and focus.

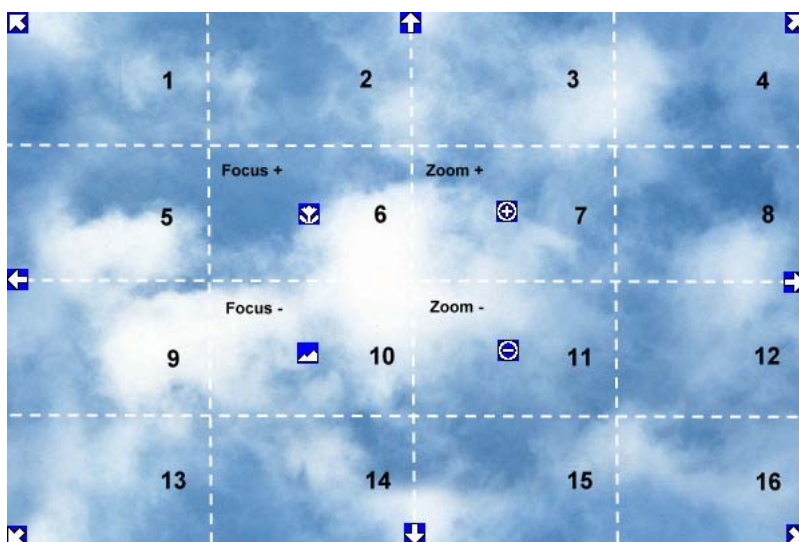

Figure 3-3 Express Control PTZ

The screen is divided into a 4x4 grid. The function of each section is defined as below:

- 1: PTZ pan/tilt left and up
- 2, 3: PTZ tilt up
- 4: PTZ pan/tilt right and up
- 5, 9: PTZ pan left
- 8, 12: PTZ pan right
- 13: PTZ pan/tilt left and down
- 14, 15: PTZ tilt down
- 16: PTZ pan/tilt right and down
- 6: Focus closer
- 10: Focus further
- 7: Zoom in
- 11: Zoom out

REMEMBER:

Click **"X"** at the top-right corner to hide the PTZ menu (see Express control below)

Click **"Exit"** to leave PTZ function.

"X" only HIDES the PTZ control panel. **"EXIT"** closes the panel *and* exits PTZ mode!! Other controls will not respond until you EXIT the PTZ mode!!

3.7 LAYOUT

The ENDEAVOR264 DVR has several display modes available, depending on the number of cameras the DVR supports. The different available layouts for a 16 camera model are shown below:



NOTE: PIP display is not available in Playback mode

To change layout, follow the steps below:

By mouse: Right-click to bring up the menu bar and click  then click on the desired layout choice.

By front panel: Push the “View” button on the front of the DVR to scroll through each display format.

3.7.1 Bring a camera to full screen mode

By mouse: Double left-click on the selected channel to put that camera in full screen mode.

By front panel: Press any channel key to bring that channel to full screen mode.

With a mouse, double left-click again on the screen to return to the previous multiple camera layout.

3.8 CHANNEL SWITCHING

Use this function to change a channel position within a multiple camera display

1. Select one camera
2. Press Channel button .
3. Click on the channel number you wish to select on the channel bar. The camera channel displayed in that position will be switched.













EX: On a four camera screen, select camera1 and enter Channel menu and choose “2”, then camera 2 will show on position of camera 1, camera 1 will show on position of camera 2. If the new camera being selected is already displayed on screen, then the camera positions will be exchanged. If the new camera being selected does not already appear, it will replace the previously displayed camera.









3.9 DISPLAY

Press the Display button  on the menu by using the mouse or selecting this icon with the front panel keys and pressing 'Enter'. Pressing/clicking cycles through the four OSD formats:

1. Press to show camera information. Please see the following table for camera information icons.

 Recording	 Playback	 Fast forward	 Fast backward	 Back	 pause
 Alarm	 Motion	 Video loss	 Express copy	 Audio out	

3. Press again to show status information. Please see the following table for status representation.

 Alarm	 Audio	 Event	 HDD failure	 HD temp. too high	 Seq.
 Motion	 Video loss	 No network			

4. Press again to show both status information and camera information.

5. Press again to hide all information.

3.10 SEQUENCE

1. By mouse: Click Sequence button  to enter the auto sequential switching mode.
2. By front panel: Press the Sequence button on front panel to enter the auto sequential switching mode.

3.11 ZOOM

1. Make sure no camera is in playback mode
2. Select one camera
3. Right-click to bring up the menu bar and click  button. Or, press the ZOOM button on the front panel.

4. When in ZOOM mode, the mouse cursor will change to a different icon in different areas of the screen. Or, use the arrow keys to bring a different portion of the magnified image into view. Users can control the portion of the magnified image to be displayed by clicking directly on screen:

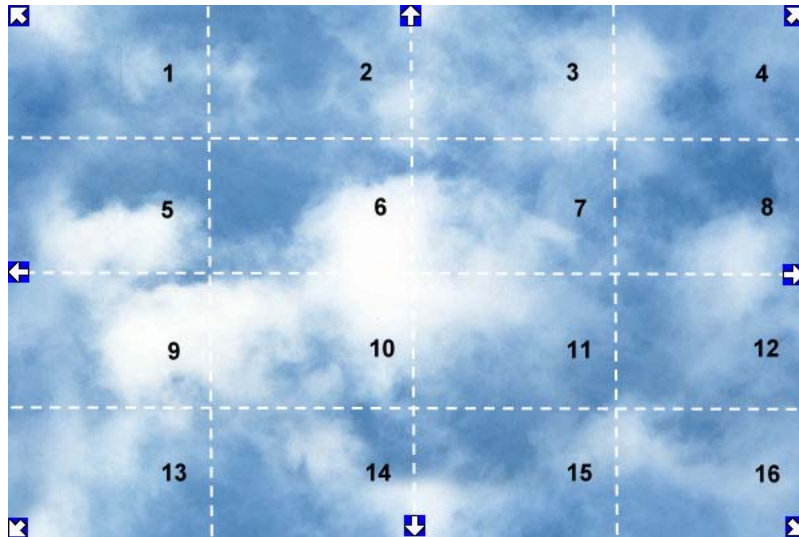



Figure 3-4 Zoom Express Control

The screen is divided into a 4x4 grid. The function of each section is defined as below:

- 1: Left and up
- 2, 3: Up
- 4: Right and up
- 5, 9: Left
- 8, 12: Right
- 13: Left and down
- 14, 15: Down
- 16: Right and down
- 6, 7, 10, 11: Not used

3.12 SEARCH

By mouse: Right-click to bring up the menu bar and click  to enter **Search Menu**.

By front panel: Press "**Search**" key to enter Search Menu directly.

3.12.1 Time Search



Figure 3-5 Search Menu – Time Search

Start Date/Time: Select the time to begin the search by choosing the Date and Time.

Click on the “**Play**” button to start the search. The DVR will automatically begin to play the video selected. The DVR will play the nearest time if there is no data at the selected time.

In search playback mode, pressing the “**Stop**” button will return to the search menu.

3.12.2 Event Search

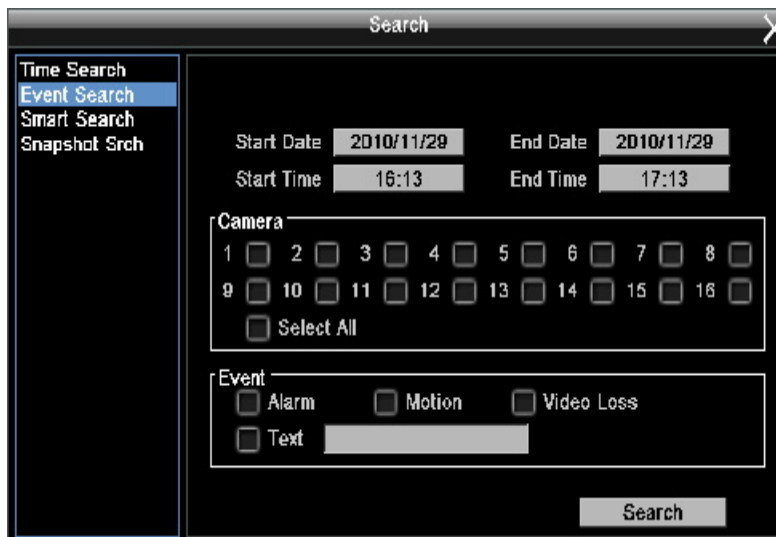

Figure 3-6 Search Menu – Event Search

Start Date/Time: Select starting date and time

End Date/Time: Select ending date and time.

Camera: Select which cameras to include in the search.

Event: Select which event type(s) to search for. Choose from Alarm, Motion or Video Loss. Or specify an event by entering the event name to be searched in Text box.

Click on the **“Search”** button to start searching. The search results will be shown as a list of events.

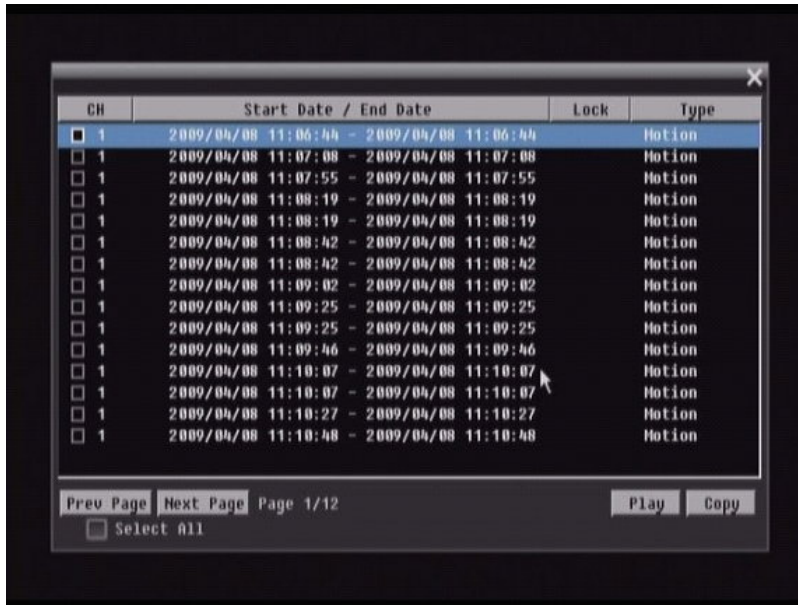

The screenshot shows a window titled 'Search Results' with a table of events. The table has columns for 'CH', 'Start Date / End Date', 'Lock', and 'Type'. The first row is selected. Below the table are buttons for 'Prev Page', 'Next Page', 'Page 1/12', 'Play', 'Copy', and a 'Select All' checkbox.

CH	Start Date / End Date	Lock	Type
<input checked="" type="checkbox"/> 1	2009/04/08 11:06:44 - 2009/04/08 11:06:44		Motion
<input type="checkbox"/> 1	2009/04/08 11:07:08 - 2009/04/08 11:07:08		Motion
<input type="checkbox"/> 1	2009/04/08 11:07:55 - 2009/04/08 11:07:55		Motion
<input type="checkbox"/> 1	2009/04/08 11:08:19 - 2009/04/08 11:08:19		Motion
<input type="checkbox"/> 1	2009/04/08 11:08:19 - 2009/04/08 11:08:19		Motion
<input type="checkbox"/> 1	2009/04/08 11:08:42 - 2009/04/08 11:08:42		Motion
<input type="checkbox"/> 1	2009/04/08 11:08:42 - 2009/04/08 11:08:42		Motion
<input type="checkbox"/> 1	2009/04/08 11:09:02 - 2009/04/08 11:09:02		Motion
<input type="checkbox"/> 1	2009/04/08 11:09:25 - 2009/04/08 11:09:25		Motion
<input type="checkbox"/> 1	2009/04/08 11:09:25 - 2009/04/08 11:09:25		Motion
<input type="checkbox"/> 1	2009/04/08 11:09:46 - 2009/04/08 11:09:46		Motion
<input type="checkbox"/> 1	2009/04/08 11:10:07 - 2009/04/08 11:10:07		Motion
<input type="checkbox"/> 1	2009/04/08 11:10:07 - 2009/04/08 11:10:07		Motion
<input type="checkbox"/> 1	2009/04/08 11:10:27 - 2009/04/08 11:10:27		Motion
<input type="checkbox"/> 1	2009/04/08 11:10:48 - 2009/04/08 11:10:48		Motion

Prev Page: Go to previous page

Next Page: Go to next page

Play: Playback selected item

Copy: Copy selected item

Note: Text Search supported by VSI-Pro Max POS/Cash register interface from AVE has been implemented. For more information, you may contact AVE (<http://www.avethailand.com>) directly. If you have any other POS integration request, please contact EverFocus sales.

3.12.3 Smart Search

Smart Search allows the review of a segment of the recorded video from individual cameras to detect motion in an area specified at the time of the search. The resulting 'motion events' are displayed in the form of an Event List.

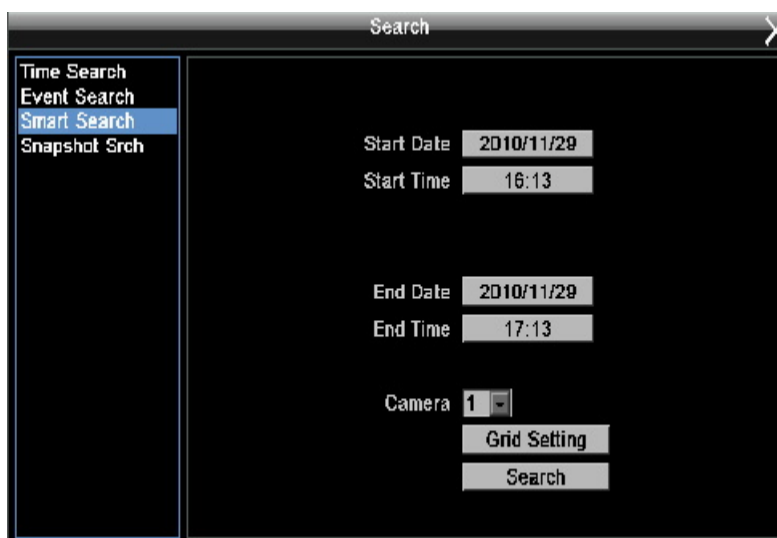

Figure 3-7 Search Menu – Smart Search

Start

Date: Select starting date.

Time: Select starting time.

End

Date: Select ending date.

Time: Select ending time.

Camera: Select which cameras to review.

Grid Setting: Press Grid Setting button to open the motion grid setup window.

Edit Motion Grid: Press this button to edit the motion grid (See Figure 4-5 Camera Menu – Motion Grid Setting).

Set All: Press this button to select the entire area.

Clear All: Press this button to clear all the grids selected.

Save & Back: Press this button to save the motion grid setting and return to motion setting menu.

Cancel: Press this button to cancel all changes and returns to the motion setting menu.

How to select motion grid by mouse:

1. Click on the image and the grid will display.
2. Select the grid square in the upper-left of the desired rectangle.

3. Select the grid square in the lower-right of the desired rectangle.
4. The area between upper-left and lower-right grid will be selected.
The same result is achieved from lower left followed by upper right.
5. Choose "Save & Back" to proceed.

How to select motion grid by front panel:

1. Press Enter key on "Grid Setting" to launch motion grid setting page. .
2. Use arrow keys to scroll above or below list of buttons to enter the grid setting area.
3. Press Enter key to display grid.
4. Use arrow keys to choose one corner of desired area
5. Press Enter key at the starting point.
6. Use arrow keys to select motion area; the shape of the proposed area will be displayed.

Press Enter key at the end point, and the area will be selected.

Press the Menu key to exit the area selection; use the up/down arrows to choose "Save & Back" and press Enter to proceed.

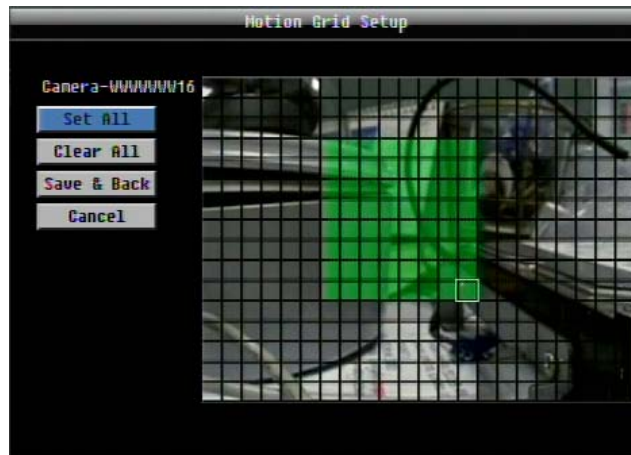

Click on the "**Search**" button to start searching. The search results will be shown as a list of events.

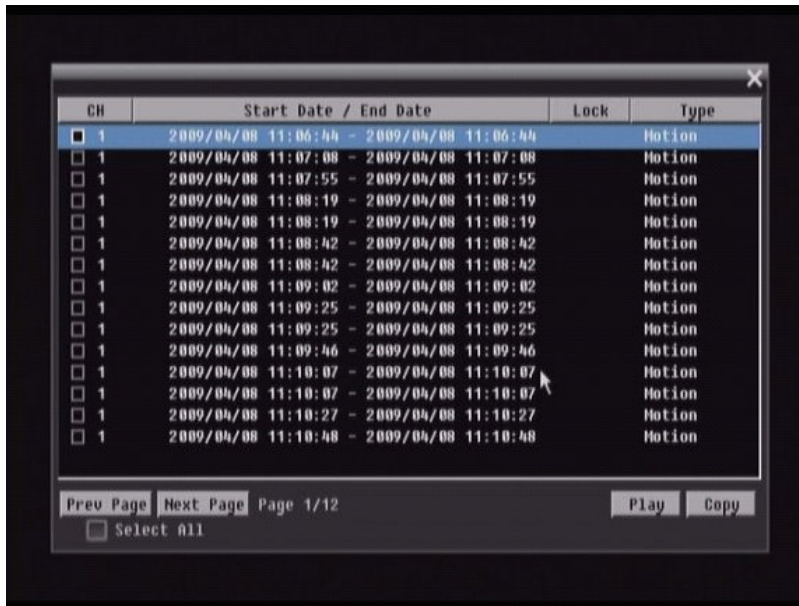

Prev Page: Go to previous page

Next Page: Go to next page

Play: Playback selected item

Copy: Copy selected item

3.12.4 Snapshot Search

Snapshot Search shows snapshots of the specified interval, it helps users to quickly find the interested scene.

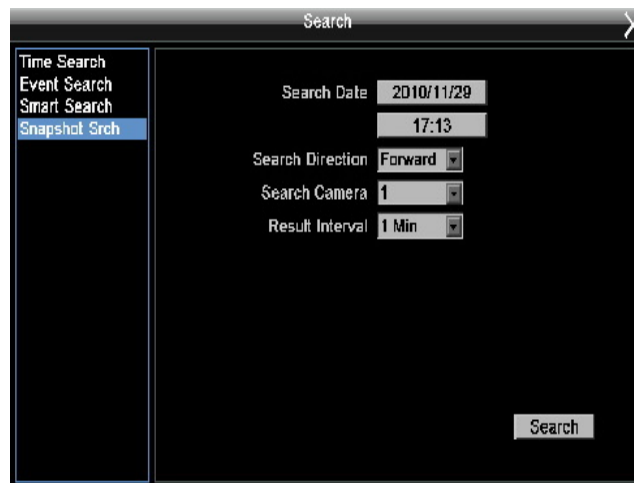

Figure 3-8 Search Menu – Snapshot Search

Search Date: Select search date and time

Search Direction: Select search direction, either forward or backward.

Search Camera: Select which camera to be searched.

Result Interval: Select interval of the snapshot to be searched. Available from 1 min, 5 min, 10 min, 30 min, 1 hour, 2 hour, 4 hour, 12 hour and 1 day.

Press **Search** button to start Search. Thumbnails of the Snapshot will be displayed on the screen. First thumbnail is the search date/time, date/time of the second thumbnail will be the interval set in “Result Interval” next to the first thumbnail, and so on. If “forward” is selected as search direction, a white frame will surround the selected snapshot at the first thumbnail. If backward is selected, the search date/time will be displayed at the last thumbnail and a white frame will surround the selected snapshot at the last thumbnail.





Right click the mouse to obtain a hint window, see figure 3.9. Press  button to view the 16 previous snapshots. Press  button to playback the selected snapshot. Press  button to close the hint window and return to search menu. Press  button to view the 16 next snapshots.



Figure 3-8 Search Menu – Snapshot Search result

3.13 COPY

To bring up Copy menu:

By mouse: Right-click to bring up the menu bar and click on  to enter **Copy Menu**.

By front panel: Press the **“Copy”** key to enter Copy Menu directly.

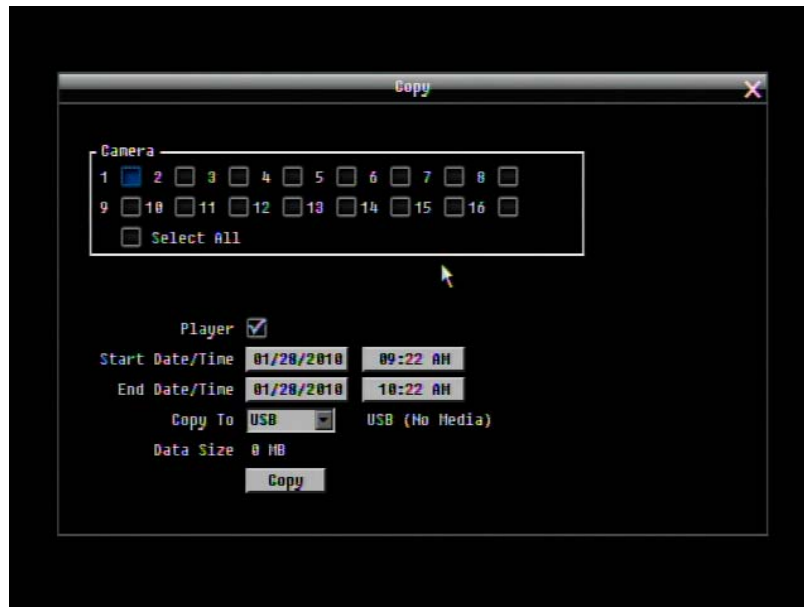

Figure 3-10 Copy Menu

Camera: Select which cameras will be archived. Choose **“Select All”** to select all the cameras.

Player: Check the box to include the ePlayer program as part of the copy (recommended).

Start Date/Time: Select the starting date/time to be archived.

End Date/Time: Select the ending date/time to be archived.

Copy To: Select whether you want to copy to USB or CD/DVD (CD/DVD on “D” models only).

Data Size: Shows the estimated total size for the time period.

Copy Now: Press **“Copy”** button to start archiving.

3.14 LOGOUT

Right-click to bring up the menu bar and click the  button to bring up the **Logout Confirmation window** (see Figure 3-11).

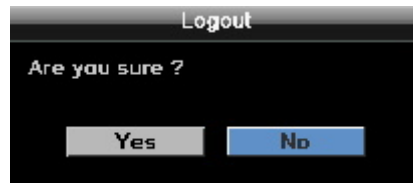



Figure 3-11 Logout Confirmation window

Press “**Yes**” button when you are ready to logout from the system. You will need to login again before accessing any other configuration options.

4 DVR CONFIGURATION

This chapter will walk you through the DVR Menu Settings step by step and show you how to set the DVR for your specific application.

4.1 CONFIGURATION MENU

1. To bring up the Main Menu, press the **"Menu"** key on the front panel or right-click with the USB mouse to bring up the OSD menu bar.
2. Press **"Enter"** or left-click on the "Configuration" icon  to enter the Configuration Menu. Log in if necessary (see Section 3.2 LOGIN above).

4.2 EXPRESS

The Figure 4-1 Express Menu is a screenshot of the **EXPRESS SETTING MENU**. This menu is used to configure global express settings for all cameras. For example, if user selects Event Only in Record Mode and presses the **"Apply"** button, all 8/16 cameras will be set to Event only. If user selects Blank in Recording Mode and presses the **"Apply"** button, cameras will keep their own current individual record settings without any changes.



Figure 4-1 Express Menu

Date: Sets the current date of DVR.



Time: Sets the current time of DVR.



Record Dual Stream: Select "Enable" to record dual stream. Select "Disable" to disable this function.

Record Mode: Choose from

Normal+Event: Normal recording plus event recording.

Event Only: Event recording only.

Schedule Rec: Schedule recording.

For Event recording, enter the estimated number of hours per day for event recording.

Main Resolution: Select recording resolution based on video format for the main stream.

NTSC: 704x480 / 704x240 / 352x240

PAL: 704x576 / 704x288 / 352x288

Sub Resolution: Select recording resolution based on video format for the sub stream.

NTSC: 352x240 / 176x120

PAL: 352x288 / 176x144

Record With:

Preset Settings: Select preset setting or recording quality. Available options are Best Quality, Standard and Extended Record in the next column. For more detail, please refer to APPENDIX B: RECORDING VALUE SELECTION RULES

Recording Days: (not available with Schedule Record) Set the maximum recording days. Available selection will be shown in the next column, including 1, 3, 5, 7, 14, 20, 30, 40, 50 and 60 days. DVR will auto adjust relative settings for all the cameras to fit the selected max recording days. For more detail, please refer to APPENDIX B: RECORDING VALUE SELECTION RULES

Network Type:

Static IP: User sets a static IP for network connection.

DHCP: DHCP server in LAN will automatically assign IP for network connection.

PPPoE: This is for direct DSL connection application ONLY (no router). Check with your ISP to see if they use PPPoE.

IP Address: This field shows the current IP Address for the DVR. If Fixed IP address is used then this value must be set manually. If DHCP or PPPoE is selected, this value will be assigned automatically.

Subnet Mask: This field shows the subnet mask for your network so the DVR will be recognized within the network. If DHCP or PPPoE is selected, this value will be assigned automatically.

Gateway: This field shows the gateway for your network so the DVR will be able to communicate *outside* the network. If DHCP or PPPoE is selected, this value will be assigned automatically.

DNS server 1: This field shows the primary DNS server for your network. When DHCP is selected and an internet connection is available, this value will be assigned automatically. **This field must be assigned correctly if you plan to use the DDNS feature** (see Section 4.7.3 DDNS for more details).

DNS server 2: This field shows the secondary DNS server for your network.

Note: The default addresses in the machine are for internal testing only. You must supply your own addresses to comply with your network. Refer to Section 4.6 for more details.

Apply: Press “**Apply**” button to save and apply the Express settings to DVR. The system will automatically adjust recording frame rate according to your settings. The following message will pop up; press “Yes” to change Resolution, Recording frame rate and Quality depending on your Express settings.

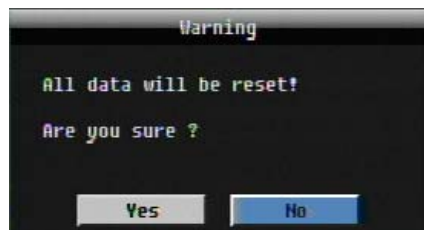

4.3 CAMERA SETTING

Figure 4-2 is a screenshot of the **CAMERA SETTING MENU**. This menu is used to configure individual camera settings.



Figure 4-2 Camera Menu-Basic Setting

4.3.1 Basic Setting

Camera: Select the camera to be configured.

Title: The title setting allows you to assign a title to the selected camera. Each title supports up to 16 characters. The on-screen keyboard will appear when you click the title option.



Install: Check the box to enable the current camera. To take full advantage of the DVR's recording abilities, any unused cameras should have this option set to "disabled".

Covert: Check the box to hide the camera picture in live and sequence modes. However, the image will still be recorded and **can be played back by any user who has playback rights.**

Record Mode: 2 record modes are available.

Normal + Event: This recording mode includes continuous and event recording.

Event Only: Video will be recorded only when events occur.

Record Dual Stream: Select "Enable" to record dual stream. Select "Disable" to disable this function.

Resolution (Main Stream): Select recording resolution based on video format for main stream.

CH 1~14 of 2H14 / CH 1~4 of 4H4 analog video input:

NTSC: 704x480 / 704x240 / 352x240

PAL: 704x576 / 704x288 / 352x288

CH 15~16 of 2H14 / CH 5~8 of 4H4 HD-CCTV video input:

NTSC/PAL: 1920x1080 or 1280x720 auto detected by HD-CCTV camera input

Resolution (Sub Stream): Select recording resolution based on video format for sub stream.

CH 1~14 of 2H14 / CH 1~4 of 4H4 analog video input:

NTSC: 352x240 / 176x120

PAL: 352x288 / 176x144

CH 15~16 of 2H14 / CH 5~8 of 4H4 HD-CCTV video input:

NTSC/PAL: 480x270 or 320x180 auto detected by HD-CCTV camera input

Record Quality (Main Stream / Sub Stream): Select an image quality for recording. There are five different qualities available: Superior, High, Standard, Basic and Low. A higher image quality uses more HDD space.

Normal Speed (Main Stream / Sub Stream): Frame rate in frames (images) per second (FPS) for continuous recording. The speed is limited by the maximum total recording capacity of the DVR as allocated across all the installed cameras, with an upper limit of 30 FPS (NTSC – 25 PAL) per individual camera (real time recording). The EDR HD-2H14 DVR is capable of recording 420 4CIF (704x480) sized frames per second (NTSC; 300 PAL) plus 30 Full HD (1920x1080) or 60 HD (1280x720) sized framed per second. The EDR HD-4H4 DVR is capable of recording 120 4CIF (704x480) sized frames per second (NTSC; 300 PAL) plus 60 Full HD (1920x1080) or 120 HD (1280x720) sized framed per second.; Thus the DVR can record a combination of CIF, 2 CIF and 4 CIF images, with different combinations of image size/resolution and different FPS rates on different cameras, so long as the total equivalents allocated is not greater than the max. total recording capacity. Choices for possible record speeds are 30, 15, 10, 7.5, 5, 3, 2 and 1 FPS.

Event Speed (Main Stream / Sub Stream): *Maximum* desired frame rate in frames per second (FPS) for event recording; if more than one camera requires simultaneous event recording, the total for all cameras cannot exceed the maximum available FPS for the DVR at the corresponding resolution setting, and *the available FPS may be divided across the cameras responding to an event.*

Record Audio: (Camera 1 screen only) Check this box to enable audio recording on the DVR.

PTZ ID: When using a PTZ Camera, in order to control the camera from the DVR this ID must match the RS-485 ID used by the connected camera. Click "On" to confirm selection, "Off" to cancel PTZ control for this camera. When PTZ ID is ON, a drop down menu will appear; set the PTZ ID address used to control this camera in that menu.

Apply To: This button can be used to copy the recording settings to other cameras. Select which camera(s) you wish to copy to. "Select All" selects all cameras, "Unselect All" deselects all cameras. Click "OK" to copy the settings or "Cancel" to exit without copying.

Note: Analog camera settings cannot be applied (copied) to HD-CCTV camera.

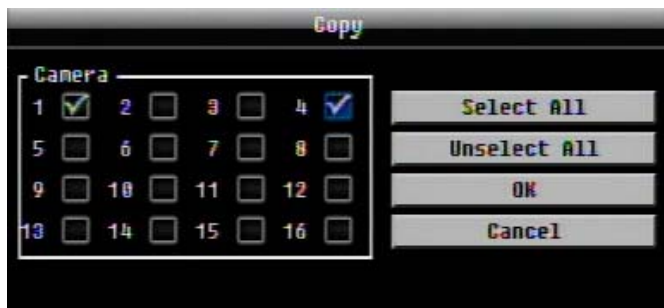

4.3.2 Video Adjust (apply to analog camera only)



Figure 4-3 Camera Menu – Video Adjust

Camera: Select the camera you wish to adjust. "Title" will change to the name of the selected camera.

Brightness: Adjusts how bright/dark the picture appears. If details appear to be lost in the shadows or darker regions, try increasing the Brightness. If the image appears too saturated or if the colors appear overwhelmed by glare, try decreasing the Brightness.

Contrast: Adjusts the total amount of light output from the display. If details are lost or lines appear distorted, try decreasing the contrast.

Color: Adjusts the amount of color information in the picture.

Apply To: This button can be used to copy the video settings to other cameras. Select which cameras you wish to copy to. "Select All" selects all cameras, "Unselect All" deselects all cameras. Click "OK" to copy the settings or "Cancel" to exit without copying.

4.3.3 Motion



Figure 4-4 Camera Menu – Motion

Camera: Select the camera you wish to configure. "Title" will change to the title name of the selected camera.

Enable: Check box to enable motion detection. Other motion options will not be available unless this feature is selected.

Log: Check this box to record motion events in the log.

Main Monitor: Main monitor display options when a motion event occurs.

No change: No change on the main monitor display.

Full screen: A full screen of the event camera will display on the main monitor.

Pre-alarm Record: Check box to start copying recorded video to the hard disk from 5 seconds before the motion event. (Pre-alarm recording rate will follow the “**Normal**” frame rate setting)

Buzzer: Check this box to enable the buzzer when a motion event is triggered.

Email Notify: Check this box to send email notification when a motion event is detected. Email operation requires that valid email settings have been entered in the Network Setting/Email setup screen. (See Section 4.6.2 Email for more information.)

Network Alarm: Check this box to send out a network alarm to a client PC when motion occurs. (This feature requires PowerCon software on the client PC and proper settings for the Alarm Server in the Network Setup menu; see Section 4.6.4 Alarm Server for more information.)

Auto Lock: Check the box and the events will be recorded in a write protected segment of the Hard Disk. (DVR will lock a period of time when the alarm occurs, the length of time will depend on DVR setting)

Alarm Output: This will transmit a signal through the alarm output relay. It can be set to either “**NONE**” (not active), “**1**”, “**2**”, “**3**” or “**4**” (indicating which alarm relay is active).

Output Type: Output action when motion is triggered.

Timeout: Alarm output lasts for a set of time duration. If this option is selected, a field will appear for setting the duration.

Permanent: Alarm will remain on until the user presses the “Enter” key on front panel or otherwise resets the alarm condition.

Transparent: Alarm output continues as long as there is a motion event.

Trans+Timeout: Alarm output continues until the event ends, then continues for a set time duration.

Timeout Duration: Time duration selectable from 1 to 150 seconds.

Edit Motion Grid: Press this button to edit the motion grid (See Figure 4-5 Camera Menu – Motion Grid Setting).

Sensitivity: Set the threshold value for sensitivity within the grids. Select from 1 (lowest) to 10 (highest).

Min Area: To avoid false detections by small objects this value defines how many grids have to exceed threshold before generating a motion event. Select a value between 1 (default) to 5 grids.

Preview: Preview the motion grid.

Set All: Press this button to select the entire area.

Clear All: Press this button to clear all the grids selected.

Save & Back: Press this button to save the motion grid setting and return to motion setting menu.

Cancel: Press this button to cancel all changes and returns to the motion setting menu.

How to select motion grid by mouse:

1. Click on the image and the grid will display.
2. Select the grid square in the upper-left of the desired rectangle.

3. Select the grid square in the lower-right of the desired rectangle.
4. The area between upper-left and lower-right grid will be selected.
The same result is achieved from lower left followed by upper right.
5. Choose "Save & Back" to proceed.

How to select motion grid by front panel:

1. Press Enter key on "Grid Setting" to launch motion grid setting page. .
2. Use arrow keys to scroll above or below list of buttons to enter the grid setting area.
3. Press Enter key to display grid.
4. Use arrow keys to choose one corner of desired area
5. Press Enter key at the starting point.
6. Use arrow keys to select motion area; the shape of the proposed area will be displayed.
7. Press Enter key at the end point, and the area will be selected.
8. Press the Menu key to exit the area selection; use the up/down arrows to choose "Save & Back" and press Enter to proceed.

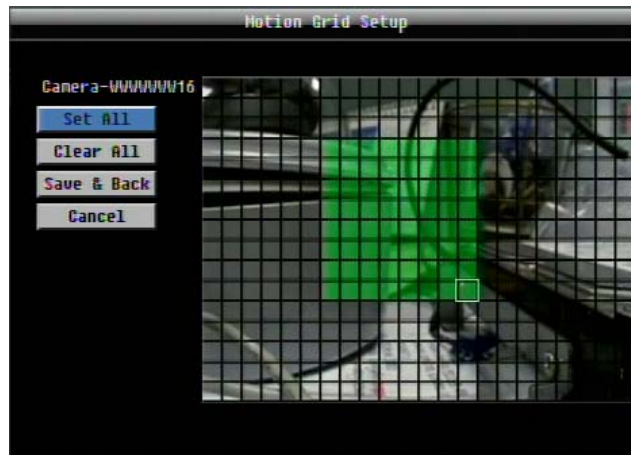

Figure 4-5 Camera Menu – Motion Grid Setting

Apply To: This button can be used to copy the motion settings to other cameras. Select which cameras you wish to copy to. "Select All" selects all cameras, "Unselect All" deselects all cameras. Click "OK" to copy the settings or "Cancel" to exit without copying.



4.3.4 Video Loss



Figure 4-6 Camera Menu – Video Loss

Camera: Select the camera you wish to configure, “Title” will change to the title name of the selected camera.

Enable: Check box to enable Video Loss detection.

Log: Check box to record video loss events in the log.

Pre-alarm Record: Check box to start copying recorded video to the hard disk from 5 seconds before the video loss. (Pre-alarm recording rate will follow the “Normal” frame rate setting)

Buzzer: Check box to enable the buzzer when a video loss event occurs.

Email Notify: Check box to enable email notification when a video loss event occurs. Email operation requires that valid email settings have been entered in the Network Setting/Email setup screen. (See Section 4.6.2 Email for more information.)

Network Alarm: Check this box to send out a network alarm to a client PC when motion occurs. (This feature requires PowerCon software on the client PC and proper settings for the Alarm Server in the Network Setup menu; see Section 4.6.4 Alarm Server for more information.)

Alarm Output: This will transmit a signal through the alarm output relay. It can be set to either "**NONE**" (not active), "**1**", "**2**", "**3**" or "**4**" (indicating which alarm relay is active).

Output Type: Output action when alarm is triggered.

Timeout: Alarm output lasts for a set time duration. If this option is selected, a field will appear for setting the duration. Time duration selectable from 1 to 150 seconds.

Permanent: Alarm will remain active until the user presses "**Enter**" key on front panel.

Transparent: Alarm output continues as long as there is a video loss.

Trans+Timeout: Alarm output continues until the event ends, then continues for a set time duration.

Apply To: This button can be used to copy the video loss settings to other cameras. Select which cameras you wish to copy to. "Select All" selects all cameras, "Unselect All" deselects all cameras. Click "OK" to copy the settings or "Cancel" to exit without copying.



4.4 RECORD & PLAY SETTING

Figure 4-7 is a screenshot of the **RECORD & PLAY SETTING MENU**. This menu is used to configure basic recording and playback settings.

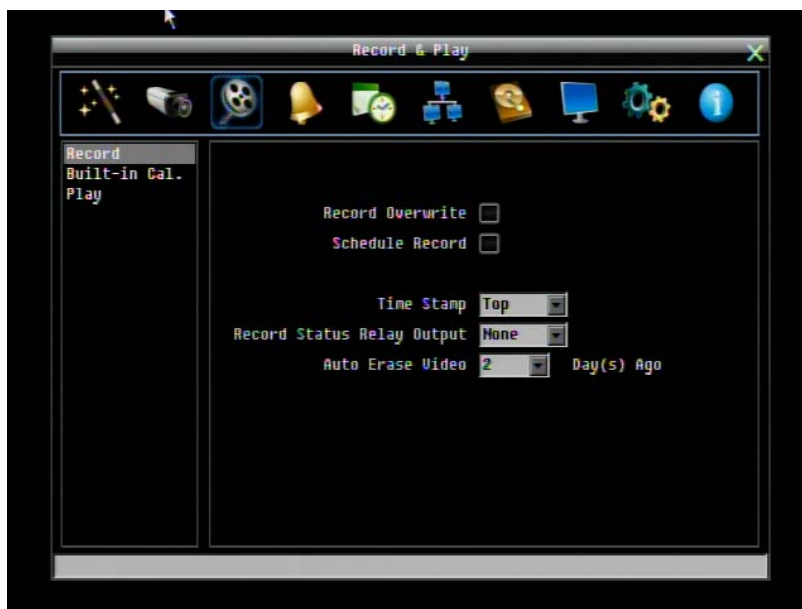

Figure 4-7 Record & Play Menu

4.4.1 Record

Record Overwrite: Check the box and the disk will begin overwriting when full. NOTE: Unless this box is checked, THE DVR MUST STOP RECORDING WHEN THE DISK IS FULL. **The use of record overwrite is strongly recommended.** If you do not use this feature, please be sure to make specific arrangements to monitor/be notified when the disk is full.

Schedule Record: Use schedule recording mode.

For Schedule recording, the only way to stop the DVR from recording is to turn schedule recording off. Pressing any key on the front panel to attempt to stop recording will not work during scheduling record mode. When schedule recording is disabled, as the default the DVR will automatically begin recording when it is first turned on.

Time Stamp: Select if the time and date will display while recording. Choose the location for the time display from Top, Bottom or Off.

Record Status Relay Output: Select from "NONE" "1" and "2". By monitoring the state of the selected alarm relay, the user can easily see the recording status from the alarm output if this option is set as "1" or "2".

Auto Erase Video: The hard drive will automatically erase video after it has been on the hard drive for the selected number of days. To use the maximum hard drive space, choose "OFF". (See Record Overwrite

and notes above.) This feature is useful if local rules and regulations require recorded video to be discarded after a specific number of days, or to limit the retention of older recorded video to clear space in anticipation of event recording.

4.4.2 Built-in Calculator

The built-in record period calculator can give a rough estimation of the total recording time for the DVR with the current settings. In order to compute as accurate an estimate as possible, please enter your expectations for the hours per day you expect recording to take place due to motion events and due to other alarm conditions.

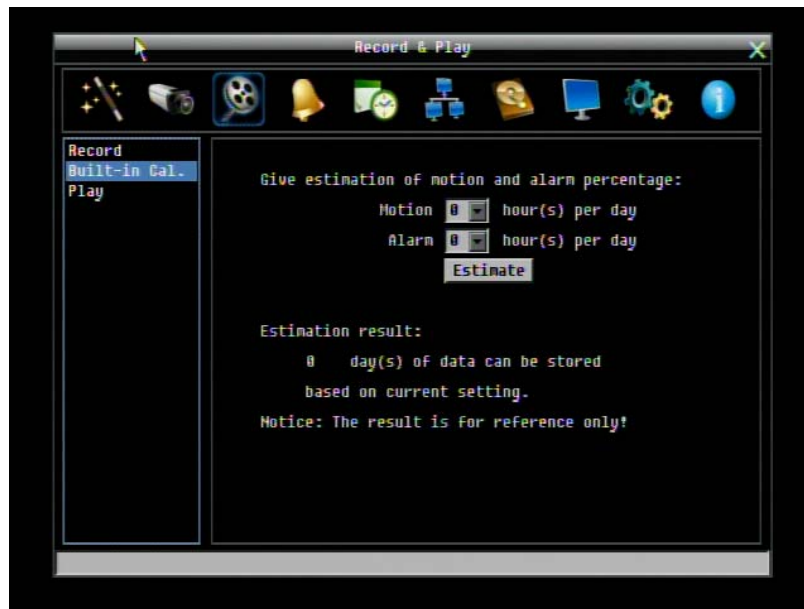

Figure 4-8 Record & Play Menu-Built-in Cal.

Motion: Enter the expected number of hours per day due to motion recording.

Alarm: Enter the expected number of hours per day due to alarm recording.

If the total of Motion and Alarm hours is more than 24 hours, the calculator will assume that motion and alarm recording take place for the entire 24 hour period.

Click on the **ESTIMATE** button to display the result at the bottom of the screen:

" xx days of data can be stored based on current setting"

4.4.3 Play

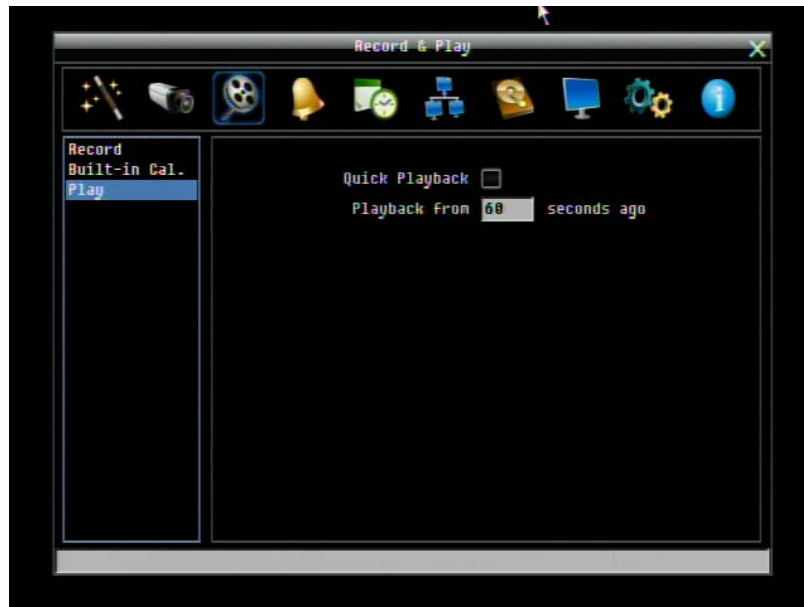

Figure 4-9 Record & Play Menu - Play

Quick Playback: Check the box to enable the Quick Playback function as described below.

Playback From X Seconds ago: When the DVR is put into playback (press PLAY), it will begin playing from the selected time. Choose from 60 to 3600 seconds prior to the present time.

If Quick Playback is not enabled, pressing the **PLAY** button will bring up the Playback Bar (see Section 3.5).

4.5 ALARM & EVENT SETTING

Figure 4-10 is a screenshot of the **ALARM & EVENT SETTING MENU**. This menu will guide you through alarm and event setup.



Figure 4-10 Alarm & Event Menu - Alarm

4.5.1 Alarm

Alarm: Select the alarm input trigger connection number from 1 to 16.

Enable: Check box to enable response to that alarm trigger.

Log: Check box to record these alarm events in the log.

Pre-alarm Record: Check box to start copying recorded video to the hard disk from 5 seconds before the alarm event. (Pre-alarm recording rate will follow the “Normal” frame rate setting)

Buzzer: Check this box to enable the buzzer when an alarm occurs.

Main Monitor: Main monitor display options when a motion occurs.

No change: No change on the main monitor display.

Full screen: A full screen of the active camera will display on main monitor.

Record: Select which camera(s) will start recording in response to this alarm event.

Email Notify: Check box to enable email notification when an alarm occurs. Email operation requires that valid email settings have been entered in the Network Setting/Email setup screen. (See Section 4.6.2 Email for more information.)

Input Type: This field is to change the type of alarm trigger.

N.O.: Normal Open contact.

N.C.: Normal Closed contact.

Network Alarm: Check this box to send out a network alarm to a client PC when motion occurs. (This feature requires PowerCon software on the client PC and proper settings for the Alarm Server in the Network Setup menu; see Section 4.6.4 Alarm Server for more information.)

Active Camera: This field is for associating an alarm trigger with a specific camera. For example if you had an external motion detector near camera four you would set this option to "4". The alarm will be associated with this camera for optional full screen display, event logging, and PTZ preset activation.

PTZ Preset: Select PTZ Preset from "1" to "255". If the Active Camera is a PTZ speed dome, the alarm will move the camera to the specified preset position for event recording. Click "On" to confirm selection, "Off" to cancel selection. When "ON" a sub-menu is displayed for choosing the desired PTZ preset number.

Auto Lock: Check the box and the events will be recorded in the write protected segment of the Hard Disk. (DVR will lock a period of time when an alarm occurs, the length of time will depend on the DVR settings)

Alarm Output: This will transmit a signal through the alarm output. It can be set to either "**NONE**" (not active), "**1**", "**2**", "**3**" or "**4**" (selects alarm relay to be active).

Output Type: Output action when alarm is triggered.

Timeout: Alarm output lasts for the set time duration.

Permanent: Alarm will remain active until the user presses the "**Enter**" key or resets the alarm remotely.

Transparent: Alarm output remains as long as the alarm input is active.

Trans+Timeout: Alarm output continues until event ends, then continues for the set time duration.

Timeout Duration: Time duration selectable from 1 to 150 seconds.

Apply To: This button can be used to copy the alarm settings to other cameras. Select which cameras you wish to copy to. "Select All" selects all cameras, "Unselect All" deselects all cameras. Click "OK" to copy the settings or "Cancel" to exit without copying.

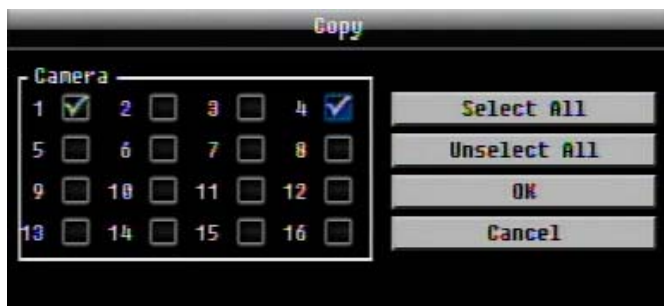

4.5.2 Event

This section covers notifications due to internal system event warnings.

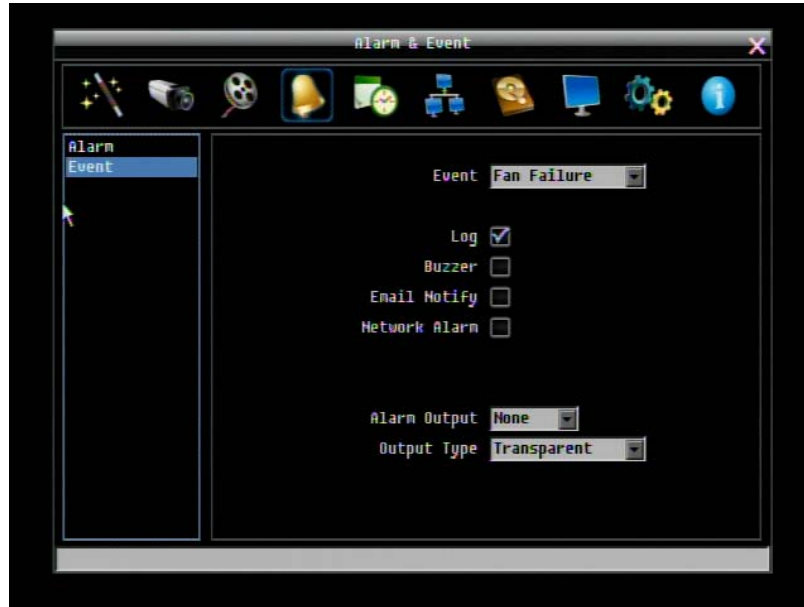

Figure 4-11 Alarm & Event Menu – Event

Event: Select from the following event types.

Fan Failure: Fan is not working.

HD Temperature: Hard drive is over the safety warning temperature.

HD Failure: If DVR fails to detect the HDD on start up, the system will create an HD failure event.

HD Full: If the DVR is not set to Overwrite in the Record Menu, an event will be created when the HDD is filled.

HD Off: If HDDs are switched off or are removed, the DVR will create an HD OFF event.

Power Loss: If power is disconnected, an alarm event will be triggered when power is restored.

Network Loss: If connection to the local network is lost, DVR will create a Network Loss event.

NOTE: This function only checks the physical connection (link) to the network. Any network behavior that blocks data connectivity (blocked ports, IP addressing errors, etc.) is not detected by this function.

Fan Failure:

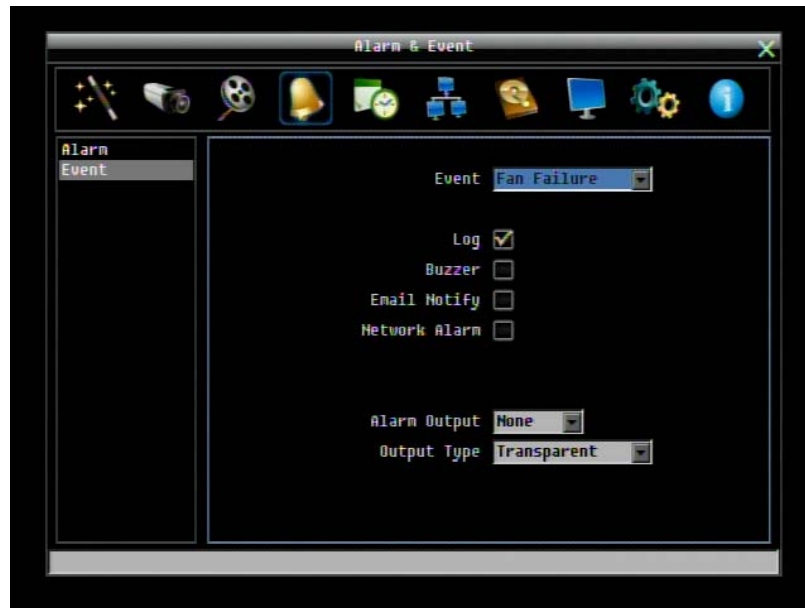

Figure 4-12 Alarm & Event Menu – Event – Fan Failure

Log: Check box to record fan failure events in the log.

Buzzer: Check box to enable buzzer when fan is not working.

Email Notify: Check box to enable email notification when fan is not working. Email operation requires that valid email settings have been entered in the Network Setting/Email setup screen.

Network Alarm: Check box to send out a network alarm to client PC. (requires PowerCon software and setting up Alarm Server in Network Setup menu)

Alarm Output: This will transmit a signal through the alarm output. It can be set to either "**NONE**" (not active), "**1**"(active), "**2**"(active), "**3**"(active) or "**4**" (active).

Output Type: Output action will be **Transparent** and cannot be changed (alarm output remains as long as the alarm condition is active).

HD Temperature:

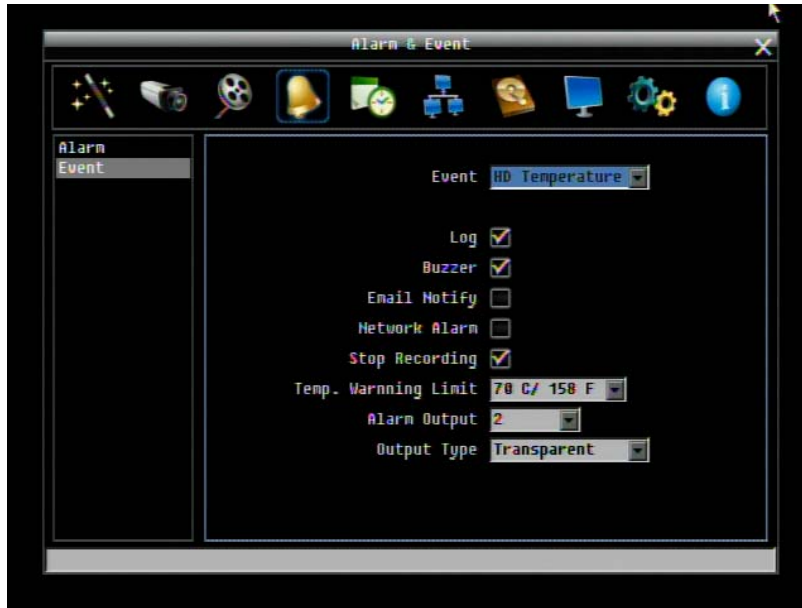

Figure 4-13 Alarm & Event Menu – Event - HD Temperature

Log: Check box to record HDD temperature events in the log.

Buzzer: Check box to enable buzzer when hard drive's temperature is over the "Temp. Warning Limit".

Email Notify: Check box to enable email notification when HDD temperature is over the "Temp. Warning Limit". Email operation requires that valid email settings have been entered in the Network Setting/Email setup screen.

Network Alarm: Check box to send out a network alarm to client PC. (requires PowerCon software and setting up Alarm Server in Network Setup menu)

Stop Recording: Check box to stop recording when HD's temperature is over the "Temp. Warning Limit".

Temp. Warning Limit: Sets the trigger temperature for HD Temperature event actions. Choose between 55°C /131°F or 85°C /185°F.

Alarm Output: This will transmit a signal through the alarm output. It can be set to either "NONE" (not active), "1"(active), "2"(active), "3"(active) or "4" (active).

Output Type: Output action will be **Transparent** and cannot be changed (alarm output remains as long as the alarm condition is active).

HD Failure:

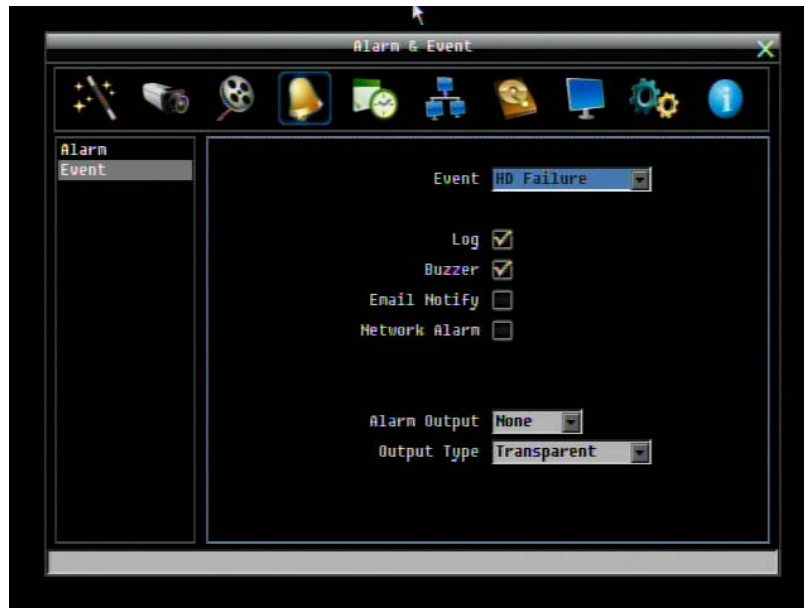

Figure 4-14 Alarm & Event Menu – Event - HD Failure

Log: Check box to record events in the log.

Buzzer: Check box to enable the buzzer if no hard drive is detected on system startup.

Email Notify: Check box to enable email notification function when HD fails. Email operation requires that valid email settings have been entered in the Network Setting/Email setup screen.

Network Alarm: Check box to send out a network alarm to client PC. (requires PowerCon software and setting up Alarm Server in Network Setup menu).

Alarm Output: This will transmit a signal through the alarm output. It can be set to either "NONE" (not active), "1"(active), "2"(active), "3"(active) or "4" (active).

Output Type: Output action will be **Transparent** and cannot be changed (alarm output remains as long as the alarm condition is active).

HD Full:

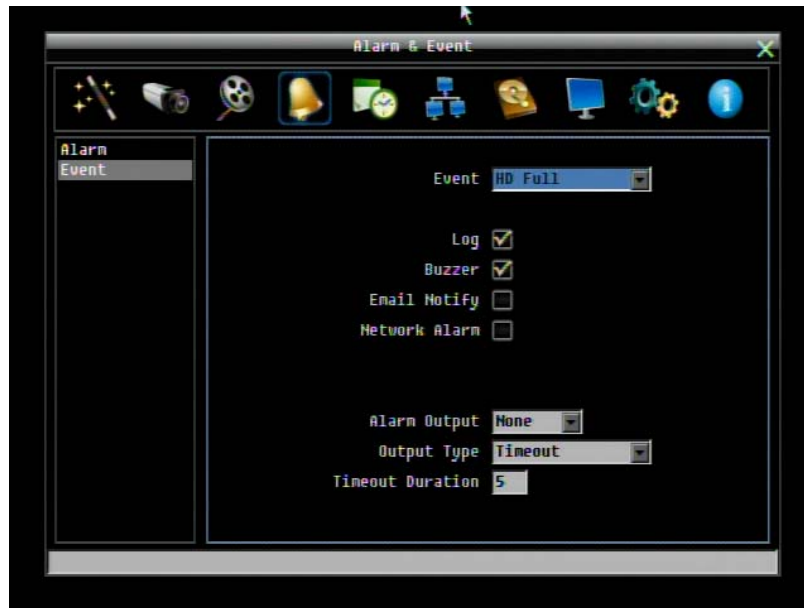

Figure 4-15 Alarm & Event Menu – Event - HD Full

Log: Check box to record events in the log.

Buzzer: Check box to enable the buzzer when hard drive is full (recommended if the Record Overwrite function is disabled. See Section 5.4.1).

Email Notify: Check box to enable email notification when HD is full. Email operation requires that valid email settings have been entered in the Network Setting/Email setup screen.

Network Alarm: Check box to send out a network alarm to client PC. (requires PowerCon software and setting up Alarm Server in Network Setup menu)

Alarm Output: This will transmit a signal through the alarm output. It can be set to either “**NONE**” (not active), “**1**”(active), “**2**”(active), “**3**”(active) or “**4**” (active).

Output Type: Output action when alarm is triggered.

Timeout: Alarm output lasts for the set time duration.

Permanent: Alarm will be continuously active until user presses the “**Enter**” key or resets the alarm remotely.

Transparent: Alarm output remains active until event ends.

Trans+Timeout: Alarm output continues until event ends, then continues for the set time duration.

Timeout Duration: The amount of time the alarm condition continues when the HD is full. Duration selectable from 1 to 150 seconds.

HD Off:

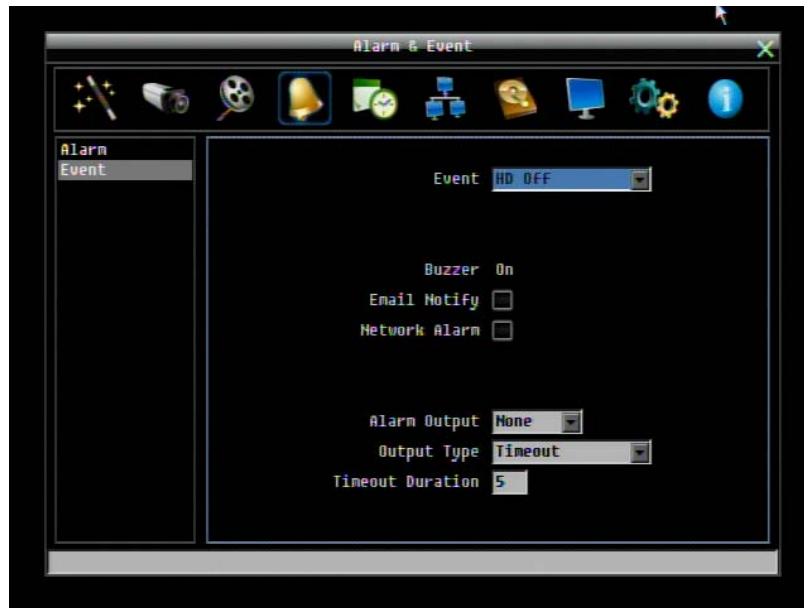

Figure 4-16 Alarm & Event Menu – Event - HD Off

Buzzer: Check box to enable buzzer if the hard drive is turned off (disconnected) or becomes disabled (cannot be detected by the system).

Email Notify: Check box to enable email notification when HD is off. Email operation requires that valid email settings have been entered in the Network Setting/Email setup screen.

Network Alarm: Check box to send out a network alarm to client PC. (requires PowerCon software and setting up Alarm Server in Network Setup menu)

Alarm Output: This will transmit a signal through the alarm output relay. It can be set to either "NONE" (not active), "1"(active), "2"(active), "3"(active) or "4" (active).

Output Type: Output action when alarm is triggered.

Timeout: Alarm output lasts for the set time duration.

Permanent: Alarm will be continuously active until user presses "Enter" key.

Transparent: Alarm output remains active until event ends.

Trans+Timeout: Alarm output continues until event ends, then lasts for the set time duration.

Timeout Duration: The amount of time the buzzer sounds when the HD is off. Duration selectable from 1 to 150 seconds.

Power Loss:

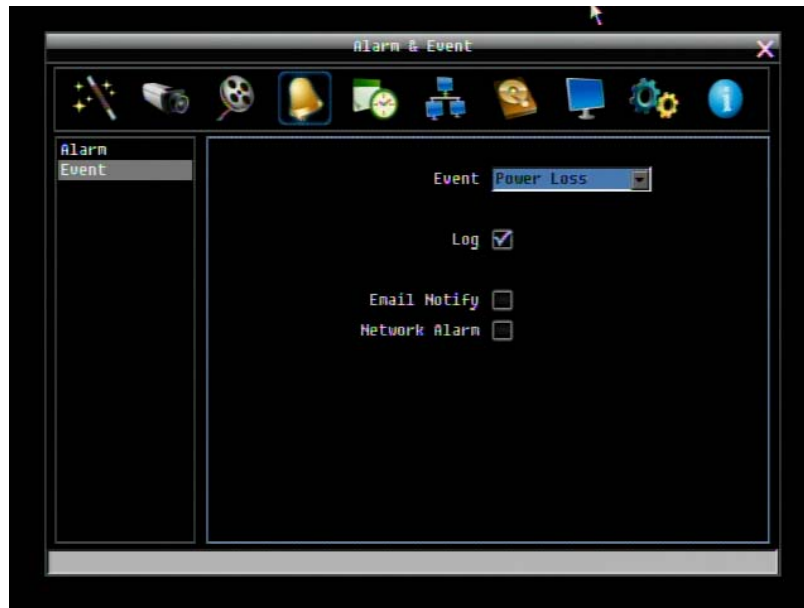

Figure 4-17 Alarm & Event Menu – Event – Power Loss

Log: Log is permanently checked for this feature. Power Loss events are always recorded by the DVR.

Email Notify: Check box to enable email notification when power has been restored. Email operation requires that valid email settings have been entered in the Network Setting/Email setup screen.

Network Alarm: Check box to send out a network alarm to client PC when power has been restored. (requires PowerCon software and setting up Alarm Server in Network Setup menu)

NOTE: As alarms and emails cannot be transmitted without power, the log entry is made when power is restored, and any notifications cannot be made until that time.

Network Loss:

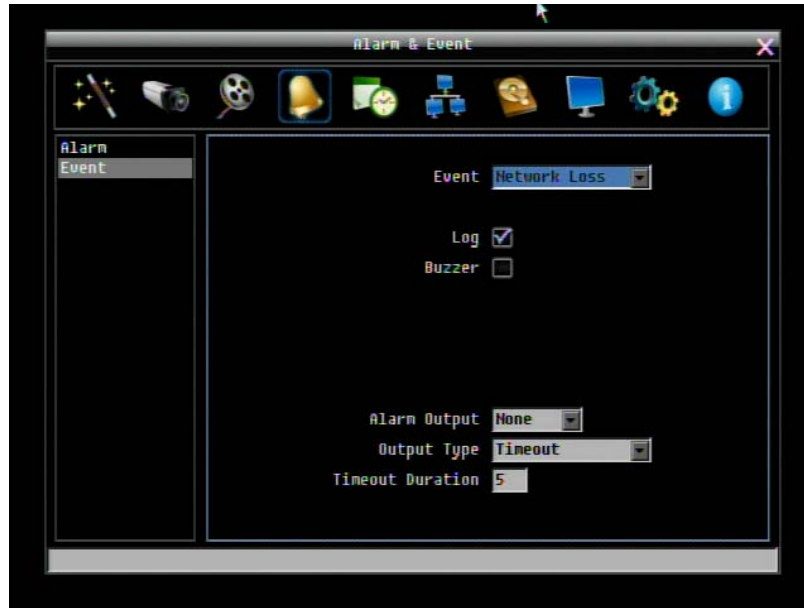

Figure 4-19 Alarm & Event Menu – Event – Network Loss

Log: Check box to record events in the log.

Buzzer: Check box to enable buzzer when network is lost.

Alarm Output: This will transmit a signal through the alarm output relay. It can be set to either "**NONE**" (not active), "**1**"(active), "**2**"(active), "**3**"(active) or "**4**" (active).

Output Type: Output action when alarm is triggered.

Timeout: Alarm output lasts for the set time duration.

Permanent: Alarm will be continuously active until user presses "**Enter**" key.

Transparent: Alarm output remains active until event ends.

Trans+Timeout: Alarm output continues until event ends, then lasts for the set time duration.

Timeout Duration: The amount of time the buzzer sounds when DVR stops recording. Duration selectable from 1 to 150 seconds.

NOTE: This function only checks the physical connection (link) to the network. Any network behavior that blocks data connectivity (blocked ports, IP addressing errors, etc.) is not detected by this function.

4.6 SCHEDULE SETTING

Figure 4-20 is a screenshot of the **SCHEDULE SETTING MENU**. In this menu you can set a unique configuration to enable recording during a specified time periods. This menu is used to configure Express Setup, Holidays and detailed Schedule settings.



Figure 4-20 Schedule Menu-Express Setup

4.6.1 Express Setup

Weekend Start: Select day and time when weekend starts.

Weekend End: Select day and time when weekend ends.

Daytime Start: Select weekday daytime starting time. (Nighttime schedule ends when Daytime begins)

Daytime End: Select weekday daytime ending time. (Nighttime schedule begins when Daytime ends)

Record Type: Select the type of recording for each time period.

Disabled: No recording during scheduled time period

Normal+Event: Continuous and Event recording

Event Only: Event recording only

Normal Frame Rate: Continuous FPS recording rate for the scheduled time period. The maximum rate is limited to the DVR's maximum recording rate divided by the number of active cameras. Selectable frame rates include 30fps, 15fps, 10fps, 7.5fps, 5fps, 1fps or 0fps (0fps means no continuous recording).

Event Frame Rate: FPS recording rate for events. Selectable frame rate includes 30fps, 15fps, 10fps, 7.5fps, 5fps, 1fps or 0fps. (0fps means no event recording).

Event Action: Check this box to enable Buzzer, Alarm out, E-mail and Network actions selected elsewhere when an event occurs during the selected time period.

Apply: Press “Apply” button bring up a confirmation window. Select “Yes” to confirm and apply the express schedule settings or “No” to cancel changes.

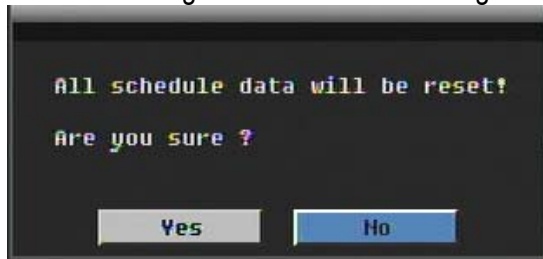

4.6.2 Holidays

In addition to setting a weekly record schedule, user can also schedule a specific recording configuration for specific days of the year.



Figure 4-21 Schedule Menu-Holidays

Date Type: Select either Holiday or Others. (Holiday and Others are two different groups, you can assign special days in these two groups)

Recurrent Type: Choose how often each scheduled day should be applied.

Disabled: This entry is ignored.

One time: This entry is used only once, on that specific date.

Month/date: Uses this entry on the same month and day, every year (e.g. January 1 for New Year's Day)

Month/weekday: Uses this entry on a specific day of a specific week in the month specified (e.g 4th Thursday in November for Thanksgiving).

Details: Specifies the date to be used.

Prev: Previous Page (30 Holidays Total)

Next: Next Page (30 Holidays Total)

4.6.3 Schedule

Controls camera recording mode by time of day on specific days of the week and/or holidays and 'other' days.



Figure 4-22 Schedule Menu-Schedule

Camera: Select a camera number to change the schedule for that camera. Each camera can be controlled during a 24 hour time block for Holiday (Hol), Other (Oth), Sunday (Sun), Monday (Mon), Tuesday (Tue), Wednesday (Wed), Thursday (Thu), Friday (Fri), or Saturday (Sat).

Time Bar: The time bar uses three different colors to distinguish each recording mode.

Gray (No Rec): No recording during this time block.

Orange (E): Only events are recorded during this time block.

Blue (N+E): (Default) Normal and event recording during this time block.

To Set Schedule using Mouse

1. Click on desired start time block (no numbers on it) on a time bar. At this time, the selected time block will be highlighted in blue frame and the entire time bar will be highlighted by red frame. There are 24 blocks on the time bar representing 24 hours respectively.
2. Set a schedule start time by clicking on a desired start time block on a time bar. Click again to confirm, and a new sequence number (for this new section) will show on this block and the current and all following blocks will turn to gray. This means this new gray timezone has a new record mode (No record).
3. Change the timezone/section to different record mode (which shows a different color) by clicking on the first (numbered) block of any section. The color switches from gray -> orange -> blue, every time the user clicks the first block of a section.
4. Repeat clicking on the first block (indicated by a sequence number on it) of any timezone, this timezone will change from one color to another, which means switching the record mode. The color switch sequence is gray->orange->blue.

Schedule Setting from front panel

1. **Enter schedule setting mode:** Select the "Schedule" icon on the configuration menu and press the 'Enter' button; the left hand column will be highlighted in a blue frame. Use the up/down arrows to highlight the 'Schedule' choice and press the "Enter" button to enter the schedule setting mode. At this time, the whole editing area at the lower right side will be highlighted within a blue frame. See below image.



2. **Enter camera selection mode:** Use Up/Down arrow key to switch to Camera selection mode. When Camera selection mode is selected, the list of camera numbers will be highlighted in a blue frame. See below image.



3. **Selecting camera:** Use Right/Left arrow keys to select desired camera to configure. Selected camera number will be highlighted by a blue frame. See above image.
4. **Enter time bar editing mode:** Use Up/Down arrow key to switch to **time bar editing mode**. When this mode is selected, all 9 time bars will be highlighted within a blue frame.
5. **Select desired time bar for setting:** press the “Enter” button; the first time bar will be selected for setting and highlighted in a red frame. See below image. Use Up/Down arrow key to select the desired time bar for setting.



6. **Editing blocks in a time bar:** when a time bar is selected (highlighted in red frame), press the “Enter” button, and the first block of this bar will be selected (highlighted in blue frame). Use Right/Left arrow keys to select the desired block as the starting time, and press Enter button to confirm. At this time, the current and all following blocks will turn into gray, which means this gray timezone has been set to the recording mode of gray(No Rec). User can also change the timezone to a different record mode (with different color) by following instructions in the next step.



7. **Changing recording mode (color) of a timezone:** Use Right/Left arrow key to switch to the first block (with number on it) of a timezone. Clicking Enter button, and this timezone will switch to another color, which means switching to another record mode. The color switch sequence is gray->orange->blue.
8. To exit the screen, press the "Menu/Esc" button as required to move up the menu levels and, if desired, out of the menu system.

Click the **"Edit Timezone"** button to edit the recording parameters for a time zone.

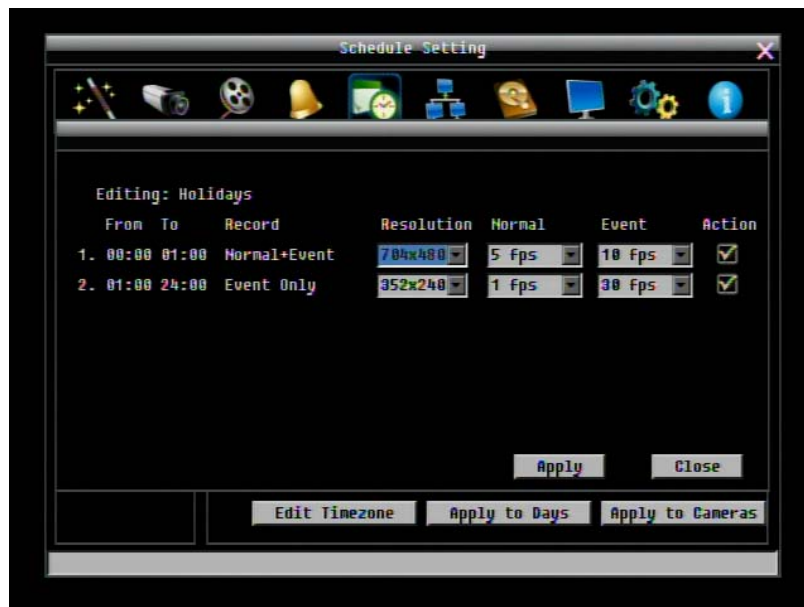

Figure 4-23 Schedule Menu-Schedule-Edit Timezone

Editing Timezone:

From: Displays time zone start time

To: Displays time zone end time

Record: Displays Record mode

Resolution: Select recording resolution for analog camera. Resolution for HD-CCTV is fixed, any setup or change is not required.

NTSC: 704x480 / 704x240 / 352x240

PAL: 704x576 / 704x288 / 352x288

Normal: Frame rate in frames (images) per second (FPS) for continuous recording. The speed is limited by the maximum total recording capacity of the DVR as allocated across all the installed cameras, with an upper limit of 30 FPS (NTSC – 25 PAL) per individual camera (real time recording). The EDR HD-2H14 DVR is capable of recording 420 4CIF (704x480) sized frames per second (NTSC; 300 PAL) plus 30 Full HD (1920x1080) or 60 HD (1280x720) sized framed per second. The EDR HD-4H4 DVR is capable of recording 120 4CIF (704x480) sized frames per second (NTSC; 300 PAL) plus 60 Full HD (1920x1080) or 120 HD (1280x720) sized framed per second.; Thus the DVR can record a combination of CIF, 2 CIF and 4 CIF images, with different combinations of image size/resolution and different FPS rates on different cameras, so long as the total equivalents allocated is not greater than the max. total recording capacity. Choices for possible record speeds are 30, 15, 10, 7.5, 5, 3, 2 and 1 FPS.

Action: Check this box to enable notifications enabled elsewhere (Buzzer, Alarm out, E-mail, and Network Alarm) when an event occurs.

Apply to Days: This button can be used to copy schedules to other days. Select which days you wish to copy to. "Select All" selects all days, "Clear All" deselects all days. Click "OK" to copy the settings or "Cancel" to exit without copying.

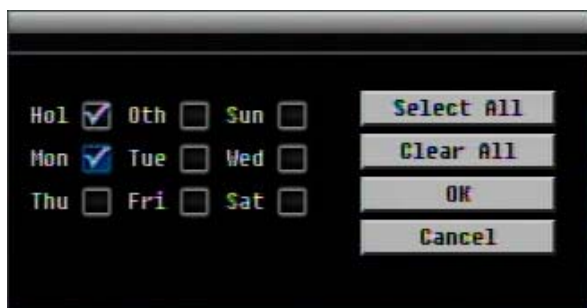

Apply to Cameras: This button can be used to copy schedules to other cameras. Select which cameras you wish to copy to. "Select All" selects all cameras, "Clear All" deselects all cameras. Click "OK" to copy the settings or "Cancel" to exit without copying.



4.6.4 Alarm Action

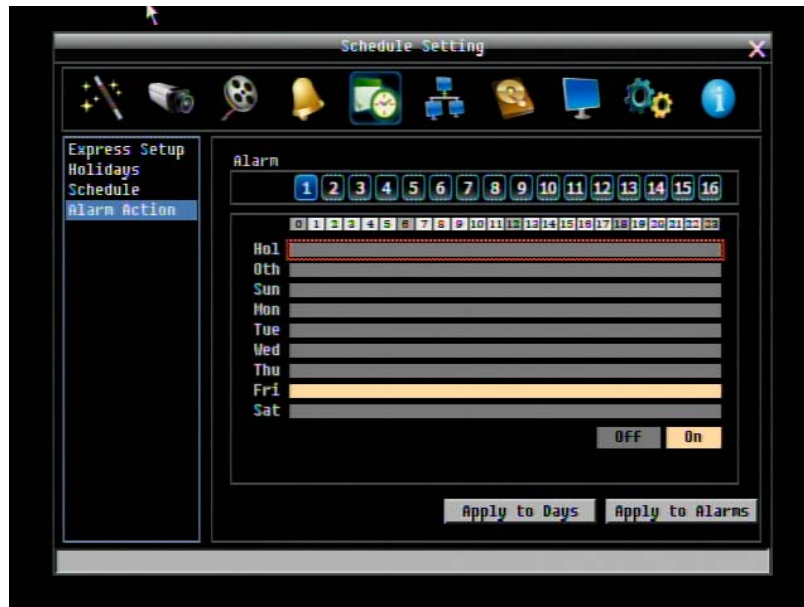

Figure 4-24 Schedule Menu-Alarm Action

Defines recording response to “alarm” input trigger signals by time of day on specific days of the week and/or holidays and ‘other’ days.

Alarm: Select a number to change the schedule for that alarm input trigger. Each alarm can be set on a 24 hour time block for Holiday (Hol), Other (Oth), Sunday (Sun), Monday (Mon), Tuesday (Tue), Wednesday (Wed), Thursday (Thu), Friday (Fri), or Saturday (Sat).

Time Bar: The time bar uses two different colors to distinguish each recording mode.

Off: No recording during this time block.

On: Alarm action will be recorded during this time block.

To Set Schedule using Mouse

1. Click on the “Alarm Action” choice, then click on the right hand side of the screen. The border for that region will now turn blue.
2. Click on the number of the alarm trigger input you wish to configure. That number will be framed in blue.
3. Click on a desired start time block on a time bar. There are 24 blocks on the time bar representing 24 hours respectively. At this time, the selected time bar will be highlighted by a red frame and the selected block will be highlighted in blue frame. Initially, the selected block and all following blocks will be gray, which means this gray timezone has been set to the recording mode corresponding to gray (alarm action recording OFF).

4. Change the section to different mode (with a different color) by clicking on the first block of the section. The color switches from gray -> orange -> gray, every time user clicks the first block of a section. Orange indicates 'alarm action recording ON'.
5. To set the end of a timezone, select the time block following the end of the timezone defined in the step above. The first click will highlight the block in blue. A second click will toggle the state/color of that block and the remainder of the time bar, ending the above defined timezone

Alarm Action Setting from front panel

1. **Enter Alarm Action setting mode:** highlight the "Alarm Action:" menu choice and press the "Enter" button to enter Alarm Action setting mode. At this time, the whole editing area at the right side will be highlighted within a blue frame. See image below.



2. **Enter alarm selection mode:** Use Up/Down arrow key to switch to Alarm selection mode.



3. **Selecting alarm:** Use Right/Left arrow key to select an alarm to configure. Selected alarm number will be highlighted by a blue frame. See above image.
4. **Enter time bar editing mode:** Use Up/Down arrow key to switch to **time bar editing mode**. When this mode is selected, the area surrounding the time bars will be highlighted within a blue frame..
5. **Select desired time bar for setting:** press the Enter button, the first time bar will be selected and highlighted in a red frame. See below image. Use the Up/Down arrow keys to choose the desired time bar for setting.

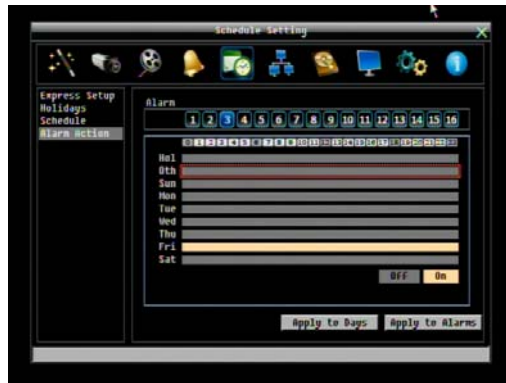

6. **Editing blocks in a time bar:** when a time bar is chosen (highlighted in red frame), the press Enter button to select that time bar for configuration; then the first block of this bar will be selected (highlighted in blue frame). Use Right/Left arrow key to move to the desired block for the starting time, and press the Enter button again to confirm. At this time, the current and all following blocks will turn into gray, which means this gray timezone has been set to the recording mode of gray (Alarm Action off). User can also change the timezone to a different record mode by following instructions in the next step.



7. **Changing recording mode (color) of a timezone:** Use Right/Left arrow key to select the first block of a timezone. Press the Enter button, and this timezone will switch to another color, which means switching to another recording mode. The color switch sequence is gray->orange->gray.

Apply to Days: This button can be used to copy schedules to other days. Select which days you wish to copy to. "Select All" selects all days, "Clear All" deselects all days. Click "OK" to copy the settings or "Cancel" to exit without copying.

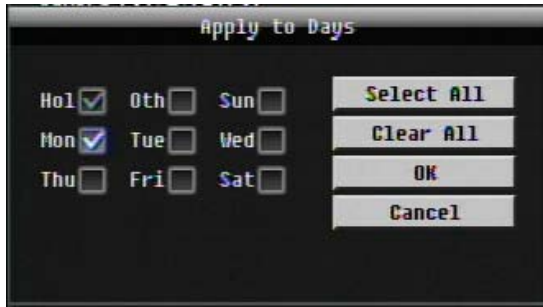

Apply to Cameras: This button can be used to copy schedules to other cameras. Select which cameras you wish to copy to. "Select All" selects all cameras, "Clear All" deselects all cameras. Click "OK" to copy the settings or "Cancel" to exit without copying.



4.7 NETWORK SETTING

Figure 4-25 is a screenshot of the **NETWORK SETTING MENU**. This menu is for configuring the DVR for a network connection.

NOTE: Since every Network Configuration is different, please check with your Network Administrator or ISP to see if your DVR should use specific IP addresses and/or port numbers.

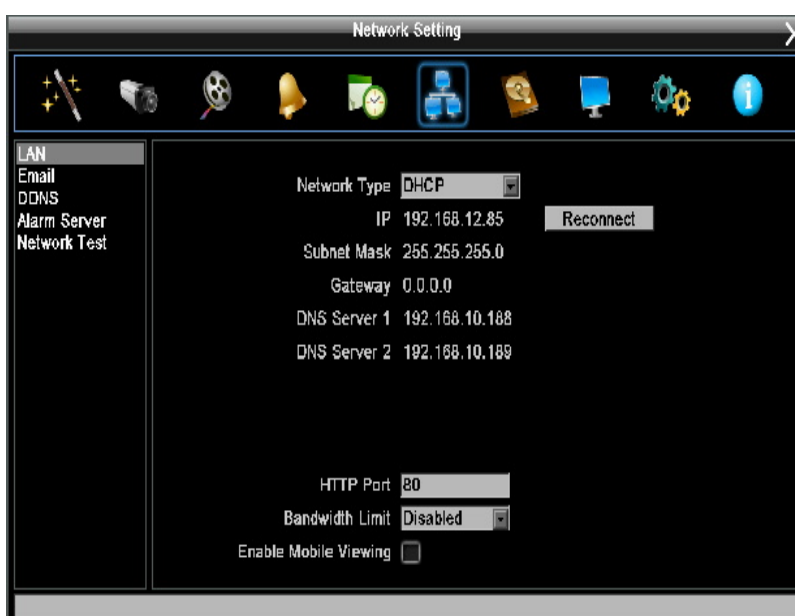

Figure 4-25 Network Menu – LAN

4.7.1 LAN

Network Type:

Static IP: User can set a fixed IP for network connection.

DHCP: DHCP server in LAN will automatically assign IP configuration for the network connection

PPPoE: For direct connection to DSL ONLY. Verify with your ISP if they use PPPoE.

IP: This field shows the DVR's current IP Address. A static IP address must be set manually. If DHCP or PPPoE is selected, this value will be assigned automatically.

Subnet Mask: This field shows the subnet mask for your network so the DVR will be recognized within the network. If DHCP or PPPoE is selected, this value will be assigned automatically.

Gateway: This field shows the gateway on your network for the DVR to use when communicating with any devices not on the local network. If DHCP or PPPoE is selected, this value will be assigned automatically.

DNS Server 1: This field shows the primary DNS server for your network. If DHCP is selected and an internet connection is available, this value should be assigned automatically. This field must have a valid DNS address in order to use the DDNS feature (see Sections 4.6.3 and 7 DDNS for more detail).

DNS Server 2: This field shows the secondary DNS server for your network.

HTTP Port: Port number for HTTP/WEB communication.

Additional information:

1. Set up the DVR Network Menu according to the instructions detailed in the Networking chapter of this DVR's manual.
 - a. If using DHCP, all settings will be detected automatically. While DHCP is a useful tool for determining the network settings, if you set up your DVR in this manner *its IP address may change at different times for different reasons*, particularly after a power failure. *If the IP address of the DVR changes, you may have difficulties accessing your DVR locally and/or remotely. It is strongly recommended that you assign a fixed (static) IP address to your DVR*, and that in order to avoid address conflicts the IP address assigned be outside of the DHCP range of addresses your router issues to DHCP clients. Please do not set the DHCP address issued to the DVR by the router as its static IP address unless you take specific steps that program your router to prevent such address conflicts.
 - b. If using a Fixed IP (**recommended**), you will need to input the information manually. In order for DDNS to work, you must enter valid data, compatible with your network, for all four of the network setting fields: IP address, subnet mask, default gateway and the DNS Address (depending on your network hardware and configuration this may be the IP address of your router/gateway, or it may be the actual IP address of the local DNS server). The DNS server IP is required because your DNS server provides critical information necessary for the DVR to communicate with the DDNS server.

You can obtain the actual DNS IP from your Internet Service Provider (ISP); or, from a PC located on the same LAN as the DVR, go to <http://www.dnsserverlist.org/> to obtain a list of the IP addresses of their recommendation of the best servers to use for your location.

2. If you are connecting through a router, make sure that you have 'opened up' all the required network ports in the *port forwarding* section of your router's setup options. That is, you have directed the router to send any incoming traffic using those IP ports to the LAN IP address of the DVR. Useful information about router port forwarding can be found at www.portforward.com. Different routers may use different terms for port forwarding function. For instance, D-Link calls it *virtual server*, Netopia calls it *pinholes*.

The default port for the ENDEAVOR SD+HD is: 80

Note: Port 80 is the default port used for web browsing. Because of this, in order to prevent the average user from hosting a web server, *most ISPs BLOCK traffic using port 80* from reaching the average site. If you only plan to view your DVR on a LAN, you can use port 80, and don't have to concern yourself with DDNS or routers. However, if you desire remote access to your DVR, perhaps using DDNS (optional), you MUST select functional ports and set up the port forwarding in your router. Other ports, such as 8080 and 8000 are sometimes blocked by ISPs as well.

What port(s) should be used? There are 65,535 valid IP ports to choose from. These are broken down into three groups:

- Well Known Ports 0 thru 1023
- Registered Ports 1024 thru 49151
- Dynamic and/or Private Ports 49152 thru 65535

So, rather than encounter a port conflict by choosing a port commonly used for another purpose (like port 25 for SMTP mail or port 448 for secure sockets), choose an 'unusual' port number. For example, add 50,000 to your house number: 50,123 is less likely to lead to a port conflict. For a list of the known and registered ports, see <http://www.iana.org/assignments/port-numbers>

Bandwidth Limit: Specify, disabled / 128 K / 256 K / 512 K / 768K / 1M / 3M bps. This is the maximum bandwidth that the DVR is allowed to use on the network. This is a useful function when connecting the DVR to busy or heavily loaded networks, or when accessing the DVR(s) over a WAN.

Enable Mobile Viewing: Check this box to allow unrestricted external connection of mobile phones, and other rtsp capable devices for viewing via 3GPP/rtsp streaming.

4.7.2 EMAIL



Figure 4-26 Network Menu – Email

SMTP Server: Assign the SMTP (e-mail) server's name.

NOTE: For more reliable email service, use the server's IP address.

SMTP Port: Assign the port number used by the SMTP server.

Authentication: Check this box if the SMTP server requires authentication (user name / password).

SSL: Check the box if mail server needs communication to be encrypted by SSL.

User name: Input the login user name if the SMTP server requires authentication.

Password: Input the password if the SMTP server requires authentication.

Confirm: Re-enter password.

Sender Email: Input the e-mail address of the sender (the DVR). Sender's e-mail address has to match the user name and password above.

Receiver Email 1: Input the first e-mail address that event messages are sent to.

Receiver Email 2: Input the second e-mail address that event messages are sent to.

Receiver Email 3: Input the third e-mail address that event messages are sent to.

Email Subject: Input email subject.

4.7.3 DDNS

DDNS Server: Select either "EverfocusDDNS" or "www.dyndns.org" as the DDNS provider. If DDNS will not be used, simply select "Disable".

EverfocusDDNS

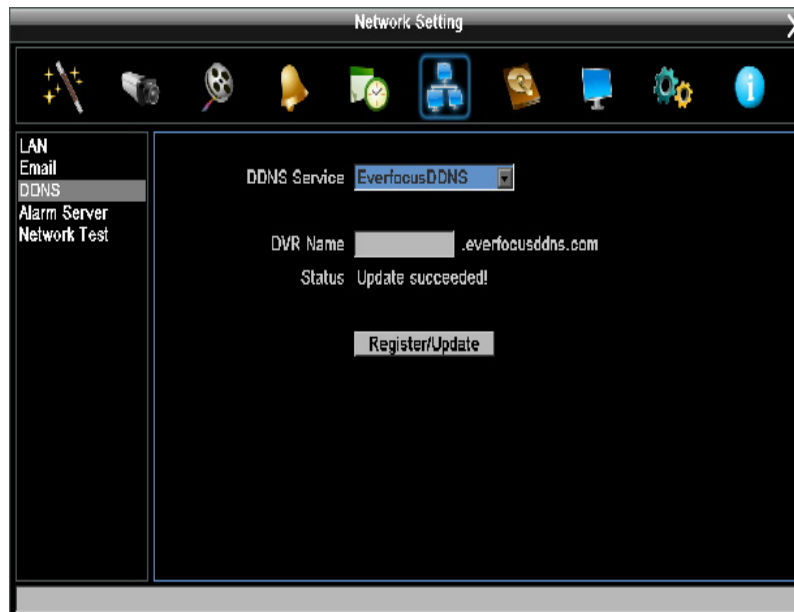

Figure 4-27 Network Menu – DDNS-EverfocusDDNS

DVR Name: Input the desired name for the DVR

Register/Update: Click the button to submit and register the name to the Everfocus server.

The DDNS name you choose must be unique; that is, it must not already be in use. Please go to the website <http://everfocusddns.com> and check that the name you wish to use is available.

PLEASE NOTE: The name of the DVR **cannot include a space, or a dot (period) or any special characters** particularly ~ ! @ # \$ % ^ & * () + < > " ; : . , _

In the DVR's Network Menu above, go to DDNS. Choose "everfocusddns.com" for the Server and put in your chosen name (verified available and without special characters) for DVR Name/hostname.

Press the Select or Submit/Update button to synchronize the DVR with the DDNS server. You should see an indication of "Success" on the screen. If you see "Could Not Find Server" or any other error message instead, double-check your network settings and DDNS name and resubmit the DDNS name until you get "Success". You should now be able to connect by typing in the host name you created.

Example: <http://hostname.everfocusddns.com>

It is not necessary to append the HTTP port number to the DDNS name. The EverFocus DDNS server not only keeps track of your DVR's IP address, it keeps track of the ports too!

www.dyndns.org



Figure 4-28 Network Menu – DDNS- www.dyndns.org

Host name: Host name created through the dyndns account.

User name: User name of the dyndns account.

Password: Password of the dyndns account.

Confirm: Re-enter password.

Note: For more details on DDNS setup, please see "Chapter 7 - Everfocus DDNS Setup".

4.7.4 Alarm Server

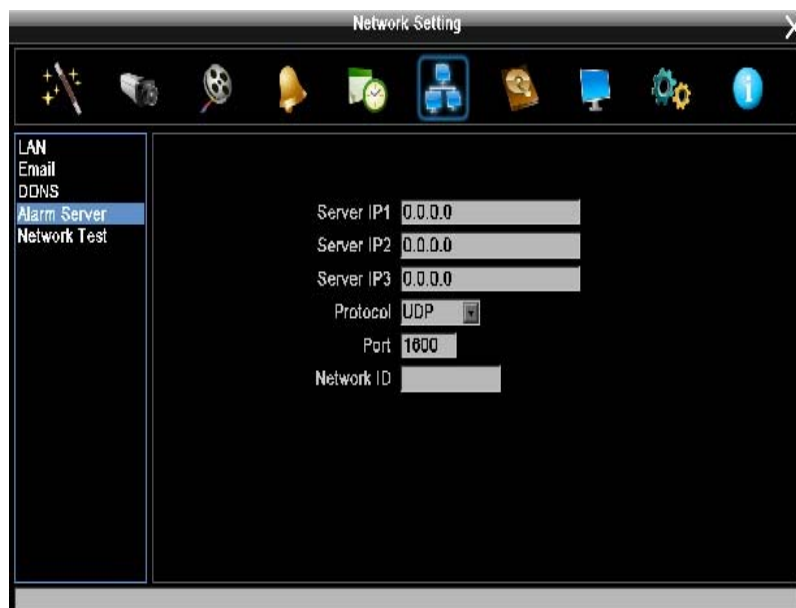

Figure 4-29 Network Menu – Alarm Server

This menu defines the parameters for communicating with a PC running PowerCon software.

Server IP1~3: IP address of client PC with installed PowerCon Software. The network alarm can be transmitted to up to 3 addresses.

Protocol: Select the protocol type for alarm transmission:

UDP: User Datagram Protocol

TCP: Transmission Control Protocol

Port: Select the transmission port for network alarm messages

Network ID: The network ID is an identifier for the alarm transmitter (DVR sending the alarm).

4.7.5 Network Test



Figure 4-30 Network Menu – Alarm Server

Enter the server's IP address to be tested. Press "Ping" button to ping the IP address.

4.8 DISK INFORMATION

4-30 is a screenshot of the **DISK INFORMATION MENU**. This menu is used to review the DVR's hard drive settings and status. No values in this screen can be changed by the operator.



Figure 4-30 Disk Menu-Disk

4.8.1 Disk

Record Time (Start): Shows earliest recorded time on the DVR.

Record Time (End): Shows latest or most current recorded time on the DVR.

Disk: Select disk number.

Health Status: Displays current status of the selected disk.

Disk Temperature: Displays current disk temperature of the selected disk.

Disk Size/Total: Shows total disk size of the selected disk.

Disk Size/Usage: Shows percentage of used disk space for the selected disk.

4.8.2 Lock/Format

4-31 is a screenshot of the **DISK LOCK/FORMAT MENU**. This menu is used to control the portion of the DVR's hard drive reserved for locked event recordings, and to format drives(s) if necessary.

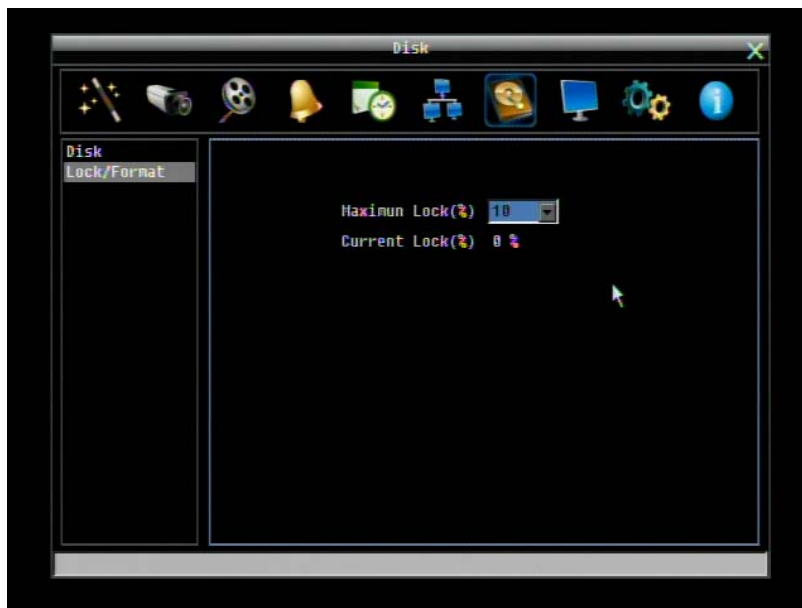

Figure 4-31 Disk Menu-Lock/Format

Maximum Lock (%): Sets the maximum lock percentage of the HDD volume. After setting the lock percentage, conditions where video is written to the locked area can be enabled/disabled in three places

- i. "Camera > Basic Setting > Motion > Auto Lock"
- ii. "Alarm & Event > Alarm > Auto Lock".
- iii. Lock or unlock the file manually in search result list

Current Lock (%): Displays the current lock percentage of HDD volume. If amount of locked data has reached the maximum lock percentage, the DVR will be unable to lock new data.

4.9 DISPLAY SETTING

Figure 4-32 is a screenshot of the **DISPLAY SETTING MENU**. This menu will walk you through the Main Monitor On-Screen Display (OSD) and Main Monitor Sequential setup.



Figure 4-32 Display Menu – Monitor OSD

4.9.1 Monitor OSD

These are the display options for the Main Monitor.

Main Monitor

Camera Title: Check the box to display camera titles.

Date/Time: Check the box to display current date/time.

Event Status: Check the box to display event status.

HDD Status: Check the box to display hard drive status.

Playback Date/Time: Check the box to display playback date/time.

Playback Status: Check the box to display playback status.

Text Insert: Check the box to display text inserted.

Screen Mode: Select the suitable screen mode. Selections are: 1920x1080(16:9) P50 ; 1920x1080(16:9) CVT; 1920x1080(16:9) P60; 1280x1024 (4:3); 1280x720 (16:9) P50; 1280x720 (16:9) P60; 1024x768 (4:3); 800x600 (4:3).

4.9.2 Main M/T SEQ



Figure 4-33 Display Menu – Main M/T SEQ

Step: Sequence order. For reference.

Camera: Select which camera appears in the current step.

Dwell (sec): Set the dwell time for each step. Sequence dwell time can be set from 0 to 99 seconds.

Sequence repeats continuously from steps 1 through 20 until interrupted.

4.10 SYSTEM SETTING

Figure 4-35 is a screenshot of the **SYSTEM SETTING MENU**. This menu is for setting up the general system parameters for the DVR.



Figure 4-34 System Menu – Date/Time

4.10.1 Date/Time

Date: Set current Date.

Time: Set current Time.

Date Format: Choose date format from yyyy/mm/dd, dd/mm/yyyy, and mm/dd/yyyy.

Time Format: Change time format between 12H and 24H mode.

Time Zone: Set the time zone that the DVR adjusts to when updating from the time server.

NTP: Select "Enable" or "Disable" NTP time synchronization.

NTP Server: Displays the time server address that the DVR uses for time synchronization. Requires operating network configuration and WAN or LAN access to a compatible NTP server.

To find a compatible NTP address, please follow these steps:

- a) Go to a PC that is connected to the internet.
- b) Click on "START" -> "RUN" -> type "command" and press "OK".
- c) In the DOS Prompt, type "ping pool.ntp.org" to find out the IP address of an NTP Server.

NTP Update Interval: The frequency that the system automatically updates the time via the NTP server. Select Daily, Weekly, or Monthly.

4.10.2 Daylight Saving

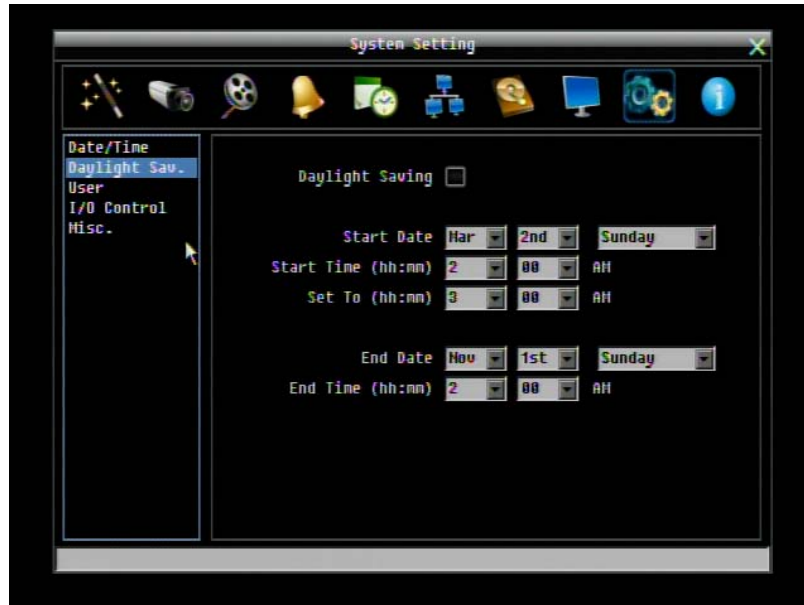

Figure 4-35 System Menu – Daylight Saving

Daylight Saving: Check the box to enable automatic daylight saving time adjustment.

Start Date: Set the start date for daylight saving time.

Start Time (hh:mm): Set the time when daylight saving time begins.

Set To (hh:mm): This is what the time will change to when daylight saving begins. For most regions, this will be one hour ahead of the “Start Time”.

End Date: Set the end date for daylight saving time.

End Time (hh:mm): Set the time when daylight saving time ends.

The time change difference on the End Date will be the same as the difference between the Start Time and End Time entered for the Start Date (typically 1 hour as in the example shown).

4.10.3 User

User Menu is where you can add or delete different login IDs on the system as well as set access levels. See the charts below for a listing of the rights associated with each access level.

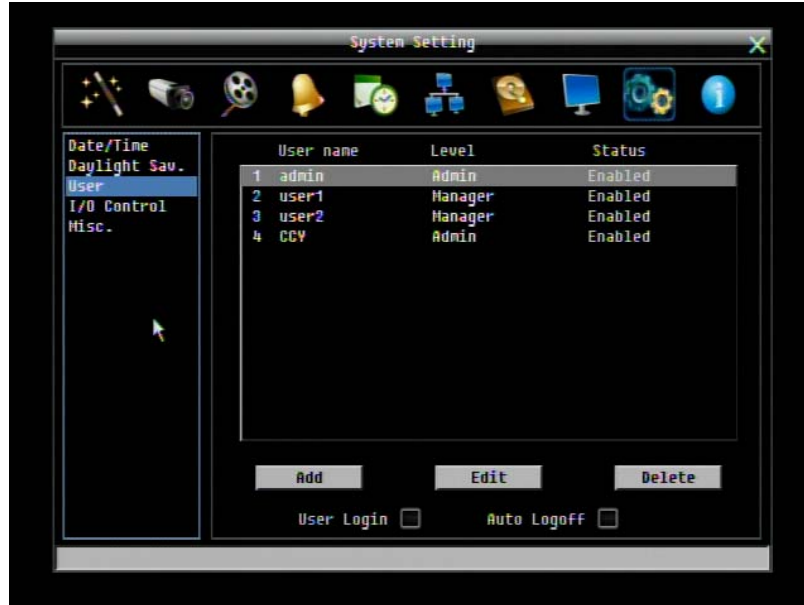

Figure 4-36 System Menu – User

Add

Click “Add” button to add a new user. Set the name (case-sensitive), password, access level and status. Press “Add” button to confirm a new user or “Cancel” to exit without making changes.

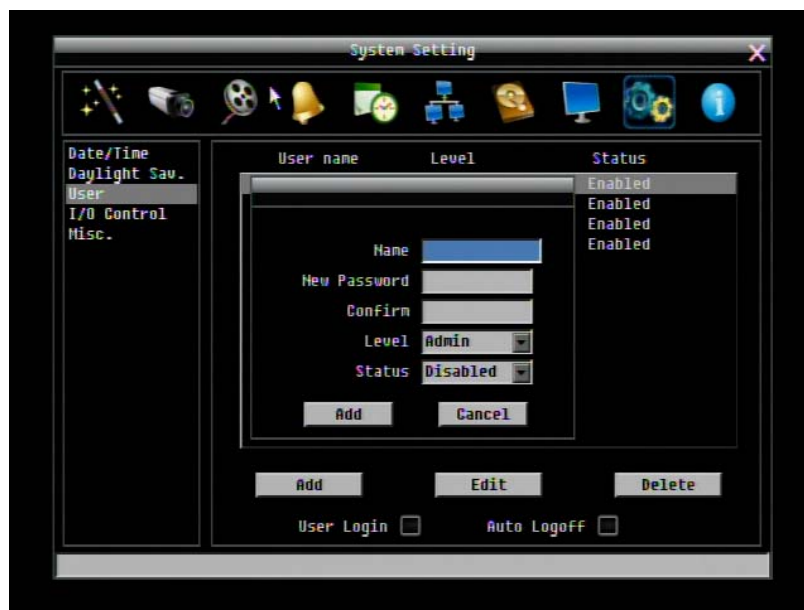

Figure 4-37 System Menu – User - Add

Edit

Click “Edit” button to make changes to an existing user account. Press “Save” button to save changes or “Cancel” to exit without making changes.

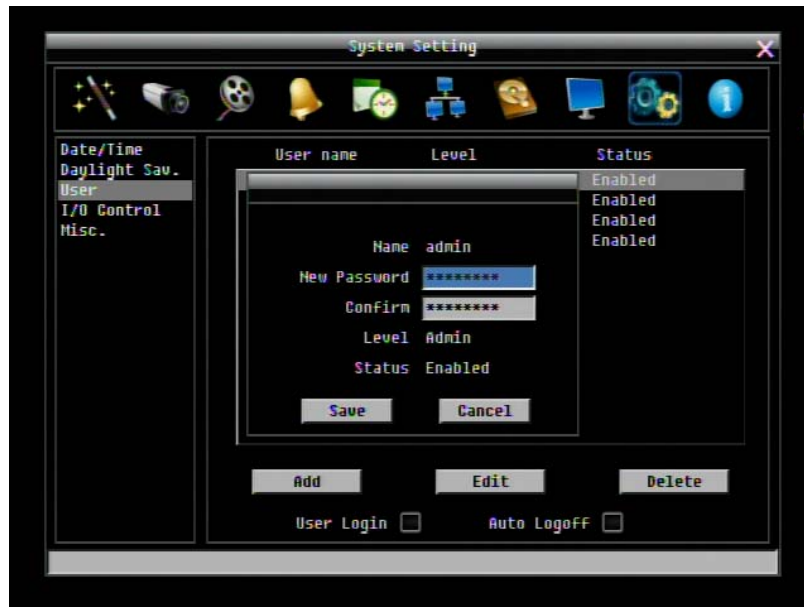

Figure 4-38 System Menu – User - Edit

User Login: Check this box to require user login for menu access from the front panel. When this is disabled, no username or password is required to access the system from the front panel, and all users operate with ADMIN rights from the front panel.

Auto Logoff: Check this box to automatically logoff the current front panel user after 3 minutes of inactivity.

There are three system access levels. The following charts show the rights of each level.

Main Menu at the DVR

User Level and Right			
RIGHT	ADMINISTRATOR	MANAGER	OPERATOR
Playback	OK	OK	NO
PTZ	OK	OK	NO
Layout	OK	OK	OK
Channel	OK	OK	OK
Display	OK	OK	OK
Sequence	OK	OK	OK
Monitor	OK	OK	OK
Zoom	OK	OK	NO
Search	OK	OK	NO
Copy	OK	OK	NO
Config.	OK	OK	OK
View Covert Cameras	OK	OK	NO
Logout	OK	OK	OK

Configuration Menu at the DVR

User Level and Right			
RIGHT	ADMINISTRATOR	MANAGER	OPERATOR
Express	OK	NO	NO
Camera	OK	NO	NO
Record/Play	OK	NO	NO
Alarm/Event	OK	NO	NO
Schedule	OK	NO	NO
Network	OK	NO	NO
Disk	OK	NO	NO
Display	OK	OK	NO
System	OK	(1)	(2)
Info	OK	OK	Ok
Log	OK	NO	NO

1. Only USER submenu; only access to change own password, and to access operator ID's
2. Only USER submenu; only ability to change own password.

4.10.4 I/O Control

Figure 4-40 is a screenshot of the I/O Control Setting Menu. This menu is used to define the settings for controlling the DVR through RS485, and for DVR control of attached PTZ cameras.



Figure 4-39 System Menu – I/O Control

RS232

Type: Select “Control” to allow the command sent to the DVR by an EKB500. The other option “Text Insert” is reserved for POS integration.

Baud Rate: This field is to set the speed at which is used to transmit instruction or information through the RS232 port on the DVR. There are eight different speeds: 1200 BPS, 2400 BPS, 4800 BPS, 9600 BPS, 19200 BPS, 38400 BPS, 57600 BPS and 115200 BPS.

Data Bit: This field is the data bit at which you will be transferring. There are two settings for this option: 8 or 7.

Stop Bit: This field is to set the stop bit for the RS232 connection. There are two different stop bits, 1 or 2.

Parity: This field is to select the parity level at which you will be connected. You can choose between None, Odd, or Even parity levels.

RS485

PTZ Protocol: Select PTZ protocol, choose from the following protocols: Transparent, Pelco D, Pelco P, Everfocus, or Samsung. (*NOTE: all cameras on the bus must use the same protocol*)

485 ID: This is the ID used by the EKB500 to send commands to the DVR. On an RS485 connection, every device (PTZ, DVR and controller) must be assigned a unique ID number between 0 and 127.

Baud Rate: The speed used to transmit instructions or information through the RS485 port on the DVR. Choose from the following speeds: 1200, 2400, 4800, 9600, 19200, 38400, 57600, 115200 BPS.

Data Bit: The number of data bits used in a data packet or word. This can be set to 8 or 7.

Stop Bit: This field is to set the number of stop bits indicating the end of a data packet. This can be set to 1 or 2.

Parity: This selects the transmission error checking rule. Choose either None, Odd, or Even.

Control

One remote control can be used to operate several DVRs. The DVR to be addressed is selected by pressing the key corresponding to its ID number on the remote control.

IR Remote ID: ID used by the remote control to select this DVR. This can be set from 1 to 4.

4.10.5 Misc.



Figure 4-40 System Menu – Firmware & Misc.

Firmware

Current Firmware Version: Displays the current version.

Firmware Upgrade: Press “Upgrade” to upgrade the firmware.

***NOTE:** To perform a Firmware Upgrade, you will need to connect a USB flash device with the desired firmware. **Do not disconnect the USB device or turn off the power to the unit during the upgrade;** this can cause the system to fail to recover, requiring factory service to repair.*

Configurations

Load Factory Default: Click “Load” to restore all menu settings to the default values. User Account, Network IP Settings, and Time are not affected. 3GP streaming is disabled by default.

Load From USB: Click “Load” to upload saved DVR configuration settings from a USB flash device.

Save To USB: Click “Save” to save the current DVR configuration settings to a USB flash device.

Language: Choose which language the DVR uses. The available languages may vary based on region.

4.11 INFORMATION

Figure 4.42 is a screenshot of the **INFORMATION MENU**. This menu displays important (read only) system information.

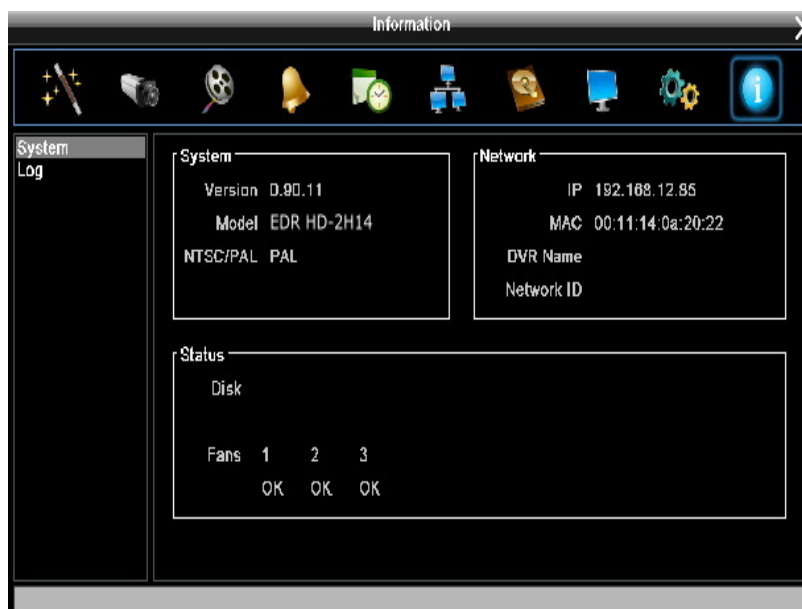

Figure 4-42 Information Menu – System

4.11.1 System

System

Version: Displays firmware version number.

Model: Displays DVR model number.

NTSC/PAL: Displays current video format selected based video format on Camera 1 input at boot up.

Network

IP: Displays the DVR's current IP Address as set in the Network or Express Setup screen.

MAC: Unique address of the DVR's internal network card. This option cannot be changed.

DVR Name: Displays DVR DDNS name if configured.

Network ID: The ID number for the PowerCon alarm network as set in the Alarm Server screen.

Status

Disk: Displays status of the installed disk(s); normal disk operation is indicated by "OK".

Fans: Displays fan status; normal fan operation is indicated by "OK".

4.11.2 Log

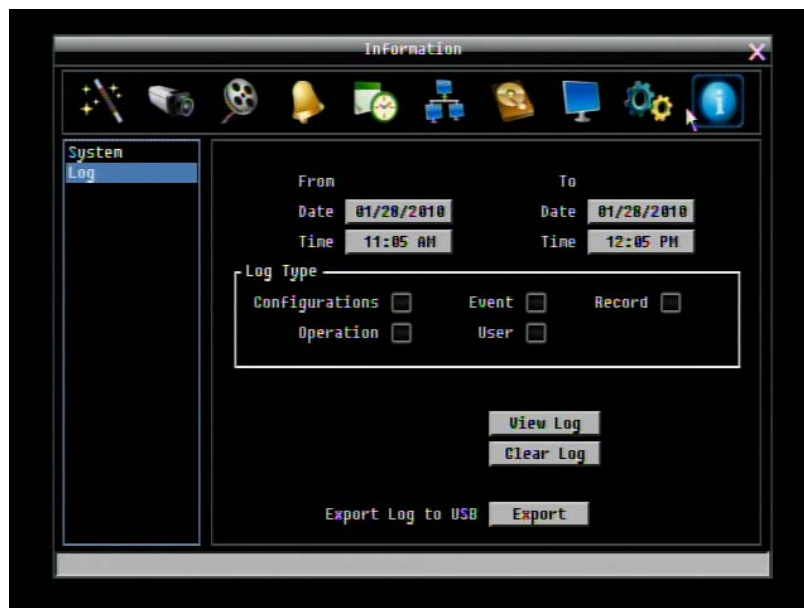

Figure 4-43 Information Menu – Log

This screen is used to choose, display and/or export log entries.

From

Date: Select starting date of log to be displayed.

Time: Select starting time of log to be displayed.

To

Date: Select end date of log to be displayed.

Time: Select end time of log to be displayed.

Log Type:

Configurations: to see log entries related to configuration changes.

Event: to see log entries related to events.

Record: to see log entries related to recording changes.

Operation: to see log entries related to operation changes.

User: to see log entries related to user access.

View Log: Press "View Log" button to view the log. See Figure 4-44 for more detail.

Clear Log: Press "Clear Log" button to clear the log.

Export Log to USB: Press "Export" button to export log data to USB.

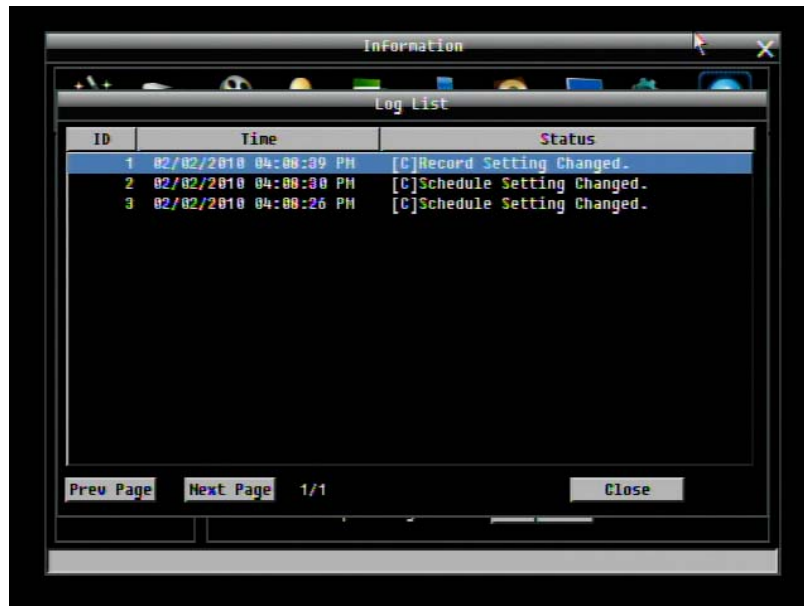

Figure 4-44 Log List

Prev Page: Go to the previous page of log.

Next Page: Go to the next page of log.

Close: Close the window

5 Networking Overview

This chapter will give you a basic instruction on how to set up the DVR for network connection. It is highly recommended that you have a working knowledge of what a network is and how it works. This will be helpful in completing the networking process.

5.1 Introduction to TCP/IP

TCP/IP is the group of protocols used by the Internet and most Local Area Networks (LANs) throughout the world. In TCP/IP, every computer or other communications device that is connected to the network has a unique IP address. By doing this you are giving your device a unique address similar to the address of your house. An IP address is composed of four octets (numbers in the range of 0 to 255) separated by decimal points. The IP address is used to uniquely identify a host or computer on the LAN. For example, one computer on a network could have an IP address of 192.168.1.127.

You should never give two or more devices the same exact IP address, but the first three octets of an IP address is often the same for all computers in the local area network. For example, if a total of 253 computers exist in a single LAN, the IP addresses could be assigned starting with 192.168.1.*x*, where *x* represents a number in the range of 2 to 254. In IPP address could be compared with a telephone number.

5.2 Subnet Masks

Each host in a LAN has a subnet mask. The *subnet mask* is a set of octets that is used to determine which LAN or class it belongs to. The number 255 is usually used to represent the network address portion of the IP address and a zero is placed at the end to identify the host portion of the address. Basically the subnet mask tells the devices how the network addresses are organized, and helps to determine which addresses are local and which are remote (on the other side of the router).

5.3 Gateway Address

Addressees are either local or remote. A *gateway address* is composed of four octets separated by decimal points. The gateway address is used to uniquely identify the device on the LAN that has access to the communications links connecting to other LANs, WANs and/or the Internet (access to the 'remote' addresses).

5.4 Virtual Ports

A **port number** represents a "channel" or entryway for network communications. Port numbers allow different computers to utilize network resources without interfering with each other. Port numbers most commonly appear in network programming, particularly socket programming. Sometimes, though, port numbers are made visible to the casual user. For example, some websites on the Internet use a URL like the following:

`http://www.sitename.com:8100/`

In this example, the number 8100 refers to the port number used by the browser to connect to the web server. The standard port number used by web sites is 80, so this number does not need to be included with the URL (although it can be). In IP networking, port numbers can theoretically range from 0 to 65535. Most popular network applications, though, use port numbers at the lower end of the range (such as 80 for HTTP). Ports are similar to doors and windows of your house, with port 80 acting as the front door. If these are not open you could not enter the house. This is the same case with ports on a network. If the ports for a specific IP address are not open then you could not gain access to that IP address.

Note: *The term port also refers to several other aspects of network technology. A port can refer to Ethernet connection points, such as those on a hub, switch, or router. The term port is also used to refer to a physical connection point for peripheral devices such as serial, parallel, and USB ports.*

Another analogy would be: if a WAN IP address is similar to the phone number identify a site, IP ports are similar to telephone extensions, in that they allow communication with specific devices within a site that all share the same external (WAN) IP address. A router is a device which allows multiple computers and other IP enabled equipment to share that single WAN IP address. It functions like a "switchboard operator" – opening ports creates an association between those port numbers and the LAN IP address of specific equipment on the LAN behind the router. When the router sees a 'call' for a specific 'extension' (port), it directs that data stream to the (LAN IP address of the) equipment associated with that 'extension' (port).

5.5 Pre-Installation

Before beginning the installation, please answer the following questions:

Do you have Hi-speed Internet? _____

There are many types of high speed Internet available. The most common ones are T1, Cable, and DSL (in order of speed). The DVR is not compatible with a dial-up connection.

- **Note:** *EverFocus suggests having a minimum upload speed of 256KBps. This can be addressed by your Internet Service Provider.*

What type of modem/router do you have? _____
Modem/router model name/ #

The modem/router was either installed by your Internet service provider or purchased by you to establish a connection to the Internet. A router assigns different internal IP addresses to local computers; this allows multiple computers to access the Internet through the same external IP address.

Do you have a static IP address? _____

A Static IP address means you use the same IP address every time you connect to the Internet. With a static IP address, other Internet users always know the address of your location and can easily connect with it. This makes it much simpler to host a website, email server, or other type of server connection. Everfocus suggests using a static IP address. If this is not available, you will need to use a dynamic IP address. This is explained below.

Do you have a dynamic IP address? _____

A Dynamic IP address means your IP address changes each time you connect to the Internet. We recommend asking your Internet service provider for a Static IP address. If this is not a possibility, you may use the DDNS feature of the DVR. DDNS stands for Dynamic Domain Name Server, a service that provides a central database where IP information can be stored and retrieved. It allows those using a dynamic IP address to be registered centrally so users can connect to it by name. See Chapter 7 for details on using EverFocus DDNS.

What type of DVR are you installing? _____

The default ports are
ENDEAVOR SD+HD: 80
ECOR264: 80
Paragon: 80
ECOR: 80, 1600
EDR/EDVR: 80, 1600, and 37260 – 37263

If the ports were changed in the Network Setup, use those port numbers.

5.6 What is your Network Setup?

Everfocus DVR's can operate using one of three types of networking connections.

1. Simple One to One Connection: A simple one to one connection is the simplest type of network connection. It uses a cross-over cable to make a direct connection from one computer to another (or in this case a computer to a DVR).

2. Direct High Speed Modem Connection: A direct modem connection uses a standard network cable to connect the modem directly to a computer (or in this case a modem to the DVR). This type of connection only covers single-port modems. For a combination modem/router, use the setup described below.
3. Router or LAN Connection – A local area network connection requires either a router or a pre-existing LAN connection. This is the most common type of connection. A router allows multiple computers and DVR's to access each other as well as the Internet. It assigns different internal IP addresses to the computers.

5.7 Simple One to One Connection

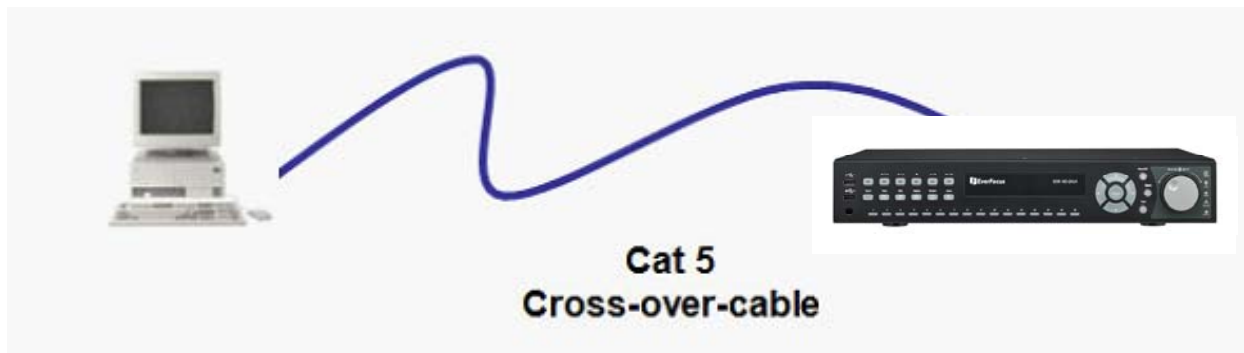

Crossover Ethernet Cable Pin outs:

The Figure below shows the pin configurations for a cross-over cable.

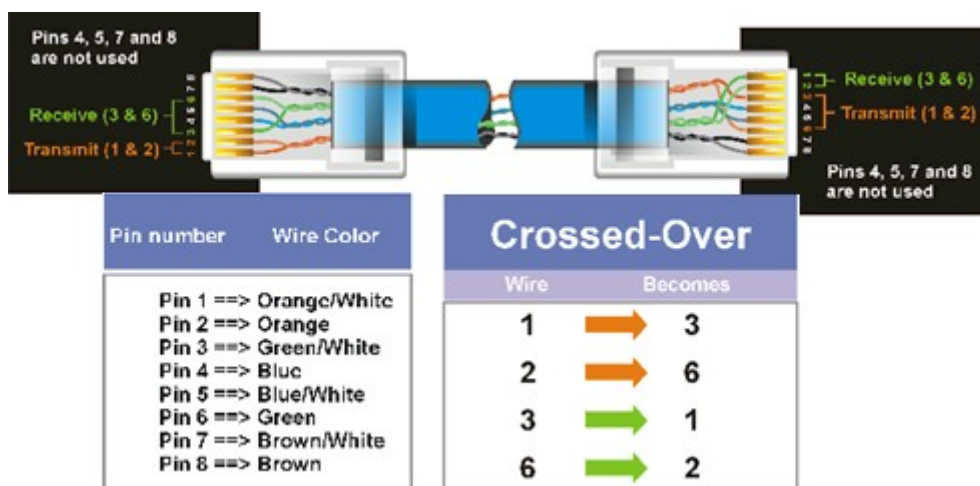

Connection Procedure:

- The First step is to purchase or make a cross-over cable. We recommend purchasing one if you have never made a cross-over cable. Please remember you can not use a straight through network cable for this application
- Once you have a cross-over cable plug one end into the LAN port on the back of the DVR and the other into the network card on the back of the computer.
- Log into the EverFocus DVR menu and go to the Network Setting Menu.
- You must use the Static IP option for this type of connection.
- Assign an IP of 192.168.001.003, a Subnet Mask of 255.255.255.000, and a Gateway of 192.168.001.001. You can ignore DNS Server.
- The next step is to set the computer's network settings to match those of the DVR. You will need Administrator privileges on your Windows machine to do this.
- To assign a fixed IP address in Windows 2000/XP.

- Go to **Start**
- Double-click on **Control Panel**

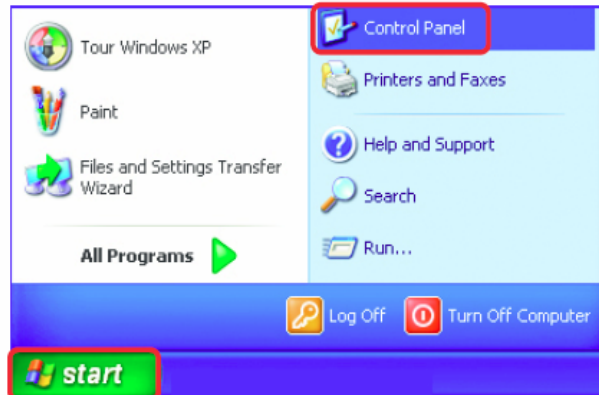

- Double-click on **Network Connections**

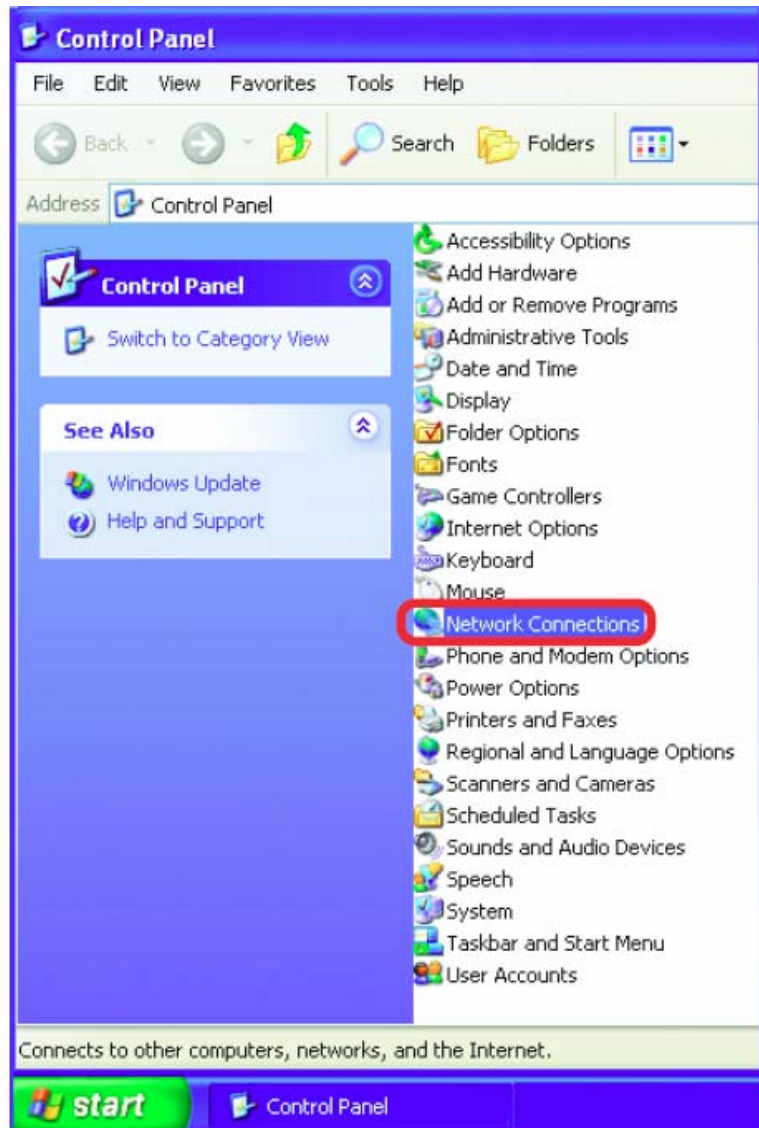

- Right-click on **Local Area Connections**

- Double-click on **Properties**

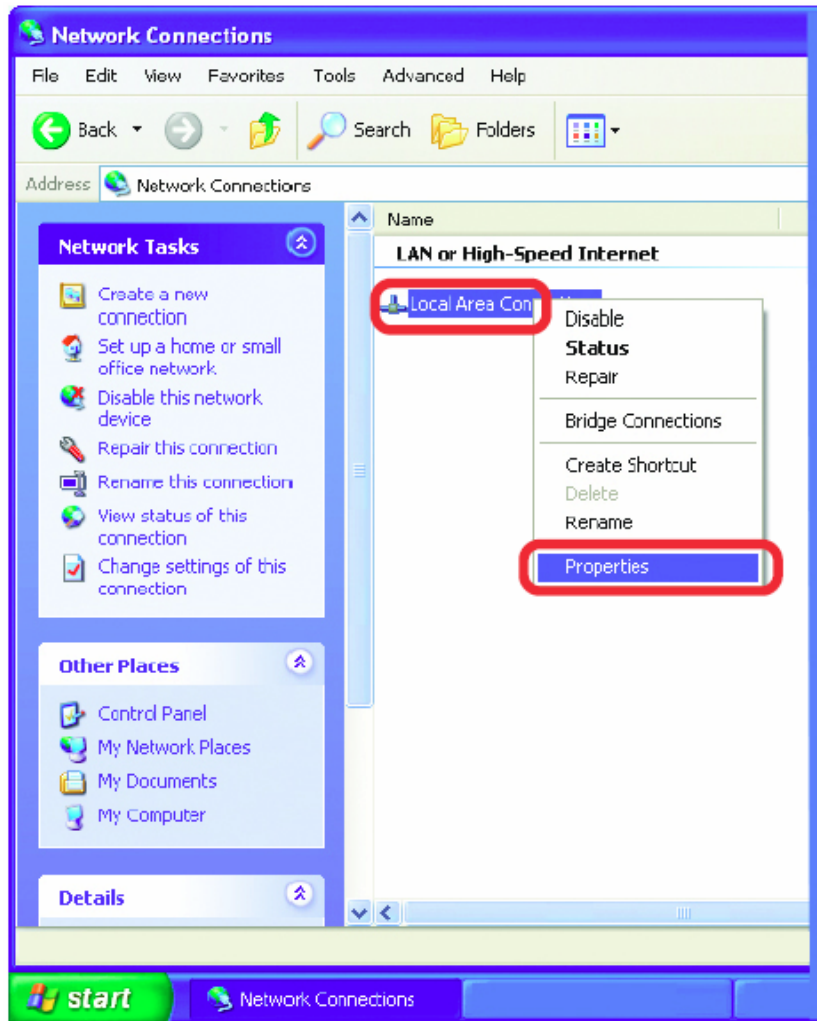

- Click on **Internet Protocol (TCP/IP)**
- Click **Properties**

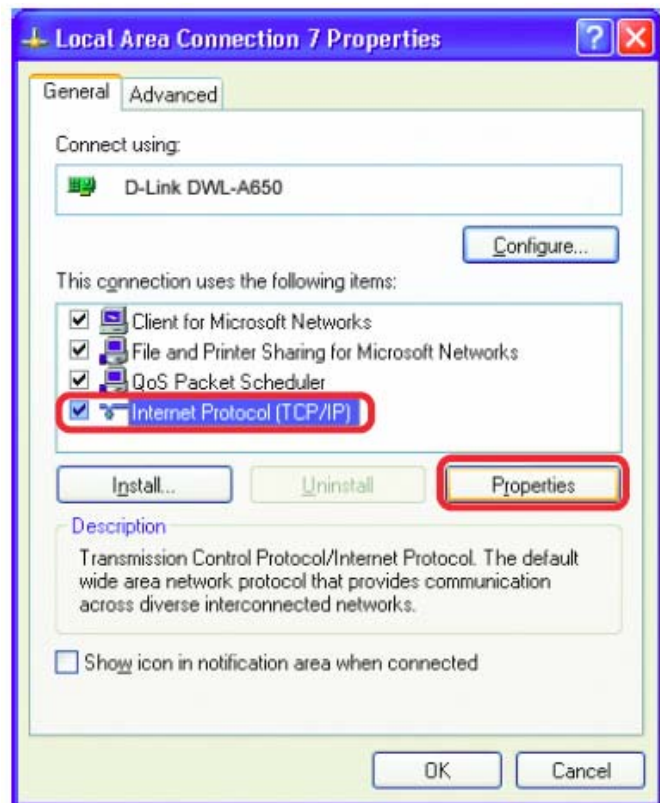

- Click on the option that says “Use the following IP address”
- Assign an IP address of 192.168.1.2, a Subnet Mask of 255.255.255.0, and a Default Gateway of 192.168.1.1, then click OK.
- Restart both the computer and the DVR.
- To access the DVR from the computer, simply open Internet Explorer and in the address bar type:

<http://192.168.1.3>

5.8 Direct High Speed Modem Connection

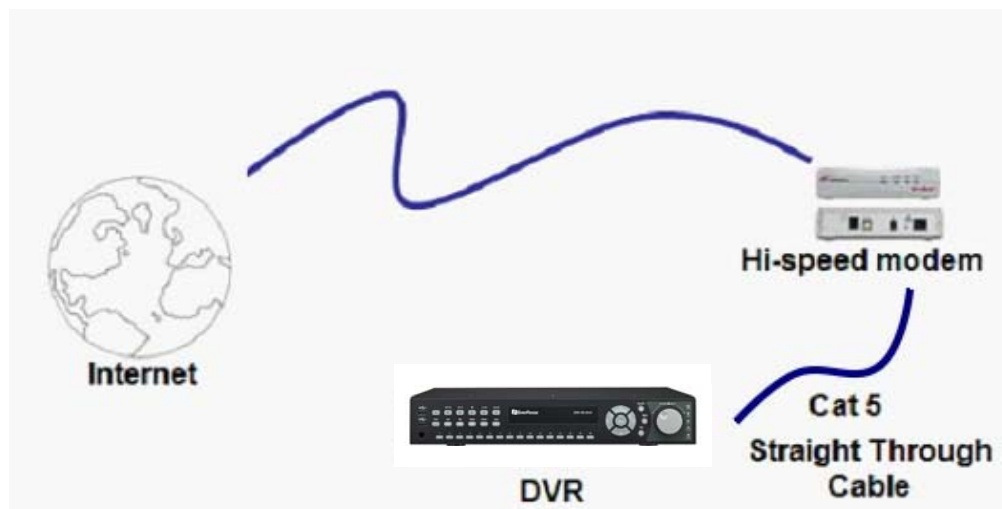

Straight Through Ethernet Cable Pin outs:

The Figure below shows the pin configurations for a straight cable.

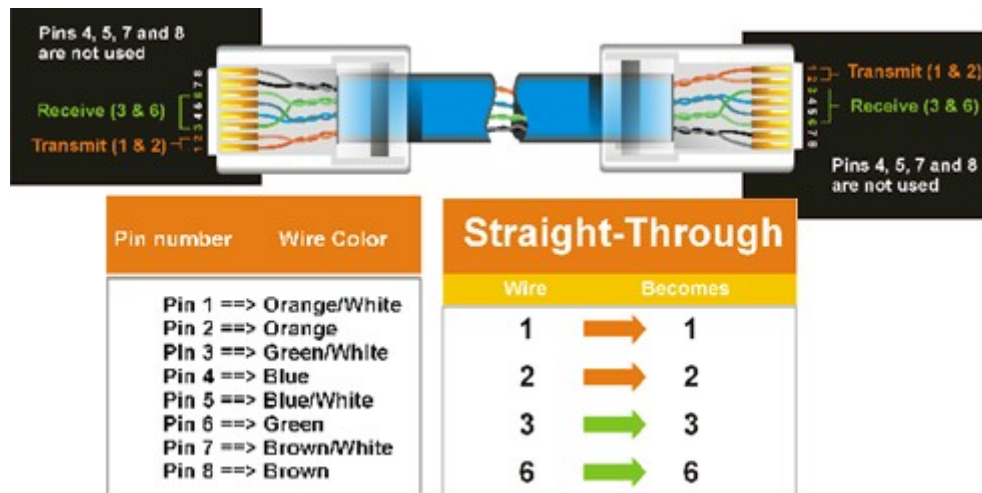

Connection Procedure:

- The first step is to purchase or make a straight through cable. We recommend purchasing one if you have never made a straight through cable. Please remember you can not use a cross-over network cable for this application
- Once you have a straight through cable plug one end into the LAN port on the back of the recorder and the other into the high speed modem.

- Log into the EverFocus DVR menu and go to the Network Setting Menu.
- Input the Static IP address, the Subnet Mask, and the Gateway that you obtained from the internet service provider.
 - **Note:** *If you have a dynamic IP address, you can set the DVR to DHCP to automatically detect the network settings. Therefore, it can use a dynamic IP address.*
- Exit from the DVR's Menu to save the settings.
- To access the DVR from a computer, open Internet Explorer and in the address bar type:
http:// (IP address given by your internet service provider)
 - **Note:** *When using this type of connection, only one device can be connected to the modem at a time. You will need to use a computer at a different location to test the connection.*

5.9 Router or LAN Connection

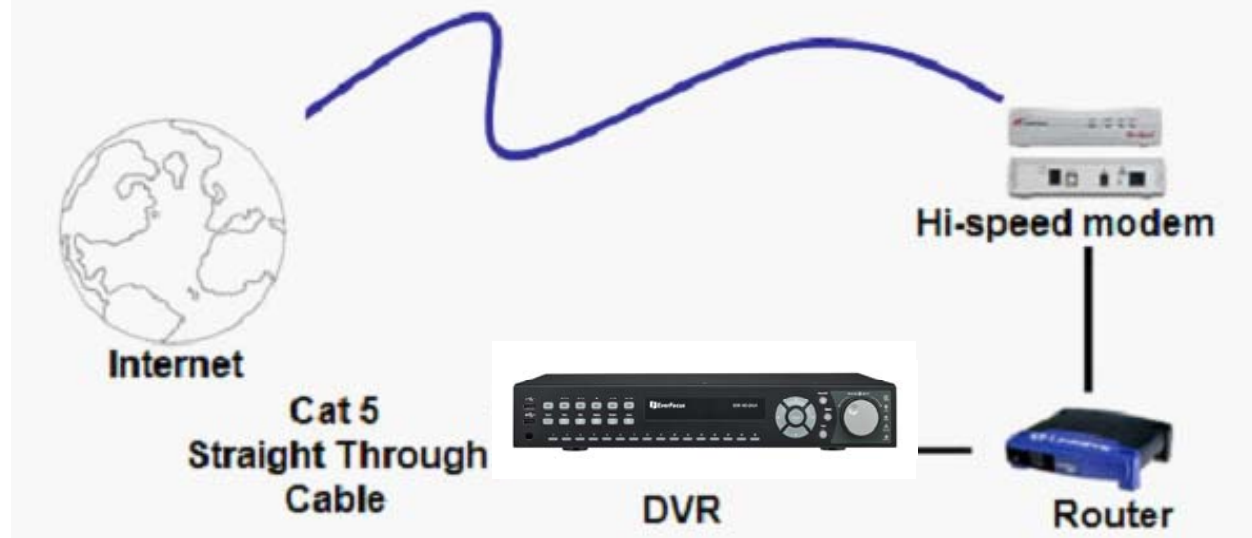

Straight Through Ethernet Cable Pin outs:

The Figure below shows the pin configurations for a straight cable.

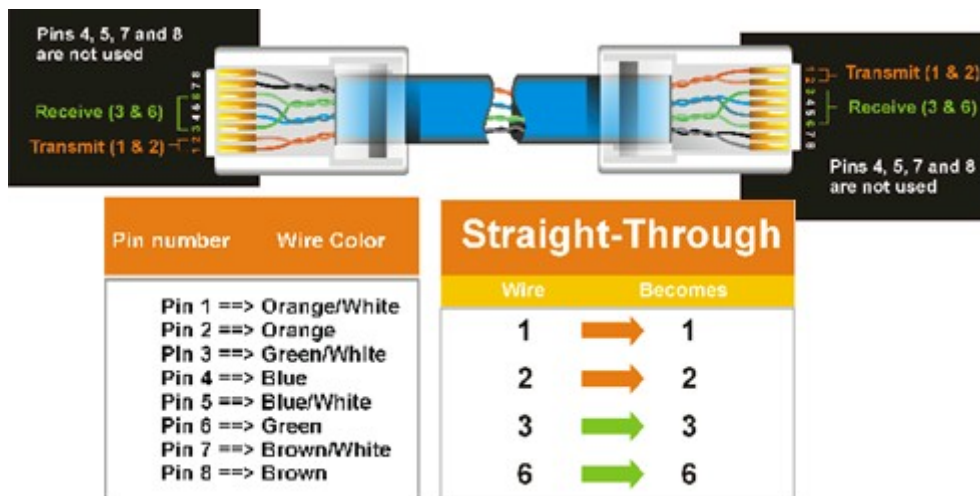

Connection Procedure:

- The First step is to purchase or make a straight through cable. We recommend purchasing one if you have never made a straight through cable. Please remember you can not use a cross-over network cable for this application

- Once you have a straight through cable plug one end into the LAN port on the back of the recorder and the other into the router.
- Log into the EverFocus DVR menu and go to the Network Setting Menu.
- To let the router automatically assign an address:
 - Set the Network Type to DHCP. Make sure to write down the IP address and the Gateway.
 - Exit from the Menu to save settings.

To manually assign an address:

- Go to a computer connected on the same network as the DVR.
- Click on the Start button and choose Run.
 - If using Windows Vista, choose Search instead.
- Type “command” and click on OK.
 - In Vista, you will need to double-click on the “Command Prompt” file to open it..
- In the DOS prompt, type “ipconfig” and press Enter.
- The network information will be displayed on a screen similar to the one below.
 - In Windows Vista, look for the information that says “IP v4”.

```

Command Prompt
Microsoft Windows XP [Version 5.1.2600]
(C) Copyright 1985-2001 Microsoft Corp.
C:\Documents and Settings\Steven>ipconfig
Windows IP Configuration

Ethernet adapter Local Area Connection:

    Connection-specific DNS Suffix . :
    IP Address . . . . . : 192.168.0.80
    Subnet Mask . . . . . : 255.255.255.0
    Default Gateway . . . . . : 192.168.0.1

C:\Documents and Settings\Steven>

```

- Take the values for Subnet Mask and Default Gateway and input them into the DVR; these values should be exactly the same in both devices. However, you should change the last

number of the IP address. For example, if the IP address of the computer is 192.168.2.101, the DVR's IP address should be 192.168.002.050.

- To access the DVR from a computer simply open Internet Explorer and in the address bar type:
http:// (IP address of the DVR)
 - **Note:** *The DVR's IP address will only work at the location of the DVR. To connect from a different location over the Internet, see below.*

To set DVR for Internet Connection through router

- The next step is to open ports within your router. Log into the router using a PC and open the following ports.
 - Ports to open: 80
 - If your Internet service provider blocks port 80, you can change it to a different port in the DVR's Network Menu Setup; open/forward that port instead.
 - If you are using a Linksys or D-Link router, see Chapter 8 for basic support on setting up ports. For any other router, you will need to contact the manufacturer for support.
- To access the DVR from a computer simply open Internet Explorer and in the address bar type:
http:// (the IP address given by your internet service provider)
 - **Note:** *If you changed to a different port other than 80, you will need to include this at the end of the IP address*

http:// (the IP address given by your internet service provider):portnumber
- If you have a WAN Dynamic IP address and have opened the ports, go to Chapter 7 to setup DDNS.

6 REMOTE OPERATION FROM BROWSER

6.1 CONNECTING TO ENDEAVOR SD+HD

To access the DVR from a computer, open an Internet Explorer window and in the address bar type:

Local connection: http:// (IP address from the DVR's Network Menu): IP port used
e.g. http://192.168.1.163:2468

Internet connection: http:// (IP address given by your Internet Service Provider): IP port used
e.g. http://57.182.67.204:2468

You should then see a login prompt.

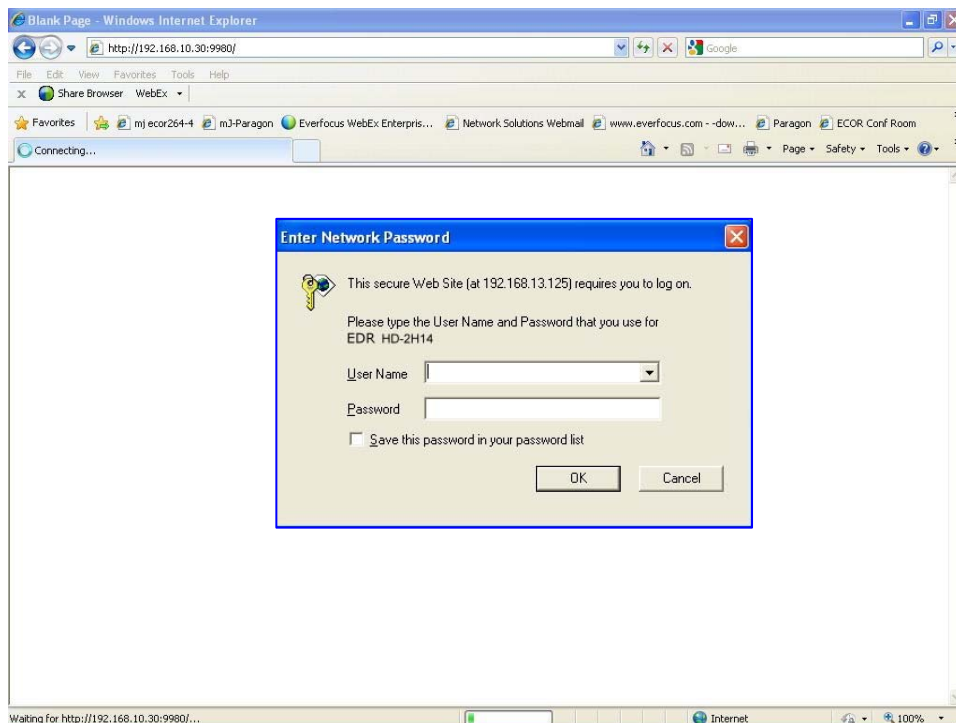

- The login page will appear on the screen similar to the one shown above.

- Enter a user name and password to access the recorder. These can be changed in the System section of the Main Menu.
- The default user name is “admin”. The default password is “11111111”.
- Click on the Login button and you will log in to the recorder’s Network Viewer.

6.2 BROWSER SECURITY SETTING

6.2.1 Installing ActiveX controls

When you first connect to the DVR’s IP address, you should see a screen like the one below. If you do not see a yellow bar like the one the arrow is pointing at, your security settings may be too high. If so, go to “Section 6.2.2 - Enabling ActiveX Controls.”

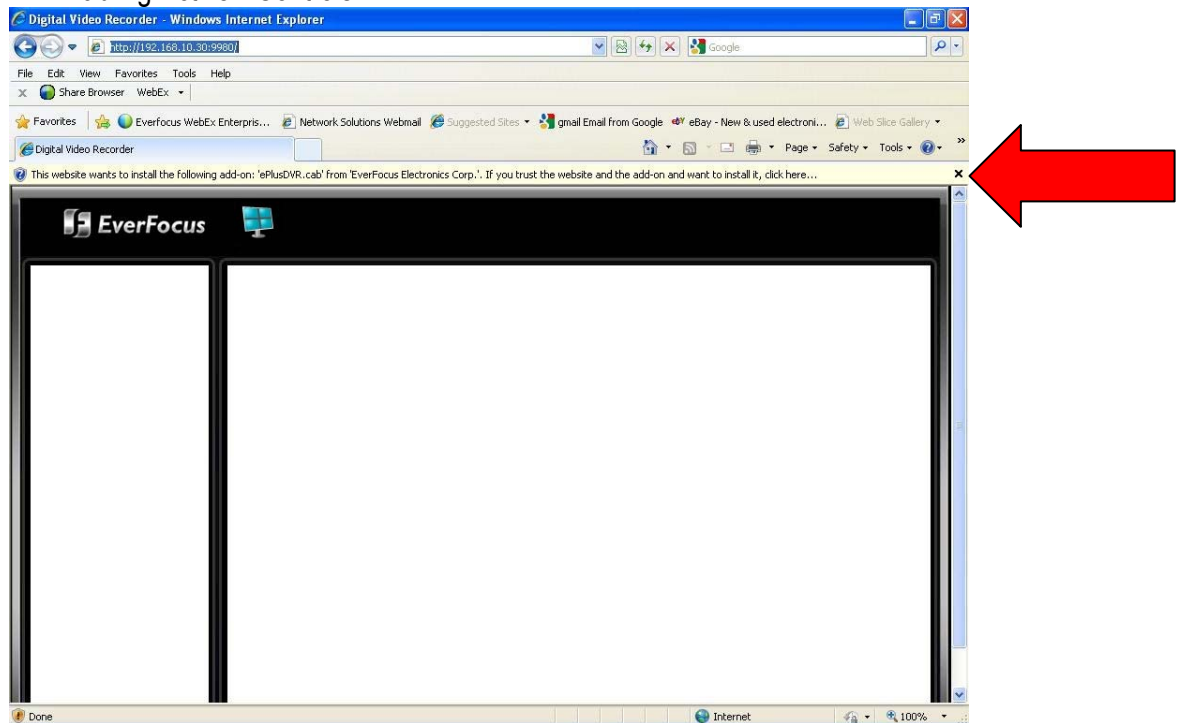

Right click on the yellow bar and select “Install This Add-on...”

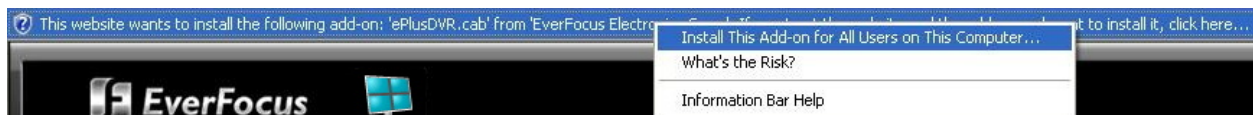

Install the ePlusDVR.cab file when prompted to do so.



Once the file finishes installing, you will return to the screen like the one below.

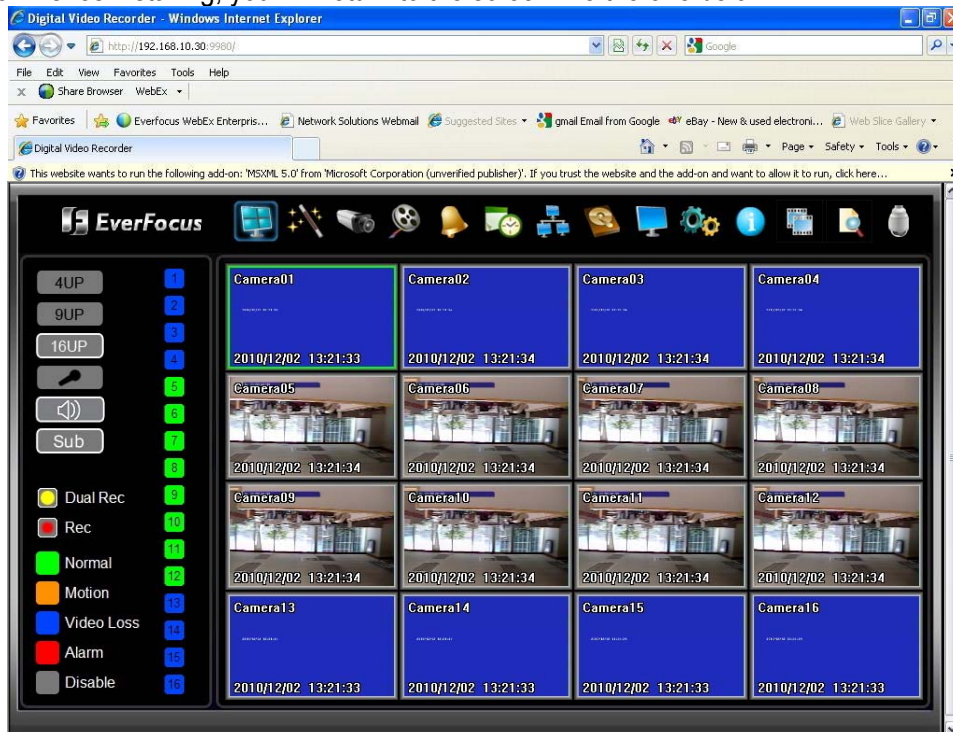

Right click on the yellow bar and select "Run Add-on..."

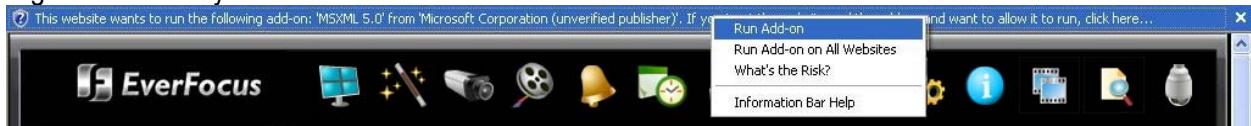

Install the MSXML file when prompted to do so.



Now, you will be able to see the remote live page.



Enabling ActiveX Controls

Note: This section is only necessary if you DO NOT see the yellow ActiveX bar at the top of your browser screen when you first connect to the DVR.

At the top of the Internet Explorer Window, click on Tools, then select Internet Options.

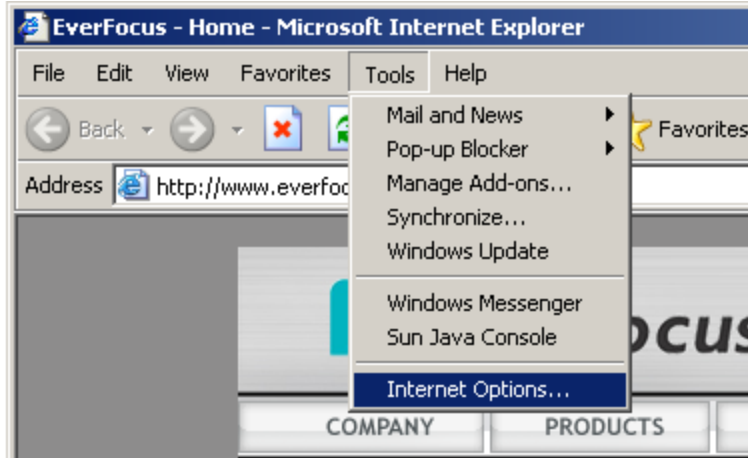

Click the Security tab at the top of the window, then choose Custom Level near the bottom.

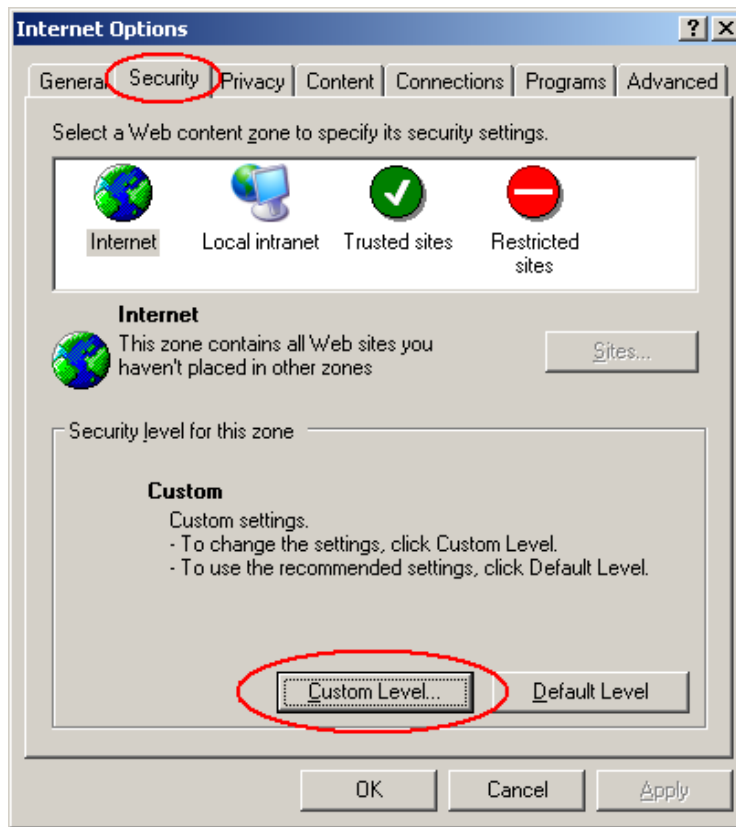

In the Security Settings window, scroll to “ActiveX controls and plug-ins”

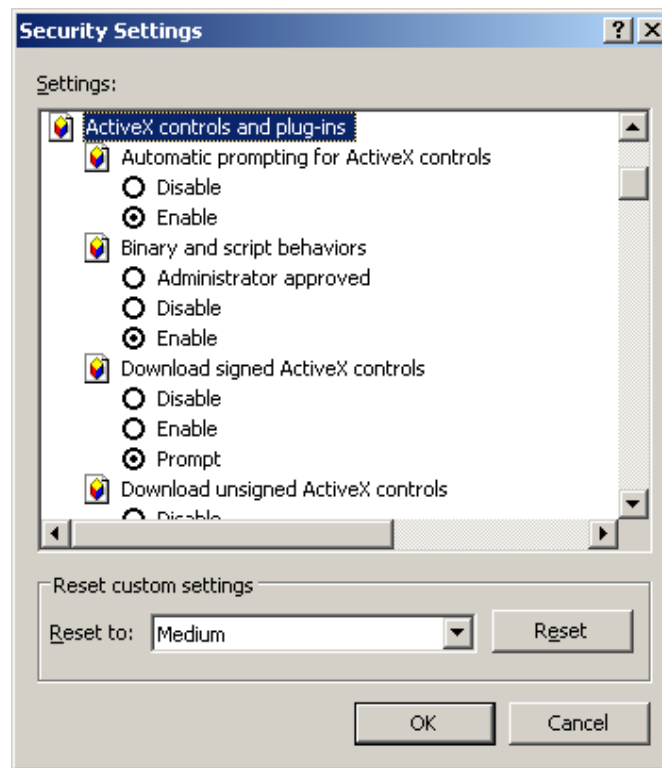

Set the controls as follows:

“Enable”:

- ✓ Allow previously unused ActiveX controls to run without prompt (*Internet Explorer 7 only*)
- ✓ Allow scriptlets (*IE7 only*)
- ✓ Automatic prompting for ActiveX controls
- ✓ Binary and script behaviors
- ✓ Display video and animation on a webpage that does not use external media player (*IE7 only*)
- ✓ Run ActiveX controls and plug-ins
- ✓ Script ActiveX controls marked safe for scripting

“Prompt”:

- ✓ Download signed ActiveX controls
- ✓ Download unsigned ActiveX controls

“Disable”:

- ✓ Initialize and script ActiveX controls not marked as safe

Click OK and then choose Yes to change the security settings.

Close the window so you are back at the login screen.

Click the Refresh button to reload the page.



Install the ePlusDVR.cab file when prompted to do so.

Once the file finishes installing, you will return to the same login page as before. Type in the user name and password and click Login to view the cameras.



Default user name: admin

Default password: 11111111.



6.3 REMOTE LIVE VIEW



1. Click on a camera number on the left side of the display to switch that camera to full screen. Click on "4UP" to display 4 screens, click on "9UP" to display 9 screens or click on "16IP" to display 16 screens.
2. You can click the "Mic" button to transfer audio to DVR from client side if there is a microphone attached to the PC and an amplifier and speaker attached to the DVR. You can also click the "Speaker" button to transfer audio to the client side from DVR if there is a speaker on the PC and a microphone and preamp attached to the DVR, and audio recording is enabled on the DVR. Double click on a camera image to enlarge the current display to full screen; double click again or press "Esc" to return to the normal view.
3. **Main/Sub:** Click this icon to switch stream for multi view. Sub stream image is less clear as compared to the main stream. Select Sub stream if you wish to see smooth image but do not care about the frame rate. By choosing the main stream, PC performance may affect the frame rate.
4. The status of each camera is represented by different colors on the left side of the screen.  indicates dual stream is recording.  indicates only main stream is recording. Green means normal; orange indicates a Motion alarm; blue indicates Video Loss, red indicates an alarm event and grey means disable
5. **Menu bar:** Menu buttons for setup, search and export, details are explained in following chapters.



Live View



Express Setup



Camera Setup



Record Setup



Alarm Setup



Schedule Setup



Network Setup



Hard Disk Setup



Display Setup



System Setup



Information Setup



Video Export



Playback Search



PTZ Control

6. In the main page, you will see live images in a 16-screen display.

6.4 REMOTE PLAYBACK

To playback the video, click the “Search” button. Select from “Time Search”, “Event Search”, or “Motion Search”. For more details about Search setting, please refer to “3.12 Search Setting”.

“Event Search” and “Motion Search” will show maximum 400 search result items (beginning with the start time)



Playback Control Keys

Back: returns to live view

Playback Control Keys:

1.  Fast rewind the video
2.  Play Reverse the video
3.  Stop playback
4.  Pause
5.  Playback the video
6.  Fast forward the video

7 EVERFOCUS DDNS SETUP

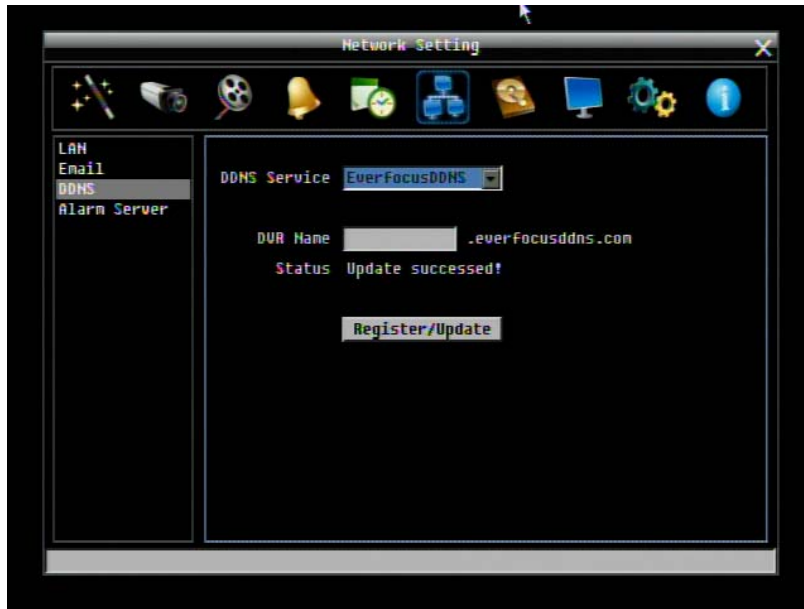

Setup Steps:

Step 1. Set up the Network Menu according to the instructions detailed in the Networking chapter. (Make sure that DNS Server 1 is set correctly or DDNS will not work)

Step 2. Go to the website <http://everfocusddns.com> and check for an available name.

Note: This step is optional, though recommended, as it is used to check the availability of a host name. If the name is already used, and attempt to register that name must fail. If the name is available, proceed to step 3 for DDNS setup.

Step 3. In DVR's Network Menu, go to DDNS. Choose "EverfocusDDNS" for the Server and put in your chosen name in the field: DVR Name.

PLEASE NOTE: The name of the DVR **cannot include a space, or a dot (period) or any special characters** particularly ~ ! @ # \$ % ^ & * () + < > " ; : . , _

Step 4. Click (or select and press Enter) on the "**Register/Update**" button to synchronize the DVR with the DDNS server. You should see an indication of "Success" on the screen. If you see "Could Not Find Server" or any other error message instead, double-check your network

settings and DDNS name and resubmit the DDNS name until you get "Success".

Step 5. You should now be able to connect by typing the name you created into the address bar.

Example: <http://hostname.everfocusddns.com>

It is not necessary to append the HTTP port number to the DDNS name. The EverFocus DDNS server not only keeps track of your DVR's IP address, it keeps track of the ports too!

8 LINKSYS & D-LINK PORT FORWARDING

8.2 TYPICAL LINKSYS PORT FORWARDING

This section will cover a few simple configurations for the Linksys router. This chapter is only to offer some help to the installer and end user. Please understand we **DO NOT** support this product and will not give tech support on it. If you need additional technical support on this router you must call Linksys.

To access the Web-based Utility, launch a web browser and type the Router's IP address, typically **192.168.1.1**, in the address bar. Then press **Enter**. A password request page will appear. (Non-Windows XP users will see a similar screen.) Leave the *User Name* field blank. The first time you access the router, use the default password **admin**. Click the **OK** button to continue.



The first screen that appears displays the Setup tab. This allows you to change the Router's general settings. Change these settings as described here and click the **Save Settings** button to apply your changes or **Cancel Changes** to cancel your changes.

Click on the "Applications & Gaming" tab.

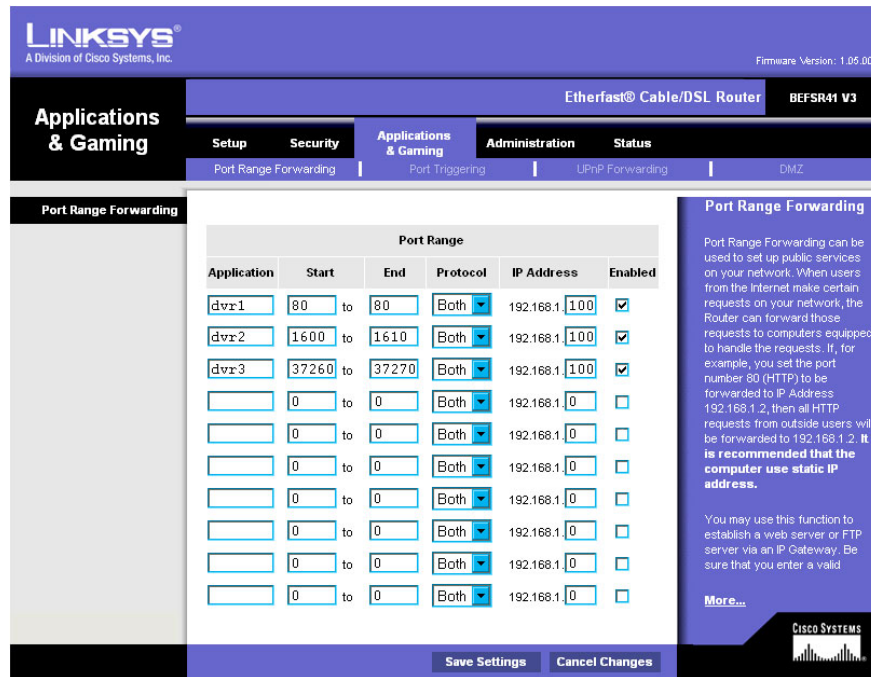

Applications and Gaming allows you to set up public services on your network, such as web servers, ftp servers, e-mail servers, or other specialized Internet applications. (Some Internet applications may not require any forwarding) To forward a port, enter the information on each line for the criteria required. Descriptions of each criterion are described here.

Application - In this field, enter the name you wish to give the application.

Start/End - Enter the starting number of the range under **Start** and the ending number under **End**.

Protocol - Enter the protocol used for this application, either **TCP** or **UDP**, or **Both**.

IP Address - For each application, enter the IP Address of the PC running the specific application.

Enable - Click the **Enable** checkbox to enable port forwarding for the relevant application.

When finished making changes, click the **Save Settings** button to apply your changes or **Cancel Changes** to cancel them.

Here is an example for how the port information might look:

HTTP 80 to 80 Both 192.168.1.50 Enable

Where 192.168.1.50 is the IP address of the ENDEAVOR SD+HD on the LAN, and the default port 80 is in use.

Note: *If you changed port 80 in the DVR's Network Menu, open that port instead of 80.*

8.3 TYPICAL D-LINK PORT FORWARDING

This section will cover a few simple configurations for the D-Link router. This chapter is only to offer some help to the installer and end user. Please understand we **DO NOT** support this product and will not give tech support on it. If you need additional technical support on this router you must call D-Link.

Whenever you want to configure your network or the DI-624, you can access the Configuration Menu by opening a web-browser and typing in the IP Address of the DI-264.

The DI-264 default IP Address is 192.168.0.1.

- Type “admin” in the **User Name** field
- Leave the **Password** blank
- Click **OK**

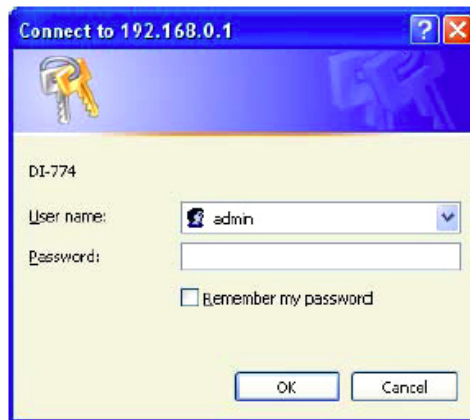

The first screen that shows up is the Home Tab. This is the starting point for all the router's settings and functions.

Click Virtual Servers on the left to bring up the following screen.



Virtual Servers allows users who are connecting remotely to access services on the router's Local Network. The functions of each field are described below.

Virtual Server - Select **Enabled** or **Disabled**

Name - Enter the name referencing the virtual service

Private IP - The IP address of the device running the local services.

Protocol Type - The protocol used for the virtual service.

Private Port - The port number that the service uses on the LAN (Local Area Network).

Public Port - The port number that the services uses on the WAN (Wide Area Network).

Schedule - The time period the virtual server will be active.

When you have input all the information for a virtual server, click on **Apply** to add it to the list at the bottom or **Cancel** to clear all fields.

Here is an example of the information for each service:

<u>Name</u>	<u>Private IP</u>	<u>Protocol</u>	<u>Private Port</u>	<u>Public Port</u>	<u>Schedule</u>
HTTP	192.168.1.50	Both	80	80	Enable

Where 192.168.1.50 is the IP address of the ENDEAVOR SD+HD on the LAN, and the default port 80 is in use.

Note: *If you changed port 80 in the DVR's Network Menu, open that port instead of 80.*

9 TROUBLESHOOTING

If you have problems with the system, run through the following checklist to see if you can solve the problem.

- **The DVR will not go into record mode.**
 - Bring up the DVR's Menu and check under the Camera Menu. Verify that all connected cameras are checked as "Installed" and that Record Mode is set to "Continuous".
 - Check the Disk or Information Menus and verify that the internal hard drive is being detected.

- **The DVR displays nothing on the main monitor.**
 - Make sure the monitor is connected to either BNC Main Monitor port or the VGA port. If the monitor has multiple inputs, make sure it is on the correct input source and display setting (1024x768).
 - Check that the monitor cables are good and power is on.
 - Verify the recorder is getting the correct supply power.

- **There is no display coming from one of the channels on the DVR.**
 - In the DVR's Camera Menu, make sure that all cameras are checked as "Installed" and unchecked for "Covert".
 - If there is still no picture, switch ports or connect a working camera to the port that has no picture. If you get an image, the problem is coming from the camera or cable.

- **I cannot connect to the recorder via the internet.**
 - Check that you can connect to the DVR on the LAN.
 - Check that the DVR has a static IP address and the port used by the DVR is forwarded correctly to that IP address in the router.
 - Verify that your Internet Service Provider does not block the IP port being used

- Make sure you are using the correct WAN IP address given by the ISP, or, if you have a Dynamic IP, check if the IP address has changed; use DDNS to avoid problems caused by changing ISP addresses.

APPENDIX A: TIMING OF ALARM MODES

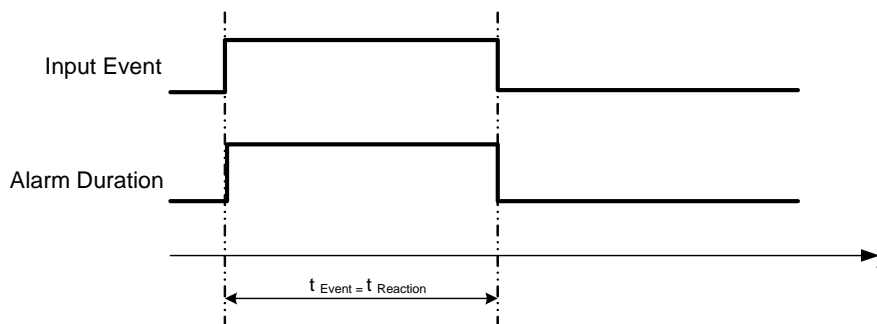
Transparent Mode

t_{Event}: Duration of alarm input source (motion, contact, system events...)

t_{reaction}: Resulting duration for this alarm mode, related to event record, alarm outputs, OSD message, buzzer

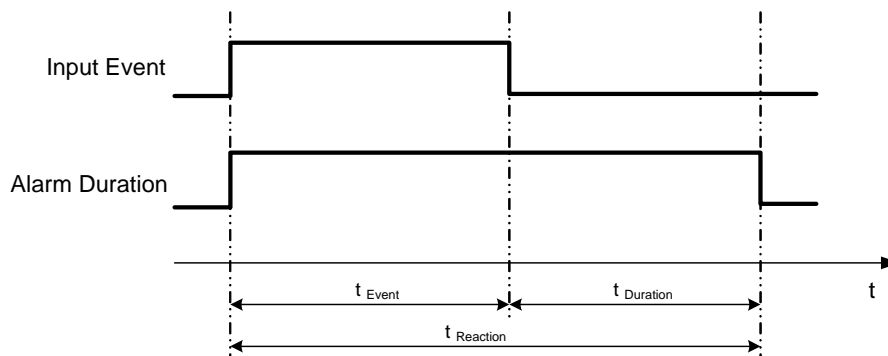
Timeout + Transparent Mode

t_{Event}: Duration of alarm input source (motion, contact, system events...)

t_{Duration}: Alarm duration for timeout, defined in the event setup menus

t_{reaction}: Resulting duration for this alarm mode, related to event record, alarm outputs, OSD message, buzzer

Timeout Mode

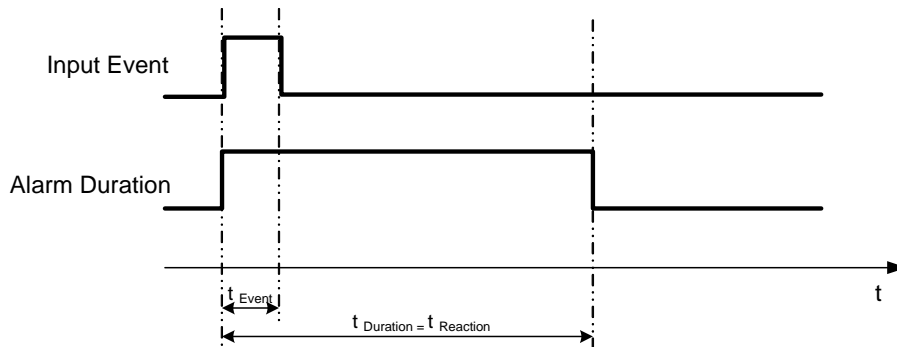

t_{Event}: Duration of alarm input source (motion, contact, system events...)

t_{Duration}: Alarm duration for timeout, defined in the event setup menus

t_{reaction}: Resulting duration for this alarm mode, related to event record, alarm outputs, OSD message, buzzer

Permanent Mode

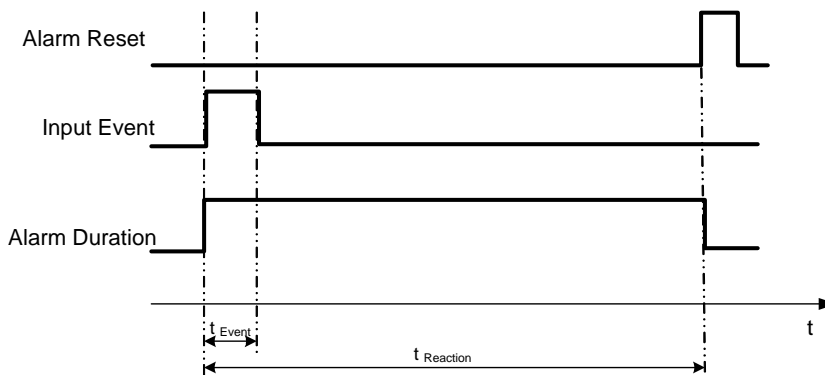

t_{Event}: Duration of alarm input source (motion, contact, system events...)

t_{Duration}: Alarm duration for timeout, defined in the event setup menus

t_{reaction}: Resulting duration for this alarm mode, related to event record, alarm outputs, OSD message, buzzer

Timeout Mode: Retrigger of Alarms

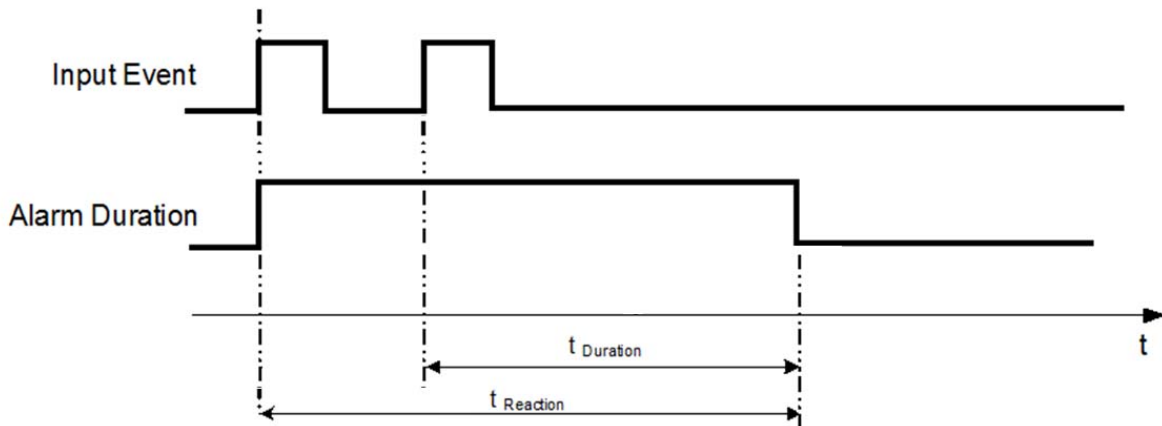

- t Event:** Duration of alarm input source (motion, contact, system events...)
- t Duration:** Alarm duration for timeout, defined in the event setup menus
- t reaction:** Resulting duration for this alarm mode, related to event record, alarm outputs, OSD message, buzzer

Timeout+Transparent Mode: Retrigger of Alarms

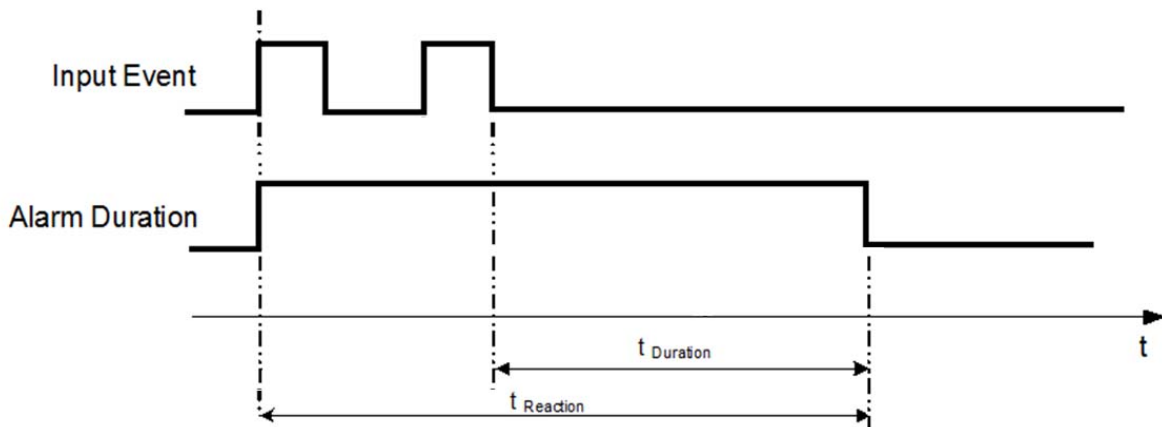

- t Event:** Duration of alarm input source (motion, contact, system events...)
- t Duration:** Alarm duration for timeout, defined in the event setup menus
- t reaction:** Resulting duration for this alarm mode, related to event record, alarm outputs, OSD message, buzzer

APPENDIX B: EXPRESS SETUP RECORDING VALUE SELECTION RULES

Case 1:

Record Mode: Normal + Event

Record With: Recording days

The DVR will Auto adjust image Quality and Event frame rate to match the number of Recording days which user selected:

According to resolution, event hours and other assumptions above, the DVR will attempt to select one set of suitable quality and event frame rate by checking if set 1 meets the requirements, and proceed in order until the requirements are met. If the DVR can't match the required record days from one of the 8 sets, it will use set 8.

Checking Order	1	2	3	4	5	6	7	8
Normal Frame Rate	1	1	1	1	1	1	1	1
Quality	Superior	Standard	Low	Low	Low	Low	Low	Low
Event Frame Rate	30	30	30	15	10	7.5	5	1

Case 2:

Record Mode: Event Only

Record With: Recording days

DVR will Auto adjust Quality and Event frame rate to match the Recording days which user need:

According to resolution, event hours and other assumptions above, the DVR will attempt to select one set of suitable quality and event frame rate by checking if set 1 meets the requirements, and proceed in order until the requirements are met. If the DVR can't match the required record days from one of the 8 sets, it will use set 8.

Checking Order	1	2	3	4	5	6	7	8
Quality	Superior	Standard	Low	Low	Low	Low	Low	Low
Event Frame Rate	30	30	30	15	10	7.5	5	1

Case 3:

Record Mode: Normal + Event or Event Only

Record With: Preset Setting

DVR will apply the settings in the table below to all cameras according to the Preset Settings.

Preset Setting Option	Camera Item	Apply value
Best Quality	Quality	Superior
	Normal Frame Rate	Max recording frame rate of DVR
	Event Frame Rate	30
Standard Quality	Quality	Standard
	Normal Frame Rate	Half of max recording frame rate of DVR
	Event Frame Rate	30
Extended Quality	Quality	Basic
	Normal Frame Rate	1
	Event Frame Rate	10

APPENDIX C: REMOTE CONTROL

The IR remote control is an accessory to enhance the convenient operation of the DVR. You can perform all the settings and operations from the remote control. The effective distance is up to 33 feet line of sight. The keypad functions are same as the front panel buttons of the DVR.



ID number here must correspond to the "IR Remote ID" in "I/O Control Setup Menu". Used to select a DVR when there is more than one unit. Selecting an incorrect unit ID will prevent the DVR from responding to commands from the remote.

Channel keys #1~16

EverFocus Electronics Corp.

EverFocus Taiwan:

12F, No.79, Sec. 1, Shin-Tai Wu Road,
Hsi-Chih, Taipei, Taiwan
TEL: +886 2 2698 2334
FAX: +886 2 2698 2380
www.everfocus.com.tw
marketing@everfocus.com.tw

EverFocus China - Beijing:

Room 609, Technology Trade Building,
Shangdi Information Industry Base,
Haidian District, Beijing 100085, China
TEL: +86 10 6297 3336~39
FAX: +86 10 6297 1423
www.everfocus.com.cn
marketing@everfocus.com.cn

EverFocus USA - California:

1801 Highland Avenue, Unit A, Duarte, CA 91010,
USA
TEL: +1 626 844 8888
FAX: +1 626 844 8838
www.everfocus.com
sales@everfocus.com

EverFocus Japan:

5F, Kinshicho City Building, 2-13-4 Koto-
Bashi, Sumida-Ku, Tokyo, 130-0022, Japan
TEL: +81 3 5625 8188
FAX: +81 3 5625 8189
www.everfocus.co.jp
info@everfocus.co.jp

EverFocus India:

Suite 803, Housefin Bhavan, C-21,
Bandra Kurla Complex, Bandra (East),
Mumbai 400051, India
TEL: +91 22 6128 8700
FAX: +91 22 6128 8705
www.everfocus.in
sales@everfocus.in

EverFocus Europe - Germany:

Albert-Einstein-Strasse 1, D-46446
Emmerich, Germany
TEL: +49 2822 93940
FAX: +49 2822 939495
www.everfocus.de
info@everfocus.de

EverFocus China - Shenzhen:

4F, No. 2, D4 Building, Wan Yelong
Industrial Park, Tangtou Road, Shiyan,
Baoan, Shenzhen, Guangdong 518101, China
TEL: +86 755 2765 1313
FAX: +86 755 2765 0337
www.everfocus.com.cn
marketing@everfocus.com.cn

EverFocus USA - New York:

415 Oser Avenue, Unit S, Hauppauge, NY 11788, USA
TEL: +1 631 436 5070
FAX: +1 631 436 5027
www.everfocus.com
sales@everfocus.com

EverFocus Europe - UK:

Unit 12, Spitfire Business Park,
Hawker Road, Croydon Surrey, CR0 4WD, UK
TEL: +44 20 8649 9757 / +44 845 430 9999
FAX: +44 20 8649 9907
www.everfocusuk.co.uk
salesuk@everfocus.com

	<p>Your EverFocus product is designed and manufactured with high quality materials and components which can be recycled and reused.</p> <p>This symbol means that electrical and electronic equipment, at their end-of-life, should be disposed of separately from your household waste.</p> <p>Please, dispose of this equipment at your local community waste collection/recycling centre.</p> <p>In the European Union there are separate collection systems for used electrical and electronic product.</p> <p>Please, help us to conserve the environment we live in!</p>	<p>Ihr EverFocus Produkt wurde entwickelt und hergestellt mit qualitativ hochwertigen Materialien und Komponenten, die recycelt und wieder verwendet werden können.</p> <p>Dieses Symbol bedeutet, dass elektrische und elektronische Geräte am Ende ihrer Nutzungsdauer vom Hausmüll getrennt entsorgt werden sollen.</p> <p>Bitte entsorgen Sie dieses Gerät bei Ihrer örtlichen kommunalen Sammelstelle oder im Recycling Centre.</p> <p>Helfen Sie uns bitte, die Umwelt zu erhalten, in der wir leben!</p>
---	--	---



EverFocus[®]

P/N: 4605XCHD16001AR

Free Manuals Download Website

<http://myh66.com>

<http://usermanuals.us>

<http://www.somanuals.com>

<http://www.4manuals.cc>

<http://www.manual-lib.com>

<http://www.404manual.com>

<http://www.luxmanual.com>

<http://aubethermostatmanual.com>

Golf course search by state

<http://golfingnear.com>

Email search by domain

<http://emailbydomain.com>

Auto manuals search

<http://auto.somanuals.com>

TV manuals search

<http://tv.somanuals.com>