

HD CCTV Digital Video Camera

OPERATION MANUAL

EQH5000

 EverFocus®



Before attempting to connect or operate, please read and follow these instructions.

Download from Www.Somanuals.com. All Manuals Search And Download.

CONTENTS

1. CAUTIONS
2. FEATURES
3. EQUIPMENT AND ACCESSORIES
4. CAMERA COMPONENT DESCRIPTION
5. INSTALLATION
6. DIMENSIONS
7. SPECIFICATIONS
8. DIGITAL INPUT/OUTPUT CIRCUIT (Future use)
9. OSD MANUAL

1. CAUTIONS

This device complies with Part 15 of the FCC Rules.

Operation is subject to the following two conditions;

1. This device may not cause harmful interference.
2. This device must accept any interference received, including interference that may cause undesired operation.

Note

This equipment has been tested and found to comply with the limits for a Class A digital device, pursuant to part 15 of the FCC Rules. These limits are designed to provide reasonable protection against harmful interference when the equipment is operated in a commercial environment. This equipment generates, uses, and can radiate radio frequency energy and, if not installed and used in accordance with the instruction manual, may cause harmful interference to radio communications. Operation of this equipment in a residential area is likely to cause harmful interference in which case the user will be required to correct the interference at his own expense."

WARNING

This is a class A product. In a domestic environment this product may cause radio interference in which case the user may be required to take adequate measures.

Caution

Any changes or modifications in construction of this device which are not expressly approved by the party responsible for compliance could void the user's authority to operate the equipment.



CAUTION

1. A regulated DC12V 1A power supply is recommended for use with this camera for the best picture and the most stable operation.
An unregulated power supply can cause damage to the camera. If an unregulated power supply is used, product warranty will be Void.
2. It is recommended that the camera is used with a system that has an HDCCTV quality 75 video impedance level.
3. Do not attempt to disassemble the camera to gain access to the internal components. Refer servicing to your dealer.
4. Never face the camera towards the sun or any bright or reflective light, which may cause smear on the picture and possible damage to the CCD.
5. **Do not remove the serial number sticker.**
6. **Do not expose the camera to rain or other type of liquid.**

1. CAUTIONS



Correct Disposal of This Product (Waste Electrical & Electronic Equipment)

(Applicable in the European Union and other European countries with separate collection systems)

This marking shown on the product or its literature, indicate that it should not be disposed with other household wastes at the end of its working life. To prevent possible harm to the environment or human health from uncontrolled waste disposal, please separate this from other types of wastes and recycle it responsibly to promote the sustainable reuse of material resources.

This product should not be mixed with other commercial wastes purchased this product, or their local government office, for details of where and how they can take item for environmentally safe recycling.

Business users should contact their supplier and check the terms and conditions of the purchase contract.

Household users should contact either the retailer where they for disposal.



CAUTION

RISK OF ELECTRIC SHOCK DO NOT OPEN



CAUTION : TO REDUCE THE RISK OF ELECTRIC SHOCK, DO NOT REMOVE COVER (OR BACK). NO USER SERVICEABLE PARTS INSIDE. REFER SERVICING TO QUALIFIED SERVICE PERSONNEL.



This symbol is intended to alert the user to the presence of uninsulated “dangerous voltage” within the product’s enclosure that may be of sufficient magnitude to constitute a risk of electric shock to persons.





This symbol is intended to alert the user to the presence of important operating and maintenance(servicing) instructions in the literature accompanying the appliance

2. FEATURES

- **High Resolution**
1/3" SONY Progressive Color CMOS Sensor,
1280x720 30fps
- **Supports Various Digital Video Output**
720p 30, 720p 60
720p 25, 720p 50
- **Video Outputs**
Primary HD-SDI (BNC)
Test/Setup TV Out (BNC), NTSC /PAL selectable
- **S/N Ratio** : Max 50dB
- **OSD menu for setup and configuration**
- **Lens Control**
Manual Iris
DC Iris
- **Provides True Day/Night Capability with Motorized IR Cut Filter**
- **Accepts CS Mount Lenses** : Adapter included for C-Mount Lens
- **Power Source** : DC 12V

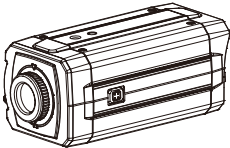
3. EQUIPMENT AND ACCESSORIES

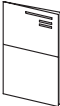
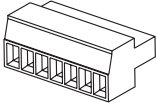
<p>HD CCTV Digital Video Camera</p>	
<p>C-MOUNT ADAPTOR RING</p>	
<p>OPERATION MANUAL</p>	
<p>TERMINAL BLOCK</p>	

*** NOTE**

PLEASE REMOVE PROTECTION FILM



4. CAMERA COMPONENT DESCRIPTIONS

• FRONT

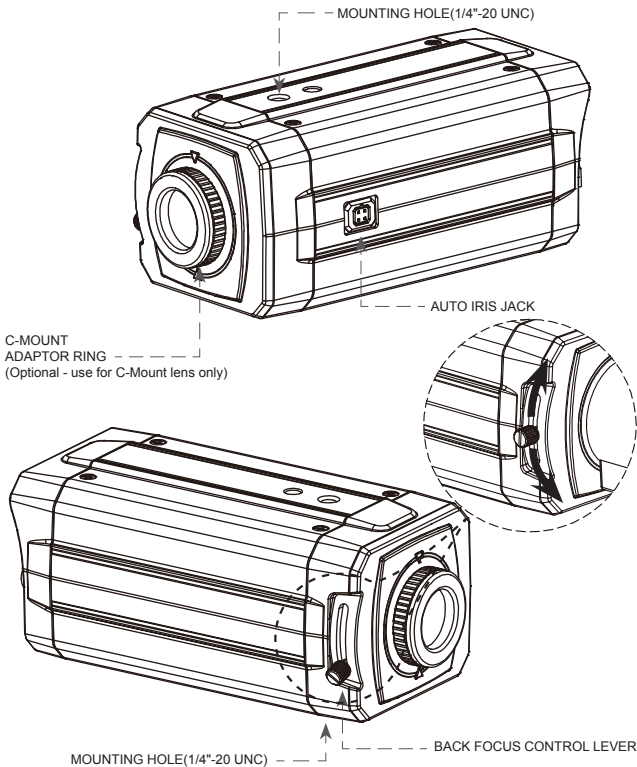

4. CAMERA COMPONENT DESCRIPTIONS

• BACK

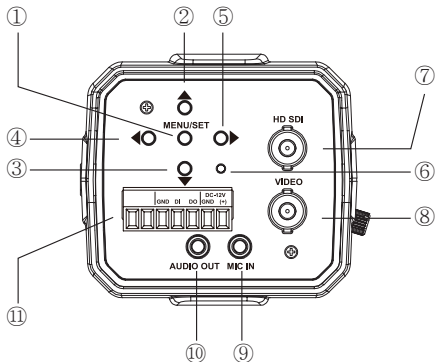

①. MENU SET BUTTON

MENU NAVIGATION BUTTONS

②. UP BUTTON

③. DOWN BUTTON

④. LEFT BUTTON

⑤. RIGHT BUTTON

⑥. POWER LED

⑦. SDI OUT BNC

⑧. VIDEO OUT BNC

⑨. MIC IN JACK (Future Feature)

⑩. AUDIO OUT JACK (Future Feature)

⑪. TERMINAL (POWER, Digital Input/Output) "Note : Digital input and Output for Future use"

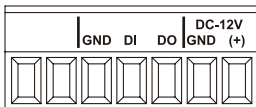

5. INSTALLATION

• LENS CONNECTION

Mega Pixel Lenses are sold separately. Lenses such as a DC auto iris lens, CS-Mount lens and C-Mount lens can be used (adapter included for C-Mount Lenses).

NOTE

- Please keep the lens clean.
- Any foreign objects and Finger marks on the lens can cause inferior image quality in low light level conditions.

After attaching the lens to the camera please insert the connection plug from the DC auto iris lens cable into the auto lens connector, which is located on the side of the camera

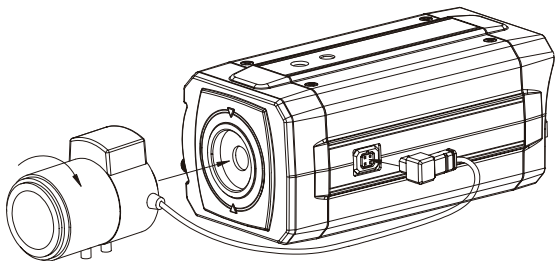

*NOTE

When using a CS Mount Lens, you can attach it directly to camera,
If using a C Mount lens, you must attach the ring spacer provided,
otherwise it will crack the image sensor.

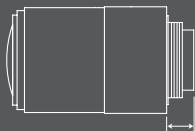

C-mount lens : 10mm or less
CS-mount lens : 5mm or less

5. INSTALLATION

Installation of C-Mount Lens

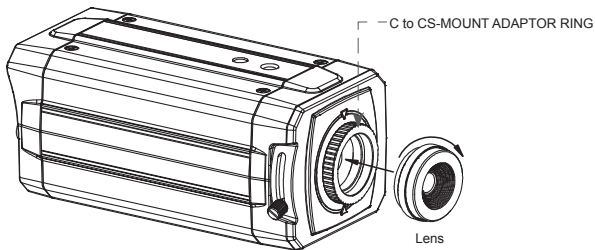

Installation of CS-Mount Lens

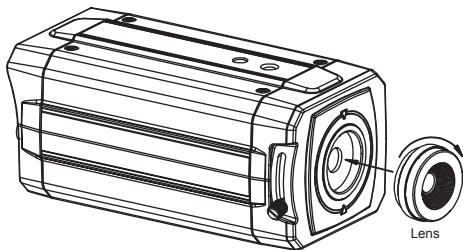

5. INSTALLATION

• CONNECTION

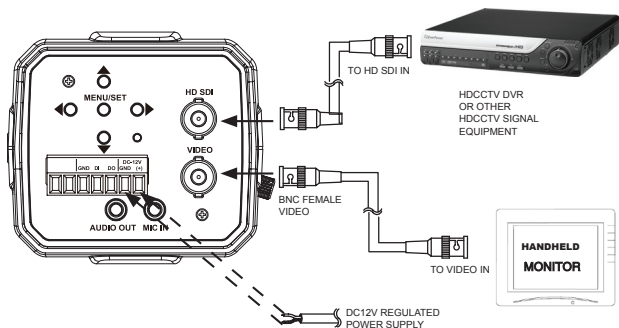

6. DIMENSIONS

Unit: mm(inch)

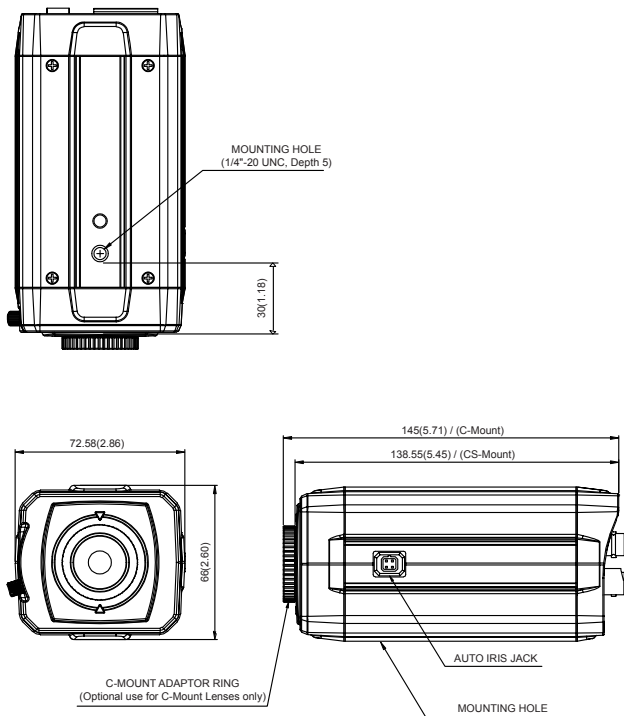

7. SPECIFICATION

Image Device	1/3" SONY Mega-Pixel Color Progressive CMOS
Effective Pixels	1329 (H) x 1049 (V) 30fps
Unit cell size	3.63um (H) x 3.63um (V)
Video output mode	HDCCTV : 720p 30, 720p 60, 720p 25, 720p 50 TV Out : NTSC / PAL selectable
H.Resolution	More than 800 TV Lines
Minimum illumination	1.0 Lux
S/N Ratio	Max 50dB
Shutter speed	Auto / Manual selectable
Min. Exposure Time	110.86us (1/9020 sec)
Flickerless	Off / 60Hz(50Hz) selectable
True Day/Night	IR Cut /Pass Filter change
White Balance	ATW / Push / Manual
BLC	On/Off (by OSD)
Lens Control	Manual Iris, DC Iris
OSD Menu	Yes
Power	DC 12V
Consumption	Max 500mA
Dimension (W x H x D)	72.5mm x 66mm x 138.5mm / 2.86inch x 2.60inch x 5.45inch
Weight (g / lb)	410g / 0.90lb
Lens Mount	CS/C-mount
Conformity	CE, FCC
Temperature/Humidity (non-condensing)	Operation : Celsius -10~50 (Fahrenheit 14~122) / 20~80% Storage : Celsius -20~70 (Fahrenheit -4~158) / 20~95%

Specifications and designs are subject to change without notice for improving the functionality of this product.

8. DIGITAL INPUT/OUTPUT

• Digital Input Port (Future Feature, Use for CDS Mode Only)

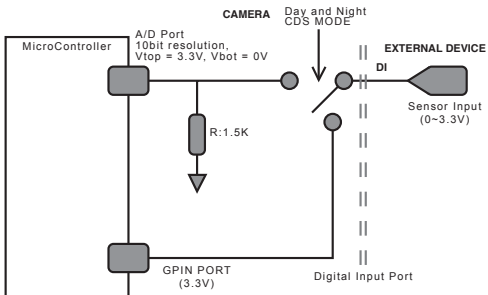

External CDS is only active when day and night mode is set to EXT Mode in the OSD.
CDS : External device to control day and night status

• Digital Output Port (Future Feature)

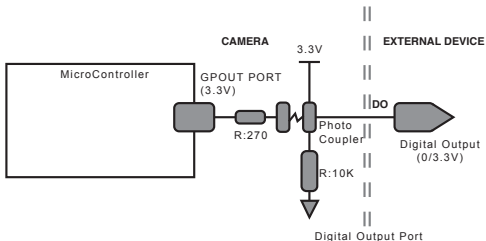

9. OSD MANUAL

• Menu structure

- Main Menu

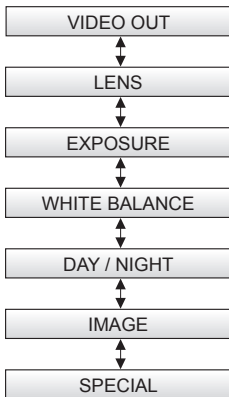

- VIDEO OUT Menu

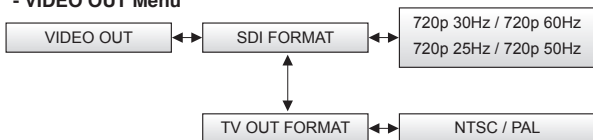

8. OSD MANUAL

- LENS Menu

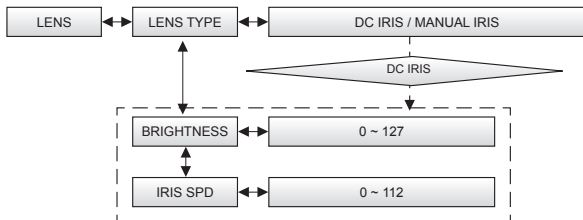

- EXPOSURE Menu

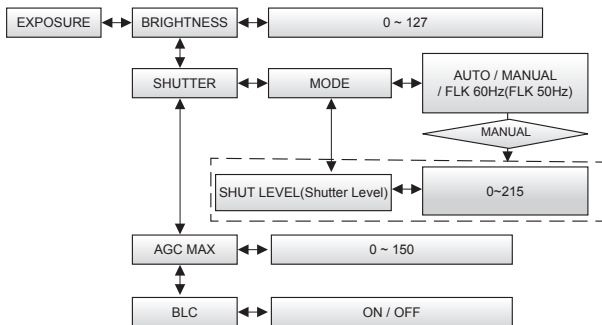

9. OSD MANUAL

- WHITE BALANCE Menu

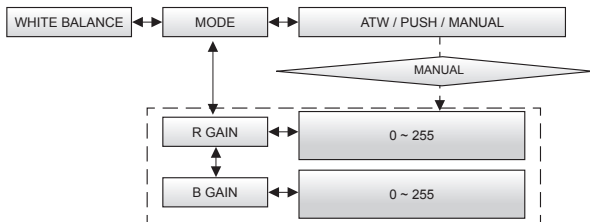

- DAY / NIGHT Menu

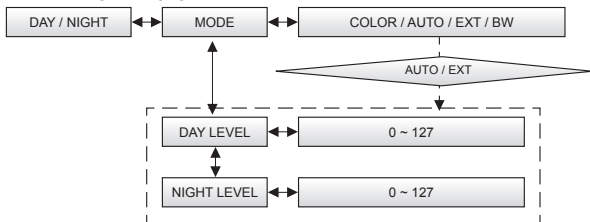

- IMAGE Menu

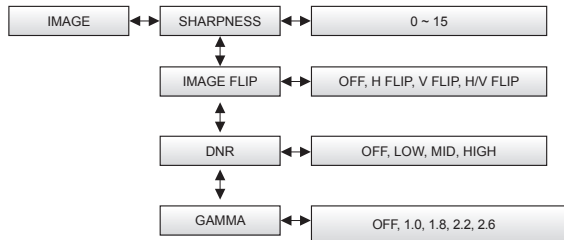





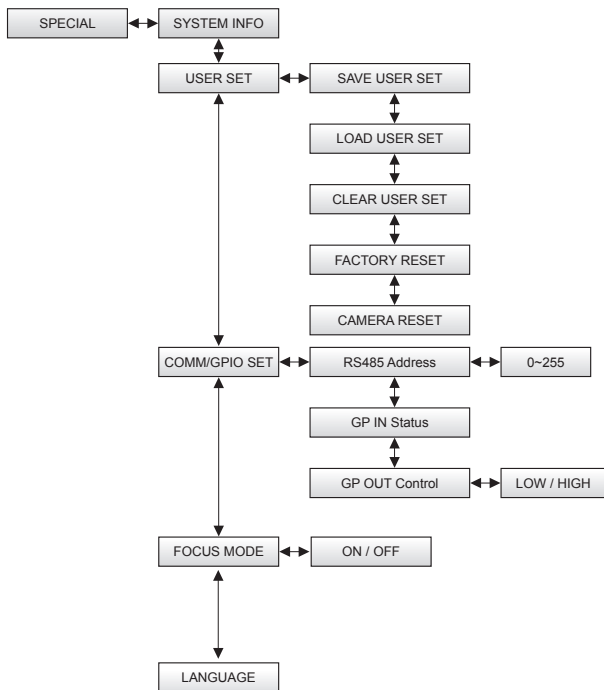

9. OSD MANUAL

- SPECIAL Menu



9. OSD MANUAL

• ICONS

-  : Value adjustment(use LEFT/RIGHT button).
-  : Select Sub Menu(use SET button).
-  : Execution command(use SET button).
-  : Return to previous menu.
-  : Menu OFF.
-  : Information.

The [SETUP] menu will show up when you push the SET button.

• Main Menu

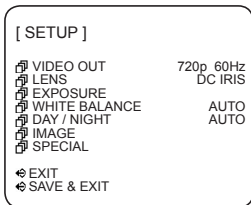

- **VIDEO OUT** : Select SDI Out format and TV Out format.
- **LENS** : Select the IRIS TYPE and adjust IRIS control value.
- **EXPOSURE** : Adjust Exposure control.
- **WHITE BALANCE** : Adjust White balance control.
- **DAY / NIGHT** : Day / Night control.
- **IMAGE** : Apply Image processing effects.
- **SPECIAL** : System setting, IO setting, USER SET setting
- **EXIT** : Close OSD Menu.
- **SAVE & EXIT** : Save and Close OSD Menu. These settings are loaded and applied automatically when the Camera is power on.

9. OSD MANUAL

• Video Out

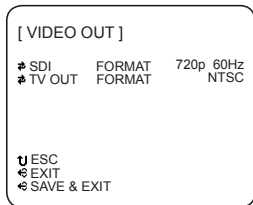

- SDI Format

Select SDI output Formats – 720p 30Hz, 720p 60Hz, 720p 25Hz and 720p 50Hz.

- TV Out Format

Select NTSC / PAL.

Note : NTSC or PAL Video Format can be selected by pressing the RIGHT Button even when the OSD Menu is turned off

- ESC

Back to the previous.

• LENS

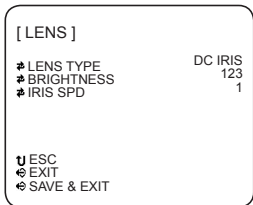

- LENS TYPE

Using Left / Right button, Select DC IRIS or MANUAL IRIS.

- BRIGHTNESS

This menu appeared on screen when DC IRIS is selected.

Using Left / Right button, adjust Brightness value.

- IRIS SPD

This menu appears on screen when DC IRIS is selected.

Using Left / Right button, adjust Iris speed value.

9. OSD MANUAL

• EXPOSURE

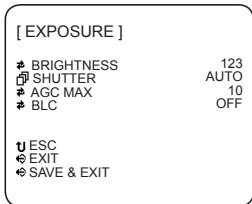

- BRIGHTNESS

Same as the BRIGHTNESS value in LENS Menu. Using Left / Right button, adjust Brightness value.

- SHUTTER

Using Set button, go to the SHUTTER sub menu.

- AGC MAX

Using Left / Right button, adjust AGC Max value.

- BLC

Using Left / Right button, select on/off of Back-Light Compensation Control.

• SHUTTER (Sub Menu)

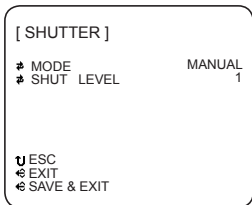

- MODE

Using Left / Right button, select Shutter Control modes – AUTO, MANUAL and FLK 60Hz (FLK 50Hz).

AUTO	Auto Exposure mode
MANUAL	Manual Exposure mode
FLK 60Hz (FLK 50Hz)	Flickerless mode (Default)

- SHUT LEVEL (Shutter Level)

This menu can be accessed when the Shutter Speed is set to MANUAL.

Use the Left / Right button to adjust the shutter speed control level.

Instead of using the default conventional shutter speed of 1/60, you may choose other speeds. The speeds corresponding to the value of shutter level are listed below.

Shutter Speed	1/50	1/60	1/100	1/120	1/250	1/500	1/700	1/1000	1/1600	1/2500	1/5000	1/7000	1/10000
Level	178	169	142	135	105	65	46	32	20	12	6	4	3

9. OSD MANUAL

• WHITE BALANCE

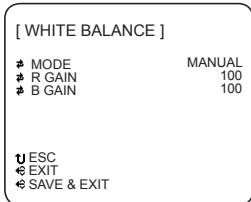

- MODE

Using Left / Right button, select White balance modes – ATW, PUSH and MANUAL.

ATW	Auto Trace White Balance mode
PUSH	White Balance Push Lock mode (Auto White Balance Control & Lock)
MANUAL	Manual White Balance mode

- R GAIN

This menu appears on screen when MANUAL is selected.
Using Left / Right button, adjust Red Gain.

-B GAIN

This menu appears on screen when MANUAL is selected.
Using Left / Right button, adjust Blue Gain.

* NOTE

R GAIN and B GAIN is correlated with the G GAIN internally, so the R GAIN and B GAIN may increase or decrease with the other color gain.

9. OSD MANUAL

• Day / Night

[DAY / NIGHT]	
# MODE	AUTO
# DAY LEVEL	50
# NIGHT LEVEL	100
↑ ESC	
↶ EXIT	
↷ SAVE & EXIT	

- MODE

Using Left / Right button, select TDN(True Day & Night) modes – AUTO, EXT, COLOR, and BW.

AUTO	Controlled by AGC level in the processor. (AGC Type)
EXT	Controlled by signal from CDS sensor. (CDS Type)
COLOR	Fixed Day State. Color Image.
BW	Fixed Night State. BW Image.

- DAY/Night Levels

This menu can be displayed by selecting AUTO or EXT in the MODE Menu.
The Day Level and Night Level thresholds function independently from each other.

- DAY LEVEL

The threshold of change from B&W Mode to Color Mode can be adjusted with values between 0 - 127. A lower value will prevent the camera from switching to Color until the scene becomes brighter.

- NIGHT LEVEL

The threshold of change from Color Mode to B&W Mode can be adjusted with values between 0 - 127. A higher value will prevent the camera from switching to B&W until the scene becomes darker.

Note: There is a built in offset between the Day and Night Level to prevent a switching level conflict. The effective Day level can not be set lower than the Night level

9. OSD MANUAL

• IMAGE

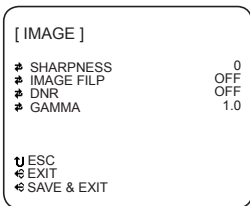

- **SHARPNESS:** Using Left / Right button, adjust sharpness value.
- **IMAGE FLIP:** Using Left / Right button, select Flip modes – OFF, H FLIP, V FLIP and HW FLIP.
- **DNR:** Using Left / Right button, select Digital Noise Reduction Modes - OFF, LOW, MID, HIGH.
- **GAMMA:** Using Left / Right button, adjust gamma control setting.

• SPECIAL

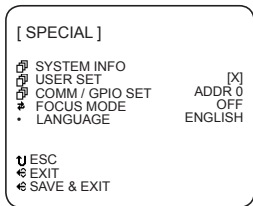

- SYSTEM INFO

Display Camera Version, SDI IF F/W Version & other information.

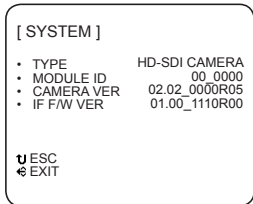

9. OSD MANUAL

- USER SET

Using Set button, display [USER SET] sub menu.

- COMM/GPIO SET

Using Set button, display [COMM/GPIO SET] sub menu.

- FOCUS MODE

In focus mode, the iris becomes fully open, electronic shutter controls the light level, and the TV out screen zooms into the center in order to make focusing easier. When in Focus Mode, the OSD Menu is not displayed. The OSD Menu can be toggled on and off using the Left / Right button.

> TV Out Image



FOCUS MODE OFF



FOCUS MODE ON

- LANGUAGE

Select OSD Language. (Only English is available, currently)

• USER SET (Sub Menu)

[USER SET]

↓ SAVE USER SET

↓ LOAD USER SET

↓ CLEAR USER SET

↓ FACTORY RESET

↓ CAMERA RESET

⏏ ESC

⏏ EXIT

[X]

- SAVE USER SET

Saves a copy of the current configuration set by the user into a separate memory area. If user set data has been saved, an [O] mark is displayed and if not, an [X] mark is displayed. User Set settings can NOT be loaded automatically when the camera is powered on. They can only be loaded manually via the "LOAD USER SET" OSD choice. To make the values in a User Set become the configuration loaded when the camera is powered on, first load that User set, then choose "SAVE AND EXIT" in any of the OSD Screens; the current User Set OSD Settings will be written to the power on configuration. These steps effectively copy a User Set to the power on configuration.

- LOAD USER SET

Load the saved user set, and applies to Camera.

- CLEAR USER SET

Clear all saved user set.

- FACTORY RESET

Clear all setting and initialize to factory setting.

Clear user set.

- CAMERA RESET

Reboot the Camera.

9. OSD MANUAL

• COMM/GPIO SET (Sub Menu)

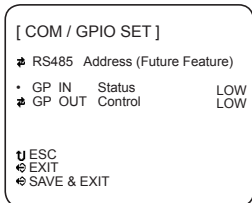

- RS485 Address

Future Feature.

- GP IN Status (CDS Mode Only Digital input Future Feature)

If the OSD is set to the EXT mode in the [DAY/NIGHT] menu, this port is used to connect to a photo-sensor.

- GP OUT Control (Future Feature).

For control of an external device by the camera.

EverFocus Electronics Corp.

Corporate Headquarters:
12F, No.79 Sec. 1 Shin-Tai Wu Road,
Hsi-Chih, Taipei, Taiwan
TEL: +886-2-26982334
FAX: +886-2-26982380
www.everfocus.com.tw
marketing@everfocus.com.tw

U.S.A - California Office:
1801 Highland Avenue Units A & B
Duarte, CA 91010
TEL: +1-626-844-8888
FAX: +1-626-844-8838
www.everfocus.com
sales@everfocus.com

Europe - Germany Office:
Albert-Einstein-Strasse 1,
D-46446 Emmerich, Germany
TEL: +49-2822-93940
FAX: +49-2822-939495
www.everfocus.de
info@everfocus.de

India Office:
Suite 803, Housefin Bhavan, C-21,
Bandra Kurla Complex, Bandra (East),
Mumbai 400051, India.
TEL: +91-222-444-8791
FAX: +91-222-444-8790
www.everfocus.in

China Office:
Room 609, Technology Trade Building,
Shangdi Information Industry Base,
Haidian District, Beijing, China 100085
TEL: +86-10-62973336~39
FAX: +86-10-62971423
www.everfocus.com.cn
marketing@everfocus.com.cn

U.S.A - New York Office:
415 Oser Avenue Unit S
Happauge, NY 11788
TEL: +1-631-436-5070
FAX: +1-631-436-5077
www.everfocus.com
sales@everfocus.com

Japan Office:
5F Kinshicho city Building,
2-13-4 Koto-Bashi,
Sumida-Ku, Tokyo, 130-0022 Japan
TEL: +81-3-5625-8188
FAX: +81-3-5625-8189
www.everfocus.co.jp
info@everfocus.co.jp

UK Office:
Unit 12 Spirefire Business Park
Hawker Road
Croydon, CR0 4WD
London: 0845 430 9999
Telford: 0845 430 8888
Fax: 020 8649 9907
uk.support@EverFocus.com



Your EverFocus product is designed and manufactured with high quality materials and components which can be recycled and reused.

This symbol means that electrical and electronic equipment, at their end-of-life, should be disposed of separately from your household waste.

Please, dispose of this equipment at your local community waste collection/recycling centre.

In the European Union there are separate collection systems for used electrical and electronic product. Please, help us to conserve the environment we live in!

Ihr EverFocus Produkt wurde entwickelt und hergestellt mit qualitativ hochwertigen Materialien und Komponenten, die recycelt und wieder verwendet werden können.

Dieses Symbol bedeutet, dass elektrische und elektronische Geräte am Ende ihrer Nutzungsdauer vom Hausmüll getrennt entsorgt werden sollen.

Bitte entsorgen Sie dieses Gerät bei Ihrer örtlichen kommunalen Sammelstelle oder im Recycling Centre. Helfen Sie uns bitte, die Umwelt zu erhalten, in der wir leben!



EverFocus®

Free Manuals Download Website

<http://myh66.com>

<http://usermanuals.us>

<http://www.somanuals.com>

<http://www.4manuals.cc>

<http://www.manual-lib.com>

<http://www.404manual.com>

<http://www.luxmanual.com>

<http://aubethermostatmanual.com>

Golf course search by state

<http://golfingnear.com>

Email search by domain

<http://emailbydomain.com>

Auto manuals search

<http://auto.somanuals.com>

TV manuals search

<http://tv.somanuals.com>