

English – GN 6110 user guide

This user guide provides you with information on setting up, using and maintaining your GN 6110.

CONTENTS

1. Product information

- 1.1 GN 6110 – what's in the box
- 1.2 Parts and signatures

2. Assembling your GN 6110

- 2.1 Setting up for desk telephone use
 - Connecting cords
 - Charging headset
 - Clear dial tone adjustment
- 2.2 Setting up for mobile telephone use
 - Pairing

3. Operating the GN 6110

- 3.1 Operation – with desk telephone
- 3.2 Operation – with mobile telephone

4. Additional functionality and features

- 4.1 Volume settings and functions
- 4.2 Wearing and wearing styles
- 4.3 Setting up your GN 1000 RHL (accessory)
- 4.4 Operation with your GN 1000 RHL (accessory)
- 4.5 Battery charging
- 4.6 Pairing your headset to the base
- 4.7 Reset
- 4.8 Audio and visual indicators

5. Frequently asked questions

6. Cleaning, safety and maintenance

1. Product information

Congratulations on purchasing the GN 6110, which consists of a base and headset. The GN 6110 accepts calls from both your desk and mobile phone, letting you answer/make a call from either your desk or mobile phone via your headset. If using your headset for a call from your desk phone, an incoming call from your mobile phone will not be accepted by your headset. If using your headset for a call from your mobile phone, an incoming call from your desk phone will not be accepted by your headset.

To fully benefit from your GN 6110, follow the instructions in this user guide step by step.

1.1 GN 6110 – What's in the box

- 1 GN 6110 headset, with built-in rechargeable battery
- 2 GN 6110 base (connectivity unit)
- 3 Connection cord for telephone connection
- 4 Power adapter with cord
- 5 Quick Set Up guide
- 6 User guide
- 7 Cord management strips
- 8 Headset travel charger (90-240 V)

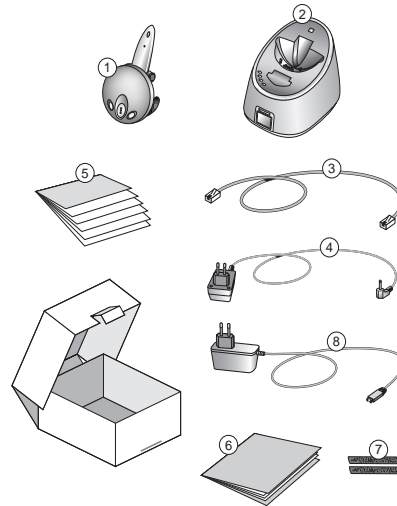

1.2 GN 6110 – Parts and signatures

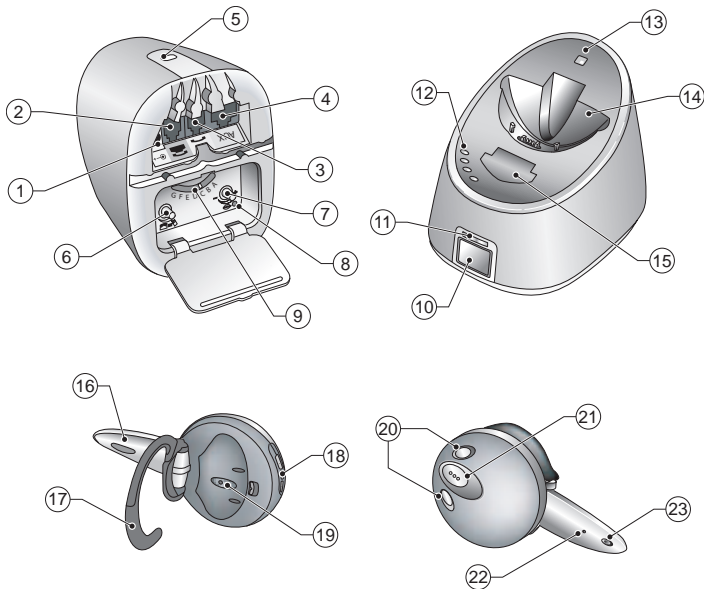

- | | |
|--|---|
| <ol style="list-style-type: none"> 1 Power adapter socket 2 Telephone socket 3 Handset socket 4 Hook switch [AUX] socket (accessory) 5 Additional functionality port 6 Volume match dial 7 Microphone volume dial 8 Reset button 9 Clear dial tone termination switch 10 Base Multifunction Button (MFB) 11 Pairing indicator 12 Battery indicator | <ol style="list-style-type: none"> 13 On-line indicator 14 Charging cradle 15 Headset release button 16 Headset boom arm 17 Earhook 18 Charging port 19 Speaker 20 Volume buttons 21 Headset Multifunction Button (MFB) 22 Microphone 23 Headset indicator |
|--|---|

2. Assembling your GN 6110



First assemble your GN 6110 to work with your desk telephone, and then set it up to work with your mobile phone. The GN 6110 supports the GN 1000 Remote Handset Lifter for desk telephones.

See Section 4.3 for hook switch set up instructions and use.

2.1 Setting up for desk telephone use

Connecting cords

To set up your GN 6110, connect the cords by completing the following instructions:

1. Connect the power adapter cord to the socket marked  [A]. All of the base's indicators will flash once when power is connected.
2. Unplug your telephone's handset from the handset port on the bottom of your telephone and plug its cord into the base's socket marked  [C]
3. The blue colored cord will go from the blue socket on the base back to the now free handset port. [B].
4. Place all cords into the base's slots to ensure a fully functional product. [D]

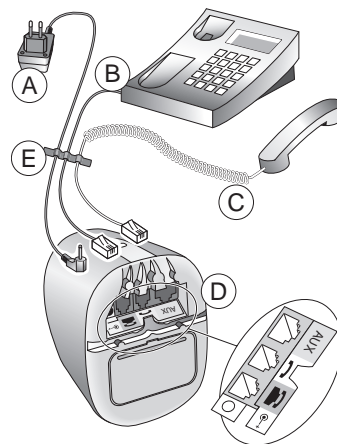

Note: For your convenience, you may also feed the telephone cord through the base's right or left slot, depending if your desk telephone is positioned to the right or left of the base.

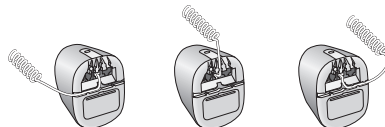

5. Use the cord management strips to fasten and organise the cords. [E]

Charging headset

Before using your headset, charge it for a minimum of two hours. You may charge the headset by placing it in the base or with the travel charger cord.

During initial (and subsequent) charging, you may continue to use your desk telephone as normal.

See Section 4.5 for full details on charging batteries and the battery charge level indication.

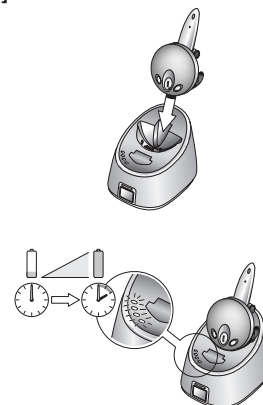

Pairing of headset to the base and verifying pairing

The headset and the base in their original product box have been factory-paired to ensure proper functioning of your GN 6110. You do not need to pair these two devices, and you may now proceed to the *Clear dial tone adjustment* section.

If original pairing is lost (by resetting the base, changing your headset or changing your base), you will have to pair your headset to the base again. You may also verify pairing between the headset and base at any point (except during telephone conversations). See Section 4.6 for these instructions.

Clear dial tone adjustment

Desk telephones operate on a range of standards. In order for your GN 6110 to work with your desk telephone and to hear a clear, crisp dial tone, you must set the correct dial tone setting. Consult the inside back cover of this user guide for the most common telephone models and settings.

Complete the following instructions to set the correct dial tone adjustment:

1. Open the compartment cover on the bottom of the base and locate the termination switch **[A]**.
2. Put on your headset and press the base's Multifunction button. An audible tone will shortly be heard.
3. Lift the telephone's handset from the cradle and listen for a dial tone in your headset.
4. If there is no dial tone or it is not clear, stepwise slide the termination switch through all 7 settings (along the A-G range), listening for the clearest possible dial tone. If the dial tone is just as clear in position A as in position G, leave the switch in position A.
5. When you hear the clearest dial tone, you have located the correct termination setting.

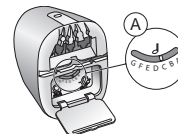

Microphone volume adjustment

In order to ensure that your voice is neither too loud nor too soft when calling others, adjust the transmit sound volume. You will need to make a call with your desk telephone to adjust it.

Complete the following instructions to adjust the transmit volume:

1. Open the compartment cover on the bottom of the base and locate the blue microphone volume adjustment button **[A]**.
2. Put on your headset and press the Multifunction Button on the base. An audible tone will shortly be heard.
3. Lift the telephone's handset from the cradle and listen for a dial tone in your headset.
4. Using your desk telephone, make a call to someone who will act as your test person.
5. While speaking with your test person, adjust the blue microphone volume adjustment button until he/she hears your voice at an appropriate level.

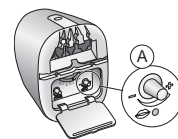

2.2 Setting up for mobile telephone use

The GN 6110 headset is also compatible with Bluetooth mobile phones. The mobile phone you use with your GN 6110 must be Bluetooth technology-equipped.

Setting up the headset to a mobile phone (pairing)

Before using your headset for the first time with a mobile phone, you must pair your headset and mobile telephone by completing the following:

1. Press and hold down the Multifunction Button on the headset for 5 seconds, after which the headset indicator lights. **[A]**
2. Within 3 seconds, open the headset boom arm. The headset can be paired within the next 5 minutes.
3. Put the mobile phone into pairing mode, according to your mobile phone's user manual. **[B]**

Note: Your mobile phone must be Bluetooth-equipped in order to pair it with the GN 6110.

4. From your mobile phone, perform a *device discovery* so that your mobile phone will find your headset and pair to it. This may take several seconds.

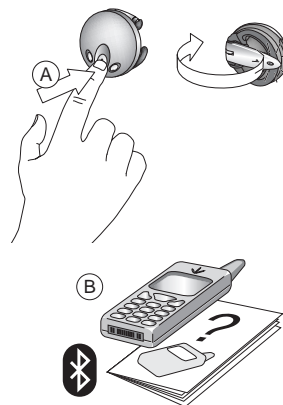

Note: Ensure that the mobile device and the headset are within 1 metre of each other. **[C]**

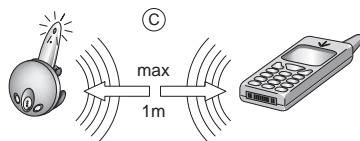

5. When your mobile phone prompts you, enter the following 4-digit passkey code: **0000**. The mobile phone will now begin pairing and store your GN 6110 headset in its memory. Your mobile phone screen will advise that pairing has been successful. The headset indicator will rapidly flash 10 times, and a beep will be heard in the headset to indicate successful pairing.

After successful pairing, your headset is ready to use with your mobile phone. Consult your mobile phone's user guide for full details on utilising a Bluetooth headset with your mobile phone.

3.0 Operating the GN 6110

3.1 Operation – with desk telephone

If your headset is in its base, press the release headset button to free the headset before using it.

Turning headset ON:

Open the headset boom arm. The headset indicator lights for 2 seconds, and then continue to flash slowly as long as the headset is on.

Turning headset OFF:

Close the headset boom arm. The headset indicator lights for 2 seconds, after which it will turn off.

Making calls:

1. With the boom arm open, press the Multifunction Button on either the headset **[C]** *or* the base **[B]**. An audible tone will be heard and the connection will be established shortly.
2. Lift the telephone's handset, *or* press the telephone's line button if your telephone has one. A dial tone will be heard.
3. Dial the desired number when the dial tone is heard in your headset.

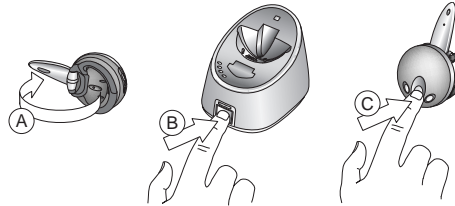

The headset indicator and the on-line indicator will flash rapidly for the duration of the call.

Answering calls:

1. With the boom arm open, press the Multifunction Button on either the headset or the base. An audible tone will be heard and the connection will be established shortly.
2. Lift the telephone's handset, *or* press the line button if your telephone has one. The headset indicator and the pairing indicator will flash rapidly for the duration of the call.

Ending calls:

1. Press the Multifunction Button on either the base or the headset.
2. Lower the telephone's handset, or press the line button if your telephone has one.

Headset <-- --> handset switching (while on a call).

To switch from using the headset to the handset during a call:

1. Terminate the link between the headset and the base by either closing the headset boom arm **[A]** *or* pressing the Multifunction Button on the base **[B]** or the headset **[C]**.
2. The call is now terminated in the headset, and can be continued in the handset.
3. To end the call, hang up the telephone handset.

To switch from using the handset to the headset during a call:

1. With the boom arm open, press the Multifunction Button on either the headset or the base. An audible tone will be heard and the connection will be established shortly.
2. The call is now terminated in the handset, and can be continued in the headset.
3. To end the call, press the Multifunction Button on either the base *or* the headset, *or* close the headset boom arm.
4. Lower the telephone's handset. On telephones equipped with a line button, press the line button to end the call.
5. You may continue wearing the headset, or place it in the base (with the boom arm closed) for recharging.

3.2 Operation – with mobile telephone

If your headset is in its base, press the release headset button to free the headset before using it.

Turning headset ON:

Open the headset boom arm. The headset indicator lights for 2 seconds, and then continue to flash slowly as long as the headset is on.

Turning headset OFF:

Close the headset boom arm. The headset indicator lights for 2 seconds, after which it will turn off.

Making calls:

1. Open the headset boom arm and place the headset on the ear.
2. Dial the desired number on your mobile, and press the mobile's Yes/Send/Call button to begin calling.

The headset indicator will flash rapidly for the duration of the call.

Making voice-activated calls:

Note: Before making voice-activated calls, voice dialling must be activated on your mobile phone and voice tags stored. Consult your mobile phone's user guide for full details.

To make voice-activated calls:

1. Open the headset boom arm and place the headset on the ear.
2. Press the Volume up/down buttons simultaneously on the headset for 3 seconds. The headset will go into voice command mode, and an audible tone will be heard indicating that the headset is expecting a voice command.
3. Give the desired voice command.

The headset indicator will flash rapidly for the duration of the call.

Answering calls:

1. Press the Multifunction Button on the headset, **or** open the headset boom arm if not already opened.
The connection will be established shortly.
2. An audible tone will be heard, and you are now connected to your caller.

The headset indicator will flash rapidly for the duration of the call.

Ending calls:

Press the Multifunction Button on the headset. An audible tone will be heard.

The call will also terminate if the mobile phone's *End Call* button/functionality is used, or if the second party hangs up.

Headset <-- --> mobile phone switching (while on a call).

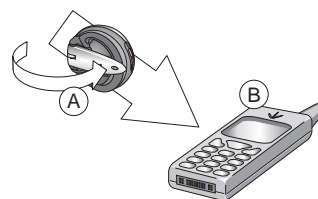

To switch from using the headset to mobile phone during a call:

1. Terminate the link between the headset and the mobile phone by closing the headset boom arm [A]
Note: do not press the Multifunction Button.
2. The mobile phone will prompt you to continue the call [B].
3. You have 30 seconds to accept the transfer to your mobile phone; after accepting continue the call on your mobile phone.
4. To end the call, use the mobile phone's *End Call* button/functionality.

To switch from using the mobile phone to the headset during a call:

1. With the boom arm open, simultaneously press the Volume up/down on the headset.
2. An audible tone will shortly be heard, and the connection will be established momentarily.
3. Continue the call on your headset.
4. To end the call, press the Multifunction Button on the headset.
5. You may continue wearing your headset, **or** close the headset boom arm and place in the base for charging.
Consult your mobile phone's user guide for full details.

4.0 Additional functionality and features

4.1 Volume settings and functionality

Volume adjust [A]

There are two volume buttons, one on each side of the headset's Multifunction Button. The GN 6110's headset comes equipped with intelligent volume re-orientation, so no matter which ear you wear the headset on, the topmost of the two volume buttons is always volume + (up) and the lower button is always volume - (down).

Press the volume + (up) or volume - (down) button until the desired volume level has been reached. If minimum/maximum volume is reached, an audible tone will be heard in the headset.

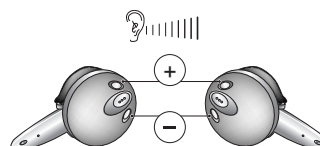

Volume match

For your own comfort, match the volume level of your desk telephone to that of your mobile phone. This will ensure that you get a consistent volume level for all of your calls, no matter which device you use. After the initial volume match, subsequent volume level changes made on your headset will be replicated on your desk and mobile phones.

You will need to make 2 calls to adjust the volume match, one using your mobile phone and the other using the desk telephone.

1. Open the compartment cover on the bottom of the base and locate the black volume match button **[A]**
2. Using your mobile telephone, make an initial test call to someone and have a brief conversation, keeping in mind the volume level of the conversation.
3. Using your desk telephone, make a second test call to the same person.
4. While speaking with your test person, again adjust the black volume match adjustment button until the volume level of this conversation matches that of the first mobile phone's test conversation.

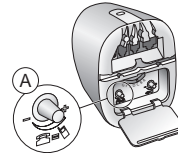

4.2 Wearing and wearing styles

Choosing right or left ear wearing styles

The GN 6110's headset comes configured for wearing on your right ear.

To change for left ear wearing, use the instructions as follows:

1. Open the headset boom arm.
2. Put the headset's earhook in its opened position.
3. Gently lift and pull the top of the earhook up from the upper hinge pin and pull away to remove **[A]**.
4. Turn the headset over **[B]**.
5. Hook the bottom of the earhook on to the lower hinge pin and lift and pull the top of the earhook over the upper hinge pin **[C]**.
The volume + (up) or volume - (down) buttons will re-orient automatically.

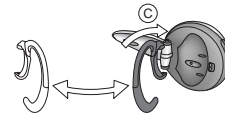
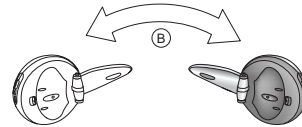
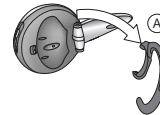

Placing the headset on your ear [A]

In order to wear the headset follow these instructions:

1. Open the headset boom arm.
2. Put the earhook in its opened position (90° away from the headset).
3. Loop the earhook behind your ear.
4. Close the headset boom arm towards your ear.
The headset boom arm will then point towards your mouth.

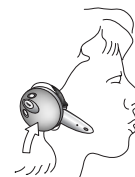
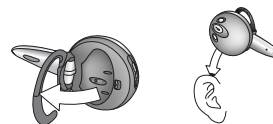

4.3 Setting up your GN 1000 RHL (accessory)

The GN 6110 can be connected to GN Netcom's GN 1000 Remote Handset Lifter (accessory). This gives you the additional convenience of answering and ending calls even while away from your desk.

To connect your GN 1000 to the GN 6110, complete the following:

1. Connect the GN 1000's connector cord to the yellow-marked hook switch [AUX] socket on the bottom of the base [A].
2. Consult the GN 1000 user guide to complete the set up.

Note: If you cannot locate the GN 1000 product box and/or user guide, consult GN Netcom's web pages at www.gnnetcom.dk.

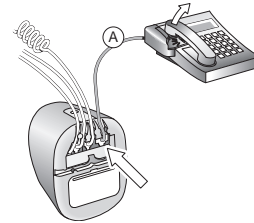

Your GN 6110 is now ready to use with your GN 1000, and you may proceed to Section 4.4.

4.4 Operation with your GN 1000 RHL (accessory)

Turning headset ON:

Open the headset boom arm. The headset indicator lights for 2 seconds, and then continue to flash slowly as long as the headset is on.

Turning headset OFF:

Close the headset boom arm. The headset indicator lights for 2 seconds, after which it will turn off.

Making calls:

1. With the boom arm open, press the Multifunction Button on either the headset [C] **or** the base [B]. An audible tone will be heard and the connection will be established shortly.
2. The hook switch will be activated, and your telephone's handset will be lifted.
3. Dial the desired number when the dial tone is heard.
The headset indicator and the base's on-line indicator will flash rapidly for the duration of the call.

Answering calls:

1. Press the Multifunction Button on either the headset [C] **or** the base [B], **or** open the headset boom arm [A] if not already opened. If the headset is already being worn, an audible beep will indicate an incoming call, after which press the Multifunction Button.
2. An audible tone will be heard, and you are now connected to your caller.
The headset indicator and the pairing indicator will flash rapidly for the duration of the call.

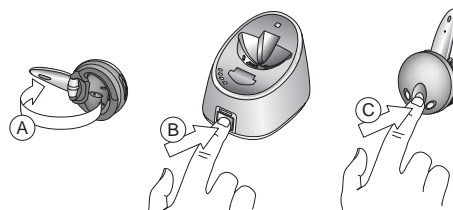

Ending calls:

1. Press the Multifunction Button on either the base **or** the headset, **or** close the headset boom arm. Your call is now terminated.

- You may continue wearing your headset, or replace the (closed) headset boom arm in the base for charging.

Headset <-- --> handset switching (while on a call)

To switch from using the headset to the handset during a call:

- Pick up the telephone's handset [A].
- Close the headset boom arm [B], or press the Multifunction Button on the base [C] or the headset [D] to continue the call on the handset.
- To end the call, hang up the telephone handset.

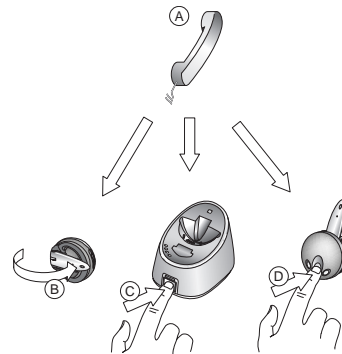

Note: Closing the boom arm gives you a few seconds to pick up the telephone handset.

To switch from using the handset to the headset during a call:

- With the boom arm open, press the Multifunction Button on either the headset or the base. The connection will be established shortly.
- When the hook switch is activated, place the handset on the lifter arm.
- To end the call, press the Multifunction Button on either the base or the headset, or close the headset boom arm.
- You may continue wearing the headset, or place it in the base (with the boom arm closed) for recharging.

4.5 Battery charging

With an initial full battery charge and continual daily charging, the GN 6110's battery will give you years of reliable service.

Charging in the base charger

To charge in the base, place the headset into the base. The headset indicator lights to indicate charging, and will turn off when fully charged.

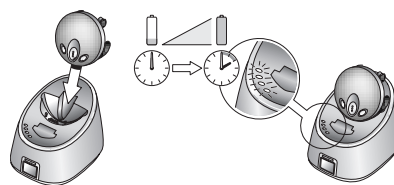

Note: To ensure optimal charging, ensure that the headset is placed firmly and completely into the base.

To use your headset, press the release headset button to free the headset from its base.

During initial (and subsequent) charging, you may use your desk telephone's handset.



Battery charge indication

The headset indicator lights to indicate charging, and will turn off when fully charged. The 4 lights of the battery indicator show the approximate battery charge level of the headset:

- 1 lit indicator represents 25% of a full charge (will flash if less than 25%)
- 4 lit indicators represent a full charge.

Charging with the travel charger

The travel charger works universally (90-240 V), letting you charge the headset in any country. You will need to purchase separately any required electrical outlet plug-in adapters.

To charge with the travel charger, insert the travel charger plug into the electrical outlet and the cord's plug into headset.

Note: To ensure optimal charging, ensure that the plug of the travel charger is placed correctly into the headset. The headset indicator lights when the headset is charging.

Battery saving mode

To save power, the headset enters snooze mode after 1 minute of inactivity. This will in no way affect the normal use of the headset, and it will re-activate itself immediately when used or when a call is received.

4.6 Pairing your headset to the base

Pairing your headset

In order for your GN 6110 to work correctly, the headset and the base must be paired together. For your convenience, these two devices in their original product box have been factory-paired.

If this original pairing is lost (by resetting the base, changing your headset or changing your base), you will have to pair your headset again to the base. Complete the following steps to pair your headset again to the base:

1. Press and hold down the Multifunction Button on the headset for 5 seconds **[A]**, after which the headset indicator lights **[B]**.
2. Within 3 seconds, open the headset boom arm. The headset can now be paired within the next 5 minutes.
3. Press and hold down the Multifunction Button on the base for 5 seconds, after which the pairing indicator lights. **[C]**

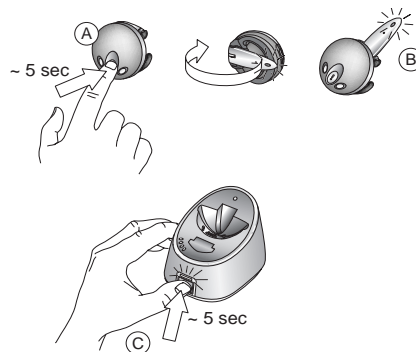

Note: Ensure that the headset and base are within 1 metre of each other. After 5 seconds, the base will automatically pair with the headset.

Successful pairing will be indicated by 10 rapid flashes of both the headset indicator and the pairing indicator. A beep will also be heard in the headset.

Verifying pairing

To verify pairing, create an audio link between the headset and base by completing the following:

1. With the boom arm open, press the Multifunction Button on either the headset **[C]** *or* the base **[B]**.
An audible tone will be heard, and the headset indicator and online indicator will flash rapidly.
2. To end the audio link, press the Multifunction Button on either the headset or base, or close the headset boom arm.

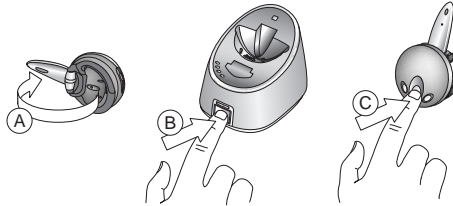

Note: You may verify pairing at any point. However, during telephone conversations, verifying pairing is not possible.

4.7 Reset

You may reset the base to remove pairing settings. To reset the base, complete the following:

1. Open the compartment cover on the bottom of the base and locate the reset button.
2. With a pointed object (such as an unfolded paperclip), press the reset button on the base for 10 seconds **[A]**.

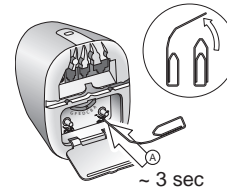

When the base is reset, the pairing indicator lights for 2 seconds.

Note: If you reset the base you will have to pair your headset to the base again. See Section 4.6 for pairing instructions.

4.8 Audio and visual indicators

The GN 6110's headset and base have audio and visual indicators, which represent various actions and aspects associated with setting up and operating the product.

The headset gives audio and visual indications. The base gives various visual indications via its online, link and general indicators. Familiarise yourself with these indicators to fully benefit from your GN 6110.

The headset's audio indicators:

Headset action	Audio indication
Volume Limit	Repeated single high tone when min. or max. limits achieved (when button is pressed)
Low Battery Tone	Two rapid high tones repeated every 20 seconds
Out of Range	No audio indications; gradual deterioration of audio quality
Incoming Call from Mobile	Ring tone A
Incoming Call from desk phone	Ring tone B (only when using hook switch)
Pairing Confirmation – with base – with mobile	2 single tones 1 single tone
Establish Audio Link	Series of tones, low to high
Initiate Voice Dial	Single low tone
Voice Tag not Recognised	Dual high-low tone
End Call/Audio Link Closed	Series of tones, high to low
Power ON/OFF	No audible tone

The headset's visual indicators:

Headset mode	Headset indicator
Power Off	OFF (no charger)
Charging in Process	ON (charger plugged in, or headset placed in base)
Charging Complete	OFF (charger plugged in, or headset placed in base)
Pairing Mode	ON (no charger) with headset boom arm opened
Pairing Successful	Series of 10 rapid flashes
Audio Link (on a call)	Rapidly flashes
Headset ON	Continuous single flash (slow)
Headset ON and in range of base	Continuous double flash (slow)
Opened boom arm (turn ON)	Lights for two seconds
Closed boom arm (turn OFF)	Lights for two seconds
Test link established	Rapidly flashes

The base's visual indicators:

Base's on-line indicator	On-line indicator
On-line with a call	Flashes
Base's pairing indicator	Pairing indicator
Pairing Mode	ON
Pairing Successful	Series of 10 rapid flashes
Base reset Successful	Lights for two seconds

Base's multifunction indicator

Battery indication

Multifunction indicator

Number of lit indicators indicates level of charge

1 flashing indicator < 25% charged

1 lit indicator = 25% charged

2 lit indicators = 50% charged

3 lit indicators = 75% charged

4 lit indicators = 100% charged

ALL base's indicators

Power is turned ON

All indicators

Flash for a few moments.

5. Frequently asked questions

Should I unplug my telephone's line cord from the wall?

No, do not unplug your telephone's line cord from the wall. Your GN 6110 is not a telephone, but rather works with your desk telephone. The GN 6110 base accesses the telephone line via your existing desk telephone.

I've set up my GN 6110 but I still don't hear a dial tone?

There are several possible reasons why you do not hear a dial tone. Check that:

- The various cords are correctly set up and inserted.
- The clear dial tone adjustment (using the termination switch at the bottom of the base) is correct.
- The power supply is correctly hooked to the base.
- You have not unplugged your desk telephone's telephone line.

What is the yellow-coloured AUX socket on the bottom of the base for?

The yellow-marked AUX socket is where you may connect the (optional) GN 1000 Remote Handset Lifter's connector cord. By connecting the GN 1000, you may answer/end calls while up to 10 meters away from your desk.

How long do I have to charge the headset before I can use it?

It takes 2 hours to fully charge your headset. Although you may already use your headset after 20 minutes of charging, we recommend you allow 2 hours of charging before you use your headset.

The battery indicator represents the charge level of your headset. One lit green indicator represents a 25% charge and when all four indicators are lit the headset is fully charged.

How do I lift the headset out of its base?

Press the headset release button first, and then lift the headset from the base unit. The headset release mechanism allows the headset to sit firmly in the base, thus guaranteeing its charging.

Can I wear the headset on either the left of the right ear?

Yes, you can wear the headset on either the left or the right ear. To change the wearing ear, open the headset boom arm, open and remove the earhook, turn the headset over and finally reinsert the earhook. Full instructions and illustrations can be found in Section 4.3.

What is the clear dial tone adjustment for?

Desk telephones operate on a wide range of standards and use different kinds of internal components. The GN 6110 works with a very wide range of desk telephones, but it still must be set to match your desk telephone's standard. The GN 6110's termination switch (located at the bottom of the base) has a sliding 7-setting that must be adjusted until you hear a clear, crisp dial tone. Once you have a clear dial tone, your GN 6110 is correctly adjusted.

Why do I need to volume match the headset and desk telephone?

Volume match ensures consistency between the volume levels of received calls. Once you have completed volume match, the volume you hear in your ear will be at the same level, irrespective of if the call comes from your desk or mobile phone. Furthermore, if you adjust the headset's volume up or down during normal use, it will apply consistently for calls from both your desk and mobile phone.

How do I make and end calls with my headset?

To make a call, open the boom arm, press the Multifunction Button, lift the telephone's handset (or simply press its line button), listen for the dial tone and dial the desired number.

To end a call, press the Multifunction Button on the headset or base and lower the telephone's handset (or simply press its line button).

6. Cleaning, safety and maintenance

Clean the headset, including the headset boom arm and ear hook piece, by wiping with a slightly damp cloth as required. Dampen the cloth with only water and a little washing-up liquid if needed. Avoid getting moisture into any button sockets or other openings. The base and cords may be dry-dusted as required.

Do not immerse the GN 6110 in water.

The plastic bags the GN 6110 and its parts are wrapped in are not toys for children. The bags themselves or the many small parts they contain may cause choking if ingested.

Only authorised dealers or service centres may open the product. If any parts of your GN 6110 require replacement for any reason, including normal wear and tear or breakage, contact your dealer.

Dispose of the product and battery according to local standards and regulations. The battery is guaranteed for one year.

Declaration

This product is CE marked according to the provisions of the R & TTE Directive (99/5/EC). Hereby, GN Netcom as declares that this product is in compliance with the essential requirements and other relevant provisions of Directive 1999/5/EC.

Please note that this product uses radio frequency bands not harmonised within EU. Within the EU, this product is intended to be used in Austria, Belgium, Denmark, Finland, France, Germany, Greece, Ireland, Italy, Luxembourg, The Netherlands, Portugal, Spain, Sweden, United Kingdom and within EFTA in Iceland, Norway and Switzerland.

- Never try to dismantle the product yourself. None of the internal components can be replaced or repaired by users.
- Avoid exposing the product to rain or other liquids.
- The headset may become warm during battery charging. This is normal and will not affect the safety or performance of the headset.

If you have any problems or questions regarding the product, please contact your reseller or go to <http://www.gnnetcom.com>

There is an international patent pending for the GN 6110 and its elements.

USA FCC part15 FCC Notice to Users/Product Statements

This device complies with part 15 of the FCC rules. Operation is subject to the following two conditions:
(1) This device may not cause harmful interference, and (2) This device must accept any interference received, including interference that may cause undesired operation.

Users are not permitted to make changes or modify the device in any way. Changes or modifications not expressly approved by GN Netcom will void the user's authority to operate the equipment.

Note: This equipment has been tested and found to comply with the limits for a Class B digital device, pursuant to part 15 of the FCC Rules. These limits are designed to provide reasonable protection against harmful interference in a residential installation.

This equipment generates, uses and can radiate radio frequency energy and, if not installed and used in accordance with the instructions, may cause harmful interference to radio communications. However, there is no guarantee that interference will not occur in a particular installation. If this equipment does cause harmful interference to radio or television reception, which can be determined by turning the equipment off and on, the user is encouraged to try to correct the interference by one or more of the following measures:

- Reorient or relocate the receiving antenna.
- Increase the separation between the equipment and receiver.
- Connect the equipment into an outlet on a circuit different from that to which the receiver is connected.
- Consult the dealer or an experienced radio/TV technician for help.

The user must place the base at least 8" (20cm) or more from any personnel and must not be co-loaded or operating in conjunction with any other antenna or transmitter in order to comply with FCC RF exposure requirements.

USA FCC part68 FCC Notice to Users/Product Statements

1. This equipment is compliant with part 68 of the FCC Rules. On the equipment is a label that contains, among other information, the FCC registration number for this equipment. If requested, this information must be provided to the telephone company.
2. The device may not be connected directly to the telephone network, but must connect to a FCC registered telephone.
3. If this device is malfunctioning, it may also be causing harm to the telephone network. The device should then be disconnected until the source of the problem can be determined and until repair has been made. If this is done, the telephone company will notify you in advance that temporary discontinuance of service may be required. But if advance notice is not practical, the telephone company will notify the customer as soon as possible. Also, you will be advised of your right to file a complaint with the FCC if you believe it is necessary.
4. The telephone company may make changes in its facilities, equipment, operations and/or procedures that may affect the operation of this equipment. If this happens, the telephone company will provide advanced notice in order for you to take the necessary steps to maintain uninterrupted service.

5. If the telephone company requests information on what equipment is connected to their lines, inform them of:
- The telephone number that this unit is connected to.
 - The FCC Registration number located on the label.

Canada

IC Notice to Users/Product Statements

Operation is subject to the following two conditions:

(1) This device may not cause interference and (2) This device must accept any interference, including interference that may cause undesired operation of the device.

The term "IC:" before the certification/registration number only signifies that registration was performed based on a Declaration of Conformity indicating that Industry Canada technical specifications were met. It does not imply that industry Canada approved the equipment

Canada Terminal equipment

IC Notice to Users/Product Statements

NOTICE: This equipment meets the applicable Industry Canada Terminal Equipment Technical Specifications. This is confirmed by the registration number.

The Ringer Equivalence Number (REN) assigned to each terminal device provides an indication of the maximum number of terminals allowed to be connected to a telephone interface. The termination on an interface may consist of any combination of devices subject only to the requirement that the sum of the Ringer Equivalence Numbers of all the devices does not exceed five.

Limited Warranty

GN Netcom, Inc. warrants to the original consumer purchaser that, except for the limitations and exclusions set forth below, the product shall be free from defects in materials and workmanship for a period of one (1) year from the date of original retail purchase ("Warranty Period"). The obligation of GN Netcom, Inc. under this warranty shall be limited to repair or replacement, at GN Netcom, Inc.'s option, without charge, of any part or unit that proves to be defective in material or workmanship during the Warranty Period, provided the product is returned to GN Netcom, Inc. at the address listed under "How to Obtain Warranty Repairs." Except as modified by applicable State Law, this warranty sets forth the extent and limit of GN Netcom, Inc.'s obligation to the purchaser and or user of the product.

Exclusions from Warranty

This warranty applies only to defective factory material and factory workmanship. Any conditions caused by accident, abuse, misuse or improper operation in violation of instructions furnished by GN Netcom, Inc., destruction or alteration, improper electrical voltages or currents, or repair or maintenance attempted by anyone other than GN Netcom, Inc., is not a "defect" covered by this Warranty. In such cases, GN Netcom, Inc. may charge you for materials and labor, even during the Warranty Period. It is the owner's responsibility to operate and care for this product in accordance with the operating instructions and specifications supplied with the product; and repairs resulting from failure to do so are not covered by the Warranty.

The following parts are considered to be subject to wear and tear in normal usage and are not covered by the Warranty: earhooks, decorative finishes and all foam products (earpads, microphone covers).

Implied Warranty

Under state law, you may be entitled to the benefit of certain implied warranties. These implied Warranties will continue in force only during the Warranty Period. Some states do not allow limitations on how long an implied warranty lasts, so the above limitation may not apply to you.

Incidental or Consequential Damages

Neither GN Netcom, Inc. nor your retail dealer or selling distributor has any responsibility for any incidental or consequential damages including, without limitation, commercial loss, or for any incidental expenses, loss of time, or inconvenience. Some states do not allow the exclusion or limitation of incidental or consequential damages, so the above limitation or exclusion may not apply to you.

Other Legal Rights

This warranty gives you specific legal rights, and you may also have other rights which vary from state to state.

How to Obtain Warranty Repairs

To obtain Warranty repairs, return your unit, shipping prepaid, direct to:

In USA:	GN Netcom, Inc. 77 Northeastern Blvd. Nashua, NH 03062 USA	In Canada:	GN Netcom, Inc. 1515 Matheson Blvd., Unit 104 Mississauga, Ontario L4W 2P5
---------	--	------------	--

In Latin and South America

Please ship to the distributor from whom you purchased the product.

Please use the original container, if possible, or pack the unit in a sturdy carton with sufficient packing material to prevent shipping damage. Include the following information:

- A copy of your purchase receipt indicating the model number and date of purchase.
- Your return address.
- Reason for return.

During the Warranty Period, shipping charges for return to you will be paid by GN Netcom, Inc. for a unit requiring any repair covered by the Warranty. Return shipping will be charged to the customer during the Warranty Period for a unit requiring no Warranty repair. These shipping charges will be prepaid by GN Netcom, Inc. and billed to the customer. Damage occurring during shipment is deemed the responsibility of the carrier, and any claim should be made directly to such carrier.

Australia

CAUTION

- The Telephone Headset may hold small objects in the area of the earpiece.
- Do not use in areas where there are explosive hazards.
- Base unit must be operated at a distance of more than 20 cm from the body.

Free Manuals Download Website

<http://myh66.com>

<http://usermanuals.us>

<http://www.somanuals.com>

<http://www.4manuals.cc>

<http://www.manual-lib.com>

<http://www.404manual.com>

<http://www.luxmanual.com>

<http://aubethermostatmanual.com>

Golf course search by state

<http://golfingnear.com>

Email search by domain

<http://emailbydomain.com>

Auto manuals search

<http://auto.somanuals.com>

TV manuals search

<http://tv.somanuals.com>