



**GAS LOG VENTED
DECORATIVE APPLIANCE**
OWNER'S OPERATION AND
INSTALLATION MANUAL

For more information, visit www.desatech.com



**VTD-24N-PDG, VTD-24P-PDG,
VTD-18N-PDG, VTD-18P-PDG**



**VTD-24N-BTB, VTD-24P-BTB,
VTD-18N-BTB, VTD-18P-BTB**

**ANSI Z21.60-2003
CSA 2.26-2003**

APPROVED

WARNING: If the information in this manual is not followed exactly, a fire or explosion may result causing property damage, personal injury, or loss of life.

- Do not store or use gasoline or other flammable vapors and liquids in the vicinity of this or any other appliance.
- **WHAT TO DO IF YOU SMELL GAS**
 - Do not try to light any appliance.
 - Do not touch any electrical switch; do not use any phone in your building.
 - Immediately call your gas supplier from a neighbor's phone. Follow the gas supplier's instructions.
 - If you cannot reach your gas supplier, call the fire department.
- Installation and service must be performed by a qualified installer, service agency, or the gas supplier.

WARNING: Improper installation, adjustment, alteration, service, or maintenance can cause injury or property damage. Refer to this manual for correct installation and operational procedures. For assistance or additional information consult a qualified installer, service agency, or the gas supplier.

WARNING: This appliance is for installation only in a solid-fuel burning masonry or UL127 factory-built fireplace, constructed of noncombustible material, and connected to a working flue. (See page 7 for minimum flue opening.)

WARNING: This is a gas-fired appliance. It uses air (oxygen) from the room in which it is installed. Provisions for adequate combustion and ventilation air must be provided. Refer to the *National Fuel Gas Codes, ANSI Z233.1/NFPA 54, Section 5.3, Air for Combustion and Ventilation.*

This appliance may be installed in an aftermarket,* manufactured (mobile) home, where not prohibited by local codes.

This appliance is only for use with the type of gas indicated on the rating plate. This appliance is not convertible for use with other gases.

Warning: This product must be installed by a Licensed Plumber or Gas Fitter when installed within The Commonwealth of Massachusetts.

* Aftermarket: Completion of sale, not for purpose of resale, from the manufacturer

Save this manual for future reference.



TABLE OF CONTENTS

SAFETY INFORMATION.....	2	CLEANING AND MAINTENANCE	13
LOCAL CODES.....	3	TROUBLESHOOTING.....	14
PRODUCT IDENTIFICATION.....	3	REPLACEMENT PARTS	18
UNPACKING.....	4	ILLUSTRATED PARTS BREAKDOWN AND PARTS LIST	20
PRODUCT FEATURE	4	ACCESSORIES.....	22
INSTALLATION	7	OWNER'S REGISTRATION FORM.....	23
OPERATING APPLIANCE.....	11	WARRANTY INFORMATION	Back Cover
INSPECTING BURNERS	13		

SAFETY INFORMATION

WARNINGS

 **WARNING: Keep flue open when operating unit.**

IMPORTANT: Read this owner's manual carefully and completely before trying to assemble, operate, or service this log set. Improper use of this log set can cause serious injury or death from burns, fire, explosion, electrical shock, and carbon monoxide poisoning.

 **DANGER: Carbon monoxide poisoning may lead to death!**

 **WARNING: This product contains and/or generates chemicals known to the State of California to cause cancer or birth defects, or other reproductive harm.**

Carbon Monoxide Poisoning: Early signs of carbon monoxide poisoning resemble the flu, with headaches, dizziness, or nausea. If you have these signs, the log set may not be working properly. **Get fresh air at once!** Have log set serviced. Some people are more affected by carbon monoxide than others. These include pregnant women, people with heart or lung disease or anemia, those under the influence of alcohol, and those at high altitudes.

Natural & LP Gas : Natural & LP gas are odorless. An odor-making agent is added to the gas. The odor helps you detect a gas leak. However, the odor added to the gas can fade. Gas may be present even though no odor exists.

Make certain you read and understand all warnings. Keep this manual for reference. It is your guide to safe and proper operation of this log set.

 **WARNING: Any change to this log set or its controls can be dangerous.**

1. This appliance, as supplied, is only for use with the type of gas indicated on the rating plate.
2. If you smell gas
 - shut off gas supply

- do not try to light any appliance
- do not touch any electrical switch; do not use any phone in your building
- immediately call your gas supplier from a neighbor's phone. Follow the gas supplier's instructions
- if you cannot reach your gas supplier, call the fire department

3. Never install the log set
 - in a recreational vehicle
 - where curtains, furniture, clothing, or other flammable objects are less than 42 inches from the front, top, or sides of the log set
 - in high traffic areas
 - in windy or drafty areas
4. Before installing in a solid fuel burning fireplace, the chimney flue and firebox must be cleaned of soot, creosote, ashes and loose paint by a qualified chimney cleaner. Creosote will ignite if highly heated. Inspect chimney flue for damage. If damaged, repair flue before operating appliance.
5. You must operate this log set with fireplace doors or screens in place and fully closed. Unless provided by other means, screens shall have openings for introduction of combustion air.
6. This log set is designed to be smokeless. If logs ever appear to smoke, turn off appliance and call a qualified service person. *Note:* During initial operation, slight smoking could occur due to log curing and the burning of manufacturing residues. You may wish to add more ventilation by opening a window.
7. To reduce the creation of soot, follow the instructions in *Cleaning and Maintenance*, page 13.
8. Do not allow fans to blow directly into the fireplace. Avoid any drafts that alter burner flame patterns. Ceiling fans can create drafts that alter burner flame patterns. Altered burner patterns can increase sooting.
9. Do not use a blower insert, heat exchanger insert or other accessory not approved for use with this log set.
10. The installation and provisions for combustion and ventilation air must conform with the *National Fuel Gas Codes, ANSI Z233.1/NFPA 54, Section 5.3, Air for Combustion and Ventilation*.
11. Do not run log set
 - where flammable liquids or vapors are used or stored
 - under dusty conditions

For more information, visit www.desatech.com

SAFETY INFORMATION

Continued

12. Do not burn solid fuel in the fireplace after installing the log set. Do not use this log set to cook food or burn paper or other objects.
13. Log set becomes very hot when in use. Keep children and adults away from hot surface to avoid burns or clothing ignition. Log set will remain hot for a time after shutdown. Allow surface to cool before touching.
14. Carefully supervise young children when they are in the room with log set.
15. Do not use this appliance if any part has been under water. Immediately call a qualified service technician to inspect the appliance and to replace any part of the control system and any gas control which has been under water.
17. Turn log set off and let cool before servicing, installing, or repairing. Only a qualified service person should install, service, or repair log set.
18. Keep the appliance area clear and free from combustible materials, gasoline and other flammable vapors and liquids.
19. Provide adequate clearances around air openings.

⚠ WARNING: Do not place log scraps or lava rocks on burner.

⚠ WARNING: Any change to this log set or its controls can be dangerous.

⚠ WARNING: Do not use a blower insert, heat exchanger insert, or other accessory not approved for use with this appliance.

⚠ WARNING: Keep flue open when operating unit.

Appliance base assembly becomes very hot when running appliance. Keep children and adults away from hot surface to avoid burns or clothing ignition. Appliance will remain hot for a time after shutdown. Allow surface to cool before touching.

Carefully supervise young children when they are in the room with appliance. When using the hand-held remote accessory (Remote-Ready Models Only), keep selector switch in the OFF position to prevent children from turning on burners with remote.

You must operate this appliance with a fireplace screen in place. Make sure fireplace screen is closed before running appliance.

Keep the appliance area clear and free from combustible materials, gasoline, and other flammable vapors and liquids.

LOCAL CODES

Install and use appliance with care. Follow all local codes. In the absence of local codes, use the latest edition of *The National Fuel Gas Code ANSI Z223.1/NFPA 54**.

*Available from:

American National Standards Institute, Inc.
 1430 Broadway
 New York, NY 10018

National Fire Protection Association, Inc.
 Batterymarch Park
 Quincy, MA 02269

PRODUCT IDENTIFICATION

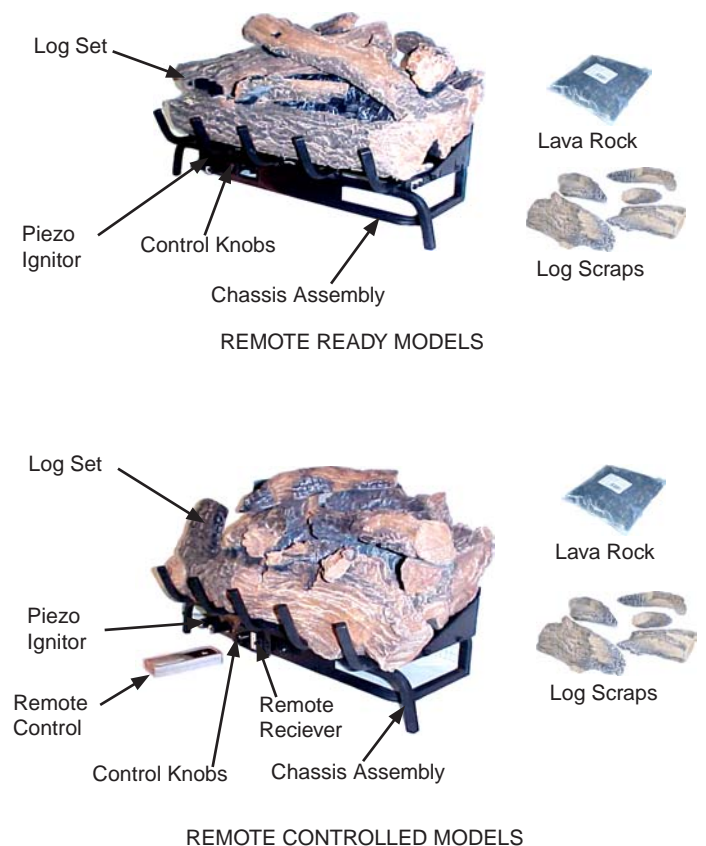

Figure 1 - Product Identification

OPTIONAL REMOTE CONTROL ACCESSORIES

There are two optional remote controls that can be purchased separately for Remote-Ready Models:

- wall switch
- hand-held ON/OFF remote

See *Accessories*, page 22.

The wall thermostat or hand-held thermostat may not be used with vented decorative appliances.

UNPACKING

CAUTION: Do not remove the data plates from the grate assembly. The data plates contain important warranty and safety information.

1. Remove log set assembly from carton. *Note:* Do not pick up assembly by logs. This could damage the unit. Always handle assembly by grate.
2. Remove control cover floor media components & remote control if supplied.
3. Remove all protective packaging applied to log set for shipment.
4. Check all items for any shipping damage. If damaged, promptly inform dealer where you bought appliance.

PRODUCT FEATURES

REMOTE READY & REMOTE CONTROLLED

This unitized gas log set is tested and approved to *ANSI Z21.60a* and *CSA 2.26a-2000* as a vented decorative appliance. This log set has a piezo ignitor. This system requires no matches, batteries or other source to light log set.

SAFETY DEVICE

This unit has a pilot with an Oxygen Depletion Sensing (ODS) safety shutoff system. The ODS/pilot shuts off the appliance if there is not enough fresh air.

PIEZO IGNITION SYSTEM

This unit has a piezo ignitor. This system requires no matches, batteries, or other sources to light appliance.

AIR FOR COMBUSTION AND VENTILATION

WARNING: This appliance shall not be installed in a confined space or unusually tight construction unless provisions are provided for adequate combustion and ventilation air. Read the following instructions to insure proper fresh air for this and other fuel-burning appliances in your home.

Today's homes are built more energy efficient than ever. New materials, increased insulation, and new construction methods help reduce heat loss in homes. Home owners weather strip and caulk around windows and doors to keep the cold air out and the warm air in. During heating months, home owners want their homes as airtight as possible.

While it is good to make your home energy efficient, your home needs to breathe. Fresh air must enter your home. All fuel-burning appliances need fresh air for proper combustion and ventilation.

Exhaust fans, fireplaces, clothes dryers, and fuel burning appliances draw air from the house to operate. You must provide adequate fresh air for these appliances. This will insure proper venting of vented fuel-burning appliances.

PROVIDING ADEQUATE VENTILATION

The following are excerpts from *National Fuel Gas Code, ANSI Z223.1/NFPA 54, Section 5.3, Air for Combustion and Ventilation*.

All spaces in homes fall into one of the three following ventilation classifications:

1. Unusually Tight Construction
2. Unconfined Space
3. Confined Space

The information on pages 4 through 6 will help you classify your space and provide adequate ventilation.

Unusually Tight Construction

The air that leaks around doors and windows may provide enough fresh air for combustion and ventilation. However, in buildings of unusually tight construction, you must provide additional fresh air.

Unusually tight construction is defined as construction where:

- a. walls and ceilings exposed to the outside atmosphere have a continuous water vapor retarder with a rating of one perm (6×10^{-11} kg per pa-sec- m^2) or less with openings gasketed or sealed and
- b. weather stripping has been added on openable windows and doors and
- c. caulking or sealants are applied to areas such as joints around window and door frames, between sole plates and floors, between wall-ceiling joints, between wall panels, at penetrations for plumbing, electrical, and gas lines, and at other openings.

If your home meets all of the three criteria above, you must provide additional fresh air. See *Ventilation Air From Outdoors*, page 5.

If your home does not meet all of the three criteria above, proceed to *Determining Fresh-Air Flow For Appliance Location*, below.

AIR FOR COMBUSTION AND VENTILATION

Continued

Confined and Unconfined Space

The *National Fuel Gas Code, ANSI Z223.1/NFPA 54* defines a confined space as a space whose volume is less than 50 cubic feet per 1,000 Btu per hour (4.8 m³ per kw) of the aggregate input rating of all appliances installed in that space and an unconfined space as a space whose volume is not less than 50 cubic feet per 1,000 Btu per hour (4.8 m³ per kw) of the aggregate input rating of all appliances installed in that space. Rooms communicating directly with the space in which the appliances are installed*, through openings not furnished with doors, are considered a part of the unconfined space.

* Adjoining rooms are communicating only if there are doorless passageways or ventilation grills between them.

DETERMINING FRESH-AIR FLOW FOR APPLIANCE LOCATION

Determining if You Have a Confined or Unconfined Space

Use this work sheet to determine if you have a confined or unconfined space.

Space: Includes the room in which you will install appliance plus any adjoining rooms with doorless passageways or ventilation grills between the rooms.

1. Determine the volume of the space (length x width x height).

Length x Width x Height = _____ cu. ft. (volume of space)

Example: Space size 20 ft. (length) x 16 ft. (width) x 8 ft. (ceiling height) = 2560 cu. ft. (volume of space)

If additional ventilation to adjoining room is supplied with grills or openings, add the volume of these rooms to the total volume of the space.

2. Multiply the space volume by 20 to determine the maximum Btu/Hr the space can support.

_____ (volume of space) x 20 = (Maximum Btu/Hr the space can support)

Example: 2560 cu. ft. (volume of space) x 20 = 51,200 (maximum Btu/Hr the space can support)

3. Add the Btu/Hr of all fuel burning appliances in the space.

Vent-free appliance	_____	Btu/Hr
Gas water appliance*	_____	Btu/Hr
Gas furnace	_____	Btu/Hr
Vented gas appliance	_____	Btu/Hr
Gas fireplace logs	_____	Btu/Hr
Other gas appliances* +	_____	Btu/Hr
Total	= _____	Btu/Hr

* Do not include direct-vent gas appliances. Direct-vent draws combustion air from the outdoors and vents to the outdoors.

Example:

Gas water appliance	_____	40,000	Btu/Hr
Vent-free appliance	+ _____	33,000	Btu/Hr
Total	= _____	73,000	Btu/Hr

4. Compare the maximum Btu/Hr the space can support with the actual amount of Btu/Hr used.

_____ Btu/Hr (maximum the space can support)

_____ Btu/Hr (actual amount of Btu/Hr used)

Example: 51,200 Btu/Hr (maximum the space can support)

73,000 Btu/Hr (actual amount of Btu/Hr used)

The space in the above example is a confined space because the actual Btu/Hr used is more than the maximum Btu/Hr the space can support. You must provide additional fresh air. Your options are as follows:

- A. Rework worksheet, adding the space of an adjoining room. If the extra space provides an unconfined space, remove door to adjoining room or add ventilation grills between rooms. See *Ventilation Air From Inside Building*, page 6.
- B. Vent room directly to the outdoors. See *Ventilation Air From Outdoors*, page 6.
- C. Install a lower Btu/Hr appliance, if lower Btu/Hr size makes room unconfined.

If the actual Btu/Hr used is less than the maximum Btu/Hr the space can support, the space is an unconfined space. You will need no additional fresh air ventilation.

⚠ WARNING: If the area in which the appliance may be operated is smaller than that defined as an unconfined space or if the building is of unusually tight construction, provide adequate combustion and ventilation air by one of the methods described in the *National Fuel Gas Code, ANSI Z223.1/NFPA 54 Section 5.3* or applicable local codes.

VENTILATION AIR

Ventilation Air From Inside Building

This fresh air would come from an adjoining unconfined space. When ventilating to an adjoining unconfined space, you must provide two permanent openings: one within 12" of the ceiling and one within 12" of the floor on the wall connecting the two spaces (see options 1 and 2, Figure 2). You can also remove door into adjoining room (see option 3, Figure 2). Follow the *National Fuel Gas Code, ANSI Z223.1/NFPA 54, Section 5.3, Air for Combustion and Ventilation* for required size of ventilation grills or ducts.

Ventilation Air From Outdoors

Provide extra fresh air by using ventilation grills or ducts. You must provide two permanent openings: one within 12" of the ceiling and one within 12" of the floor. Connect these items directly to

AIR FOR COMBUSTION AND VENTILATION

Continued

the outdoors or spaces open to the outdoors. These spaces include attics and crawl spaces. Follow the *National Fuel Gas Code, ANSI Z223.1/NFPA 54, Section 5.3, Air for Combustion and Ventilation* for required size of ventilation grills or ducts.

IMPORTANT: Do not provide openings for inlet or outlet air into attic if attic has a thermostat-controlled power vent. Heated air entering the attic will activate the power vent.

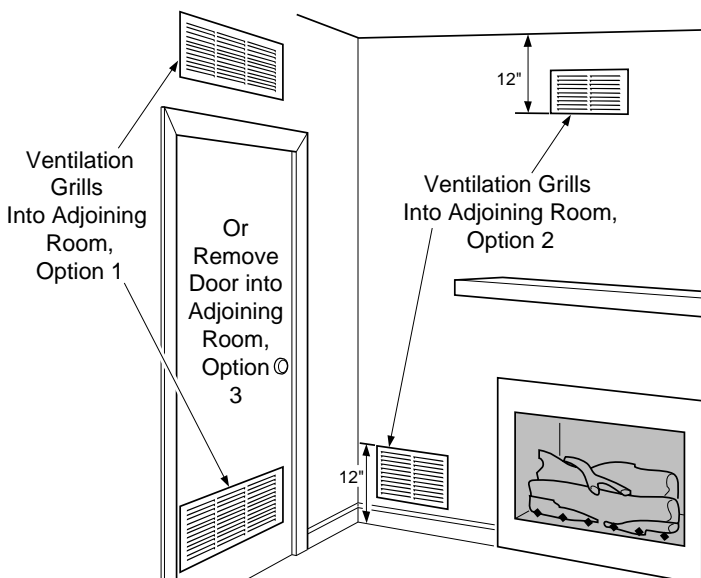

Figure 2 - Ventilation Air from Inside Building

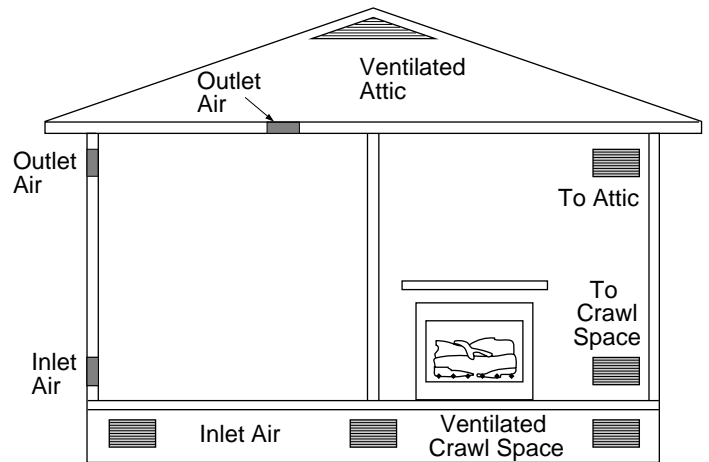

Figure 3 - Ventilation Air from Outdoors

INSTALLATION

⚠ WARNING: Before installing in a solid fuel burning fireplace, the chimney flue and firebox must be cleaned of soot, creosote, ashes and loose paint by a qualified chimney cleaner. Creosote will ignite if highly heated. A dirty chimney flue may create and distribute soot within the house. Inspect chimney flue for damage. If damaged, repair flue damper before operating appliance.

⚠ WARNING: Make sure the selector switch is in the OFF position before installing appliance .

⚠ WARNING: Before installing in a solid fuel burning fireplace, the chimney flue and firebox must be cleaned of soot, creosote, ashes and loose paint by a qualified chimney cleaner. Creosote will ignite if highly heated. A dirty chimney flue may create and distribute soot within the house. Inspect chimney flue for damage.

NOTICE: Installation, service, and repair of this appliance must be performed by a qualified installer, service agency, company or gas supplier experienced with this type of gas appliance. Only factory authorized components listed in these instructions may be used in accordance with the manufacturer's instructions and all codes and requirements of the authority having jurisdiction. Any modifications to this kit, or use of unauthorized components or accessory items will void the manufacturer's warranty, and may result in a hazardous condition.

FLUE OPENING SPECIFICATIONS

Note: This vented appliance must be installed only in a solid-fuel burning fireplace with a working flue and constructed of noncombustible material.

The charts in Figure 4 indicate technical information regarding the installation of your gas log set. Please make sure that all of the specifications shown are applicable before installation is attempted.

The fireplace must include a working flue and venting system with the minimum openings shown in the Figure 5.

SPECIFICATIONS (W.C.)			
	FUEL INLET PRESSURE		MANIFOLD PRESSURE
	Min.	Max.	
NG	7	10.5	3.5
LP	11	14	10

Figure 4 - Technical Information Charts

INSTALLATION AND CLEARANCES

Log Size	Minimum Firebox Size				Min. Flue size
	Height	Depth	Front Width	Rear* Width	
24"	17"	14"	28"	22"	8"

*Measured at 14" depth

Figure 5 - Sizes & Clearances

CHECK GAS TYPE

Use the correct gas type (natural or propane/LP) for your unit. If your gas supply is not correct, do not instal in fireplace. Call dealer where you bought the appliance for proper type of appliance.

VENTING SPECIFICATIONS FOR INSTALLATION

The fireplace chimney flue and vent must be drafting properly. To check the vent for proper drafting: Light a tightly rolled newspaper on one end and place it at the inside front edge of the fireplace. Observe the smoke and be sure the vent is properly drawing it up the chimney. If the smoke spills out into the room, extinguish the flame and remove any obstruction until proper venting is achieved.

The chimney flue damper must be fixed open to provide a minimum of 43 sq. in. of free air opening during operation of this log set. A multipurpose damper clamp is provided to fix the damper in position.

The minimum flue sizes shown in Figure 5 are based on a 6' chimney height using round pipe. Your minimum flue size will vary based on input rate and chimney height. Refer to the *National Fuel Gas Code ANSI Z223.1/NFPA 54, Section 6.6*, for details.

INSTALLING DAMPER CLAMP

Secure the damper stop clamp provided to the leading edge of the damper as shown in Figure 6. If for any reason this clamp doesn't work on your fireplace, another suitable clamp or permanent stop must be installed, or the damper blade must be cut or removed.

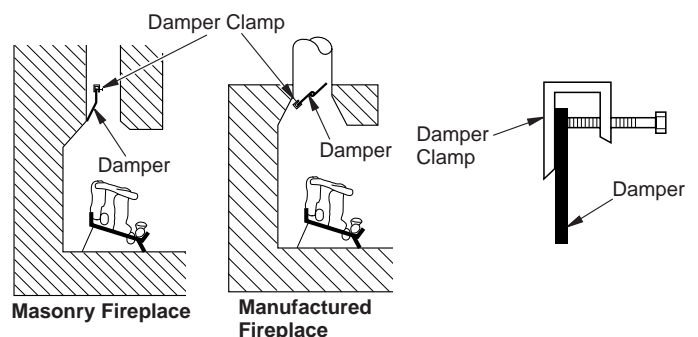

Figure 6 - Attaching Damper Clamp

INSTALLATION

Continued

INSTALLING APPLIANCE ASSEMBLY

⚠ WARNING: If installing in a sunken fireplace, special care is needed. You must raise the fireplace floor to allow access to appliance control panel. This will insure adequate air flow and guard against sooting. Raise fireplace floor with noncombustible material. Make sure material is secure.

⚠ CAUTION: Do not pick up appliance assembly by logs. This could damage unit. Only handle assembly by grates.

IMPORTANT: Make sure the appliance is level. If unit is not level, unit will not work properly.

Installation Items Needed

- control cover kit (provided with appliance)
- approved flexible gas hose and fittings (provided with appliance) (if allowed by local codes)
- sealant (resistant to propane/LP gas, not provided)

Note: Install optional Hand-Held Remote Control Kit (see *Accessories*, page 22) before installing gas log appliance (Remote-Ready Models Only). See installation instructions included with the kit.

1. Apply pipe joint sealant lightly to male threads of gas fitting (not provided). Connect approved flexible gas hose to inlet side of gas control (see Figure 7).
2. Position appliance in fireplace.
3. Connect to gas supply. See *Connecting To Gas Supply*.

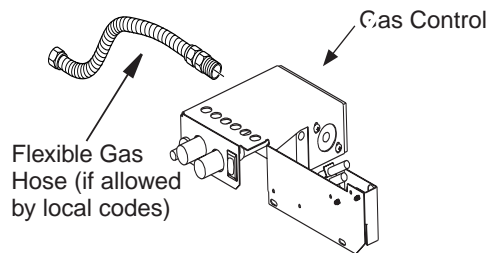

Figure 7 - Attaching Flexible Gas Hose to Gas Regulator

CONNECTING TO GAS SUPPLY

⚠ WARNING: This appliance requires a 3/8" NPT (National Pipe Thread) inlet connection to the pressure regulator.

⚠ WARNING: A qualified service person must connect appliance to gas supply. Follow all local codes.

⚠ CAUTION: Never connect propane/LP fireplace directly to the propane/LP supply. This unit requires an external regulator (not supplied). Install the external regulator between the unit and propane/LP supply.

⚠ WARNING: Never connect natural gas fireplace to private (non-utility) gas wells. This gas is commonly known as wellhead gas.

Installation Items Needed

Before installing appliance, make sure you have the items listed below.

- external regulator (supplied by installer)
- piping (check local codes)
- sealant (resistant to propane/LP gas)
- equipment shutoff valve *
- test gauge connection *
- sediment trap
- tee joint
- pipe wrench
- approved flexible gas line with gas connector (if allowed by local codes) (provided)

* A CSA design-certified equipment shutoff valve with 1/8" NPT tap is an acceptable alternative to test gauge connection. Purchase the optional CSA design-certified equipment shutoff valve from your dealer. See *Accessories*, page 22.

For propane/LP units, the installer must supply an external regulator. The external regulator will reduce incoming gas pressure. You must reduce incoming gas pressure to between 11 and 14 inches of water. If you do not reduce incoming gas pressure, regulator damage could occur. Install external regulator with the vent pointing down as shown in Figure 8 page 9. Pointing the vent down protects it from freezing rain or sleet.

⚠ CAUTION: Use only new, black iron or steel pipe. Internally-tinned copper tubing may be used in certain areas. Check your local codes. Use pipe of 1/2" diameter or greater to allow proper gas volume to appliance. If pipe is too small, undue loss of volume will occur.

INSTALLATION Continued

Installation must include an equipment shutoff valve, union, and plugged 1/8" NPT tap. Locate NPT tap within reach for test gauge hook up. NPT tap must be upstream from appliance (see Figure 9).

IMPORTANT: Install equipment shutoff valve in an accessible location. The equipment shutoff valve is for turning on or shutting off the gas to the appliance.

Apply pipe joint sealant lightly to male NPT threads. This will prevent excess sealant from going into pipe. Excess sealant in pipe could result in clogged appliance valves.

WARNING: Use pipe joint sealant that is resistant to liquid petroleum (LP) gas.

We recommend that you install a sediment trap in supply line as shown in Figure 9, depending on your model. Locate sediment trap where it is within reach for cleaning. Install in piping system between fuel supply and appliance. Locate sediment trap where trapped matter is not likely to freeze. A sediment trap traps moisture and contaminants. This keeps them from going into appliance controls. If sediment trap is not installed or is installed wrong, appliance may not run properly.

CAUTION: Avoid damage to gas control. Hold gas control with wrench when connecting it to gas piping and/or fittings.

Installation must include an equipment shutoff valve, union, and plugged 1/8" NPT tap. Locate NPT tap within reach for test gauge hook up. NPT tap must be upstream from appliance (see Figure 9).

IMPORTANT: Install equipment shutoff valve in an accessible location. The equipment shutoff valve is for turning on or shutting off the gas to the appliance.

Apply pipe joint sealant lightly to male NPT threads. This will prevent excess sealant from going into pipe. Excess sealant in pipe could result in clogged appliance valves.

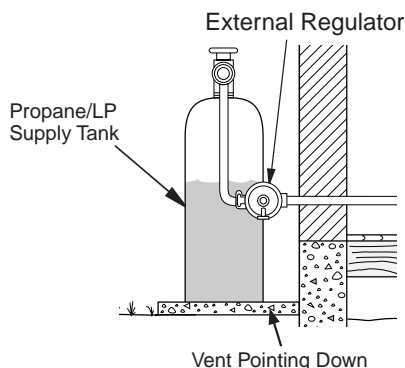

Figure 8 - External Regulator With Vent Pointing Down

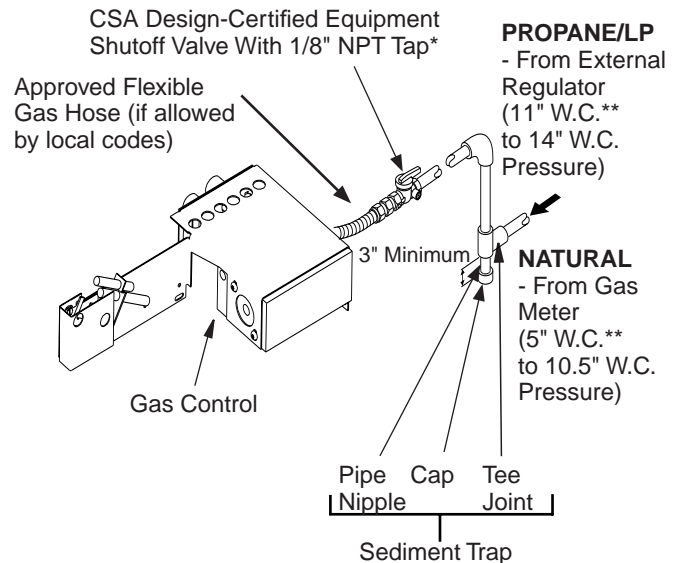

Figure 9 - Gas Connection

* Purchase the optional CSA design-certified equipment shutoff valve from your dealer. See *Accessories*, page 22.

**Minimum inlet pressure for purpose of input adjustment.

CHECKING GAS CONNECTIONS

WARNING: Test all gas piping and connections for leaks after installing or servicing. Correct all leaks at once.

WARNING: Never use an open flame to check for a leak. Apply a noncorrosive leak detection fluid to all joints. Bubbles forming show a leak. Correct all leaks at once.

CAUTION: Make sure external regulator has been installed between propane/LP supply and appliance. See guidelines under *Connecting to Gas Supply*, page 8.

Pressure Testing gas Supply Piping system

Test Pressures In Excess Of 1/2 PSIG (3.5 kPa)

1. Disconnect appliance with its appliance main gas valve (control valve) and equipment shutoff valve from gas supply piping system. Pressures in excess of 1/2 psig will damage appliance regulator.
2. Cap off open end of gas pipe where equipment shutoff valve was connected.
3. Pressurize supply piping system by either opening propane/LP supply tank valve for propane/LP gas or opening main gas valve located on or near gas meter for natural gas, or using compressed air.

INSTALLATION Continued

4. Check all joints of gas supply piping system. Apply noncorrosive leak detection fluid to all joints. Bubbles forming show a leak.
5. Correct all leaks at once.
6. Reconnect appliance and equipment shutoff valve to gas supply. Check reconnected fittings for leaks.

Test Pressures Equal To or Less Than 1/2 PSIG (3.5 kPa)

1. Close equipment shutoff valve (see Figure 10).
2. Pressurize supply piping system by either opening propane/LP supply tank valve for propane/LP gas or opening main gas valve located on or near gas meter for natural gas, or using compressed air.
3. Check all joints from gas meter to equipment shutoff valve for natural gas or propane/LP supply to equipment shutoff valve for propane/LP (see Figure 11). Apply noncorrosive leak detection fluid to all joints. Bubbles forming show a leak.
4. Correct all leaks at once.

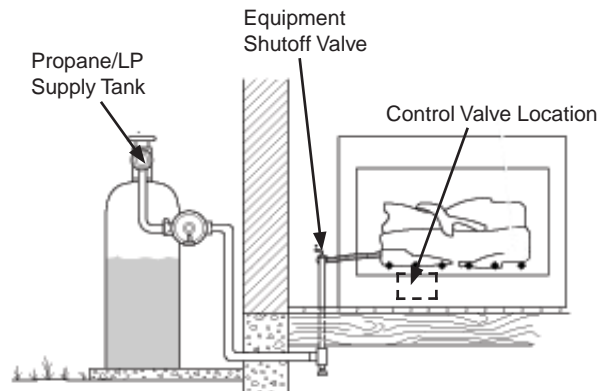

Figure 11- Checking Gas Joints (propane/LP only)

Pressure Testing Appliance Gas Connections

1. Open equipment shutoff valve (see Figure 10).
2. Open main gas valve located on or near gas meter for natural gas or open propane/LP supply tank valve.
3. Make sure control knob of appliance is in the OFF position.
4. Check all joints from equipment shutoff valve to gas control (see Figures 11 and 12). Apply noncorrosive leak detection fluid to all joints. Bubbles forming show a leak.
5. Correct all leaks at once.
6. Light appliance (see *Operating Appliance*, pages 11 through 13). Check all other internal joints for leaks.
7. Turn off appliance.

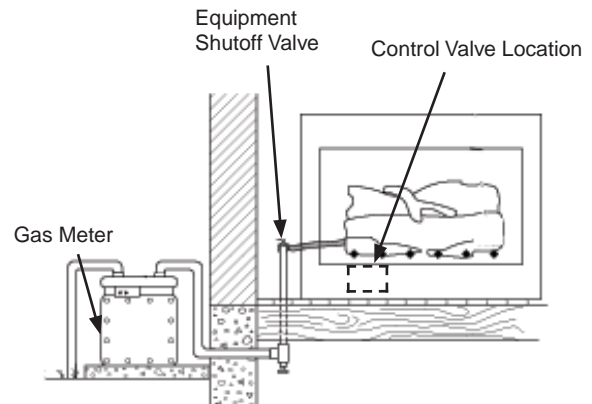

Figure 12 - Checking Gas Joints (Natural Gas Only)

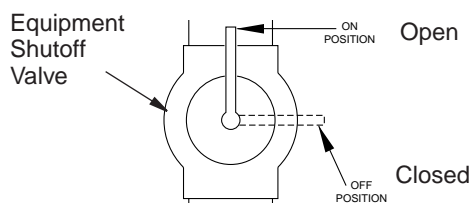

Figure 10 - Equipment Shutoff Valve

OPERATING APPLIANCE

REMOTE-READY MODELS

**FOR YOUR SAFETY READ
BEFORE LIGHTING**

WARNING: Keep flue open when operating unit.

WARNING: If you do not follow these instructions exactly, a fire or explosion may result causing property damage, personal injury or loss of life.

- A. This appliance has a pilot which must be lighted by hand. When lighting the pilot, follow these instructions exactly.
- B. **BEFORE LIGHTING** smell all around the appliance area for gas. Be sure to smell next to the floor because some gas is heavier than air and will settle on the floor.
WHAT TO DO IF YOU SMELL GAS
 - Do not try to light any appliance.
 - Do not touch any electric switch; do not use any phone in your building.
 - Immediately call your gas supplier from a neighbor's phone. Follow the gas supplier's instructions.
 - If you cannot reach your gas supplier, call the fire department.
- C. Use only your hand to push in or turn the gas control knob. Never use tools. If the knob will not push in or turn by hand, don't try to repair it, call a qualified service technician or gas supplier. Force or attempted repair may result in a fire or explosion.
- D. Do not use this appliance if any part has been under water. Immediately call a qualified service technician to inspect the appliance and to replace any part of the control system and any gas control which has been under water.

LIGHTING INSTRUCTIONS

NOTICE: During initial operation of new appliance, metallic components may emit an odor as paint and assembly compounds are heated and cure. Be sure to provide adequate fresh air if odors are detected.

WARNING: Damper handle will be hot if appliance has been running.

CAUTION: A mild gas flash may occur within 10 seconds of normal shutdown of this appliance. Remain clear of the hearth area for the entire shutdown process to avoid possible injury.

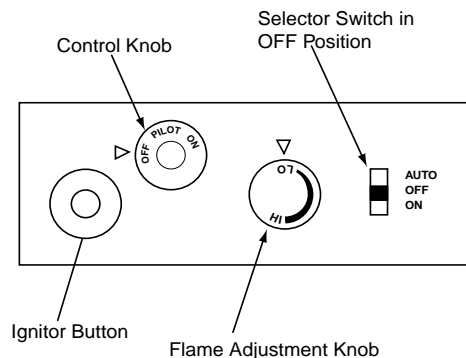

Figure 13 - Control Knob and Ignitor Button Location, Remote Ready Units.

1. **STOP!** Read the safety information, starting in column 1, of this page.
2. Make sure equipment shutoff valve is fully open.
3. Set selector switch in the OFF position.
4. Press in and turn control knob clockwise to the OFF position (see Figure 13).

WARNING: Burners will come on automatically within one minute when the selector switch is in the ON position after the pilot is lit.

5. Wait five (5) minutes to clear out any gas. Then smell for gas, including near the floor. If you smell gas, **STOP!** Follow "B" in the safety information, starting in column 1 of this page. If you don't smell gas, go to the next step.
6. Press in and turn control knob counterclockwise to the PILOT position. Press in control knob for five (5) seconds (see Figure 13).

Note: You may be running this appliance for the first time after hooking up to gas supply. If so, the control knob may need to be pressed in for 30 seconds or more. This will allow air to bleed from the gas system.

7. With control knob pressed in, press and release ignitor button. This will light pilot. The pilot is attached to the front burner. If needed, keep pressing ignitor button until pilot lights.

Note: If pilot does not stay lit, contact a qualified service person or gas supplier for repairs. Until repairs are made, light pilot with match. To light pilot with match, see *Manual Lighting Procedure*, page 12.

8. Keep control knob pressed in for 30 seconds after lighting pilot. After 30 seconds, release control knob.
 - If control knob does not pop out when released, contact a qualified service person or gas supplier for repairs.

Note: If pilot goes out, repeat steps 4 through 8.

OPERATING APPLIANCE

Continued

9. Slightly push in and turn control knob counterclockwise to the ON position.
10. Wait one minute and switch selector switch to the ON position to light burners. **Note:** AUTO is not functional.
11. Set flame adjustment knob to any level between HI and LO.

CAUTION: Do not try to adjust heating levels by using the equipment shutoff valve.

WARNING: Make sure the selector switch is in the OFF position when you are away from home for long periods of time. Appliance will come on automatically with selector switch in the ON position.

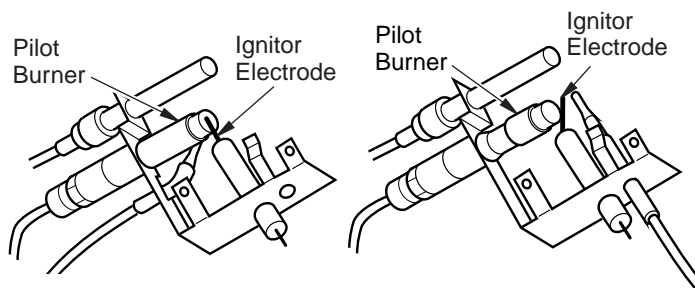

Figure 14 - Pilot (Propane/LP)

Pilot (Natural)

TO TURN OFF GAS TO APPLIANCE

Shutting Off Appliance

1. Turn control knob clockwise to the OFF position.
- 2a. Set selector switch in the OFF position.
- 2b. If Using Optional Hand-Held Remote: Set selector switch in the OFF position to prevent draining battery.

Shutting Off Burner Only (pilot stays lit)

You may shut off the burners and keep the pilot lit by doing one of the following:

1. Turn control knob clockwise to the PILOT position.
2. Use remote control manual OFF button.
3. Set selector switch in the OFF position.

MANUAL LIGHTING PROCEDURE

1. Follow steps 1 through 6 under *Lighting Instructions*.
2. Depress control knob and light pilot with match.
3. Keep control knob pressed in for 30 seconds after lighting pilot. After 30 seconds, release control knob. Now follow steps 9 through 11, *Lighting Instructions*, column 1.

REMOTE CONTROL OPERATION

Remote Control Operation

GHRC Series Operation:

1. After lighting, let pilot flame burn for about one minute. Turn control knob to ON position. Adjust flame adjustment knob anywhere between HI and LO. Slide the selector switch to the REMOTE position. **Note:** The burners may light if hand-held remote ON button was on when selector switch was last turned off. You can now turn the burners on and off with the hand-held remote control unit. **IMPORTANT:** Do not leave the selector switch in the REMOTE or ON position when the pilot is not lit. This will drain the battery.
2. Press the ON/OFF button to turn the burners on and off. When turning burners off, the pilot will remain lit.

IMPORTANT: Be sure to press the ON/OFF buttons on the hand-held remote control unit for up to 3 seconds to assure proper operation.

Note: All additional remote control accessories must be purchased separately (see *Accessories*, page 22). Follow instructions included with the remote control.

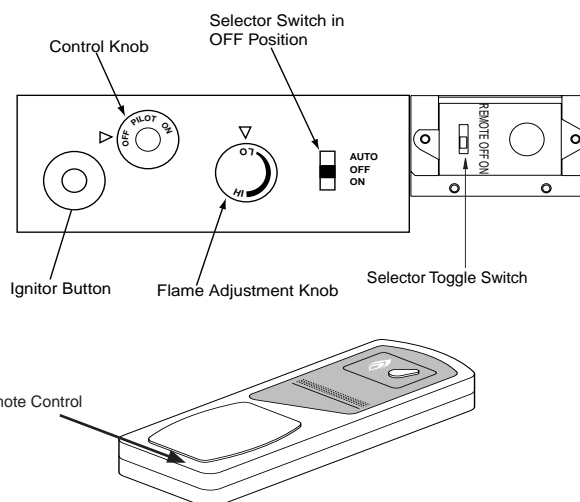

Figure 15- Setting the Selector switch, Control Knob, and Flame Adjustment Knob for Remote Operation

OPERATING APPLIANCE *Continued*

INSPECTING BURNER

Check pilot flame pattern and burner flame patterns often.

PILOT FLAME PATTERN

Figure 16 shows a correct pilot flame pattern. Figure 17 shows an incorrect pilot flame pattern. The incorrect pilot flame is not touching the thermocouple. This will cause the thermocouple to cool. When the thermocouple cools, the appliance will shut down.

If pilot flame pattern is incorrect, as shown in Figure 17

- turn appliance off (see *To Turn Off Gas to Appliance*, page 12)
- see *Troubleshooting*, pages 14 through 16

Note: The pilot flame on natural gas units will have a slight curve, but flame should be blue and have no yellow or orange color.

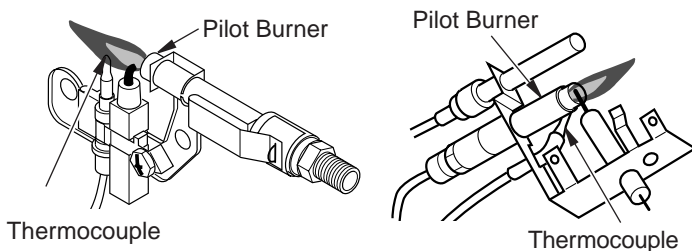

Figure 16 - Correct Pilot Flame Pattern (Your pilot may vary from pilots shown)

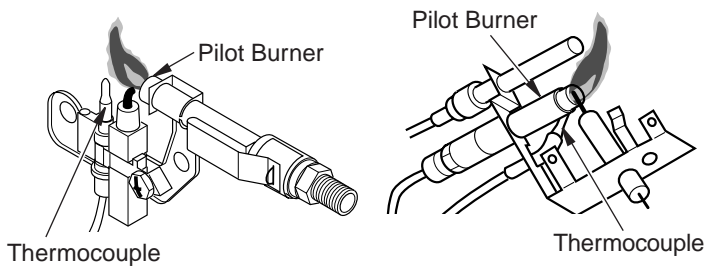

Figure 17 - Incorrect Pilot Flame Pattern (Your pilot may vary from pilots shown)

BURNER FLAME PATTERN

Figure 18 shows correct burner flame pattern.

NOTICE: Do not mistake orange flames with yellow tipping. Dirt or other fine particles are burned by appliance, causing brief patches of orange flame.

If burner flame pattern is incorrect, as shown in Figure 19

- turn appliance off (see *To Turn Off Gas to Appliance*, page 12)
- see *Troubleshooting*, pages 14 through 16

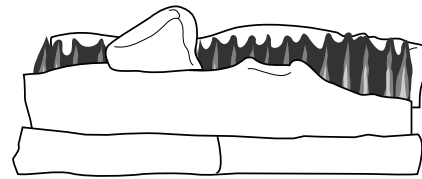

Figure 18 - Correct Burner Flame Pattern

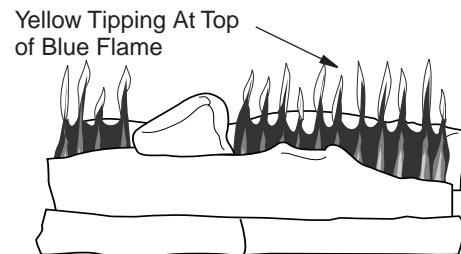

Figure 19 - Incorrect Burner Flame Pattern

CLEANING AND MAINTENANCE

- Keep the area around the log set clean and clear of debris.
- Periodically inspect the air mixer and burner tube for foreign matter blocking the air inlet and flame holes.
- Once every year a qualified agency or certified chimney sweep should examine and clean the venting system of the fireplace.

TROUBLESHOOTING

Note: For additional help, visit DESA International's technical service web site at www.desatech.com.

Note: All troubleshooting items are listed in order of operation.

⚠ WARNING: Turn off and unplug appliance and let cool before servicing. Only a qualified service person should service and repair heater.

⚠ CAUTION: Never use a wire, needle, or similar object to clean ODS/pilot. This can damage ODS/pilot unit.

OBSERVED PROBLEM	POSSIBLE CAUSE	REMEDY
When ignitor button is pressed, there is no spark at ODS/pilot	<ol style="list-style-type: none"> Ignitor electrode not connected to ignitor cable Ignitor cable pinched or wet Piezo ignitor nut is loose Broken ignitor cable Bad piezo ignitor Ignitor electrode positioned wrong or broken 	<ol style="list-style-type: none"> Reconnect ignitor cable Free ignitor cable if pinched by any metal or tubing. Keep ignitor cable dry Tighten nut holding piezo ignitor to base panel of log set. Nut is located behind base panel. Replace ignitor cable Replace piezo ignitor Replace pilot assembly for remote-ready units; Replace ignitor electrode for variable manually controlled units
When ignitor button is pressed, there is spark at ODS/pilot but no ignition	<ol style="list-style-type: none"> Gas supply turned off or equipment shutoff valve closed Control knob not in PILOT position Control knob not pressed in while in PILOT position Air in gas lines when installed Depleted gas supply (propane/LP only) ODS/pilot is clogged Gas regulator setting is not correct 	<ol style="list-style-type: none"> Turn on gas supply or open equipment shutoff valve Turn control knob to PILOT position Press in control knob while in PILOT position Continue holding down control knob. Repeat igniting operation until air is removed Contact local propane/LP gas company Clean ODS/pilot (see <i>Cleaning and Maintenance</i>, page 13) or replace ODS/pilot assembly Replace gas regulator
ODS/pilot lights but flame goes out when control knob is released	<ol style="list-style-type: none"> Control knob not fully pressed in Control knob not pressed in long enough Safety interlock system has been triggered Equipment shutoff valve not fully open Pilot flame not touching thermocouple, which allows thermocouple to cool, causing pilot flame to go out. This problem could be caused by one or both of the following: <ol style="list-style-type: none"> Low gas pressure Dirty or partially clogged ODS/pilot Thermocouple connection loose at control valve 	<ol style="list-style-type: none"> Press in control knob fully After ODS/pilot lights, keep control knob pressed in 30 seconds Wait one minute for safety interlock system to reset. Repeat ignition operation Fully open equipment shutoff valve A) Contact local natural or propane/LP gas company <ol style="list-style-type: none"> Clean ODS/pilot (see <i>Cleaning and Maintenance</i>, page 13) or replace ODS/pilot assembly Hand tighten until snug, then tighten 1/4 turn more Replace pilot assembly Replace control valve

TROUBLESHOOTING

Continued

OBSERVED PROBLEM	POSSIBLE CAUSE	REMEDY
One or both burner does not light after ODS/pilot is lit	<ol style="list-style-type: none"> 1. Inlet gas pressure is too low 2. Burner orifice(s) clogged 3. Mislocated crossover tube 4. Burner orifice(s) diameter is too small 5. Remote selector in OFF position (Remote-Ready Models Only) 6. Wire disconnected from gas control (Remote-Ready Models Only) 	<ol style="list-style-type: none"> 1. Contact local natural or propane/LP gas company 2. Clean burner(s) (see <i>Cleaning and Maintenance</i>, page 13) or replace burner orifice(s) 3. Contact qualified service person 4. Replace burner orifice(s) 5. Put remote selector in ON position 6. See <i>Wiring Diagram</i>, page 18
Delayed ignition of burner	<ol style="list-style-type: none"> 1. Manifold pressure is too low 2. Burner orifice(s) clogged 3. Mislocated crossover tube 	<ol style="list-style-type: none"> 1. Contact local natural or propane/LP gas company 2. Clean burner(s) (see <i>Cleaning and Maintenance</i>, page 13) or replace burner orifice(s) 3. Contact qualified service person
Burner backfiring during combustion	<ol style="list-style-type: none"> 1. Burner orifice is clogged or damaged 2. Damaged burner 3. Gas regulator defective 	<ol style="list-style-type: none"> 1. Clean burner (see <i>Cleaning and Maintenance</i>, page 13) or replace burner orifice 2. Replace damaged burner 3. Replace gas regulator
Orange flame in burner during burner combustion	<ol style="list-style-type: none"> 1. Not enough air 2. Gas regulator defective 	<ol style="list-style-type: none"> 1. Check burner(s) for dirt and debris. If found, clean burner(s) (see <i>Cleaning and Maintenance</i>, page 13) 2. Replace gas regulator
Slight smoke or odor during initial operation	<ol style="list-style-type: none"> 1. Residues from manufacturing processes and logs curing 	<ol style="list-style-type: none"> 1. Problem will stop after a few hours of operation
Appliance produces a whistling noise when burners are lit	<ol style="list-style-type: none"> 1. Turning control knob to HI position when burners are cold 2. Air in gas line 3. Air passageways on appliance blocked 4. Dirty or partially clogged burner orifice(s) 	<ol style="list-style-type: none"> 1. Turn control knob to LO position and let warm up for a minute 2. Operate burners until air is removed from line. Have gas line checked by local natural or propane/LP gas company 3. Observe minimum installation clearances (see pages 7 through 8) 4. Clean burners (see <i>Cleaning and Maintenance</i>, page 13) or replace burner orifice(s)
White powder residue forming within burner box or on adjacent walls or furniture	<ol style="list-style-type: none"> 1. When heated, vapors from furniture polish, wax, carpet cleaners, etc. turn into white powder residue 	<ol style="list-style-type: none"> 1. Turn appliance off when using furniture polish, wax, carpet cleaners, or similar products
Moisture/condensation noticed on windows	<ol style="list-style-type: none"> 1. Not enough combustion/ventilation air 	<ol style="list-style-type: none"> 1. Refer to Air for <i>Combustion and Ventilation</i> requirements (page 4)

TROUBLESHOOTING

Continued



WARNING: If you smell gas

- Shut off gas supply.
- Do not try to light any appliance.
- Do not touch any electrical switch; do not use any phone in your building.
- Immediately call your gas supplier from a neighbor's phone. Follow the gas supplier's instructions.
- If you cannot reach your gas supplier, call the fire department.

IMPORTANT: Operating appliance where impurities in air exist may create odors. Cleaning supplies, paint, paint remover, cigarette smoke, cements and glues, new carpet or textiles, etc., create fumes. These fumes may mix with combustion air and create odors. These odors will disappear over time.

OBSERVED PROBLEM	POSSIBLE CAUSE	REMEDY
Remote does not function (Remote-Ready Models Only)	1. Battery is not installed. Battery power is low	1. Replace 9-volt batteries in receiver and remote control
Appliance produces a clicking/ticking noise just after burners are lit or shut off	1. Metal expanding while heating or contracting while cooling	1. This is common with most appliances. If noise is excessive, contact qualified service person
Appliance produces unwanted odors	1. Appliance burning vapors from paint, hair spray, glues, cleaners, chemicals, new carpet, etc. (See <i>IMPORTANT</i> statement above) 2. Low fuel supply (propane/LP only) 3. Gas leak. See Warning statement at top of page	1. Open window to ventilate room. Stop using odor causing products while appliance is running 2. Refill supply tank (propane/LP only) 3. Locate and correct all leaks (see <i>Checking Gas Connections</i> , page 9)
Appliance shuts off in use (ODS operates)	1. Not enough fresh air is available 2. Low line pressure 3. ODS/pilot is partially clogged	1. Open window and/or door for ventilation 2. Contact local natural or propane/LP gas company 3. Clean ODS/pilot (see <i>Cleaning and Maintenance</i> , page 13)
Gas odor even when control knob is in OFF position	1. Gas leak. See Warning statement at top of page 2. Control valve or gas control defective	1. Locate and correct all leaks (see <i>Checking Gas Connections</i> , page 9) 2. Replace control valve or gas control
Gas odor during combustion	1. Foreign matter between control valve and burner 2. Gas leak. See Warning statement at top of page	1. Take apart gas tubing and remove foreign matter 2. Locate and correct all leaks (see <i>Checking Gas Connections</i> , page 9)

SPECIFICATIONS

	VTD-18N-PDG/VTD-18N-BTB	VTD-24N-PDG/VTD-24N-BTB
Btu (Variable)	37,000/54,000	41,000/58,000
Type Gas	Natural Gas Only	Natural Gas Only
Ignition	Piezo	Piezo
Manifold Pressure	3.5" W.C.	3.5" W.C.
Inlet Gas Pressure (in. of water)		
Maximum	10.5" W.C.	10.5" W.C.
Minimum*	5.0" W.C.	5.0" W.C.
Shipping Weight	32 lbs.	34 lbs.

* For purpose of input adjustment

	VTD-18P-PDG/VTD-18P-BTB	VTD-24P-PDG/VTD-24P-BTB
Btu (Variable)	30,000/46,000	41,000/58,000
Type Gas	Propane/LP Only	Propane/LP Only
Ignition	Piezo	Piezo
Manifold Pressure	10" W.C.	10" W.C.
Inlet Gas Pressure (in. of water)		
Maximum	14" W.C.	14" W.C.
Minimum*	11" W.C.	11" W.C.
Shipping Weight	32 lbs.	34 lbs.

* For purpose of input adjustment

WIRING DIAGRAM (Remote-Ready Models Only)

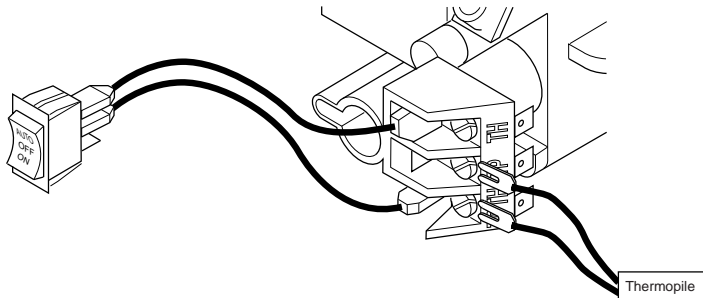

SERVICE HINTS

When Gas Pressure Is Too Low

- pilot will not stay lit
- burners will have delayed ignition
- propane/LP gas supply may be low

You may feel your gas pressure is too low. If so, contact your local propane/LP or natural gas supplier.

TECHNICAL SERVICE

You may have further questions about installation, operation, or troubleshooting. If so, contact DESA International's Technical Service Department at 1-866-672-6040. When calling please have your model and serial numbers of your appliance ready.

You can also visit DESA International's technical services web site at www.desatech.com.

REPLACEMENT PARTS

Note: Use only original replacement parts. This will protect your warranty coverage for parts replaced under warranty.

PARTS UNDER WARRANTY

Contact authorized dealers of this product. If they can't supply original replacement part(s), call DESA International's Technical Service Department at 1-866-672-6040.

When calling DESA International, have ready

- your name
- your address
- model and serial numbers of your appliance
- how appliance was malfunctioning
- type of gas used (propane/LP or natural gas)
- purchase date

Usually, we will ask you to return the part to the factory.

PARTS NOT UNDER WARRANTY

Contact authorized dealers of this product. If they can't supply original replacement part(s), call DESA International at 1-866-672-6040 for referral information.

When calling DESA International, have ready

- model number of your appliance
- the replacement part number

THIS PAGE INTENTIONALLY LEFT BLANK

ILLUSTRATED PARTS BREAKDOWN

REMOTE-READY MODELS AND REMOTE CONTROLLED MODELS

- VTD-24N-PDG VTD-24N-BTB
- VTD-24P-PDG VTD-24P-BTB
- VTD-18N-PDG VTD-18N-BTB
- VTD-18P-PDG VTD-18P-BTB

ITEM #5 (AIR SHUTTER) INSTALLATION NOTES:
 FOR NG---FULLY CLOSED
 FOR LP---FULLY OPEN

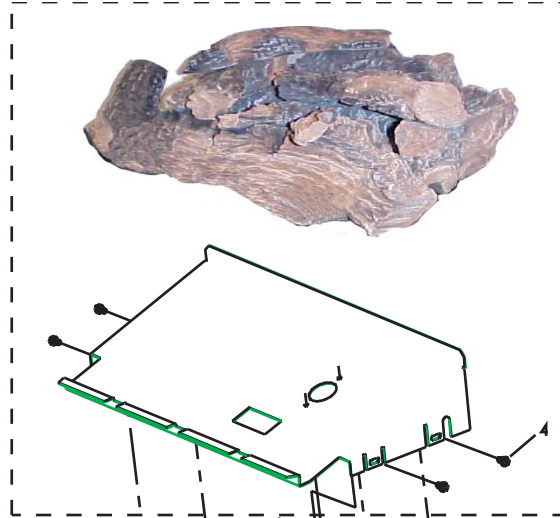

3
 Log sets and mounting plates are ordered as an assembly

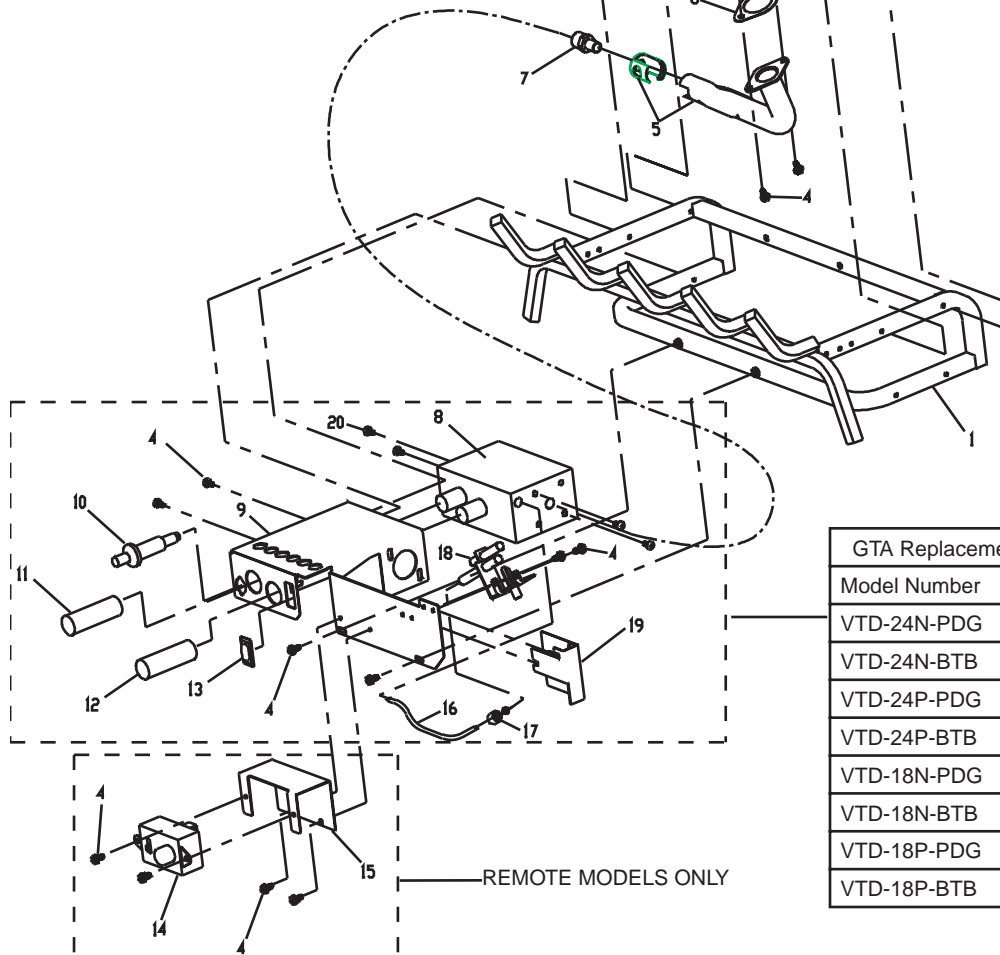

GTA Replacement Part Numbers	
Model Number	GTA Part number
VTD-24N-PDG	111794 01
VTD-24N-BTB	
VTD-24P-PDG	111794 05
VTD-24P-BTB	
VTD-18N-PDG	111794 03
VTD-18N-BTB	
VTD-18P-PDG	111794 04
VTD-18P-BTB	

PARTS LIST

This list contains replaceable parts used in your appliance. When ordering parts, follow the instructions listed under *Replacement Parts* on page 18 of this manual.

	PART NUMBER FOR								DESCRIPTION	QTY
	VTD-18N-PDG	VTD-18P-PDG	VTD-18N-BTB	VTD-18P-BTB	VTD-24N-PDG	VTD-24P-PDG	VTD-24N-BTB	VTD-24P-BTB		
1	111808-01	111808-01	111808-01	111808-01	11793-01	111793-01	111793-01	111793-01	GRATE ASSEMBLY	1
2	see table page 20	see table page 20	see table page 20	see table page 20	see table page 20	see table page 20	see table page 20	see table page 20	GTA (Gas Train Assembly)	1
3	112789-01	112789-01	112790-01	112790-01	112359-01	112359-01	112360-01	112360-01	LOG ASSEMBLY	1
4	111800-01	111800-01	111800-01	111800-01	111800-01	111800-01	111800-01	111800-01	SCREW	10-PDG/ 14-BTB
5	111372-02	111372-02	111372-02	111372-02	111372-01	111372-01	111372-01	111372-01	VENTURI/SHUTTER ASSY.	1
6	112370-01	112370-01	112370-01	112370-01	112370-01	112370-01	112370-01	112370-01	GASKET	1
7	112371-03	112371-04	112371-03	112371-04	112371-01	112371-02	112371-01	112371-02	ORIFICE	1
8	111807-01	111807-02	111807-01	111807-02	111807-01	111807-02	111807-01	111807-02	VALVE	1
9	111796-01	111796-01	111796-01	111796-01	111796-01	111796-01	111796-01	111796-01	BRACKET-VALVE	1
10	097159-04	097159-04	097159-04	097159-04	097159-04	097159-04	097159-04	097159-04	PIEZO IGNITOR	1
11	103784-01	103784-01	103784-01	103784-01	103784-01	103784-01	103784-01	103784-01	CONTROL KNOB EXT.	1
12	103784-02	103784-02	103784-02	103784-02	103784-02	103784-02	103784-02	103784-02	CONTROL KNOB EXT.	1
13	099998-01	099998-01	099998-01	099998-01	099998-01	099998-01	099998-01	099998-01	SWITCH	1
14	—	—	112806-01	112806-01	—	—	112806-01	112806-01	REMOTE CONTROL ASSY.	1
15	—	—	112806-02	112806-02	—	—	112806-02	112806-02	BRACKET-RECIEVER	1
16	111817-02	111817-02	111817-02	111817-02	111817-02	111817-02	111817-02	111817-02	FLEXTUBE 3/16	1
17	111828-01	111828-01	111828-01	111828-01	111828-01	111828-01	111828-01	111828-01	COMPRESSION NUT/ SLEEVE	1
18	112376-01	103778-01	112376-01	103778-01	112376-01	103778-01	112376-01	103778-01	PILOT	1
19	111796-02	111796-02	111796-02	111796-02	111796-02	111796-02	111796-02	111796-02	SHIELD-PILOT	1
20	111816-01	111816-01	111816-01	111816-01	111816-01	111816-01	111816-01	111816-01	SCREW	4
PARTS AVAILABLE NOT SHOWN										
	100563-01	100563-01	100563-01	100563-01	00563-01	100563-01	100563-01	100563-01	WARNING PLATE	1
	103877-01	103877-01	103877-01	103877-01	103877-01	103877-01	103877-01	103877-01	LIGHTING INSTRUCTION	1
	100639-01	100639-01	100639-01	100639-01	100639-01	100639-01	100639-01	100639-01	CAUTION DECAL	1
	GA6060	GA6060	GA6060	GA6060	GA6060	GA6060	GA6060	GA6060	LAVA ROCK	1
	111288-02	111288-02	111288-02	111288-02	111288-02	111288-02	111288-02	111288-02	GAS LINE FLEX 18	1
	—	—	111836-01	111836-01	—	—	111836-01	111836-01	BATTERY	2
	112363-01	112363-01	112363-01	112363-01	112363-01	112363-01	112363-01	112363-01	LOG SCRAP KIT#1	1
	112364-01	112364-01	112364-01	112364-01	112364-01	112364-01	112364-01	112364-01	LOG SCRAP KIT#2	1

ACCESSORIES

Purchase these appliance accessories from your local dealer. If they can not supply these accessories, call DESA International at 1-866-672-6040 for referral information. You can also write to the address listed on the back page of this manual.

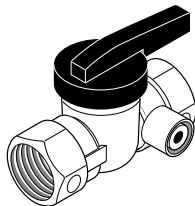

EQUIPMENT SHUTOFF VALVE - GA5010

For all models. Equipment shutoff valve with 1/8" NPT tap. Fits 1/2" NPT pipe.

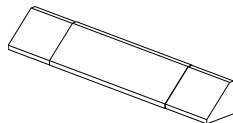

FIREPLACE HOOD

Black - GA6050

Brass - GA6052

Antique Brass - GA6053

For all models. Helps deflect heat away from mantel or wall above fireplace. Fits openings 28" to 48" wide.

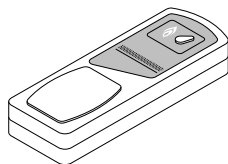

RECEIVER AND HAND-HELD REMOTE CONTROL KIT - GHRC

For all Remote-Ready Models. Allows the gas log appliance to be turned on and off by using a hand-held remote control.

For all models.

DAMPER CLAMP - GA6080

(Not Shown)

For Remote-Ready and Variable Manually-Controlled Models. Permanently opens chimney flue damper for vented operation.

LAVA ROCK - GA6060

(Not Shown)

For all models. Order when additional rock is desired. (1.8 lb. bag)

CLEANING KIT - GCK (Not Shown)

For all models. Your vented gas appliance requires regular cleaning and maintenance to prevent performance problems. This kit gives you the tools and instructions to make it easy to clean all critical areas of your appliance.

INFORMATION VIDEO - 108917-01

For all models. A care and maintenance video is available by calling 1-866-672-6040.

OWNER'S REGISTRATION FORM

In order to provide better customer service for this and future purchases, we recommend that you register your product with us. You can register online at www.desatech.com. If access to our website is not available to you, please complete this Owner's Registration Form and mail to the address on the back of this owner's manual. Please provide the following product information:

Brand: _____ (Comfort Glow, Vanguard, etc.)
Model: _____ (EFP33PR, VTGH33NR, etc.)
Date Purchased: _____ Note: Keep receipt for warranty verification.
Serial Number: _____ 7 or 9 digit number located on product or identification tag.
First Name: _____ Last Name: _____
Address: _____
City: _____ State: _____ Zip: _____ Country: _____
Home Phone: _____ () - _____
E-Mail: _____

Please answer the following questions to register your product with DESA:

- Where will the product be used?
 Living/Family Room Office/Warehouse Utility Shed/Outbuilding Garage Bedroom Bathroom Other
- If you bought this product yourself, did you plan to purchase this type of product before going into the store? Yes No
- Who selected the product? Male Female Both
- What is the population of your area? Under 10,000 10,000 to 25,000 25,000 to 50,000 50,000 to 100,000
 100,000 to 250,000 Over 250,000
- What is your primary source of heat? Propane (LP Gas) Fuel Oil Wood Natural Gas Electric Other
- How was the product installed? Professional Installer Self Other
- Cost of product excluding sales tax? \$ _____
- Cost to install product? \$ _____
- Type of store where product was purchased? Hardware Propane Dealer Natural Gas/Utility Co. Home Center/Builder's Supply
 Fireplace or Hearth Shop Farm Store Other
- What motivated you to buy this product? Sudden Cold Weather Replace Older Model D.I.Y. Home Project
 Emergency Back-Up Heat Heater was on Sale Energy Savings/High Efficiency Construction Project Other
- How did you learn about this product brand? Advertising Relative or Friend Store Display Other _____
- Level of Education of Purchaser: Some High School Completed High School Completed College Completed Graduate School
- Age of Purchaser: Under 20 20 - 29 30 - 39 40 - 49 50 - 59 60 or Over
- Buyer's total annual household income: Under \$15,000 \$15,000 to \$19,999 \$20,000 to \$34,999 \$35,000 to \$49,999
 \$50,000 to \$74,999 \$75,000 to \$99,999 \$100,000 and Over
- Store where product was purchased:
Name: _____
City: _____ State: _____

16. In choosing this product, how important were the following:

	Not Important	Somewhat Important	Very Important
Availability	<input type="radio"/>	<input type="radio"/>	<input type="radio"/>
Price	<input type="radio"/>	<input type="radio"/>	<input type="radio"/>
Brand Name	<input type="radio"/>	<input type="radio"/>	<input type="radio"/>
Overall Quality	<input type="radio"/>	<input type="radio"/>	<input type="radio"/>
Heat Output	<input type="radio"/>	<input type="radio"/>	<input type="radio"/>
Made in USA	<input type="radio"/>	<input type="radio"/>	<input type="radio"/>
Warranty	<input type="radio"/>	<input type="radio"/>	<input type="radio"/>
Local Service	<input type="radio"/>	<input type="radio"/>	<input type="radio"/>
Value for Price	<input type="radio"/>	<input type="radio"/>	<input type="radio"/>
Prior Brand Experience	<input type="radio"/>	<input type="radio"/>	<input type="radio"/>
Controls Location	<input type="radio"/>	<input type="radio"/>	<input type="radio"/>
Thermostat, Remote, or Manual Operation	<input type="radio"/>	<input type="radio"/>	<input type="radio"/>
Ease of Operation	<input type="radio"/>	<input type="radio"/>	<input type="radio"/>
Special Features	<input type="radio"/>	<input type="radio"/>	<input type="radio"/>
Salesperson's Recommendation	<input type="radio"/>	<input type="radio"/>	<input type="radio"/>
Friend/Relative's Recommendation	<input type="radio"/>	<input type="radio"/>	<input type="radio"/>
Portability	<input type="radio"/>	<input type="radio"/>	<input type="radio"/>
Quiet Operation	<input type="radio"/>	<input type="radio"/>	<input type="radio"/>

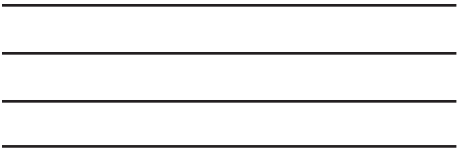

Postage
Required



2701 S. Harbor Blvd.
Santa Ana, CA. 92704
www.desatech.com

WARRANTY INFORMATION

KEEP THIS WARRANTY

Model _____
Serial No. _____
Date Purchased _____

Always specify model and serial numbers when communicating with the factory.

We reserve the right to amend these specifications at any time without notice. The only warranty applicable is our standard written warranty. We make no other warranty, expressed or implied.

LIMITED WARRANTY VENT-FREE GAS LOG APPLIANCES

DESA International warrants this product to be free from defects in materials and components for four (4) years and five (5) years on stainless steel burners from the date of first purchase, provided that the product has been properly installed, operated and maintained in accordance with all applicable instructions. To make a claim under this warranty the Bill of Sale or cancelled check must be presented.

This warranty is extended only to the original retail purchaser. This warranty covers the cost of part(s) required to restore this appliance to proper operating condition and an allowance for labor when provided by a DESA Authorized Service Center. Warranty part(s) MUST be obtained through authorized dealers of this product and/or DESA International who will provide original factory replacement parts. Failure to use original factory replacement parts voids this warranty. The appliance MUST be installed by a qualified installer in accordance with all local codes and instructions furnished with the unit.

This warranty does not apply to parts that are not in original condition because of normal wear and tear, or parts that fail or become damaged as a result of misuse, accidents, lack of proper maintenance or defects caused by improper installation. Travel, diagnostic cost, labor, transportation and any and all such other costs related to repairing a defective appliance will be the responsibility of the owner.

TO THE FULL EXTENT ALLOWED BY THE LAW OF THE JURISDICTION THAT GOVERNS THE SALE OF THE PRODUCT; THIS EXPRESS WARRANTY EXCLUDES ANY AND ALL OTHER EXPRESSED WARRANTIES AND LIMITS THE DURATION OF ANY AND ALL IMPLIED WARRANTIES, INCLUDING WARRANTIES OF MERCHANTABILITY AND FITNESS FOR A PARTICULAR PURPOSE TO FOUR (4) YEARS ON ALL COMPONENTS AND FIVE (5) YEARS ON STAINLESS STEEL BURNERS FROM THE DATE OF FIRST PURCHASE; AND DESA INTERNATIONAL'S LIABILITY IS HEREBY LIMITED TO THE PURCHASE PRICE OF THE PRODUCT AND DESA INTERNATIONAL SHALL NOT BE LIABLE FOR ANY OTHER DAMAGES WHATSOEVER INCLUDING INDIRECT, INCIDENTAL OR CONSEQUENTIAL DAMAGES.

Some states do not allow a limitation on how long an implied warranty lasts or an exclusion or limitation of incidental or consequential damages, so the above limitation on implied warranties, or exclusion or limitation on damages may not apply to you.

This warranty gives you specific legal rights, and you may also have other rights that vary from state to state.

For information about this warranty write:



2701 S. Harbor Blvd.
Santa Ana, CA. 92704
www.desatech.com



111826-02

NOT A UPC

111826-02
Rev. F
10/04

For more information, visit www.desatech.com

Free Manuals Download Website

<http://myh66.com>

<http://usermanuals.us>

<http://www.somanuals.com>

<http://www.4manuals.cc>

<http://www.manual-lib.com>

<http://www.404manual.com>

<http://www.luxmanual.com>

<http://aubethermostatmanual.com>

Golf course search by state

<http://golfingnear.com>

Email search by domain

<http://emailbydomain.com>

Auto manuals search

<http://auto.somanuals.com>

TV manuals search

<http://tv.somanuals.com>