

DENON

DVD AUDIO-VIDEO/SUPER AUDIO CD PLAYER

DVD-2910/955

OPERATING INSTRUCTIONS

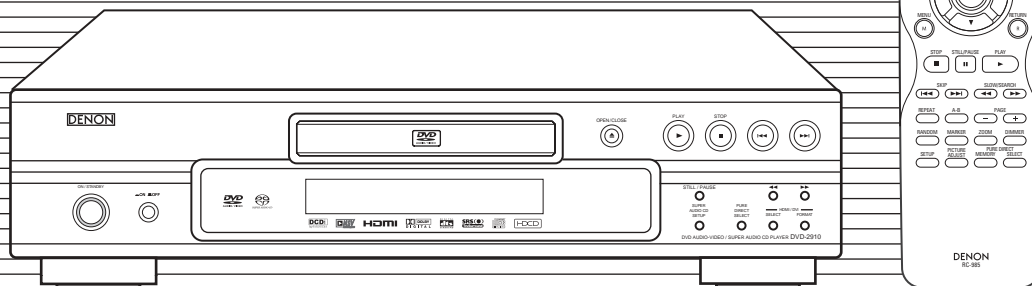

IMPORTANT TO SAFETY

WARNING:

TO PREVENT FIRE OR SHOCK HAZARD, DO NOT EXPOSE THIS APPLIANCE TO RAIN OR MOISTURE.

CAUTION:

1. Handle the power supply cord carefully

Do not damage or deform the power supply cord. If it is damaged or deformed, it may cause electric shock or malfunction when used. When removing from wall outlet, be sure to remove by holding the plug attachment and not by pulling the cord.

2. Do not open the top cover

In order to prevent electric shock, do not open the top cover. If problems occur, contact your DENON DEALER.

3. Do not place anything inside

Do not place metal objects or spill liquid inside the DVD audio-video/Super audio CD player. Electric shock or malfunction may result.

Please, record and retain the Model name and serial number of your set shown on the rating label.

Model No. DVD-2910/955 Serial No. _____



CAUTION
RISK OF ELECTRIC SHOCK
DO NOT OPEN



CAUTION:

TO REDUCE THE RISK OF ELECTRIC SHOCK, DO NOT REMOVE COVER (OR BACK). NO USER SERVICEABLE PARTS INSIDE. REFER SERVICING TO QUALIFIED SERVICE PERSONNEL.



The lightning flash with arrowhead symbol, within an equilateral triangle, is intended to alert the user to the presence of uninsulated "dangerous voltage" within the product's enclosure that may be of sufficient magnitude to constitute a risk of electric shock to persons.



The exclamation point within an equilateral triangle is intended to alert the user to the presence of important operating and maintenance (servicing) instructions in the literature accompanying the appliance.

NOTE:

This DVD audio-video/Super audio CD player uses the semiconductor laser. To allow you to enjoy music at a stable operation, it is recommended to use this in a room of 5 °C (41 °F) – 35 °C (95 °F).

CAUTION:

USE OF CONTROLS OR ADJUSTMENTS OR REFORMANCE OF PROCEDURES OTHER THAN THOSE SPECIFIED HEREIN MAY RESULT IN HAZARDOUS RADIATION EXPOSURE.

THE COMPACT DISC PLAYER SHOULD NOT BE ADJUSTED OR REPAIRED BY ANYONE EXCEPT PROPERLY QUALIFIED SERVICE PERSONNEL.

FCC INFORMATION (For US customers)

1. PRODUCT

This product complies with Part 15 of the FCC Rules. Operation is subject to the following two conditions: (1) this product may not cause harmful interference, and (2) this product must accept any interference received, including interference that may cause undesired operation.

2. IMPORTANT NOTICE: DO NOT MODIFY THIS PRODUCT

This product, when installed as indicated in the instructions contained in this manual, meets FCC requirements. Modification not expressly approved by DENON may void your authority, granted by the FCC, to use the product.

3. NOTE

This product has been tested and found to comply with the limits for a Class B digital device, pursuant to Part 15 of the FCC Rules. These limits are designed to provide reasonable protection against harmful interference in a residential installation.

This product generates, uses and can radiate radio frequency energy and, if not installed and used in accordance with the instructions, may cause harmful interference to radio communications. However, there is no guarantee that interference will not occur in a particular installation. If this product does cause harmful interference to radio or television reception, which can be determined by turning the product OFF and ON, the user is encouraged to try to correct the interference by one or more of the following measures:

- Reorient or relocate the receiving antenna.
- Increase the separation between the equipment and receiver.
- Connect the product into an outlet on a circuit different from that to which the receiver is connected.
- Consult the local retailer authorized to distribute this type of product or an experienced radio/TV technician for help.

• FOR CANADA MODEL ONLY

CAUTION

TO PREVENT ELECTRIC SHOCK, MATCH WIDE BLADE OF PLUG TO WIDE SLOT, FULLY INSERT.

• POUR LES MODELE CANADIENS UNIQUEMENT

ATTENTION

POUR ÉVITER LES CHOCS ÉLECTRIQUES, INTERODUIRE LA LAME LA PLUS LARGE DE LA FICHE DANS LA BORNE CORRESPONDANTE DE LA PRISE ET POUSSER JUSQU' AU FOND.

**FRONT PANEL
PANNEAU AVANT
PANEL FRONTAL**

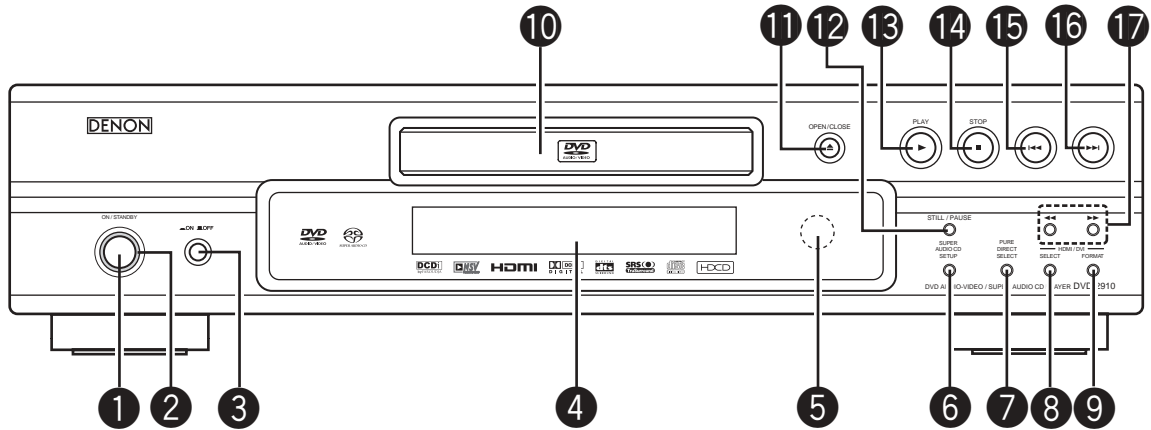

**REAR PANEL
PANNEAU ARRIERE
PANEL TRASERO**

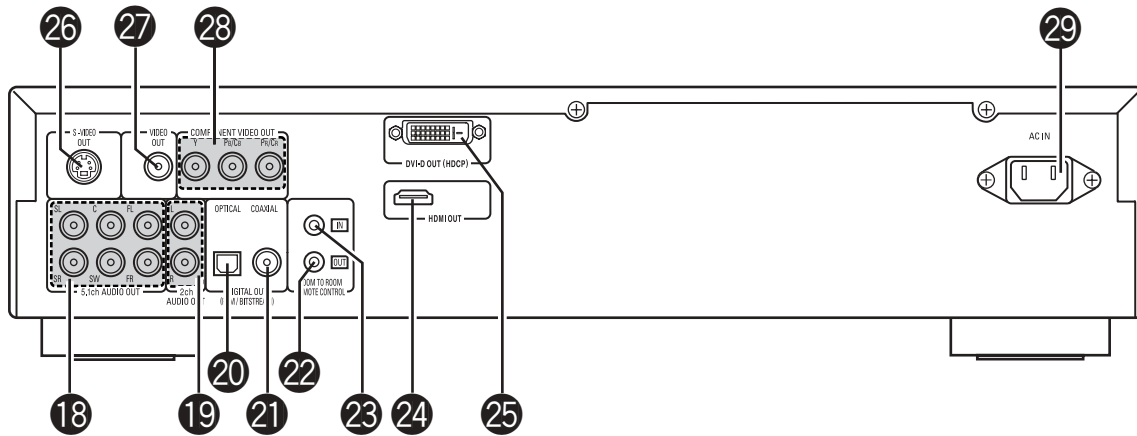

SAFETY INSTRUCTIONS





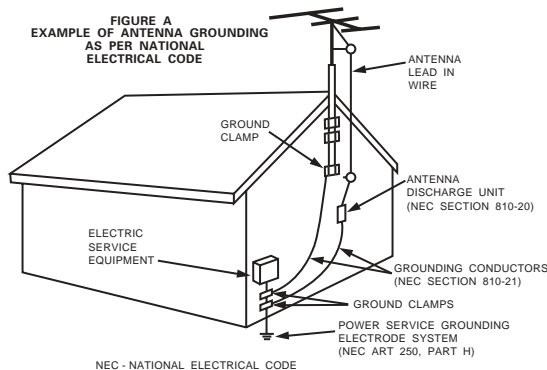

1. Read Instructions – All the safety and operating instructions should be read before the product is operated.
2. Retain Instructions – The safety and operating instructions should be retained for future reference.
3. Heed Warnings – All warnings on the product and in the operating instructions should be adhered to.
4. Follow Instructions – All operating and use instructions should be followed.
5. Cleaning – Unplug this product from the wall outlet before cleaning. Do not use liquid cleaners or aerosol cleaners.
6. Attachments – Do not use attachments not recommended by the product manufacturer as they may cause hazards.
7. Water and Moisture – Do not use this product near water – for example, near a bath tub, wash bowl, kitchen sink, or laundry tub; in a wet basement; or near a swimming pool; and the like.
8. Accessories – Do not place this product on an unstable cart, stand, tripod, bracket, or table. The product may fall, causing serious injury to a child or adult, and serious damage to the product. Use only with a cart, stand, tripod, bracket, or table recommended by the manufacturer, or sold with the product. Any mounting of the product should follow the manufacturer's instructions, and should use a mounting accessory recommended by the manufacturer.
9. A product and cart combination should be moved with care. Quick stops, excessive force, and uneven surfaces may cause the product and cart combination to overturn.
10. Ventilation – Slots and openings in the cabinet are provided for ventilation and to ensure reliable operation of the product and to protect it from overheating, and these openings must not be blocked or covered. The openings should never be blocked by placing the product on a bed, sofa, rug, or other similar surface. This product should not be placed in a built-in installation such as a bookcase or rack unless proper ventilation is provided or the manufacturer's instructions have been adhered to.
11. Power Sources – This product should be operated only from the type of power source indicated on the marking label. If you are not sure of the type of power supply to your home, consult your product dealer or local power company. For products intended to operate from battery power, or other sources, refer to the operating instructions.
12. Grounding or Polarization – This product may be equipped with a polarized alternating-current line plug (a plug having one blade wider than the other). This plug will fit into the power outlet only one way. This is a safety feature. If you are unable to insert the plug fully into the outlet, try reversing the plug. If the plug should still fail to fit, contact your electrician to replace your obsolete outlet. Do not defeat the safety purpose of the polarized plug.

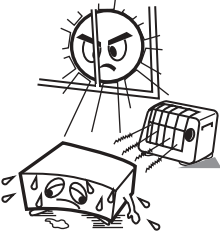
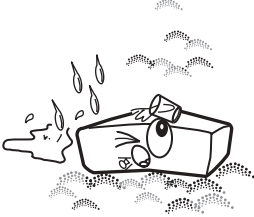

13. Power-Cord Protection – Power-supply cords should be routed so that they are not likely to be walked on or pinched by items placed upon or against them, paying particular attention to cords at plugs, convenience receptacles, and the point where they exit from the product.
15. Outdoor Antenna Grounding – If an outside antenna or cable system is connected to the product, be sure the antenna or cable system is grounded so as to provide some protection against voltage surges and built-up static charges. Article 810 of the National Electrical Code, ANSI/NFPA 70, provides information with regard to proper grounding of the mast and supporting structure, grounding of the lead-in wire to an antenna discharge unit, size of grounding conductors, location of antenna-discharge unit, connection to grounding electrodes, and requirements for the grounding electrode. See Figure A.
16. Lightning – For added protection for this product during a lightning storm, or when it is left unattended and unused for long periods of time, unplug it from the wall outlet and disconnect the antenna or cable system. This will prevent damage to the product due to lightning and power-line surges.
17. Power Lines – An outside antenna system should not be located in the vicinity of overhead power lines or other electric light or power circuits, or where it can fall into such power lines or circuits. When installing an outside antenna system, extreme care should be taken to keep from touching such power lines or circuits as contact with them might be fatal.
18. Overloading – Do not overload wall outlets, extension cords, or integral convenience receptacles as this can result in a risk of fire or electric shock.
19. Object and Liquid Entry – Never push objects of any kind into this product through openings as they may touch dangerous voltage points or short-out parts that could result in a fire or electric shock. Never spill liquid of any kind on the product.
20. Servicing – Do not attempt to service this product yourself as opening or removing covers may expose you to dangerous voltage or other hazards. Refer all servicing to qualified service personnel.
21. Damage Requiring Service – Unplug this product from the wall outlet and refer servicing to qualified service personnel under the following conditions:
 - a) When the power-supply cord or plug is damaged,
 - b) If liquid has been spilled, or objects have fallen into the product,
 - c) If the product has been exposed to rain or water,
 - d) If the product does not operate normally by following the operating instructions. Adjust only those controls that are covered by the operating instructions as an improper adjustment of other controls may result in damage and will often require extensive work by a qualified technician to restore the product to its normal operation,
 - e) If the product has been dropped or damaged in any way, and
 - f) When the product exhibits a distinct change in performance – this indicates a need for service.
22. Replacement Parts – When replacement parts are required, be sure the service technician has used replacement parts specified by the manufacturer or have the same characteristics as the original part. Unauthorized substitutions may result in fire, electric shock, or other hazards.
23. Safety Check – Upon completion of any service or repairs to this product, ask the service technician to perform safety checks to determine that the product is in proper operating condition.
24. Wall or Ceiling Mounting – The product should be mounted to a wall or ceiling only as recommended by the manufacturer.
25. Heat – The product should be situated away from heat sources such as radiators, heat registers, stoves, or other products (including amplifiers) that produce heat.

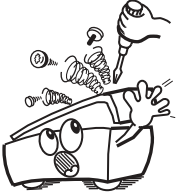

NOTE ON USE / OBSERVATIONS RELATIVES A L'UTILISATION / NOTAS SOBRE EL USO

| | | |
|--|--|---|
|  <ul style="list-style-type: none"> • Avoid high temperatures. Allow for sufficient heat dispersion when installed on a rack. • Eviter des températures élevées. Tenir compte d'une dispersion de chaleur suffisante lors de l'installation sur une étagère. • Evite altas temperaturas. Permite la suficiente dispersión del calor cuando está instalado en la consola. |  <ul style="list-style-type: none"> • Keep the set free from moisture, water, and dust. • Protéger l'appareil contre l'humidité, l'eau et lapoussière. • Mantenga el equipo libre de humedad, agua y polvo. |  <ul style="list-style-type: none"> • Do not let foreign objects in the set. • Ne pas laisser des objets étrangers dans l'appareil. • No deje objetos extraños dentro del equipo. |
|  <ul style="list-style-type: none"> • Handle the power cord carefully. Hold the plug when unplugging the cord. • Manipuler le cordon d'alimentation avec précaution. Tenir la prise lors du débranchement du cordon. • Maneje el cordón de energía con cuidado. Sostenga el enchufe cuando desconecte el cordón de energía. |  <ul style="list-style-type: none"> • Unplug the power cord when not using the set for long periods of time. • Débrancher le cordon d'alimentation lorsque l'appareil n'est pas utilisé pendant de longues périodes. • Desconecte el cordón de energía cuando no utilice el equipo por mucho tiempo. |  <ul style="list-style-type: none"> • Do not let insecticides, benzene, and thinner come in contact with the set. • Ne pas mettre en contact des insecticides, du benzène et un diluant avec l'appareil. • No permita el contacto de insecticidas, gasolina y diluyentes con el equipo. |
| |  <p>* (For sets with ventilation holes)</p> <ul style="list-style-type: none"> • Do not obstruct the ventilation holes. • Ne pas obstruer les trous d'aération. • No obstruya los orificios de ventilación. |  <ul style="list-style-type: none"> • Never disassemble or modify the set in any way. • Ne jamais démonter ou modifier l'appareil d'une manière ou d'une autre. • Nunca desarme o modifique el equipo de ninguna manera. |

Copyrights / Droits d'auteur / Derechos de Autor

■ It is prohibited by law to reproduce, broadcast, rent or play discs in public without the consent of the copyright holder.

■ La reproduction, la diffusion, la location, le prêt ou la lecture publique de ces disques sont interdits sans le consentement du détenteur des droits d'auteur.

■ De acuerdo con las leyes está prohibido reproducir, emitir, alquilar o interpretar discos en público sin la autorización del propietario de los derechos de autor.

— TABLE OF CONTENTS —

| | | | | | |
|----|-------------------------------------|---------|----|---|---------|
| 1 | Features..... | 6, 7 | 14 | Playing Repeatedly..... | 55, 56 |
| 2 | Discs..... | 8 | 15 | Playing Tracks in the Desired Order..... | 57 |
| 3 | Cautions on Handling Discs..... | 9 | 16 | Playing Tracks in the Random Order..... | 58 |
| 4 | Connections..... | 10 ~ 17 | 17 | Using the On-screen Display..... | 59 |
| 5 | Part Names and Functions..... | 18, 19 | 18 | Using the Multiple Audio, Subtitle and Angle Functions..... | 60 ~ 62 |
| 6 | Remote Control Unit..... | 20, 21 | 19 | Using the Menus..... | 63, 64 |
| 7 | Loading Discs..... | 22 | 20 | Marking Scenes you want to see again..... | 65 |
| 8 | Changing the Default Settings..... | 23 ~ 43 | 21 | Playing in the Zoom Mode..... | 66 |
| 9 | Using the Pure Direct Mode..... | 43, 44 | 22 | Playing MP3..... | 67, 68 |
| 10 | Using the Super Audio CD Setup..... | 44 | 23 | Playing WMA..... | 69 |
| 11 | Adjusting the Picture Quality..... | 45 ~ 48 | 24 | Playing Still Picture Files (JPEG format)..... | 70 ~ 72 |
| 12 | Using the Video Setup..... | 49 | 25 | Troubleshooting..... | 73, 74 |
| 13 | Playback..... | 50 ~ 54 | 26 | Main Specifications..... | 75 |

• ACCESSORIES

Please check to make sure the following items are included with the main unit in the carton:

| | | | |
|-------------------------------------|---|-------------------------------|---|
| ① Audio video cord..... | 1 | ④ Power supply cord..... | 1 |
| ② Remote control unit (RC-985)..... | 1 | ⑤ Operating instructions..... | 1 |
| ③ R6P/AA batteries..... | 2 | ⑥ Service station list..... | 1 |

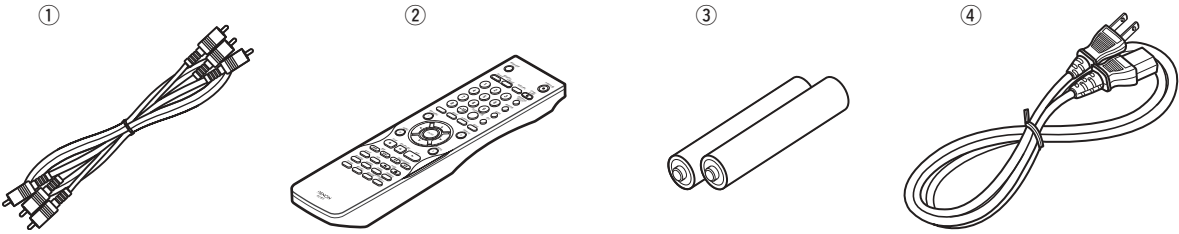

1 FEATURES

1. Digital transfer connectors

Digital transfer of video signals is possible by connecting an HDCP compatible display device equipped with one of the connectors below using a special cable.

When playing DVD AUDIO with CPPM, the video signal cannot be output, and then the audio signal cannot be output from the HDMI connector too.

(1) HDMI connector

Digital video signals are transferred in color space (Y/Cb/Cr) or RGB.

The audio signals can be transferred simultaneously, so both audio and video signals can be transferred with a single cable.

(2) DVI-D connector

Digital video signals are transferred in RGB.

2. Super Audio CD multi-channel playback compatibility

In addition to playing DVD audio and video discs, the DVD-2910/955 can play multi-channel Super Audio CDs with a playback frequency range covering 100 kHz and a dynamic range of 120 dB or greater within the audible frequency range, and a maximum of 5.1 channels can be output.

3. High precision 24-bit D/A converter

The audio playback circuit includes an advanced segment type D/A converter with the high technical specifications in the business, manufactured by Burr-Brown, a company with an established reputation for D/A converters. This high performance D/A converter allows not only input of the 24-bit/192 kHz data of DVD-Audio discs, it also includes an analog pure FIR filter for ideal DSD playback of Super Audio CDs. Furthermore, the same DAC is used unsparingly for the front, the surround, center and LFE channels to provide optimum sound quality during multi-channel playback as well.

4. HDCD® (High Definition Compatible Digital®) decoder (NOTE 1)

HDCD is an encoding/decoding technology that greatly reduces the distortion occurring at the time of digital recording while maintaining compatibility with the conventional CD format. HDCD allows 20-bit data to be converted into the 16-bit data of current CDs with no loss in sound quality.

The use of this HDCD decoder makes it possible to achieve the high resolution and low distortion characteristic of HDCD when playing HDCD-compatible discs, and DENON's digital technology optimizes the high sound quality possibilities of HDCD technology. Furthermore, normal CDs and HDCD-compatible CDs are automatically identified, and the optimum digital signal processing for that type of disc is used.

5. Dolby Digital/DTS decoder (NOTE 2, 3)

The DVD-2910/955 is equipped with a built-in Dolby Digital/DTS decoder, allowing you to recreate the atmosphere of a movie theater or concert hall when using the DVD-2910/955 in combination with an AV amplifier and speakers.

6. Progressive Scan circuit "DCDi™" (NOTE 4)

The DVD-2910/955 is equipped with a high precision Progressive Scan circuit "DCDi™" allowing it to reproduce movies and other images on DVDs with a quality near that of the original.

7. 12-bit/216 MHz video D/A converter (NOTE 5)

The DVD-2910/955 uses a video D/A converter that conducts D/A conversion of all video signals at 12 bits and allows 8X oversampling in the progressive mode to achieve the high quality picture that DVDs are meant to provide. In addition, NSV technology reduces noise upon D/A conversion.

8. Thorough vibration-resistant design

- (1) The pickup mechanism is positioned at the center to reduce the effects of external vibrations.
- (2) A low center of gravity make for a low vibration design.

9. Multiple functions

- (1) Still picture playback function
Kodak Picture CD (NOTE 6) and Fujifilm Fujicolor CD (NOTE 7) can be played on the DVD-2910/955.
Still images stored in JPEG format on CD-R/RWs can also be played.
- (2) Windows Media™ playback function (NOTE 8)
Windows Media™ CDs can be played on the DVD-2910/955.
- (3) Multiple audio function
Selection of up to 8 audio languages.
(The number of languages offered differs from DVD to DVD.)
- (4) Multiple subtitle function
Selection of up to 32 subtitle languages.
(The number of languages offered differs from DVD to DVD.)















- (5) Multiple angle function
The angle of view can be changed.
(For DVDs on which multiple angles are recorded.)
- (6) GUI (Graphical User Interface) function
The DISPLAY button on the remote control unit can be used to display player and disc information on the TV screen.
- (7) Marker function
The positions of up to five scenes can be stored in the memory, so you can watch your favourite scenes whenever you want.
- (8) Playback disable function
This function can be used to disable playback of DVDs you do not want children to watch.

NOTES:

1. ®, HDCD®, High Definition Compatible Digital® and Microsoft® are either registered trademarks or trademarks of Microsoft Corporation, Inc. in the United States and/or other countries. HDCD system manufactured under license from Microsoft Corporation, Inc. This product is covered by one or more of the following: In the USA: 5,479,168, 5,638,074, 5,640,161, 5,808,574, 5,838,274, 5,854,600, 5,864,311, 5,872,531, and in Australia: 669114. Other patents pending.
2. Manufactured under license from Dolby Laboratories. "Dolby" and the double-D symbol are trademarks of Dolby Laboratories.
3. "DTS" and "DTS Digital Surround" are registered trademarks of Digital Theater Systems, Inc.
4. "DCDi™" is trademark of Faroodja, a division of Genesis Microchip Inc.
5. "NSV" is a trademark of Analog Devices, Inc.
6. "KODAK" is a trademark of Eastman Kodak Company.
7. "FUJICOLOR CD" is a trademark of Fuji Photo Film Co, Ltd.
8. "Windows Media™", "Windows™" are a trademarks of Microsoft Corporation, Inc.

2 DISCS

- The types of discs listed on the table below can be used on the DVD-2910/955. The marks are indicated on the disc labels or jackets.

| Usable discs | Mark (logo) | Recorded signals | Disc size |
|------------------------------------|--|--|---------------|
| DVD video DVD audio (NOTE 1) |    | Digital audio + digital video (MPEG2) | 12 cm |
| DVD-R DVD-RW (NOTE 2) |     | | 8 cm |
| Super audio CD |  | Digital audio | 12 cm |
| Video CD (NOTE 1) |  | Digital audio + digital video (MPEG1) | 12 cm 8 cm |
| CD CD-R CD-RW (NOTE 3) |    | Digital audio MP3 Digital picture (JPEG) | 12 cm 8 cm |
| Picture CD |  | JPEG | 12 cm |
| Fujicolor CD |  | JPEG | 12 cm |
| WMA (Windows Media Audio) |  | Digital audio | 12 cm |

■ The following types of discs cannot be played on the DVD-2910/955:

- DVDs with region numbers other than "1" or "ALL"
- DVD-ROM/RAMs
- CD-ROMs (unless MP3, JPEG, WMA Files)
- CVD/VSDs
- CDVs (Only the audio part can be played.)
- CD-Gs (Only the audio is output.)
- Photo CDs

NOTE 1: Some DVD audio, DVD video and video CD discs do not operate as described in this manual due to the intentions of the discs' producers.

NOTE 2: Playing DVD-R and DVD-RW discs
DVD-R and DVD-RW discs recorded in video format on a DVD recorder can be played on the DVD-2910/955. Discs that have not been finalized cannot be played. Depending on the disc's recording status, the disc may not be accepted or may not be played normally (the picture or sound may be not be smooth, etc.).

NOTE 3: According to recording quality, some CD-R/RW cannot be played.

NOTE:

- This DVD player is designed and manufactured to respond to the Region Management Information that is recorded on a DVD disc. If the Region number described on the DVD disc does not correspond to the Region number of this DVD player, this DVD player cannot play this disc. The Region number for this DVD player is 1.



■ Disc terminology

• Groups and tracks (DVD-audios)

DVD-audios are divided into several large sections called "groups" and smaller sections called "tracks". Numbers are allotted to these sections. These numbers are called "group numbers" and "track numbers".

For example:

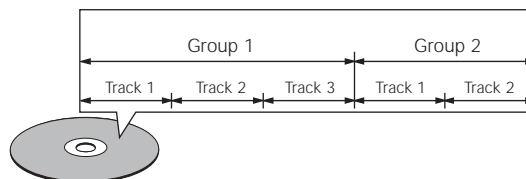

• Titles and chapters (DVD-videos)

DVD-videos are divided into several large sections called "titles" and smaller sections called "chapters". Numbers are allotted to these sections. These numbers are called "title numbers" and "chapter numbers".

For example:

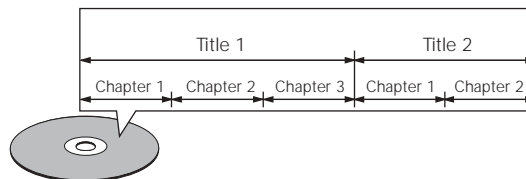

• Tracks (Super audio CDs, video and music CDs)

Super audio CDs, video and music CDs are divided into sections called "tracks". Numbers are allotted to these sections. These numbers are called "track numbers".

For example:

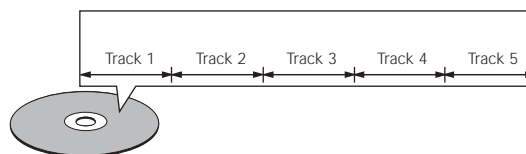

• Playback control (video CDs)

Video CDs including the words "playback control" on the disc or jacket are equipped with a function for displaying menus on the TV screen for selecting the desired position, displaying information, etc., in dialog fashion. In this manual, playing video CDs using such menu is referred to "menu playback". Video CDs with playback control can be used on the DVD-2910/955.

3 CAUTIONS ON HANDLING DISCS

Discs

Only the discs including the marks shown on page 8 can be played on the DVD-2910/955.

Note, however, that discs with special shapes (heart-shaped discs, hexagonal discs, etc.) cannot be played on the DVD-2910/955. Do not attempt to play such discs, as they may damage the player.



Holding Discs

Avoid touching the surface of discs when loading and unloading them.

Be careful not to get fingerprints on the signal surface (the side which shines in rainbow colors).

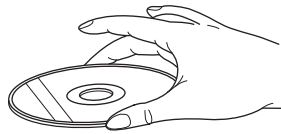

Cleaning Discs

- Fingerprints or dirt on the disc may lower sound and picture quality or cause breaks in playback. Wipe off fingerprints or dirt.
- Use a commercially available disc cleaning set or a soft cloth to wipe off fingerprints or dirt.

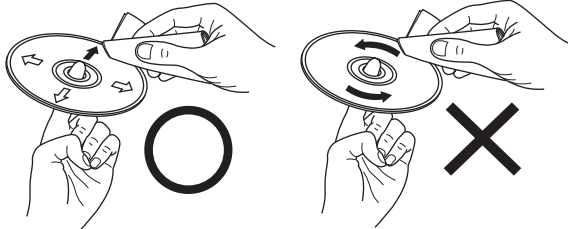

Wipe gently from the middle outwards.

Do not wipe with a circular motion.

NOTE:

- Do not use record spray or antistatic. Also do not use volatile chemicals such as benzene or thinner.



Record spray Thinner Benzene

Cautions on Handling Discs

- Do not get fingerprints, grease or dirt on discs.
- Be especially careful not to scratch discs when removing them from their cases.
- Do not bend discs.
- Do not heat discs.
- Do not enlarge the center hole.
- Do not write on the labeled (printed) side with a ball-point pen or a pencil.
- Water droplets may form on the surface if the disc is moved suddenly from a cold place to a warm one. Do not use a hairdryer, etc., to dry the disc.

Cautions on Storing Discs

- Always eject discs after playing them.
- Keep discs in their cases to protect them from dust, scratches and warping.
- Do not put discs in the following places:
 1. Places exposed to direct sunlight for long periods of time
 2. Humid or dusty places
 3. Places exposed to heat from heaters, etc.

Cautions on Loading Discs

- Only load one disc at a time. Loading one disc on top of another may result in damage or scratch the discs.
- Load 8 cm discs securely in the disc guide, without using an adapter. If the disc is not properly loaded, it may slip out of the guide and block the disc tray.
- Be careful not to let your fingers get caught when the disc tray is closing.
- Do not place anything but discs in the disc tray.
- Do not load cracked or warped discs or discs that have been fixed with adhesive, etc.
- Do not use discs on which the adhesive part of cellophane tape or glue used to attach the label is exposed, or discs with traces of tape or labels that have been peeled off. Such discs may get stuck inside the player, resulting in damage.

CAUTIONS ON INSTALLATION

For heat dispersal, leave at least 10 cm of space between the top, back and sides of this unit and the wall or other components.

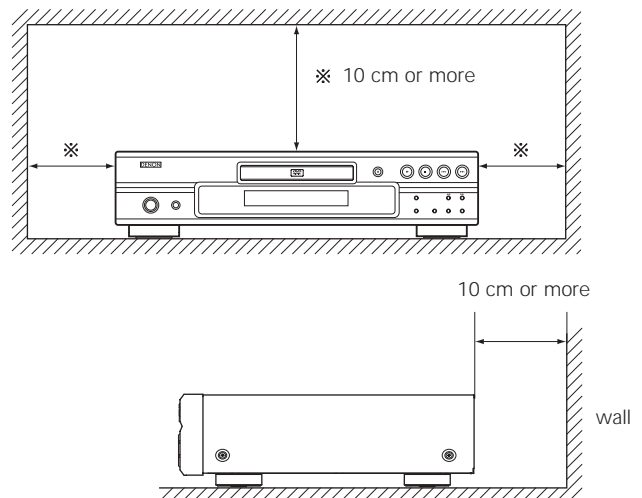

4 CONNECTIONS

NOTES:

- Read the manuals of all the components when making connections.
- Keep the power supply cord unplugged until all connections have been completed.
- If the power is on when connections are made, noise may be generated and damage the speakers.
- Be sure to connect the left and right channels properly, L (left) to L, R (right) to R.
- Plug the power supply cord securely into the power outlet. Incomplete connection may result in noise.
- Binding the power supply cord together with connection cords may result in humming or noise.

(1) Connecting to a TV

- Use the included audio video cord to connect the TV's video input connector and audio input connectors to the DVD-2910/955's VIDEO OUT or S-VIDEO OUT and AUDIO OUT.

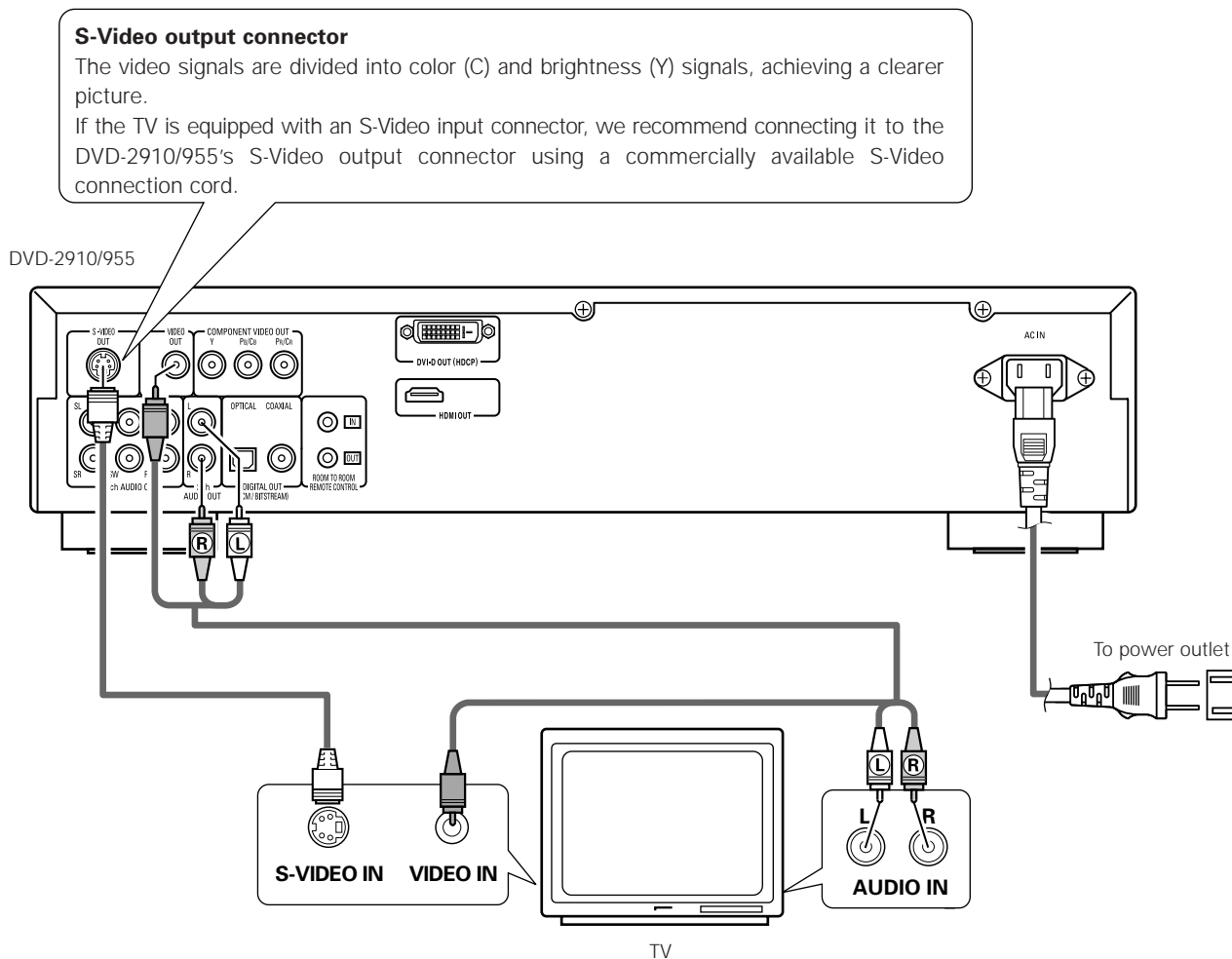

NOTES:

- Connect the DVD-2910/955's video outputs to the TV either directly or through an AV amplifier. Do not connect it via a VCR (video cassette recorder). Some discs contain copy prohibit signals. If such discs are played via a VCR, the copy prohibit system may cause disturbance in the picture.
- Set the "TV TYPE" in "VIDEO SETUP" in "SETUP" to comply with your TV's video format. When the TV is NTSC formatted set to NTSC. (See pages 32, 33.)
- To use with 5.1ch audio output, set "2CH (SRS OFF)" or "2CH (SRS ON)" under "AUDIO CHANNEL" in "AUDIO SETUP" on the "SETUP" menu to the initial settings. (See page 34.)
- Set the "TV ASPECT" in "VIDEO SETUP" in "SETUP" to comply with your TV's aspect. (See page 32.)
- To use with video out or s-video output, set "INTERLACED" in "VIDEO OUT" in "VIDEO SETUP" in "SETUP" at the initial settings. (See pages 32, 33.)

(2) Connecting to a TV or Monitor Equipped with Color Component Input Connectors

Color component output connectors (PR/CR, PB/CB and Y)

The red (PR/CR), blue (PB/CB) and brightness (Y) signals are output independently, achieving more faithful reproduction of the colors.

- The color component input connectors may be marked differently on some TVs or monitors (PR, PB and Y/R-Y, B-Y and Y/CR, CB and Y, etc.). For details, refer to the TV's operating instructions.
- **Connect in this way if your TV is compatible with Progressive Scan.**

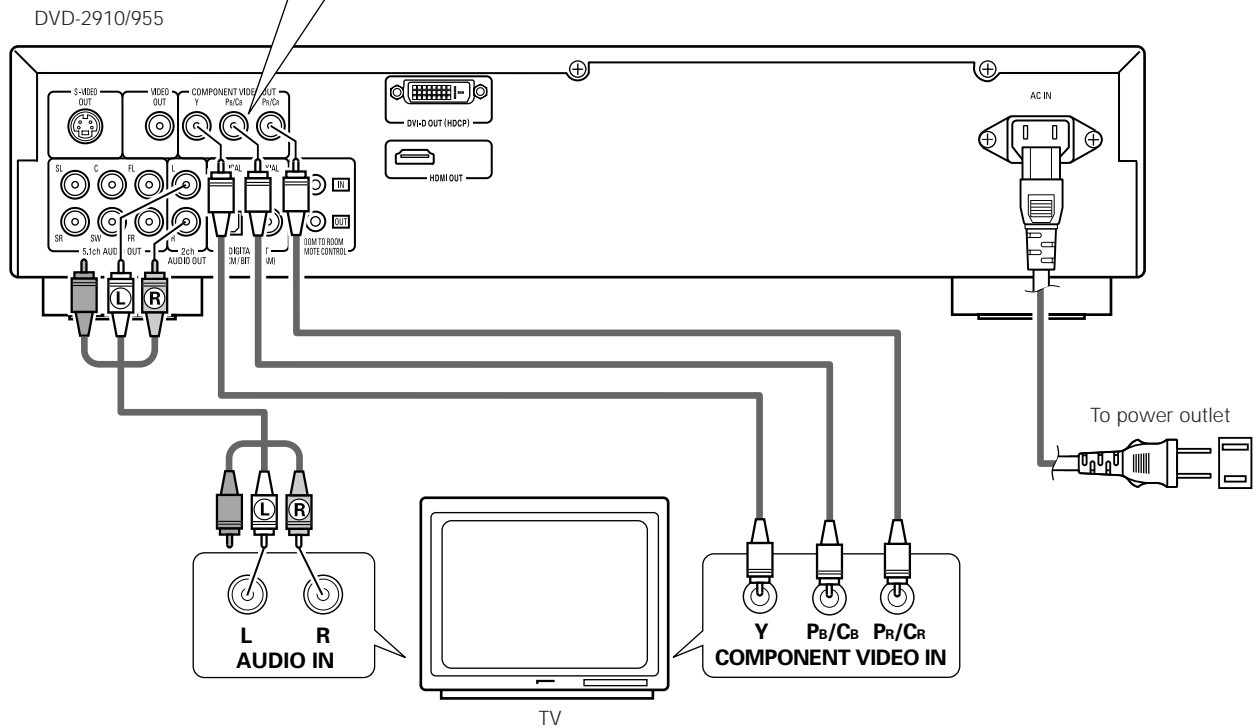

NOTES:

- Use the three commercially available video cords to connect the DVD-2910/955's color component output connectors to the TV or monitor.
- Set the "TV TYPE" in "VIDEO SETUP" in "SETUP" to comply with your TV's video format. When the TV is NTSC formatted set to NTSC. (See pages 32, 33.)
- Set the "VIDEO OUT" in "VIDEO SETUP" in "SETUP" to comply with Progressive TV.
- To use with 5.1ch audio output, set "2CH (SRS OFF)" or "2CH (SRS ON)" in "AUDIO CHANNEL" in "AUDIO SETUP" in "SETUP" at the initial settings. (See page 34.)
- Set the "TV ASPECT" in "VIDEO SETUP" in "SETUP" to comply with your TV's aspect. (See page 32.)

CONSUMERS SHOULD NOTE THAT NOT ALL HIGH DEFINITION TELEVISION SETS ARE FULLY COMPATIBLE WITH THIS PRODUCT AND MAY CAUSE ARTIFACTS TO BE DISPLAYED IN THE PICTURE. IN CASE OF 525 OR 625 PROGRESSIVE SCAN PICTURE PROBLEMS, IT IS RECOMMENDED THAT THE USER SWITCH THE CONNECTION TO THE "STANDARD DEFINITION" OUTPUT.

(3) Connecting to a AV amplifier with a built-in decoder

When DVDs recorded in Dolby Digital or DTS are played, Dolby Digital or DTS bitstream signals are output from the DVD player's digital audio output connectors. If a Dolby Digital or DTS decoder is connected, you can achieve sound with the power and sense of presence of a movie theater or concert hall.

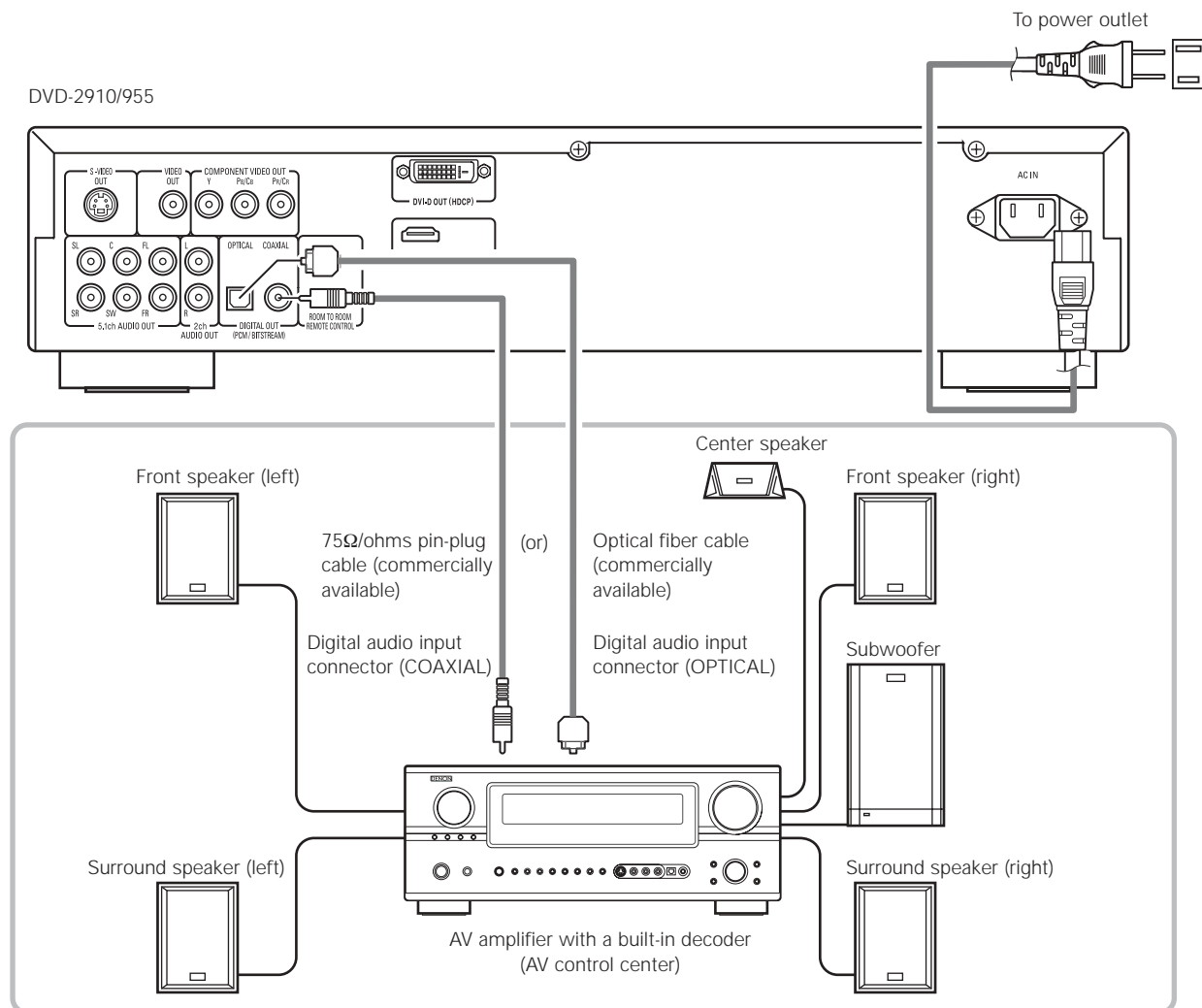

NOTES:

- Harsh noise that could harm your ears or damage the speakers is generated when a DVD recorded in DTS is played while using a decoder, etc., that is not DTS-compatible.
- When playing copyright-protected linear PCM or packed PCM DVDs, in consideration of copyrights, no digital signals are output for sources exceeding 48 kHz/16 bits. When playing such sources, either set "LPCM (44.1 kHz/48 kHz)" under "AUDIO SETUP" at "SETUP" to "ON" (See pages 34, 37.) or make analog connections. (See page 14.)
- When making digital connections to an AV amplifier that is not compatible with 96 kHz/88.2 kHz signals, set "LPCM (44.1 kHz/48 kHz)" under "AUDIO SETUP" at "SETUP" to "ON". (See pages 34, 37.)
- With Super audio CDs, digital audio signals cannot be output from the digital out terminals. Use analog connections. (See page 14.)

■ Connecting an optical fiber cable (commercially available) to the digital audio input connector (OPTICAL)

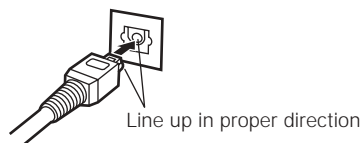

Line up the cable in the proper directly, then insert it securely as far as it goes.

■ Sound output from the DVD-2910/955's digital audio output connectors

In the case of bitstream output

| | | Settings | |
|-----------|---------------|-------------------------|-------------------------------------|
| | | DIGITAL OUT | |
| | | NORMAL | PCM |
| DVD video | Dolby Digital | Dolby Digital bitstream | 2 channels PCM (48 kHz / 16 bit) |
| | DTS | DTS bitstream | 2 channels PCM (48 kHz / 16 bit) |

In the case of PCM output

| | | | Settings | | |
|----------------|--------------------------------|-------------------------|---------------------------|----------------------------|---------------------------|
| | | | LPCM SELECT | | |
| | | | OFF | | ON |
| | | | Copy protection ON | Copy protection OFF | |
| DVD video | Linear PCM | 48 kHz / 16 ~ 24 bit | No output data (*1) | 48 kHz / 16 ~ 24 bit PCM | 48 kHz / 16 bit PCM |
| | | 96 kHz / 16 ~ 24 bit | No output data | 96 kHz / 16 ~ 24 bit PCM | 48 kHz / 16 bit PCM |
| DVD audio | Linear PCM or Packed PCM | 44.1 kHz / 16 ~ 24 bit | No output data (*2) | 44.1 kHz / 16 ~ 24 bit PCM | 44.1 kHz / 16 bit PCM |
| | | 48 kHz / 16 ~ 24 bit | No output data (*1) | 48 kHz / 16 ~ 24 bit PCM | 48 kHz / 16 bit PCM |
| | | 88.2 kHz / 16 ~ 24 bit | No output data | 88.2 kHz / 16 ~ 24 bit PCM | 44.1 kHz / 16 bit PCM |
| | | 96 kHz / 16 ~ 24 bit | No output data | 96 kHz / 16 ~ 24 bit PCM | 48 kHz / 16 bit PCM |
| | | 176.4 kHz / 16 ~ 24 bit | No output data | 88.2 kHz / 16 ~ 24 bit PCM | 44.1 kHz / 16 bit PCM |
| | | 192 kHz / 16 ~ 24 bit | No output data | 96 kHz / 16 ~ 24 bit PCM | 48 kHz / 16 bit PCM |
| Video CD | MPEG 1 | | 44.1 kHz / 16 bit PCM | | 44.1 kHz / 16 bit PCM |
| Music CD | 44.1 kHz / 16 bit Linear PCM | | 44.1 kHz / 16 bit PCM | | 44.1 kHz / 16 bit PCM |
| MP3 CD | MP3 (MPEG-1 Audio Layer 3) | | 44.1, 48 kHz / 16 bit PCM | | 44.1, 48 kHz / 16 bit PCM |
| WMA CD | WMA (Windows Media Audio) | | 44.1, 48 kHz / 16 bit PCM | | 44.1, 48 kHz / 16 bit PCM |
| Super audio CD | DSD (DIRECT STREAM DIGITAL) | | No output data (*3) | | No output data (*3) |

*1 Only 48 kHz/16 bit sources are output.

*2 Only 44.1 kHz/16 bit sources are output.

*3 44.1 kHz/16-bit PCM signals are output during CD layer playback.

- Down-mixed to 2 channels for multi-channel PCM sources. (Only the front left and right channels are output for sources for which down-mixing is prohibited.)
- When "DIGITAL OUT : OFF" is selected at the PURE DIRECT MODE, digital signals are not output from the digital audio output at this time.
- Bitstream signals are signals that are compressed and converted into digital format. They are decoded into multi-channel audio signals (5.1-channels, etc.) by the decoder.
- Linear PCM audio is the signal recording format used for music CDs.
While the signals are recorded at 44.1 kHz/16 bit for music CDs, for DVDs they are recorded at 44.1 kHz/16 bit to 192 kHz/24 bit, providing higher sound quality than music CDs.
- Packed PCM signals are high sound quality compressed PCM signals that are decompressed with virtually no loss of data.

(4) Connecting a basic 5.1-channel surround system

Analog 5.1-channel audio signals can be output from the DVD-2910/955.

The multichannel audio signals recorded in packed PCM and the multichannel Super audio CDs can be played when an AV amplifier equipped with analog 5.1-channel audio inputs is connected.

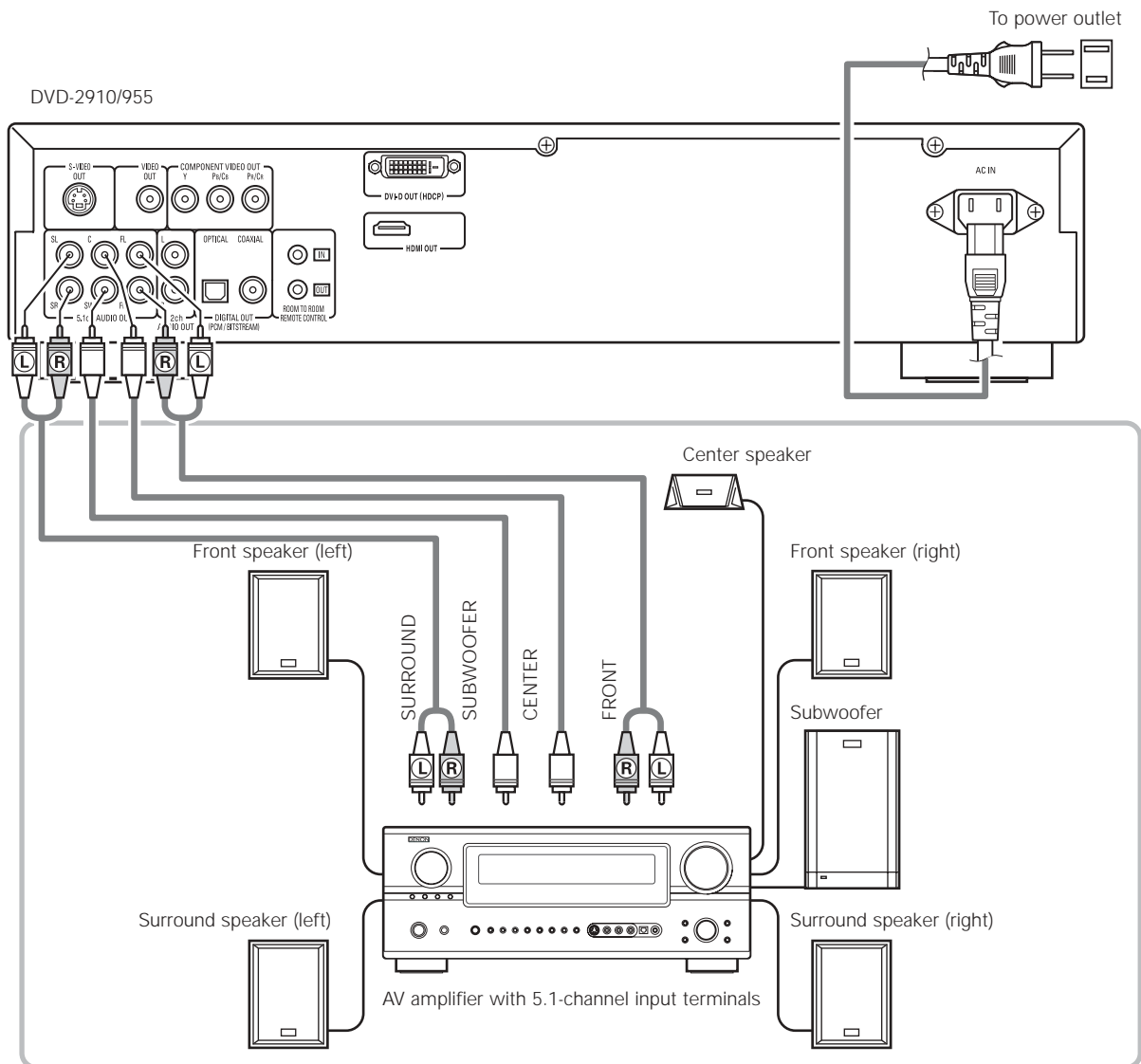

NOTES:

- For multi-channel connections, set "AUDIO CHANNEL" under "AUDIO SETUP" at "SETUP" to "MULTI CHANNEL" and make the "SPEAKER CONFIGURATION", "CHANNEL LEVEL" and "DELAY TIME" settings. (See pages 34 ~ 38.)
- With the DVD-2910/955, we recommend turning the digital output off by using the PURE DIRECT MODE and only outputting analog signals in order to keep interference from the digital output circuitry to a minimum and allow you to enjoy high-quality multi-channel sound thanks to the high-bit, high sampling frequency. (See pages 43, 44.)

(5) Connecting to a Digital Recorder (MD Recorder, DAT Deck, etc.)

* Set the "AUDIO SETUP" default setting as shown below. (See pages 34 ~ 37.)

- "DIGITAL OUT" → "PCM"
- "LPCM (44.1kHz/48kHz)" → "ON"

Playing DVDs with incorrect settings may result noise that could damage your ears or the speakers.

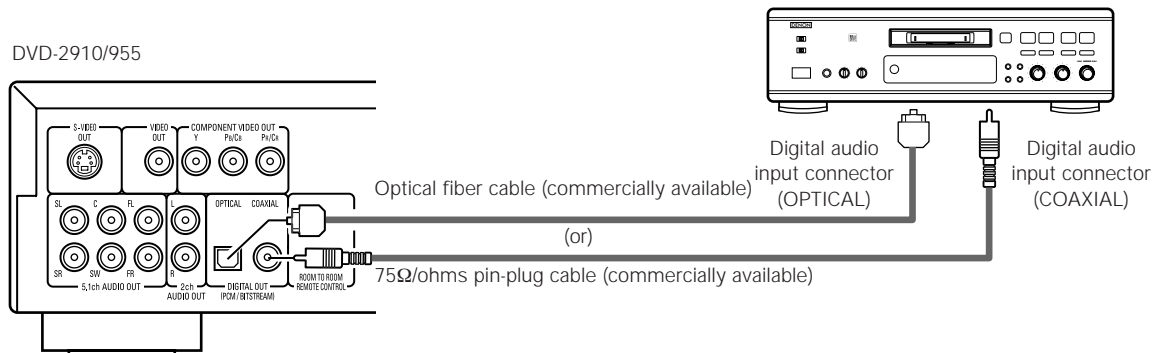

NOTE:

- Digital audio signals cannot be output when playing Super Audio CDs. Use analog connections to record Super Audio CDs.

(6) Connecting to a Stereo Component

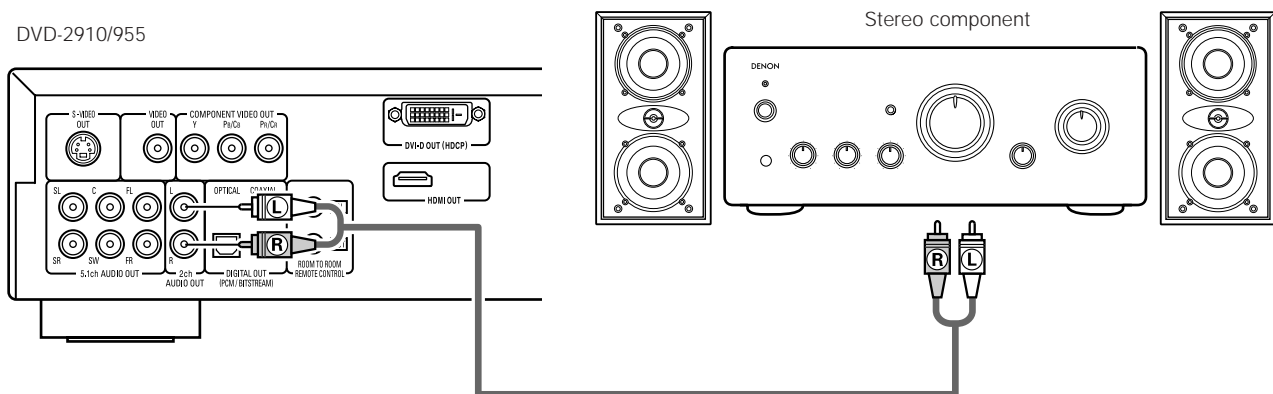

NOTE:

- When connecting to a 2-channel audio stereo device using the 5.1ch AUDIO OUT, set "AUDIO CHANNEL" under "AUDIO SETUP" on the "SETUP" menu to "2CH (SRS OFF)" or "2CH (SRS ON)" (See page 34.). For multi-channel sources, the signals are down-mixed into two channels (analog).
(Only the front left and right channels are output for sources for which down-mixing is prohibited.)

(7) HDMI connections

A simple 1-cable connection (using a commercially available cable) with a device having an HDMI (High-Definition Multimedia Interface) connector allows digital transfer of the digital images of DVD video and other sources, DVD video, and the multi-channel sound of DVD audio.

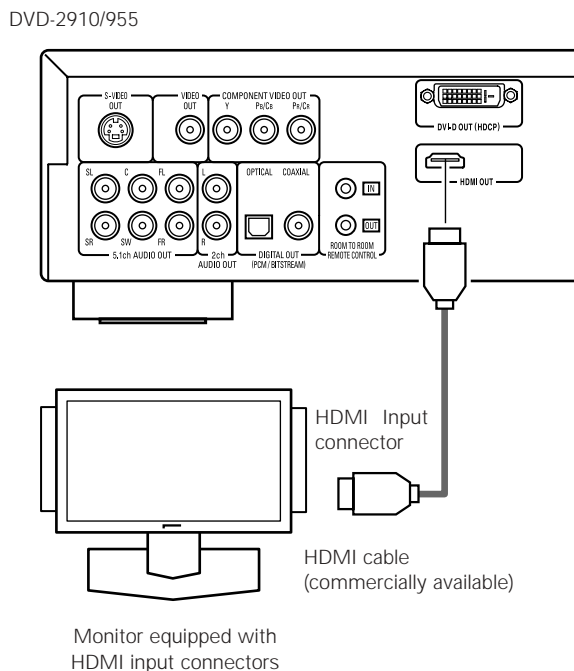

| | Audio recording format | Setting of HDMI | | |
|----------------|------------------------------|-----------------|----------------|---------------|
| | | 2CH | MULTI (NORMAL) | MULTI (LPCM) |
| DVD video | Dolby digital | 2 channel PCM | Dolby digital | Multi PCM |
| | DTS | 2 channel PCM | DTS | Multi PCM |
| DVD Audio | LPCM or P.PCM (with CPPM) | X | X | X |
| | LPCM or P.PCM (without CPPM) | 2 channel PCM | Multi PCM | Multi PCM |
| Video CD | | 2 channel PCM | 2 channel PCM | 2 channel PCM |
| CD | | 2 channel PCM | 2 channel PCM | 2 channel PCM |
| MP3 CD | | 2 channel PCM | 2 channel PCM | 2 channel PCM |
| WMA CD | | 2 channel PCM | 2 channel PCM | 2 channel PCM |
| Super Audio CD | Multi area | X | X | X |
| | Stereo area | X | X | X |
| | CD layer | 2 channel PCM | 2 channel PCM | 2 channel PCM |

* The multi-channel/stereo area sound of Super Audio CD is not output.

* The video and audio signals cannot be output when playing DVD AUDIO with CPPM.

Connection Examples for HDMI AUDIO SETUP

HDMI-supported monitor or projector, etc. (2-channel support or no audio support)

- 2CH.....Use this connection when you would like to enjoy the multi-channel audio output from an analog audio output connector.

HDMI-supported monitor/AV amplifier, etc. (Supports DTS and Dolby Digital decoders)

- MULTI (NORMAL)....Use this connection when you would like to enjoy the multi-channel audio output from an HDMI connector and you wish to have a DTS, Dolby Digital, or other decoder connected to do the processing. (Speaker and other settings are not required.)

HDMI-supported monitor (Supports audio input for 2 or more channels)

- MULTI (LPCM).....Use this connection when you would like to enjoy the multi-channel output from an HDMI connector and the connection point does not support a DTS, Dolby Digital, or other decoder. (Speaker settings are permitted.)

NOTES:

- HDMI audio output settings permit the selection of either 2 channels or multi-channels. When selecting multi (NORMAL) or MULTI (LPCM), a down-mixed audio signal is only output from the analog connectors (Left/Right and Front Left/Front Right) of the DVD-2910/955. To output multi-channel sound from the analog audio output connectors, set HDMI to OFF, or select 2CH.
- When the HDMI audio setting is set to multi-channel, the "AUDIO CHANNEL", "DIGITAL OUTPUT", "LPCM (44.1 kHz/48 kHz)", "SOURCE DIRECT", and "BASS ENHANCER" under "AUDIO SETUP".
- The HDMI audio output is turned off if the digital output is set to "OFF" at "PURE DIRECT", and the HDMI video and audio output are both turned off if the video output is set to "OFF" or if "ALL OFF" is set. (See Pages 43, 44.)
Also note that it will not be possible to select the setting of digital output, when selecting "MULTI (NORMAL)" at "HDMI AUDIO SETUP".
- When selecting MULTI (NORMAL) or MULTI (LPCM), the DVD-2910/955 speaker settings under "AUDIO SETUP" become invalid.
- When playing a Super Audio CD with an HDMI connection, audio cannot be transferred beyond the CD layer. Make an analog connection for this.
- Among the devices that support HDMI, some devices can control other devices via the HDMI connector; however, the DVD-2910/955 cannot be controlled by another device vice the HDMI connector.
- When using display equipment that is not supported by the HDCP (content protection function), the image will not be output properly. (See the compatibility table.)
- The audio signals from the HDMI connector (including the sampling frequency and bit length) may be limited by the equipment that is connected.

(8) DVI connections

Connection with equipment that has a DVI (Digital Visual Interface)-D connector permits the transfer of digital images.

- * When using display equipment that is not supported by the HDCP (content protection function), the image will not be output properly. (See the compatibility table.)
- * Make an audio connection also because an audio signal will not be output from the DVI-D connector.
- * Commercially-available DVI cables are available in 24-pin and 29-pin types. The DVD-2910/955 supports the 24-pin DVI-D cable, but the 29-pin DVI cable cannot be connected.

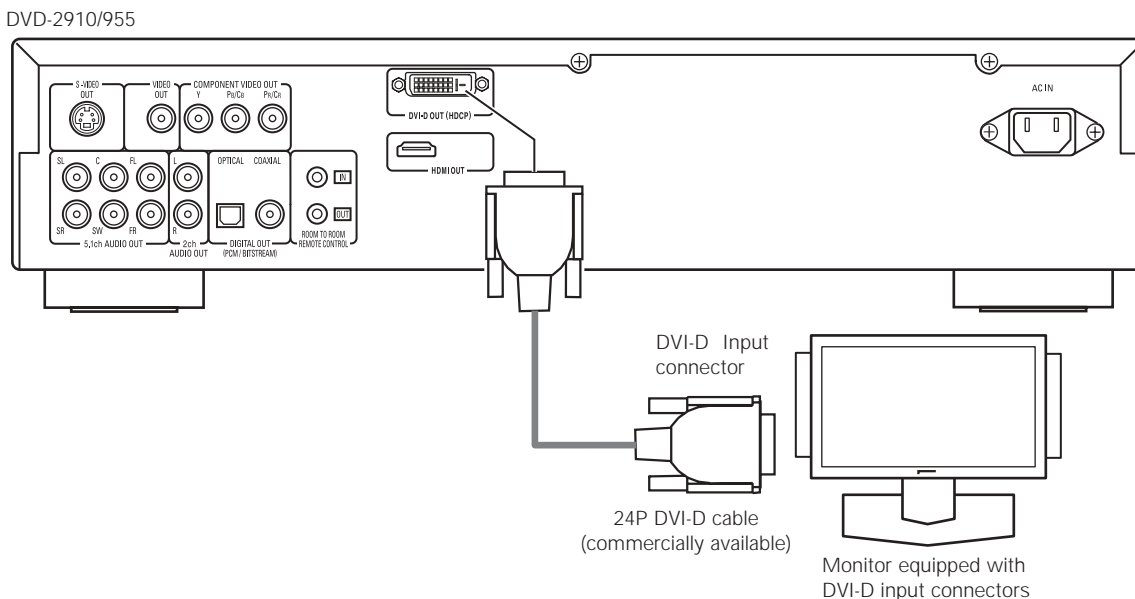

NOTE:

HDMI and DVI connectors.

- The table below indicates the compatibility of connections between the HDMI/DVI-D output connector of the DVD-2910/955 and monitors that support HDMI/DVI-D.

| | Monitor with HDMI | Monitor with DVI-D (HDCP compatible) | Monitor with DVI-D (HDCP incompatible) |
|-----------------------|--------------------|--------------------------------------|--|
| HDMI output terminal | ○ Video/Audio*1 | ○ (Only Video)*2 | x |
| DVI-D output terminal | ○ (Only Video) | ○ (Only Video) | x |

*1 Among the monitors that support HDMI, some do not support audio output (for example, projectors). In connections with equipment such as this, audio signals are not output from the HDMI output connector. Use analog audio outputs connectors to provide the audio output at "DIGITAL INTERFACE SETUP" under "SETUP", set "HDMI AUDIO SETUP" to "2CH".

*2 When the set's HDMI connector is connected to a DVI-D compatible monitor (HDCP compatible) with an HDMI-DVI converter cable (commercially available), the signals are output in digital RGB, regardless of the "HDMI/DVI SELECT" setting.

Copyright Protection System

To play the digital images and sounds of DVD video or DVD audio via an HDMI/DVI-D connection, it is necessary that both the player and monitor (or AV amplifier) support a copyright protection system called HDCP (High-bandwidth Digital Content Protection System). HDCP is copy protection technology that comprises data encryption and authentication of the partner equipment. The DVD-2910/955 supports HDCP. Please see the user's manual of your monitor (or AV amplifier) for information about this.

5 PART NAMES AND FUNCTIONS

(1) Front Panel

See page 3.

1 Power ON/STANDBY button

- Press once to set to the standby mode. The indicator lights up in red.
- Press again to turn the power on. The indicator lights up in green.

2 Power indicator

- This indicator lights when the power is on and when the power is in the standby mode.
Light green: Power is on
Light red : Power is in the standby mode

3 Power switch

- Press once to turn the power on.
- Press again to set to the "OFF" position and turn the power off.

4 Display

- Information on the disc that is currently playing is shown on the display. (See page 19.)

5 Remote control sensor

6 Select the playback area/layer of SUPER AUDIO CD (SUPER AUDIO CD SETUP)

- Switch the area /layer of the Super audio CDS played with priority.
- MULTI.....When playing Super audio CDs, the Multi channel area is played with priority
- STEREO....When playing Super audio CDs, the stereo channel area is played with priority.
- CD.....When playing Super audio CDs, the CDs layer is played with priority.

→MULTI → STEREO → CD ←

7 PURE DIRECT SELECT button

- Press to switch the modes with the specific video signals and digital audio signals and indicate in display on and off. (See pages 43, 44.)

→NORMAL → MODE 1 → MODE 2 → ALL OFF ←

8 SELECT of HDMI/DVI button

- Press this to set the video signal output from the HDMI connector or the DVI connector. (See page 49.)

→ HDMI Y Cb Cr → HDMI RGB → DVI ←
HDMI/DVI OFF ←

9 FORMAT of HDMI/DVI button

- Press this to set the video signal format from the HDMI connector or the DVI connector. (See page 49.)

→ 480P/576P → 720P → 1080i ←

10 Disc tray

- Load discs here. (See pages 22, 50.)
- Press the OPEN/CLOSE button 11 to open and close the disc tray.
- The disc tray is also closed when the PLAY button 13 is pressed.

11 OPEN/CLOSE button (▲)

- Press this to open and close the disc tray. (See pages 22, 50.)

12 STILL/PAUSE button (III)

- Press this to pause images or music or to play images frame by frame. (See page 52.)

13 PLAY button (▶)

- Press this to play the disc. (See page 51.)

14 STOP button (■)

- Press this to stop the disc. (See page 52.)

15 Skip button (I◀◀)

- Press this to move back to the beginning of the current track (or chapter). (See page 53.)
- Press again to move back to the beginning to the previous track (or chapter).

16 Skip button (▶▶I)

- Press this to move ahead to the beginning of the next track (or chapter). (See page 53.)

17 Slow/Search buttons (◀◀ ▶▶)

- Press this to set the slow or search play mode. (See pages 52, 53.)

◀◀: search in the reverse direction.
▶▶: search in the forward direction.

(2) Rear Panel**18 Audio output connectors (5.1ch AUDIO OUT)**

- Connect using an audio cord. Connect a commercially available pin-plug cord.

19 Audio output connectors (2ch AUDIO OUT)

- Connect using the included audio video cord.
Multi-channel sound is down-mixed and output.

20 Digital audio output connector (OPTICAL)

- Connect using an optical fiber cable (available in stores).
- Digital data is output from this connector.

21 Digital audio output connector (COAXIAL)

- Connect using an digital audio cord. Connect a commercially available 75 Ω/ohms pin-plug cord.
- Digital data is output from this connector.

22 Control output connector (ROOM TO ROOM/OUT)

- This is the output connector for wired remote control.
Consult your DENON dealer if you wish to use this connector.

23 Control input connector (ROOM TO ROOM/IN)

- This is the input connector for wired remote control.
Consult your DENON dealer if you wish to use this connector.

24 HDMI output connector (HDMI)

- Connect using HDMI connection cord (available in stores).

25 DVI-D-Video output connector (DVI-D OUT)

- Connect using 24P DVI-D connection cord (available in stores).

26 S-Video output connector (S-VIDEO OUT)

- Connect using an S-Video connection cord (available in stores).

27 Video output connector (VIDEO OUT)

- Connect using the included audio video cord.

28 Component video output connectors (COMPONENT VIDEO OUT)

- Connect using video cords (available in stores).

29 Power input (AC IN)

- Connect to AC power supply using the included power supply cord.

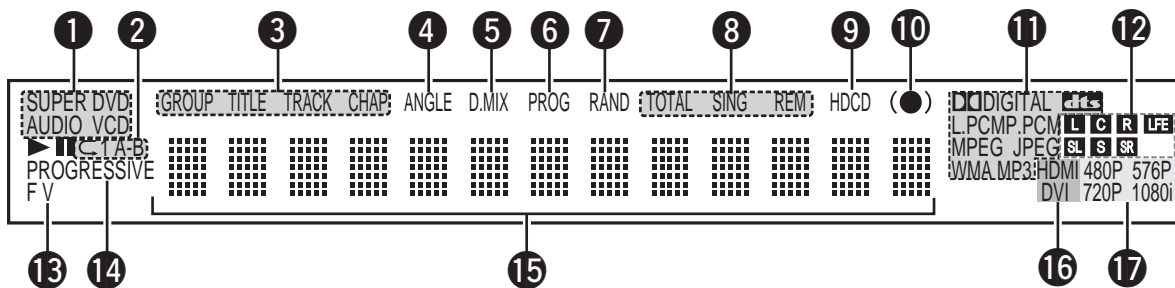
(3) Display

1 Lights to indicate the currently playing disc.

2 Lights in the repeat play mode.

3 These light to indicate the names of sections of the disc being played.

4 Lights during playback of multiple angles disc.

5 Lights when the audio signals can be down-mixed.

6 Lights in the programmed play mode.

7 Lights in the random play mode.

8 There light to indicate the time display mode.

9 Lights when HDCD is playing.

10 Lights when SRS TruSurround is on.

11 Lights to indicate the currently playing audio format.

12 Lights to indicate the currently playing audio.

L : Front left channel S : Mono surround channel

C : Center channel SR : Surround right channel

R : Front right channel LFE : Low frequency effect

SL : Surround left channel

13 Lights to indicate the currently playing video type.

F :Film source

V :Video source

14 Lights when progressive video signals are being output.

15 Displays the title , track number and elapsed time during playback.

16 Lights when the video (or audio) signals is output from HDMI or DVI terminals.(Lights only one of the HDMI or DVI.) (Flashes while the connection to the DVI-D or HDMI connector is being checked.)

17 Lights to indicate the currently video format of HDMI or DVI terminals. (Flashes while the connection to the DVI-D or HDMI connector is being checked.)

6 REMOTE CONTROL UNIT

■ The DVD-2910/955 can be controlled from a distance using the included remote control unit (RC-985).

(1) Inserting Batteries

① Remove the remote control unit's rear cover.

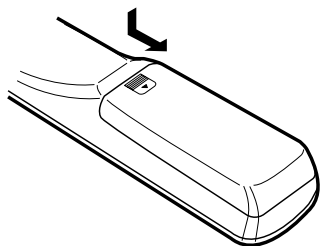

② Place two R6P/AA batteries in the battery compartment in the direction indicated by the marks.

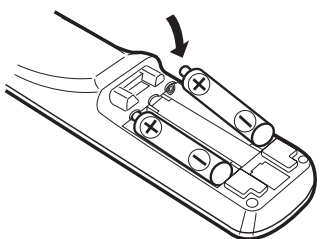

③ Close the rear cover.

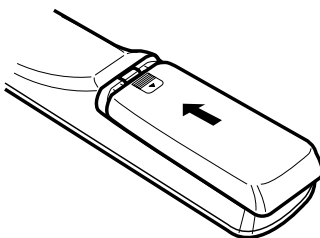

Cautions On Batteries

- Use R6P/AA batteries in this remote control unit.
- Replace the batteries with new ones approximately once a year, though this depends on the frequency with which the remote control unit is used.
- If the remote control unit does not operate from close to the main unit, replace the batteries with new ones, even if less than a year has passed.
- The included battery is only for verifying operation. Replace it with a new battery as soon as possible.
- When inserting the batteries, be careful to do so in the proper direction, following the ⊕ and ⊖ marks in the remote control unit's battery compartment.
- To prevent damage or battery fluid leakage:
 - Do not use a new battery with an old one.
 - Do not use two different types of batteries.
 - Do not short-circuit, disassemble, heat or dispose of batteries in flames.
- Remove the batteries when not planning to use the remote control unit for a long period of time.
- If the batteries should leak, carefully wipe off the fluid from the inside of the battery compartment, then insert new batteries.

(2) Using the Remote Control Unit

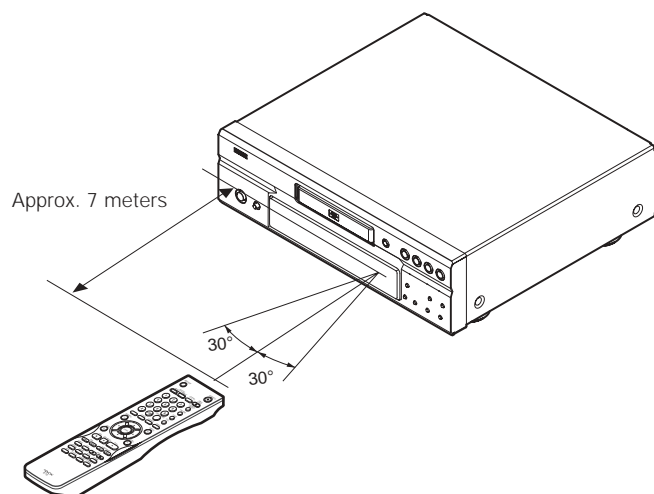

- When operating the remote control unit, point it at the remote control sensor as shown on the diagram.
- The remote control unit can be used from a direct distance of approximately 7 meters. This distance will be shorter, however, if there are obstacles in the way or if the remote control unit is not pointed directly at the remote control sensor.
- The remote control unit can be operated at a horizontal angle of up to 30° with respect to the remote control sensor.

NOTES:

- It may be difficult to operate the remote control unit if the remote control sensor is exposed to direct sunlight or strong artificial light.
- Do not press buttons on the main unit and on the remote control unit at the same time. Doing so will result in malfunction.

(3) Names and Functions of Remote Control Unit Buttons

■ Button not explained here function in the same way as the corresponding buttons on the main unit.

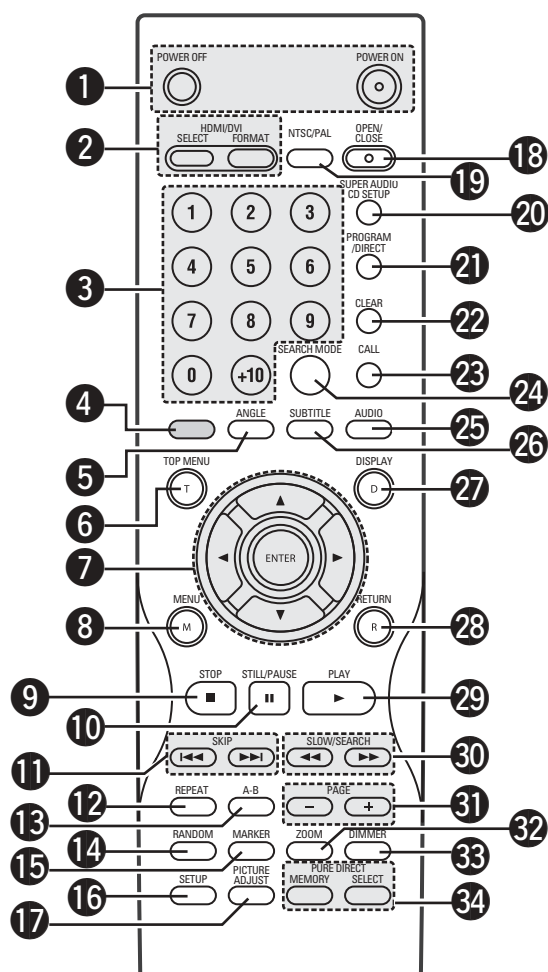

1 POWER ON/POWER OFF buttons

- Press this to switch the power between on and standby.

2 HDMI/DVI SELECT/FORMAT buttons

- Use these to select to use HDMI terminal or DVI terminal, and the format of video signals (480P/576P,720P,1080i).

3 Number buttons

- Use these to input numbers.
- Use the +10 button to input numbers of 10 or over.
- Example: To input 25 → +10 → +10 → 5

4 This button does not function

5 ANGLE button

- Press this to switch the angle.

6 TOP MENU button

- The top menu stored on the disc is displayed.

7 Cursor buttons/ENTER button

- Use the ▲ and ▼ cursor buttons to select in the vertical direction.

Use the ◀ and ▶ cursor buttons to select in the horizontal direction.

Press the ENTER button to select the item selected with the cursor buttons.

8 MENU button

- The DVD menu stored on the disc is displayed.

9 STOP button (■)

10 STILL/PAUSE button (||)

11 SKIP buttons

12 REPEAT button

- Press this to play tracks repeatedly.

13 A-B repeat button (A-B)

- Use this to repeat sections between two specific points.

14 RANDOM button

- Press this to play the tracks on the video or music CD in random order.

15 MARKER button

- Press this to mark places you want to see again.

16 SETUP button

- Press this to display the default setting screen.

17 PICTURE ADJUST button

- Press this to adjust the picture quality to suit your tastes.

18 OPEN/CLOSE button

19 NTSC/PAL button

- Use this to switch the set's video output format (NTSC/PAL).

20 SUPER AUDIO CD SETUP button

21 PROGRAM/DIRECT button

22 CLEAR button

- Press this to clear numbers that you have input.

23 CALL button

- Press this to check the program contents.

24 SEARCH MODE button

- Press this to change the search mode to search for groups or titles, tracks or chapters when selecting sections of discs directly using the number buttons.

25 AUDIO button

- For DVDs, press this to switch the audio language. For video CDs, press this to switch the channel between "STEREO", "MONO LEFT" and "MONO RIGHT".

26 SUBTITLE button

- Press this to switch the DVD's subtitle language.

27 DISPLAY button

- Press this to display the ON-SCREEN.

28 RETURN button

- Press this to return to the previous menu screen.

29 PLAY button (▶)

30 SLOW/SEARCH buttons

31 PAGE -/PAGE + buttons

- Use these to selected the desired still picture on DVD audio discs containing browseable still pictures.

32 ZOOM button

- Press this to enlarge the image.

33 DIMMER button

- Use this to adjust the brightness of the main unit's display. Can be switched in 4 steps, from all off to always on.

34 PURE DIRECT MEMORY/SELECT buttons

- Use these to make and select that various setting to achieve higher quality sound.

7 LOADING DISCS

- Set discs in the disc tray with the labeled (printed) side facing up.

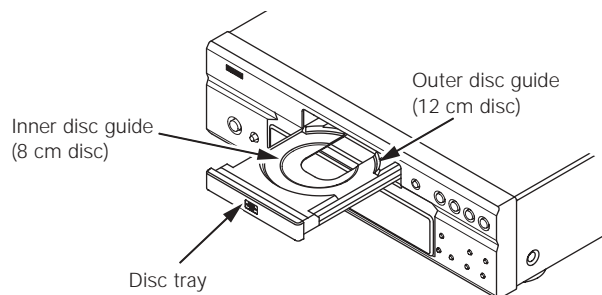

NOTE:

- Do not move the DVD-2910/955 while a disc is playing. Doing so may scratch the disc.

(1) Opening and Closing the Disc Tray

- ① Turn on the power.
- ② Press the OPEN/CLOSE button.

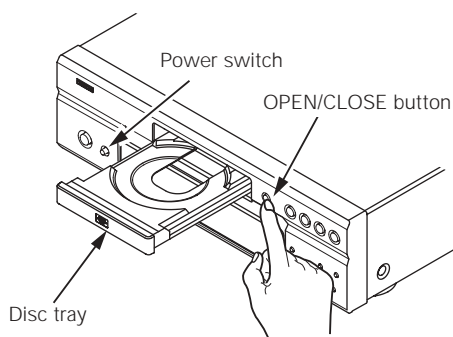

NOTES:

- Be sure to turn on the power before opening and closing the disc tray.
- Do not strike on the button with a pencil, etc.

(2) Loading Discs

- Pick up the disc carefully so as not to touch the signal surface and hold it with the labeled side facing up.
- With the disc tray fully open, set the disc in the disc tray.
- Set 12 cm discs in the outer disc guide (Figure 1), 8 cm discs in the inner disc guide (Figure 2).
- Press the OPEN/CLOSE button. The disc is automatically loaded.
- The disc tray can also be closed automatically to load the disc by pressing the PLAY button.

Figure 1

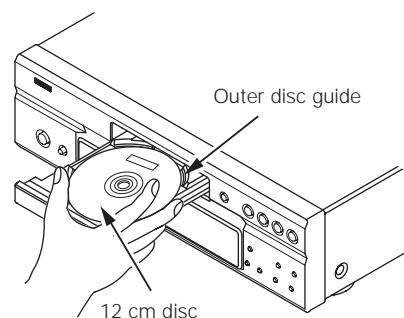
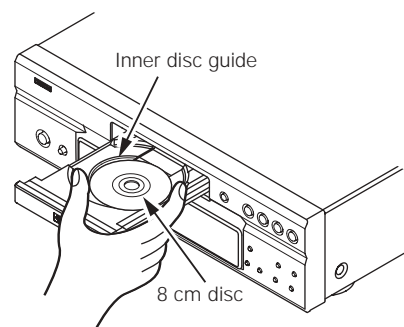

Figure 2



NOTES:

- If a foreign object is caught in the disc tray during closing, simply press the OPEN/CLOSE button again and the tray will open.
- Do not press the disc tray in by hand when the power is off. Doing so will damage it.
- Do not place foreign objects in the disc tray. Doing so will damage it.

8 CHANGING THE DEFAULT SETTINGS

- Make the initial settings to suit your usage conditions before starting playback.
The initial settings are retained until they are next changed, even if the power is turned off.

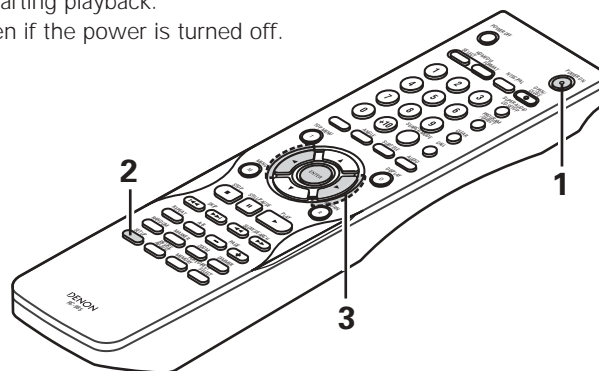
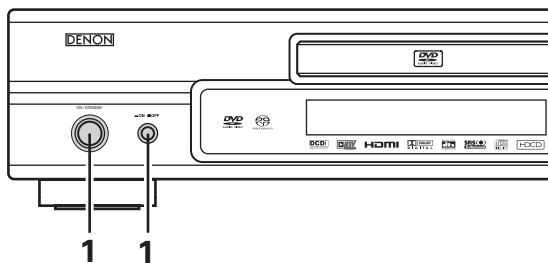

| | | |
|---|---|--|
| <p>1</p> | <p>Turn on the power.</p> <ul style="list-style-type: none"> Press the power button, the power indicator lights green and the power turns on. When pressed again, the power turns off and indicator is off. In the standby mode (the power indicator lights red), press the ON/STANDBY button on the main unit or POWER ON button on the RC-985. | <p>(Green) ON / STANDBY Main unit</p> <p>(Red) ON / STANDBY Main unit</p> <p>POWER ON Remote control unit</p> |
| <p>2</p> | <p>In the stop mode, press the SETUP button.</p> <ul style="list-style-type: none"> The setup (default settings) screen appears. <p>NOTE: For some menus, the initial values can be changed during playback.</p> <p>LANGUAGE SETUP </p> <p>Use this to set the language to be used when playing the disc. If the set language is not offered on that disc, the discs default language is set. And use this to set the language for the default setting screen and messages displayed on the TV screen ("PLAY", etc.).</p> <p>DIGITAL INTERFACE SETUP </p> <p>Use this to set the output of DVI and HDMI terminals.</p> <p>VIDEO SETUP </p> <p>Use this to set the DVD-2910/955's screen mode. (TV aspect and TV type.)</p> <p>AUDIO SETUP </p> <p>Use this to set the DVD-2910/955's audio output mode. (Digital and LPCM output settings.)</p> | <p>RATINGS </p> <p>Use this to disable playback of adult DVDs so that children cannot watch them. Note that playback of adult DVDs cannot be disabled if the rating level is not recorded on the DVD.</p> <p>OTHER SETUP </p> <p>These include special settings such as CAPTIONS, WALL PAPER, etc.,</p> <p>Remote control unit</p> |
| <p>3</p> | <p>Use the ◀ and ▶ cursor buttons to select the desired setting item, then press the ENTER button.</p> <p>Select "LANGUAGE SETUP". (See page 26.) Select "DIGITAL INTERFACE SETUP". (See page 29.) Select "VIDEO SETUP". (See page 32.) Select "AUDIO SETUP". (See page 34.) Select "RATINGS". (See page 39.) Select "OTHER SETUP". (See page 41.)</p> | <p>Remote control unit</p> <p>Remote control unit</p> |
| <p>* To exit the setup mode</p> <p>Use the ▼ cursor button to select "EXIT SETUP", then press the ENTER button. It is also possible to quit by pressing the SETUP button on the remote control unit.</p> | | |

Setup items for use

Bold characters indicate factory defaults.

LANGUAGE SETUP

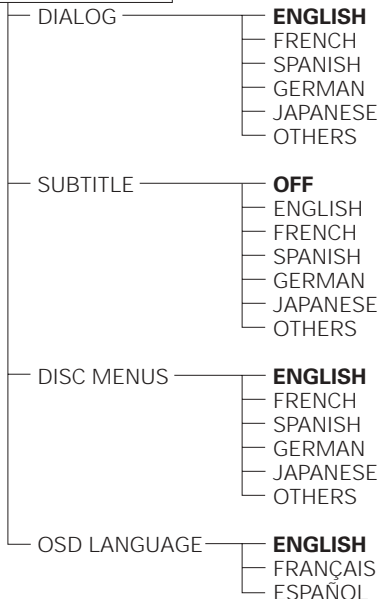

DIGITAL INTERFACE SETUP

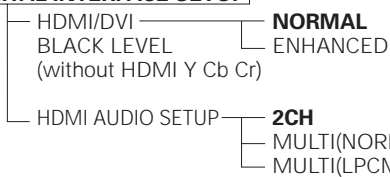

VIDEO SETUP

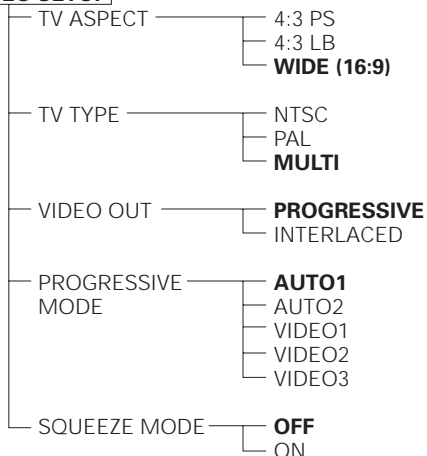

HDMI SPEAKER SETUP

※ The display depends on the connected device.

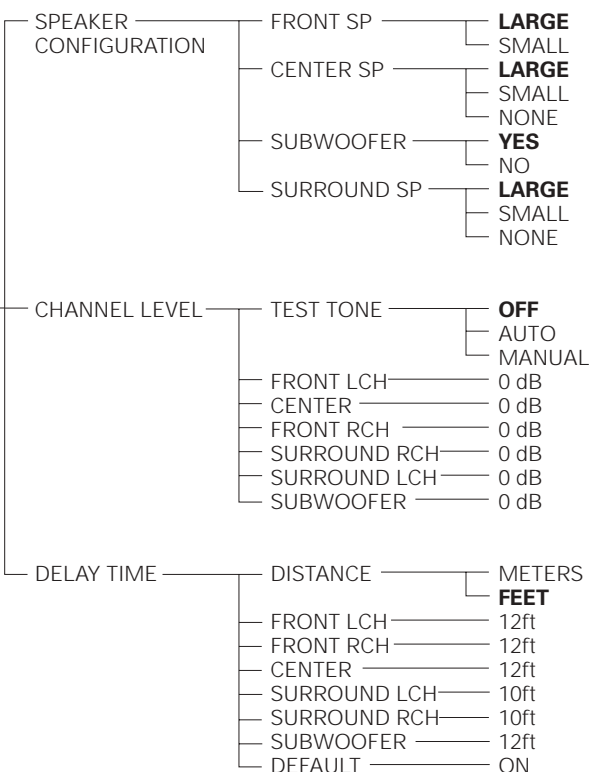

Bold characters indicate factory defaults.

AUDIO SETUP

- AUDIO CHANNEL — **MULTI CHANNEL**
 - 2 CH(SRS OFF)
 - 2 CH(SRS ON)
- DIGITAL OUTPUT — **NORMAL**
 - PCM
- LPCM (44.1 kHz/48 kHz) — **OFF**
 - ON
- SOURCE DIRECT — **OFF**
 - ON
- BASS ENHANCER — **OFF**
 - ON
- COMPRESSION — **OFF**
 - ON
- SACD FILTER — **50Hz**
 - 100kHz

SPEAKER SETUP

- SPEAKER CONFIGURATION
 - FRONT SP — **LARGE**
 - SMALL
 - CENTER SP — **LARGE**
 - SMALL
 - NONE
 - SUBWOOFER — **YES**
 - NO
 - SURROUND SP — **LARGE**
 - SMALL
 - NONE
- CHANNEL LEVEL
 - TEST TONE — **OFF**
 - AUTO
 - MANUAL
 - FRONT LCH — 0 dB
 - CENTER — 0 dB
 - FRONT RCH — 0 dB
 - SURROUND RCH — 0 dB
 - SURROUND LCH — 0 dB
 - SUBWOOFER — 0 dB
 - SW + 10dB — **OFF**
 - ON
- DELAY TIME
 - DISTANCE — METERS
 - FEET**
 - FRONT LCH — 12ft
 - FRONT RCH — 12ft
 - CENTER — 12ft
 - SURROUND LCH — 10ft
 - SURROUND RCH — 10ft
 - SUBWOOFER — 12ft
 - DEFAULT — ON

RATINGS

- RATING LEVEL — 0(LOCK ALL)
 - 1
 - 2
 - 3
 - 4
 - 5
 - 6
 - 7
 - 8(NO LIMIT)**
- PASSWORD — CHANGE
 - OLD PASSWORD
 - NEW PASSWORD
 - COMFIRM PASSWORD

OTHER SETUP

- PLAYER MODE — **AUDIO**
 - VIDEO
- CAPTIONS — **OFF**
 - ON
- WALL PAPER — **BLUE**
 - GRAY
 - BLACK
 - PICTURE
- DISPLAY — **OFF**
 - ON
- AUTO POWER MODE — **OFF**
 - ON
- SLIDE SHOW — **5SEC**
 - (5~15SEC)

When "LANGUAGE SETUP" is selected

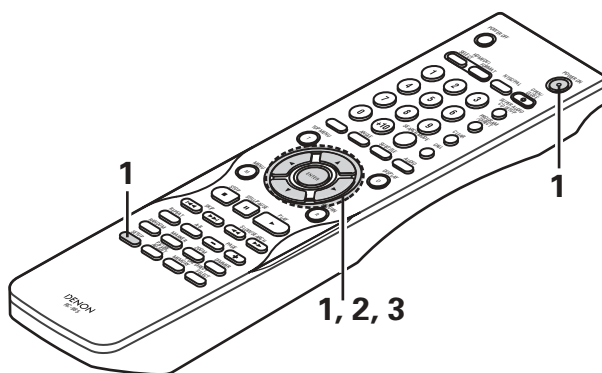

| | | |
|-----------------|---|---|
| <p>1</p> | <p>See page 23.</p> | <p>Remote control unit Remote control unit</p> |
| <p>2</p> | <p>Use the ▲ and ▼ cursor buttons to select the desired setting, then press the ENTER button.</p> <p>DIALOG Use this to set the language of the sound output from the speakers.</p> <p>SUBTITLE Use this to set the language of the subtitles displayed on the TV.</p> <p>DISC MENUS Use this to set the language of the menus recorded on the disc (top menu, etc.).</p> <p>OSD LANGUAGE Use this to set the language for the default setting screen and messages displayed on the TV screen(" PLAY", etc.)</p> | |
| <p>3</p> | <p>Use the ▲ and ▼ cursor buttons to select the desired setting, then press the ENTER button.</p> <p>① When "DIALOG" is selected:</p> <p>ENGLISH (Factory default) Select this when you want to play the DVD with the sound in English.</p> <p>FRENCH Select this when you want to play the DVD with the sound in French.</p> <p>SPANISH Select this when you want to play the DVD with the sound in Spanish.</p> <p>GERMAN Select this when you want to play the DVD with the sound in German.</p> <p>JAPANESE Select this when you want to play the DVD with the sound in Japanese.</p> <p>OTHERS Use the number buttons to input the language number. (See "Language code list" on page 28.)</p> | <p>Remote control unit Remote control unit</p> |

3

② When "SUBTITLE" is selected:

OFF (Factory default)

Select this if you do not want to display the subtitles. (For some discs it is not possible to turn off the subtitle display.)

ENGLISH

Select this when you want to play the DVD with the subtitles in English.

FRENCH

Select this when you want to play the DVD with the subtitles in French.

SPANISH

Select this when you want to play the DVD with the subtitles in Spanish.

GERMAN

Select this when you want to play the DVD with the subtitles in German.

JAPANESE

Select this when you want to play the DVD with the subtitles in Japanese.

OTHERS

Use the number buttons to input the language number.
(See "Language code list" on page 28.)

③ When "DISC MENUS" is selected:

ENGLISH (Factory default)

Select this when you want to display the menus in English.

FRENCH

Select this when you want to display the menus in French.

SPANISH

Select this when you want to display the menus in Spanish.

GERMAN

Select this when you want to display the menus in German.

JAPANESE

Select this when you want to display the menus in Japanese.

OTHERS

Use the number buttons to input the language number.
(See "Language code list" on page 28.)

④ When "OSD LANGUAGE" is selected:

ENGLISH (Factory default)

Select this to set the OSD language to English.

FRANÇAIS

Select this to set the OSD language to French.

ESPAÑOL

Select this to set the OSD language to Spanish.

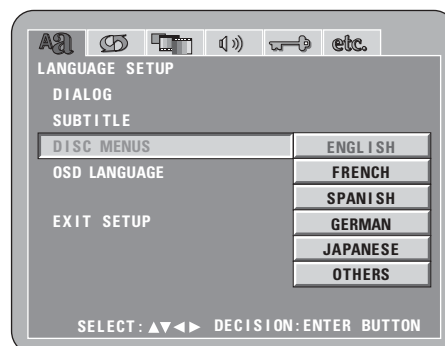
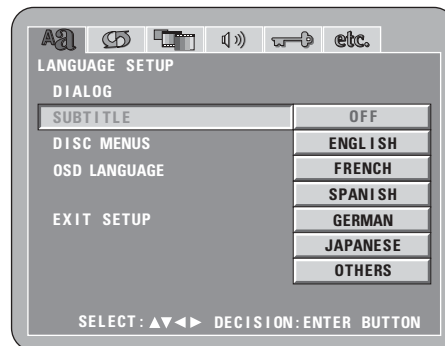

*** To exit the setup mode**

Use the ▼ cursor button to select "EXIT SETUP", then press the ENTER button. It is also possible to quit by pressing the SETUP button on the remote control unit.

Language code list

| Code | Language | Code | Language | Code | Language | Code | Language |
|------|-----------------|------|--------------|------|------------------|------|------------|
| 6565 | Afar | 7079 | Faroese | 7678 | Lingala | 8375 | Slovak |
| 6566 | Abkhazian | 7082 | French | 7679 | Laothian | 8376 | Slovenian |
| 6570 | Afrikaans | 7089 | Frisian | 7684 | Lithuanian | 8377 | Samoan |
| 6577 | Ameharic | 7165 | Irish | 7686 | Latvian, Lettish | 8378 | Shona |
| 6582 | Arabic | 7168 | Scots Gaelic | 7771 | Malagasy | 8379 | Somali |
| 6583 | Assamese | 7176 | Galician | 7773 | Maori | 8381 | Albanian |
| 6588 | Aymara | 7178 | Guarani | 7775 | Macedonish | 8382 | Serbian |
| 6590 | Azerbaijani | 7185 | Gujarati | 7776 | Malayalam | 8385 | Sundanese |
| 6665 | Bashkir | 7265 | Hausa | 7778 | Mongolian | 8386 | Swedish |
| 6669 | Byelorussian | 7273 | Hindi | 7779 | Moldavian | 8387 | Swahili |
| 6671 | Bulgarian | 7282 | Croatian | 7782 | Marathi | 8465 | Tamil |
| 6672 | Bihari | 7285 | Hungarian | 7783 | Malay | 8469 | Telugu |
| 6678 | Bengali; Bangla | 7289 | Armenian | 7784 | Maltese | 8471 | Tajik |
| 6679 | Tibetan | 7365 | Interlingua | 7789 | Burmese | 8472 | Thai |
| 6682 | Breton | 7378 | Indonesian | 7865 | Nauru | 8473 | Tigrinya |
| 6765 | Catalan | 7383 | Icelandic | 7869 | Nepali | 8475 | Turkmen |
| 6779 | Corsican | 7384 | Italian | 7876 | Dutch | 8476 | Tagalog |
| 6783 | Czech | 7387 | Hebrew | 7879 | Norwegian | 8479 | Tonga |
| 6789 | Welsh | 7465 | Japanese | 7982 | Oriya | 8482 | Turkish |
| 6865 | Danish | 7473 | Yiddish | 8065 | Panjabi | 8484 | Tatar |
| 6869 | German | 7487 | Javanese | 8076 | Polish | 8487 | Twi |
| 6890 | Bhutani | 7565 | Georgian | 8083 | Pashto, Pushto | 8575 | Ukrainian |
| 6976 | Greek | 7575 | Kazakh | 8084 | Portuguese | 8582 | Urdu |
| 6978 | English | 7576 | Greenlandic | 8185 | Quechua | 8590 | Uzbek |
| 6979 | Esperanto | 7577 | Cambodian | 8277 | Rhaeto-Romance | 8673 | Vietnamese |
| 6983 | Spanish | 7578 | Kannada | 8279 | Romanian | 8679 | Volapük |
| 6984 | Estonian | 7579 | Korean | 8285 | Russian | 8779 | Wolof |
| 6985 | Basque | 7583 | Kashmiri | 8365 | Sanskrit | 8872 | Xhosa |
| 7065 | Persian | 7585 | Kurdish | 8368 | Sindhi | 8979 | Yoruba |
| 7073 | Finnish | 7589 | Kirghiz | 8372 | Serbo-Croatian | 9072 | Chinese |
| 7074 | Fiji | 7665 | Latin | 8373 | Singhalese | 9085 | Zulu |

When "DIGITAL INTERFACE SETUP" is selected

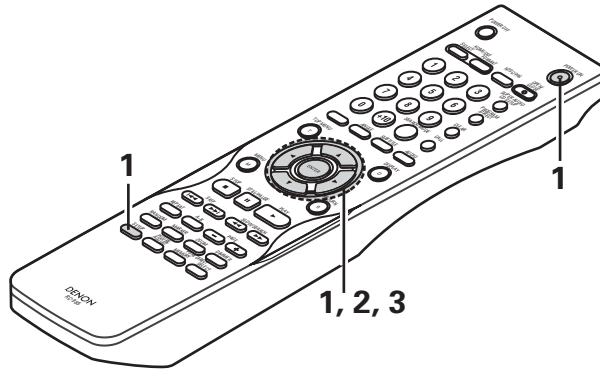

| | | |
|-----------------|--|---|
| <p>1</p> | <p>See page 23.</p> | <div data-bbox="1003 640 1448 987"> </div> <div data-bbox="1003 1017 1448 1259"> <p>Remote control unit Remote control unit</p> </div> |
| <p>2</p> | <p>Use the ▲ and ▼ cursor buttons to select the desired setting, then press the ENTER button.</p> <p>HDMI/DVI BLACK LEVEL Switches the digital RGB video level (data range) of the HDMI and the DVI-D terminals.</p> <p>HDMI AUDIO SETUP Use this to adjust for the audio signals from the HDMI terminal.</p> | |
| <p>3</p> | <p>Use the ▲ and ▼ cursor buttons to select the desired setting, then press the ENTER button.</p> <p>① When "HDMI/DVI BLACK LEVEL" is selected:</p> <p>NORMAL (Factory default) Signals are output from the HDMI and the DVI-D terminals with a digital RGB video level (data range) of 16(black) to 235(white).</p> <p>ENHANCED Signals are output from the HDMI and the DVI-D terminals with a digital RGB video level (data range) of 0(black) to 246(white). *When the HDMI and the DVI-D terminals are connected, the black may seem to stand out, depending on the TV or the Monitor you are using. In this case, set this to "ENHANCED". *When select "HDMI Y Cb Cr" under "HDMI/DVI SELECT", will have no effect. (See page 49.)</p> | <div data-bbox="1003 1455 1448 1802"> </div> |

3

② When "HDMI AUDIO SETUP" is selected:

2CH (Channel) (Factory default)

The audio signals are output from the HDMI terminal with a down-mixed to 2 channel.

MULTI(NORMAL)

The multi-channel audio signals are output from the HDMI terminal with a bit-stream.

MULTI(LPCM)

The multi-channel audio signals are output from the HDMI terminal with a linear PCM.

Ⓞ When "MULTI (LPCM)" is selected, use the ▲ and ▼ cursor buttons to select the item to be set, then press the ENTER button.

SPEAKER CONFIGURATION

Use this to select the types of the different speakers.

CHANNEL LEVEL

Use this to adjust the output level of the different speakers.

DELAY TIME

Use this to set the distance from the different speakers to the listening position.

* To exit the HDMI SPEAKER SETUP mode.

Use the ▼ cursor button to select "DIGITAL INTERFACE SETUP" then press ENTER button.

Ⓞ When "SPEAKER CONFIGURATION" is selected, use the ▲ and ▼ cursor buttons to select the speaker to be set then press the ENTER button.

- The type of speaker used for the front speakers, center speaker, subwoofer and surround speakers can be set. Use the ▲ and ▼ cursor buttons to select the speaker type, then press the ENTER button.

LARGE

Select this when a large speaker is connected.

SMALL

Select this when a small speaker is connected.

NONE

Select this when no speaker is connected.

YES

Select this when a subwoofer is connected.

NO

Select this when no subwoofer is connected.

* Press the RETURN button to return to the "HDMI SPEAKER SETUP" menu.

Ⓞ When "CHANNEL LEVEL" is selected, use the ▲ and ▼ cursor buttons to select the speaker to be adjusted, then use the ◀ and ▶ cursor buttons to set the level.

TEST TONE

- Use the ◀ and ▶ cursor buttons to select auto or manual. Adjust so that the volume of the test tones output from the different speakers sounds the same.
- The volume level output from the front speakers (left and right channels), center speaker, surround speakers (left and right channels) and subwoofer can be adjusted.
- The volume level can be adjusted between 0 and -10 dB in steps of 1 dB.
- * Press the RETURN button to return to the "HDMI SPEAKER SETUP" menu.

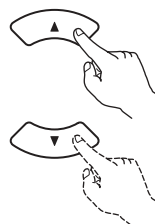
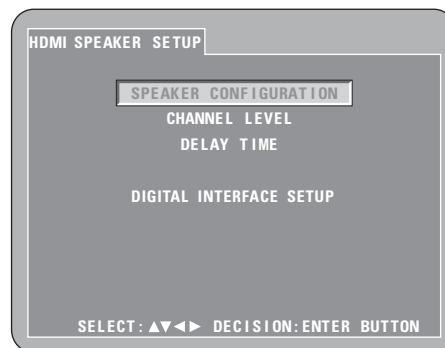

Remote control unit



Remote control unit

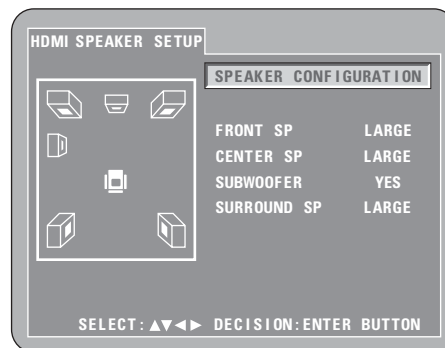

* The display depends on the connected device. (Indicates whether or not speakers are connected)

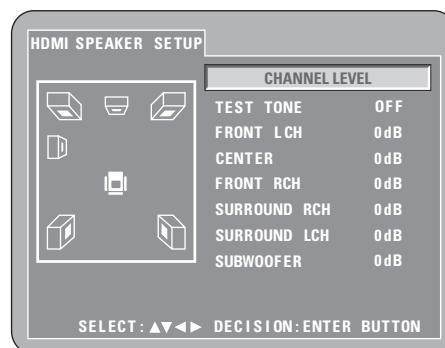

3

© When "DELAY TIME" is selected:

With 5.1-channel surround sound, ideally the distance between the listening position and all the speakers aside from the subwoofer should be the same. The delay time setting can be used to make the sound from the different speakers reach the listening position at the same time.

Use the ▲ and ▼ cursor buttons to select the setting item, then press the ENTER button.

© When "DISTANCE" is selected:

METERS (when the ◀ cursor button is pressed):

The unit of distance is set to meters ("m").

FEET (when the ▶ cursor button is pressed):

The unit of distance is set to feet ("ft").

© When "FRONT LCH", "FRONT RCH", "CENTER", "SURROUND LCH", "SURROUND RCH", "SUBWOOFER" is selected:

Use the ◀ and ▶ cursor buttons to set the distance from the listening position to the different speakers.

* The distance can be set within the range of 0 to 60 feet (18 meters).

* The maximum difference in speaker distance for which adjustment is possible is 15 feet (4.5 meters).

© When "DEFAULT" is selected:

When "DEFAULT" is selected and the ENTER button is pressed, all the items are restored to their factory default settings.

* When digital connections are made with an AV amplifier, make the speaker settings on the AV amplifier.

For DVD audio discs, the disc's settings are given priority, so the sound may not be produced as set with the above speaker mode setting.

* Press the RETURN button to return to the "HDMI SPEAKER SETUP" menu.

* When the HDMI connection cable is disconnected, the "SPEAKER CONFIGURATION", "CHANNEL LEVEL", and "DELAY TIME" settings under "HDMI SPEAKER SETUP" are stored.

* **To exit the setup mode**

Use the ▼ cursor button to select "EXIT SETUP", then press the ENTER button. It is also possible to quit by pressing the SETUP button on the remote control unit.

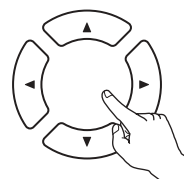

Remote control unit



Remote control unit

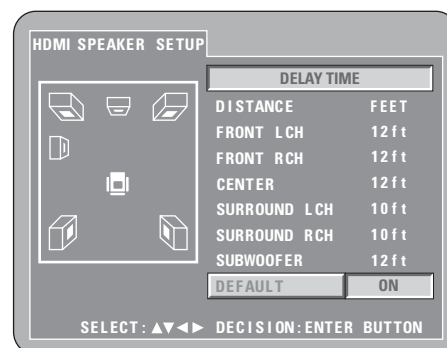
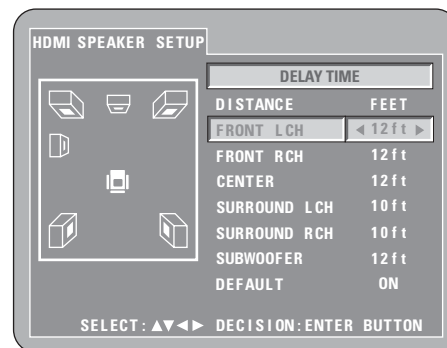
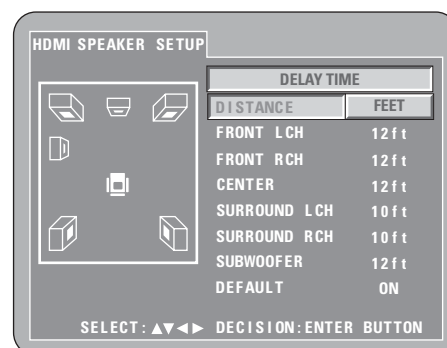
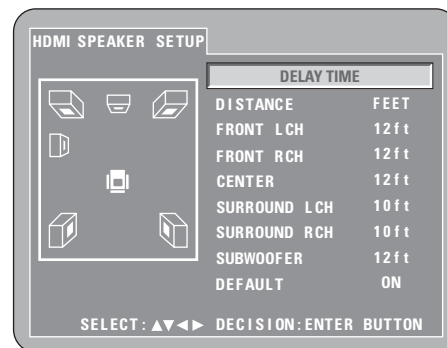

When "VIDEO SETUP" is selected

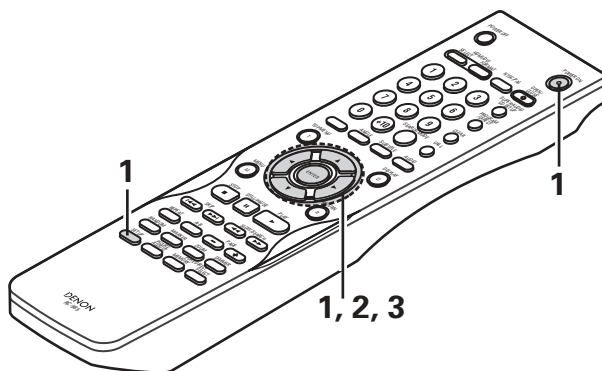

| | | |
|-----------------|--|---|
| <p>1</p> | <p>See page 23.</p> | |
| <p>2</p> | <p>Use the ▲ and ▼ cursor buttons to select the desired setting, then press the ENTER button.</p> <p>TV ASPECT Use this to set the shape of your TV's screen.</p> <p>TV TYPE Use this to set your TV's video format (NTSC, PAL or MULTI).</p> <p>VIDEO OUT Use this to select either the progressive image output or interlace image output.</p> <p>PROGRESSIVE MODE A method of progressive conversion can be set depending on the image recorded to the DVD.</p> <p>SQUEEZE MODE The size of the screen to be output can be switched.</p> | <p>Remote control unit Remote control unit</p> |
| <p>3</p> | <p>Use the ▲ and ▼ cursor buttons to select the desired setting, then press the ENTER button.</p> <p>① When "TV ASPECT" is selected:</p> <p>4:3 PS Select this to play wide DVDs in the pan & scan mode (with the sides of the picture cut off). Discs for which pan & scan is not specified are played in the letter box mode.</p> <p>4:3 LB Select this to play wide DVDs in the letter box mode (with black strips at the top and bottom).</p> <p>WIDE (16:9) (Factory default) Select this to play wide DVDs in the full-screen mode.</p> | <p>Remote control unit Remote control unit</p> |

3

② When "TV TYPE" is selected:

NTSC

Select this when your TV's video format is NTSC. If NTSC is selected, output format is fixed to NTSC.

PAL

Select this when your TV's video format is PAL. If PAL is selected, output format is fixed to PAL.

MULTI (Factory default)

Select this when your TV is compatible with both the NTSC and PAL formats.

NTSC signals are output from the video output jacks when discs recorded in NTSC format are played, and PAL signals are output from the video output jacks when discs recorded in PAL format are played.

③ When "VIDEO OUT" is selected: (NOTES)

PROGRESSIVE (Factory default)

Select this when using the DVD-2910/955 connected to a progressive type TV.

INTERLACED

Select this when using the DVD-2910/955 connected to an interlace type TV.

NOTE:

- For the component output only, it is possible to switch between interlace image output and progressive image output. It is not possible to specify progressive image output for the Video output connector or S-Video output connector.

④ When "PROGRESSIVE MODE" is selected:

AUTO 1 (Factory default)

Select this when the image recorded to the DVD is film material.

AUTO 2

Select this when the image recorded to the DVD is 30-frame film material.

VIDEO 1 TO 3

Select this when the image recorded to the DVD is video material.

VIDEO 1

Select this for regular video material.

VIDEO 2

Select this for video material having little movement.

VIDEO 3

Select this for video material having a lot of movement.

⑤ When "SQUEEZE MODE" is selected:

OFF (Factory default)

Select this to display without changing the screen size.



TV

ON

Select this when playing back a 4:3 image that you wish to display at 4:3 aspect ratio at the center of a 16:9 TV.



TV

* Only effective for set to "WIDE (16:9)" at "TV ASPECT".

(See page 32.)

* No effective for interlaced image.

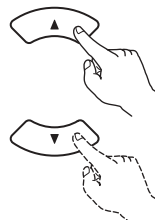

Remote control unit



Remote control unit

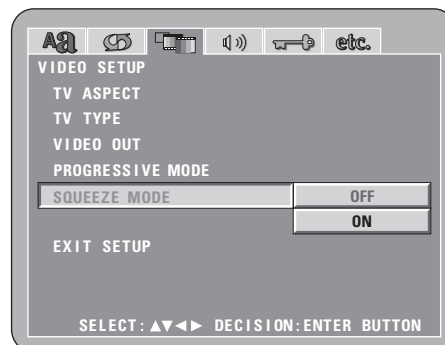
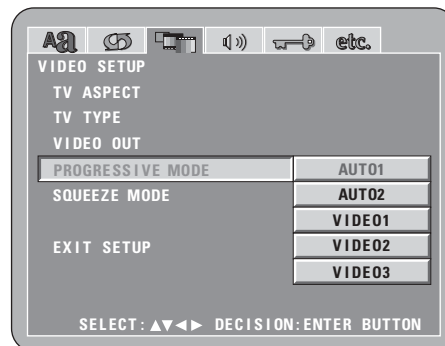
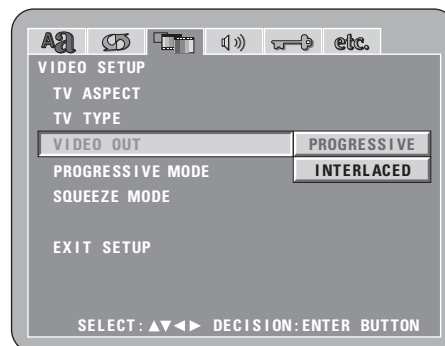
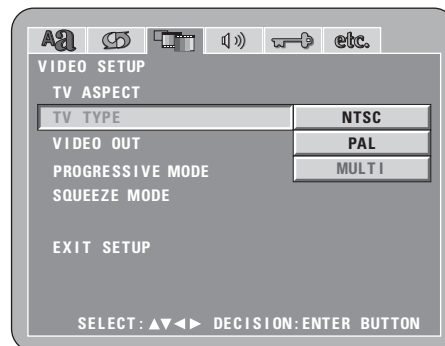

*** To exit the setup mode**

Use the ▼ cursor button to select "EXIT SETUP", then press the ENTER button. It is also possible to quit by pressing the SETUP button on the remote control unit.

When "AUDIO SETUP" is selected

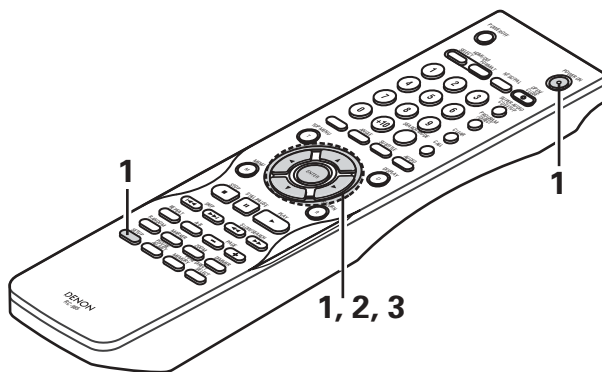

| | | |
|-----------------|---|---|
| <p>1</p> | <p>See page 23.</p> | |
| <p>2</p> | <p>Use the ▲ and ▼ cursor buttons to select the desired setting, then press the ENTER button.</p> <p>AUDIO CHANNEL Use this to adjust for the connected speaker systems.</p> <p>DIGITAL OUTPUT Use this to select the digital output's signal format.</p> <p>LPCM (44.1 kHz/48 kHz) Use this to set the digital audio output when playing DVDs recorded in linear PCM audio.</p> <p>SOURCE DIRECT This permits a setting to output the audio without adding speaker settings or channel level processing to the audio signals of DVD audio or Super Audio CD.</p> <p>BASS ENHANCER Set whether or not to output audio signals from the subwoofer when playing two-channel audio signals. * The BASS ENHANCER settings do not apply to digital outputs.</p> <p>COMPRESSION Use this to set the dynamic range output when playing discs.</p> <p>SACD FILTER The low pass filter value when playing Super Audio CDs can be set.</p> | <p>Remote control unit Remote control unit</p> |
| <p>3</p> | <p>Use the ▲ and ▼ cursor buttons to select the desired setting, then press the ENTER button.</p> <p>① When "AUDIO CHANNEL" is selected:</p> <p>⊙ Use the ▲ and ▼ cursor buttons to select the item to be set, then press the ENTER button.</p> <p>MULTI CHANNEL (Factory default) Select this for systems in which three or more speakers are connected.</p> <p>When MULTI CHANNEL is set, the speaker settings (SPEAKER CONFIGURATION), speaker output level adjustment (CHANNEL LEVEL) and speaker distances (DELAY TIME) can be set.</p> <p>2CH(SRS OFF) Select this does not use to the SRS TruSurround function for systems in which only two speakers are connected.</p> <p>2CH(SRS ON) (See page 36.) Select this use to the SRS TruSurround function for systems in which only two speakers are connected. The indicator "●" in the display lights at this mode.</p> | <p>Remote control unit Remote control unit</p> |

3

© When "MULTI CHANNEL" is selected, use the ▲ and ▼ cursor buttons to select the item to be set, then press the ENTER button.

SPEAKER CONFIGURATION

Use this to select the types of the different speakers.

CHANNEL LEVEL

Use this to adjust the output level of the different speakers.

DELAY TIME

Use this to set the distance from the different speakers to the listening position.

* To exit the SPEAKER SETUP mode

Use the ▼ cursor button to select "AUDIO SETUP" then press ENTER button.

* The SPEAKER CONFIGURATION settings only apply to analog outputs.

© When "SPEAKER CONFIGURATION" is selected, use the ▲ and ▼ cursor buttons to select the speaker to be set then press the ENTER button.

• The type of speaker used for the front speakers, center speaker, subwoofer and surround speakers can be set. Use the ▲ and ▼ cursor buttons to select the speaker type, then press the ENTER button.

LARGE

Select this when a large speaker is connected.

SMALL

Select this when a small speaker is connected.

NONE

Select this when no speaker is connected.

YES

Select this when a subwoofer is connected.

NO

Select this when no subwoofer is connected.

* Press the RETURN button to return to the "SPEAKER SETUP" menu.

© When "CHANNEL LEVEL" is selected, use the ▲ and ▼ cursor buttons to select the speaker to be adjusted, then use the ◀ and ▶ cursor buttons to set the level.

TEST TONE

• Use the ◀ and ▶ cursor buttons to select auto or manual.

Adjust so that the volume of the test tones output from the different speakers sounds the same.

• The volume level output from the front speakers (left and right channels), center speaker, surround speakers (left and right channels) and subwoofer can be adjusted.

• The volume level can be adjusted between 0 and -10 dB in steps of 1 dB.

• Settings SW + 10 dB to "ON" increases by 10 dB the volume level that is output from the subwoofer.

* Press the RETURN button to return to the "SPEAKER SETUP" menu.

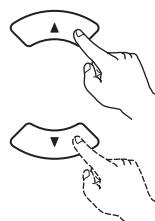

Remote control unit



Remote control unit

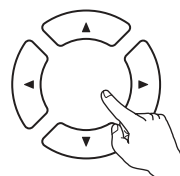
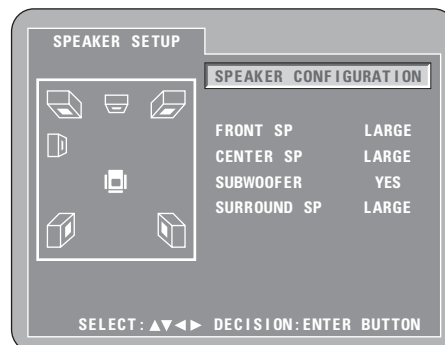

Remote control unit

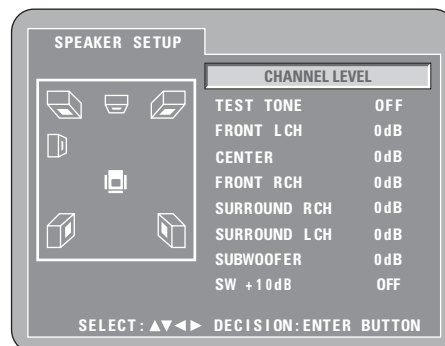

© When "DELAY TIME" is selected:

With 5.1-channel surround sound, ideally the distance between the listening position and all the speakers aside from the subwoofer should be the same. The delay time setting can be used to make the sound from the different speakers reach the listening position at the same time.

Use the ▲ and ▼ cursor buttons to select the setting item, then press the ENTER button.

• When "DISTANCE" is selected:

METERS (when the ◀ cursor button is pressed):

The unit of distance is set to meters ("m").

FEET (when the ▶ cursor button is pressed):

The unit of distance is set to feet ("ft").

• When "FRONT LCH", "FRONT RCH", "CENTER", "SURROUND LCH", "SURROUND RCH", "SUBWOOFER" is selected:

Use the ◀ and ▶ cursor buttons to set the distance from the listening position to the different speakers.

* The distance can be set within the range of 0 to 60 feet (18 meters).

* The maximum difference in speaker distance for which adjustment is possible is 15 feet (4.5 meters).

• When "DEFAULT" is selected:

When "DEFAULT" is selected and the ENTER button is pressed, all the items are restored to their factory default settings.

* When digital connections are made with an AV amplifier, make the speaker settings on the AV amplifier.

For DVD audio discs, the disc's settings are given priority, so the sound may not be produced as set with the above speaker mode setting.

* Press the RETURN button to return to the "SPEAKER SETUP" menu.

The SRS TruSurround function (only for DVD-videos and Video CDs)

■ The multi-channel sound normally achieved with five speakers is recreated using only the two front stereo speakers. This results in a sound with a nearly natural sense of movement that seems to surround the head, without the strong directivity characteristic of multi-speaker systems.

NOTES:

- This function only works with DVD-videos and video CDs only.
- Note that for some discs the effect will be weak or there will be no effect.
- Turn off other surround functions (the TV's surround mode, etc.).

*  is a trademark of SRS Labs, Inc. TruSurround technology is incorporated under license from SRS Labs, Inc.

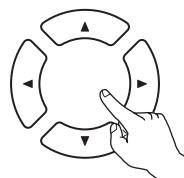

Remote control unit



Remote control unit

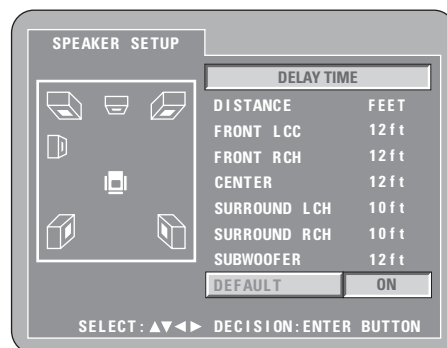
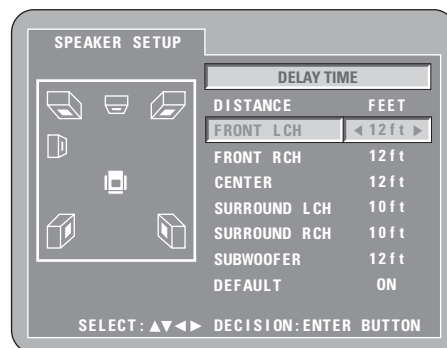
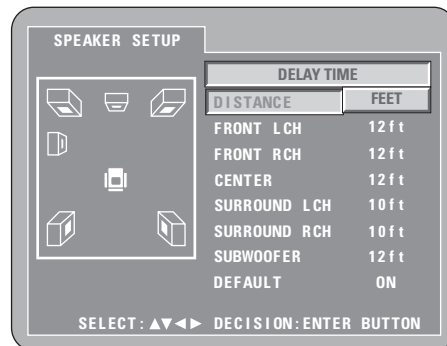
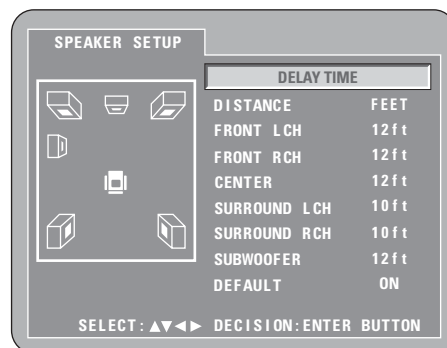

3

- ② When "DIGITAL OUTPUT" is selected:

NORMAL (Factory default)

When playing DVDs recorded in Dolby Digital or DTS, bitstream signals are output from the digital audio output terminals. When playing DVDs recorded in linear PCM or packed PCM, linear PCM signals are output. Select "NORMAL" when making digital connections to an AV amplifier with built-in Dolby Digital and DTS decoder.

PCM

When playing Dolby Digital/DTS bitstream signals or DVDs recorded in linear PCM or packed PCM, the signals are converted into 48 kHz/16-bit PCM (2-channel) signals and output from the digital outputs. When playing DVDs recorded in PCM, linear PCM signals are output.

- ③ When "LPCM (44.1 kHz/ 48 kHz)" is selected:

OFF (Factory default)

When playing linear PCM or packed PCM DVDs that are not copyright-protected, for 2-channel PCM audio signals up to 96 kHz, linear PCM signals are output as such without being converted from the digital outputs. (176.2 kHz and 192 kHz signals are converted to 88.2 kHz and 96 kHz, respectively.)

For DVDs containing multi-channel PCM signals, the digital signals are down-mixed for output into two channels, front left and right. (Only the front left and right channels are output for sources for which down-mixing is prohibited.)

When playing copyright-protected linear PCM or packed PCM DVDs, in consideration of copyrights, no digital signals are output for sources exceeding 48 kHz/16 bits. When playing such sources, either set to "ON" or make analog connections. (See page 14.)

ON

Linear PCM and packed PCM signals are converted to 44.1 kHz or 48 kHz and output. (The PCM digital audio output signals are converted to 48 kHz or less in consideration of copyrights.) When making digital connections to an AV amplifier that is not compatible with 96 kHz/88.2 kHz signals, set to "ON".

- ④ When "SOURCE DIRECT" is selected:

OFF (Factory default)

Please set to OFF when performing speaker settings or setting the delay time and playing back.

ON

Set to ON when playing back without performing the processing of speaker settings. Performing this setting will result in the setting of the DTS recommended all-channel, full bandwidth playback. (Note that the volume of the sub woofer will increase by 5 dB, and there will be an increase of 15 dB with a Super Audio CD.) This is also set when playing back a 6-channel source of DVD audio that has been recorded with all channels and full bandwidth. When set to "ON", the speaker size will be set to "Large" for all speakers and the sub woofer will be set to "Yes". When playing back software such as this, perform the analog connections according to the software instruction manual.

- ⑤ When "BASS ENHANCER" is selected:

OFF (Factory default)

No sound is produced from the subwoofer.

ON

Sound is produced from the subwoofer.

In the case, set the subwoofer to "YES" at the speaker settings.

* This works only with analog audio output.

* This mode does not work, at "SOURCE DIRECT" is on.

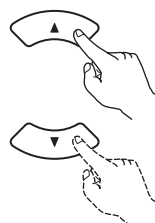

Remote control unit



Remote control unit

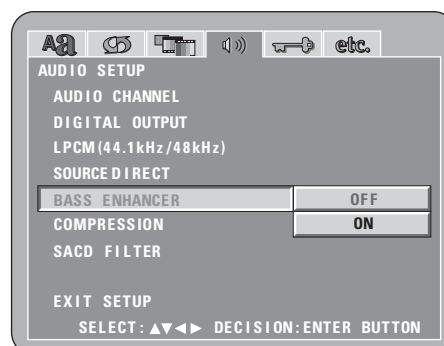
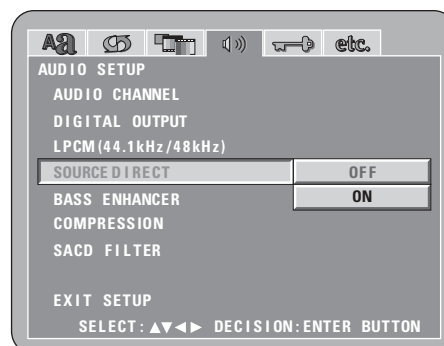
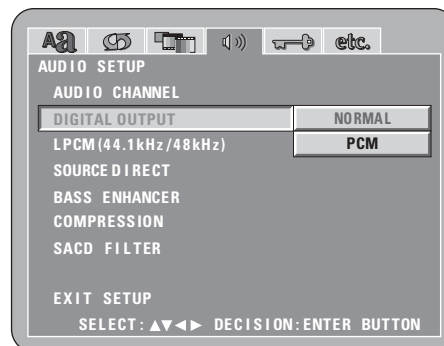

3

⑥ When "COMPRESSION" is selected:

OFF (Factory default)

Select this for the standard range.

ON

Select this to achieve powerful sound even when the volume is low. This setting is suited for watching DVDs late at night with the volume low.(This setting is only valid for DVDs recorder in Dolby Digital.)

⑦ When "SACD (Super Audio CD) FILTER" is selected:

50kHz (Factory default)

When playing Super Audio CDs, high frequencies of 50kHz and higher are cut.

100kHz

When playing Super Audio CDs, high frequencies of 100kHz and higher are cut.

* Set to 100kHz when a high frequency compatible AV amplifier is connected.

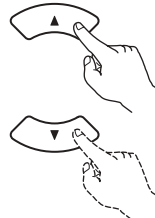

Remote control unit



Remote control unit

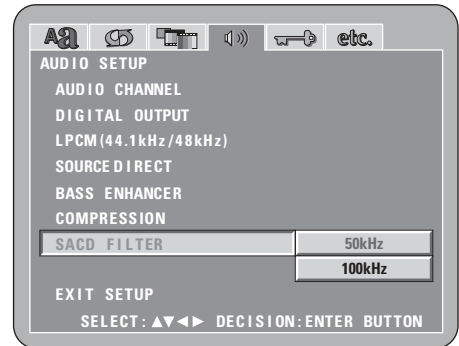
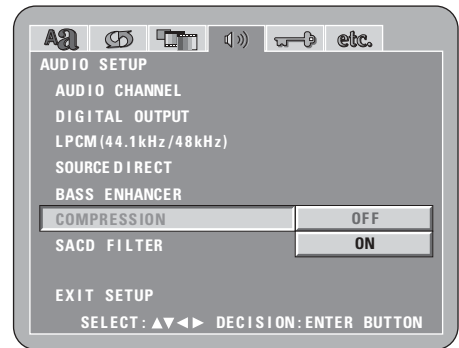

*** To exit the setup mode**

Use the ▼ cursor button to select "EXIT SETUP", then press the ENTER button. It is also possible to quit by pressing the SETUP button on the remote control unit.

When "RATINGS" is selected

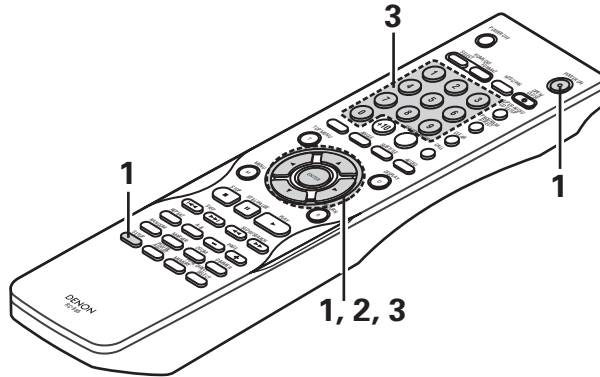

| | | |
|-----------------|---|---|
| <p>1</p> | <p>See page 23.</p> | |
| <p>2</p> | <p>Use the ▲ and ▼ cursor buttons to select the desired setting, then press the ENTER button.</p> <p>RATING LEVEL Use this to restrict playback of adult DVDs you do not want children to view. Note that even with adult DVDs, viewing cannot be restricted unless the restriction level is recorded on the disc.</p> <p>PASSWORD Use this to change the password. The default password is "0000".</p> | <p>Remote control unit</p> <p>Remote control unit</p> |
| <p>3</p> | <p>Use the ▲ and ▼ cursor buttons to select the desired setting, then press the ENTER button.</p> <p>① When "RATING LEVEL" is selected:</p> <p>0 (LOCK ALL) Select this to disable playback of all DVDs. Use this for example to disable playback of adult DVDs on which the rating level is not recorded.</p> <p>1 Select this to play only DVDs for children. (Adult and general audience DVDs cannot be played.)</p> <p>2 to 7 Select this to play DVDs for general audiences and children. Adult DVDs cannot be played.</p> <p>8 (NO LIMIT) (Factory default) Select this to play all DVDs.</p> | <p>Remote control unit</p> <p>Remote control unit</p> |

3

Use the number buttons to input a 4-digit password, then press the ENTER button.
 * The default password is "0000".
 * Do not forget the password.
 * The setting cannot be changed without inputting the correct password.

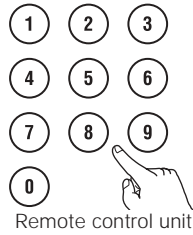

Remote control unit

② When "PASSWORD" is selected:
 Use the ► cursor button to select the "CHANGE", then press the ENTER button.



Remote control unit

Use the number buttons to input a old (current) 4-digit password.
 * The default password is "0000".

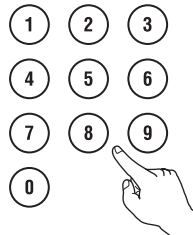

Remote control unit

Use the number buttons to input a new 4-digit password.

Use the number buttons to input a new 4-digit password again. (for the confirmation.)
 Then press the ENTER button.
 * Do not forget the password. (See page 73.)
 * The setting cannot be changed without inputting the correct password.



Remote control unit





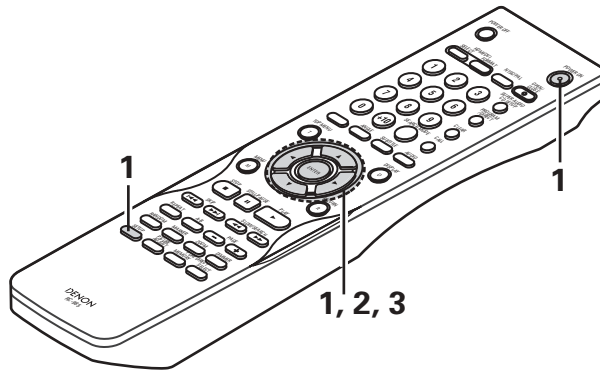

*** To exit the setup mode**

Use the ▼ cursor button to select "EXIT SETUP", then press the ENTER button. It is also possible to quit by pressing the SETUP button on the remote control unit.

When "OTHER SETUP" is selected



| | | | | | | | | | | | | | | |
|-----------------|--|--|-------------|-------|----------|-------|------------|------|---------|-----|-----------------|-----|------------|------|
| <p>1</p> | <p>See page 23.</p> | <div style="display: flex; justify-content: space-around;">   </div> <p>Remote control unit Remote control unit</p> <div style="border: 1px solid gray; padding: 5px; margin: 10px 0;"> <p>AQ etc.</p> <p>OTHER SETUP</p> <table style="width: 100%; border-collapse: collapse;"> <tr> <td style="width: 50%;">PLAYER MODE</td> <td style="width: 50%;">AUDIO</td> </tr> <tr> <td>CAPTIONS</td> <td>OFF</td> </tr> <tr> <td>WALL PAPER</td> <td>BLUE</td> </tr> <tr> <td>DISPLAY</td> <td>OFF</td> </tr> <tr> <td>AUTO POWER MODE</td> <td>OFF</td> </tr> <tr> <td>SLIDE SHOW</td> <td>5SEC</td> </tr> </table> <p>EXIT SETUP</p> <p style="text-align: center;">SELECT: ▲▼◀▶ DECISION: ENTER BUTTON</p> </div> | PLAYER MODE | AUDIO | CAPTIONS | OFF | WALL PAPER | BLUE | DISPLAY | OFF | AUTO POWER MODE | OFF | SLIDE SHOW | 5SEC |
| PLAYER MODE | AUDIO | | | | | | | | | | | | | |
| CAPTIONS | OFF | | | | | | | | | | | | | |
| WALL PAPER | BLUE | | | | | | | | | | | | | |
| DISPLAY | OFF | | | | | | | | | | | | | |
| AUTO POWER MODE | OFF | | | | | | | | | | | | | |
| SLIDE SHOW | 5SEC | | | | | | | | | | | | | |
| <p>2</p> | <p>Use the ▲ and ▼ cursor buttons to select the desired setting, then press the ENTER button.</p> <p>PLAYER MODE The DVD video play mode can be set to play the DVD video contents included on a DVD audio disc.</p> <p>CAPTIONS Use this to set whether or not to display the closed captions recorded on DVDs.</p> <p>WALL PAPER Use this to select the image to be shown on the screen in the stop mode and CD play mode.</p> <p>DISPLAY The setting of whether or not there will be an indication on the display of this unit only for the 2 seconds immediately following the operation, even while the display has been off.</p> <p>AUTO POWER MODE To save power, DCD-2910/955's can automatically be set to the standby mode when it is not used for long periods of time.</p> <p>SLIDE SHOW The time interval for switching to the next still picture when playing slide shows of still pictures (in JPEG format) can be set.</p> | | | | | | | | | | | | | |
| <p>3</p> | <p>Use the ▲ and ▼ cursor buttons to select the desired setting, then press the ENTER button.</p> <p>① When "PLAYER MODE" is selected: AUDIO (Factory default) Set this to play the DVD audio signals as such. VIDEO Set this to play the DVD video contents included on a DVD audio disc.</p> | <div style="display: flex; justify-content: space-around;">   </div> <p>Remote control unit Remote control unit</p> <div style="border: 1px solid gray; padding: 5px; margin: 10px 0;"> <p>AQ etc.</p> <p>OTHER SETUP</p> <table style="width: 100%; border-collapse: collapse;"> <tr> <td style="width: 50%; border: 1px solid gray;">PLAYER MODE</td> <td style="width: 50%; border: 1px solid gray;">AUDIO</td> </tr> <tr> <td>CAPTIONS</td> <td style="border: 1px solid gray;">VIDEO</td> </tr> <tr> <td>WALL PAPER</td> <td></td> </tr> <tr> <td>DISPLAY</td> <td></td> </tr> <tr> <td>AUTO POWER MODE</td> <td></td> </tr> <tr> <td>SLIDE SHOW</td> <td></td> </tr> </table> <p>EXIT SETUP</p> <p style="text-align: center;">SELECT: ▲▼◀▶ DECISION: ENTER BUTTON</p> </div> | PLAYER MODE | AUDIO | CAPTIONS | VIDEO | WALL PAPER | | DISPLAY | | AUTO POWER MODE | | SLIDE SHOW | |
| PLAYER MODE | AUDIO | | | | | | | | | | | | | |
| CAPTIONS | VIDEO | | | | | | | | | | | | | |
| WALL PAPER | | | | | | | | | | | | | | |
| DISPLAY | | | | | | | | | | | | | | |
| AUTO POWER MODE | | | | | | | | | | | | | | |
| SLIDE SHOW | | | | | | | | | | | | | | |

3



- ② When "CAPTIONS" is selected:
OFF (Factory default)
 Select this when you do not want to display the captions on the screen when playing DVDs containing English captions
ON
 Select this to display the captions on the screen when playing DVDs containing English captions.
- ③ When "WALL PAPER" is selected:
BLUE (Factory default)
 Select this to display a blue background on the TV display.
GRAY
 Select this to display a gray background on the TV display.
BLACK
 Select this to display a black background on the TV display.
PICTURE
 Select this to display the wallpaper on the TV display.
- ④ When "DISPLAY" is selected:
OFF (Factory default)
 This is valid when the display has been switched off. The display will not show an indication even when the button (ex. skip, stop, etc.) has been pressed.
ON
 This is valid when the display has been switched off. When the button (ex. skip, stop, etc.) is pressed, the indication will appear on the display for approximately 2 seconds.
- ⑤ When "AUTO POWER MODE" is selected:
OFF (Factory default)
 The power does not automatically switch to the standby mode.
ON
 The DVD-2910/955's power turns off and the standby mode is set if the DVD-2910/955 remains in the stop mode for approximately 30 minutes.
- ⑥ When "SLIDE SHOW" is selected:
 Use the ▲ and ▼ cursor buttons to set the time interval.
 The time interval can be set within 5 and 15 seconds. **(The factory default setting is 5 seconds.)**

* To exit the setup mode

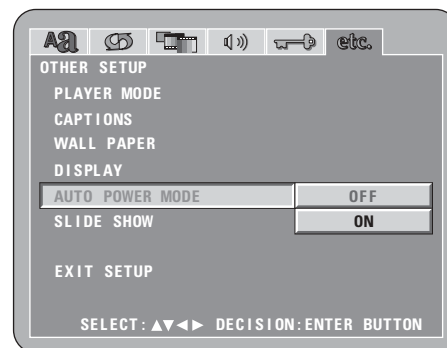
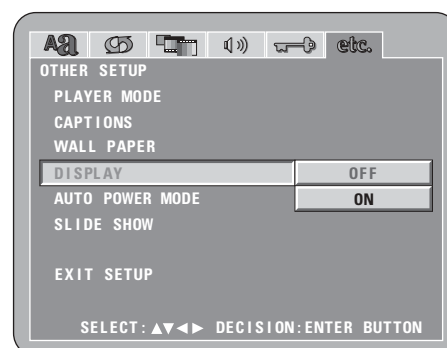
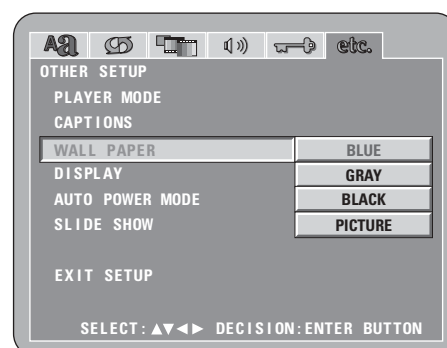
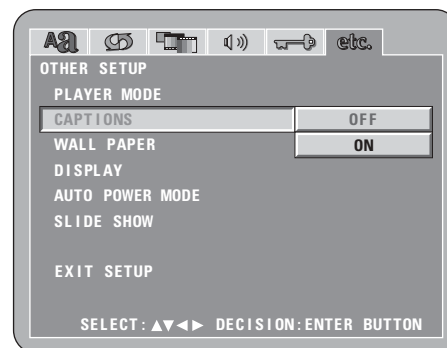
Use the ▼ cursor button to select "EXIT SETUP", then press the ENTER button. It is also possible to quit by pressing the SETUP button on the remote control unit.



NOTES:

- An English caption decoder is required to display English captions.
- DVDs with caption signals are indicated by the , ,  mark.
English captions cannot be displayed when playing DVDs which do not contain caption signals.
- The characters in which the captions are displayed (capital letters, small letters, italics, etc.) depend on the DVD and cannot be selected with the DVD-2910/955.

9 USING THE PURE DIRECT MODE

■ In the pure direct mode, only analog audio signals (no video signals, etc.) are output, thereby achieving high quality sound.

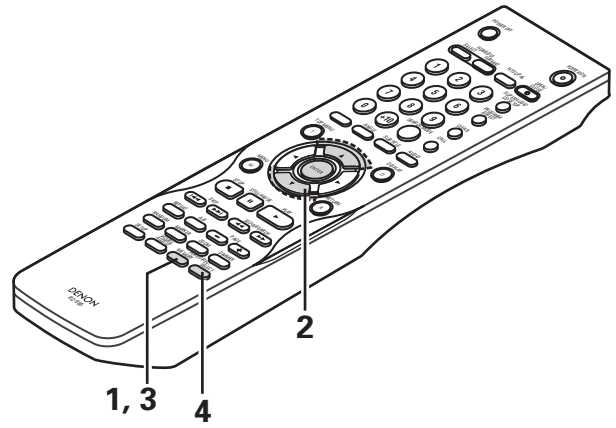
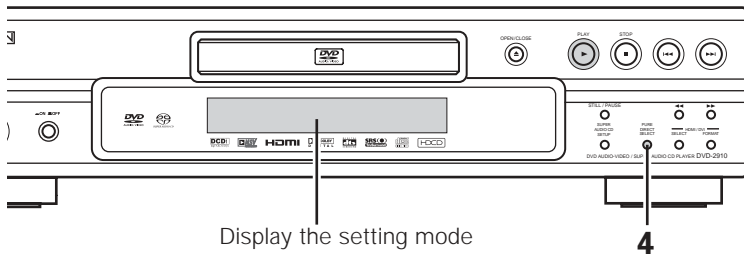

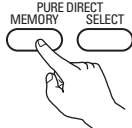
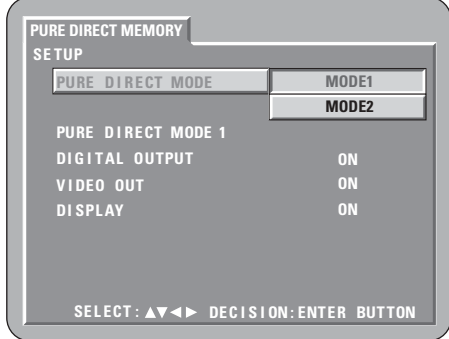
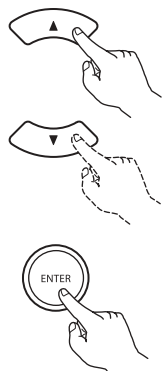
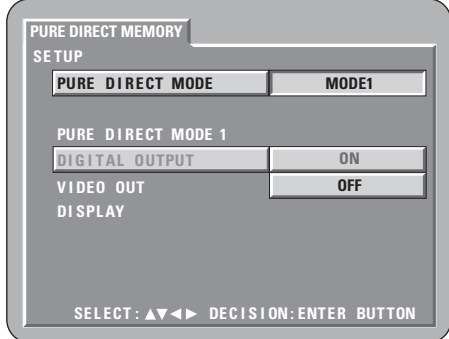
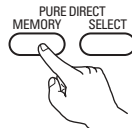

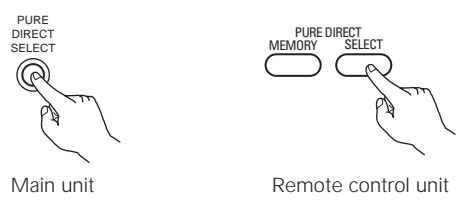
| | | |
|-----------------|--|--|
| <p>1</p> | <p>Press the PURE DIRECT MEMORY button on the remote control unit.</p> <ul style="list-style-type: none"> • The output status of the video signals, etc., can be stored at MODE 1 and MODE 2 as desired. |  <p>Remote control unit</p>  |
| <p>2</p> | <p>Use the ▲ and ▼ cursor buttons to select the mode, then press the ENTER button.</p> <p>DIGITAL OUTPUT ON: Digital audio signals are output. OFF: Digital audio signals are not output.</p> <p>VIDEO OUT ON: Video signals are output. OFF: Video signals are not output.</p> <p>DISPLAY ON: It is indicate in Display of the main unit. OFF: It is not indicate in Display of the main unit.</p> <p>* When the video output is set to "OFF" or "ALL OFF", neither HDMI video nor audio signals are output. Also, when the "HDMI AUDIO SETUP" is set to "MULTI (NORMAL)", the digital output setting cannot be made. (See page 30.)</p> |  <p>Remote control unit</p>  |
| <p>3</p> | <p>Press the PURE DIRECT MEMORY button on the remote control unit.</p> <ul style="list-style-type: none"> • All of the settings are stored in the memory. |  <p>Remote control unit</p> |

| | | |
|---|---|--|
| 4 | <p>Press the PURE DIRECT SELECT button on the main unit.</p> <p>The modes described below will appear on the display.</p> <p>NORMAL : All signals are output normally.</p> <p>MODE 1 : The settings stored for MODE 1 are used. The factory default settings are: "DIGITAL OUT" : "ON" "VIDEO OUT" : "ON" "DISPLAY" : "ON"</p> <p>MODE 2 : The settings stored for MODE 2 are used. The factory default settings are: "DIGITAL OUT" : "ON" "VIDEO OUT" : "ON" "DISPLAY" : "ON"</p> <p>ALL OFF : No indicate in Display of the main unit, video and digital signals are not out.(except analog audio output)</p> |  <p>Main unit</p> <p>Remote control unit</p> |
|---|---|--|

10 USING THE SUPER AUDIO CD SETUP

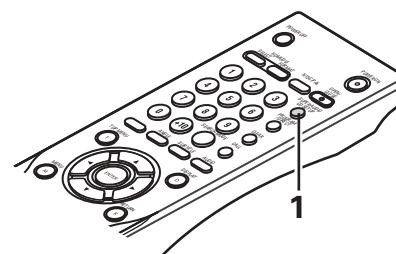
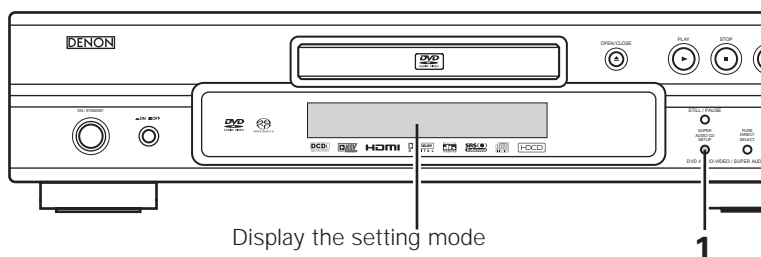
- On a Super Audio CD, the stereo and multi – channel areas are separate.
Hybrid discs comprise 2-layer structure of Super Audio CD layer and a CD layer.
The area/layer can be set to be played with priority.



| | | |
|---|---|--|
| 1 | <p>Press the SUPER AUDIO CD SETUP button.</p> <ul style="list-style-type: none"> The modes described below will appear on the display. <p>MULTI (Factory default) When playing a Super Audio CD disc, the multi – channel area will be played back with priority.</p> <p>STEREO When playing a Super Audio CD disc, the stereo area will be played back with priority.</p> <p>CD When playing a Super Audio CD disc, the CD layer will be played back with priority.</p> <p>*When playing back a disc that does not have a selected area/layer, another area/layer will be played back automatically.</p> |  <p>Main unit</p> <p>Remote control unit</p> <div style="display: flex; flex-direction: column; align-items: center; margin-top: 20px;"> <div style="border: 1px solid black; padding: 5px; margin-bottom: 10px;">MULTI</div> <div style="border: 1px solid black; padding: 5px; margin-bottom: 10px;">STEREO</div> <div style="border: 1px solid black; padding: 5px;">CD</div> </div> |
|---|---|--|

11 ADJUSTING THE PICTURE QUALITY

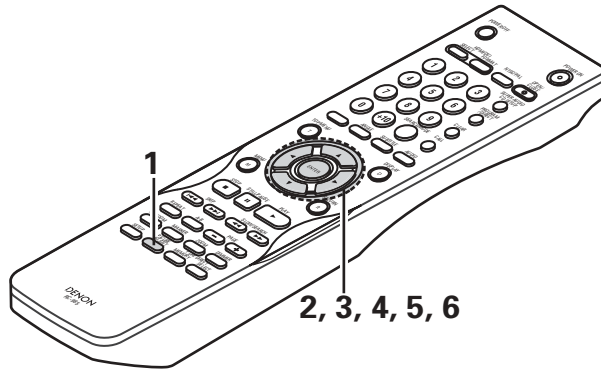

| | | |
|-----------------|---|----------------------------|
| <p>1</p> | <p>Press the PICTURE ADJUST button during playback or during pause.</p> <ul style="list-style-type: none"> The image quality adjustment screen will appear. <p>STD Returns the settings to the factory default settings.</p> <p>M1 TO M5 Image quality settings that have been adjusted to your preference can be stored to 5 memories, M1 to M5.</p> <p>SET SET permits set to setup level and setting of the screen display position (horizontal and vertical).</p> | <p>Remote control unit</p> |
| <p>2</p> | <p>Select the memory using the 2 cursor buttons (◀, ▶) and press the ENTER button.</p> <p>IMAGE QUALITY ADJUSTMENT 1 This permits adjustment of the contrast, brightness, sharpness, tint, and CCS (cross color suppression). → Advance to Operation 3</p> <p>IMAGE QUALITY ADJUSTMENT 2 This permits adjustment of the setup level, white level, color density, chroma delay, and NOISE REDUCTION. → Advance to Operation 4.</p> <p>GAMMA CORRECTION This is selected when dark portions of the image are obscure, or bright portions are much brighter than necessary. → Advance to Operation 5.</p> | <p>Remote control unit</p> |
| <p>3</p> | <p>When Image Quality Adjustment 1 Is Selected and Adjusted:</p> <ul style="list-style-type: none"> Press cursor button (▼), then select the image quality adjustment item with cursor buttons (◀, ▶), set the adjustment value with cursor buttons (▲, ▼), and press the ENTER button. All of the adjusted contents will be stored. <p>CONTRAST (-6 to +6) (Factory default: 0)</p> <ul style="list-style-type: none"> This adjusts the light/dark difference of the image. <p>BRIGHTNESS (0 to +12) (Factory default: 0)</p> <ul style="list-style-type: none"> This adjusts the brightness of the image. <p>SHARPNESS (MID) (-6 to +6) (Factory default: 0)</p> <ul style="list-style-type: none"> This adjusts the sharpness of the image for the intermediate frequencies. | <p>Remote control unit</p> |

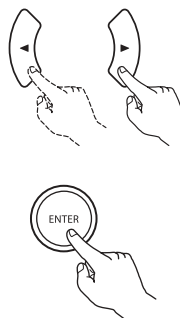
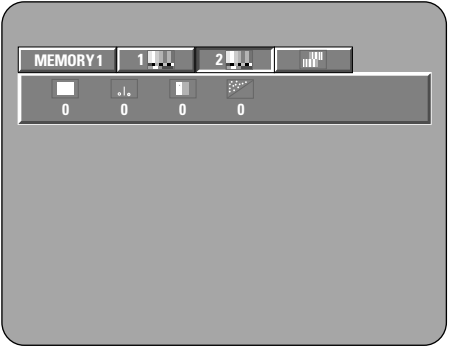
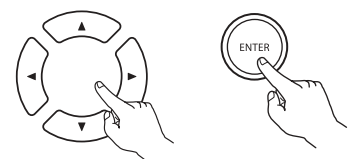
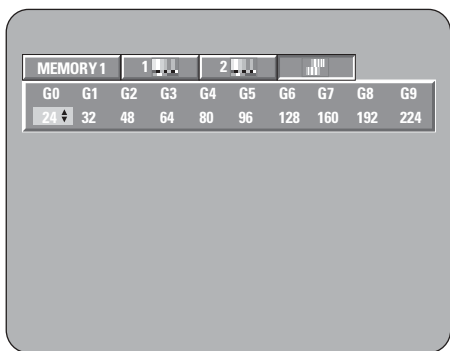
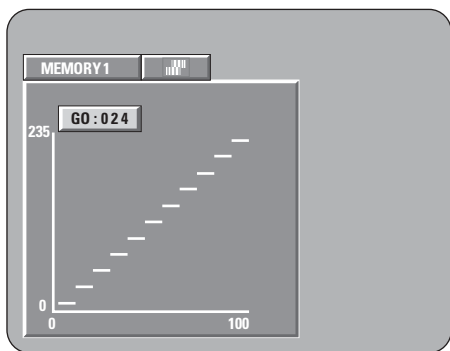
| | | |
|---|--|--|
| <p>3</p> | <p>SHARPNESS (HI) (-6 to +6) (Factory default: 0)</p> <ul style="list-style-type: none"> This adjusts the sharpness of the image for the high frequencies. (Only effective for progressive images.) <p>HUE (-6 to +6) (Factory default: 0)</p> <ul style="list-style-type: none"> This adjusts the balance between green and red. (Not effective for progressive scan output nor component output.) <p>CCS (0 to +3) (Factory default: 0)</p> <ul style="list-style-type: none"> This performs removal of the color signal component for images in which the color signal component is mixed with the brightness signal. (Only effective with progressive images.) | |
| <p>4</p> | <p>When Image Quality Adjustment 2 Is Selected and Adjusted:</p> <p>WHITE LEVEL (-5 to +5) (Factory default: 0)</p> <ul style="list-style-type: none"> This adjusts the white level. <p>CHROMA LEVEL (-6 to +6) (Factory default: 0)</p> <ul style="list-style-type: none"> This adjusts the density of the color. <p>CHROMA DELAY (-2 to +2) (Factory default: 0)</p> <ul style="list-style-type: none"> This adjusts the shift of the brightness signal and the color signal of the image. (Only effective for progressive images.) <p>DNR (Digital Noise Reduction) (0 to +6) (Factory default: 0)</p> <ul style="list-style-type: none"> This reduces video noise. |   <p>Remote control unit</p> |
| <p>5</p> | <p>When Gamma Correction is Selected and Adjusted: Two kinds of displays are prepared for adjustment of Gamma Correction.</p> <ul style="list-style-type: none"> When use the Numerical table of Gamma Correction. (Figure 1) :Pressing the cursor button (▼) When use the Graph of Gamma Correction. (Figure 2) :Pressing the enter button <p>Select the adjust point with cursor buttons (◀, ▶), set the adjustment brightness level with cursor buttons (▲, ▼), and press the ENTER button. (If the PICTURE ADJUST button is pressed before pressing the enter button, an adjustment level is not stored)</p> <ul style="list-style-type: none"> The brightness level can be adjusted in range of 16 to 235. Pressing the cursor button (▲) raises the level (and the image becomes brighter), and pressing the cursor button (▼) lowers the level (and the image becomes darker). A press of the CLEAR button returns all of the setting points to the standard level. *The level of the selected point cannot exceed the level of the points above and below that point. (A dark portion cannot be set to exceed a portion that is brighter than it.) |  <p>Remote control unit</p>  <p>(Figure 1)</p>  <p>(Figure 2)</p> |
| <p>*Ending the Image Quality Adjustment</p> | | |

REFERENCE:

- In the Graph of Gamma correction, the horizontal axis indicates the brightness level of the image that is recorded on the disc, and the vertical axis indicates the brightness level of the image when it is output from this unit.

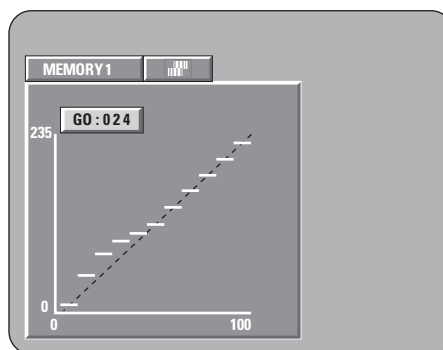
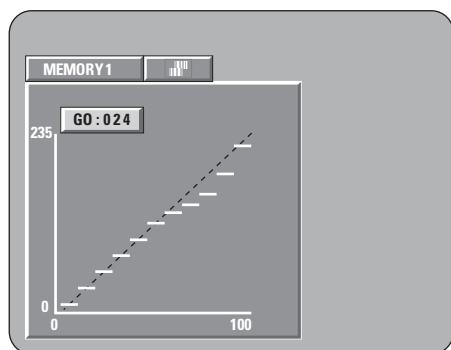

- When bright points of the disc side are adjusted to the "dark" of the output side, the fine parts of the bright portion that normally become hard to see, become an easily discerned image.

- When dark points of the disc side are adjusted to the "bright" of the output side, the fine parts of the dark portion that normally become hard to see, become an easily discerned image.

6

When the Display Position is Selected and Adjusted:

- Press the cursor button (▼), then select the horizontal/vertical direction with the cursor buttons (◀, ▶), set the adjustment value with the (▲, ▼) cursor buttons, and press the ENTER button.

SETUP LEVEL (0 IRE, 7.5 IRE) (Factory default: 7.5 IRE)

- This corrects floating black.

H. POSITION (-7 to +7) (Factory default: 0)

- A 15-step portion of position adjustment is permitted left and right.

V. POSITION (-3 to +7) (Factory default: 0)

- A 11-step portion of position adjustment is permitted up and down.

* The picture and sound may be disturbed while the display position is being adjusted.

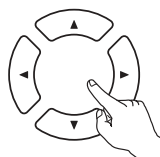

Remote control unit

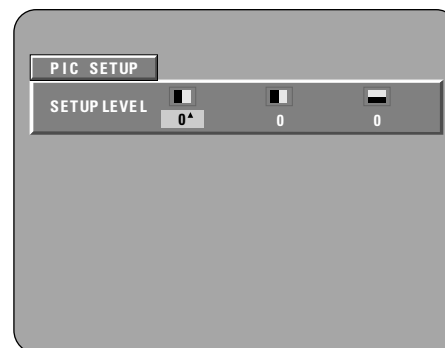
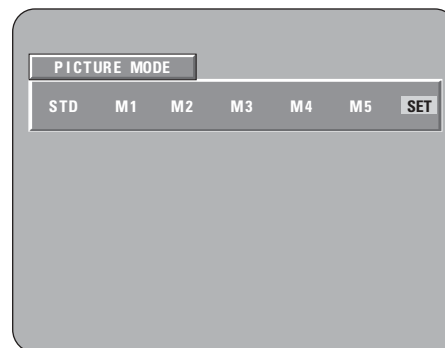

*** To exit the picture adjust mode**

Press the PICTURE ADJUST button.

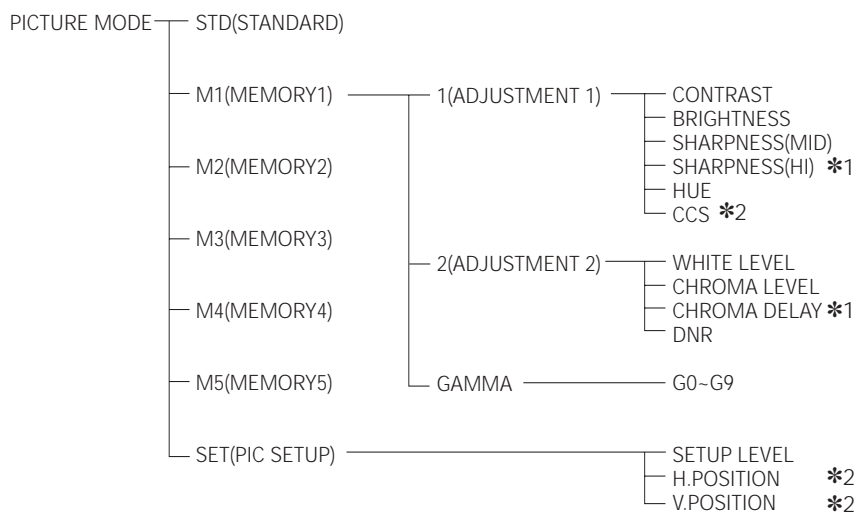

- *1 Only effective for progressive scan.
- *2 Only effective for HDMI, DVI and progressive scan.
- When HDMI and DVI signals are output, the SHARPNESS (MID/HI), CHROMA DELAY and Gamma correction settings will have no effect.

12 USING THE VIDEO SETUP

- The video output setting of the HDMI and the DVI-D connectors can be changed.
- The video output setting of the PICTURE MODE, PROGRESSIVE MODE and ADJUST MODE also can be changed.

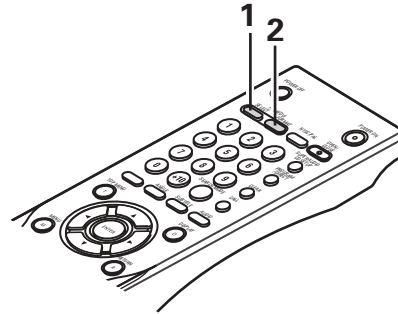
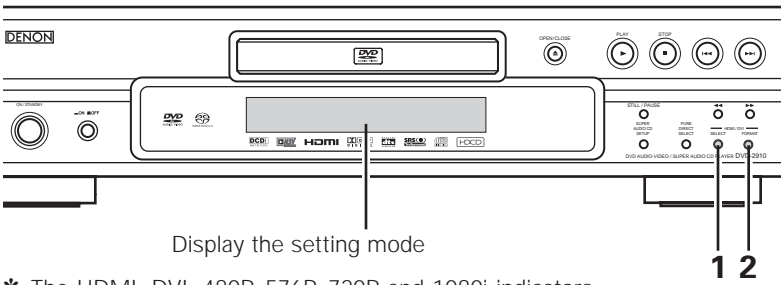

- * The HDMI, DVI, 480P, 576P, 720P and 1080i indicators flash when the connection is being checked, then stop flashing, remaining lit, once the check is completed.



| | | |
|-----------------|---|--|
| <p>1</p> | <p>Press the HDMI/DVI SELECT button.</p> <ul style="list-style-type: none"> The modes described below will appear on the display. <ul style="list-style-type: none"> HDMI/DVI OFF (Factory default) No output signals from the HDMI and DVI-D connectors. This mode is set to use the COMPONENT VIDEO OUT connector. HDMI Y Cb Cr Outputs the component signals from the HDMI connector. HDMI RGB Outputs the RGB signals from the HDMI connector. DVI Outputs the RGB signals from the DVI-D connector. * The video signals are only output from one of the HDMI, DVI or progressive component video output connectors. | |
| <p>2</p> | <p>Press the HDMI/DVI FORMAT button.</p> <ul style="list-style-type: none"> The modes described below will appear on the display. Select the item you wish to set and press the select knob to define it. <ul style="list-style-type: none"> 480P/576P (Factory default) Outputs the image from the HDMI or DVI-D connector at 480P (NTSC) or 576P (PAL). 720P Outputs the image from the HDMI or DVI-D connector at 720P. 1080i Outputs the image from the HDMI or DVI-D connector at 1080i. When playing back a PAL-formatted disc, be sure to set the TV TYPE option to NTSC. (See pages 32, 33.) The video or audio signals may be interrupted when the output setting mode is switched. Depending on the TV you are using, if the TV's input is not set to HDMI or DVI, the HDMI or DVI OFF mode may be set. In this case, set the TV's input setting to HDMI or DVI before performing the DVI setup procedure. Connect to an HDCP compatible display to view images with DVI connections. | |

13 PLAYBACK

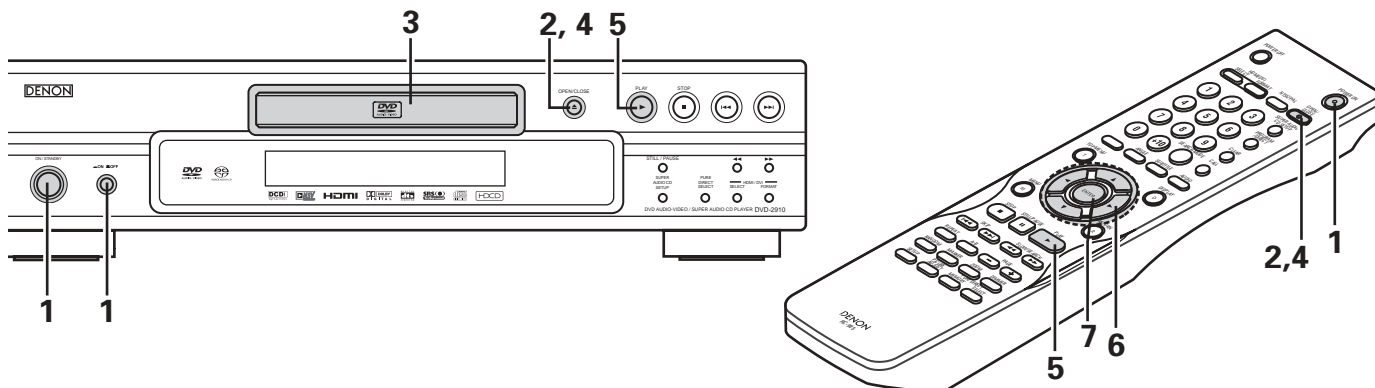
(1) Playback

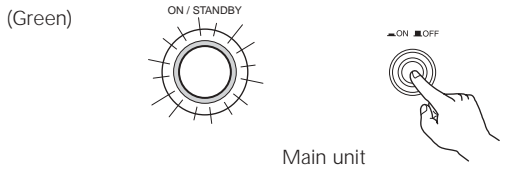
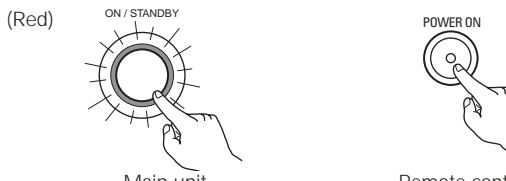
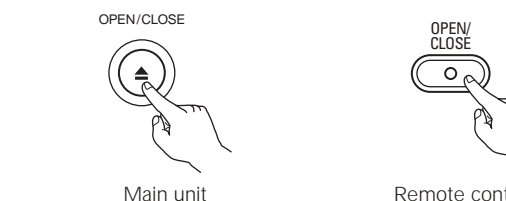
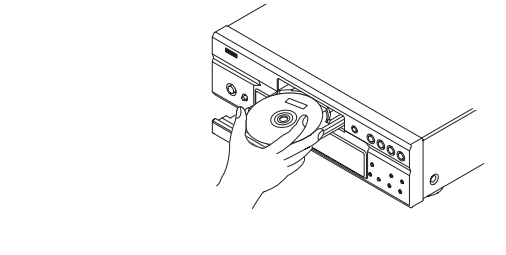
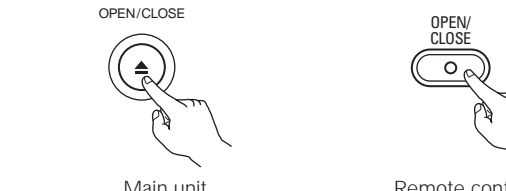

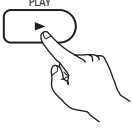
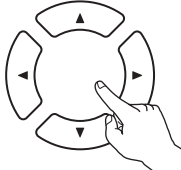
| | | |
|-----------------|--|---|
| <p>1</p> | <p>Turn on the power.</p> <ul style="list-style-type: none"> Press the power button, the power indicator lights green and the power turns on. When pressed again, the power turns off and indicator is off. In the standby mode (the power indicator lights red), press the ON/STANDBY button on the main unit or POWER ON button on the RC-985. | <p>(Green)</p>  <p>Main unit</p> <p>(Red)</p>  <p>Main unit</p> <p>Remote control unit</p> |
| <p>2</p> | <p>Press the OPEN/CLOSE button to open the disc tray.</p> |  <p>Main unit</p> <p>Remote control unit</p> |
| <p>3</p> | <p>Set the disc in the disc tray.</p> |  |
| <p>4</p> | <p>Press the OPEN/CLOSE button.</p> |  <p>Main unit</p> <p>Remote control unit</p> |

| <p>5</p> | <p>Press the PLAY button.</p> <ul style="list-style-type: none"> For many interactive DVDs and video CDs with playback control, a menu screen appears. In this case use the procedure in step 6 to select the desired item. * Interactive DVDs are DVDs including multiple angles, stories, etc. | <div style="display: flex; justify-content: space-around;"> <div style="text-align: center;">  <p>Main unit</p> </div> <div style="text-align: center;">  <p>Remote control unit</p> </div> </div> <p>Example: For DVDs with menu screens</p> <table border="1" style="margin: 10px auto; width: 150px;"> <tr><th colspan="2">TOP MENU</th></tr> <tr><td>Apple</td><td>Banana</td></tr> <tr><td>Orange</td><td>Strawberry</td></tr> <tr><td>Peach</td><td>Pineapple</td></tr> </table> <p>Example: For video CDs with playback control</p> <table border="1" style="margin: 10px auto; width: 150px;"> <tr><td>1. Opening</td></tr> <tr><td>2. 1st movement</td></tr> <tr><td>3. 2nd movement</td></tr> <tr><td>4. 3rd movement</td></tr> <tr><td>5. Ending</td></tr> </table> | TOP MENU | | Apple | Banana | Orange | Strawberry | Peach | Pineapple | 1. Opening | 2. 1st movement | 3. 2nd movement | 4. 3rd movement | 5. Ending |
|-----------------|--|---|----------|--|-------|--------|--------|------------|-------|-----------|------------|-----------------|-----------------|-----------------|-----------|
| TOP MENU | | | | | | | | | | | | | | | |
| Apple | Banana | | | | | | | | | | | | | | |
| Orange | Strawberry | | | | | | | | | | | | | | |
| Peach | Pineapple | | | | | | | | | | | | | | |
| 1. Opening | | | | | | | | | | | | | | | |
| 2. 1st movement | | | | | | | | | | | | | | | |
| 3. 2nd movement | | | | | | | | | | | | | | | |
| 4. 3rd movement | | | | | | | | | | | | | | | |
| 5. Ending | | | | | | | | | | | | | | | |
| <p>6</p> | <p>Use the cursor buttons (▲, ▼, ◀ and ▶) to select the desired item.</p> <ul style="list-style-type: none"> For some discs there is a second menu screen. If so, press the ►► button to display the next menu screen. (See the disc's jacket.) * The cursor buttons (▲, ▼, ◀ and ▶) do not work for video CDs. Use the number buttons to select the desired item. | <div style="text-align: center;">  <p>Remote control unit</p> </div> | | | | | | | | | | | | | |
| <p>7</p> | <p>Press the ENTER button.</p> <ul style="list-style-type: none"> The desired item is selected and playback starts. You can return to the menu screen by pressing the TOP MENU/MENU button while the DVD is playing, though this depends on the disc. Press the RETURN button during playback of a video CD to return to the menu screen. | <div style="text-align: center;">  <p>Remote control unit</p> </div> <p>Example: When "Apple" is selected</p> <table border="1" style="margin: 10px auto; width: 150px;"> <tr><th colspan="2">TOP MENU</th></tr> <tr><td>Apple</td><td>Banana</td></tr> <tr><td>Orange</td><td>Strawberry</td></tr> <tr><td>Peach</td><td>Pineapple</td></tr> </table> <div style="display: flex; align-items: center; justify-content: center; margin: 10px 0;"> ➔ <div style="border: 1px solid black; padding: 10px; text-align: center; width: 100px;"> <h2 style="margin: 0;">Apple</h2> </div> </div> | TOP MENU | | Apple | Banana | Orange | Strawberry | Peach | Pineapple | | | | | |
| TOP MENU | | | | | | | | | | | | | | | |
| Apple | Banana | | | | | | | | | | | | | | |
| Orange | Strawberry | | | | | | | | | | | | | | |
| Peach | Pineapple | | | | | | | | | | | | | | |

NOTES:

- If  appears on the TV screen while buttons are being operated, that operation is not possible on the DVD-2910/955 or with that disc.
- Set the disc in the disc guide.
- Do not place more than one disc in the disc tray.
- The disc keeps turning while the menu screen is displayed on the TV screen.

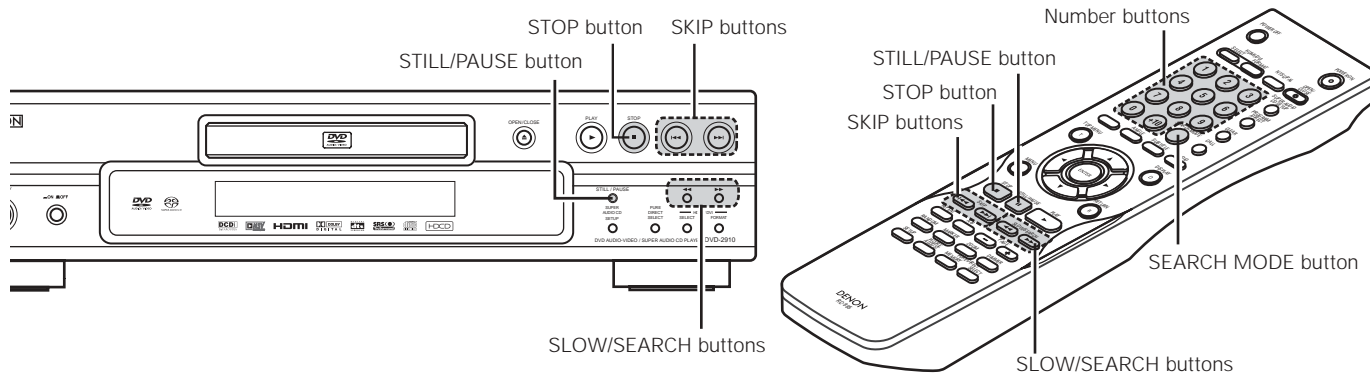

(2) Stopping Playback

During playback, press the STOP button on the main unit or the remote control unit, playback stops and wall paper is displayed.

<Resume play memory function (DVD only)>

- With the DVD-2910/955, when the STOP button is pressed, that position is stored in the memory. At this time, "▶" flashes on the display. When the PLAY button is pressed after pressing the STOP button, playback resumes from the position at which it was stopped. The resume play memory function is cancelled if the disc tray is opened or the STOP button is pressed a second time.
- After 30 minutes in the stop mode, the DVD-2910/955's power automatically turns off and the standby mode is set. (Auto Power Off)

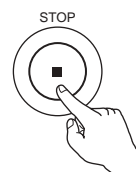

Main unit

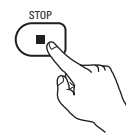

Remote control unit

- * The resume play memory function only works for discs for which the elapsed time is shown on the display during playback.

NOTE:

- The resume play memory function does not work during menu playback of DVD-VIDEO discs.

(3) Playing Still Pictures (Pausing)

During playback, press the STILL/PAUSE button on the main unit or the remote control unit.

- Press the PLAY button to resume normal playback.



Main unit

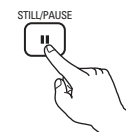

Remote control unit

(4) Forward/Reverse Searching

During playback, press one of the SLOW/SEARCH buttons on the main unit or the remote control unit.

- ◀◀ : Reverse direction
- ▶▶ : Forward direction

- When pressed again, the search speed increases.
- Variable in 4 steps for Super audio CDs and CDs, 7 steps for DVD audio (movie part), DVD video and video CD discs.
- Press the PLAY button to resume normal playback.

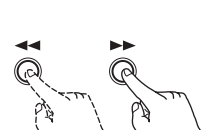

Main unit

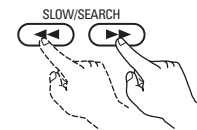

Remote control unit

NOTE:

- In some cases the menu screen may reappear when one of the SLOW/SEARCH buttons is pressed during menu playback on a video CD.

(5) Skipping to the Beginning of Chapters or Tracks

Cueing using the SKIP buttons

During playback, press one of the SKIP buttons on the main unit or the remote control unit.

- ◀◀ : Reverse direction (PREVIOUS)
- ▶▶ : Forward direction (NEXT)

- A number of chapters or tracks equal to the number of times the button is pressed is skipped.
- When the SKIP ◀◀ button is pressed once, the pickup returns to the beginning of the currently playing chapter or track.

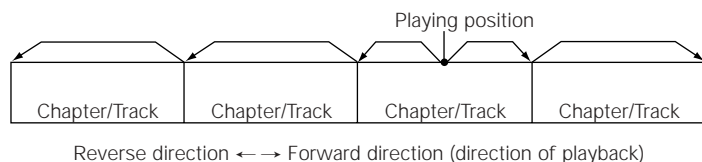

Cueing using the number buttons

Press the SEARCH MODE button during playback.

- The search mode switches each time the button is pressed.
 - For DVD audio discs : Group → Track → (Group) →
 - For DVD video discs : Title → Chapter → (Title) →
 - For Super audio CDs, CDs and video CDs : Track only
- * The search mode set by pressing the SEARCH MODE button is stored in the memory until the button is pressed again. However, the search mode returns to the default mode when the power is turned off.
- Use the number buttons to input the number to be played.

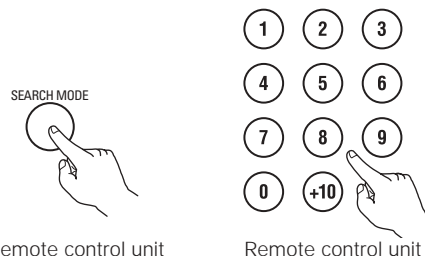

NOTE:

- In some cases the menu screen may reappear when one of the SKIP buttons is pressed during menu playback on a video CD.

NOTE:

- Some DVD audio, DVD video and video CD discs do not operate as described in this manual due to the intentions of the discs' producers.

(6) Playing Frame by Frame (for DVD-videos and video CDs only)

During playback, press the STILL/PAUSE button on the main unit or the remote control unit.

- The picture moves forward one frame each time the button is pressed.
- Press the PLAY button to resume normal playback.
- With DVD audio discs, forward frame-by-frame skipping is only possible for the video part.



(7) Slow Playback (for DVD-videos and video CDs only)

In the still mode, press one of the SLOW/SEARCH buttons on the main unit or the remote control unit.

- ◀◀ : Reverse direction
- ▶▶ : Forward direction

- When pressed again, the slow play speed increases.
- Press the PLAY button to resume normal playback.
- With DVD audio discs, the forward slow play function can only be used with the video part.

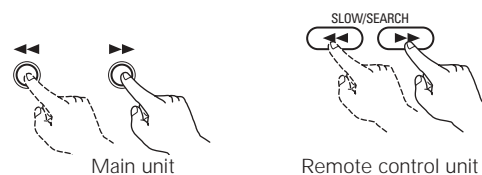

NOTE:

- Reverse slow play is not possible on video CDs.

(8) Selecting the still image (only for DVD-audios)

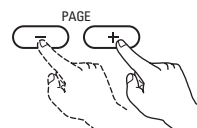

During playback, press the PAGE + or PAGE - button on the remote control unit.

- For DVD audio discs with still images, the desired image can be selected.
- On some discs the image cannot be selected due to the intentions of the discs' producers.

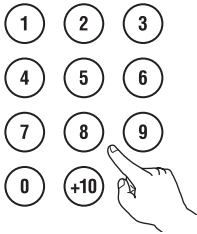

Remote control unit

(9) Playing bonus groups (only for DVD-audios)

| | | |
|---|--|---|
| 1 | In the stop mode, press the SEARCH MODE button on the remote control unit to set the search mode to "GROUP". |  <p>Remote control unit</p> |
| 2 | Use the number buttons to input the bonus group number. |  <p>Remote control unit</p> |
| 3 | Use the number buttons on the remote control unit to input the password (4 digits), then press the ENTER button. <ul style="list-style-type: none"> • Playback starts from the first track in the specified group. |  <p>Remote control unit</p> |
| <ul style="list-style-type: none"> • In some cases the password must be input at the menu screen. In these cases, follow the instructions on the screen. • Once the password is input, the disc can be played as many times as you want until it is removed. • If you make a mistake when inputting the password, press the CLEAR button on the remote control unit. | | |

14 PLAYING REPEATEDLY

■ Use this function to play your favourite audio or video sections repeatedly.

Playing Repeatedly (Repeat Playback)

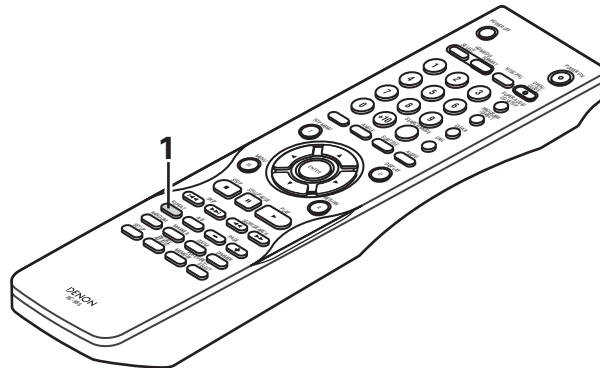

In the play mode, press the REPEAT button.

- The display on the TV screen switches each time the button is pressed, and the corresponding repeat play mode or normal playback mode is set.

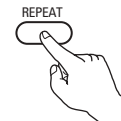

Remote control unit

① For DVD audio discs

- Normal playback

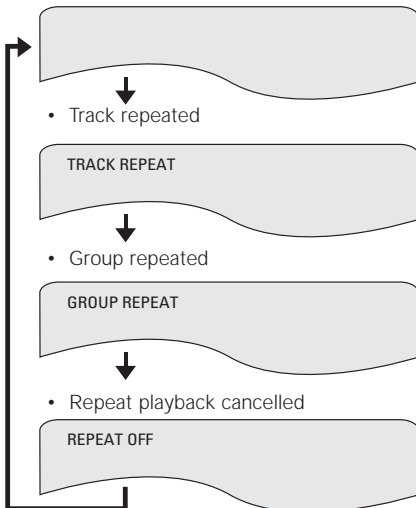

② For DVD video discs

- Normal playback

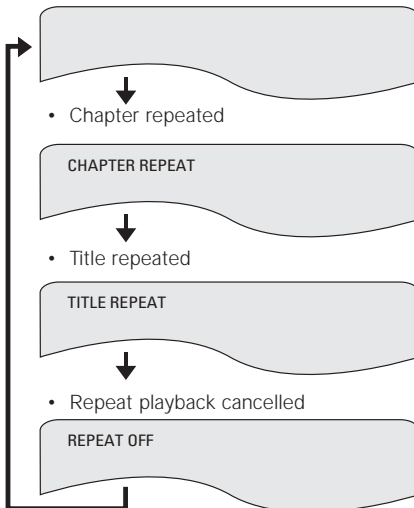

③ For video CDs, Super audio CDs and music CDs

- Normal playback

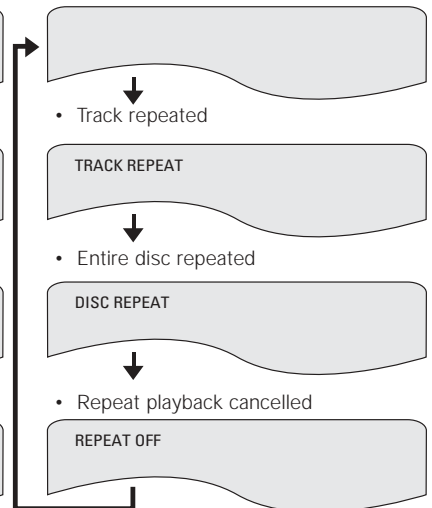

* To return to normal playback:

Return to normal playback by pressing the REPEAT button until "REPEAT OFF" appears on the TV screen.

Playing a Certain Section Repeatedly (A-B Repeat Playback)

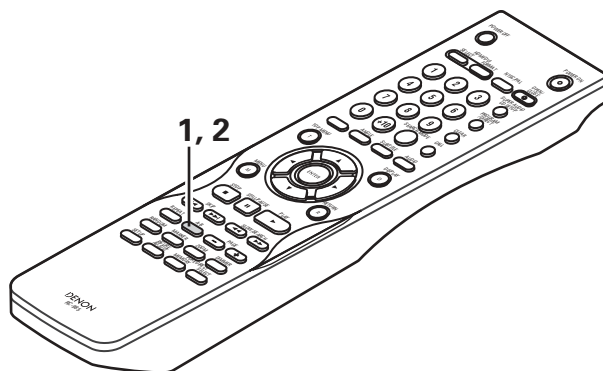

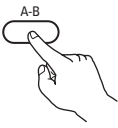
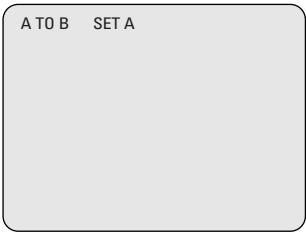
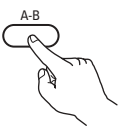
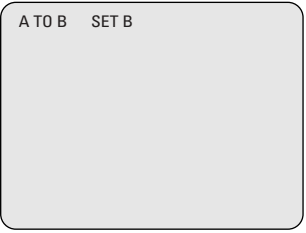
| | | |
|---|--|---|
| <p>1</p> | <p>During playback, press the A-B button.</p> <ul style="list-style-type: none"> This sets start point A. |  <p>Remote control unit</p>  |
| <p>2</p> | <p>Press the A-B button again.</p> <ul style="list-style-type: none"> This sets end point B, and repeat playback of the A-B section starts. |  <p>Remote control unit</p>  |
| <p>* To return to normal playback: Press the A-B button until "A TO B CANCELED" appears on the TV screen.</p> | | |

NOTES:

- Repeat playback may not work for some DVDs.
- The repeat playback and A-B repeat playback functions will not work for DVDs and video CDs for which the elapsed time is not shown on the display during playback.
- In some cases, subtitles may not be displayed near the A and B points during A-B repeat playback.

15 PLAYING TRACKS IN THE DESIRED ORDER

- Use this function with DVD-AUDIO discs, video CDs, Super audio CDs and music CDs to play the tracks in the desired order.
- This function does not affect with DVD-VIDEO discs.

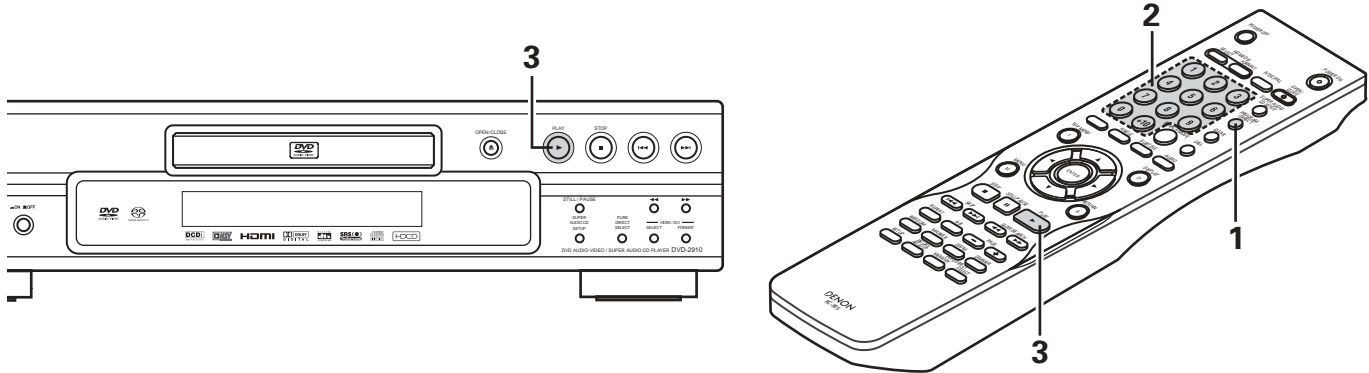

| | | |
|-----------------|---|---|
| <p>1</p> | <p>In the stop mode, press the PROGRAM/DIRECT button once.</p> <ul style="list-style-type: none"> • The program selection screen appears. | <p>Remote control unit</p> |
| <p>2</p> | <p>Use the number buttons to select the track number you want to program.</p> <p>EX: To program track 5 and track 12</p> <ul style="list-style-type: none"> • Press the "5". • Press the "+10" and "2". • With DVD-audio, group numbers can be specified and programmed. Bonus tracks, however, cannot be programmed. | <p>Remote control unit</p> |
| <p>3</p> | <p>Press the PLAY button.</p> <ul style="list-style-type: none"> • Playback of the tracks in the programmed order begins. | <p>Main unit Remote control unit</p> |

- * To return to normal playback:
Press the STOP button to stop programmed playback, then press the PROGRAM/DIRECT button. Now press the PLAY button to start normal playback from the beginning of the disc.
- * To clear tracks from the program:
Press the STOP button. The program play screen appears. Press the CLEAR button to clear the last track in the program.
- * To clear the entire program:
The entire program is cleared when the power is turned off or the disc is ejected.
- * To check the programmed contents, press the CALL button in the stop mode. The programmed contents are displayed step by step.
- * Up to 20 tracks can be programmed.

16 PLAYING TRACKS IN THE RANDOM ORDER

- Use this function with video CDs, Super audio CDs and music CDs to play the tracks in random order.
With DVD-AUDIO discs, random playback is performed within the selected group.
- This function does not affect with DVD-VIDEO discs.

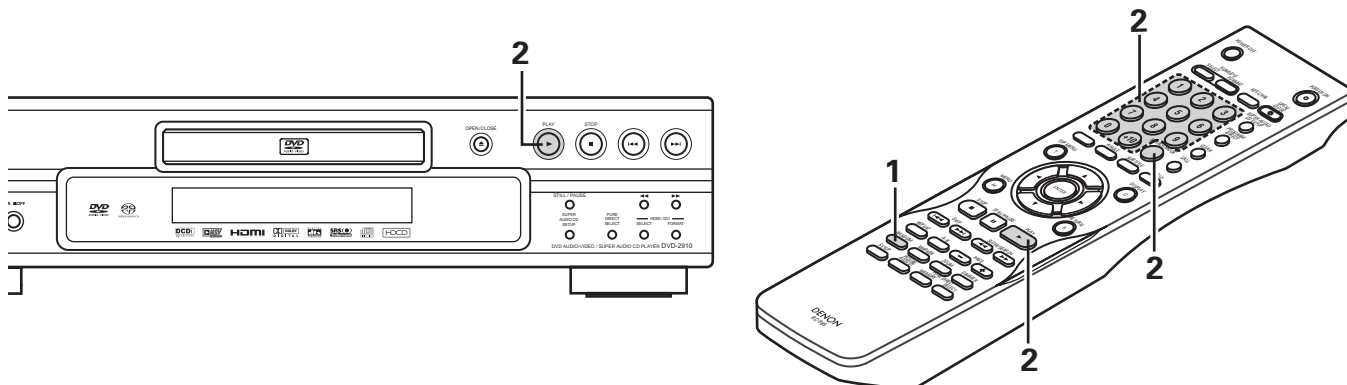

| | | |
|--|---|--|
| <p>1</p> | <p>In the stop mode, press the RANDOM button.</p> <ul style="list-style-type: none"> • The random play screen appears. | <p>Remote control unit</p> |
| <p>2</p> | <p>Press the PLAY button.</p> <ul style="list-style-type: none"> • The tracks start playing in random order. | <p>Main unit Remote control unit</p> |
| | <p>* For DVD audio discs: When operating from the remote control unit, use the buttons to input the number of the group you want to play.</p> | <p>Remote control unit Remote control unit</p> <p>* for DVD audio discs</p> |
| <ul style="list-style-type: none"> • Random playback is not possible for some discs. * To return to normal playback: Press the STOP button to stop random playback, then press the RANDOM button once. | | |

17 USING THE ON-SCREEN DISPLAY

■ Use this function to display and change information on the disc (titles, chapters, time, etc.)

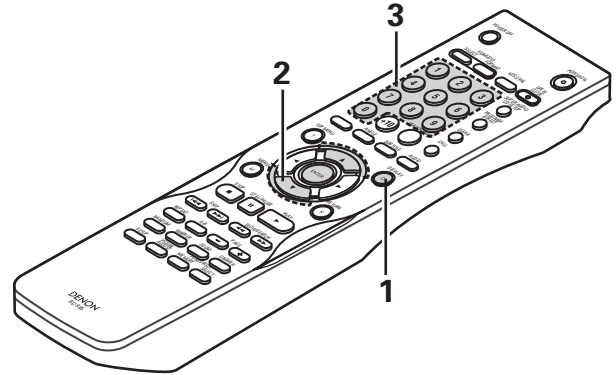



| | | |
|-----------------|--|--|
| <p>1</p> | <p>In the play mode, press the DISPLAY button.</p> <ul style="list-style-type: none"> The On-Screen Display appears. The picture on the TV screen switches each time the button is pressed. The items displayed differ from disc to disc. <p>Example: For DVD audio discs</p> <ul style="list-style-type: none"> Normal playback screen Disc information screen GROUP 01/02 TRACK 01 /10 GROUP ELAPSED 0 : 00 : 01 GROUP REMAIN 0 : 57 : 59 TRACK ELAPSED 0 : 00 : 01 TRACK REMAIN 0 : 05 : 59 Disc information screen AUDIO 1/1 : PPCM 5.1 ch/ 96 kHz/24 BIT <p>Example: For DVD video discs</p> <ul style="list-style-type: none"> Normal playback screen Disc information screen TITLE 01/10 CHAPTER 01 /10 TITLE ELAPSED 00 : 00 : 01 TITLE REMAIN 01 : 10 : 59 CHAPTER ELAPSED 00 : 00 : 01 CHAPTER REMAIN 00 : 40 : 59 Disc information screen AUDIO 01/2 : DOLBY D3/2.1 ENGLISH SUBTITLE OFF | <p>Example: For video CDs, Super audio CDs and music CDs</p> <ul style="list-style-type: none"> Normal playback screen Disc information screen TRACK 05/10 *SINGLE ELAPSED 02 : 11 SINGLE REMAIN 03 : 17 TOTAL ELAPSED 26 : 15 TOTAL REMAIN 32 : 05 <p>* Some Super audio CDs contain text data. In this case, the album title and artist are displayed in the stop mode, and the title of the currently playing track is displayed in the play mode.</p> |
| <p>2</p> | <p>Use the ▲ and ▼ cursor buttons to select the item you wish to change.</p> <ul style="list-style-type: none"> The selected item is displayed with a yellow frame. <ol style="list-style-type: none"> For DVD audio discs The elapsed time of groups and tracks can be selected. For DVD video discs The elapsed time of titles, titles and chapters can be selected. For video CDs, Super audio CDs and music CDs The elapsed time of tracks, tracks can be selected. | <p>Remote control unit</p> |
| <p>3</p> | <ol style="list-style-type: none"> Changing the elapsed time Input using the number buttons, then press the ENTER button. Example: For 1 minute 26 seconds → "00126" : DVD/SUPER AUDIO CD ↳ "0126" : VIDEO CD/CD Changing the title, track or chapter <ul style="list-style-type: none"> For DVDs Input using the number buttons, then press the ENTER button. (For some discs it is not possible to change the title or chapter.) For video CDs, Super audio CDs and music CDs Input using the number buttons. Playback starts from that track. | <p>Remote control unit Remote control unit</p> |

18 USING THE MULTIPLE AUDIO, SUBTITLE AND ANGLE FUNCTIONS

Switching the Audio Language (Multiple Audio Function)

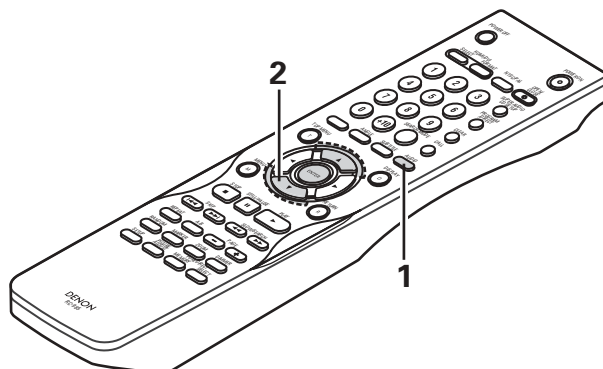
- With DVDs containing multiple audio language signals, the audio language can be switched during playback.

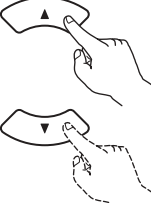

| | | |
|-----------------|---|--|
| <p>1</p> | <p>During playback, press the AUDIO button.</p> <ul style="list-style-type: none"> • The current audio language number is displayed. |  <p>Remote control unit</p> <div data-bbox="1166 868 1469 1095" style="border: 1px solid black; padding: 5px; background-color: #f0f0f0;"> <p>AUDIO 1/3 :DOLBY D3/2.1 ENGLISH</p> </div> |
| <p>2</p> | <p>Use the ▲ and ▼ cursor buttons to select the desired language.</p> <ul style="list-style-type: none"> • The display turns off when the AUDIO button is pressed. |  <p>Remote control unit</p> <div data-bbox="1166 1244 1469 1472" style="border: 1px solid black; padding: 5px; background-color: #f0f0f0;"> <p>AUDIO 2/3 :DOLBY D3/2.1 FRENCH</p> </div> |

NOTES:

- With some discs it is not possible to change the audio language during playback. In such cases, select from the DVD menu. (See page 64.)
- If the desired language is not set after pressing the ▲ and ▼ cursor buttons several times, the disc does not include that language.
- The language selected in the default settings (See page 23.) is set when the power is turned on and when the disc is replaced.

Switching the Subtitle Language (Multiple Subtitle Function)

- With DVDs containing multiple subtitle language signals, the subtitle language can be switched during playback.

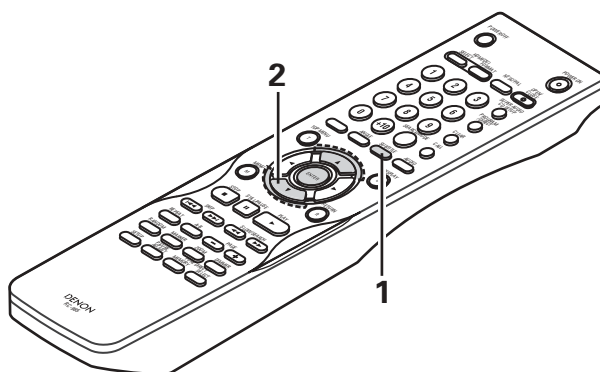

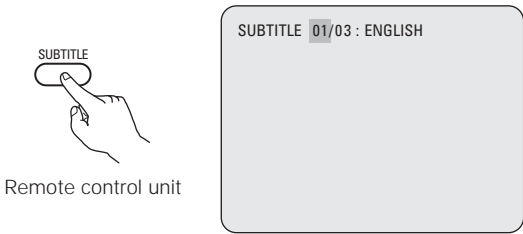
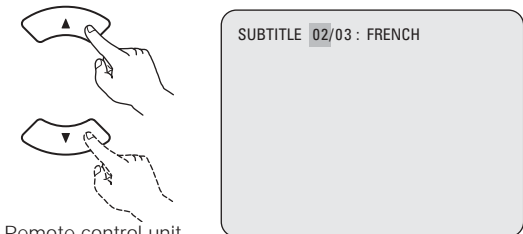
| | | |
|-----------------|--|---|
| <p>1</p> | <p>During playback, press the SUBTITLE button.</p> <ul style="list-style-type: none"> • The current subtitle language number is displayed. |  <p>Remote control unit</p> |
| <p>2</p> | <p>Use the ▲ and ▼ cursor buttons to select the desired language.</p> <ul style="list-style-type: none"> • The display turns off when the SUBTITLE button is pressed. |  <p>Remote control unit</p> |

NOTES:

- If the desired language is not set after pressing the ▲ and ▼ cursor buttons several times, the disc does not include that language.
- The subtitle language set with the default settings (See pages 26, 27.) is set when the power is turned on and when the disc is replaced.
If that language is not included on the disc, the disc's default language is set.
- When the subtitle language is changed, several seconds may be required for the new language to appear.
- When a disc supporting the closed caption is played, the subtitle and the closed caption may overlap each other on the TV monitor.
in this case, turn the subtitle off.

Switching the Angle (Multiple Angle Function)

- With DVDs containing multiple angle signals, the angle can be switched during playback.

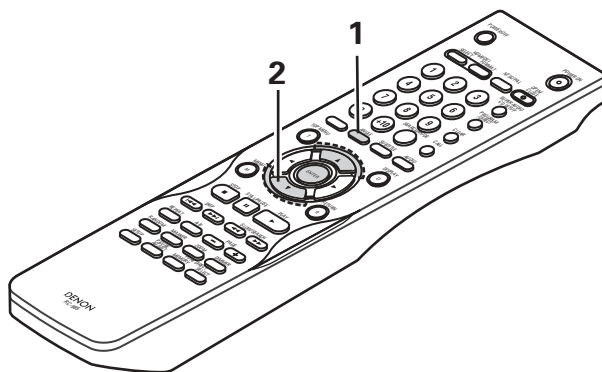

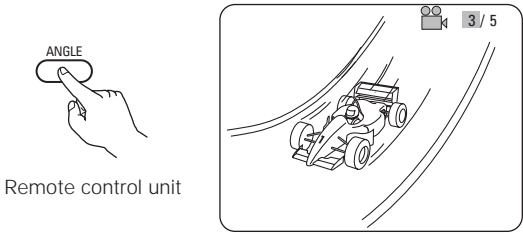
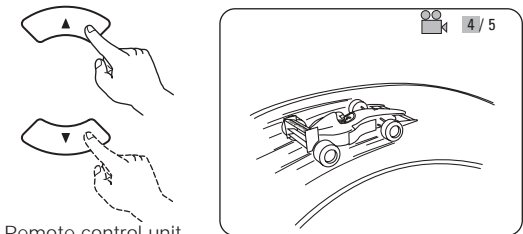
| | | |
|-----------------|--|---|
| <p>1</p> | <p>During playback, press the ANGLE button.</p> <ul style="list-style-type: none"> • The current angle number is displayed. |  <p>Remote control unit</p> |
| <p>2</p> | <p>Use the ▲ and ▼ cursor buttons to select the desired angle.</p> <ul style="list-style-type: none"> • The display turns off when the ANGLE button is pressed. |  <p>Remote control unit</p> |

NOTES:



- The multiple angle function only works with discs on which multiple angles are recorded.
- "ANGLE" lights on the main unit's display when playing a section recorded in the multi-angle mode.
- At scenes where multiple angles are recorded, the angle can be switched.

19 USING THE MENUS

Using the Top Menu

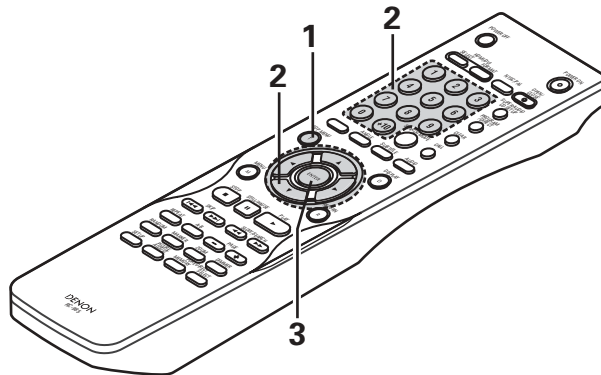
■ For DVDs containing multiple titles, the desired title can be selected and played from the top menu.

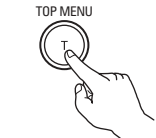
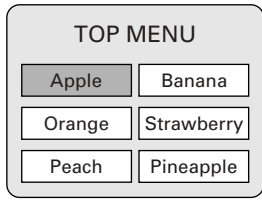
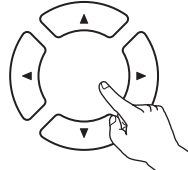
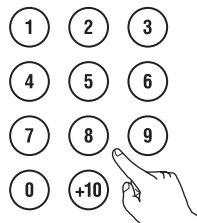
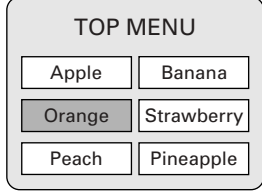

| | | |
|-----------------|--|---|
| <p>1</p> | <p>During playback, press the TOP MENU button.</p> <ul style="list-style-type: none"> The top menu appears. | <p>Example:</p>  <p>Remote control unit</p>  |
| <p>2</p> | <p>Use the cursor or number buttons to select the desired title.</p> <ul style="list-style-type: none"> If you select the title number using the number buttons, skip step 3 below. |  <p>Remote control unit</p>  <p>Remote control unit</p> <p>Example: When "Orange" is selected</p>  |
| <p>3</p> | <p>Press the ENTER button.</p> <ul style="list-style-type: none"> Playback starts. Playback also starts if the PLAY button is pressed. |  <p>Remote control unit</p> |

Using the DVD Menu



■ Some DVDs include special menus called DVD menus.

For example, DVDs with complex contents may contain guide menus, and DVDs with multiple languages may contain audio and subtitle language menus.

These menus are called "DVD menus".

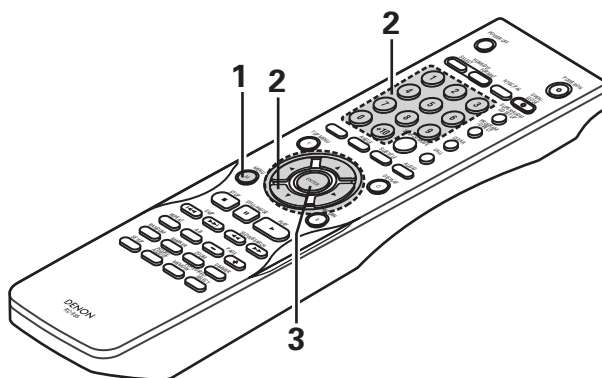
Here we describe the general procedure for using DVD menus.

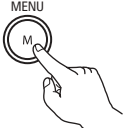
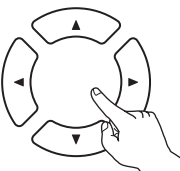
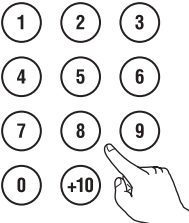

| | | |
|-----------------|---|---|
| <p>1</p> | <p>During playback, press the MENU button.</p> <ul style="list-style-type: none"> The DVD menu appears. | <p>Example:</p>  <p>Remote control unit</p> <div data-bbox="1203 836 1459 1027" style="border: 1px solid gray; padding: 5px;"> <p style="text-align: center;">DVD MENU</p> <p>1. SUB TITLE</p> <p>2. AUDIO</p> <p>3. ANGLE</p> </div> |
| <p>2</p> | <p>Use the cursor or number buttons to select the desired item.</p> <ul style="list-style-type: none"> If you select the item using the number buttons, skip step 3 below. | <p>Example: "AUDIO" is selected</p>  <p>Remote control unit</p>  <p>Remote control unit</p> <div data-bbox="1203 1257 1459 1449" style="border: 1px solid gray; padding: 5px;"> <p style="text-align: center;">DVD MENU</p> <p>1. SUB TITLE</p> <p>2. AUDIO</p> <p>3. ANGLE</p> </div> |
| <p>3</p> | <p>Press the ENTER button.</p> <ul style="list-style-type: none"> The selected item is set. If more menus appear, repeat steps 2 and 3. |  <p>Remote control unit</p> |

20 MARKING SCENES YOU WANT TO SEE AGAIN

■ Set marks at scenes you want to see again so that you can start playback from the marked position whenever you want.

Setting Marks (DVD-AUDIO / DVD-VIDEO)

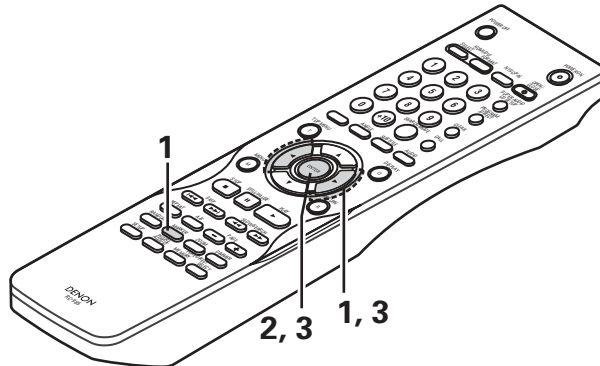

| | | |
|-----------------|--|----------------------------|
| <p>1</p> | <p>During playback, press the MARKER button.</p> <ul style="list-style-type: none"> • The marker screen appears. • Use the ◀ and ▶ cursor buttons to select the " ❄ " marks. • " ❄ " is displayed if the mark is not set. | <p>Remote control unit</p> |
| <p>2</p> | <p>Press the ENTER button at the scene you want to mark.</p> <ul style="list-style-type: none"> • A number is displayed. • Up to five marks can be set. (To select another marker, use the cursor buttons (◀, ▶).) | <p>Remote control unit</p> |

Calling Out Marked Scenes and Clearing Marks

| | | |
|--|---|---|
| <p>3</p> | <p>Use the ◀ and ▶ cursor buttons to select the marker number and press the ENTER button.</p> <ul style="list-style-type: none"> • If the marker screen is not displayed during playback, press the MARKER button to display it. | <p>Remote control unit Remote control unit</p> |
| <p>* To clear the marker display: Press the MARKER button.</p> <p>* To clear a marker: Use the ◀ and ▶ cursor buttons to select a marker number and press the CLEAR button.</p> <ul style="list-style-type: none"> • You can clear existing markers, but they are restored when you open the disc tray or switch the unit to standby. | | |

NOTES:

- All the markers added with this unit are cleared when the unit is switched to standby or the disc tray is opened.
- Depending on where the marker is set, subtitles may not be displayed.

21 PLAYING IN THE ZOOM MODE

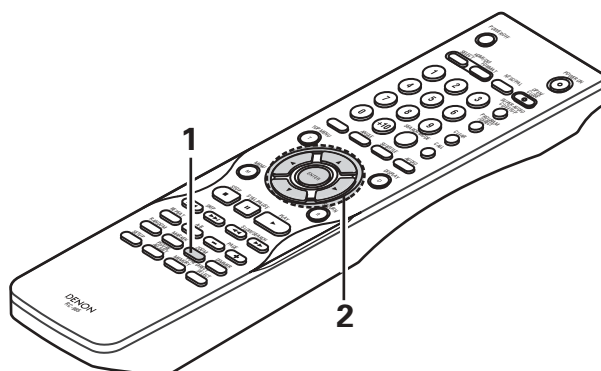

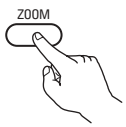
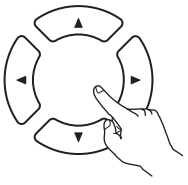
| | | |
|-----------------|---|--|
| <p>1</p> | <p>In the play or pause mode, press the ZOOM button.</p> <ul style="list-style-type: none"> The zoom rate increases each time the ZOOM button is pressed. For DVD video discs and video CDs: OFF → x1.5 → x2 → x4 → OFF For DVD audio discs: OFF → x2 → x4 → OFF When "PLAYER MODE" at "OTHER SETUP" in "SETUP" is set to "AUDIO", zooming is not possible at still pictures. |  <p>Remote control unit</p> |
| <p>2</p> | <p>Use the cursor buttons (▼, ▲, ◀ and ▶) to move the zoomed picture.</p> |  <p>Remote control unit</p> |

NOTES:

- Zooming is not possible with some discs.
- The zoom function may not work properly at some scenes.
- Zooming is not possible at the top menu or the menu screen.
- When the picture is enlarged, the picture quality may be decreased and the picture may be blurred.

22 PLAYING MP3

Listening to MP3 CD, CD-Rs and CD-RWs





There are many music distribution sites on the internet from which music files in MP3 format can be downloaded. Music downloaded as instructed on the site and written onto a CD-R/RW disc can be played on the DVD-2910/955.

If music recorded on commercially available music CDs is converted on a computer into MP3 files using an MP3 encoder (conversion software), the data on a 12 cm CD is reduced into about 1/10 the amount of the original data. Thus, when written in MP3 format, the data of about 10 music CDs can fit onto the one CD-R/RW disc. The one CD-R/RW disc can contain over 100 tracks.

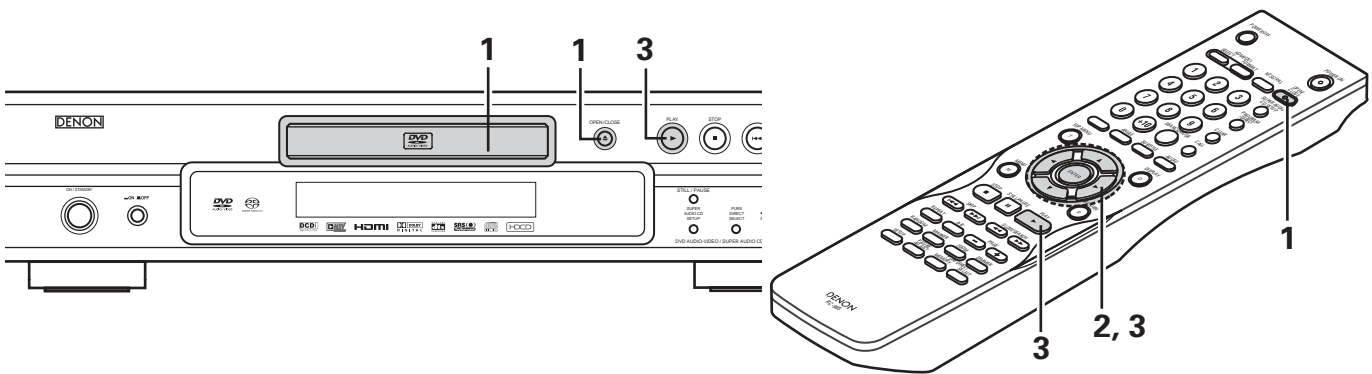
* Values when 5-minute tracks are converted with a standard bit rate of 128 kbps into MP3 files and using a CD-R/RW disc with a capacity of 650 MB.

* **Uses of recordings you have made other than for your personal enjoyment are not permitted under the Copyright Law without permission of the copyright holder.**

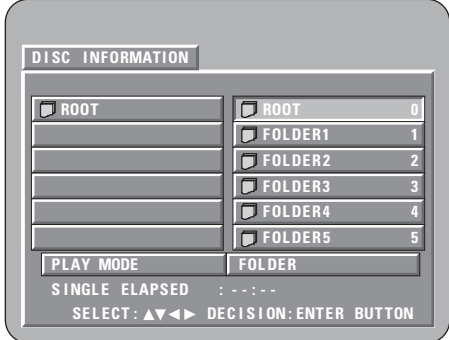
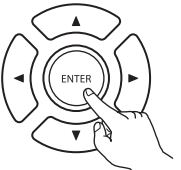

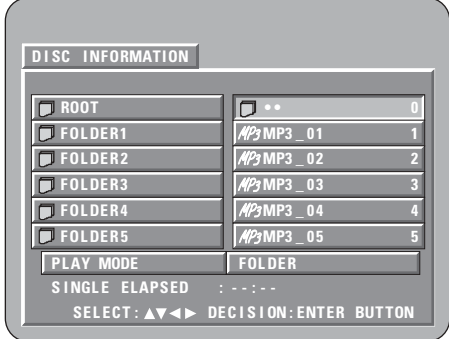
| <p>1</p> | <p>Load the CD-R/RW disc on which the MP3 format music files have been written into the DVD-2910/955. (See page 22.)</p> <ul style="list-style-type: none"> When the disc is loaded in the DVD-2910/955, the disc information screen appears. If there are multiple folders, proceed to step 2. If there are no folders on the disc, proceed to step 3. | <p>OPEN/CLOSE</p>  <p>Main unit</p> <p>OPEN/CLOSE</p>  <p>Remote control unit</p>  <table border="1"> <thead> <tr> <th colspan="2">DISC INFORMATION</th> </tr> </thead> <tbody> <tr> <td>ROOT</td> <td>0</td> </tr> <tr> <td>FOLDER1</td> <td>1</td> </tr> <tr> <td>FOLDER2</td> <td>2</td> </tr> <tr> <td>FOLDER3</td> <td>3</td> </tr> <tr> <td>FOLDER4</td> <td>4</td> </tr> <tr> <td>FOLDER5</td> <td>5</td> </tr> </tbody> </table> <p>PLAY MODE: FOLDER SINGLE ELAPSED: : - : - : SELECT: ▲▼◀▶ DECISION: ENTER BUTTON</p> | DISC INFORMATION | | ROOT | 0 | FOLDER1 | 1 | FOLDER2 | 2 | FOLDER3 | 3 | FOLDER4 | 4 | FOLDER5 | 5 |
|------------------|--|---|------------------|--|------|------|---------|--------------|---------|--------------|---------|--------------|---------|--------------|---------|--------------|
| DISC INFORMATION | | | | | | | | | | | | | | | | |
| ROOT | 0 | | | | | | | | | | | | | | | |
| FOLDER1 | 1 | | | | | | | | | | | | | | | |
| FOLDER2 | 2 | | | | | | | | | | | | | | | |
| FOLDER3 | 3 | | | | | | | | | | | | | | | |
| FOLDER4 | 4 | | | | | | | | | | | | | | | |
| FOLDER5 | 5 | | | | | | | | | | | | | | | |
| <p>2</p> | <p>Use the cursor buttons (▼, ▲, ◀ and ▶) to select the folder containing the file(s) you want to play, then press the ENTER button.</p> <p>* To change the folder Use the cursor buttons to select "ROOT", then press the ENTER button. The screen in step 1 reappears. Select the desired folder.</p> | <p>Remote control unit</p>  <p>Remote control unit</p>  <p>Remote control unit</p>  <table border="1"> <thead> <tr> <th colspan="2">DISC INFORMATION</th> </tr> </thead> <tbody> <tr> <td>ROOT</td> <td>** 0</td> </tr> <tr> <td>FOLDER1</td> <td>MP3 MP3_01 1</td> </tr> <tr> <td>FOLDER2</td> <td>MP3 MP3_02 2</td> </tr> <tr> <td>FOLDER3</td> <td>MP3 MP3_03 3</td> </tr> <tr> <td>FOLDER4</td> <td>MP3 MP3_04 4</td> </tr> <tr> <td>FOLDER5</td> <td>MP3 MP3_05 5</td> </tr> </tbody> </table> <p>PLAY MODE: FOLDER SINGLE ELAPSED: : - : - : SELECT: ▲▼◀▶ DECISION: ENTER BUTTON</p> | DISC INFORMATION | | ROOT | ** 0 | FOLDER1 | MP3 MP3_01 1 | FOLDER2 | MP3 MP3_02 2 | FOLDER3 | MP3 MP3_03 3 | FOLDER4 | MP3 MP3_04 4 | FOLDER5 | MP3 MP3_05 5 |
| DISC INFORMATION | | | | | | | | | | | | | | | | |
| ROOT | ** 0 | | | | | | | | | | | | | | | |
| FOLDER1 | MP3 MP3_01 1 | | | | | | | | | | | | | | | |
| FOLDER2 | MP3 MP3_02 2 | | | | | | | | | | | | | | | |
| FOLDER3 | MP3 MP3_03 3 | | | | | | | | | | | | | | | |
| FOLDER4 | MP3 MP3_04 4 | | | | | | | | | | | | | | | |
| FOLDER5 | MP3 MP3_05 5 | | | | | | | | | | | | | | | |

3

Use the ▲ and ▼ cursor buttons to select the MP3 file you want to play, then press the PLAY button or ENTER button.

- Playback starts.

* The display can be switched between the single elapsed time and the single remaining time and the track name by pressing the DISPLAY button.

* Programmed playback is not possible with MP3 discs.

* **To change the MP3 file**

Press the STOP button, then use the ▲ and ▼ cursor buttons to reselect the desired MP3 file.

* **To set the random play mode**

In the stop mode, press the RANDOM button.

Then press the PLAY button or ENTER button.

* **To set the repeat mode**

The repeat mode changes each time the REPEAT button is pressed.



* **To return to the initial disc information screen**

Press the STOP button, use the cursor button to select "ROOT", then press the ENTER button.

The screen in step 1 reappears.



Remote control unit



Main unit

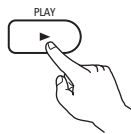

Remote control unit

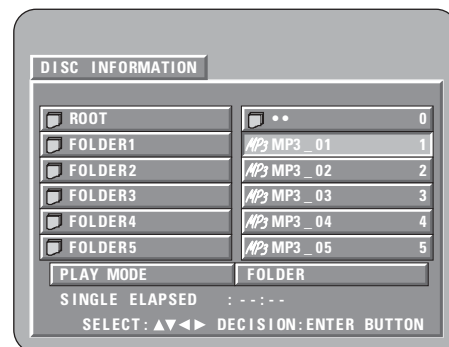

NOTES:

- The DVD-2910/955 is compatible with the "MPEG-1 Audio Layer 3" standards (sampling frequency of 44.1 kHz or 48 kHz). It is not compatible with such other standards as "MPEG-2 Audio Layer 3", "MPEG-2.5 Audio Layer 3", MP1, MP2, etc.
- It may not be possible to play some CD-R/RW discs due to disc properties, dirt, warping, etc.
- The digital signals output when playing MP3 files are MP3 signals converted into PCM, regardless of whether the audio output presetting is set to "normal" or "PCM". The signals are output with the same sampling frequency as that of the music source.
- In general, the higher an MP3 file's bit rate, the better the sound quality. On the DVD-2910/955, we recommend using MP3 files recorded with bit rates of 128 kbps or greater.
- MP3 files may not be played in the expected order, since the writing software may change the position of the folders and the order of the files when writing them on the CD-R/RW.
- Programmed playback are not possible with MP3 discs.
- When writing MP3 files on CD-R/RW discs, select "ISO9660 level 1" as the writing software format. This may not be possible with some types of writing software. For details, refer to the writing software's usage instructions.
- The number of files playable with the DVD-2910/955 is approximately 600 or less.
- With the DVD-2910/955 it is possible to display folder names and file names on the screen like titles. The DVD-2910/955 can display up to 8 characters, consisting of numbers, capital letters, and the "_" (underscore) mark.
- If recorded in a format other than "ISO9660 level 1", normal display and playback may not be possible. In addition, folder and file names including other symbols will not be displayed properly.
- Be sure to add the extension ".MP3" to MP3 files. Files cannot be played if they have any extension other than ".MP3" or if they have no extension. (with Macintosh computers, MP3 files can be played by adding the extension ".MP3" after the file name consisting of up to 8 capital or numbers and recording the files on the CD-R/RW.)
- Do not apply stickers, tape, etc., to either the label side or the signal side of CD-R/RW discs. If adhesive gets on the surface of a disc, the disc may get stuck inside the DVD-2910/955 and be impossible to eject.
- The DVD-2910/955 is not compatible with packet write software.
- The DVD-2910/955 is not compatible with ID3-Tag.
- The DVD-2910/955 is not compatible with play lists.
- The DVD-2910/955 is not compatible with MP3 PRO.
- Do not play CD-R/RW discs containing any files other than music CD files (in CD-DA format), WMA, MP3 and JPEG files. Doing so may result in malfunction or damage, depending on the type of file.

23 PLAYING WMA

■ Listening to WMA (Windows Media Audio) CD-R/CD-RW

- This unit can play CD-R/RW music files that have been recorded in the WMA (Windows Media Audio)* audio compression format.



Windows Media and the Windows logo are trademarks, or registered trademarks of Microsoft Corporation in the United States and/or other countries.

* WMA (Windows Media Audio): New audio coding of Microsoft Corporation.

*** Uses of recordings you have made other than for your personal enjoyment are not permitted under the Copyright Law without permission of the copyright holder.**

- The method of playback is the same as "Listening to Recorded MP3 CD/CD-R/CD-RW" on Pages 67 and 68.
 - In the file display of the disc information screen, WMA files will be displayed with the "WMA" icon instead of the "MP3" icon. (Files for which the "WMA" icon is not displayed cannot be played. There will be a skip and the next file with an icon will be played.)

NOTES:

- Files recorded with a sampling frequency (fs) of 44.1, and 48 kHz are supported.
- Programmed playback cannot be performed with WMA discs.
- The digital output at the time of WMA file playback is converted to PCM regardless of the initial settings.
- Please use discs that have been recorded in conformity with the ISO 9660 level 1/level 2 CD-ROM file system. (Extended formats are excluded.)
- Copyright protected files cannot be played. Also note that depending on the writing software and conditions, playback might not be possible, or the files might not be displayed properly.
- Playback of the CD-R/RW might not be possible depending on the disc characteristics, soiling, scratches, and other factors.
- Bit rates of 64 k to 160 kbps are supported for WMA files that have an extension of ".wma" or ".WMA".
- This unit can display the folder names and file names on the screen. Up to 11 half-width alphanumeric upper case characters and symbols (including the underscore symbol) can be displayed. Kanji, hiragana, katakana and other characters cannot be displayed.
- While in the stop condition, the DISPLAY button of the remote control can be used to switch and display the title names and the artist names. (One folder has a capacity of up to 99 files.)
- Recorded discs with no more than 99 files per folder are recommended. Multiple folder configurations are possible; however, depending on the configuration, recognition and playback of all the folders and files might not be possible.
- Multi-session discs can also be played back, however, playback of discs that have had session closure within 10 sessions.
- Direct track selection using the remote control numerical keys (0 to 9, and +10) can specify up to 179 tracks (179 files) per folder. When 179 tracks are exceeded, while the unit is stopped, use the cursor buttons at the disc information screen to select the files, and use the play button or the ENTER button to play.

24 PLAYING STILL PICTURE FILES (JPEG FORMAT)

JPEG files stored on Kodak picture CDs, Fujicolor CDs, CD-Rs and CD-RWs can be played as a slide show and enjoyed on the DVD-2910/955.

Playing still picture

Kodak picture CDs and Fujifilm Fujicolor CDs can be played on the DVD-2910/955.

When a CD (recording still picture) is played, the photographs on the CD can be displayed on a TV.

("Picture CD" and "Fujicolor CD" are service by which photographs taken on conventional silver film cameras are converted into digital data and written on CDs. For details on Kodak picture CD, contact a store that offers Kodak development services. For details about Fujicolor CDs, please contact a store offering Fuji Photo Film developing services.)

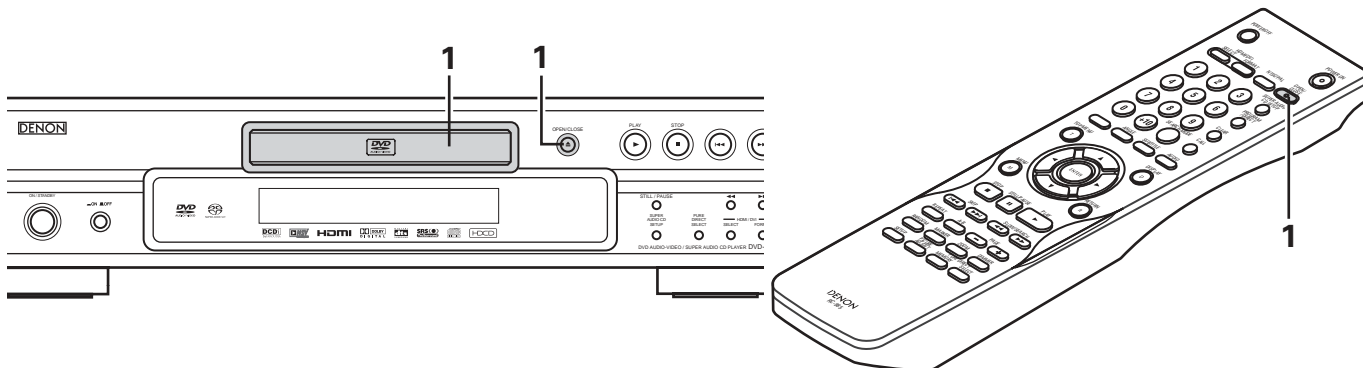

1

Load the Kodak picture CD into the DVD-2910/955.

- When the disc is loaded, a slide show of the still pictures begins automatically.
- The slide show continues until the STOP button is pressed.

Load the Fujicolor CD into the DVD-2910/955.

- When the disc is loaded, a maximum of 9 still pictures are displayed automatically.
- The slide show continues until the STOP button is pressed.

OPEN/CLOSE



Main unit

OPEN/CLOSE

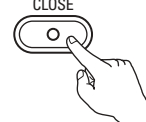

Remote control unit

Playing still pictures stored on CD-Rs/RWs

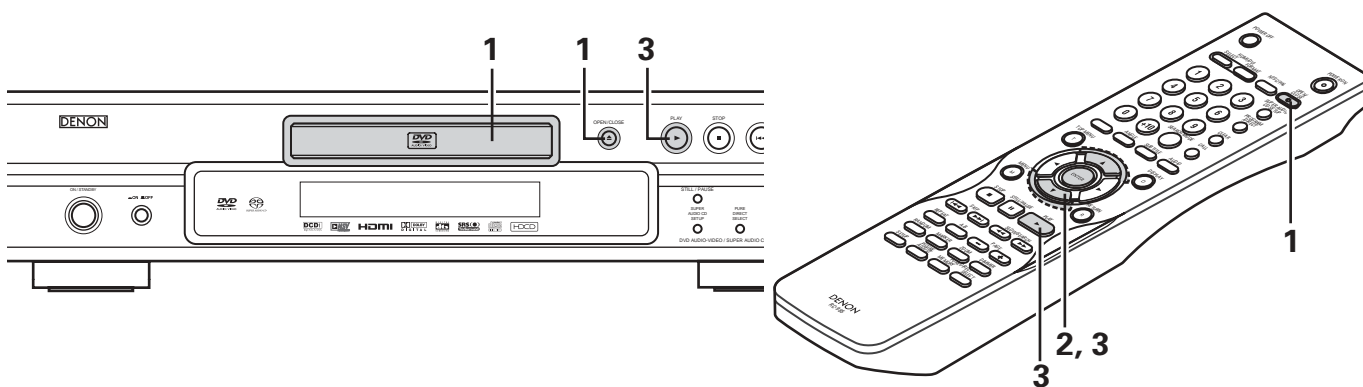

1

Load the CD-R/RW on which the still pictures have been written into the DVD-2910/955.

- When the disc is loaded in the DVD-2910/955, the disc information screen appears.

- If there are multiple folders, proceed to step 2.
- If there are no folders on the disc, proceed to step 3.

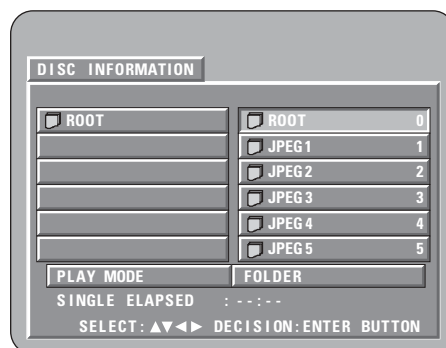

2

Use the ▲ and ▼ cursor buttons to select the folder containing the file(s) you want to play, then press the ENTER button.

*** To change the folder**

Use the cursor button to select "ROOT", then press the ENTER button. The screen in step 1 reappears. Select the desired folder.

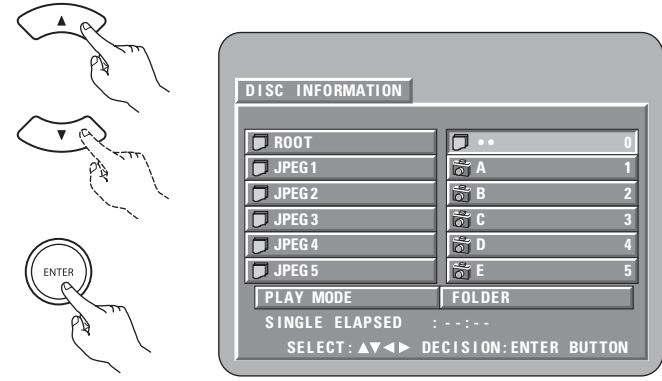

Remote control unit

3

Use the ▲ and ▼ cursor buttons on the remote control unit to select the still picture file from which you want to start the slide show, then press the PLAY button or the ENTER button on the remote control unit.

- The slide show starts.
- Only the still picture files in the selected folder are played.

*** Once all the still picture files in the folder have been played, the disc information screen reappears.**

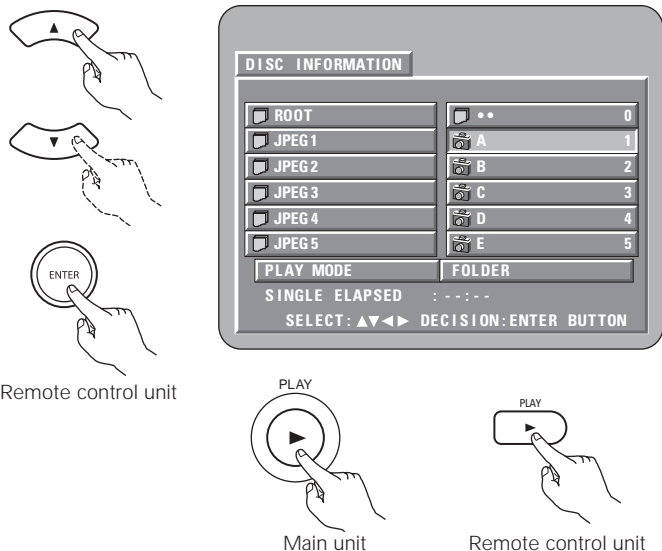

Remote control unit

Main unit

Remote control unit

- * To view several of the still pictures stored on the disc at once:
 - To select and view a still picture (to start the slide show from a specific still picture), use the cursor buttons (▼, ▲, ◀ and ▶) to select the desired still picture, then press the ENTER button.
- * To temporarily stop the slide show:
 - Press the STILL/PAUSE button.
 - To resume the slide show, press the PLAY button.
- * To cue a still picture you want to view (from which you want to start the slide show):
 - During the slide show, press one of the SKIP (◀◀, ▶▶) buttons. Press the SKIP ◀◀ button to cue back to the previous still picture, the SKIP ▶▶ button to cue ahead to the next still picture.
- * Flipping and rotating still pictures:
 - Use the cursor buttons (▼, ▲, ◀ and ▶) to flip the still picture.
 - ▲ cursor button: The currently displayed still picture is flipped vertically.
 - ▼ cursor button: The currently displayed still picture is flipped horizontally.
 - ◀ cursor button: The currently displayed still picture is rotate 90° counterclockwise.
 - ▶ cursor button: The currently displayed still picture is rotate 90° clockwise.
- * Play the image in the zoom mode.
 - When the ZOOM button is pressed while playing a JPEG image ("ZOOM ON" is displayed on the screen at this time) zoom in and zoom out using the search keys.
 - ◀◀: zoom out, ▶▶: zoom in
 - When the image is zoomed, use the cursor buttons (▼, ▲, ◀ and ▶) to move the zoomed picture.
 - Continuous playback (SLIDE SHOW) is not possible in the zoom mode.
 - Zooming is not possible with files that have a low resolution.
- * The way of switching to the next image during continuous JPEG image playback (SLIDE SHOW) can be selected.
 - Preset the SEARCH MODE button on the remote control unit.
 - Select from SLIDE SHOW MODE:1 to MODE: 11, MODE: RAND and MODE: NONE.

Special play modes for WMA and MP3 and JPEG files

Use the ◀ and ▶ cursor buttons to select the play mode, the ▲ and ▼ cursor buttons to select the special play mode.

- FOLDER (the WMA and MP3 and JPEG files in the folder are played in order starting from the selected file)
- FOLDER REPEAT (all the WMA and MP3 and JPEG files in the folder are played repeatedly starting from the selected file)
- DISC (all the WMA and MP3 and JPEG files on the disc are played in order starting from the selected file)
- DISC REPEAT (all the WMA and MP3 and JPEG files on the disc are played repeatedly starting from the selected file)
- RANDOM ON (all the WMA and MP3 and JPEG files in the folder are played in random order starting from the selected file)
- TRACK REPEAT (the select WMA or MP3 or JPEG file is played repeatedly)

NOTES:

- The DVD-2910/955 is compatible with image data stored in JPEG format, but Denon does not guarantee that all image data stored in JPEG format can be viewed.
- Files with sizes of up to 30 Mbytes can be displayed.
- It may not be possible to play some CD-Rs/RWs due to disc properties, dirt, scratches, etc.
- When storing JPEG files on the CD-R/RW, set the writing program to store the files in the "ISO9660 level 1" format.
- Be sure to give JPEG files the extension ".JPG" and ".JPE". Files with other extensions or with no extensions cannot be viewed on the DVD-2910/955.
- Do not apply stickers, tape, etc., to either the label side or the signal side of CD-R/RW discs. If adhesive gets on the surface of a disc, the disc may get stuck inside the DVD-2910/955 and be impossible to eject.
- Do not play CD-R/RW discs containing any files other than music CD files (in CD-DA format), WMA, MP3 and JPEG files. Doing so may result in malfunction or damage, depending on the type of file.
- JPEG files written using Macintosh computers cannot be played.

25 TROUBLESHOOTING

Check again before assuming the player is malfunctioning

■ Are all the connections correct ?

■ Are you following the instructions in the manual ?

■ Are the amplifier and speakers operating properly ?

If the DVD-2910/955 does not seem to be functioning properly, check the table below. If this does not solve the problem, the DVD-2910/955 may be damaged. Turn off the power, unplug the power cord from the power outlet, and contact your store of purchase or nearest Denon sales office.

| Symptom | Check | Page |
|--|---|--|
| Power does not turn on. | <ul style="list-style-type: none"> Plug the power supply cord securely into the power outlet. | 10-17, 19 |
| Playback does not start when PLAY button is pressed. Playback stops immediately. | <ul style="list-style-type: none"> Is there condensation on the disc or player ? (Let stand for 1 or 2 hours.) Discs other than DVDs, SuperAudio CDs, video CDs and music CDs cannot be played. Disc is dirty. Wipe off the dirt. | - 8 9 |
| Picture does not appear. | <ul style="list-style-type: none"> Check the connections. Check that VIDEO OUT has not been set to "VIDEO OUT:OFF" or "ALL OFF" for PURE DIRECT MODE. Set the TV's input to "video". When the HDMI or DVI-D connector output the signals, no progressive signals from the component video connector. If you wish to use the component video output, set to "OFF" for HDMI/DVI SELECT. | 10-17 43, 44 - 16, 17, 49 |
| Sound is not produced or sound quality is poor. | <ul style="list-style-type: none"> Check the connections. Properly set the input of the TV, stereo, etc. Check the "DIGITAL OUTPUT" and "COMPRESSION" settings. Digital signals cannot be output with Super audio CDs. Use analog connections. Area/layer of Super audio CD being played (MULTI/STEREO/CD) does not match amplifier connections. When the video output setting at "PURE DIRECT" is set to "VIDEO : OFF" or "ALL OFF", no sound at HDMI connector. | 10-17 - 34, 37, 38 14, 15 14, 15, 44 43, 44 |
| Menu playback of video CD's is not possible. | <ul style="list-style-type: none"> Menu playback is not possible with anything but video CDs with playback control. | 51 |
| Picture is disturbed during the search operation. | <ul style="list-style-type: none"> Some disturbance is normal. | - |
| Buttons do not operate. | <ul style="list-style-type: none"> Some operations are disabled for some discs. | 51 |
| No subtitles are displayed. | <ul style="list-style-type: none"> Subtitles are not displayed for DVDs not containing subtitles. Subtitles are turned off. Turn the subtitles setting on. | - 26, 27 |
| Audio (or subtitle) language does not switch. | <ul style="list-style-type: none"> The audio (or subtitle) language does not switch for discs which do not include multiple audio (or subtitle) languages. For some discs the audio (or subtitle) language cannot be switched when the operation to switch it is performed, but can be switched on the menu screens. | 60, 61 64 |
| Angle does not switch. | <ul style="list-style-type: none"> The angle cannot be switched for DVDs which do not contain multiple angles. In some cases multiple angles are only recorded for specific scenes. | 62 |
| Playback does not start when the title is selected. | <ul style="list-style-type: none"> Check the "RATINGS" setting. | 39, 40 |
| The password for rating level has been forgotten. Reset all the setting to Factory Preset. | <ul style="list-style-type: none"> While the player is in the stop mode, hold the player's SKIP ►►► button and the PLAY button down simultaneously and then hold the OPEN/CLOSE button down for longer than 3 seconds (until "INITIALIZE" disappears from the TV monitor). The lock will be released and all default settings and picture settings will return to the default values. | - |
| The disc is not played with the audio or subtitle language set as the default setting. | <ul style="list-style-type: none"> The disc does not play with the selected audio or subtitle language if that audio or subtitle language is not included on that DVD. | 26-28 |
| Picture is not displayed in 4:3 (or 16:9). | <ul style="list-style-type: none"> Set the "TV ASPECT" default setting to the proper setting for the connected TV. | 32 |
| Menu screen messages for the desired language do not display. | <ul style="list-style-type: none"> Check the default setting for the disc language's menu language. | 26-28 |

| Symptom | Check | Page |
|---|--|---|
| <p>An image is not projected with an HDMI/DVI connection.</p> | <ul style="list-style-type: none"> • Check the HDMI/DVI connection.(Check the status of the HDMI/DVI-related indicators.) • Check whether the connected monitor equipment or other equipment supports HDCP. (The DVD-2910/955 will not output a video signal unless the other equipment supports HDCP) • Check the settings of "HDMI/DVI SELECT". • Check whether the output format of the DVD-2910/955 (HDMI/DVI FORMAT) matches the supported input format of other connected equipment. • Check whether the video output setting at "PURE DIRECT" is set to "VIDEO: OFF" or "ALL OFF". | <p>16, 17 16, 17 49 16, 17 43, 44</p> |
| <p>Remote control unit does not operate.</p> | <ul style="list-style-type: none"> • Check that the batteries are inserted in the proper "⊕" and "⊖" directions. • The batteries are dead. Replace them with new batteries. • Point the remote control unit at the remote control sensor when operating it. • Operate the remote control unit within a distance of 7 meters from the remote control sensor. • Remove the obstacle between the remote control unit and remote control sensor. | <p>20 20 20 20 20</p> |

26 MAIN SPECIFICATIONS

| | |
|-------------------------------------|---|
| Signal system: | NTSC/PAL |
| Applicable discs: | (1) DVD-Audio/DVD-Video discs 1-layer 12 cm single-sided discs, 2-layer 12 cm single-sided discs, 2-layer 12 cm double-sided discs (1 layer per side) 1-layer 8 cm single-sided discs, 2-layer 8 cm single-sided discs, 2-layer 8 cm double-sided discs (1 layer per side) (2) Super audio CDs Single layer 12 cm discs, Dual layer 12 cm discs, Hybrid layer 12 cm discs (3) Compact discs (CD-DA, Video CD) 12 cm discs, 8 cm discs |
| S-Video output: | Y output level : 1 Vp-p (75 Ω /ohms) C output level: 0.286 Vp-p Output connector : S connector, 1 set |
| Video output: | Output level : 1 Vp-p (75 Ω /ohms) Output connector : Pin jack, 1 set |
| Component output: | Y output level : 1 Vp-p (75 Ω /ohms) PB/CB output level : 0.648 Vp-p (75 Ω /ohms) PR/CR output level: 0.648 Vp-p (75 Ω /ohms) Output connector : Pin jack, 1 set |
| HDMI output: | Output connector : HDMI connector, 1 set |
| DVI output: | Output connector : DVI-D connector, 1 set |
| Audio output: | Output level : 2 Vrms (10 Ω /ohms) 2 channel (L, R) output connector: Pin jack, 1 set Multi channel (FL, FR, C, SW, SL, SR) output connector: Pin jack, 1 set |
| Audio output properties: | (1) Frequency response ① DVDs (linear PCM) : 2 Hz to 22 kHz (48 kHz sampling) : 2 Hz to 44 kHz (96 kHz sampling) : 2 Hz to 88 kHz (192 kHz sampling) ② Super audio CDs : 2 Hz to 100 kHz ③ CDs : 2 Hz to 20 kHz (2) S/N ratio : 118 dB (3) Total harmonic distortion : 0.001 % (4) Dynamic range : 106 dB |
| Digital audio output: | Optical digital output : Optical connector, 1 set Coaxial digital output : Pin jack, 1 set |
| Power supply: | AC 120 V, 60 Hz |
| Power consumption: | 28 W |
| Maximum external dimensions: | 434 (width) x 101 (height) x 322 (depth) mm (17-3/32" x 3-63/64" x 12-11/16") (including protruding parts) |
| Mass: | 5.5 kg (18 lbs 12 oz) |
| Remote control unit: | RC-985 |
| Type: | Infrared pulse |
| Power supply: | DC 3 V, 2 R6P/AA batteries |

This product incorporates copyright protection technology that is protected by method claims of certain U.S. patents and other intellectual property rights owned by Macrovision Corporation and other rights owners. Use of this copyright protection technology must be authorized by Macrovision Corporation, and is intended for home and other limited viewing uses only unless otherwise authorized by Macrovision Corporation. Reverse engineering or disassembly is prohibited.

* Design and specifications are subject to change without notice in the course of product improvement.

MEMO:

DENON, Ltd.

TOKYO, JAPAN
www.denon.com

Printed in China 511 4192 003

Free Manuals Download Website

<http://myh66.com>

<http://usermanuals.us>

<http://www.somanuals.com>

<http://www.4manuals.cc>

<http://www.manual-lib.com>

<http://www.404manual.com>

<http://www.luxmanual.com>

<http://aubethermostatmanual.com>

Golf course search by state

<http://golfingnear.com>

Email search by domain

<http://emailbydomain.com>

Auto manuals search

<http://auto.somanuals.com>

TV manuals search

<http://tv.somanuals.com>