

DENON

CD AUTO CHANGER

DCM-500AE

OPERATING INSTRUCTIONS

BEDIENUNGSANLEITUNG

MODE D'EMPLOI

ISTRUZIONI PER L'USO

INSTRUCCIONES DE FUNCIONAMIENTO

GEBRUIKSAANWIJZING

BRUKSANVISNING

■ SAFETY PRECAUTIONS



CAUTION

RISK OF ELECTRIC SHOCK

DO NOT OPEN



CAUTION:
TO REDUCE THE RISK OF ELECTRIC SHOCK, DO NOT REMOVE COVER (OR BACK). NO USER-SERVICEABLE PARTS INSIDE. REFER SERVICING TO QUALIFIED SERVICE PERSONNEL.



The lightning flash with arrowhead symbol, within an equilateral triangle, is intended to alert the user to the presence of uninsulated "dangerous voltage" within the product's enclosure that may be of sufficient magnitude to constitute a risk of electric shock to persons.



The exclamation point within an equilateral triangle is intended to alert the user to the presence of important operating and maintenance (servicing) instructions in the literature accompanying the appliance.

WARNING:
TO REDUCE THE RISK OF FIRE OR ELECTRIC SHOCK, DO NOT EXPOSE THIS APPLIANCE TO RAIN OR MOISTURE.

CLASS 1 LASER PRODUCT
LUOKAN 1 LASERLAITE
KLASS 1 LASERAPPARAT

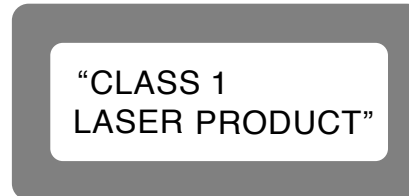

ADVARSEL: USYNLIG LASERSTRÅLING VED ÅBNING, NÅR SIKKERHEDSAFBRYDERE ER UDE AF FUNKTION. UNDGÅ UDSÆTTELSE FOR STRÅLING.

VAROITUS! LAITTEEN KÄYTTÄMINEN MUULLA KUIN TÄSSÄ KÄYTTÖOHJEESSA MAINITULLA TAVALLA SAATTAA ALTISTAA KÄYTTÄJÄN TURVALLISUUSLUOKAN 1 YLITTÄVÄLLE NÄKYMÄMTTÖMÄLLE LASERSÄTEILYLLE.

WARNING: OM APPARATEN ANVÄNDS PÅ ANNAT SÄTT ÄN I DENNA BRUKSANVISNING SPECIFICERATS, KAN ANVÄNDAREN UTSÄTTAS FÖR OSYNLIG LASERSTRÅLNING SOM ÖVERSKRIDER GRÄNSEN FÖR LASERKLASS 1.

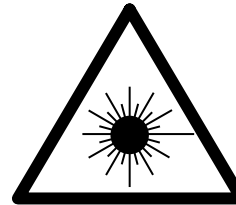





ATTENZIONE: QUESTO APPARECCHIO E' DOTATO DI DISPOSITIVO OTTICO CON RAGGIO LASER. L'USO IMPROPRIO DELL'APPARECCHIO PUO' CAUSARE PERICOLOSE ESPOSIZIONI A RADIAZIONI!

CAUTION:
USE OF CONTROLS OR ADJUSTMENTS OR PERFORMANCE OF PROCEDURES OTHER THAN THOSE SPECIFIED HEREIN MAY RESULT IN HAZARDOUS RADIATION EXPOSURE.
THE SUPER AUDIO CD PLAYER SHOULD NOT BE ADJUSTED OR REPAIRED BY ANYONE EXCEPT PROPERLY QUALIFIED SERVICE PERSONNEL.

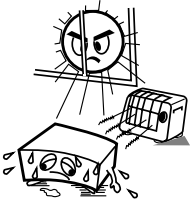
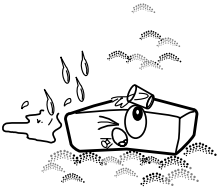
- **DECLARATION OF CONFORMITY**
We declare under our sole responsibility that this product, to which this declaration relates, is in conformity with the following standards: EN60065, EN55013, EN55020, EN61000-3-2 and EN61000-3-3. Following the provisions of 73/23/EEC, 2004/108/EC and 93/68/EEC Directive.
- **ÜBEREINSTIMMUNGSERKLÄRUNG**
Wir erklären unter unserer Verantwortung, daß dieses Produkt, auf das sich diese Erklärung bezieht, den folgenden Standards entspricht: EN60065, EN55013, EN55020, EN61000-3-2 und EN61000-3-3. Entspricht den Verordnungen der Direktive 73/23/EEC, 2004/108/EC und 93/68/EEC.
- **DECLARATION DE CONFORMITE**
Nous déclarons sous notre seule responsabilité que l'appareil, auquel se réfère cette déclaration, est conforme aux standards suivants: EN60065, EN55013, EN55020, EN61000-3-2 et EN61000-3-3. D'après les dispositions de la Directive 73/23/EEC, 2004/108/EC et 93/68/EEC.
- **DICHIARAZIONE DI CONFORMITÀ**
Dichiariamo con piena responsabilità che questo prodotto, al quale la nostra dichiarazione si riferisce, è conforme alle seguenti normative: EN60065, EN55013, EN55020, EN61000-3-2 e EN61000-3-3. In conformità con le condizioni delle direttive 73/23/EEC, 2004/108/EC e 93/68/EEC. QUESTO PRODOTTO E' CONFORME AL D.M. 28/08/95 N. 548
- **DECLARACIÓN DE CONFORMIDAD**
Declaramos bajo nuestra exclusiva responsabilidad que este producto al que hace referencia esta declaración, está conforme con los siguientes estándares: EN60065, EN55013, EN55020, EN61000-3-2 y EN61000-3-3. Siguiendo las provisiones de las Directivas 73/23/EEC, 2004/108/EC y 93/68/EEC.
- **EENVORMIGHEIDSVERKLARING**
Wij verklaren uitsluitend op onze verantwoordelijkheid dat dit product, waarop deze verklaring betrekking heeft, in overeenstemming is met de volgende normen: EN60065, EN55013, EN55020, EN61000-3-2 en EN61000-3-3. Volgens de bepalingen van de Richtlijnen 73/23/EEC, 2004/108/EC en 93/68/EEC.
- **ÖVERENSSTÄMMELSESINTYG**
Härmed intygas helt på eget ansvar att denna produkt, vilken detta intyg avser, uppfyller följande standarder: EN60065, EN55013, EN55020, EN61000-3-2 och EN61000-3-3. Enligt stadgarna i direktiv 73/23/EEC, 2004/108/EC och 93/68/EEC.

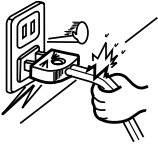
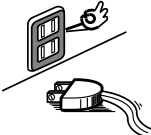
NOTE ON USE / HINWEISE ZUM GEBRAUCH / OBSERVATIONS RELATIVES A L'UTILISATION / NOTE SULL'USO / NOTAS SOBRE EL USO / ALVORENS TE GEBRUIKEN / OBSERVERA

 <ul style="list-style-type: none"> • Avoid high temperatures. Allow for sufficient heat dispersion when installed in a rack. • Vermeiden Sie hohe Temperaturen. Beachten Sie, daß eine ausreichend Luftzirkulation gewährleistet wird, wenn das Gerät auf ein Regal gestellt wird. • Eviter des températures élevées. Tenir compte d'une dispersion de chaleur suffisante lors de l'installation sur une étagère. • Evitate di esporre l'unità a temperature alte. Assicuratevi che ci sia un'adeguata dispersione del calore quando installate l'unità in un mobile per componenti audio. • Evite altas temperaturas. Permite la suficiente dispersión del calor cuando está instalado en la consola. • Vermijd hoge temperaturen. Zorg voor een degelijk hitteafvoer indien het apparaat op een rek wordt geplaatst. • Undvik höga temperaturer. Se till att det finns möjlighet till god värmeavledning vid monteringen i ett rack. 	 <ul style="list-style-type: none"> • Keep the apparatus free from moisture, water, and dust. • Halten Sie das Gerät von Feuchtigkeit, Wasser und Staub fern. • Protéger l'appareil contre l'humidité, l'eau et la poussière. • Tenete l'unità lontana dall'umidità, dall'acqua e dalla polvere. • Mantenga el equipo libre de humedad, agua y polvo. • Laat geen vochtigheid, water of stof in het apparaat binnendringen. • Utsätt inte apparaten för fukt, vatten och damm. 	 <ul style="list-style-type: none"> • Do not let foreign objects into the apparatus. • Keine fremden Gegenstände in das Gerät kommen lassen. • Ne pas laisser des objets étrangers dans l'appareil. • E' importante che nessun oggetto è inserito all'interno dell'unità. • No deje objetos extraños dentro del equipo. • Laat geen vreemde voorwerpen in dit apparaat vallen. • Se till att främmande föremål inte tränger in i apparaten. 	<p>CAUTION:</p> <ul style="list-style-type: none"> • The ventilation should not be impeded by covering the ventilation openings with items, such as newspapers, tablecloths, curtains, etc. • No naked flame sources, such as lighted candles, should be placed on the apparatus. • Attention should be drawn to the environmental aspects of battery disposal. • Do not expose the set to dripping or splashing fluids. • No objects filled with liquids, such as vases, shall be placed on the apparatus. <p>ACHTUNG:</p> <ul style="list-style-type: none"> • Die Belüftung sollte auf keinen Fall durch das Abdecken der Belüftungsöffnungen durch Gegenstände wie beispielsweise Zeitungen, Tischtücher, Vorhänge o. Ä. behindert werden. • Auf dem Gerät sollten keinerlei direkten Feuerquellen wie beispielsweise angezündete Kerzen aufgestellt werden. • Bitte beachten Sie bei der Entsorgung der Batterien die geltenden Umweltbestimmungen. • Das Gerät sollte keinerlei Flüssigkeit, also keinem Tropfen oder Spritzen ausgesetzt werden. • Auf dem Gerät sollten keinerlei mit Flüssigkeit gefüllten Behälter wie beispielsweise Vasen aufgestellt werden.
 <ul style="list-style-type: none"> • Unplug the power cord when not using the apparatus for long periods of time. • Wenn das Gerät eine längere Zeit nicht verwendet werden soll, trennen Sie das Netzkabel vom Netzstecker. • Débrancher le cordon d'alimentation lorsque l'appareil n'est pas utilisé pendant de longues périodes. • Disinnestate il filo di alimentazione quando avete l'intenzione di non usare il filo di alimentazione per un lungo periodo di tempo. • Desconecte el cordón de energía cuando no utilice el equipo por mucho tiempo. • Neem altijd het netsnoer uit het stopcontact wanneer het apparaat gedurende een lange periode niet wordt gebruikt. • Koppla ur nätkabeln om apparaten inte kommer att användas i lång tid. 	 <ul style="list-style-type: none"> • Do not let insecticides, benzene, and thinner come in contact with the apparatus. • Lassen Sie das Gerät nicht mit Insektiziden, Benzin oder Verdünnungsmitteln in Berührung kommen. • Ne pas mettre en contact des insecticides, du benzène et un diluant avec l'appareil. • Assicuratevvi che l'unità non venga in contatto con insetticidi, benzolo o solventi. • No permita el contacto de insecticidas, gasolina y diluyentes con el equipo. • Laat geen insektenverdelgende middelen, benzine of ververfdunder met dit apparaat in contact komen. • Se till att inte insektsmedel på spraybruk, bensen och thinner kommer i kontakt med apparatens hölje. 	 <ul style="list-style-type: none"> • Do not obstruct the ventilation holes. • Die Belüftungsöffnungen dürfen nicht verdeckt werden. • Ne pas obstruer les trous d'aération. • Non coprire i fori di ventilazione. • No obstruya los orificios de ventilación. • De ventilatieopeningen mogen niet worden geblokkeerd. • Täpp inte till ventilationsöppningarna. 	<p>ATTENTION:</p> <ul style="list-style-type: none"> • La ventilation ne doit pas être gênée en recouvrant les ouvertures de la ventilation avec des objets tels que journaux, rideaux, tissus, etc. • Aucune flamme nue, par exemple une bougie, ne doit être placée sur l'appareil. • Veillez à respecter l'environnement lorsque vous jetez les piles usagées. • L'appareil ne doit pas être exposé à l'eau ou à l'humidité. • Aucun objet contenant du liquide, par exemple un vase, ne doit être placé sur l'appareil. <p>PRECAUZIONI:</p> <ul style="list-style-type: none"> • Le aperture di ventilazione non devono essere ostruite coprendole con oggetti, quali giornali, tovaglie, tende e così via. • Non posizionare sull'apparecchiatura fiamme libere, come ad esempio le candele accese. • Prestare attenzione agli aspetti legati alla tutela dell'ambiente quando si smaltisce la batteria. • L'apparecchiatura non deve essere esposta a gocciolii o spruzzi. • Non posizionare sull'apparecchiatura nessun oggetto contenete liquidi, come ad esempio i vasi. <p>PRECAUCIÓN:</p> <ul style="list-style-type: none"> • La ventilación no debe quedar obstruida por hacerse cubierto las aperturas con objetos como periódicos, manteles, cortinas, etc. • No debe colocarse sobre el aparato ninguna fuente inflamable sin protección, como velas encendidas. • A la hora de deshacerse de las pilas, respete la normativa para el cuidado del medio ambiente. • No se expondrá el aparato al goteo o salpicaduras cuando se utilice. • No se colocarán sobre el aparato objetos llenos de líquido, como jarras.
<ul style="list-style-type: none"> • Handle the power cord carefully. Hold the plug when unplugging the cord. • Gehen Sie vorsichtig mit dem Netzkabel um. Halten Sie das Kabel am Stecker, wenn Sie den Stecker herausziehen. • Manipuler le cordon d'alimentation avec précaution. Tenir la prise lors du débranchement du cordon. • Maneggiare il filo di alimentazione con cura. Agitare per la spina quando scollegate il cavo dalla presa. • Maneje el cordón de energía con cuidado. Sostenga el enchufe cuando desconecte el cordón de energía. • Hanteer het netsnoer voorzichtig. Houd het snoer bij de stekker vast wanneer deze moet worden aan- of losgekoppeld. • Hantera nätkabeln varsamt. Håll i kabeln när den kopplas från el-uttaget. 	 <p>* (For apparatuses with ventilation holes)</p> <ul style="list-style-type: none"> • Never disassemble or modify the apparatus in any way. • Versuchen Sie niemals das Gerät auseinander zu nehmen oder auf jegliche Art zu verändern. • Ne jamais démonter ou modifier l'appareil d'une manière ou d'une autre. • Non smontate mai, nè modificate l'unità in nessun modo. • Nunca desarme o modifique el equipo de ninguna manera. • Nooit dit apparaat demonteren of op andere wijze modificeren. • Ta inte isär apparaten och försök inte bygga om den. 	<p>WAARSCHUWING:</p> <ul style="list-style-type: none"> • De ventilatie mag niet worden belemmerd door de ventilatieopeningen af te dekken met bijvoorbeeld kranten, een tafelkleed, gordijnen, enz. • Plaats geen open vlammen, bijvoorbeeld een brandende kaars, op het apparaat. • Houd u steeds aan de milieuvorschriften wanneer u gebruikte batterijen wegdoet. • Stel het apparaat niet bloot aan druppels of spatten. • Plaats geen voorwerpen gevuld met water, bijvoorbeeld een vaas, op het apparaat. <p>OBSERVERA:</p> <ul style="list-style-type: none"> • Ventilationen bör inte förhindras genom att täcka för ventilationsöppningarna med föremål såsom tidningar, bordsdukar, gardiner osv. • Inga blottade brandkällor, såsom tända ljus, bör placeras på apparaten. • Tänk på miljöaspekterna när du bortskaffar batteri. • Apparaten får inte utsättas för vätska. • Inga objekt med vätskor, såsom vaser, får placeras på apparaten. 	

A NOTE ABOUT RECYCLING:

This product's packaging materials are recyclable and can be reused. Please dispose of any materials in accordance with the local recycling regulations.

When discarding the unit, comply with local rules or regulations.

Batteries should never be thrown away or incinerated but disposed of in accordance with the local regulations concerning chemical waste.

This product and the accessories packed together constitute the applicable product according to the WEEE directive except batteries.

**HINWEIS ZUM RECYCLING:**

Das Verpackungsmaterial dieses Produktes ist für zum Recyceln geeignet und kann wieder verwendet werden. Bitte entsorgen Sie alle Materialien entsprechend der örtlichen Recycling-Vorschriften.

Beachten Sie bei der Entsorgung des Gerätes die örtlichen Vorschriften und Bestimmungen.

Die Batterien dürfen nicht in den Hausmüll geworfen oder verbrannt werden; bitte geben Sie die Batterien gemäß örtlichen Bestimmungen an den Sammelstellen oder Sondermüllplätzen ab.

Dieses Produkt zusammen mit den Zubehörteilen ist das geltende Produkt der WEEE-Direktive, davon ausgenommen sind die Batterien.

UNE REMARQUE CONCERNANT LE RECYCLAGE:

Les matériaux d'emballage de ce produit sont recyclables et peuvent être réutilisés. Veuillez disposer de tout matériau conformément aux règlements de recyclage locaux.

Lorsque vous mettez cet appareil au rebut, respectez les lois ou réglementations locales.

Les piles ne doivent jamais être jetées ou incinérées, mais mises au rebut conformément aux règlements locaux concernant les déchets chimiques.

Ce produit et les accessoires emballés ensemble sont des produits conformes à la directive DEEE sauf pour les piles.

NOTA RELATIVA AL RICICLAGGIO:

I materiali di imballaggio di questo prodotto sono riutilizzabili e riciclabili. Smaltire i materiali conformemente alle normative locali sul riciclaggio.

Per smaltire l'unità, osservare la normativa in vigore nel luogo di utilizzo.

Non gettare le batterie, né incenerirle, ma smaltirle conformemente alla normativa locale sui rifiuti chimici.

Questo prodotto e gli accessori inclusi nell'imballaggio sono applicabili alla direttiva RAEE, ad eccezione delle batterie.

ACERCA DEL RECICLAJE:

Los materiales de embalaje de este producto son reciclables y se pueden volver a utilizar. Disponga de estos materiales siguiendo los reglamentos de reciclaje de su localidad.

Cuando se deshaga de la unidad, cumpla con las reglas o reglamentos locales.

Las pilas nunca deberán tirarse ni incinerarse. Deberá disponer de ellas siguiendo los reglamentos de su localidad relacionados con los desperdicios químicos.

Este producto junto con los accesorios empacados es el producto aplicable a la directiva RAEE excepto pilas.

EEN AANTEKENING WAT BETREFT HET RECYCLEREN:

Het inpakmateriaal van dit product is recycleerbaar en kan opnieuw gebruikt worden. Er wordt verzocht om zich van elk afvalmateriaal te ontdoen volgens de plaatselijke voorschriften.

Volg voor het wegdoen van de speler de voorschriften voor de verwijdering van wit- en bruingoed op.

Batterijen mogen nooit worden weggegooid of verbrand, maar moeten volgens de plaatselijke voorschriften betreffende chemisch afval worden verwijderd.

Op dit product en de meegeleverde accessoires, m.u.v. de batterijen is de richtlijn voor afgedankte elektrische en elektronische apparaten (WEEE) van toepassing.

EN KOMMENTAR OM ÅTERVINNING:

Produktens emballage är återvinningsbart och kan återanvändas. Kassera det enligt lokala återvinningsbestämmelser. När du kasserar enheten ska du göra det i överensstämmelse med lokala regler och bestämmelser.

Batterier får absolut inte kastas i soporna eller brännas. Kassera dem enligt lokala bestämmelser för kemiskt avfall.

Denna apparat och de tillbehör som levereras med den är de som uppfyller gällande WEEE-direktiv, med undantag av batterierna.

CAUTION:

To completely disconnect this product from the mains, disconnect the plug from the wall socket outlet. The mains plug is used to completely interrupt the power supply to the unit and must be within easy access by the user.

VORSICHT:

Um dieses Gerät vollständig von der Stromversorgung abzutrennen, trennen Sie bitte den Netzstecker von der Wandsteckdose ab.

Die Hauptstecker werden verwendet, um die Stromversorgung zum Gerät völlig zu unterbrechen; er muss für den Benutzer gut und einfach zu erreichen sein.

PRECAUTION:

Pour déconnecter complètement ce produit du courant secteur, débranchez la prise de la prise murale.

La prise secteur est utilisée pour couper complètement l'alimentation de l'appareil et l'utilisateur doit pouvoir y accéder facilement.

ATTENZIONE:

Per scollegare definitivamente questo prodotto dalla rete di alimentazione elettrica, togliere la spina dalla relativa presa.

La spina di rete viene utilizzata per interrompere completamente l'alimentazione all'unità e deve essere facilmente accessibile all'utente.

PRECAUCIÓN:

Para desconectar completamente este producto de la alimentación eléctrica, desconecte el enchufe del enchufe de la pared.

El enchufe de la alimentación se utiliza para interrumpir por completo el suministro de alimentación a la unidad y debe de encontrarse en un lugar al que el usuario tenga fácil acceso.

VOORZICHTIGHEID:

Om de voeding van dit product volledig te onderbreken moet de stekker uit het stopcontact worden getrokken.

De netstekker wordt gebruikt om de stroomtoevoer naar het toestel volledig te onderbreken en moet voor de gebruiker gemakkelijk bereikbaar zijn.

FÖRSIKTIHETSMÅTT:

Koppla loss stickproppen från eluttaget för att helt skilja produkten från nätet.

Stickproppen används för att helt bryta strömförsörjningen till apparaten, och den måste vara lättillgänglig för användaren.

Getting Started

Thank you for purchasing this DENON CD Player. Please read the operation instructions thoroughly in order to acquaint yourself with the CD player and achieve maximum satisfaction from it.

Be sure to keep these instructions for future reference, should any questions or problems arise.

Contents

Getting Started	
Accessories	1
Before using	1, 2
About discs	
Discs usable on this set	2
Before playing MP3 or WMA (Windows Media® Audio) files	2
Holding discs	2
Loading discs	2
Cautions on loading discs	3
Cautions on handling	3
Cautions on storing discs	3
Cleaning discs	3
About the remote control unit	
Inserting the batteries	3
Operating range of the remote control unit	3
Part names and functions	
Front panel	4
Display	4
Rear panel	5
Remote control unit	5
Connections	
Cable indications	6
Analog connections	6
Digital connections	6
Connecting the power supply cord	6

Operation	
Turning the power on	7
Opening and closing the drawer and loading a disc	7
Starting playback	8
To stop playback	8
Various playback functions	
Playing the desired disc and desired track [Direct play]	8
To move to the next disc during playback	8
To pause playback	8
Automatic search	8, 9
Manual search	9
Programmed play	9
Random play	9
Repeat play	10
Other functions	10
Troubleshooting	
11	
Specifications	
12	

Accessories	
Check that the following parts are attached in addition to the main unit:	
① Operating instructions	1
② Service station list	1
③ Remote control unit (RC-1033)	1
④ R03/AAA batteries	2
⑤ Pin-plug cable (Cable length: Approx. 1 m)	1
⑥ Power supply cord (Cable length: Approx. 2 m)	1

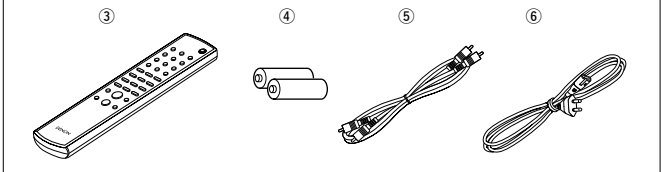

Before using

Remove two shipping screws.

At the bottom of the player there are two red shipping screws for use when the player is transported. Before using the player, turn these screws counterclockwise and remove them.

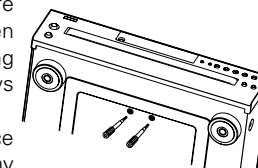

If the shipping screws are still in place and the power is turned on, the disc tray will not open. If this happens, turn off the power, unplug the power supply cord from the power outlet and remove the shipping screws. Retain these screws as they will be needed when the player is transported.

Before transporting the player, take out the discs, close the disc tray, turn off the power after "0 000 00:00" is displayed and unplug the power supply cord from the power outlet. Then install the shipping screws by turning them clockwise. Be sure to fasten them securely.

Handle the power supply cord carefully.

Do not damage or deform the power supply cord. If it is damaged or deformed, it may cause electric shock or malfunction when used. When disconnecting the power supply cord from the wall outlet, hold the plug and do not pull on the cable.

Do not open the top cover.

In order to prevent electric shock, do not open the top cover. If problems occur, contact your DENON dealer.

Do not place anything inside.

Prevent metal objects from entering the CD player and avoid spilling liquids on it. Electric shock or malfunction may result.

Cautions on moving.

First, if a disc is loaded, eject it, then turn off the power, unplug the power supply cord from the power outlet and disconnect the connection cables with other devices.

Cautions on using mobile phones.

Using a mobile phone near this unit may result in noise. If so, move the mobile phone away from this unit when using it.

Store these instructions in a safe place.

After reading, store this instructions along with the warranty card in a safe place.

Note that the illustrations in these instructions may differ from the actual unit for explanation purposes.

Getting Started

NOTE:

- This CD player uses a semiconductor laser. To ensure stable operation, it is recommended to use the set indoors at a temperature of 5°C (41°F) ~ 35°C (95°F).

About discs

Discs usable on this set

1 Music CDs

Discs with the mark at the right can be used on this set.

Note however that discs with special shapes (heart-shaped discs, octagonal discs, etc.) cannot be played. Do not attempt to play them, as doing so could damage the set.



2 CD-R/CD-RW

- Some discs and some recording formats may not be playable.
- Non-finalized discs cannot be played.

※ Finalization:

Finalization is the process that makes recorded CD-R/CD-RW discs playable on compatible players.

Before playing MP3 or WMA (Windows Media® Audio) files

There are many music distribution sites on the Internet allowing you to download music files in MP3 or WMA format. The music (files) downloaded from such sites can be stored on CD-R or CD-RW discs and played on the this CD player.

“Windows Media” and “Windows” are registered trademarks or trademarks in the United States and other countries of the Microsoft Corporation of the United States.

※ According to copyright laws, recordings you have made should only be used for your personal enjoyment and must not be used in other ways without the consent of the copyright holder.

NOTE:

- This CD player is compatible with “MPEG-1 Audio Layer-3” standards (sampling frequency of 44.1 and 48 kHz). It is not compatible with “MPEG-2 Audio Layer-3”, “MPEG-2.5 Audio Layer-3”, MP1 or MP2 standards.
- The signals are output with a sampling frequency of 44.1 kHz.
- When writing MP3 files on a CD-R or CD-RW disc, set the writing software’s format to “ISO9660 Level 1”. The files may not play properly if they are recorded in other formats. Also note that with some writing software it is not possible to record in ISO9660 format. If so, use a different program allowing you to record in ISO9660 format.
- With MP3 files, the higher the bit rate, the better the sound quality. The compatible bit rate range is 32 to 320 kbps for MP3 files, 64 to 160 kbps for WMA files. We recommend using MP3 files with bit rates of 128 kbps or greater on the this CD player.
- Be sure to add the extensions “.MP3” or “.WMA” to MP3 or WMA files, respectively. Files with extensions other than “.MP3” or “.WMA” or files without extensions cannot be played. (On Macintosh computers, MP3 files can be played by giving the extension “.MP3” after the file name consisting up a maximum of 8 alphanumeric characters and storing the files on a CD-R or CD-RW disc.)
- This CD player is not compatible with packet write software or playlists.
- The time may not be displayed properly when searching or pausing during variable bit rate playback.
- The time display cannot be switched “TOTAL REMAIN” using the **TIME** button on the remote control unit.

Getting Started

NOTE:

- Multisession and CD-R/CD-RW discs that have not been completely written can be played, but we recommend using discs closed after a maximum of 10 sessions or discs that have been completed.
- The maximum number of files and folders playable is 512 (total of the number of folders and files). The maximum number of folders is 256.
- Copyright-protected WMA files cannot be played. (“-- : --” is displayed. Use the **◀◀/▶▶** or **▶▶/▶▶▶▶** button on the main unit (the **◀◀** or **▶▶▶▶** button on the remote control unit) to select a different file.)

Holding discs

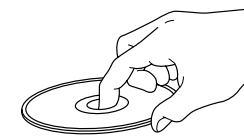

Do not touch the signal surface.

Loading discs

- Set the disc with the labeled side facing up.
- Make sure the disc tray is fully open when inserting the disc.
- Place the discs flatly, 12 cm discs in the outer tray guide (Figure 1), 8 cm discs in the inner tray guide (Figure 2).

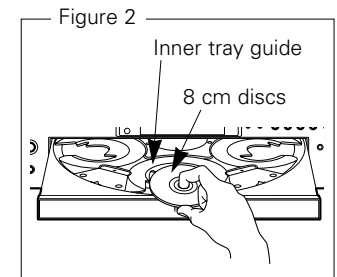
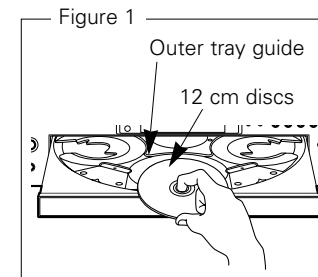

- Place 8 cm discs in the inner tray guide without using an adapter.



- “0 000 00:00” is displayed if no disc is loaded, if a disc that cannot be played is loaded or if the disc is loaded upside-down.

Getting Started

Cautions on loading discs

- Only load one disc per tray at a time. Loading two or more discs per tray can damage the set or scratch the discs.
- Do not use cracked or warped discs or discs that have been repaired with adhesive, etc.
- Do not use discs on which the sticky part of cellophane tape or labels is exposed or on which there are traces of where labels have been removed. Such discs could get caught inside the player and damage it.

Cautions on handling

- Do not get fingerprints, oil or dirt on discs.
- Take special care not to scratch discs when removing them from their cases.
- Do not bend or heat discs.
- Do not enlarge the hole at the center.
- Do not write on the labeled (printed) surface with ball-point pens, pencils, etc., or stick new labels on discs.
- Water droplets may form on discs if they are moved suddenly from a cold place (outdoors for example) to a warm place, but do not try to dry them off using a hairdryer, etc.

Cautions on storing discs

- Be sure to remove discs after using them.
- Be sure to store discs in their cases to protect them from dust, scratches, warping, etc.
- Do not store discs in the following places:
 1. Places exposed to direct sunlight for long periods of time
 2. Dusty or humid places
 3. Places exposed to heat from heating appliances, etc.

Cleaning discs

- If there are fingerprints or dirt on discs, wipe them off before using the disc. If not the sound quality could be reduced and the sound may be broken.
- Use a commercially available disc cleaning set or a soft cloth to clean discs.

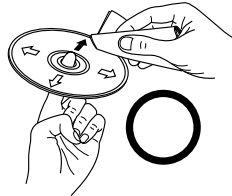

Gently wipe the disc from the inside towards the outside.

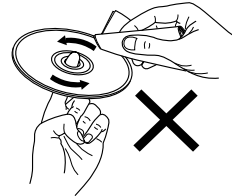

Do not wipe with a circular motion.

NOTE:

- Do not use record spray, antistatic agents, or benzene, thinner or other solvents.

About the remote control unit

Inserting the batteries

- ① Remove the remote control unit's rear cover.
- ② Set two R03/AAA batteries in the battery compartment in the indicated direction.

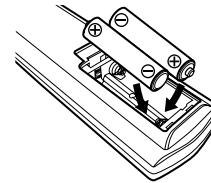
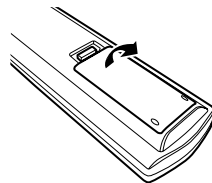

- ③ Put the rear cover back on.

Getting Started

Notes on batteries:

- Replace the batteries with new ones if the set does not operate even when the remote control unit is operated nearby the unit. (The attached batteries are only for verifying operation.)
- When inserting the batteries, be sure to do so in the proper direction, following the “⊕” and “⊖” marks in the battery compartment.
- To prevent damage or leakage of battery fluid:
 - Do not use a new battery together with an old one.
 - Do not use two different types of batteries.
 - Do not short-circuit, disassemble, heat or dispose of batteries in flames.
- If the battery fluid should leak, carefully wipe the fluid off the inside of the battery compartment and insert new batteries.
- Remove the batteries from the remote if it will not be in use for long periods.

Operating range of the remote control unit

- Point the remote control unit at the remote sensor when operating it.
- The remote control unit can be used from a distance of up to about 8 meters, at a horizontal angle of up to 30° with respect to the sensor.

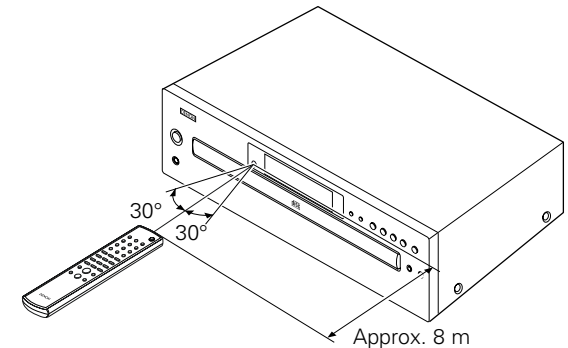

NOTE:

- It may be difficult to operate the remote control unit if the remote sensor is exposed to direct sunlight or strong artificial light.

Getting Started

Part names and functions

For buttons not explained here, see the page indicated in parentheses ().

Front panel

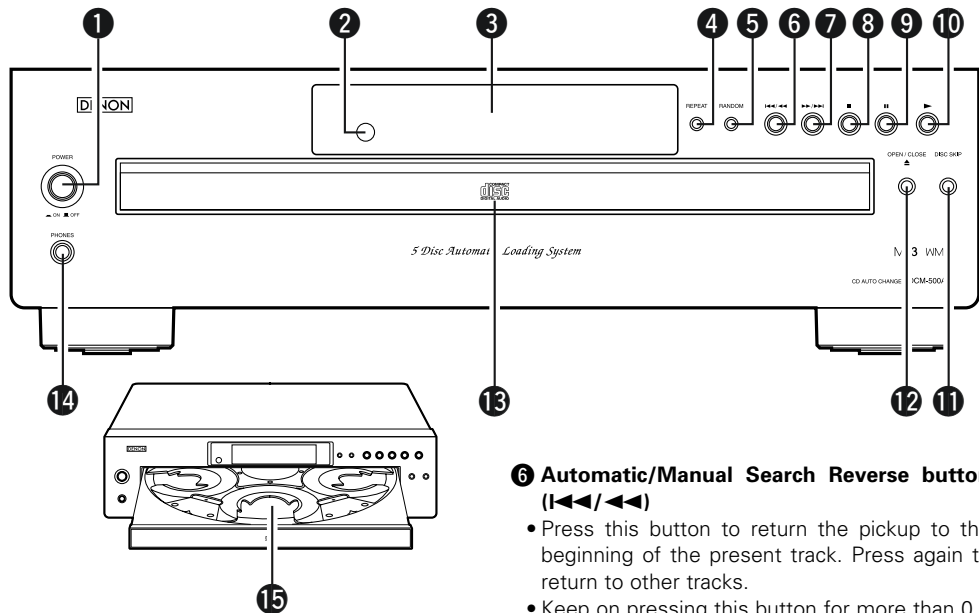

1 POWER switch

- Press once to turn the power on.
- If a disc is loaded when the power is turned on, playback starts automatically.

2 Remote control sensor

This sensor receives the infrared light transmitted from the wireless remote control unit.

3 Display

4 REPEAT button

Press this button for repeated playback. The "REPEAT" indicator appears on the display. Three types of repeat modes are available. (See page 10)

5 RANDOM button

Press this button to begin random play.

6 Automatic/Manual Search Reverse button (I◀◀/◀◀I)

- Press this button to return the pickup to the beginning of the present track. Press again to return to other tracks.
- Keep on pressing this button for more than 0.5 seconds during playback for fast reverse search.

7 Automatic/Manual Search Forward button (▶▶/▶▶I)

- Press this button to move the pickup forward to the beginning of the next track. Press again to move ahead to other tracks.
- Keep on pressing this button for more than 0.5 seconds during playback for fast forward search.

8 Stop button (■)

Press this button to stop playback.

9 Pause button (II)

Press this button to stop play temporarily.

10 Play button (▶ PLAY)

Press this button to play a disc.

11 DISC SKIP button

Each time this button is pressed, the carousel will rotate in a clockwise direction to the next tray position. This allows for loading or unloading of discs.

This button is also used to select the next disc, in the normal play continuously.

12 OPEN/CLOSE button (▲)

- Press this button when opening.
- The drawer is opened toward the front.
- Press the button again to close the drawer.

13 Loading Drawer

Discs can be loaded and unloaded when this drawer is open. Do not force the drawer closed by hand.

14 PHONES jack

For private listening, you can connect your headphones (commercially available) to this jack.

15 Disc Trays (1 ~ 5)

One disc per tray can be loaded.

Getting Started

Display

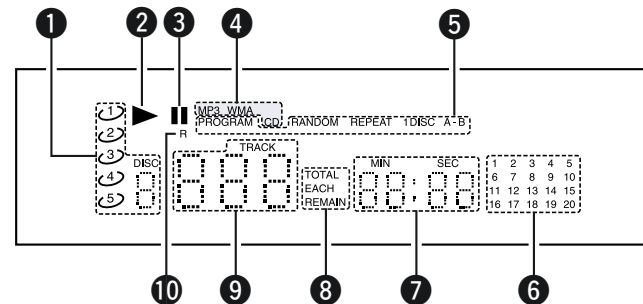

1 Disc indicator

2 Play indicator

3 Pause indicator

4 Playing disc indicator

5 Playing mode indicator

6 20-track music calendar

7 Time indicator

8 Time display mode indicator

9 Track number indicator

10 Remote control signal receive indicator

Rear panel

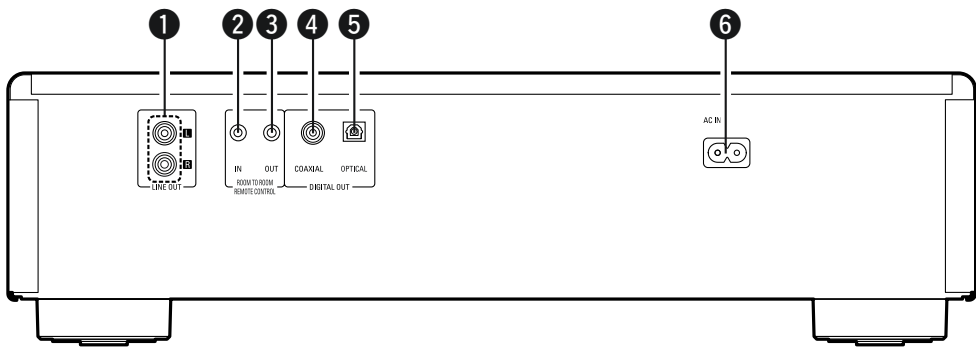

- 1 LINE OUT terminals**
Connect these to the amplifier's input terminals.
- 2 REMOTE CONTROL jack (ROOM TO ROOM IN)**
This is the input connector for wired remote control. Consult your DENON dealer if you wish to use this connector.
- 3 REMOTE CONTROL jack (ROOM TO ROOM OUT)**
This is the output connector for wired remote control. Consult your DENON dealer if you wish to use this connector.

- 4 COAXIAL terminal**
This terminal outputs digital data. Connect using a 75 Ω/ohms coaxial cable (commercially available) intended for digital audio connections.
- 5 OPTICAL terminal**
Digital data is output in optical form from this terminal. Connect using an optical fiber cable (commercially available).
- 6 AC inlet**
Connect to an AC power supply using the included power supply cord.

Remote control unit

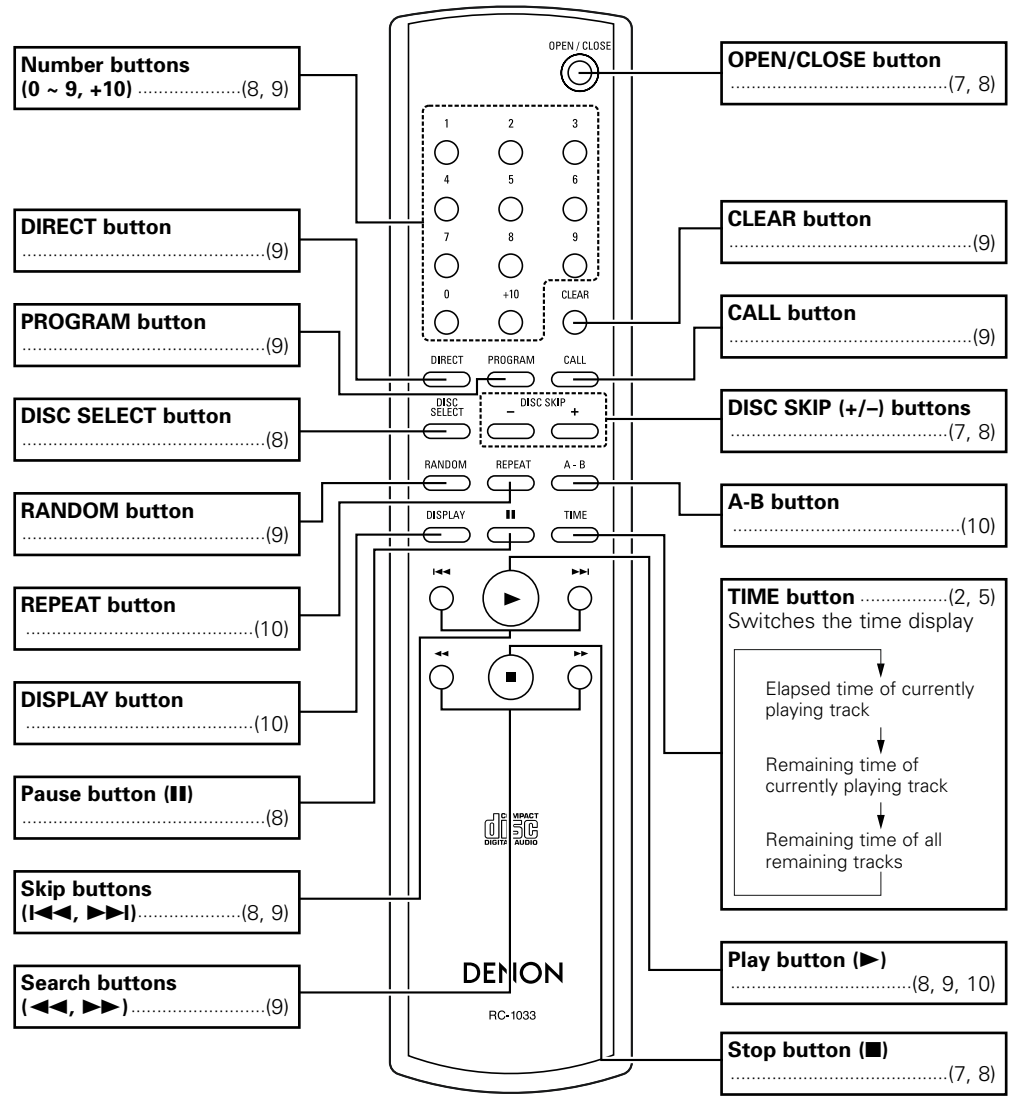

- If the automatic search forward button (▶▶I), automatic search reverse button (I◀◀) or +10 button are held in, the function of these button will be repeated.

Connections

NOTE:

- Do not plug in the power supply cord until all connections have been completed.
- When making connections, also refer to the operating instructions of the other components.
- Be sure to connect the left and right channels properly (left with left, right with right).
- Making connections with the power turned on could result in noise or damage the speakers.
- Bunching the power supply cords and connection cables together could result in humming or noise.

Cable indications

Connect using the connection cables shown below.

Audio cable	Signal direction
<p>A Analog connections (Stereo)</p> <p>(White) (Red)</p> <p>Pin-plug cable</p>	<p>Audio signal</p> <p>OUT IN</p>
<p>B Digital connections (Coaxial)</p> <p>(Orange)</p> <p>Coaxial cable (75 Ω/ohms pin-plug cable)</p>	
<p>C Digital connections (Optical)</p> <p>Optical fiber cable</p>	

Analog connections

Use the included pin-plug cable to connect the left (L) and right (R) output terminal (LINE OUT) of the CD Player to the CD, AUX or TAPE PLAY left (L) and right (R) input terminal of the amplifier.

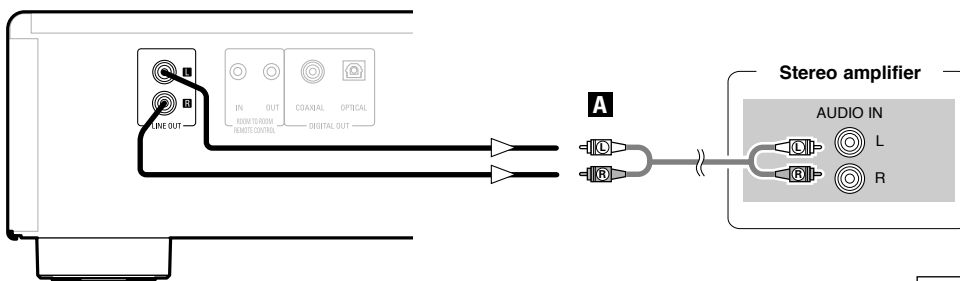

Digital connections

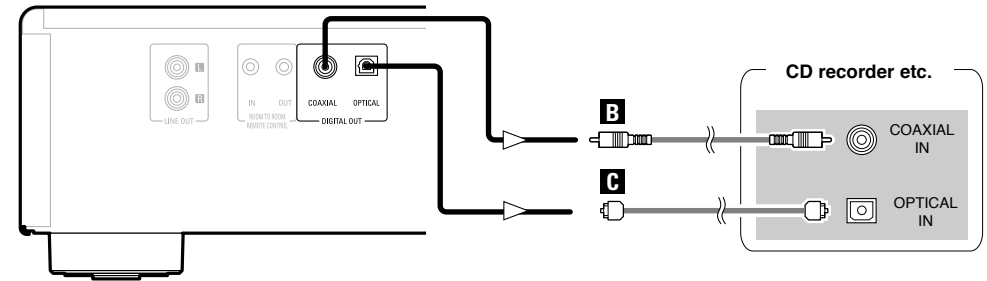

- Digital signals are output from optical terminal and coaxial terminal with parallel.

When connecting the OPTICAL digital output connector with an optical transmission cable (commercially available)

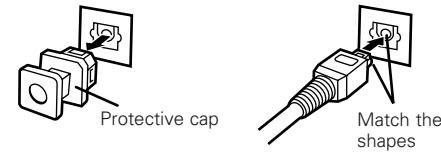

Remove the protective cap, match the shapes then insert firmly all the way in.



- Store the protective cap in a safe place so as not to lose it, and use it when not using the terminal.

Connecting the power supply cord

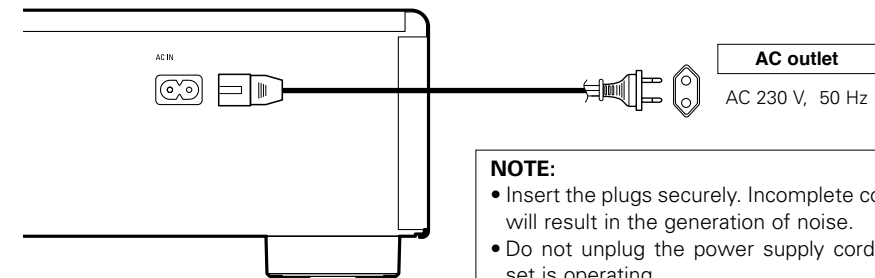

NOTE:

- Insert the plugs securely. Incomplete connections will result in the generation of noise.
- Do not unplug the power supply cord while the set is operating.

Operation

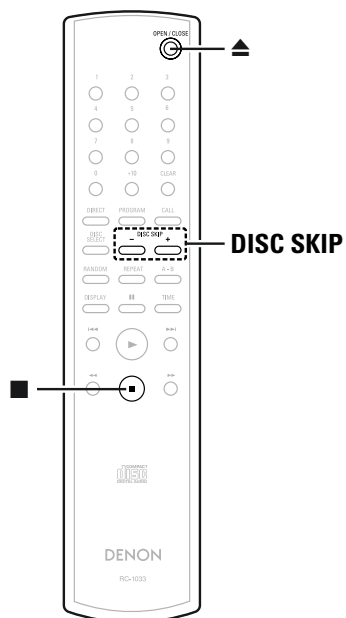
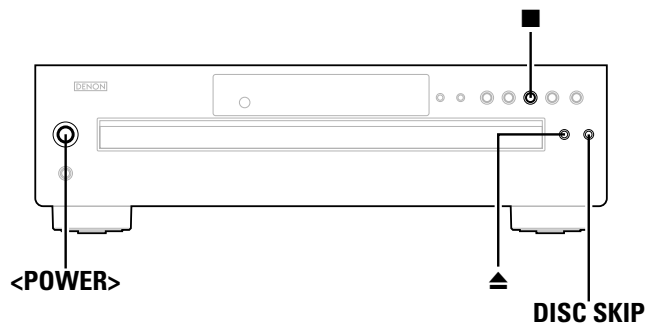

About the button names in this explanation
 < > : Buttons on the main unit
 [] : Buttons on the remote control unit
Button name only :
 Buttons on the main unit and remote control unit

Turning the power on

Press <POWER>.

- When a disc is loaded, playback starts automatically.
- If no disc is loaded "0 000 00:00" is displayed.

To turn off the power:
 Press <POWER> again.

NOTE:

- To turn off the power while a disc is playing, be sure to press ■ to stop playback before turning off the power.

Opening and closing the drawer and loading a disc

1 Press ▲.

- Make sure the drawer is completely open.

※ Hold the disc by the edges and place it on the disc tray. (Do not touch the signal surface, i.e., the glossy side.)

2 Set the disc properly in the tray according to its size.

- Set 8 cm discs in the center hole.
- Set 12 cm discs in the outer hole.

3 Press DISC SKIP.

- The carousel turns and a disc can be loaded in the another disc tray.
- When the drawer is opened during the play mode, it is possible to load and unload discs in all of the disc trays other than the one whose disc is currently playing.

4 Press ▲ again.

NOTE:

- The player will not operate properly and the disc may even be damaged if it is not set correctly.
- If your finger should get caught in the drawer when it closes, press ▲.
- Do not place any foreign objects on the disc tray, and do not place more than one disc on the tray at a time. Otherwise malfunction may occur.
- Do not push in the disc tray manually when the power is off as this may cause malfunction and damage the CD player.
- Do not touch the carousel while it is turning. Also, do not turn the carousel by hand when it is stopped. Doing so could damage it.
- Do not insert disc where indicated by arrow. This could damage the internal mechanism in the unit.

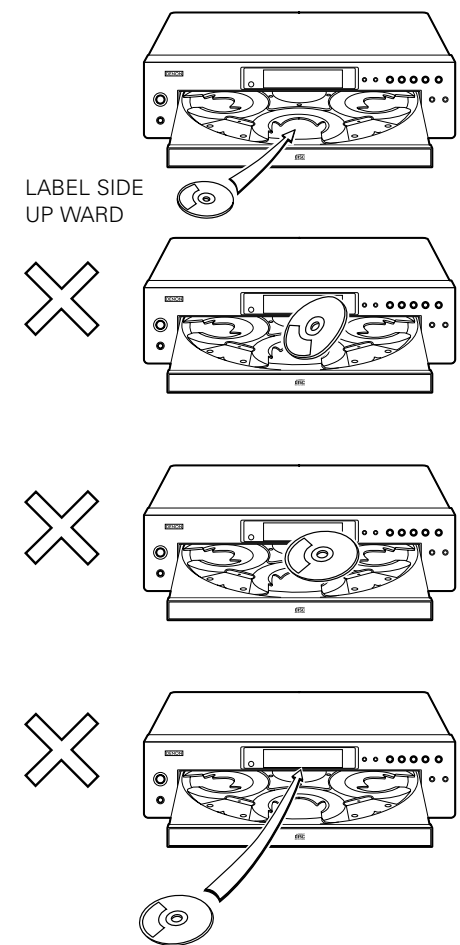

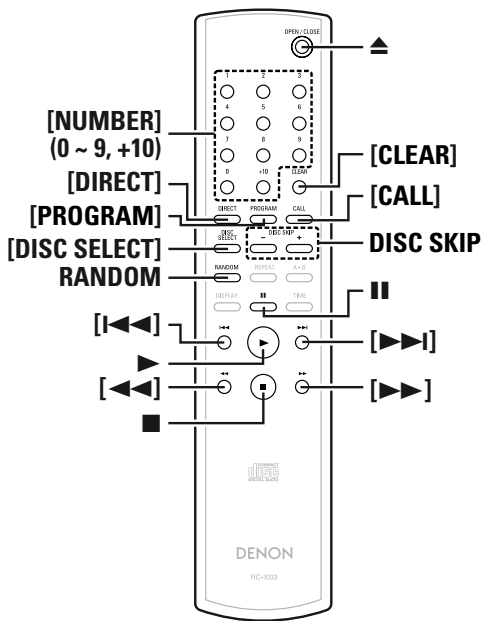
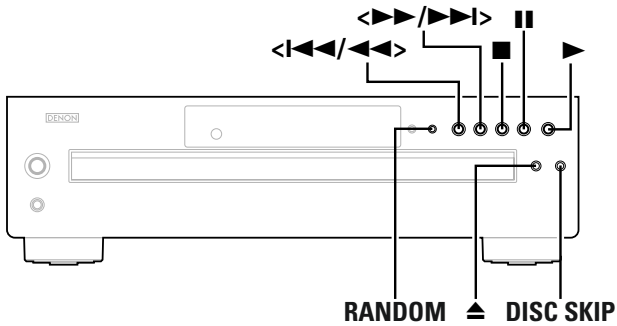

About the button names in this explanation
 < > : Buttons on the main unit
 [] : Buttons on the remote control unit
Button name only :
 Buttons on the main unit and remote control unit

Starting playback

Press ►.

- The drawer closes and the disc just loaded is played.
- Playback starts.

※ If ▲ is pressed while a disc is playing, playback continues, but the drawer opens and four discs can be replaced. The disc that can be replaced switches when **DISC SKIP** is pressed.

※ Playback stops automatically after the last track on the disc has been played.

To stop playback

Press ■ during playback.

- Playback stops.

Various playback functions

Playing the desired disc and desired track [Direct play]

- 1 Press [DISC SELECT].
- 2 Use [NUMBER] (1 to 5) to select the disc.
- 3 Use [NUMBER] (0 ~ 9, +10) to select the track.
Example: To play the 4th track on the 3rd disc:
 Press [DISC SELECT] [3] [4].
Example: To play the 12th track on the 5th disc:
 Press [DISC SELECT] [5] [+10] [2].
- 4 Playback begins from the number of the disc and track selected.

To move to the next disc during playback

Press DISC SKIP.

※ The carousel in the drawer turns and the disc on the next tray is played.

When [DISC SKIP-] on the remote control unit is pressed, the carousel turns in the opposite direction and the previous disc is played.

To pause playback

Use this function to stop playback temporarily, and later resume playback from that point.

Press || during playback.

- Playback pauses.

To resume playback:
 Press ►.

Automatic search

Moving ahead to the beginning of the next track (file):

Press [▶▶▶] or <▶▶▶/▶▶▶I> during playback.

- The pickup will advance to the beginning of the next track and playback will continue. Pressing the button several times will forward the pickup the corresponding number tracks.

※ Normal playback resumes when you release your finger from the button.

Operation

 Moving back to the beginning of the current track (file):

Press [**⏮**] or **<⏮/⏮>** during playback.

- The pickup will advance to the beginning of the next track and playback will continue. Pressing the button several times will forward the pickup the corresponding number tracks.

Manual search

Use this function to skip forward or backward while listening to the sound.

 Searching forward:

Press [**⏭**] or press and hold **<⏭/⏭>** during playback.

- "]]" is displayed if the end of the last track is reached during manual searching. If this happens, use [**⏮**] or **<⏮/⏮>** to turn the display off.

 Searching backward:

Press [**⏪**] or press and hold **<⏪/⏪>** during playback.

- "[[" is displayed if the beginning of the first track is reached during manual searching. If this happens, use [**⏭**] or **<⏭/⏭>** to turn the display off.

NOTE:

- The sound may be interrupted momentarily when resuming normal playback from the manual search mode. This is not a malfunction.

Programmed play

You can play certain tracks on the loaded discs in any order. Up to 32 tracks can be set in a program.

1 Press [PROGRAM].

- The "PROGRAM" indicator lights.

2 Press [DISC SELECT], [NUMBER] to select the disc to be programmed.

Example: To program the 3rd track on the 2nd disc and the 12 track on the 5th disc:

Press [PROGRAM] [DISC SELECT] [2] [3], [DISC SELECT] [5] [+10] [2].

3 Press ▶.

- The tracks are played in the programmed order.

 Checking the programmed tracks:

Press [CALL].

The tracks are displayed in the programmed order each time the button is pressed.

 Clearing tracks from the program:

Press [CLEAR] while the track you want to clear is displayed during the "Checking the programmed tracks" operation above.

 Stopping programmed playback:

Press [DIRECT] or press ▲ to open the disc tray.



- Tracks on a disc not loaded can also be programmed, but if you try to play that disc, the microprocessor detects that it is not loaded and the following disc is played automatically.
- When programming, do not program a track number which is not recorded on the disc. If such a number is programmed by mistake, the player ignore the program.
- For programmed playback, the remaining time for the program is only displayed when the programmed tracks are all on the same disc.
 - "– : –" is displayed when tracks on more than one disc are programmed.
- In the case that the total playing time of programmed tracks becomes more than 99:59, "– : –" is displayed.

Operation

Random play

Use this function to play all the tracks on the all discs or a disc once in random order.

 Full random play:**1 Press RANDOM.**

- The "RANDOM" indicator lights.

2 Press ▶.

- A track is selected automatically and playback starts.

- ※ During programmed playback: The programmed tracks are played in random order.
- ※ During repeat playback: The tracks are played once in random order, then played again in a different order, and this is repeated.

 Stopping random playback:

Press [RANDOM] or [DIRECT].

NOTE:

- During random play, the player may display the number of disc which is not loaded in the tray. In such a case, the player will read the disc information, then reset automatically to correct. This is not a malfunction.

 Disc sequential random play:**1 Press RANDOM and specify the disc numbers (1 to 5) with the [DISC SELECT] and the [NUMBER].****2 Press ▶.**

- A track is selected automatically and playback starts.

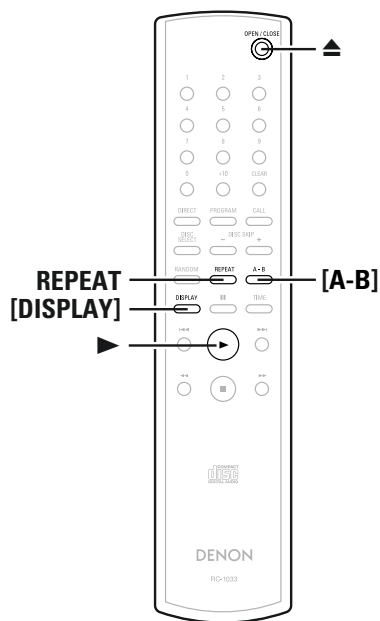
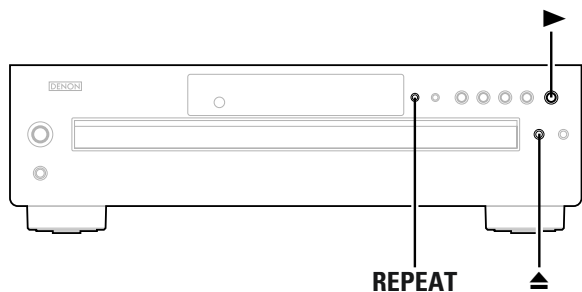

About the button names in this explanation
 < > : Buttons on the main unit
 [] : Buttons on the remote control unit
Button name only :
 Buttons on the main unit and remote control unit

Repeat play

1 Press **REPEAT** once.

- One-track Repeat**
 - The "REPEAT 1" indicator lights.
 - The track currently playing is repeated.
- One-disc Repeat**
 - The "REPEAT 1DISC" indicator lights.
 - The disc currently playing is repeated.
- All-disc Repeat**
 - The "REPEAT DISC" indicator lights.
 - All the discs currently loaded are repeated.
- OFF**

2 Press **▶**.

- ※ During regular playback:
All the tracks are played repeatedly.
- ※ During programmed playback:
The tracks are played repeatedly in the programmed order.
- ※ In the random play mode:
The tracks are played once each in random order, then played again in a different order.

Stopping all-track repeat playback:
 Press **REPEAT** twice in a row or press **▲** to open the disc tray.

- In the programmed play or random play mode during all-track repeat playback, normal playback resumes when **REPEAT** is pressed once.

A-B repeat play:

1 During playback, press **[A-B]** at the point at which you want to start repeating (point A).
 • The "A-B" indicator blinks.

2 During playback, press **[A-B]** at the point at which you want to stop repeating (point B).
 • The "A-B" indicator lights and the A-B section is played repeatedly.

Stopping A-B repeat playback:
 Press **[A-B]** again.

- The pickup will now return to the starting point and repeat playback of the selected interval.
- A-B repeat playback is not possible during programmed playback or random playback.

Other functions

Switching the display brightness:
 The brightness can be switched in three steps or turned off. Press **[DISPLAY]**.

Troubleshooting

If a problem should arise, first check the following.

1. Are the connections correct?

2. Have you operated the player according to the Operating Instructions?

If this unit is not operating properly, check the items listed in the table below. Should the problem persist, there may be a malfunction. Disconnect the power immediately and contact your store of purchase.

Symptom	Cause	Measures	Page
Disc tray does not open.	<ul style="list-style-type: none"> The power is not on. 	<ul style="list-style-type: none"> Turn on the power. 	7
"0 000 00:00" is displayed even though a disc is loaded.	<ul style="list-style-type: none"> The disc is not properly loaded. The loaded disc is not a CD. 	<ul style="list-style-type: none"> Reload the disc. Load a CD. 	2, 3 2
Disc is not played when ► button is pressed.	<ul style="list-style-type: none"> The disc is dirty or scratched. 	<ul style="list-style-type: none"> Wipe the dirt off the disc or replace the disc. 	3
No sound is produced or sound is distorted.	<ul style="list-style-type: none"> The output cables are not properly connected to the amplifier. The amplifier's function setting or adjustments are not right. 	<ul style="list-style-type: none"> Check the connections. Check the amplifier's function and controls and adjust as necessary. 	6 -
No digital signals are output.	<ul style="list-style-type: none"> The connection cables are not properly connected. 	<ul style="list-style-type: none"> Check the connections. 	6
Specific section of the disc cannot be played properly.	<ul style="list-style-type: none"> The disc is dirty or scratched. 	<ul style="list-style-type: none"> Wipe the dirt off the disc or replace the disc. 	3
Programmed playback is not possible.	<ul style="list-style-type: none"> The tracks have not been programmed properly. 	<ul style="list-style-type: none"> Program properly. 	9
A CD-R or CD-RW disc cannot be played.	<ul style="list-style-type: none"> The disc has not been finalized. The recording conditions are bad or the quality of the disc itself is poor. 	<ul style="list-style-type: none"> Finalize the disc then play it. Use a properly recorded disc. 	2 2
Set does not operate properly when remote control unit is operated.	<ul style="list-style-type: none"> The batteries are spent. The remote control unit is too far from the set. 	<ul style="list-style-type: none"> Replace the batteries with new ones. Move the remote control unit closer to the set. 	3 3
"- - : - -" is displayed when playing files recorded in MP3 or WMA format.	<ul style="list-style-type: none"> You have selected a copyright-protected WMA file or a file that cannot be played normally. 	<ul style="list-style-type: none"> Use the ◀◀/◀◀ or ▶▶/▶▶ button on the main unit (the ◀◀ or ▶▶ button on the remote control unit) to select a different file. 	2

Specifications

□ Audio performance

• Analog output

Channels:	2 channels
Playable frequency range:	2 Hz ~ 20 kHz
S/N:	108 dB
Dynamic range:	98 dB
Harmonic distortion:	0.003 % (1 kHz)
Separation:	98 dB
Wow & flutter:	Less than the measuring
Output level:	Fix 2.0 V (10 k Ω /kohms)
Signal type:	16-bit linear PCM
Sampling frequency:	44.1 kHz
Usable discs:	Audio compact discs are used 12 cm and 8 cm

• Digital output

Coaxial:	0.5 Vp-p (75 Ω /ohms)
OPTICAL:	- 15 ~ - 21 dBm
Light emission wavelength:	660 nm

• Phones output

0.04 mW

□ General

Power supply:	AC 230 V, 50 Hz
Power consumption:	15 W
Maximum external dimensions:	434 (W) x 120 (H) x 400 (D) mm (including protruding parts)
Mass:	6.3 kg

□ Remote control unit (RC-1033)

Remote control type:	Infrared pulse
Batteries:	R03/AAA Type (two batteries)
External dimensions:	49 (W) x 220 (H) x 21 (D) mm
Mass:	106 g (included batteries)

* For purposes of improvement, specifications and design are subject to change without notice.

DENON

TOKYO, JAPAN
www.denon.com

Denon Brand Company, D&M Holdings Inc.
Printed in China 00D 511 4438 000

Free Manuals Download Website

<http://myh66.com>

<http://usermanuals.us>

<http://www.somanuals.com>

<http://www.4manuals.cc>

<http://www.manual-lib.com>

<http://www.404manual.com>

<http://www.luxmanual.com>

<http://aubethermostatmanual.com>

Golf course search by state

<http://golfingnear.com>

Email search by domain

<http://emailbydomain.com>

Auto manuals search

<http://auto.somanuals.com>

TV manuals search

<http://tv.somanuals.com>