

VFD-VL

User Manual

Elevator Drive



Power Range :

3-phase 230V series: 5.5kW~22kW (7.5~30HP)

3-phase 460V series: 5.5kW~22kW (7.5~30HP)



DELTA ELECTRONICS, INC.

www.delta.com.tw/industrialautomation

ASIA

Delta Electronics, Inc.

Taoyuan¹

31-1, Xingbang Road, Guishan Industrial Zone,
Taoyuan County 33370, Taiwan, R.O.C.
TEL: 886-3-362-6301 / FAX: 886-3-362-7267

Delta Electronics (Jiang Su) Ltd.

Wujiang Plant3

1688 Jiangxing East Road,
Wujiang Economy Development Zone,
Wujiang City, Jiang Su Province,
People's Republic of China (Post code: 215200)
TEL: 86-512-6340-3008 / FAX: 86-512-6340-7290

Delta Electronics (Japan), Inc.

Tokyo Office

Delta Shibadaimon Building, 2-1-14 Shibadaimon,
Minato-Ku, Tokyo, 105-0012, Japan
TEL: 81-3-5733-1111 / FAX: 81-3-5733-1211

Delta Electronics (Korea), Inc.

234-9, Duck Soo BD 7F, Nonhyun-dong,
Kangnam-ku, Seoul, Korea
Post code : 135-010
TEL: 82-2-515-5303/5 / FAX: 82-2-515-5302

Delta Electronics (Singapore) Pte. Ltd.

8 Kaki Bukit Road 2, #04-18 Ruby Warehouse Complex,
Singapore 417841
TEL: 65-6747-5155 / FAX: 65-6744-9228

Delta Energy Systems (India) Pvt. Ltd.

Plot No. 27 & 31, Sector-34, EHTP,
Gurgaon-122001 Haryana, India
TEL: 91-124-4169040 / FAX: 91-124-4036045

AMERICA

Delta Products Corporation (USA)

Raleigh Office

P.O. Box 12173, 5101 Davis Drive,
Research Triangle Park, NC 27709, U.S.A.
TEL: 1-919-767-3813 / FAX: 1-919-767-3969

EUROPE

Deltronics (Netherlands) B.V.

Eindhoven Office

De Witbogt 15, 5652 AG Eindhoven, The Netherlands
TEL: 31-40-259-28-50 / FAX: 31-40-259-28-51

5011663901
200811-28



VLE1

*We reserve the right to change the information in this manual without prior notice



VP-VL

User Manual

Elevator Drive

Preface

Thank you for choosing DELTA's high-performance VFD-VL Series. The VFD-VL Series is manufactured with high-quality components and materials and incorporates the latest microprocessor technology available.

This manual is to be used for the installation, parameter setting, troubleshooting, and daily maintenance of the AC motor drive. To guarantee safe operation of the equipment, read the following safety guidelines before connecting power to the AC motor drive. Keep this operating manual at hand and distribute to all users for reference.

To ensure the safety of operators and equipment, only qualified personnel familiar with AC motor drive are to do installation, start-up and maintenance. Always read this manual thoroughly before using VFD-VL series AC Motor Drive, especially the WARNING, DANGER and CAUTION notes. Failure to comply may result in personal injury and equipment damage. If you have any questions, please contact your dealer.

PLEASE READ PRIOR TO INSTALLATION FOR SAFETY.



DANGER!

-
1. AC input power must be disconnected before any wiring to the AC motor drive is made.
 2. A charge may still remain in the DC-link capacitors with hazardous voltages, even if the power has been turned off. To prevent personal injury, please ensure that power has turned off before opening the AC motor drive and wait ten minutes for the capacitors to discharge to safe voltage levels.
 3. Never reassemble internal components or wiring.
 4. The AC motor drive may be destroyed beyond repair if incorrect cables are connected to the input/output terminals. Never connect the AC motor drive output terminals U/T1, V/T2, and W/T3 directly to the AC mains circuit power supply.
 5. Ground the VFD-VL using the ground terminal. The grounding method must comply with the laws of the country where the AC motor drive is to be installed. Refer to the Basic Wiring Diagram.
 6. VFD-VL series is used only to control variable speed of 3-phase induction motors, NOT for 1-phase motors or other purpose.
 7. VFD-VL series shall NOT be used for life support equipment or any life safety situation.

**WARNING!**

1. DO NOT use Hi-pot test for internal components. The semi-conductor used in AC motor drive easily damage by high-voltage.
2. There are highly sensitive MOS components on the printed circuit boards. These components are especially sensitive to static electricity. To prevent damage to these components, do not touch these components or the circuit boards with metal objects or your bare hands.
3. Only qualified persons are allowed to install, wire and maintain AC motor drives.

**CAUTION!**

1. Some parameters settings can cause the motor to run immediately after applying power.
2. DO NOT install the AC motor drive in a place subjected to high temperature, direct sunlight, high humidity, excessive vibration, corrosive gases or liquids, or airborne dust or metallic particles.
3. Only use AC motor drives within specification. Failure to comply may result in fire, explosion or electric shock.
4. To prevent personal injury, please keep children and unqualified people away from the equipment.
5. When the motor cable between AC motor drive and motor is too long, the layer insulation of the motor may be damaged. Please use a frequency inverter duty motor or add an AC output reactor to prevent damage to the motor. Refer to appendix B Reactor for details.
6. The rated voltage for AC motor drive must be $\leq 240V$ ($\leq 480V$ for 460V models) and the mains supply current capacity must be $\leq 5000A$ RMS ($\leq 10000A$ RMS for the $\geq 40hp$ (30kW) models)

Table of Contents

| | |
|---|------------|
| Preface | i |
| Table of Contents | iii |
| Chapter 1 Introduction | 1-1 |
| 1.1 Receiving and Inspection | 1-2 |
| 1.1.1 Nameplate Information | 1-2 |
| 1.1.2 Model Explanation | 1-2 |
| 1.1.3 Series Number Explanation | 1-3 |
| 1.1.4 Drive Frames and Appearances | 1-3 |
| 1.1.5 Drive Features | 1-5 |
| 1.2 Preparation for Installation and Wiring | 1-6 |
| 1.2.1 Ambient Conditions | 1-6 |
| 1.2.2 Remove Front Cover | 1-7 |
| 1.2.3 Lifting | 1-8 |
| 1.2.4 Flange Mounting | 1-9 |
| 1.2.5 Cutout Dimensions | 1-11 |
| 1.3 Dimensions | 1-13 |
| Chapter 2 Installation and Wiring | 2-1 |
| 2.1 Wiring | 2-1 |
| 2.2 External Wiring | 2-6 |
| 2.3 Main Circuit | 2-7 |

| | |
|--|------------|
| 2.3.1 Main Circuit Connection | 2-7 |
| 2.3.2 Main Circuit Terminals..... | 2-9 |
| 2.4 Control Terminals | 2-10 |
| Chapter 3 Operation and Start Up | 3-1 |
| 3.1 Operation Method | 3-1 |
| 3.2 Trial Run | 3-3 |
| 3.3 Auto-tuning Operations | 3-4 |
| 3.3.1 Flow Chart..... | 3-4 |
| 3.3.2 Explanations for the Auto-tuning Steps | 3-5 |
| 3.3.2.1 Step 1 | 3-5 |
| 3.3.2.2 Step 2 | 3-7 |
| 3.3.2.3 Step 3 | 3-9 |
| 3.3.2.4 Step 4 | 3-11 |
| 3.3.2.5 Step 5 | 3-13 |
| 3.3.2.6 Step 6 | 3-13 |
| Chapter 4 Parameters..... | 4-1 |
| 4.1 Summary of Parameter Settings..... | 4-2 |
| 4.2 Description of Parameter Settings | 4-20 |
| Chapter 5 Troubleshooting | 5-1 |
| 5.1 Over Current (OC) | 5-1 |
| 5.2 Ground Fault..... | 5-2 |
| 5.3 Over Voltage (OV) | 5-2 |
| 5.4 Low Voltage (Lv)..... | 5-3 |
| 5.5 Over Heat (OH)..... | 5-4 |
| 5.6 Overload | 5-4 |

| | |
|--|------------|
| 5.7 Display of KPVL-CC01 is Abnormal | 5-5 |
| 5.8 Phase Loss (PHL) | 5-5 |
| 5.9 Motor cannot Run | 5-6 |
| 5.10 Motor Speed cannot be Changed..... | 5-7 |
| 5.11 Motor Stalls during Acceleration | 5-8 |
| 5.12 The Motor does not Run as Expected | 5-8 |
| 5.13 Electromagnetic/Induction Noise | 5-9 |
| 5.14 Environmental Condition | 5-9 |
| 5.15 Affecting Other Machines | 5-10 |
| Chapter 6 Fault Code Information and Maintenance..... | 6-1 |
| 6.1 Fault Code Information | 6-1 |
| 6.1.1 Common Problems and Solutions..... | 6-2 |
| 6.1.2 Reset | 6-9 |
| 6.2 Maintenance and Inspections..... | 6-11 |
| Appendix A Specifications | A-1 |
| Appendix B Accessories | B-1 |
| B.1 All Brake Resistors & Brake Units Used in AC Motor Drives..... | B-2 |
| B.1.1 Dimensions and Weights for Brake Resistors | B-4 |
| B.1.2 Specifications for Brake Unit | B-6 |
| B.1.3 Dimensions for Brake Unit..... | B-7 |
| B.2 Non-fuse Circuit Breaker Chart..... | B-9 |
| B.3 Fuse Specification Chart..... | B-9 |
| B.4 AC Reactor | B-11 |
| B.4.1 AC Input Reactor Recommended Value..... | B-11 |

| | |
|---|------------|
| B.4.2 AC Output Reactor Recommended Value | B-11 |
| B.4.3 Applications for AC Reactor | B-12 |
| B.5 Zero Phase Reactor (RF220X00A) | B-15 |
| B.6 DC Choke Recommended Values | B-16 |
| B.7 Digital Keypad KPVL-CC01 | B-17 |
| B.7.1 Description of the Digital Keypad KPVL-CC01 | B-17 |
| B.7.2 How to Operate the Digital Keypad KPVL-CC01 | B-19 |
| B.7.3 Dimension of the Digital Keypad | B-21 |
| B.7.4 Recommended Position the Rubber Magnet of the Digital Keypad | B-21 |
| B.8 PG Card (for Encoder) | B-22 |
| B.8.1 EMVL-PGABL | B-22 |
| B.8.2 EMVL-PGABO | B-25 |
| B.8.3 EMVL-PGH01 (only for Heidenhain ERN1387) | B-28 |
| B.8.4 EMVL-PGS01 | B-32 |
| B.9 AMD-EMI Filter Cross Reference | B-36 |
| B.9.1 Dimensions | B-38 |
| B.10 EMVL-IOA01 | B-43 |
| B.11 Safety Relay EMVL-SAF01 | B-44 |
| B.11.1 Functions of the Terminals | B-44 |
| B.11.2 Wiring of the Safety Relay | B-44 |
| Appendix C How to Select the Right AC Motor Drive | C-1 |
| C.1 Capacity Formulas | C-2 |
| C.2 General Precaution | C-4 |
| C.3 How to Choose a Suitable Motor | C-5 |

Chapter 1 Introduction

The AC motor drive should be kept in the shipping carton or crate before installation. In order to retain the warranty coverage, the AC motor drive should be stored properly when it is not to be used for an extended period of time. Storage conditions are:



CAUTION!

1. Store in a clean and dry location free from direct sunlight or corrosive fumes.
2. Store within an ambient temperature range of -20°C to $+60^{\circ}\text{C}$.
3. Store within a relative humidity range of 0% to 90% and non-condensing environment.
4. Store within an air pressure range of 86 kPA to 106kPA.
5. DO NOT place on the ground directly. It should be stored properly. Moreover, if the surrounding environment is humid, you should put exsiccator in the package.
6. DO NOT store in an area with rapid changes in temperature. It may cause condensation and frost.
7. If the AC motor drive is stored for more than 3 months, the temperature should not be higher than 30°C . Storage longer than one year is not recommended, it could result in the degradation of the electrolytic capacitors.
8. When the AC motor drive is not used for longer time after installation on building sites or places with humidity and dust, it's best to move the AC motor drive to an environment as stated above.

1.1 Receiving and Inspection

This VFD-VL AC motor drive has gone through rigorous quality control tests at the factory before shipment. After receiving the AC motor drive, please check for the following:

- Check to make sure that the package includes an AC motor drive, the User Manual/Quick Start and CD.
- Inspect the unit to assure it was not damaged during shipment.
- Make sure that the part number indicated on the nameplate corresponds with the part number of your order.

1.1.1 Nameplate Information

Example for 15HP/11kW 230V 3-Phase AC motor drive

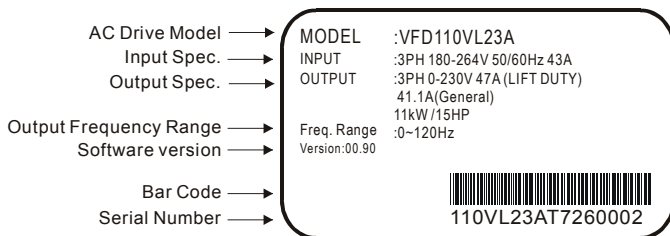

1.1.2 Model Explanation

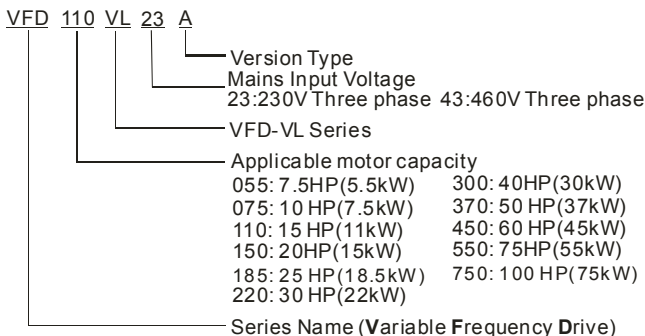

1.1.3 Series Number Explanation

110VL23A T 7 26 0002

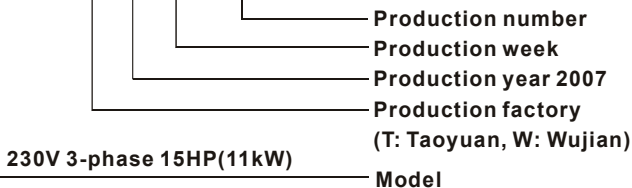

230V 3-phase 15HP(11kW) Model
 (T: Taoyuan, W: Wujian)
 Production year 2007
 Production week
 Production number

If the nameplate information does not correspond to your purchase order or if there are any problems, please contact your distributor.

1.1.4 Drive Frames and Appearances

7.5-15HP/5.5-11kW(Frame C)



20-30HP/15-22kW(Frame D)



40-100HP/30-75kW(Frame E)

| Frame | Power range | Models |
|--------|---------------------|--|
| C | 7.5-15HP (5.5-11kW) | VFD055VL23A/43A, VFD075VL23A/43A, VFD110VL23A/43A |
| D | 20-30HP (15-22kW) | VFD150VL23A/43A, VFD185VL23A/43A, VFD220VL23A/43A |
| E (E1) | 40-60hp (30-45kW) | VFD300VL43A, VFD370VL43A, VFD450V43A |
| E (E2) | 40-100hp (30-75kW) | VFD300VL23A, VFD370VL23A, VFD550VL43A, VFD750VL43A |

Please refer to Chapter 1.3 for exact dimensions.

1.1.5 Drive Features

Communication Port



Internal structure



Removable fan



1.2 Preparation for Installation and Wiring

1.2.1 Ambient Conditions

Install the AC motor drive in an environment with the following conditions:

| | | |
|-------------------------------|---|--|
| Operation | Air Temperature: | -10 ~ +45°C (14 ~ 113°F) |
| | Relative Humidity: | <90%, no condensation allowed |
| | Atmosphere pressure: | 86 ~ 106 kPa |
| | Installation Site Altitude: | <1000m |
| | Vibration: | <20Hz: 9.80 m/s ² (1G) max 20 ~ 50Hz: 5.88 m/s ² (0.6G) max |
| Storage Transportation | Temperature: | -20°C ~ +60°C (-4°F ~ 140°F) |
| | Relative Humidity: | <90%, no condensation allowed |
| | Atmosphere pressure: | 86 ~ 106 kPa |
| | Vibration: | <20Hz: 9.80 m/s ² (1G) max 20 ~ 50Hz: 5.88 m/s ² (0.6G) max |
| Pollution Degree | 2: good for a factory type environment. | |

Minimum Mounting Clearances

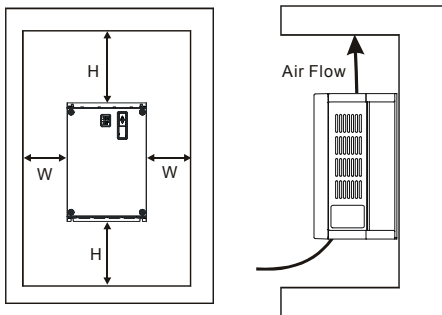

| HP | W mm (inch) | H mm (inch) |
|----------|----------------|----------------|
| 7.5-20HP | 75 (3) | 175 (7) |
| 25-75HP | 75 (3) | 200 (8) |
| 100HP | 75 (3) | 250 (10) |

**CAUTION!**

1. Operating, storing or transporting the AC motor drive outside these conditions may cause damage to the AC motor drive.
2. Failure to observe these precautions may void the warranty!
3. Mount the AC motor drive vertically on a flat vertical surface object by screws. Other directions are not allowed.
4. The AC motor drive will generate heat during operation. Allow sufficient space around the unit for heat dissipation.
5. The heat sink temperature may rise to 90°C when running. The material on which the AC motor drive is mounted must be noncombustible and be able to withstand this high temperature.
6. When AC motor drive is installed in a confined space (e.g. cabinet), the surrounding temperature must be within 10 ~ 40°C with good ventilation. DO NOT install the AC motor drive in a space with bad ventilation.
7. Prevent fiber particles, scraps of paper, saw dust, metal particles, etc. from adhering to the heatsink.
8. When installing multiple AC more drives in the same cabinet, they should be adjacent in a row with enough space in-between. When installing one AC motor drive below another one, use a metal separation between the AC motor drives to prevent mutual heating.

1.2.2 Remove Front Cover

7.5-15HP/5.5-11kW(frame C) & 20-30HP/15-22kW(frame D)

After removing the screws, please push the front cover to open it. For the open cover direction, please refer to the following picture.



40-100HP/30-75kW (frame E)

After removing the screws, please push the front cover to open it. For the open cover direction, please refer to the following picture.

**1.2.3 Lifting**

Please carry only fully assembled AC motor drives as shown in the following.

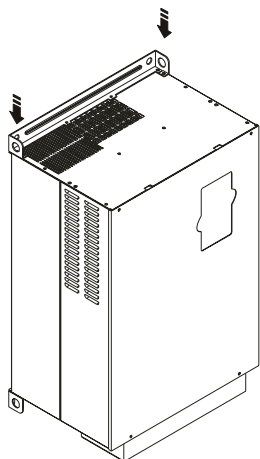
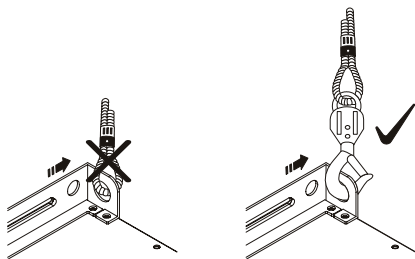
For 40-100HP (Frame E)**Step 1****Step 2**

Step 3

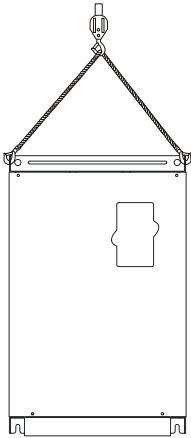

Step 4

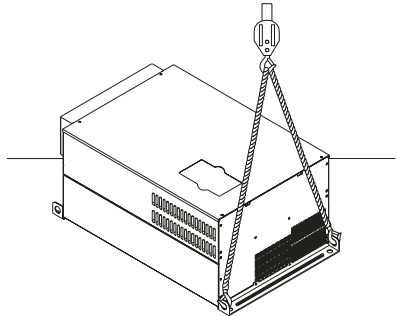

1.2.4 Flange Mounting

Step 1: Please take out the 16 screws (8 screws for each top and bottom side of the drive) and remove the fixed plate 1 and fixed plate 2 as shown in the following figures.

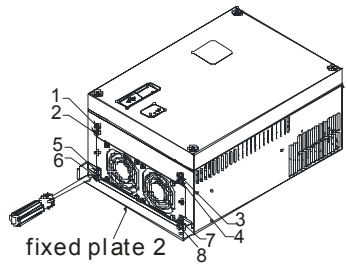
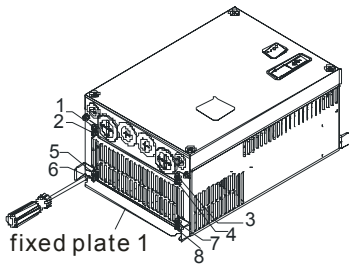

Step 2: place the 8 screws back in to secure the fixed plate 1 and fixed plate 2 (as shown in the following figures) with the following torque.

Frame C: 14-17kgf-cm [12.2-14.8in-lbf]

Frame D: 20-25kgf-cm [17.4-21.7in-lbf]

Frame E: 20-25kgf-cm [17.4-21.7in-lbf]

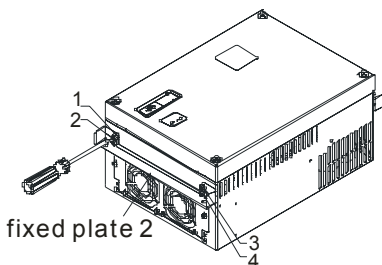
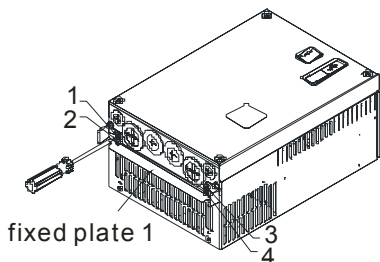

Step 3: Please notice that it doesn't need to put those 8 screws shown in the following figures back to the drive. Moreover, please make sure that these 2 different fixed plates are put in the correct side as shown in the figures.

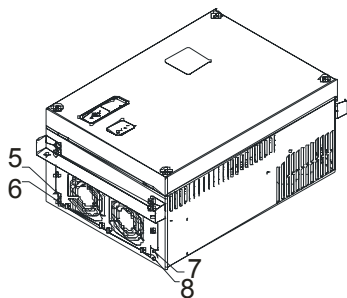
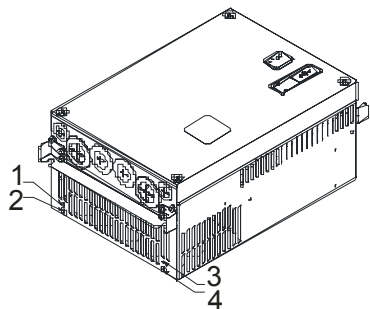

1.2.5 Cutout Dimensions

7.5-15HP/5.5-11kW (frame C)

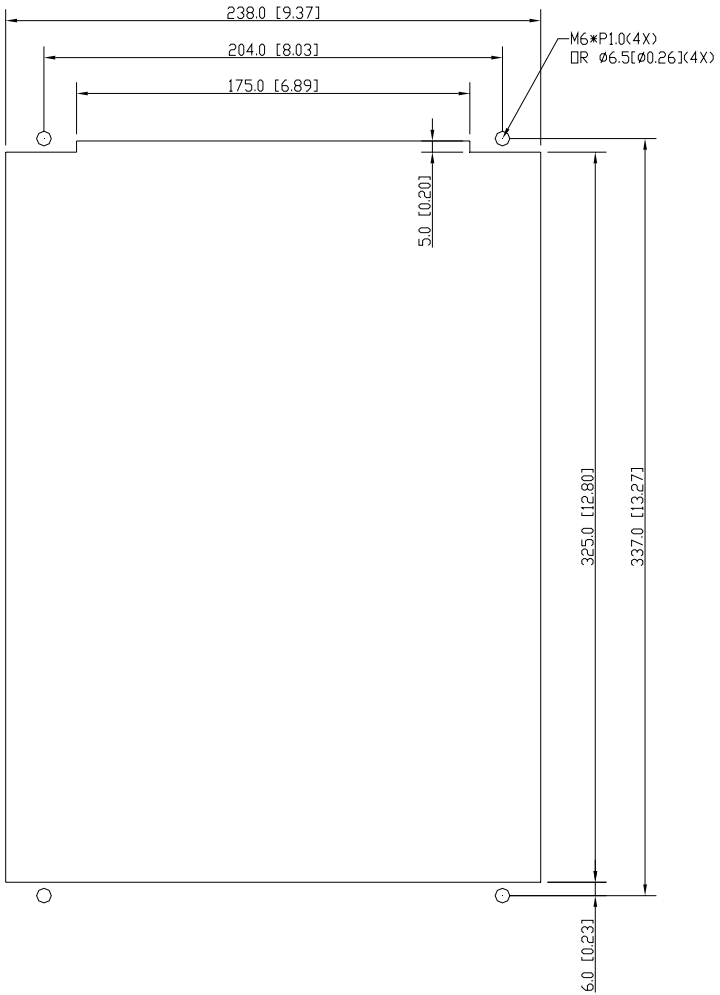

20-30HP/15-22kW (frame D)

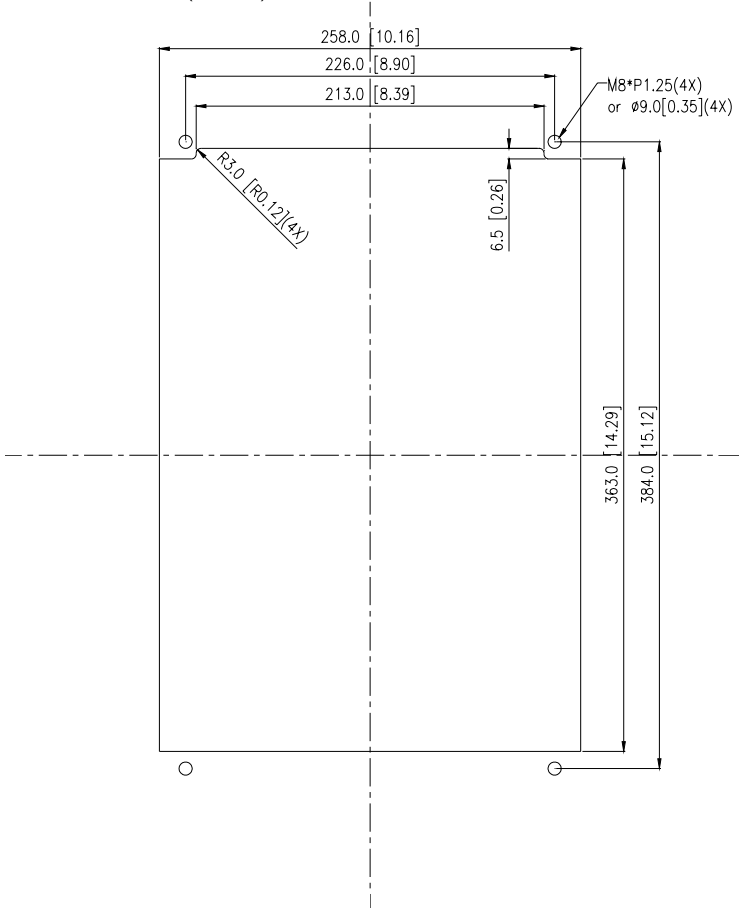

1.3 Dimensions

Frame C

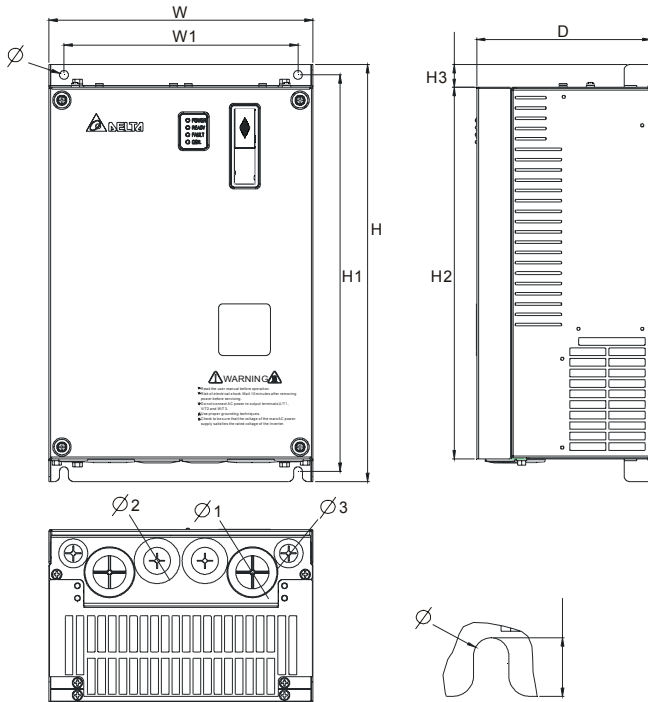

Unit: mm [inch]

| Frame | W | W1 | H | H1 | H2 | H3 | D | \varnothing | $\varnothing 1$ | $\varnothing 2$ | $\varnothing 3$ |
|-------|---------------|---------------|----------------|----------------|----------------|----|---------------|---------------|-----------------|-----------------|-----------------|
| C | 235 [9.25] | 204 [8.03] | 350 [13.78] | 337 [13.27] | 320 [12.60] | - | 136 [5.35] | 6.5 [0.26] | - | 34 [1.34] | 22 [0.87] |



Frame C: VFD055VL23A/43A, VFD075VL23A/43A, VFD110VL23A/43A

Frame D

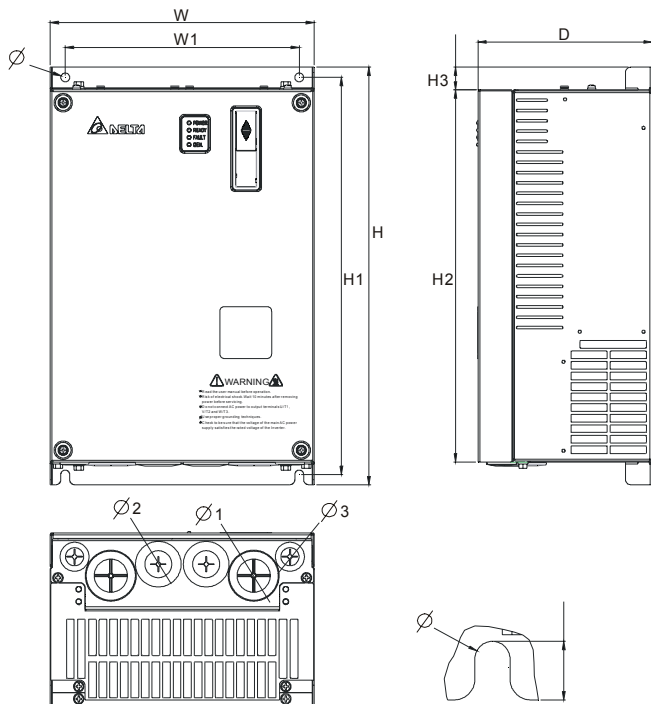

Unit: mm [inch]

| Frame | W | W1 | H | H1 | H2 | H3 | D | Ø | Ø1 | Ø2 | Ø3 |
|-------|------------------|-----------------|------------------|------------------|------------------|----------------|-----------------|---------------|--------------|--------------|--------------|
| D | 255.0 [10.04] | 226.0 [8.90] | 403.8 [15.90] | 384.0 [15.12] | 360.0 [14.17] | 21.9 [0.86] | 168.0 [6.61] | 8.5 [0.33] | 44 [1.73] | 34 [1.34] | 22 [0.87] |

NOTE

Frame D: VFD150VL23A/43A, VFD185VL23A/43A, VFD220VL23A/43A

Frame E

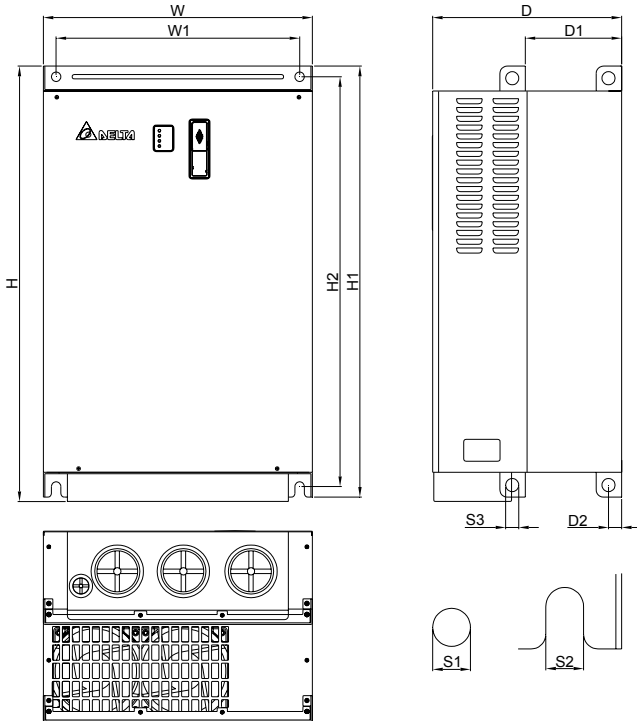

Unit: mm [inch]

| Frame | W | W1 | H | H1 | H2 | D | D1 | D2 | S1 | S2 | S3 |
|-------|------------------|------------------|------------------|------------------|------------------|------------------|-----------------|----------------|----------------|----------------|----------------|
| E1 | 370.0 [14.57] | 335.0 [13.19] | - | 589.0 [23.19] | 560.0 [22.05] | 260.0 [10.24] | 132.5 [5.22] | 18.0 [0.71] | 13.0 [0.51] | 13.0 [0.51] | 18.0 [0.71] |
| E2 | 370.0 [14.57] | 335.0 [13.19] | 595.0 [23.43] | 589.0 [23.19] | 560.0 [22.05] | 260.0 [10.24] | 132.5 [5.22] | 18.0 [0.71] | 13.0 [0.51] | 13.0 [0.51] | 18.0 [0.71] |

 **NOTE**

Frame E1: VFD300VL43A, VFD370VL43A, VFD450VL43A

Frame E2: VFD300VL23A, VFD370VL23A, VFD550VL43A, VFD750VL43A

This page intentionally left blank

Chapter 2 Installation and Wiring

After removing the front cover (see chapter 1.2.2 for details), check if the power and control terminals are clear. Be sure to observe the following precautions when wiring.



CAUTION!

1. Make sure that power is only applied to the R/L1, S/L2, T/L3 terminals. Failure to comply may result in damage to the equipment. The voltage and current should lie within the range as indicated on the nameplate.
2. Check the following items after finishing the wiring:
 - A. Are all connections correct?
 - B. No loose wires?
 - C. No short-circuits between terminals or to ground?



DANGER!

1. A charge may still remain in the DC bus capacitors with hazardous voltages even if the power has been turned off. To prevent personal injury, please ensure that the power is turned off and wait ten minutes for the capacitors to discharge to safe voltage levels before opening the AC motor drive.
2. All the units must be grounded directly to a common ground terminal to prevent lightning strike or electric shock.
3. Only qualified personnel familiar with AC motor drives is allowed to perform installation, wiring and commissioning.
4. Make sure that the power is off before doing any wiring to prevent electric shock.

2.1 Wiring

Users must connect wires according to the circuit diagrams on the following pages. Do not plug a modem or telephone line to the RS-485 communication port or permanent damage may result. Pins 1 & 2 are the power supply for the optional copy keypad only and should not be used for RS-485 communication.

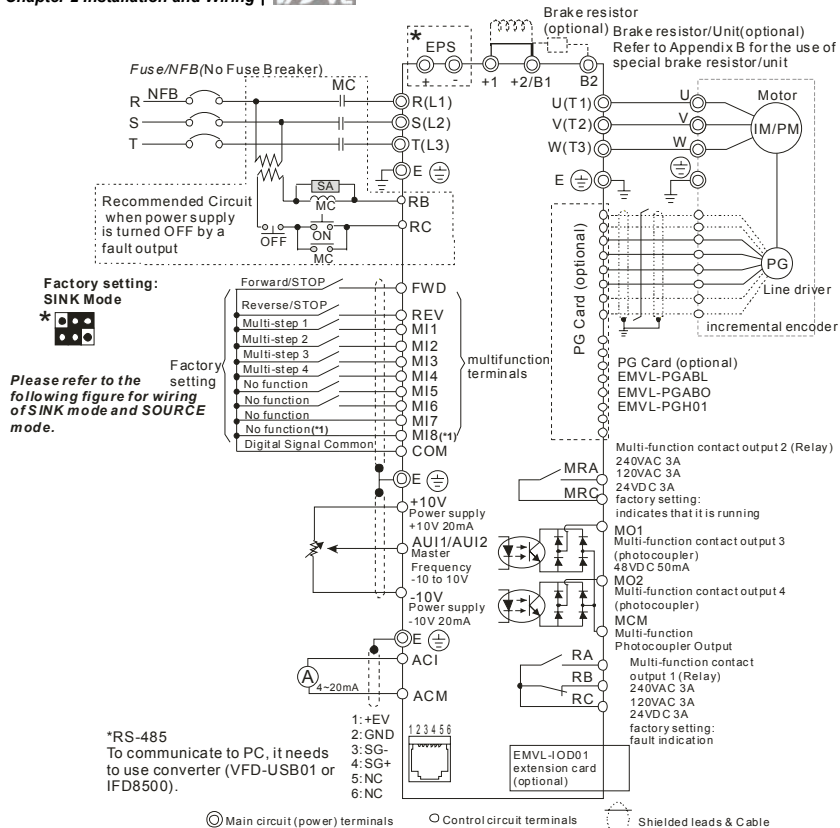

Figure 2 Wiring/Terminals setting for SINK(NPN) mode and SOURCE(PNP) mode

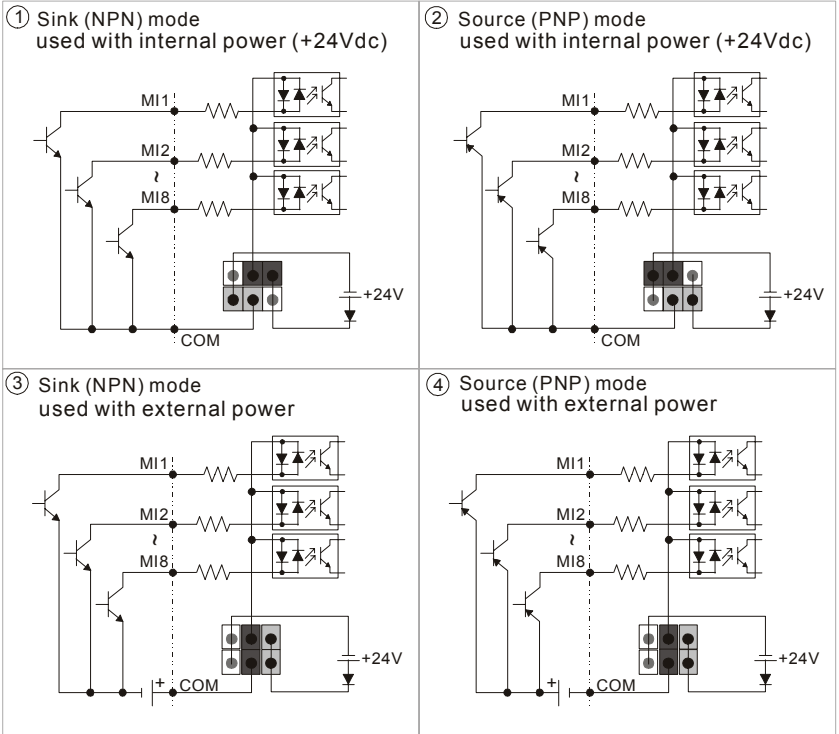

Figure 3 Apply to 1-phase UPS power supply system

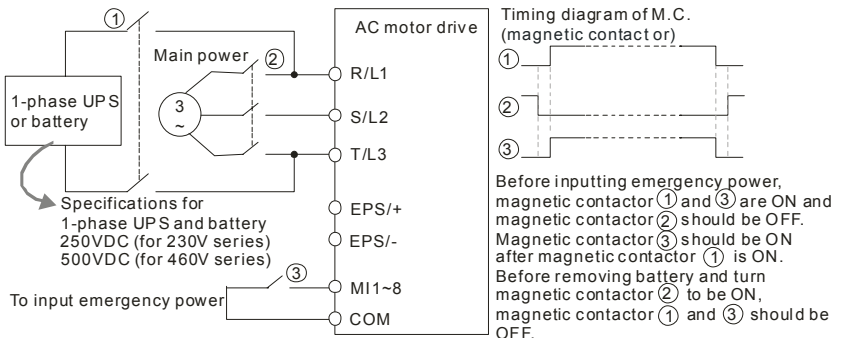
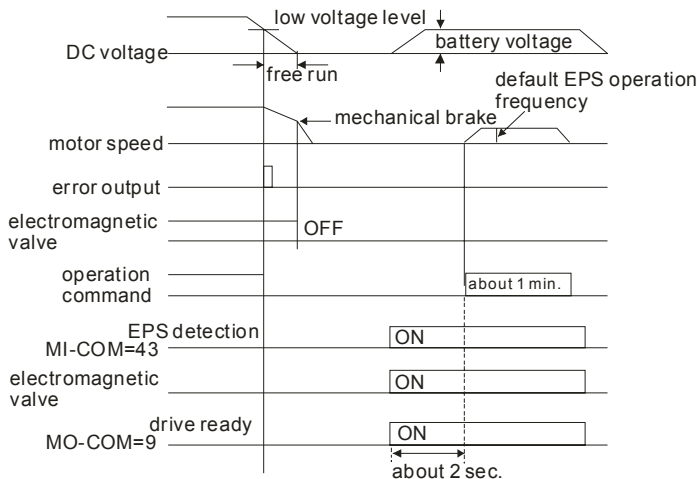
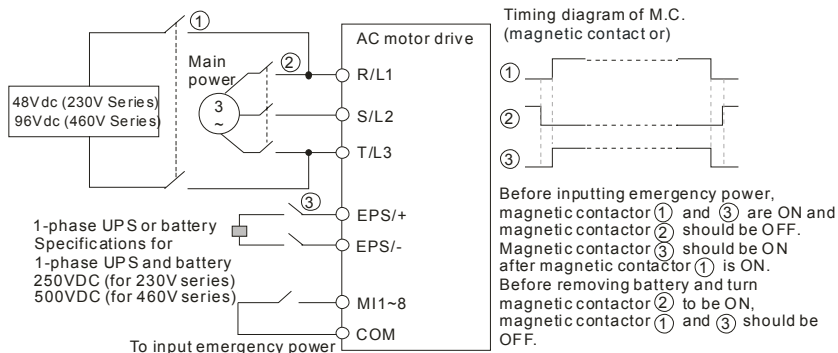

Figure 4 Apply to two batteries with main battery voltage is lower than 280Vdc



CAUTION!

1. The wiring of main circuit and control circuit should be separated to prevent erroneous actions.
2. Please use shield wire for the control wiring and not to expose the peeled-off net in front of the terminal.
3. Please use the shield wire or tube for the power wiring and ground the two ends of the shield wire or tube.
4. Damaged insulation of wiring may cause personal injury or damage to circuits/equipment if it comes in contact with high voltage.

5. The AC motor drive, motor and wiring may cause interference. To prevent the equipment damage, please take care of the erroneous actions of the surrounding sensors and the equipment.
6. When the AC drive output terminals U/T1, V/T2, and W/T3 are connected to the motor terminals U/T1, V/T2, and W/T3, respectively. To permanently reverse the direction of motor rotation, switch over any of the two motor leads.
7. With long motor cables, high capacitive switching current peaks can cause over-current, high leakage current or lower current readout accuracy. For longer motor cables use an AC output reactor.
8. The AC motor drive, electric welding machine and the greater horsepower motor should be grounded separately.
9. Use ground leads that comply with local regulations and keep them as short as possible.
10. No brake resistor is built in the VFD-VL series, it can install brake resistor for those occasions that use higher load inertia or frequent start/stop. Refer to Appendix B for details.
11. Multiple VFD-VL units can be installed in one location. All the units should be grounded directly to a common ground terminal, as shown in the figure below. **Ensure there are no ground loops.**

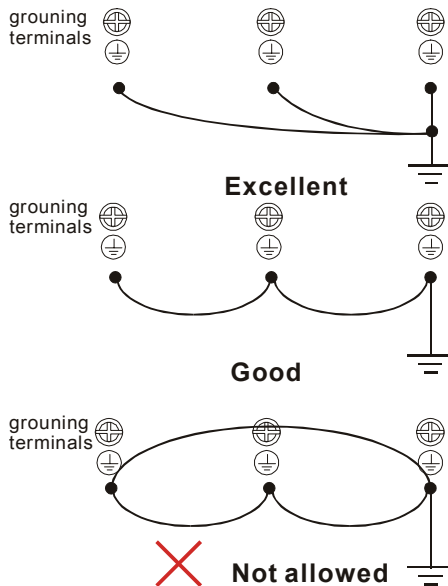

2.2 External Wiring

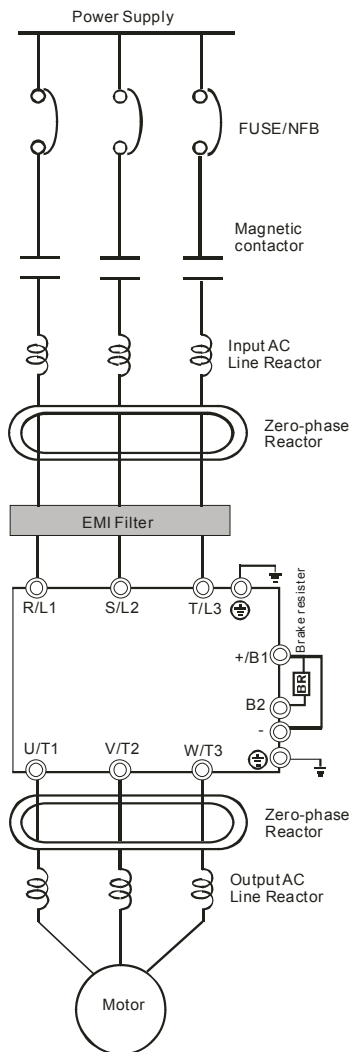

| Items | Explanations |
|---|--|
| Power supply | Please follow the specific power supply requirements shown in Appendix A. |
| Fuse/NFB (Optional) | There may be an inrush current during power up. Please check the chart of Appendix B and select the correct fuse with rated current. Use of an NFB is optional. |
| Magnetic contactor (Optional) | Please do not use a Magnetic contactor as the I/O switch of the AC motor drive, as it will reduce the operating life cycle of the AC drive. |
| Input AC Line Reactor (Optional) | Used to improve the input power factor, to reduce harmonics and provide protection from AC line disturbances- (surges, switching spikes, short interruptions, etc.). AC line reactor should be installed when the power supply capacity is 500kVA or more and exceeds 6 times the inverter capacity, or the mains wiring distance $\leq 10m$. |
| Zero-phase Reactor (Ferrite Core Common Choke) (Optional) | Zero phase reactors are used to reduce radio noise especially when audio equipment is installed near the inverter. Effective for noise reduction on both the input and output sides. Attenuation quality is good for a wide range from AM band to 10MHz. Appendix B specifies the zero phase reactor. (RF220X00A) |
| EMI filter (Optional) | To reduce electromagnetic interference, please refer to Appendix B for more details. |
| Brake Resistor (Optional) | Used to reduce the deceleration time of the motor. Please refer to the chart in Appendix B for specific Brake Resistors. |
| Output AC Line Reactor (Optional) | Motor surge voltage amplitude depends on motor cable length. For applications with long motor cable (>20m), it is necessary to install a reactor at the inverter output side. |

2.3 Main Circuit

2.3.1 Main Circuit Connection

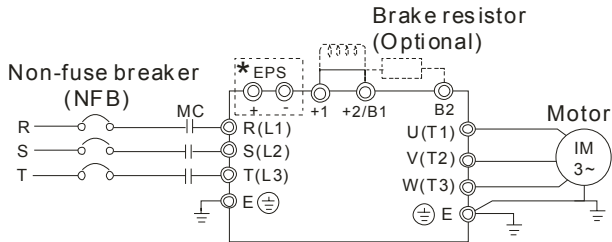

| Terminal Symbol | Explanation of Terminal Function |
|---|--|
| EPS (+, -) | For emergency power or backup power supply |
| R/L1, S/L2, T/L3 | AC line input terminals |
| U/T1, V/T2, W/T3 | AC drive output terminals for connecting 3-phase induction motor |
| +1, +2/B1 | Connections for DC Choke (optional). Please remove jumper when installation. (It is built in DC choke for models 22kW and above) |
| +2/B1, B2 | Connections for Brake Resistor (optional) |
|  | Earth connection, please comply with local regulations. |

Mains power terminals (R/L1, S/L2, T/L3)

- Connect these terminals (R/L1, S/L2, T/L3) via a non-fuse breaker or earth leakage breaker to 3-phase AC power (some models to 1-phase AC power) for circuit protection. It is unnecessary to consider phase-sequence.
- It is recommended to add a magnetic contactor (MC) in the power input wiring to cut off power quickly and reduce malfunction when activating the protection function of AC motor drives. Both ends of the MC should have an R-C surge absorber.
- Please make sure to fasten the screw of the main circuit terminals to prevent sparks which is made by the loose screws due to vibration.
- Please use voltage and current within the regulation shown in Appendix A.
- When using a general GFCI (Ground Fault Circuit Interrupter), select a current sensor with sensitivity of 200mA or above, and not less than 0.1-second operation time to avoid nuisance tripping. For the specific GFCI of the AC motor drive, please select a current sensor with sensitivity of 30mA or above.
- Do NOT run/stop AC motor drives by turning the power ON/OFF. Run/stop AC motor drives by RUN/STOP command via control terminals or keypad. If you still need to run/stop AC drives by turning power ON/OFF, it is recommended to do so only ONCE per hour.
- Do NOT connect 3-phase models to a 1-phase power source.

Output terminals for main circuit (U, V, W)

- When it needs to install the filter at the output side of terminals U/T1, V/T2, W/T3 on the AC motor drive. Please use inductance filter. Do not use phase-compensation capacitors or L-C (Inductance-Capacitance) or R-C (Resistance-Capacitance), unless approved by Delta.
- DO NOT connect phase-compensation capacitors or surge absorbers at the output terminals of AC motor drives.
- Use well-insulated motor, suitable for inverter operation.

Terminals [+1, +2] for connecting DC reactor, terminals [+1, +2/B1] for connecting brake resistor

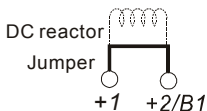

- To improve power factor and reduce harmonics connect a DC reactor between terminals [+1, +2/B1]. Please remove the jumper before connecting the DC reactor.

- Models above 22kW don't have a built-in brake chopper. Please connect an external optional brake resistor.
- When not used, please leave the terminals [+2/B1, -] open.
- Short-circuiting [B2] or [-] to [+2/B1] can damage the AC motor drive.

2.3.2 Main Circuit Terminals

Frame C

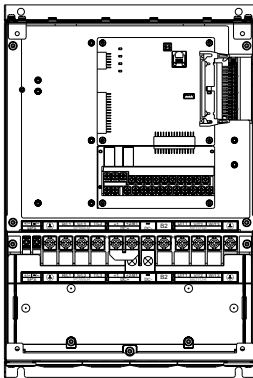

Main circuit terminals

R/L1, S/L2, T/L3, U/T1, V/T2, W/T3, \oplus , +1, +2/B1, -, B2

| Models | Wire | Torque | Wire Type |
|-------------|---|------------------------|----------------------------------|
| VFD055VL23A | 10-6 AWG. (5.3-13.3mm ²) | 30kgf-cm (26in-lbf) | Stranded copper only, 75°C |
| VFD110VL43A | | | |
| VFD055VL43A | 12-6 AWG. (3.3-13.3mm ²) | | |
| VFD075VL43A | | | |
| VFD075VL23A | 8-6 AWG. (8.4-13.3mm ²) | | |
| VFD110VL23A | 6 AWG. (13.3mm ²) | | |

Frame D

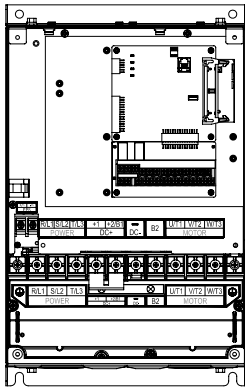

Main circuit terminals

R/L1, S/L2, T/L3, U/T1, V/T2, W/T3, \oplus , +1, +2, -

| Models | Wire | Torque | Wire Type |
|-------------|---|---------------------------|----------------------------------|
| VFD150VL43A | 8-2 AWG. (8.4-33.6mm ²) | 50Kgf-cm (43.4 lbf-in) | Stranded copper only, 75°C |
| VFD185VL43A | | | |
| VFD150VL23A | 4-2 AWG. (21.1-33.6mm ²) | | |
| VFD185VL23A | 3-2 AWG. (26.7-33.6mm ²) | | |
| VFD220VL43A | 6-2 AWG (13.3-33.6mm ²) | | |
| VFD220VL23A | 3-2 AWG (26.7-33.6mm ²) | | |

Frame E

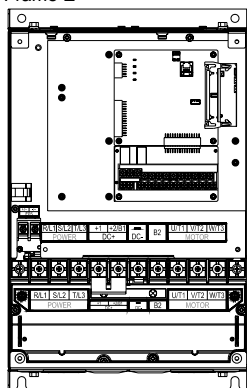

Main circuit terminals

R/L1, S/L2, T/L3, U/T1, V/T2, W/T3, ⊕, +1, +2, -

| Models | Wire | Torque | Wire Type |
|-------------|----------------------------|--------------------------|-----------------------------------|
| VFD300VL43A | 4-2 AWG. (21.2-33.6mm2) | 57kgf-cm (49in-lbf) | Stranded copper only, 75 °C |
| VFD370VL43A | | | |
| VFD450VL43A | | | |
| VFD300VL23A | | 200kgf-cm (173in-lbf) | |
| VFD370VL23A | | | |
| VFD550VL43A | | | |
| VFD750VL43A | | | |

2.4 Control Terminals

① Sink /NPN Mode

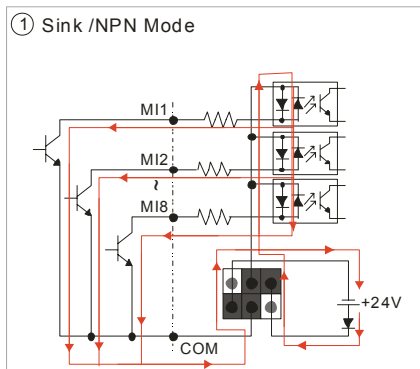

② Source Mode

used with internal power (+24Vdc)

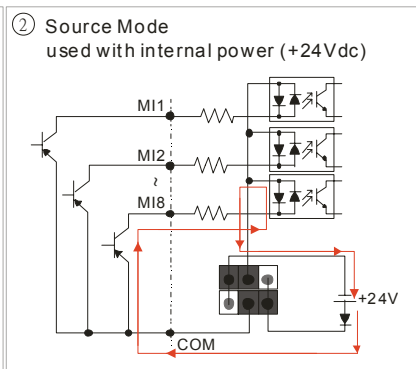

The Position of External Terminals

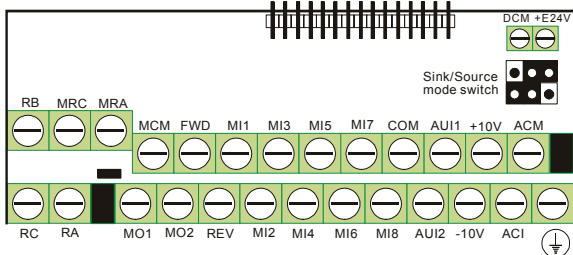

Terminal symbols and functions

| Terminal Symbol | Terminal Function | Factory Settings (SINK) ON: Connect to DCM |
|-----------------|---|--|
| FWD | Forward-Stop Command | ON: RUN in FWD direction OFF: Stop acc. to Stop Method |
| REV | Reverse-Stop Command | ON: RUN in REV direction OFF: Stop acc. to Stop Method |
| MI1 | Multi-function Input 1 | Refer to Pr.02-01 to Pr.02-08 for programming the Multi-function Inputs. ON: input voltage is 24Vdc (Max. 30Vdc), input impedance is 3.75kΩ OFF: leakage current tolerance is 10μA. MI8: when JP1 is inserted, this function is disabled. |
| MI2 | Multi-function Input 2 | |
| MI3 | Multi-function Input 3 | |
| MI4 | Multi-function Input 4 | |
| MI5 | Multi-function Input 5 | |
| MI6 | Multi-function Input 6 | |
| MI7 | Multi-function Input 7 | |
| MI8 | Multi-function Input 8 | |
| COM | Digital Signal Common | Common for digital inputs and used for SINK mode |
| +E24V | Digital Signal Common (Source) | +24V 80mA |
| DCM | Digital Signal Common (Sink) | Common for digital inputs and used for SINK mode |
| RA | Multi-function Relay Output 1 (N.O.) a | Resistive Load: 5A(N.O.)/3A(N.C.) 240VAC 5A(N.O.)/3A(N.C.) 24VDC Inductive Load: 1.5A(N.O.)/0.5A(N.C.) 240VAC 1.5A(N.O.)/0.5A(N.C.) 24VDC |
| RB | Multi-function Relay Output 1 (N.C.) b | |
| RC | Multi-function Relay Common | |
| MRA | Multi-function Relay Output 2 (N.O.) a | To output monitor signal, including in operation, frequency arrival, overload and etc. |
| MRC | Multi-function Relay Common | Refer to Pr.02-11~02-12 for programming |
| +10V | Potentiometer Power Supply | -10~+10VDC 20mA (variable resistor 3-5kohm) |
| -10V | | |
| MCM | Multi-function Output Common (Photocoupler) | Max. 48VDC 50mA |

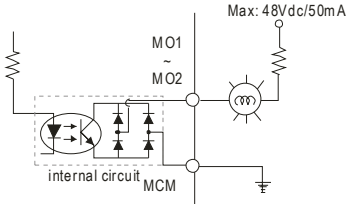
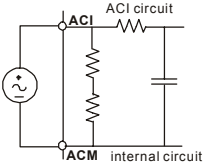
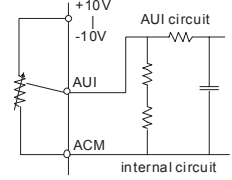
| Terminal Symbol | Terminal Function | Factory Settings (SINK) ON: Connect to DCM |
|-----------------|---|---|
| MO1 | Multi-function Output 1 (Photocoupler) | <p>The AC motor drive output every monitor signal, such as operational, frequency attained, overload, etc. by open collector transistor. Refer to Pr.03.01 multi-function output terminals for details.</p>  |
| MO2 | Multi-function Output 2 (Photocoupler) | |
| ACI | <p>Analog current Input</p>  | <p>Impedance: 250Ω</p> <p>Resolution: 12 bits</p> <p>Range: 4 ~ 20mA/0~10V = 0 ~ Max. Output Frequency (Pr.01-00)</p> <p>Set-up: Pr.03-00 ~ Pr.03-02</p> |
| AUI1/ AUI2 | <p>Auxiliary analog voltage input</p>  | <p>Impedance: 2mΩ</p> <p>Resolution: 12 bits</p> <p>Range: -10 ~ +10VDC = 0 ~ Max. Output Frequency (Pr.01-00)</p> <p>Set-up: Pr.03-00 ~ Pr.03-02</p> |
| ACM | Analog control signal (common) | Common for ACI, AUI1, AUI2 |

*Control signal wiring size: 18 AWG (0.75 mm²) with shielded wire.

Analog input terminals (ACI, AUI1, AUI2, ACM)

- Analog input signals are easily affected by external noise. Use shielded wiring and keep it as short as possible (<20m) with proper grounding. If the noise is inductive, connecting the shield to terminal ACM can bring improvement.
- If the analog input signals are affected by noise from the AC motor drive, please connect a capacitor and ferrite core as indicated in the following diagrams:

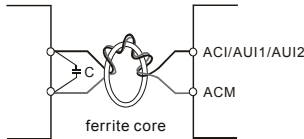

wind each wires 3 times or more around the core

Digital inputs (FWD, REV, MI1~MI8, COM)

- When using contacts or switches to control the digital inputs, please use high quality components to avoid contact bounce.

Digital outputs (MO1, MO2, MCM)

- Make sure to connect the digital outputs to the right polarity, see wiring diagrams.
- When connecting a relay to the digital outputs, connect a surge absorber or fly-back diode across the coil and check the polarity.

The specification for the control terminals

The Position of External Terminals

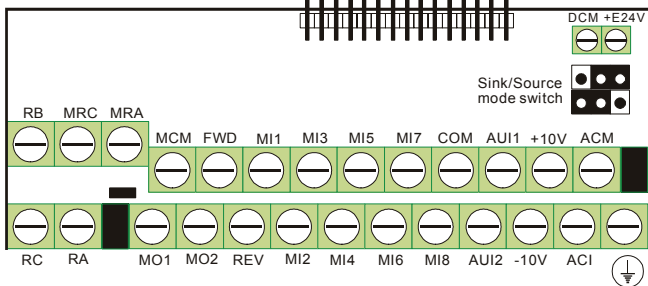

| Frame | Torque | | Wire |
|---------|-----------------------|------------------------|---------------------------------------|
| C, D, E | 8 kgf-cm (6.9 in-lbf) | | 22-14 AWG (0.3-2.1mm ²) |
| | Terminal: 0V/24V | 1.6 kgf-cm(1.4 in-lbf) | 30-16 AWG (0.051-1.3mm ²) |



NOTE

Frame C: VFD055VL23A/43A, VFD075VL23A/43A, VFD110VL23A/43A

Frame D: VFD150VL23A/43A, VFD185VL23A/43A, VFD220VL23A/43A

Frame E: VFD300VL23A/43A, VFD370VL23A/43A, VFD450VL43A, VFD550VL43A, VFD750VL43A

Chapter 3 Operation and Start Up





- Make sure that the wiring is correct. In particular, check that the output terminals U/T1, V/T2, W/T3 are NOT connected to power and that the drive is well grounded.
- Verify that no other equipment is connected to the AC motor
- Do NOT operate the AC motor drive with humid hands.
- Verify that there are no short-circuits between terminals and from terminals to ground or mains power.
- Check for loose terminals, connectors or screws.
- Make sure that the front cover is well installed before applying power.



- Please do NOT touch output terminals U, V, W when power is still applied to L1/R, L2/S, L3/T even when the AC motor drive has stopped. The DC-link capacitors may still be charged to hazardous voltage levels, even if the power has been turned off.

3.1 Operation Method

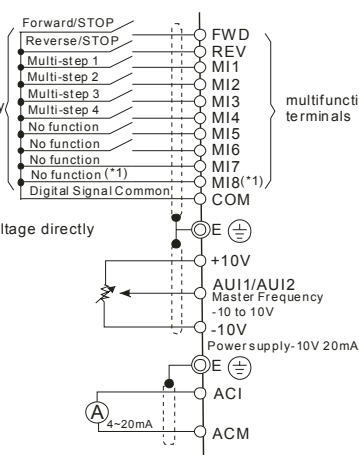
The factory setting for operation method is set to control terminal. But it is just one of the operation methods. The operation method can be via communication, control terminals settings or optional digital keypad KPV-L-CC01. Please choose a suitable method depending on application and operation rule. The operation is usually used as shown in the following table.

| Operation Method | Frequency Source | Operation Command Source | | |
|---|--|--------------------------|-------------|---------------------|
| Operate from communication | Please refer to the communication address 2000H and 2119H settings in the communication address definition. | | | |
| <p>Control Terminals-</p> <p>Operate from external signal</p> | <p>Factory setting: SINK Mode * </p>  <p>* Don't apply the mains voltage directly to above terminals.</p> <p>(*) When JP1  on the control board is inserted, MI8 is disabled.</p> | | | |
| <p>KPVL-CC01 keypad (Optional)</p> |  <table border="1" data-bbox="270 1150 913 1231"> <tr> <td data-bbox="270 1150 754 1231">UP/DOWN key</td> <td data-bbox="757 1150 913 1231">RUN, STOP/RESET key</td> </tr> </table> | | UP/DOWN key | RUN, STOP/RESET key |
| UP/DOWN key | RUN, STOP/RESET key | | | |

3.2 Trial Run

The factory setting of operation source is from external terminals.

1. Please connect a switch for both external terminals FWD-COM and REV-COM.
2. Please connect a potentiometer among AUI1/AUI2, +10V, -10V and ACM or apply power $-10 \sim +10\text{Vdc}$ to AUI1/AUI2-ACM.
3. Setting the potentiometer or $-10 \sim +10\text{Vdc}$ power to less than 1V.
4. Make sure that all external terminal wirings are finished before applying power. After applying power, verify that LED "READY" is ON.
5. Setting FWD-COM=ON for forward running. And if you want to change to reverse running direction, you should set REV-COM=ON. And if you want to decelerate to stop, please set FWD/REV-COM=OFF.
6. Check following items:
 - Check if the motor direction of rotation is correct.
 - Check if the motor runs steadily without abnormal noise and vibration.
 - Check if acceleration and deceleration are smooth.

If the results of trial run are normal, please start the formal run.

3.3 Auto-tuning Operations

3.3.1 Flow Chart

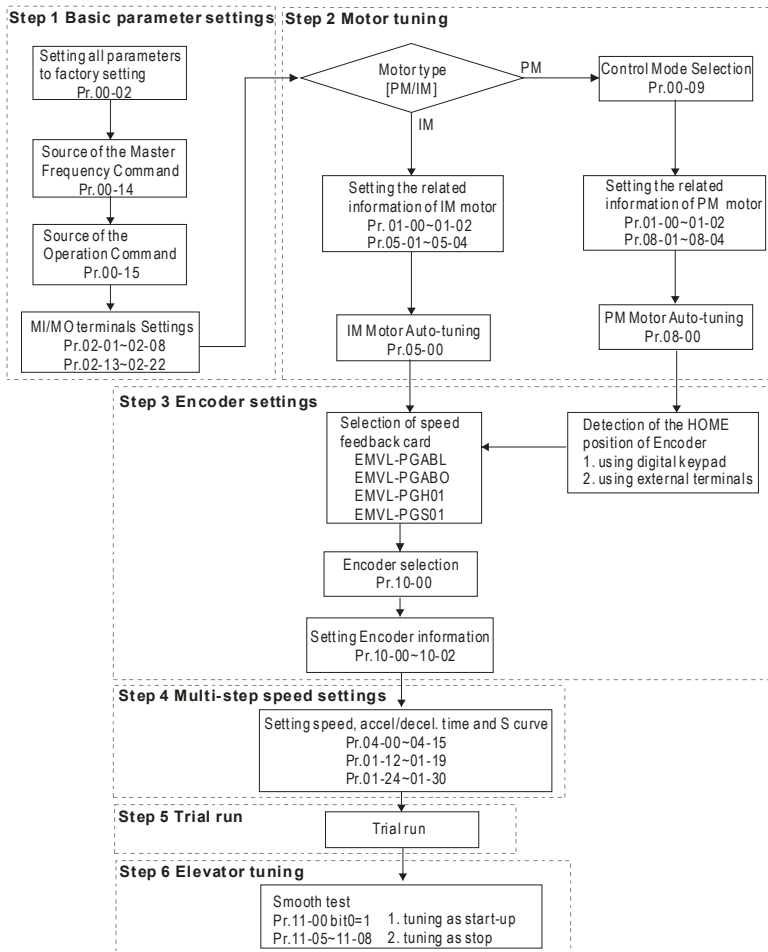

3.3.2 Explanations for the Auto-tuning Steps

3.3.2.1 Step 1

Basic parameters settings

- Make sure that Pr.00-00 (identity code of the AC motor drive) corresponds with the nameplate indicated on the AC motor drive.
- Make sure that all parameters are reset to factory setting (Pr.00-02 is set to 9 or 10).

| | |
|-----------------------------|---|
| Pr.00-02 Parameter Reset | 0: No function 1: Read only 8: Keypad lock 9: All parameters are reset to factory settings (50Hz, 220V/380V) 10: All parameters are reset to factory settings (60Hz, 220V/440V) |
|-----------------------------|---|

- Source of the Master Frequency Command: users can set by themselves (Pr.00-14)

| | |
|--|---|
| Pr.00-14 Source of the Master Frequency Command | 1: RS-485 serial communication or digital keypad (KPVLC-CC01) 2: External analog input (Pr. 03-00) 3: Digital terminals input |
|--|---|

- Source of the Operation Command: users can set by themselves (Pr.00-15)

| | |
|---|--|
| Pr.00-15 Source of the Operation Command | 1: External terminals 2: RS-485 serial communication or digital keypad (KPVLC-CC01) |
|---|--|

- MI/MO external terminals settings:

Refer to Pr.02-01~02-08 for setting the external input terminals MI1~MI8.

NOTE: The factory setting of Pr.02-08 is 40 (Enable drive function). Please disable this function if you don't need to use this function.

| | |
|----------------------------|--|
| Settings of Pr.02-01~02-08 | 0: no function 1: multi-step speed command 1 2: multi-step speed command 2 3: multi-step speed command 3 4: multi-step speed command 4 5: Reset 6: JOG command 7: acceleration/deceleration speed inhibit 8: the 1st, 2nd acceleration/deceleration time selection 9: the 3rd, 4th acceleration/deceleration time selection 10: EF input (07-28) 11: Reserved 12: Stop output 13: Disable auto accel./decel. function |
|----------------------------|--|

| | |
|----------------------------|--|
| Settings of Pr.02-01~02-08 | <ul style="list-style-type: none"> 14: Reserved 15: operation speed command form AUI1 16: operation speed command form ACI 17: operation speed command form AUI2 18: Emergency Stop (07-28) 19-23: Reserved 24: FWD JOG command 25: REV JOG command 26: Reserved 27: ASR1/ASR2 selection 28: Emergency stop (EF1) (Motor coasts to stop) 29-30: Reserved 31: High torque bias (by Pr.07-21) 32: Middle torque bias (by Pr.07-22) 33: Low torque bias (by Pr.07-23) 34-37: Reserved 38: Disable write EEPROM function 39: Torque command direction 40: Enable drive function 41: Reserved 42: Mechanical brake 43: EPS function |
|----------------------------|--|

Refer to Pr.02-13~02-22 for setting external output terminals MO1~MO10.

| | |
|----------------------------|--|
| Settings of Pr.02-13~02-22 | <ul style="list-style-type: none"> 0: No function 1: Operation indication 2: Operation speed attained 3: Desired frequency attained 1 (Pr.02-25) 4: Desired frequency attained 2 (Pr.02-27) 5: Zero speed (frequency command) 6: Zero speed with stop (frequency command) 7: Over torque (OT1) (Pr.06-05~06-07) 8: Over torque (OT2) (Pr.06-08~06-10) 9: Drive ready 10: User-defined Low-voltage Detection (LV) 11: Malfunction indication 12: Mechanical brake release (Pr.02-29, Pr.02-30) 13: Overheat (Pr.06-14) 14: Brake chopper signal 15: Motor-controlled magnetic contactor output 16: Slip error (oSL) 17-18: Reserved |
|----------------------------|--|

| | |
|----------------------------|--|
| Settings of Pr.02-13~02-22 | 19: Brake chopper output error 20: Warning output 21: Over voltage warning 22: Over-current stall prevention warning 23: Over-voltage stall prevention warning 24: Operation mode indication (Pr.00-15≠0) 25: Forward command 26: Reverse command 27: Output when current >= Pr.02-33 28: Output when current < Pr.02-33 29: Output when frequency >= Pr.02-34 30: Output when frequency < Pr.02-34 31-32: Reserved 33: Zero speed (actual output frequency) 34: Zero speed with Stop (actual output frequency) 35: Error output selection 1 (Pr.06-22) 36: Error output selection 2 (Pr.06-23) 37: Error output selection 3 (Pr.06-24) 38: Error output selection 4 (Pr.06-25) 39: Reserved 40: Speed attained (including zero speed) 41: Reserved |
|----------------------------|--|

3.3.2.2 Step 2

Motor tuning

- Setting the parameters according to the motor type (PM or IM)

IM motor

- Inputting the nameplate information on the motor into Pr.01-00~01-02 and Pr.05-01~05-04

| | |
|--------------------------------------|----------------|
| Pr.01-00 Maximum Output Frequency | 10.00~120.00Hz |
|--------------------------------------|----------------|

| | |
|--|---------------|
| Pr.01-01 1st Output Frequency Setting 1 (base frequency/motor rated frequency) | 0.00~120.00Hz |
|--|---------------|

| | |
|--|--|
| Pr.01-02 1st Output Voltage Setting 1 (base voltage/motor rated voltage) | 230V: 0.1V~255.0V 460V: 0.1V~510.0V |
|--|--|

- Motor Auto-tuning: When the Source of the Operation Command is set to digital keypad (Pr.00-15=2, refer to step 1) and setting Pr.05-00=2

| | |
|-------------------------------|--|
| Pr.05-00 Motor Auto tuning | 0: No function 1: Rolling test (Rs, Rr, Lm, Lx, no-load current) 2: Static Test |
|-------------------------------|--|

NOTE 1: It doesn't need to release the brake in this auto tuning operation. Please make sure that the electromagnetic valve is ON when it is used between the AC motor drive and motor. When Pr.05-00 is set to 2, no-load current of motor must be entered into Pr.05-05. The warning message "Auto tuning" will be displayed on the digital keypad during tuning until it is finished. Then, the measure result will be saved into Pr.05-06~Pr.05-09.

NOTE 2: It needs to finish motor auto tuning before measuring the angle between magnetic field and PG origin.

PM motor

- Control method: Please set Pr.00-09 to 8.

| | |
|----------------------------|---|
| Pr.00-09 Control Method | 0: V/f Control 1: V/f Control + Encoder (VFPG) 2: Sensorless vector control (SVC) 3: FOC vector control + Encoder (FOCPG) 4: Torque control + Encoder (TQCPG) 8: FOC PM control (FOCPM) |
|----------------------------|---|

- Inputting the nameplate information on the motor into Pr.01-00~01-02 and Pr.08-01~08-04

| | |
|--------------------------------------|----------------|
| Pr.01-00 Maximum Output Frequency | 10.00~120.00Hz |
|--------------------------------------|----------------|

| | |
|--|---------------|
| Pr.01-01 1st Output Frequency Setting 1 (base frequency/motor rated frequency) | 0.00~120.00Hz |
|--|---------------|

| | |
|--|--|
| Pr.01-02 1st Output Voltage Setting 1 (base voltage/motor rated voltage) | 230V: 0.1V~255.0V 460V: 0.1V~510.0V |
|--|--|

- Motor Auto-tuning: When the Source of the Operation Command is set to digital keypad (Pr.00-15=2, refer to step 1) and setting Pr.08-00=2

| | |
|-------------------------------|--|
| Pr.08-00 Motor Auto tuning | 0: No function 1: Only for the unloaded motor, auto measure the Angle between magnetic field and PG origin (08-09) 2: For PM motor parameters 3: Auto measure the Angle between magnetic field and PG origin (08-09) |
|-------------------------------|--|

NOTE 1: It doesn't need to release the brake in this auto tuning operation. Please make sure that the electromagnetic valve is ON when it is used between the AC motor drive and motor. The warning message "Auto tuning" will be displayed on the digital keypad during tuning until it is finished. Then, the measure result will be saved into Pr.08-05 and Pr.08-07. (Pr.08-05 is Rs of Motor and Pr.08-07 is Lq of Motor)

NOTE 2: The auto tuning of the IM motor can also be dynamic measure.

NOTE 3: It doesn't need to release the brake for the static measure.

3.3.2.3 Step 3

Encoder settings

■ Selection of speed feedback cards

Please refer to appendix B.8 for details. Delta provides 4 PG cards for user to select by their application, including EMVL-PGABL, EMVL-PGABO, EMVL-PGH01 and EMVL-PGS01.

PM motor

It can execute "RUN" by keypad or digital terminals:

- Using digital keypad: setting Pr.08-00=1 and press RUN to execute "auto measure the angle between magnetic field and PG origin".

Please notice that if the electromagnetic valve and brake is not controlled by the AC motor drive, please release it by manual.

- Using external terminals: Pr.00-14=3, Pr.00-15=1 (refer to step 1). Please use "inspection" function to execute "auto measure the angle between magnetic field and PG origin".

For the IM motor, it doesn't need to detect the position of the electromagnetic pole, this function (auto measure the Angle between magnetic field and PG origin) doesn't have to be executed.

Measure the angle between magnetic field and PG origin: Pr.08-00=1 or 3

| | |
|-------------------------------|---|
| Pr.08-00 Motor Auto tuning | 0: No function 1: Only for the unloaded motor, auto measure the Angle between magnetic field and PG origin (08-09) 2: For PM motor parameters 3: Auto measure the Angle between magnetic field and PG origin (08-09) |
|-------------------------------|---|

NOTE 1: It is recommended to set Pr.08-00 to 1 (unloaded motor) for the accurate calculation. If it needs to execute this function with loaded motor, please balance the carriage before execution.

NOTE 2: if it doesn't allow balancing the carriage in the measured environment, it can set Pr.08-00=3 for executing this function. It can execute this function with loaded motor by setting Pr.08-00=3. It will have a difference of 15~30° by the different encoder type.

NOTE3: It will display the warning message "Auto tuning" on the digital keypad during measuring until the measure is finished. Then, the result will be saved into Pr.08-09.

NOTE 4: It will display "Auto Tuning Err" on the keypad when stopping by the fault of the AC motor drive or human factor to show the failed detection. At this moment, please check the connections of the wirings of the AC motor drives. If it displays "PG Fbk Error" on the digital keypad, please change the setting of Pr.10-02 (if it is set to 1, please change it to 2). If it displays "PG Fbk Loss" on the digital keypad, please check the feedback of Z-phase pulse.

| | |
|----------------------------|--|
| Pr.10-00 PG signal type | 0: No function 1: ABZ 2: ABZ+Hall 3: SIN/COS+Sinusoidal 4: SIN/COS+Endat 5: SIN/COS 6: SIN/COS + Hiperface |
|----------------------------|--|

■ Encoder settings: Pr.10-01~Pr.10-02

Detection for the magnetic pole position of motor

The detection method will be different by the setting of Pr.10-00 PG Signal Type.

The detection methods: (refer to Pr.10-00)

- Setting 1 or 5: The AC motor drive will output short circuit to detect the position of the electromagnetic pole. At this moment, the motor will generate a little noise.
- Setting 2: The AC motor drive will detect the position of the electromagnetic pole by the UVW signal of PG.
- Setting 3: The AC motor drive will detect the position of the electromagnetic pole by the sine signal of PG.
- Setting 4: The AC motor drive will detect the position of the electromagnetic pole by the communication signal of PG.

Reference table for tuning

| Setting of PG signal type | PG signal type | Applicable PG card | Pr.08-00=1 | Pr.08-00=3 |
|---------------------------|---------------------|--------------------|----------------|-----------------|
| 10-00=1 | A, B, Z | EMVL-PGABO/ABL | Motor will run | Motor will run |
| 10-00=2 | A, B, Z+U, V, W | EMVL-PGABL | Motor will run | Motor won't run |
| 10-00=3 | SIN/COS+Sinusoidal | EMVL-PGH01/02 | Motor will run | Motor will run |
| 10-00=4 | SIN/COS+Endat | EMVL-PGS01 | Motor will run | Motor won't run |
| 10-00=5 | SIN/COS | EMVL-PGH01/02 | Motor will run | Motor will run |
| 10-00=6 | SIN/COS + Hiperface | EMVL-PGS01 | Motor will run | Motor won't run |

| | |
|---------------------------|---------|
| Pr.10-01 Encoder Pulse | 1~25000 |
|---------------------------|---------|

| | |
|--|---|
| Pr.10-02 Encoder Input Type Setting | 0: Disable 1: Phase A leads in a forward run command and phase B leads in a reverse run command 2: Phase B leads in a forward run command and phase A leads in a reverse run command 3: Phase A is a pulse input and phase B is a direction input. (low input=reverse direction, high input=forward direction) 4: Phase A is a pulse input and phase B is a direction input. (low input=forward direction, high input=reverse direction) 5: Single-phase input |
|--|---|

3.3.2.4 Step 4

Multi-step speed settings

- Please confirm the total speed steps (high speed, middle speed, low speed, creep, inspection and level auto-learning)
- Please make sure that the setting of step speeds and the action of the corresponding terminals of multi-function input commands are correct.
- Setting multi-step speeds in Pr.04-00 to Pr.04-15

| | | |
|----------------------------------|---------------------------|---------------|
| Settings of Pr.04-00 to Pr.04-15 | Zero Step Speed Frequency | 0.00~120.00Hz |
| | 1st Step Speed Frequency | 0.00~120.00Hz |
| | 2nd Step Speed Frequency | 0.00~120.00Hz |
| | 3rd Step Speed Frequency | 0.00~120.00Hz |
| | 4th Step Speed Frequency | 0.00~120.00Hz |
| | 5th Step Speed Frequency | 0.00~120.00Hz |
| | 6th Step Speed Frequency | 0.00~120.00Hz |
| | 7th Step Speed Frequency | 0.00~120.00Hz |
| | 8th Step Speed Frequency | 0.00~120.00Hz |
| | 9th Step Speed Frequency | 0.00~120.00Hz |
| | 10th Step Speed Frequency | 0.00~120.00Hz |
| | 11th Step Speed Frequency | 0.00~120.00Hz |
| | 12th Step Speed Frequency | 0.00~120.00Hz |
| | 13th Step Speed Frequency | 0.00~120.00Hz |
| | 14th Step Speed Frequency | 0.00~120.00Hz |
| 15th Step Speed Frequency | 0.00~120.00Hz | |

NOTE: It is recommended to set the max. operating frequency to the half of max. operating frequency before confirming the setting of each step speed and the action of the corresponding terminals of multi-function input commands.

- Setting the acceleration/deceleration with Pr.01-23 and the setting 08 (the 1st, 2nd acceleration/deceleration time selection) and 09 (the 3rd, 4th acceleration/deceleration time selection) of multi-function input command Pr.02-01~02-08.
- Settings of acceleration/deceleration time: Pr.01-12~Pr.01-19

| | | |
|----------------------------------|--------------|-----------------|
| Settings of Pr.01-12 to Pr.01-19 | Accel Time 1 | 0.00~600.00 sec |
| | Decel Time 1 | 0.00~600.00 sec |
| | Accel Time 2 | 0.00~600.00 sec |
| | Decel Time 2 | 0.00~600.00 sec |
| | Accel Time 3 | 0.00~600.00 sec |
| | Decel Time 3 | 0.00~600.00 sec |
| | Accel Time 4 | 0.00~600.00 sec |
| | Decel Time 4 | 0.00~600.00 sec |

NOTE: it is recommended to set the acceleration/deceleration time to the small value in the trial run and execute smooth test after all the actions are correct.

- Settings of S curve: Pr.01-24~Pr.01-30

| | | |
|----------------------------------|--|--|
| Settings of Pr.01-24 to Pr.01-30 | S-curve for Acceleration Departure Time S1 | 0.00~25.00 sec |
| | S-curve for Acceleration Arrival Time S2 | 0.00~25.00 sec |
| | S-curve for Deceleration Departure Time S3 | 0.00~25.00 sec |
| | S-curve for Deceleration Arrival Time S4 | 0.00~25.00 sec |
| | Mode Selection when Frequency < Fmin | 0: Output waiting 1: Zero-speed operation 2: Fmin (4th output frequency setting) |
| | Switch Frequency for S3/S4 Changes to S5 | 0.00~120.00Hz |
| | S-curve for Deceleration Arrival Time S5 | 0.00~25.00 sec |

NOTE: it is recommended to set the S curve time to 0 in trial run and execute smooth test after all the actions are correct.

3.3.2.5 Step 5

Trial run

This step is used to trial run after finishing the settings of Step 1 to Step 4 to check if it runs normally after executing the inspection with the loaded motor. At the same time, please also check if the operations of multi-function output terminals is normal, such as the action of the brake release and electromagnetic valve correspond to the host controller.

It needs to check the switch between each step speed, current value, the noise in the carriage and noise source during operation.

3.3.2.6 Step 6

Elevator tuning

- Setting Pr. 11-00 to bit 0=1

| | |
|----------------------------|---|
| Pr.11-00 System control | Bit 0=0: disable Bit 0=1: ASR Auto tuning, PDFF enable Bit 7=1: When position control is enabled, it doesn't need to set Pr.07-02 (DC Brake Current Level) Bit 15=0: when power is applied, it will detect the position of magnetic field again Bit 15=1: when power is applied, it will start from the magnetic field position of previous power failure |
|----------------------------|---|

- Smooth test for general operation

- Adjust the setting of Pr.11-05

| | |
|----------------------------|--------|
| Pr.11-05 Inertial Ratio | 1~300% |
|----------------------------|--------|

- Adjust the settings of Pr.11-06 to Pr.11-08

| | | |
|----------------------------------|----------------------|--------|
| Settings of Pr.11-06 to Pr.11-08 | Zero-speed Bandwidth | 0~40Hz |
| | Low-speed Bandwidth | 0~40Hz |
| | High-speed Bandwidth | 0~40Hz |

- Start-up adjustment (only for PM motor)

- Control by the zero-speed position

Setting Pr.11-00, 10-19, 10-22, 10-23, 02-29 and 10-24

| | |
|----------------------------|---|
| Pr.11-00 System control | Bit 0=0: disable Bit 0=1: ASR Auto tuning, PDFF enable Bit 7=1: When position control is enabled, it doesn't need to set Pr.07-02 (DC Brake Current Level) Bit 15=0: when power is applied, it will detect the position of magnetic field again Bit 15=1: when power is applied, it will start from the magnetic field position of previous power failure |
|----------------------------|---|

| | |
|---------------------------------|-----------|
| Pr.10-19 Zero Speed Gain (P) | 0~655.00% |
|---------------------------------|-----------|

NOTE: refer to the explanations in Pr.02-32

| | |
|---|-----------------|
| Pr.10-22 Operation Time of Zero Speed | 0.000~65.535sec |
|---|-----------------|

| | |
|--|-----------------|
| Pr.10-23 Filter Time of Zero Speed | 0.000~65.535sec |
|--|-----------------|

| | |
|--|---|
| Pr.10-24 Time for Zero Speed Execution | 0: after the brake release set in Pr.02-29 1: after the brake signal input (Pr.02-01~02-08 is set to 42) |
|--|---|

| | |
|---|------------------|
| Pr.02-29 Brake Release Delay Time when Elevator Starts | 0.000~65.000 Sec |
|---|------------------|

NOTE: When Pr.10-24=0, the zero speed control needs to be used with Pr.02-29. (refer to the explanations in Pr.02-32)

■ Function of the preload input

Please connect the signal of the preload signal to the external terminal of the AC motor drive (AU1) and setting Pr.03-00=11, 07-19=1, 03-03, 03-06 and 03-09.

| | |
|----------------------------------|---|
| Pr.03-00 Analog Input 1 (AU1) | 0: No function 1: Frequency command (torque limit under TQR control mode) 2: Torque command (torque limit under speed mode) 3: Torque compensation command 4-5: Reserved 6: P.T.C. thermistor input value 7: Positive torque limit 8: Negative torque limit 9: Regenerative torque limit 10: Positive/negative torque limit 11: Preload Input |
|----------------------------------|---|

| | |
|-------------------------------------|--|
| Pr.07-19 Source of Torque Offset | 0: Disable 1: Analog input (Pr.03-00) 2: Torque offset setting (Pr.07-20) 3: Control by external terminal (by Pr.07-21 to Pr.07-23) |
|-------------------------------------|--|

| | |
|--|---------------|
| Pr.03-03 Analog Input Bias 1 (AUI1) | -100.0~100.0% |
|--|---------------|

| | |
|--|--|
| Pr.03-06 Positive/negative Bias Mode (AUI1) | 0: Zero bias 1: Lower than bias=bias 2: Greater than bias=bias 3: The absolute value of the bias voltage while serving as the center 4: Serve bias as the center |
|--|--|

| | |
|--|---------------|
| Pr.03-09 Analog Input Gain 1 (AUI1) | -500.0~500.0% |
|--|---------------|

NOTE: Pr.03-03, 03-06 and 03-09 are used to adjust the analog input signal.

- 07-19: Source of torque offset
03-00~02: Analog input selections (AUI1/ACI/AUI2)
03-03~05: Analog input bias (AUI1/ACI/AUI2)
03-06~08: AUI1/ACI/AUI2 bias mode

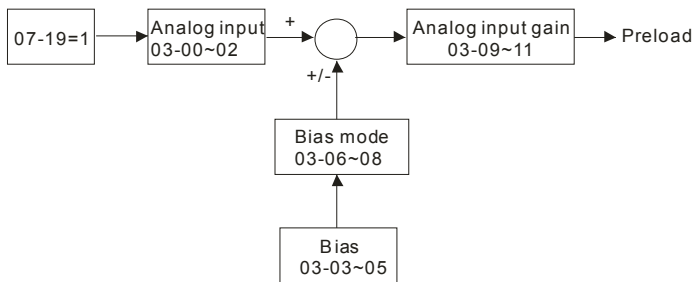

4. Setting of drive stop

Adjusting Pr.01-29, Pr.01-30 and Pr.11-06

| | |
|---|---------------|
| Pr.01-29 Switch Frequency for S3/S4 Changes to S5 | 0.00~120.00Hz |
|---|---------------|

| | |
|--|----------------|
| Pr.01-30 S-curve for Deceleration Arrival Time S5 | 0.00~25.00 sec |
|--|----------------|

| | |
|----------------------------------|--------|
| Pr.11-06 Zero-speed Bandwidth | 0~40Hz |
|----------------------------------|--------|

Chapter 4 Parameters

The VFD-VL parameters are divided into 14 groups by property for easy setting. In most applications, the user can finish all parameter settings before start-up without the need for re-adjustment during operation.

The 14 groups are as follows:

- Group 0: System Parameters
- Group 1: Basic Parameters
- Group 2: Digital Input/Output Parameters
- Group 3: Analog Input/Output Parameters
- Group 4: Multi-Step Speed Parameters
- Group 5: IM Motor Parameters
- Group 6: Protection Parameters
- Group 7: Special Parameters
- Group 8: PM Motor Parameters
- Group 9: Communication Parameters
- Group 10: Speed Feedback Control Parameters
- Group 11: Advanced Parameters
- Group 12: User-defined Parameters
- Group 13: View User-defined Parameters

4.1 Summary of Parameter Settings

↗: The parameter can be set during operation.

Group 0 System Parameters

| Pr. | Explanation | Settings | Factory Setting | VF | VFP | SVC | FOCPG | TQCPG | FOCPM |
|--------|---|---|-----------------|----|-----|-----|-------|-------|-------|
| 00-00 | Identity Code of the AC motor drive | Read-only | # | ○ | ○ | ○ | ○ | ○ | ○ |
| 00-01 | Rated Current Display of the AC motor drive | Read-only | # | ○ | ○ | ○ | ○ | ○ | ○ |
| 00-02 | Parameter Reset | 0: No function 1: Read only 8: Keypad lock 9: All parameters are reset to factory settings (50Hz, 220V/380V) 10: All parameters are reset to factory settings (60Hz, 220V/440V) | 0 | ○ | ○ | ○ | ○ | ○ | ○ |
| ↗00-03 | Start-up Display Selection | 0: Display the frequency command value (LED F) 1: Display the actual output frequency (LED H) 2: DC BUS voltage 3: Display the output current (A) 4: Output voltage 5: Multifunction display, see Pr.00-04 | 0 | ○ | ○ | ○ | ○ | ○ | ○ |
| ↗00-04 | Content of Multi Function Display | 0: Display output current (A) 1: Reserved 2: Display output frequency (H) 3: Display DC-BUS voltage (U) 4: Display output voltage (E) 5: Output power factor angle (n) 6: Display output power kW(P) 7: Display actual motor speed in rpm(r) 8: Display estimate output torque kg-m (t) 9: Display PG position (G) 10: Reserved 11: Display AUI1 % (1.) 12: Display AC1 % (2.) 13: Display AUI2 % (3.) 14: Display the temperature of heat sink (C) 15: Display the temperature of IGBT C (T.) 16: The status of digital input ON/OFF (i) 17: The status of digital output ON/OFF (o) 18: Multi-step speed (S) 19: The corresponding CPU pin status of digital input (i.) 20: The corresponding CPU pin status of digital output (o.) 21-23: Reserved 24: Output AC voltage when malfunction (B) 25: Output DC voltage when malfunction (B.) 26: Output frequency when malfunction (h) 27: Output current when malfunction (4) 28: Output frequency command when malfunction (h.) | 0 | ○ | ○ | ○ | ○ | ○ | ○ |
| ↗00-05 | User-Defined Coefficient K | Digit 4: decimal point number (0 to 3) Digit 0-3: 40 to 9999 | 0 | ○ | ○ | ○ | ○ | ○ | ○ |
| 00-06 | Software Version | Read-only | ## | ○ | ○ | ○ | ○ | ○ | ○ |
| ↗00-07 | Password Input | 1 to 9998 and 10000 to 65535 0 to 2: times of wrong password | 0 | ○ | ○ | ○ | ○ | ○ | ○ |
| ↗00-08 | Password Set | 1 to 9998 and 10000 to 65535 0: No password set or successful input in Pr.00-07 1: Password has been set | 0 | ○ | ○ | ○ | ○ | ○ | ○ |
| 00-09 | Control Method | 0: V/f Control 1: V/f Control + Encoder (VFP) 2: Sensorless vector control (SVC) 3: FOC vector control + Encoder (FOCPG) 4: Torque control + Encoder (TQCPG) 8: FOC PM control (FOCPM) | 0 | ○ | ○ | ○ | ○ | ○ | ○ |
| 00-10 | Reserved | | | | | | | | |
| 00-11 | Reserved | | | | | | | | |
| ↗00-12 | Carrier Frequency | 2~15KHz | 12 | ○ | ○ | ○ | ○ | ○ | ○ |

| Pr. | Explanation | Settings | Factory Setting | VF | VFPG | SVC | FOCPG | TCCPG | FOCPM |
|--------|--|---|-----------------|-----------------------|-----------------------|-----------------------|-----------------------|-----------------------|-----------------------|
| ↗00-13 | Auto Voltage Regulation (AVR) Function | 0: Enable AVR 1: Disable AVR 2: Disable AVR when deceleration stop | 0 | <input type="radio"/> | <input type="radio"/> | <input type="radio"/> | <input type="radio"/> | <input type="radio"/> | <input type="radio"/> |
| ↗00-14 | Source of the Master Frequency Command | 1: RS-485 serial communication or digital keypad (KPV-L-CC01) 2: External analog input (Pr. 03-00) 3: Digital terminals input (Pr. 04-00-04-15) | 1 | <input type="radio"/> | <input type="radio"/> | <input type="radio"/> | <input type="radio"/> | <input type="radio"/> | <input type="radio"/> |
| ↗00-15 | Source of the Operation Command | 1: External terminals 2: RS-485 serial communication or digital keypad (KPV-L-CC01) | 1 | <input type="radio"/> | <input type="radio"/> | <input type="radio"/> | <input type="radio"/> | <input type="radio"/> | <input type="radio"/> |

Group 1 Basic Parameters

| Pr. | Explanation | Settings | Factory Setting | VF | VFG | SVC | FOCPG | FOCFM |
|-------|--|--|-----------------|----|-----|-----|-------|-------|
| 01-00 | Maximum Output Frequency | 10.00~120.00Hz | 60.00/ 50.00 | ○ | ○ | ○ | ○ | ○ |
| 01-01 | 1st Output Frequency Setting 1 | 0.00~120.00Hz | 60.00/ 50.00 | ○ | ○ | ○ | ○ | ○ |
| 01-02 | 1st Output Voltage Setting 1 | 230V: 0.1V~255.0V 460V: 0.1V~510.0V | 220.0 440.0 | ○ | ○ | ○ | ○ | ○ |
| 01-03 | 2nd Output Frequency Setting 1 | 0.00~120.00Hz | 0.50 | ○ | ○ | | | |
| 01-04 | 2nd Output Voltage Setting 1 | 230V: 0.1V~255.0V 460V: 0.1V~510.0V | 5.0 10.0 | ○ | ○ | | | |
| 01-05 | 3rd Output Frequency Setting 1 | 0.00~120.00Hz | 0.50 | ○ | ○ | | | |
| 01-06 | 3rd Output Voltage Setting 1 | 230V: 0.1V~255.0V 460V: 0.1V~510.0V | 5.0 10.0 | ○ | ○ | | | |
| 01-07 | 4th Output Frequency Setting 1 | 0.00~120.00Hz | 0.00 | ○ | ○ | ○ | ○ | ○ |
| 01-08 | 4th Output Voltage Setting 1 | 230V: 0.1V~255.0V 460V: 0.1V~510.0V | 0.0 0.0 | ○ | ○ | | | |
| 01-09 | Start Frequency | 0.00~120.00Hz | 0.50 | ○ | ○ | ○ | ○ | ○ |
| 01-10 | Output Frequency Upper Limit | 0.00~120.00Hz | 120.00 | ○ | ○ | ○ | ○ | ○ |
| 01-11 | Output Frequency Lower Limit | 0.00~120.00Hz | 0.00 | ○ | ○ | ○ | ○ | ○ |
| 01-12 | Accel Time 1 | 0.00~600.00 sec | 3.00 | ○ | ○ | ○ | ○ | ○ |
| 01-13 | Decel Time 1 | 0.00~600.00 sec | 2.00 | ○ | ○ | ○ | ○ | ○ |
| 01-14 | Accel Time 2 | 0.00~600.00 sec | 3.00 | ○ | ○ | ○ | ○ | ○ |
| 01-15 | Decel Time 2 | 0.00~600.00 sec | 2.00 | ○ | ○ | ○ | ○ | ○ |
| 01-16 | Accel Time 3 | 0.00~600.00 sec | 3.00 | ○ | ○ | ○ | ○ | ○ |
| 01-17 | Decel Time 3 | 0.00~600.00 sec | 2.00 | ○ | ○ | ○ | ○ | ○ |
| 01-18 | Accel Time 4 | 0.00~600.00 sec | 3.00 | ○ | ○ | ○ | ○ | ○ |
| 01-19 | Decel Time 4 | 0.00~600.00 sec | 2.00 | ○ | ○ | ○ | ○ | ○ |
| 01-20 | JOG Acceleration Time | 0.00~600.00 sec | 1.00 | ○ | ○ | ○ | ○ | ○ |
| 01-21 | JOG Deceleration Time | 0.00~600.00 sec | 1.00 | ○ | ○ | ○ | ○ | ○ |
| 01-22 | JOG Frequency | 0.00~120.00Hz | 6.00 | ○ | ○ | ○ | ○ | ○ |
| 01-23 | Switch Frequency between 1st/4th Accel/decel | 0.00~120.00Hz | 0.00 | ○ | ○ | ○ | ○ | ○ |
| 01-24 | S-curve for Acceleration Departure Time S1 | 0.00~25.00 sec | 1.00 | ○ | ○ | ○ | ○ | ○ |
| 01-25 | S-curve for Acceleration Arrival Time S2 | 0.00~25.00 sec | 1.00 | ○ | ○ | ○ | ○ | ○ |
| 01-26 | S-curve for Deceleration Departure Time S3 | 0.00~25.00 sec | 1.00 | ○ | ○ | ○ | ○ | ○ |
| 01-27 | S-curve for Deceleration Arrival Time S4 | 0.00~25.00 sec | 1.00 | ○ | ○ | ○ | ○ | ○ |
| 01-28 | Mode Selection when Frequency < Fmin | 0: Output waiting 1: Zero-speed operation 2: Fmin (4th output frequency setting) | 0 | ○ | ○ | ○ | | |
| 01-29 | Switch Frequency for S3/S4 Changes to S5 | 0.00~120.00Hz | 0.00 | ○ | ○ | ○ | ○ | ○ |
| 01-30 | S-curve for Deceleration Arrival Time S5 | 0.00~25.00 sec | 1.00 | ○ | ○ | ○ | ○ | ○ |
| 01-31 | Deceleration Time when Operating without RUN Command | 0.00~60.00 sec | 2.00 | ○ | ○ | ○ | ○ | ○ |

Group 2 Digital Input/Output Parameters

| Pr. | Explanation | Settings | Factory Setting | VF | VFG | SVC | FOCPG | TCOPG | FOCPM |
|--------|---|--|-----------------|--------------------------|--------------------------|--------------------------|--------------------------|--------------------------|--------------------------|
| 02-00 | 2-wire/3-wire Operation Control | 0: FWD/STOP, REV/STOP 1: FWD/STOP, REV/STOP (Line Start Lockout) 2: RUN/STOP, REV/FWD 3: RUN/STOP, REV/FWD (Line Start Lockout) 4: 3-wire 5: 3-wire (Line Start Lockout) | 0 | <input type="checkbox"/> | <input type="checkbox"/> | <input type="checkbox"/> | <input type="checkbox"/> | <input type="checkbox"/> | <input type="checkbox"/> |
| 02-01 | Multi-Function Input Command 1 (MI1) (it is Stop terminal for 3-wire operation) | 0: no function 1: multi-step speed command 1 2: multi-step speed command 2 | 1 | <input type="checkbox"/> | <input type="checkbox"/> | <input type="checkbox"/> | <input type="checkbox"/> | <input type="checkbox"/> | <input type="checkbox"/> |
| 02-02 | Multi-Function Input Command 2 (MI2) | 3: multi-step speed command 3 4: multi-step speed command 4 | 2 | <input type="checkbox"/> | <input type="checkbox"/> | <input type="checkbox"/> | <input type="checkbox"/> | <input type="checkbox"/> | <input type="checkbox"/> |
| 02-03 | Multi-Function Input Command 3 (MI3) | 5: Reset 6: JOG command | 3 | <input type="checkbox"/> | <input type="checkbox"/> | <input type="checkbox"/> | <input type="checkbox"/> | <input type="checkbox"/> | <input type="checkbox"/> |
| 02-04 | Multi-Function Input Command 4 (MI4) | 7: acceleration/deceleration speed inhibit 8: the 1st, 2nd acceleration/deceleration time selection | 4 | <input type="checkbox"/> | <input type="checkbox"/> | <input type="checkbox"/> | <input type="checkbox"/> | <input type="checkbox"/> | <input type="checkbox"/> |
| 02-05 | Multi-Function Input Command 5 (MI5) | 9: the 3rd, 4th acceleration/deceleration time selection 10: EF input (07-28) 11: Reserved | 0 | <input type="checkbox"/> | <input type="checkbox"/> | <input type="checkbox"/> | <input type="checkbox"/> | <input type="checkbox"/> | <input type="checkbox"/> |
| 02-06 | Multi-Function Input Command 6 (MI6) | 12: Stop output 13: Disable auto accel./decel. function 14: Reserved 15: operation speed command form AUI1 16: operation speed command form ACI | 0 | <input type="checkbox"/> | <input type="checkbox"/> | <input type="checkbox"/> | <input type="checkbox"/> | <input type="checkbox"/> | <input type="checkbox"/> |
| 02-07 | Multi-Function Input Command 7 (MI7) | 17: operation speed command form AUI2 | 0 | <input type="checkbox"/> | <input type="checkbox"/> | <input type="checkbox"/> | <input type="checkbox"/> | <input type="checkbox"/> | <input type="checkbox"/> |
| 02-08 | Multi-Function Input Command 8 (MI8) (specific terminal for Enable) | 18: Emergency Stop (07-28) 19-23: Reserved 24: FWD JOG command 25: REV JOG command 26: Reserved 27: ASR1/ASR2 selection 28: Emergency stop (EF1) (Motor coasts to stop) 29-30: Reserved 31: High torque bias (by Pr.07-21) 32: Middle torque bias (by Pr.07-22) 33: Low torque bias (by Pr.07-23) 34-37: Reserved 38: Disable write EEPROM function 39: Torque command direction 40: Enable drive function 41: Reserved 42: Mechanical brake 43: EPS function | 0 | <input type="checkbox"/> | <input type="checkbox"/> | <input type="checkbox"/> | <input type="checkbox"/> | <input type="checkbox"/> | <input type="checkbox"/> |
| ↗02-09 | Digital Input Response Time | 0.001~ 30.000 sec | 0.005 | <input type="checkbox"/> | <input type="checkbox"/> | <input type="checkbox"/> | <input type="checkbox"/> | <input type="checkbox"/> | <input type="checkbox"/> |
| ↗02-10 | Digital Input Operation Direction | 0 ~ 65535 | 0 | <input type="checkbox"/> | <input type="checkbox"/> | <input type="checkbox"/> | <input type="checkbox"/> | <input type="checkbox"/> | <input type="checkbox"/> |
| ↗02-11 | Multi-function Output 1 RA, RB, RC(Relay1) | 0: No function 1: Operation indication | 11 | <input type="checkbox"/> | <input type="checkbox"/> | <input type="checkbox"/> | <input type="checkbox"/> | <input type="checkbox"/> | <input type="checkbox"/> |
| ↗02-12 | Multi-function Output 2 MRA, MRC (Relay2) | 2: Operation speed attained 3: Desired frequency attained 1 (Pr.02-25) 4: Desired frequency attained 2 (Pr.02-27) | 1 | <input type="checkbox"/> | <input type="checkbox"/> | <input type="checkbox"/> | <input type="checkbox"/> | <input type="checkbox"/> | <input type="checkbox"/> |
| ↗02-13 | Multi-function Output 3 (MO1) | 5: Zero speed (frequency command) 6: Zero speed with stop (frequency command) 7: Over torque (OT1) (Pr.06-05~06-07) 8: Over torque (OT2) (Pr.06-08~06-10) | 0 | <input type="checkbox"/> | <input type="checkbox"/> | <input type="checkbox"/> | <input type="checkbox"/> | <input type="checkbox"/> | <input type="checkbox"/> |
| ↗02-14 | Multi-function Output 4 (MO2) | 9: Drive ready 10: User-defined Low-voltage Detection (LV) 11: Malfunction indication | 0 | <input type="checkbox"/> | <input type="checkbox"/> | <input type="checkbox"/> | <input type="checkbox"/> | <input type="checkbox"/> | <input type="checkbox"/> |
| ↗02-15 | Multi-function Output 5 (MO3) | 12: Mechanical brake release (Pr.02-29, Pr.02-30) 13: Overheat (Pr.06-14) | 0 | <input type="checkbox"/> | <input type="checkbox"/> | <input type="checkbox"/> | <input type="checkbox"/> | <input type="checkbox"/> | <input type="checkbox"/> |

| Pr. | Explanation | Settings | Factory Setting | VF | V/FG | SVC | Fc/FG | TOCPG | FOCPM |
|---|--|--|--------------------------|--------------------------|--------------------------|--------------------------|--------------------------|--------------------------|--------------------------|
| ∞02-16 | Multi-function Output 6 (MO4) | 14: Brake chopper signal | 0 | <input type="checkbox"/> | <input type="checkbox"/> | <input type="checkbox"/> | <input type="checkbox"/> | <input type="checkbox"/> | <input type="checkbox"/> |
| | | 15: Motor-controlled magnetic contactor output | 0 | <input type="checkbox"/> | <input type="checkbox"/> | <input type="checkbox"/> | <input type="checkbox"/> | <input type="checkbox"/> | <input type="checkbox"/> |
| | | 16: Slip error (oSL) | | <input type="checkbox"/> | <input type="checkbox"/> | <input type="checkbox"/> | <input type="checkbox"/> | <input type="checkbox"/> | <input type="checkbox"/> |
| ∞02-17 | Multi-function Output 7 (MO5) | 17: Malfunction indication 1 | 0 | <input type="checkbox"/> | <input type="checkbox"/> | <input type="checkbox"/> | <input type="checkbox"/> | <input type="checkbox"/> | <input type="checkbox"/> |
| | | 18: Reserved | | <input type="checkbox"/> | <input type="checkbox"/> | <input type="checkbox"/> | <input type="checkbox"/> | <input type="checkbox"/> | <input type="checkbox"/> |
| | | 19: Brake chopper output error | | <input type="checkbox"/> | <input type="checkbox"/> | <input type="checkbox"/> | <input type="checkbox"/> | <input type="checkbox"/> | <input type="checkbox"/> |
| | | 20: Warning output | | <input type="checkbox"/> | <input type="checkbox"/> | <input type="checkbox"/> | <input type="checkbox"/> | <input type="checkbox"/> | <input type="checkbox"/> |
| ∞02-18 | Multi-function Output 8 (MO6) | 21: Over voltage warning | 0 | <input type="checkbox"/> | <input type="checkbox"/> | <input type="checkbox"/> | <input type="checkbox"/> | <input type="checkbox"/> | <input type="checkbox"/> |
| | | 22: Over-current stall prevention warning | | <input type="checkbox"/> | <input type="checkbox"/> | <input type="checkbox"/> | <input type="checkbox"/> | <input type="checkbox"/> | <input type="checkbox"/> |
| ∞02-19 | Multi-function Output 9 (MO7) | 23: Over-voltage stall prevention warning | 0 | <input type="checkbox"/> | <input type="checkbox"/> | <input type="checkbox"/> | <input type="checkbox"/> | <input type="checkbox"/> | <input type="checkbox"/> |
| | | 24: Operation mode indication (Pr.00-15≠0) | | <input type="checkbox"/> | <input type="checkbox"/> | <input type="checkbox"/> | <input type="checkbox"/> | <input type="checkbox"/> | <input type="checkbox"/> |
| ∞02-20 | Multi-function Output 10 (MO8) | 25: Forward command | 0 | <input type="checkbox"/> | <input type="checkbox"/> | <input type="checkbox"/> | <input type="checkbox"/> | <input type="checkbox"/> | <input type="checkbox"/> |
| | | 26: Reverse command | | <input type="checkbox"/> | <input type="checkbox"/> | <input type="checkbox"/> | <input type="checkbox"/> | <input type="checkbox"/> | <input type="checkbox"/> |
| ∞02-21 | Multi-function Output 11 (MO9) | 27: Output when current >= Pr.02-33 | 0 | <input type="checkbox"/> | <input type="checkbox"/> | <input type="checkbox"/> | <input type="checkbox"/> | <input type="checkbox"/> | <input type="checkbox"/> |
| | | 28: Output when current < Pr.02-33 | | <input type="checkbox"/> | <input type="checkbox"/> | <input type="checkbox"/> | <input type="checkbox"/> | <input type="checkbox"/> | <input type="checkbox"/> |
| ∞02-22 | Multi-function Output 12 (MO10) | 29: Output when frequency >= Pr.02-34 | 0 | <input type="checkbox"/> | <input type="checkbox"/> | <input type="checkbox"/> | <input type="checkbox"/> | <input type="checkbox"/> | <input type="checkbox"/> |
| | | 30: Output when frequency < Pr.02-34 | | <input type="checkbox"/> | <input type="checkbox"/> | <input type="checkbox"/> | <input type="checkbox"/> | <input type="checkbox"/> | |
| | | 31-32: Reserved | | <input type="checkbox"/> | <input type="checkbox"/> | <input type="checkbox"/> | <input type="checkbox"/> | <input type="checkbox"/> | |
| | | 33: Zero speed (actual output frequency) | | <input type="checkbox"/> | <input type="checkbox"/> | <input type="checkbox"/> | <input type="checkbox"/> | <input type="checkbox"/> | |
| | | 34: Zero speed with Stop (actual output frequency) | | <input type="checkbox"/> | <input type="checkbox"/> | <input type="checkbox"/> | <input type="checkbox"/> | <input type="checkbox"/> | |
| | | 35: Fault output option 1 (Pr.06-22) | | <input type="checkbox"/> | <input type="checkbox"/> | <input type="checkbox"/> | <input type="checkbox"/> | <input type="checkbox"/> | |
| | | 36: Fault output option 2 (Pr.06-23) | | <input type="checkbox"/> | <input type="checkbox"/> | <input type="checkbox"/> | <input type="checkbox"/> | <input type="checkbox"/> | |
| | | 37: Fault output option 3 (Pr.06-24) | | <input type="checkbox"/> | <input type="checkbox"/> | <input type="checkbox"/> | <input type="checkbox"/> | <input type="checkbox"/> | |
| | | 38: Fault output option 4 (Pr.06-25) | | <input type="checkbox"/> | <input type="checkbox"/> | <input type="checkbox"/> | <input type="checkbox"/> | <input type="checkbox"/> | |
| | | 39: Reserved | | <input type="checkbox"/> | <input type="checkbox"/> | <input type="checkbox"/> | <input type="checkbox"/> | <input type="checkbox"/> | |
| 40: Speed attained (including zero speed) | <input type="checkbox"/> | <input type="checkbox"/> | <input type="checkbox"/> | <input type="checkbox"/> | <input type="checkbox"/> | | | | |
| 41: Reserved | <input type="checkbox"/> | <input type="checkbox"/> | <input type="checkbox"/> | <input type="checkbox"/> | <input type="checkbox"/> | | | | |
| ∞02-23 | Multi-output Direction | 0 ~ 65535 | 0 | <input type="checkbox"/> | <input type="checkbox"/> | <input type="checkbox"/> | <input type="checkbox"/> | <input type="checkbox"/> | |
| 02-24 | Serial Start Signal Selection | 0: by FWD/REV 1: by Enable | 0 | <input type="checkbox"/> | <input type="checkbox"/> | <input type="checkbox"/> | <input type="checkbox"/> | <input type="checkbox"/> | |
| ∞02-25 | Desired Frequency Attained 1 | 0.00 ~ 120.00Hz | 60.00/ 50.00 | <input type="checkbox"/> | <input type="checkbox"/> | <input type="checkbox"/> | <input type="checkbox"/> | <input type="checkbox"/> | |
| ∞02-26 | The Width of the Desired Frequency Attained 1 | 0.00 ~ 120.00Hz | 2.00 | <input type="checkbox"/> | <input type="checkbox"/> | <input type="checkbox"/> | <input type="checkbox"/> | <input type="checkbox"/> | |
| ∞02-27 | Desired Frequency Attained 2 | 0.00 ~ 120.00Hz | 60.00/ 50.00 | <input type="checkbox"/> | <input type="checkbox"/> | <input type="checkbox"/> | <input type="checkbox"/> | <input type="checkbox"/> | |
| ∞02-28 | The Width of the Desired Frequency Attained 2 | 0.00 ~ 120.00Hz | 2.00 | <input type="checkbox"/> | <input type="checkbox"/> | <input type="checkbox"/> | <input type="checkbox"/> | <input type="checkbox"/> | |
| 02-29 | Brake Release Delay Time when Elevator Starts | 0.000~65.000 Sec | 0.250 | <input type="checkbox"/> | <input type="checkbox"/> | <input type="checkbox"/> | <input type="checkbox"/> | <input type="checkbox"/> | |
| 02-30 | Brake Engage Delay Time when Elevator Stops | 0.000~65.000 Sec | 0.250 | <input type="checkbox"/> | <input type="checkbox"/> | <input type="checkbox"/> | <input type="checkbox"/> | <input type="checkbox"/> | |
| ∞02-31 | Turn On Delay of Magnetic Contactor between Drive and Motor | 0.000~65.000 Sec | 0.200 | <input type="checkbox"/> | <input type="checkbox"/> | <input type="checkbox"/> | <input type="checkbox"/> | <input type="checkbox"/> | |
| ∞02-32 | Turn Off Delay of Magnetic Contactor between Drive and Motor | 0.000~65.000 Sec | 0.200 | <input type="checkbox"/> | <input type="checkbox"/> | <input type="checkbox"/> | <input type="checkbox"/> | <input type="checkbox"/> | |
| ∞02-33 | Output Current Level Setting for External Terminals | 0~100% | 0 | <input type="checkbox"/> | <input type="checkbox"/> | <input type="checkbox"/> | <input type="checkbox"/> | <input type="checkbox"/> | |
| ∞02-34 | Output Boundary for External Terminals | 0.00~120.00Hz (it is motor speed when using with PG) | 0.00 | <input type="checkbox"/> | <input type="checkbox"/> | <input type="checkbox"/> | <input type="checkbox"/> | <input type="checkbox"/> | |
| ∞02-35 | Detection Time of Mechanical Brake | 0.00~10.00 Sec | 0.00 | <input type="checkbox"/> | <input type="checkbox"/> | <input type="checkbox"/> | <input type="checkbox"/> | <input type="checkbox"/> | |

Group 3 Analog Input/Output Parameters

| Pr. | Explanation | Settings | Factory Setting | VF | V/FG | SVC | FOCPG | TQOPG | FOCPM | |
|--------|------------------------------------|---|-----------------|--------------------------|--------------------------|--------------------------|--------------------------|--------------------------|--------------------------|--------------------------|
| ↗03-00 | Analog Input 1 (AU11) | 0: No function | 1 | <input type="checkbox"/> | <input type="checkbox"/> | <input type="checkbox"/> | <input type="checkbox"/> | <input type="checkbox"/> | <input type="checkbox"/> | |
| ↗03-01 | Analog Input 2 (ACI) | 1: Frequency command (torque limit under TQR control mode) | 0 | <input type="checkbox"/> | <input type="checkbox"/> | <input type="checkbox"/> | <input type="checkbox"/> | <input type="checkbox"/> | <input type="checkbox"/> | |
| ↗03-02 | Analog Input 3 (AU12) | 2: Torque command (torque limit under speed mode) | 0 | <input type="checkbox"/> | <input type="checkbox"/> | <input type="checkbox"/> | <input type="checkbox"/> | <input type="checkbox"/> | <input type="checkbox"/> | |
| | | 3: Torque compensation command | | <input type="checkbox"/> | <input type="checkbox"/> | <input type="checkbox"/> | <input type="checkbox"/> | <input type="checkbox"/> | <input type="checkbox"/> | |
| | | 4-5: Reserved | | <input type="checkbox"/> | <input type="checkbox"/> | <input type="checkbox"/> | <input type="checkbox"/> | <input type="checkbox"/> | <input type="checkbox"/> | |
| | | 6: P.T.C. thermistor input value | | <input type="checkbox"/> | <input type="checkbox"/> | <input type="checkbox"/> | <input type="checkbox"/> | <input type="checkbox"/> | <input type="checkbox"/> | |
| | | 7: Positive torque limit | | <input type="checkbox"/> | <input type="checkbox"/> | <input type="checkbox"/> | <input type="checkbox"/> | <input type="checkbox"/> | <input type="checkbox"/> | |
| | | 8: Negative torque limit | | <input type="checkbox"/> | <input type="checkbox"/> | <input type="checkbox"/> | <input type="checkbox"/> | <input type="checkbox"/> | <input type="checkbox"/> | |
| | | 9: Regenerative torque limit | | <input type="checkbox"/> | <input type="checkbox"/> | <input type="checkbox"/> | <input type="checkbox"/> | <input type="checkbox"/> | <input type="checkbox"/> | |
| | | 10: Positive/negative torque limit | | <input type="checkbox"/> | <input type="checkbox"/> | <input type="checkbox"/> | <input type="checkbox"/> | <input type="checkbox"/> | <input type="checkbox"/> | |
| | | 11: Preload Input | | <input type="checkbox"/> | <input type="checkbox"/> | <input type="checkbox"/> | <input type="checkbox"/> | <input type="checkbox"/> | <input type="checkbox"/> | |
| ↗03-03 | | Analog Input Bias 1 (AU11) | | -100.0~100.0% | 0.0 | <input type="checkbox"/> | <input type="checkbox"/> | <input type="checkbox"/> | <input type="checkbox"/> | <input type="checkbox"/> |
| ↗03-04 | | Analog Input Bias 2 (ACI) | | -100.0~100.0% | 0.0 | <input type="checkbox"/> | <input type="checkbox"/> | <input type="checkbox"/> | <input type="checkbox"/> | <input type="checkbox"/> |
| ↗03-05 | Analog Input Bias 3 (AU12) | -100.0~100.0% | 0.0 | <input type="checkbox"/> | <input type="checkbox"/> | <input type="checkbox"/> | <input type="checkbox"/> | <input type="checkbox"/> | | |
| ↗03-06 | Positive/negative Bias Mode (AU11) | 0: Zero bias | 0 | <input type="checkbox"/> | <input type="checkbox"/> | <input type="checkbox"/> | <input type="checkbox"/> | <input type="checkbox"/> | | |
| ↗03-07 | | 1: Lower than bias=bias 2: Greater than bias=bias 3: The absolute value of the bias voltage while serving as the center | 0 | <input type="checkbox"/> | <input type="checkbox"/> | <input type="checkbox"/> | <input type="checkbox"/> | <input type="checkbox"/> | | |
| ↗03-08 | Positive/negative Bias Mode (AU12) | 4: Serve bias as the center | 0 | <input type="checkbox"/> | <input type="checkbox"/> | <input type="checkbox"/> | <input type="checkbox"/> | <input type="checkbox"/> | | |
| ↗03-09 | Analog Input Gain 1 (AU11) | -500.0~500.0% | 100.0 | <input type="checkbox"/> | <input type="checkbox"/> | <input type="checkbox"/> | <input type="checkbox"/> | <input type="checkbox"/> | | |
| ↗03-10 | Analog Input Gain 2 (ACI) | -500.0~500.0% | 100.0 | <input type="checkbox"/> | <input type="checkbox"/> | <input type="checkbox"/> | <input type="checkbox"/> | <input type="checkbox"/> | | |
| ↗03-11 | Analog Input Gain 3 (AU12) | -500.0~500.0% | 100.0 | <input type="checkbox"/> | <input type="checkbox"/> | <input type="checkbox"/> | <input type="checkbox"/> | <input type="checkbox"/> | | |
| ↗03-12 | Analog Input Delay Time (AU11) | 0.00~2.00 sec | 0.01 | <input type="checkbox"/> | <input type="checkbox"/> | <input type="checkbox"/> | <input type="checkbox"/> | <input type="checkbox"/> | | |
| ↗03-13 | Analog Input Delay Time (ACI) | 0.00~2.00 sec | 0.01 | <input type="checkbox"/> | <input type="checkbox"/> | <input type="checkbox"/> | <input type="checkbox"/> | <input type="checkbox"/> | | |
| ↗03-14 | Analog Input Delay Time (AU12) | 0.00~2.00 sec | 0.01 | <input type="checkbox"/> | <input type="checkbox"/> | <input type="checkbox"/> | <input type="checkbox"/> | <input type="checkbox"/> | | |
| ↗03-15 | Loss of the ACI Signal | 0: Disable | 0 | <input type="checkbox"/> | <input type="checkbox"/> | <input type="checkbox"/> | <input type="checkbox"/> | <input type="checkbox"/> | | |
| | | 1: Continue operation at the last frequency | | <input type="checkbox"/> | <input type="checkbox"/> | <input type="checkbox"/> | <input type="checkbox"/> | <input type="checkbox"/> | | |
| | | 2: Decelerate to 0Hz | | <input type="checkbox"/> | <input type="checkbox"/> | <input type="checkbox"/> | <input type="checkbox"/> | <input type="checkbox"/> | | |
| | | 3: Stop immediately and display E.F. | | <input type="checkbox"/> | <input type="checkbox"/> | <input type="checkbox"/> | <input type="checkbox"/> | <input type="checkbox"/> | | |
| 03-16 | Reserved | | | | | | | | | |
| ↗03-17 | Analog Output Selection 1 | 0: Output frequency (Hz) | 0 | <input type="checkbox"/> | <input type="checkbox"/> | <input type="checkbox"/> | <input type="checkbox"/> | <input type="checkbox"/> | | |
| | | 1: Frequency command (Hz) | | <input type="checkbox"/> | <input type="checkbox"/> | <input type="checkbox"/> | <input type="checkbox"/> | <input type="checkbox"/> | | |
| | | 2: Motor speed (RPM) | | <input type="checkbox"/> | <input type="checkbox"/> | <input type="checkbox"/> | <input type="checkbox"/> | <input type="checkbox"/> | | |
| | | 3: Output current (rms) | | <input type="checkbox"/> | <input type="checkbox"/> | <input type="checkbox"/> | <input type="checkbox"/> | <input type="checkbox"/> | | |
| | | 4: Output voltage | | <input type="checkbox"/> | <input type="checkbox"/> | <input type="checkbox"/> | <input type="checkbox"/> | <input type="checkbox"/> | | |
| | | 5: DC Bus Voltage | | <input type="checkbox"/> | <input type="checkbox"/> | <input type="checkbox"/> | <input type="checkbox"/> | <input type="checkbox"/> | | |
| | | 6: Power factor | | <input type="checkbox"/> | <input type="checkbox"/> | <input type="checkbox"/> | <input type="checkbox"/> | <input type="checkbox"/> | | |
| | | 7: Power | | <input type="checkbox"/> | <input type="checkbox"/> | <input type="checkbox"/> | <input type="checkbox"/> | <input type="checkbox"/> | | |
| | | 8: Output torque | | <input type="checkbox"/> | <input type="checkbox"/> | <input type="checkbox"/> | <input type="checkbox"/> | <input type="checkbox"/> | | |
| | | 9: AU11 | | <input type="checkbox"/> | <input type="checkbox"/> | <input type="checkbox"/> | <input type="checkbox"/> | <input type="checkbox"/> | | |
| | | 10: ACI | | <input type="checkbox"/> | <input type="checkbox"/> | <input type="checkbox"/> | <input type="checkbox"/> | <input type="checkbox"/> | | |
| | | 11: AU12 | | <input type="checkbox"/> | <input type="checkbox"/> | <input type="checkbox"/> | <input type="checkbox"/> | <input type="checkbox"/> | | |
| | | 12: q-axis current | | <input type="checkbox"/> | <input type="checkbox"/> | <input type="checkbox"/> | <input type="checkbox"/> | <input type="checkbox"/> | | |
| | | 13: q-axis feedback value | | <input type="checkbox"/> | <input type="checkbox"/> | <input type="checkbox"/> | <input type="checkbox"/> | <input type="checkbox"/> | | |
| | | 14: d-axis current | | <input type="checkbox"/> | <input type="checkbox"/> | <input type="checkbox"/> | <input type="checkbox"/> | <input type="checkbox"/> | | |
| | | 15: d-axis feedback value | | <input type="checkbox"/> | <input type="checkbox"/> | <input type="checkbox"/> | <input type="checkbox"/> | <input type="checkbox"/> | | |
| | | 16: q-axis voltage | | <input type="checkbox"/> | <input type="checkbox"/> | <input type="checkbox"/> | <input type="checkbox"/> | <input type="checkbox"/> | | |
| | | 17: d-axis voltage | | <input type="checkbox"/> | <input type="checkbox"/> | <input type="checkbox"/> | <input type="checkbox"/> | <input type="checkbox"/> | | |
| | | 18: Torque command | | <input type="checkbox"/> | <input type="checkbox"/> | <input type="checkbox"/> | <input type="checkbox"/> | <input type="checkbox"/> | | |
| | | 19-20: Reserved | | <input type="checkbox"/> | <input type="checkbox"/> | <input type="checkbox"/> | <input type="checkbox"/> | <input type="checkbox"/> | | |
| ↗03-18 | Analog Output Gain 1 | 0~200.0% | 100.0 | <input type="checkbox"/> | <input type="checkbox"/> | <input type="checkbox"/> | <input type="checkbox"/> | <input type="checkbox"/> | | |

| Pr. | Explanation | Settings | Factory Setting | VF | VFPF | SVC | FOCPG | TOCPG | FOCPM |
|--------|--|--|-----------------|-----------------------|-----------------------|-----------------------|-----------------------|-----------------------|-----------------------|
| ↗03-19 | Analog Output Value in REV Direction 1 | 0: Absolute value in REV direction 1: Output 0V in REV direction 2: Enable output voltage in REV direction | 0 | <input type="radio"/> | <input type="radio"/> | <input type="radio"/> | <input type="radio"/> | <input type="radio"/> | <input type="radio"/> |
| ↗03-20 | Analog Output Selection 2 | 0: Output frequency (Hz) 1: Frequency command (Hz) 2: Motor speed (RPM) 3: Output current (rms) 4: Output voltage 5: DC Bus Voltage 6: Power factor 7: Power 8: Output torque 9: AVI 10: ACI 11: AUI 12: q-axis current 13: q-axis feedback value 14: d-axis current 15: d-axis feedback value 16: q-axis voltage 17: d-axis voltage 18: Torque command 19-20: Reserved | 0 | <input type="radio"/> | <input type="radio"/> | <input type="radio"/> | <input type="radio"/> | <input type="radio"/> | <input type="radio"/> |
| ↗03-21 | Analog Output Gain 2 | 0-200.0% | 100.0 | <input type="radio"/> | <input type="radio"/> | <input type="radio"/> | <input type="radio"/> | <input type="radio"/> | <input type="radio"/> |
| ↗03-22 | Analog Output Value in REV Direction 2 | 0: Absolute value in REV direction 1: Output 0V in REV direction 2: Enable output voltage in REV direction | 0 | <input type="radio"/> | <input type="radio"/> | <input type="radio"/> | <input type="radio"/> | <input type="radio"/> | <input type="radio"/> |

Group 4 Multi-Step Speed Parameters

| Pr. | Explanation | Settings | Factory Setting | VF | VFPF | SVC | FOCPG | TQCPG | FOCPM |
|--------|---------------------------|---------------|-----------------|-----------------------|-----------------------|-----------------------|-----------------------|-----------------------|-----------------------|
| ↙04-00 | Zero Step Speed Frequency | 0.00~120.00Hz | 0.00 | <input type="radio"/> | <input type="radio"/> | <input type="radio"/> | <input type="radio"/> | <input type="radio"/> | <input type="radio"/> |
| ↙04-01 | 1st Step Speed Frequency | 0.00~120.00Hz | 0.00 | <input type="radio"/> | <input type="radio"/> | <input type="radio"/> | <input type="radio"/> | <input type="radio"/> | <input type="radio"/> |
| ↙04-02 | 2nd Step Speed Frequency | 0.00~120.00Hz | 0.00 | <input type="radio"/> | <input type="radio"/> | <input type="radio"/> | <input type="radio"/> | <input type="radio"/> | <input type="radio"/> |
| ↙04-03 | 3rd Step Speed Frequency | 0.00~120.00Hz | 0.00 | <input type="radio"/> | <input type="radio"/> | <input type="radio"/> | <input type="radio"/> | <input type="radio"/> | <input type="radio"/> |
| ↙04-04 | 4th Step Speed Frequency | 0.00~120.00Hz | 0.00 | <input type="radio"/> | <input type="radio"/> | <input type="radio"/> | <input type="radio"/> | <input type="radio"/> | <input type="radio"/> |
| ↙04-05 | 5th Step Speed Frequency | 0.00~120.00Hz | 0.00 | <input type="radio"/> | <input type="radio"/> | <input type="radio"/> | <input type="radio"/> | <input type="radio"/> | <input type="radio"/> |
| ↙04-06 | 6th Step Speed Frequency | 0.00~120.00Hz | 0.00 | <input type="radio"/> | <input type="radio"/> | <input type="radio"/> | <input type="radio"/> | <input type="radio"/> | <input type="radio"/> |
| ↙04-07 | 7th Step Speed Frequency | 0.00~120.00Hz | 0.00 | <input type="radio"/> | <input type="radio"/> | <input type="radio"/> | <input type="radio"/> | <input type="radio"/> | <input type="radio"/> |
| ↙04-08 | 8th Step Speed Frequency | 0.00~120.00Hz | 0.00 | <input type="radio"/> | <input type="radio"/> | <input type="radio"/> | <input type="radio"/> | <input type="radio"/> | <input type="radio"/> |
| ↙04-09 | 9th Step Speed Frequency | 0.00~120.00Hz | 0.00 | <input type="radio"/> | <input type="radio"/> | <input type="radio"/> | <input type="radio"/> | <input type="radio"/> | <input type="radio"/> |
| ↙04-10 | 10th Step Speed Frequency | 0.00~120.00Hz | 0.00 | <input type="radio"/> | <input type="radio"/> | <input type="radio"/> | <input type="radio"/> | <input type="radio"/> | <input type="radio"/> |
| ↙04-11 | 11th Step Speed Frequency | 0.00~120.00Hz | 0.00 | <input type="radio"/> | <input type="radio"/> | <input type="radio"/> | <input type="radio"/> | <input type="radio"/> | <input type="radio"/> |
| ↙04-12 | 12th Step Speed Frequency | 0.00~120.00Hz | 0.00 | <input type="radio"/> | <input type="radio"/> | <input type="radio"/> | <input type="radio"/> | <input type="radio"/> | <input type="radio"/> |
| ↙04-13 | 13th Step Speed Frequency | 0.00~120.00Hz | 0.00 | <input type="radio"/> | <input type="radio"/> | <input type="radio"/> | <input type="radio"/> | <input type="radio"/> | <input type="radio"/> |
| ↙04-14 | 14th Step Speed Frequency | 0.00~120.00Hz | 0.00 | <input type="radio"/> | <input type="radio"/> | <input type="radio"/> | <input type="radio"/> | <input type="radio"/> | <input type="radio"/> |
| ↙04-15 | 15th Step Speed Frequency | 0.00~120.00Hz | 0.00 | <input type="radio"/> | <input type="radio"/> | <input type="radio"/> | <input type="radio"/> | <input type="radio"/> | <input type="radio"/> |

Group 5 IM Motor Parameters

| Pr. | Explanation | Settings | Factory Setting | VF | VFG | SVC | FOCPG | TOCPG | FOCPM |
|--------|--|---|-----------------|-----------------------|-----------------------|-----------------------|-----------------------|-----------------------|-------|
| 05-00 | Motor Auto Tuning | 0: No function 1: Rolling test (Rs, Rr, Lm, Lx, no-load current) 2: Static Test | 0 | <input type="radio"/> | | | | | |
| 05-01 | Full-load Current of Motor | 40-120% | ### | <input type="radio"/> | <input type="radio"/> | <input type="radio"/> | <input type="radio"/> | <input type="radio"/> | |
| 05-02 | Rated power of Motor | 0.00~655.35kW | ### | | | <input type="radio"/> | <input type="radio"/> | <input type="radio"/> | |
| 05-03 | Rated speed of Motor (rpm) | 0~65535 | 1710 | | <input type="radio"/> | <input type="radio"/> | <input type="radio"/> | <input type="radio"/> | |
| 05-04 | Number of Motor Poles | 2~48 | 4 | <input type="radio"/> | | <input type="radio"/> | <input type="radio"/> | <input type="radio"/> | |
| 05-05 | No-load Current of Motor | 0-100% | ### | | <input type="radio"/> | <input type="radio"/> | <input type="radio"/> | <input type="radio"/> | |
| 05-06 | Rs of Motor | 0.000~65.535Ω | 0.000 | | | <input type="radio"/> | <input type="radio"/> | <input type="radio"/> | |
| 05-07 | Rr of Motor | 0.000~65.535Ω | 0.000 | | | <input type="radio"/> | <input type="radio"/> | <input type="radio"/> | |
| 05-08 | Lm of Motor | 0.0~6553.5mH | 0.0 | | | <input type="radio"/> | <input type="radio"/> | <input type="radio"/> | |
| 05-09 | Lx of Motor | 0.0~6553.5mH | 0.0 | | | <input type="radio"/> | <input type="radio"/> | <input type="radio"/> | |
| ↗05-10 | Torque Compensation Time Constant | 0.001~10.000sec | 0.020 | | <input type="radio"/> | | | | |
| ↗05-11 | Slip Compensation Time Constant | 0.001~10.000sec | 0.100 | | | <input type="radio"/> | | | |
| ↗05-12 | Torque Compensation Gain | 0~10 | 0 | <input type="radio"/> | <input type="radio"/> | | | | |
| ↗05-13 | Slip Compensation Gain | 0.00~10.00 | 0.00 | <input type="radio"/> | <input type="radio"/> | <input type="radio"/> | | | |
| ↗05-14 | Slip Deviation Level | 0~1000% (0: disable) | 0 | | <input type="radio"/> | <input type="radio"/> | | | |
| ↗05-15 | Detection Time of Slip Deviation | 0.0~10.0 sec | 1.0 | | <input type="radio"/> | <input type="radio"/> | | | |
| ↗05-16 | Over Slip Treatment | 0: Warn and keep operation 1: Warn and ramp to stop 2: Warn and coast to stop | 0 | | <input type="radio"/> | <input type="radio"/> | <input type="radio"/> | | |
| ↗05-17 | Hunting Gain | 0~10000 (0: disable) | 2000 | <input type="radio"/> | <input type="radio"/> | <input type="radio"/> | | | |
| 05-18 | Accumulative Motor Operation Time (Min.) | 00~1439 | 00 | <input type="radio"/> | <input type="radio"/> | <input type="radio"/> | <input type="radio"/> | <input type="radio"/> | |
| 05-19 | Accumulative Motor Operation Time (day) | 00~65535 | 00 | <input type="radio"/> | <input type="radio"/> | <input type="radio"/> | <input type="radio"/> | <input type="radio"/> | |
| ↗05-20 | Core Loss Compensation | 0~250% | 10 | | | <input type="radio"/> | | | |

Group 6 Protection Parameters

| Pr. | Explanation | Settings | Factory Setting | VF | VFG | SVC | FOCPG | TQCPG | FOCPM |
|--------|--|--|-----------------|--------------------------|--------------------------|--------------------------|--------------------------|--------------------------|--------------------------|
| ↗06-00 | Low Voltage Level | 160.0~220.0Vdc | 180.0 | <input type="checkbox"/> | <input type="checkbox"/> | <input type="checkbox"/> | <input type="checkbox"/> | <input type="checkbox"/> | <input type="checkbox"/> |
| | | 320.0~440.0Vdc | 360.0 | <input type="checkbox"/> | <input type="checkbox"/> | <input type="checkbox"/> | <input type="checkbox"/> | <input type="checkbox"/> | <input type="checkbox"/> |
| ↗06-01 | Phase-loss Protection | 0: Warn and keep operation 1: Warn and ramp to stop 2: Warn and coast to stop | 2 | <input type="checkbox"/> | <input type="checkbox"/> | <input type="checkbox"/> | <input type="checkbox"/> | <input type="checkbox"/> | <input type="checkbox"/> |
| ↗06-02 | Over-current Stall Prevention during Acceleration | 00: disable 00~250% | 00 | <input type="checkbox"/> | <input type="checkbox"/> | <input type="checkbox"/> | | | |
| ↗06-03 | Over-current Stall Prevention during Operation | 00: disable 00~250% | 00 | <input type="checkbox"/> | <input type="checkbox"/> | <input type="checkbox"/> | | | |
| ↗06-04 | Accel./Decel. Time Selection of Stall Prevention at constant speed | 0: by current accel/decel time 1: by the 1st accel/decel time 2: by the 2nd accel/decel time 3: by the 3rd accel/decel time 4: by the 4th accel/decel time 5: by auto accel/decel time | 0 | <input type="checkbox"/> | <input type="checkbox"/> | <input type="checkbox"/> | | | |
| ↗06-05 | Over-torque Detection Selection (OT1) | 0: disable 1: over-torque detection during constant speed operation, continue to operate after detection 2: over-torque detection during constant speed operation, stop operation after detection 3: over-torque detection during operation, continue to operate after detection 4: over-torque detection during operation, stop operation after detection | 0 | <input type="checkbox"/> | <input type="checkbox"/> | <input type="checkbox"/> | <input type="checkbox"/> | <input type="checkbox"/> | <input type="checkbox"/> |
| ↗06-06 | Over-torque Detection Level (OT1) | 10~250% | 150 | <input type="checkbox"/> | <input type="checkbox"/> | <input type="checkbox"/> | <input type="checkbox"/> | <input type="checkbox"/> | <input type="checkbox"/> |
| ↗06-07 | Over-torque Detection Time (OT1) | 0.0~60.0 sec | 0.1 | <input type="checkbox"/> | <input type="checkbox"/> | <input type="checkbox"/> | <input type="checkbox"/> | <input type="checkbox"/> | <input type="checkbox"/> |
| ↗06-08 | Over-torque Detection Selection (OT2) | 0: disable 1: over-torque detection during constant speed operation, continue to operate after detection 2: over-torque detection during constant speed operation, stop operation after detection 3: over-torque detection during operation, continue to operate after detection 4: over-torque detection during operation, stop operation after detection | 0 | <input type="checkbox"/> | <input type="checkbox"/> | <input type="checkbox"/> | <input type="checkbox"/> | <input type="checkbox"/> | <input type="checkbox"/> |
| ↗06-09 | Over-torque Detection Level (OT2) | 10~250% | 150 | <input type="checkbox"/> | <input type="checkbox"/> | <input type="checkbox"/> | <input type="checkbox"/> | <input type="checkbox"/> | <input type="checkbox"/> |
| ↗06-10 | Over-torque Detection Time (OT2) | 0.0~60.0 sec | 0.1 | <input type="checkbox"/> | <input type="checkbox"/> | <input type="checkbox"/> | <input type="checkbox"/> | <input type="checkbox"/> | <input type="checkbox"/> |
| ↗06-11 | Current Limit | 0~250% | 150 | | | | <input type="checkbox"/> | <input type="checkbox"/> | |
| 06-12 | Electronic Thermal Relay Selection | 0: Inverter motor 1: Standard motor 2: Disable | 2 | <input type="checkbox"/> | <input type="checkbox"/> | <input type="checkbox"/> | <input type="checkbox"/> | <input type="checkbox"/> | <input type="checkbox"/> |
| ↗06-13 | Electronic Thermal Characteristic | 30.0~600.0 sec | 60.0 | <input type="checkbox"/> | <input type="checkbox"/> | <input type="checkbox"/> | <input type="checkbox"/> | <input type="checkbox"/> | <input type="checkbox"/> |
| ↗06-14 | Heat Sink Over-heat (OH) Warning | 0.0~110.0°C | 85.0 | <input type="checkbox"/> | <input type="checkbox"/> | <input type="checkbox"/> | <input type="checkbox"/> | <input type="checkbox"/> | <input type="checkbox"/> |
| ↗06-15 | Stall Prevention Limit Level | 0~100% (refer to Pr.06-02, Pr.06-03) | 50 | <input type="checkbox"/> | <input type="checkbox"/> | <input type="checkbox"/> | | | |
| 06-16 | Present Fault Record | 0: No fault | 0 | <input type="checkbox"/> | <input type="checkbox"/> | <input type="checkbox"/> | <input type="checkbox"/> | <input type="checkbox"/> | <input type="checkbox"/> |
| 06-17 | Second Most Recent Fault Record | 1: Over-current during acceleration (ocA) 2: Over-current during deceleration (ocd) | 0 | <input type="checkbox"/> | <input type="checkbox"/> | <input type="checkbox"/> | <input type="checkbox"/> | <input type="checkbox"/> | <input type="checkbox"/> |
| 06-18 | Third Most Recent Fault Record | 3: Over-current during constant speed (ocn) 4: Ground fault (GFF) | 0 | <input type="checkbox"/> | <input type="checkbox"/> | <input type="checkbox"/> | <input type="checkbox"/> | <input type="checkbox"/> | <input type="checkbox"/> |
| 06-19 | Fourth Most Recent Fault Record | 5: IGBT short-circuit (occ) 6: Over-current at stop (ocS) | 0 | <input type="checkbox"/> | <input type="checkbox"/> | <input type="checkbox"/> | <input type="checkbox"/> | <input type="checkbox"/> | <input type="checkbox"/> |
| 06-20 | Fifth Most Recent Fault Record | 7: Over-voltage during acceleration (ovA) 8: Over-voltage during deceleration (ovd) | 0 | <input type="checkbox"/> | <input type="checkbox"/> | <input type="checkbox"/> | <input type="checkbox"/> | <input type="checkbox"/> | <input type="checkbox"/> |
| 06-21 | Sixth Most Recent Fault Record | 9: Over-voltage during constant speed (ovn) 10: Over-voltage at stop (ovS) | 0 | <input type="checkbox"/> | <input type="checkbox"/> | <input type="checkbox"/> | <input type="checkbox"/> | <input type="checkbox"/> | <input type="checkbox"/> |

| Pr. | Explanation | Settings | Factory Setting | VF | VFPF | SVC | FOCPG | TOCPG | FOCPM |
|--------|--|---|-----------------|----|------|-----|-------|-------|-------|
| | | 11: Low-voltage during acceleration (LVa) 12: Low-voltage during deceleration (LVd) 13: Low-voltage during constant speed (LVn) 14: Low-voltage at stop (LVs) 15: Phase loss (PHL) 16: IGBT heat sink over-heat (oH1) 17: Heat sink over-heat (oH2)(for 40HP above) 18: TH1 open loop error (tH1o) 19: TH2 open loop error (tH2o) 20: Fan error signal output 21: over-load (oL) (150% 1Min) 22: Motor over-load (EoL1) 23: Reserved 24: Motor PTC overheat (oH3) 25: Reserved 26: over-torque 1 (ot1) 27: over-torque 1 (ot2) 28: Reserved 29: Reserved 30: Memory write-in error (cF1) 31: Memory read-out error (cF2) 32: Isum current detection error (cd0) 33: U-phase current detection error (cd1) 34: V-phase current detection error (cd2) 35: W-phase current detection error (cd3) 36: Clamp current detection error (Hd0) 37: Over-current detection error (Hd1) 38: Over-voltage detection error (Hd2) 39: Ground current detection error (Hd3) 40: Auto tuning error (AuE) 41: PID feedback loss (AFE) 42: PG feedback error (PGF1) 43: PG feedback loss (PGF2) 44: PG feedback stall (PGF3) 45: PG slip error (PGF4) 46: PG ref input error (PGr1) 47: PG ref loss (PGr2) 48: Analog current input error (ACE) 49: External fault input (EF) 50: Emergency stop (EF1) 51: Reserved 52: Password error (PcodE) 53: Reserved 54: Communication error (cE1) 55: Communication error (cE2) 56: Communication error (cE3) 57: Communication error (cE4) 58: Communication Time-out (cE10) 59: PU time-out (cP10) 60: Brake chopper error (bF) 61-62: Reserved 63: Safety loop error (Sry) 64: Mechanical brake error (MBF) 65: PGF5 hardware error | | | | | | | |
| ∕06-22 | Fault Output Option 1 | 0-65535 (refer to bit table for fault code) | 0 | ○ | ○ | ○ | ○ | ○ | ○ |
| ∕06-23 | Fault Output Option 2 | 0-65535 (refer to bit table for fault code) | 0 | ○ | ○ | ○ | ○ | ○ | ○ |
| ∕06-24 | Fault Output Option 3 | 0-65535 (refer to bit table for fault code) | 0 | ○ | ○ | ○ | ○ | ○ | ○ |
| ∕06-25 | Fault Output Option 4 | 0-65535 (refer to bit table for fault code) | 0 | ○ | ○ | ○ | ○ | ○ | ○ |
| ∕06-26 | PTC (Positive Temperature Coefficient) Detection Selection | 0: Warn and keep operation 1: Warn and ramp to stop | 0 | ○ | ○ | ○ | ○ | ○ | ○ |
| ∕06-27 | PTC Level | 0.0~100.0% | 50.0 | ○ | ○ | ○ | ○ | ○ | ○ |
| ∕06-28 | Filter Time for PTC Detection | 0.00~10.00sec | 0.20 | ○ | ○ | ○ | ○ | ○ | ○ |
| 06-29 | EPS Voltage | 48.0~375.0Vdc 96.0~750.0Vdc | 48.0 96.0 | ○ | ○ | ○ | ○ | ○ | ○ |
| ∕06-30 | Setting Method of Fault Output | 0: By settings of Pr.06-22~06-25 1: By the binary setting | 0 | ○ | ○ | ○ | ○ | ○ | ○ |

Group 7 Special Parameters

| Pr. | Explanation | Settings | Factory Setting | VF | VFG | SVC | FOCPG | TQCPG | FOCPM |
|--------|---|---|-----------------|----|-----|-----|-------|-------|-------|
| ↗07-00 | Brake Chopper Level | 230V: 350.0~450.0Vdc 460V: 700.0~900.0Vdc | 380.0 760.0 | ○ | ○ | ○ | ○ | ○ | ○ |
| 07-01 | Brake ED Value Setting | 0~100% | 100 | ○ | ○ | ○ | ○ | ○ | ○ |
| ↗07-02 | DC Brake Current Level | 0~100% | 0 | ○ | ○ | ○ | ○ | ○ | ○ |
| ↗07-03 | DC Brake Time during Start-up | 0.0~60.0 sec | 0.0 | ○ | ○ | ○ | ○ | ○ | ○ |
| ↗07-04 | DC Brake Time during Stopping | 0.0~60.0 sec | 0.0 | ○ | ○ | ○ | ○ | ○ | ○ |
| ↗07-05 | Start-point for DC Brake | 0.00~120.00Hz | 0.00 | ○ | ○ | ○ | ○ | ○ | ○ |
| ↗07-06 | DC Brake Proportional Gain | 1~500Hz | 50 | ○ | ○ | ○ | ○ | ○ | ○ |
| ↗07-07 | Dwell Time at Accel. | 0.00~600.00sec | 0.00 | ○ | ○ | ○ | ○ | ○ | ○ |
| ↗07-08 | Dwell Frequency at Accel. | 0.00~120.00Hz | 0.00 | ○ | ○ | ○ | ○ | ○ | ○ |
| ↗07-09 | Dwell Time at Decel. | 0.00~600.00sec | 0.00 | ○ | ○ | ○ | ○ | ○ | ○ |
| ↗07-10 | Dwell Frequency at Decel. | 0.00~120.00Hz | 0.00 | ○ | ○ | ○ | ○ | ○ | ○ |
| ↗07-11 | Fan Control | 0: Fan always ON 1: 1 minute after AC motor drive stops, fan will be OFF 2: AC motor drive runs and fan ON, AC motor drive stops and fan OFF 3: Fan ON to run when preliminary heat sink temperature attained 4: Fan always OFF | 2 | ○ | ○ | ○ | ○ | ○ | ○ |
| ↗07-12 | Torque Command | -100.0~100.0% (Pr. 07-14 setting=100%) | 0.0 | | | | | ○ | |
| ↗07-13 | Torque Command Source | 0: Digital keypad (KPVL-CC01) 1: RS485 serial communication (RJ-11) 2: Analog signal (Pr.03-00) | 2 | | | | | ○ | |
| ↗07-14 | Maximum Torque Command | 0~500% | 100 | ○ | ○ | ○ | ○ | ○ | ○ |
| ↗07-15 | Filter Time of Torque Command | 0.000~1.000 sec | 0.000 | | | | | ○ | |
| 07-16 | Speed Limit Selection | 0: By Pr.07-17 and Pr.07-18 1: Frequency command source (Pr.00-14) | 0 | | | | | ○ | |
| ↗07-17 | Torque Mode +Speed Limit | 0~120% | 10 | | | | | ○ | |
| ↗07-18 | Torque Mode-Speed Limit | 0~120% | 10 | | | | | ○ | |
| ↗07-19 | Source of Torque Offset | 0: Disable 1: Analog input (Pr.03-00) 2: Torque offset setting (Pr.07-20) 3: Control by external terminal (by Pr.07-21 to Pr.07-23) | 0 | | | ○ | ○ | ○ | ○ |
| ↗07-20 | Torque Offset Setting | 0.0~100.0% | 0.0 | | | ○ | ○ | ○ | ○ |
| ↗07-21 | High Torque Offset | 0.0~100.0% | 30.0 | | | ○ | ○ | ○ | ○ |
| ↗07-22 | Middle Torque Offset | 0.0~100.0% | 20.0 | | | ○ | ○ | ○ | ○ |
| ↗07-23 | Low Torque Offset | 0.0~100.0% | 10.0 | | | ○ | ○ | ○ | ○ |
| ↗07-24 | Forward Motor Torque Limit | 0~500% | 200 | | | ○ | ○ | ○ | ○ |
| ↗07-25 | Forward Regenerative Torque Limit | 0~500% | 200 | | | ○ | ○ | ○ | ○ |
| ↗07-26 | Reverse Motor Torque Limit | 0~500% | 200 | | | ○ | ○ | ○ | ○ |
| ↗07-27 | Reverse Regenerative Torque Limit | 0~500% | 200 | | | ○ | ○ | ○ | ○ |
| ↗07-28 | Emergency Stop (EF) & Forced Stop Selection | 0: Coast to stop 1: By deceleration Time 1 2: By deceleration Time 2 3: By deceleration Time 3 4: By deceleration Time 4 5: By Pr.01-31 | 0 | ○ | ○ | ○ | ○ | ○ | ○ |
| ↗07-29 | Time for Decreasing Torque at Stop | 0.000~1.000 sec | 0.000 | | | | ○ | ○ | ○ |

Chapter 4 Parameters | **VFD-VL**
Group 8 PM Motor Parameters

| Pr. | Explanation | Settings | Factory Setting | VF | VPPG | SVC | FOCPG | TOCPG | FOCPM |
|-------|--|---|-----------------|----|------|-----|-------|-------|-------|
| 08-00 | Motor Auto Tuning | 0: No function 1: Only for the unloaded motor, auto measure the angle between magnetic field and PG origin (08-09) 2: For PM motor parameters 3: Auto measure the angle between magnetic field and PG origin (08-09) | 0 | | | | | | ○ |
| 08-01 | Full-load Current of Motor | 40-120% | ### | | | | | | ○ |
| 08-02 | Rated power of Motor | 0.00-655.35 kW | ### | | | | | | ○ |
| 08-03 | Rated speed of Motor (rpm) | 0-65535 | 1710 | | | | | | ○ |
| 08-04 | Number of Motor Poles | 2-96 | 4 | | | | | | ○ |
| 08-05 | Rs of Motor | 0.000-65.535Ω | 0.000 | | | | | | ○ |
| 08-06 | Ld of Motor | 0.0-6553.5mH | 0.0 | | | | | | ○ |
| 08-07 | Lq of Motor | 0.0-6553.5mH | 0.0 | | | | | | ○ |
| 08-08 | Reserved | | | | | | | | |
| 08-09 | Angle between Magnetic Field and PG Origin | 0.0-360.0° | 360 | | | | | | ○ |
| 08-10 | Magnetic Field Re-orientation | 0: Disable 1: Enable | 0 | | | | | | ○ |

Group 9 Communication Parameters

| Pr. | Explanation | Settings | Factory Setting | VF | VFFG | SVC | FOCPG | TQOPG | FOCPM |
|--------|------------------------------|--|-----------------|-----------------------|-----------------------|-----------------------|-----------------------|-----------------------|-----------------------|
| ↗09-00 | Communication Address | 1~254 | 1 | <input type="radio"/> | <input type="radio"/> | <input type="radio"/> | <input type="radio"/> | <input type="radio"/> | <input type="radio"/> |
| ↗09-01 | Transmission Speed | 4.8~115.2Kbps | 9.6 | <input type="radio"/> | <input type="radio"/> | <input type="radio"/> | <input type="radio"/> | <input type="radio"/> | <input type="radio"/> |
| ↗09-02 | Transmission Fault Treatment | 0: Warn and keep operation 1: Warn and ramp to stop 2: Reserved 3: No action and no display | 3 | <input type="radio"/> | <input type="radio"/> | <input type="radio"/> | <input type="radio"/> | <input type="radio"/> | <input type="radio"/> |
| ↗09-03 | Time-out Detection | 0.0~100.0 sec | 0.0 | <input type="radio"/> | <input type="radio"/> | <input type="radio"/> | <input type="radio"/> | <input type="radio"/> | <input type="radio"/> |
| ↗09-04 | Communication Protocol | 0: 7N1 (ASCII) 1: 7N2 (ASCII) 2: 7E1 (ASCII) 3: 7O1 (ASCII) 4: 7E2 (ASCII) 5: 7O2 (ASCII) 6: 8N1 (ASCII) 7: 8N2 (ASCII) 8: 8E1 (ASCII) 9: 8O1 (ASCII) 10: 8E2 (ASCII) 11: 8O2 (ASCII) 12: 8N1 (RTU) 13: 8N2 (RTU) 14: 8E1 (RTU) 15: 8O1 (RTU) 16: 8E2 (RTU) 17: 8O2 (RTU) | 13 | <input type="radio"/> | <input type="radio"/> | <input type="radio"/> | <input type="radio"/> | <input type="radio"/> | <input type="radio"/> |
| ↗09-05 | Response Delay Time | 0.0~200.0ms | 2.0 | <input type="radio"/> | <input type="radio"/> | <input type="radio"/> | <input type="radio"/> | <input type="radio"/> | <input type="radio"/> |

Group 10 Speed Feedback Control Parameters

| Pr. | Explanation | Settings | Factory Setting | VF | VPG | SVC | FOCPG | TOCPG | FOCPM |
|--------|---|---|-----------------|----|-----|-----|-------|-------|-------|
| 10-00 | PG Signal Type | 0: No function 1: ABZ 2: ABZ+Hall 3: SIN/COS+Sinusoidal 4: SIN/COS+Endat 5: SIN/COS 6: SIN/COS + Hiperface | 0 | | ○ | | ○ | ○ | ○ |
| 10-01 | Encoder Pulse | 1~20000 | 600 | | ○ | | ○ | ○ | ○ |
| 10-02 | Encoder Input Type Setting | 0: Disable 1: Phase A leads in a forward run command and phase B leads in a reverse run command 2: Phase B leads in a forward run command and phase A leads in a reverse run command 3: Phase A is a pulse input and phase B is a direction input. (low input=reverse direction, high input=forward direction) 4: Phase A is a pulse input and phase B is a direction input. (low input=forward direction, high input=reverse direction) 5: Single-phase input | 0 | | ○ | | ○ | ○ | ○ |
| ↗10-03 | Encoder Feedback Fault Treatment (PGF1, PGF2) | 0: Warn and keep operation 1: Warn and ramp to stop 2: Warn and stop operation | 2 | | ○ | | ○ | ○ | |
| ↗10-04 | Detection Time for Encoder Feedback Fault | 0.00~10.0 sec | 1.0 | | ○ | | ○ | ○ | ○ |
| ↗10-05 | Encoder Stall Level (PGF3) | 0~120% (0: disable) | 115 | | ○ | | ○ | ○ | ○ |
| ↗10-06 | Encoder Stall Detection Time | 0.0~2.0 sec | 0.1 | | ○ | | ○ | ○ | ○ |
| ↗10-07 | Encoder Slip Range (PGF4) | 0~50% (0: disable) | 50 | | ○ | | ○ | ○ | ○ |
| ↗10-08 | Encoder Slip Detection Time | 0.0~10.0 sec | 0.5 | | ○ | | ○ | ○ | ○ |
| ↗10-09 | Encoder Stall and Slip Error Treatment | 0: Warn and keep operation 1: Warn and ramp to stop 2: Warn and coast to stop | 2 | | | | | | ○ |
| 10-10 | Mode Selection for UVW Input | 0: Z signal is at the falling edge of U-phase 1: Z signal is at the rising edge of U-phase | 0 | | ○ | | ○ | ○ | ○ |
| ↗10-11 | ASR (Auto Speed Regulation) Control (P) of Zero Speed | 0.0~500.0% | 100.0 | ○ | ○ | ○ | ○ | ○ | ○ |
| ↗10-12 | ASR (Auto Speed Regulation) Control (I) of Zero Speed | 0.000~10.000 sec | 0.100 | ○ | ○ | ○ | ○ | ○ | ○ |
| ↗10-13 | ASR (Auto Speed Regulation) Control (P) 1 | 0.0~500.0% | 100.0 | ○ | ○ | ○ | ○ | ○ | ○ |
| ↗10-14 | ASR (Auto Speed Regulation) Control (I) 1 | 0.000~10.000 sec | 0.100 | ○ | ○ | ○ | ○ | ○ | ○ |
| ↗10-15 | ASR (Auto Speed Regulation) Control (P) 2 | 0.0~500.0% | 100.0 | ○ | ○ | ○ | ○ | ○ | ○ |
| ↗10-16 | ASR (Auto Speed Regulation) Control (I) 2 | 0.000~10.000 sec | 0.100 | ○ | ○ | ○ | ○ | ○ | ○ |
| ↗10-17 | ASR 1/ASR2 Switch Frequency | 0.00~120.00Hz (0: disable) | 7.00 | ○ | ○ | ○ | ○ | ○ | ○ |
| ↗10-18 | ASR Primary Low Pass Filter Gain | 0.000~0.350 sec | 0.008 | ○ | ○ | ○ | ○ | ○ | ○ |
| ↗10-19 | Zero Speed Gain (P) | 0~655.00%e | 80.00 | | | | | | ○ |
| ↗10-20 | Zero Speed/ASR1 Width Adjustment | 0.0~120.00Hz | 5.00 | | ○ | | ○ | ○ | ○ |
| ↗10-21 | ASR1/ASR2 Width Adjustment | 0.0~120.00Hz | 5.00 | | ○ | | ○ | ○ | ○ |
| ↗10-22 | Operation Time of Zero Speed | 0.000~65.535 sec | 0.250 | | | | | | ○ |
| ↗10-23 | Filter Time of Zero Speed | 0.000~65.535 sec | 0.004 | | | | | | ○ |
| ↗10-24 | Time for Executing Zero Speed | 0: after the brake release set in Pr.02-29 1: after the brake signal input (Pr.02-01~02-08 is set to 42) | 0 | | | | | | ○ |

Group 11 Advanced Parameters

| Pr. | Explanation | Settings | Factory Setting | VF | VFG | SVC | FOCPG | TOCPG | FOCPM |
|---------|--|---|-----------------|-----------------------|-----------------------|-----------------------|-----------------------|-----------------------|-----------------------|
| ↗ 11-00 | System Control | Bit 0=0: no function Bit 0=1: ASR Auto tuning, PDFF enable Bit 7=0: no function Bit 7=1: When position control is enabled, it doesn't need to set Pr.07-02 (DC Brake Current Level) Bit 15=0: when power is applied, it will detect the position of magnetic field again Bit 15=1: when power is applied, it will start from the magnetic field position of previous power failure | 0 | | | | <input type="radio"/> | | <input type="radio"/> |
| ↗ 11-01 | Elevator Speed | 0.10~3.00 m/s | 1.00 | | | | <input type="radio"/> | | <input type="radio"/> |
| ↗ 11-02 | Sheave Diameter | 100~2000 mm | 400 | | | | <input type="radio"/> | | <input type="radio"/> |
| ↗ 11-03 | Mechanical Gear Ratio | 1~100 | 1 | | | | <input type="radio"/> | | <input type="radio"/> |
| ↗ 11-04 | Suspension Ratio | 0: 1:1 1: 2:1 | 1 | | | | <input type="radio"/> | | <input type="radio"/> |
| ↗ 11-05 | Inertial Ratio | 1~300% | 40 | | | | <input type="radio"/> | | <input type="radio"/> |
| ↗ 11-06 | Zero-speed Bandwidth | 0~40Hz | 10 | | | | <input type="radio"/> | | <input type="radio"/> |
| ↗ 11-07 | Low-speed Bandwidth | 0~40Hz | 10 | | | | <input type="radio"/> | | <input type="radio"/> |
| ↗ 11-08 | High-speed Bandwidth | 0~40Hz | 10 | | | | <input type="radio"/> | | <input type="radio"/> |
| ↗ 11-09 | PDFF Gain Value | 0~200% | 30 | | | | <input type="radio"/> | | <input type="radio"/> |
| ↗ 11-10 | Gain for Speed Feed Forward | 0~500 | 0 | | | | <input type="radio"/> | | <input type="radio"/> |
| ↗ 11-11 | Notch Filter Depth | 0~20db | 0 | | | | <input type="radio"/> | | <input type="radio"/> |
| ↗ 11-12 | Notch Filter Frequency | 0.00~200.00Hz | 0.00 | | | | <input type="radio"/> | | <input type="radio"/> |
| ↗ 11-13 | Low-pass Filter Time of Keypad Display | 0.001~65.535s | 0.500 | <input type="radio"/> | <input type="radio"/> | <input type="radio"/> | <input type="radio"/> | <input type="radio"/> | <input type="radio"/> |
| ↗ 11-14 | Motor Current at Accel. | 50~200% | 150 | | | | | | <input type="radio"/> |
| ↗ 11-15 | Elevator Acceleration | 0.60~2.00m/s | 0.75 | | | | | | <input type="radio"/> |
| 11-16 | Reserved | | | | | | | | |
| 11-17 | Reserved | | | | | | | | |
| 11-18 | Reserved | | | | | | | | |

Group 12 User-defined Parameters

| Pr. | Explanation | Settings | Factory Setting | VF | VPPG | SVC | FOCPG | TOCPG | FOCPM |
|-----------------------|-------------------------|----------------------|-----------------|-----------------------|-----------------------|-----------------------|-----------------------|-----------------------|-----------------------|
| #12-00 #12-31 | User-defined Parameters | Pr.00-00 to Pr.11-18 | - | <input type="radio"/> | <input type="radio"/> | <input type="radio"/> | <input type="radio"/> | <input type="radio"/> | <input type="radio"/> |



Group 13 View User-defined Parameters

| Pr. | Explanation | Settings | Factory Setting | VF | VFPG | SVC | FOCPG | TOCPG | FOCFM |
|---------------------|------------------------------|----------------------|-----------------|-----------------------|-----------------------|-----------------------|-----------------------|-----------------------|-----------------------|
| 13-00 13-31 | View User-defined Parameters | Pr.00-00 to Pr.11-18 | - | <input type="radio"/> | <input type="radio"/> | <input type="radio"/> | <input type="radio"/> | <input type="radio"/> | <input type="radio"/> |

4.2 Description of Parameter Settings

Group 0 User Parameters *↗*: This parameter can be set during operation.

| | | | | | | | | |
|---------------------|---|------|-----------|-------|-------|-------|---------------------|--|
| 00-00 | Identity Code of the AC Motor Drive | | | | | | | |
| Control mode | VF | VFPG | SVC | FOCPG | TQCPG | FOCPM | Factory setting: ## | |
| | Settings | | Read Only | | | | | |
| 00-01 | Rated Current Display of the AC Motor Drive | | | | | | | |
| Control mode | VF | VFPG | SVC | FOCPG | TQCPG | FOCPM | Factory setting: ## | |
| | Settings | | Read Only | | | | | |

-  Pr. 00-00 displays the identity code of the AC motor drive. The capacity, rated current, rated voltage and the max. carrier frequency relate to the identity code. Users can use the following table to check how the rated current, rated voltage and max. carrier frequency of the AC motor drive correspond to the identity code.
-  Pr.00-01 displays the rated current of the AC motor drive. By reading this parameter the user can check if the AC motor drive is correct.

| | 230V Series | | | | | | | | |
|---|-------------|------|----|----|------|----|------|-----|--|
| kW | 5.5 | 7.5 | 11 | 15 | 18.5 | 22 | 30 | 37 | |
| HP | 7.5 | 10 | 15 | 20 | 25 | 30 | 40 | 50 | |
| Pr.00-00 | 12 | 14 | 16 | 18 | 20 | 22 | 24 | 26 | |
| Rated Output Current for General Purposes (A) | 21.9 | 27.1 | 41 | 53 | 70 | 79 | 120 | 146 | |
| Rated Output Current for Elevators (A) | 25 | 31 | 47 | 60 | 80 | 90 | 150 | 183 | |
| Max. Carrier Frequency | 15kHz | | | | | | 9kHz | | |

| | 460V Series | | | | | | | | | | |
|---|-------------|------|----|----|------|------|----|----|------|-----|-----|
| kW | 5.5 | 7.5 | 11 | 15 | 18.5 | 22 | 30 | 37 | 45 | 55 | 75 |
| HP | 7.5 | 10 | 15 | 20 | 25 | 30 | 40 | 50 | 60 | 75 | 100 |
| Pr.00-00 | 13 | 15 | 17 | 19 | 21 | 23 | 25 | 27 | 29 | 31 | 33 |
| Rated Output Current for General Purposes (A) | 12.3 | 15.8 | 21 | 27 | 34 | 41 | 60 | 73 | 91 | 110 | 150 |
| Rated Output Current for Elevators (A) | 14 | 18 | 24 | 31 | 39 | 47 | 75 | 91 | 113 | 138 | 188 |
| Max. Carrier Frequency | 15kHz | | | | | 9kHz | | | 6kHz | | |

00-02 Parameter Reset

| Control mode | VF | VFPG | SVC | FOCPG | TQCPG | FOCPM | Factory setting: 0 |
|--------------|----|------|-----|-------|-------|-------|--------------------|
|--------------|----|------|-----|-------|-------|-------|--------------------|

| | | | | | | | |
|----------|----|--|--|--|--|--|--|
| Settings | 0 | No Function | | | | | |
| | 1 | Read Only | | | | | |
| | 8 | Keypad Lock | | | | | |
| | 9 | All parameters are reset to factory settings (50Hz, 220V/380V) | | | | | |
| | 10 | All parameters are reset to factory settings (60Hz, 220V/440V) | | | | | |

 When it is set to 1, all parameters are read only except Pr.00-00~00-07 and it can be used with password setting for password protection.

 This parameter allows the user to reset all parameters to the factory settings except the fault records (Pr.06-16 ~ Pr.06-21).

50Hz: Pr.01-01 is set to 50Hz and Pr.01-02 is set to 230V or 400V.

60Hz: Pr.01-01 is set to 60Hz and Pr.01-02 is set to 230Vor 460V.

 When Pr.00-02=08, the KPVL-CC01 keypad is locked and only Pr.00-02 can be set. To unlock the keypad, set Pr.00-02=00.

 When Pr.00-02 is set to 1, Pr.00-02 setting should be set to 0 before setting to other setting.

00-03  Start-up Display Selection

| Control mode | VF | VFPG | SVC | FOCPG | TQCPG | FOCPM | Factory setting: 0 |
|--------------|----|------|-----|-------|-------|-------|--------------------|
|--------------|----|------|-----|-------|-------|-------|--------------------|

| | | | | | | | |
|----------|---|--|--|--|--|--|--|
| Settings | 0 | Display the frequency command value. (LED F) | | | | | |
| | 1 | Display the actual output frequency (LED H) | | | | | |
| | 2 | DC BUS voltage | | | | | |
| | 3 | Display the output current (A) | | | | | |
| | 4 | Output voltage | | | | | |
| | 5 | Multifunction display, see Pr.00-04 | | | | | |

 This parameter determines the start-up display page after power is applied to the drive.

00-04  Content of Multi-Function Display

| Control mode | VF | VFPG | SVC | FOCPG | TQCPG | FOCPM | Factory setting: 0 |
|--------------|----|------|-----|-------|-------|-------|--------------------|
|--------------|----|------|-----|-------|-------|-------|--------------------|

| | | | | | | | |
|----------|---|---|--|--|--|--|--|
| Settings | 0 | Display the output current in A supplied to the motor | | | | | |
| | 1 | Reserved | | | | | |

| | |
|-------------------|---------|
| U: Output Current | 0.0Amps |
|-------------------|---------|

| | | |
|----|---|--------------------------------|
| 2 | Display actual output frequency (H) | U: Actual Freq. Se 0.00Hz |
| 3 | Display the actual DC BUS voltage in VDC of the AC motor drive | U: DC BUS Se 255.3Vot |
| 4 | Display the output voltage in VAC of terminals U, V, W to the motor. | U: Output Voltage Se 0.0Vot |
| 5 | Display the power factor angle in ° of terminals U, V, W to the motor. | U: Power Angle Se 0.0deg |
| 6 | Display the output power in kW of terminals U, V and W to the motor. | U: Output Power Se 0.000KW |
| 7 | Display the actual motor speed in rpm (enabled when using with PG card). | U: Motor Speed Se 0RPM |
| 8 | Display the estimated value of torque in kg-m as it relates to current. | U: Torque Se 0.0NT - M |
| 9 | Display PG position | U: PG Feedback Se 1567 |
| 10 | Reserved | |
| 11 | Display the signal of AUI1 analog input terminal in %. Range 0~10V corresponds to 0~100%. (1.) | U: AUI 1 Se 0.3% |
| 12 | Display the signal of ACI analog input terminal in %. Range 4~20mA/0~10V corresponds to 0~100%. (2.) | U: ACI Se 0.0% |
| 13 | Display the signal of AUI2 analog input terminal in %. Range -10V~10V corresponds to 0~100%. (3.) | U: AUI 2 Se 0.3% |
| 14 | Display the temperature of heat sink (°C) | U: Heat Sink Se 0.0 C |
| 15 | Display the temperature of IGBT in °C. | U: IGBT Temp Se 41.3 C |
| 16 | Display digital input status ON/OFF (i) | U: DI ON/OFF St at Se 0000 |
| 17 | Display digital output status ON/OFF (o) | U: DO ON/OFF St at Se 0000 |
| 18 | Display multi-step speed | U: Multi-Speed Se 0 |
| 19 | The corresponding CPU pin status of digital input (i.) | U: DI Pin Status Se FFFF |

00-04 / Content of Multi-Function Display

20 The corresponding CPU pin status of digital output (o.)

U: DO Pin Status
Sa FFFF

21
| Reserved
23

24 Output AC voltage when malfunction (8)

U: Error Vout
Sa 0.0Vac

25 Output DC voltage when malfunction (8.)

U: Error Vbus
Sa 256.4Vdc

26 Output frequency when malfunction (h)

U: Error Fout
Sa 0.00Hz

27 Output current when malfunction (4)

U: Error Current
Sa 0.00Amps

28 Output frequency command when malfunction (h.)

U: Error Fcmd
Sa 0.00Amps

It is used to display the content when LED U is ON. It is helpful for getting the AC motor drive's status by this parameter.

U: DI ON/ OFF St at
Sa 0086

| Terminal | MI8 | MI7 | MI6 | MI5 | MI4 | MI3 | MI2 | MI1 | REV | FWD |
|----------|-----|-----|-----|-----|-----|-----|-----|-----|-----|-----|
| Status | 0 | 0 | 1 | 0 | 0 | 0 | 0 | 1 | 1 | 0 |

0: OFF, 1: ON

MI1: Pr.02-01 is set to 1 (multi-step speed command 1)

MI8: Pr.02-08 is set to 8 (the 1st, 2nd acceleration/deceleration time selection)

If REV, MI1 and MI8 are ON, the value is 0000 0000 1000 0110₂ in binary and 0086H in HEX.

At the meanwhile, if Pr.00-04 is set to "14" or "17", it will display "0086" with LED U is ON on the keypad KPVL-CC01. The setting 14 is the status of digital input and the setting 17 is the corresponding CPU pin status of digital input. User can set to 14 to monitor digital input status and then set to 17 to check if the wire is normal.

U: DO ON/ OFF St at
Sa 0001

| Terminal | MO10 | MO9 | MO8 | MO7 | MO6 | MO5 | MO4 | MO3 | MO2 | MO1 | MRA | RA | MO10 |
|----------|------|-----|-----|-----|-----|-----|-----|-----|-----|-----|-----|----|------|
| Status | 0 | 0 | 0 | 0 | 1 | 0 | 0 | 0 | 0 | 1 | 1 | 0 | 0 |

RA: Pr.02-11 is set to 9 (Drive ready).

After applying the power to the AC motor drive, if there is no other abnormal status, the contact will be ON. At the meanwhile, if Pr.00-04 is set to 15 or 18, it will display 0001 with LED U is ON on the keypad. The setting 15 is the status of digital output and the setting 18 is the corresponding CPU pin status of digital output. User can set 15 to monitor the digital output status and then set to 18 to check if the wire is normal.

00-05 \swarrow User Defined Coefficient K

| Control mode | VF | VFPG | SVC | FOCPG | TQCPG | FOCPM | Factory setting: 0 |
|--------------|----|------|--|-------|-------|-------|--------------------|
| Settings | | | Digit 4: decimal point number (0 to 3) | | | | |
| | | | Digit 0-3: 40 to 9999 | | | | |

It is used digital setting method

Digital 4: decimal point number (0: no decimal point, 1: 1 decimal point and so on.)

Digit 0-3: 40 to 9999 (the corresponding value for the max. frequency).

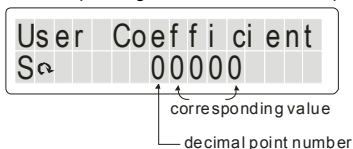

For example, if use uses rpm to display the motor speed and the corresponding value to the 4-pole motor 60Hz is 1800. This parameter can be set to 01800 to indicate that the corresponding value for 60Hz is 1800rpm. If the unit is rps, it can be set 10300 to indicate the corresponding value for 60Hz is 30.0 (a decimal point).

Only frequency setting can be displayed by the corresponding value.



After setting Pr.00-05, it won't display the unit of frequency "Hz" after returning to the main menu.

00-06 Software Version

| Control mode | VF | VFPG | SVC | FOCPG | TQCPG | FOCPM | Factory setting: Read Only |
|--------------|----|------|-----------|-------|-------|-------|----------------------------|
| Settings | | | Read Only | | | | |
| Display | | | ### | | | | |

| 00-07 | | Password Input | | | | | Unit: 1 |
|--------------|----------|-------------------------------|-----|-------|-------|-------|--------------------|
| Control mode | VF | VFPG | SVC | FOCPG | TQCPG | FOCPM | Factory setting: 0 |
| | Settings | 1 to 9998 and 10000 to 65535 | | | | | |
| | Display | 0~2 (times of wrong password) | | | | | |

 The function of this parameter is to input the password that is set in Pr.00-08. Input the correct password here to enable changing parameters. You are limited to a maximum of 3 attempts. After 3 consecutive failed attempts, a fault code "Password Error" will show up to force the user to restart the AC motor drive in order to try again to input the correct password.

 When forgetting password, you can decode by setting 9999 and press button  twice. Please note that all the settings will be set to factory setting.

| 00-08 | | Password Set | | | | | Unit: 1 |
|--------------|----------|------------------------------|--|-------|-------|-------|--------------------|
| Control mode | VF | VFPG | SVC | FOCPG | TQCPG | FOCPM | Factory setting: 0 |
| | Settings | 1 to 9998 and 10000 to 65535 | | | | | |
| | Display | 0 | No password set or successful input in Pr. 00-07 | | | | |
| | | 1 | Password has been set | | | | |

 To set a password to protect your parameter settings. If the display shows 0, no password is set or password has been correctly entered in Pr.00-07. All parameters can then be changed, including Pr.00-08. The first time you can set a password directly. After successful setting of password the display will show 1.

Be sure to record the password for later use.

To cancel the parameter lock, set the parameter to 0 after inputting correct password into Pr. 00-07.

The password consists of min. 2 digits and max. 5 digits.

 How to make the password valid again after decoding by Pr.00-07:

Method 1: Re-input original password into Pr.00-08 (Or you can enter a new password if you want to use a changed or new one).

Method 2: After rebooting, password function will be recovered.

Password Decode Flow Chart

Password Setting

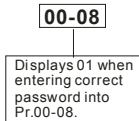

Decoding Flow Chart

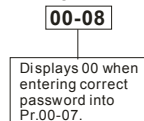

Forgetting Password

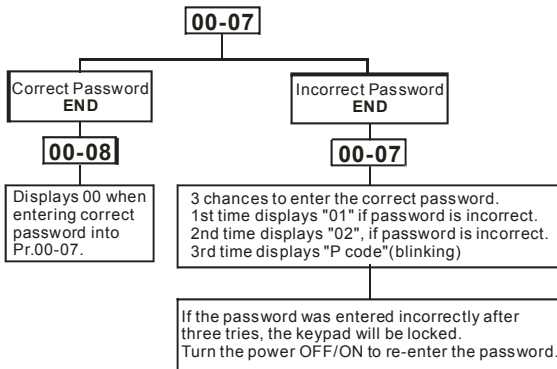
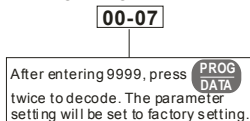

00-09

Control Method

Control mode

VF VFPG SVC FOCPG TQCPG FOCPM

Factory Setting: 0

| | | |
|----------|---|--------------------------------------|
| Settings | 0 | V/f control |
| | 1 | V/f + Encoder (VFPG) |
| | 2 | Sensorless vector control (SVC) |
| | 3 | FOC vector control + Encoder (FOCPG) |
| | 4 | Torque control + Encoder (TQCPG) |
| | 8 | FOC PM control (FOCPM) |

 This parameter determines the control method of the AC motor drive:

Setting 0: user can design V/f ratio by requirement and control multiple motors simultaneously.

Setting 1: User can use PG card with Encoder to do close-loop speed control.

Setting 2: To have optimal control characteristic by auto-tuning.

Setting 3: To increase torque and control speed precisely. (1:1000)

Setting 4: To increase accuracy for torque control.

Setting 8: To increase torque and control speed precisely. (1:1000). This setting is only for using with permanent magnet motor and others are for induction motor.

00-10 Reserved

00-11 Reserved

00-12  Carrier Frequency

Unit: 1

Control mode VF VFPG SVC FOC PG TQCPG FOC PM

Factory setting: 12

Settings 2~15KHz

 This parameter determinates the PWM carrier frequency of the AC motor drive.

| 230V/460V Series | | | | |
|------------------|----------------------|--------------------|---------------------|---------------------|
| Models | 7.5-15HP 5.5-11kW | 20-30HP 15-22kW | 40-60 HP 30-45kW | 40-100HP 30-75kW |
| Setting Range | 2~15kHz | 2~15kHz | 02-09kHz | 02~15kHz |
| Factory Setting | 12kHz | 9kHz | 6kHz | 6kHz |

| Carrier Frequency | Acoustic Noise | Electromagnetic Noise or Leakage Current | Heat Dissipation | Current Wave |
|-------------------|-----------------------------|--|-----------------------------|---|
| 2kHz | Significant ↓ Minimal | Minimal ↓ Significant | Minimal ↓ Significant |  |
| 8kHz | | | | |
| 15kHz | | | | |

 From the table, we see that the PWM carrier frequency has a significant influence on the electromagnetic noise, AC motor drive heat dissipation, and motor acoustic noise.

00-13  Auto Voltage Regulation (AVR) Function

Control mode VF VFPG SVC FOC PG TQCPG FOC PM

Factory setting: 0

Settings 0 Enable AVR
1 Disable AVR
2 Disable AVR when deceleration stop

 It is used to select the AVR mode. AVR is used to regulate the output voltage to the motor. For example, if V/f curve is set to AC200V/50Hz and the input voltage is from 200 to 264VAC, the output voltage won't excess AC200V/50Hz. If the input voltage is from 180 to 200V, the output voltage to the motor and the input voltage will be in direct proportion.

 When setting Pr.00-13 to 1 during ramp to stop and used with auto accel./decel. function, the acceleration will be smoother and faster.

00-14 / Source of the Master Frequency Command

| Control mode | VF | VFPG | SVC | FOCPG | FOCPM | Factory setting: 1 |
|--------------|----|------|---|-------|-------|--------------------|
| Settings | | 1 | RS-485 serial communication or digital keypad (KPVL-CC01) | | | |
| | | 2 | External analog input (Pr. 03-00) | | | |
| | | 3 | Digital terminals input (Pr.04-00~04-15) | | | |

 This parameter determines the drive's master frequency source.

00-15 / Source of the Operation Command

| Control mode | VF | VFPG | SVC | FOCPG | TQCPG | FOCPM | Factory setting: 1 |
|--------------|----|------|---|-------|-------|-------|--------------------|
| Settings | | 1 | External terminals | | | | |
| | | 2 | RS-485 serial communication or digital keypad (KPVL-CC01) | | | | |

 VFD-VL series is shipped without digital keypad and users can use external terminals or RS-485 to control the operation command.



 When the LED PU is light, the operation command can be controlled by the optional digital keypad (KPVL-CC01). Refer to appendix B for details.

Group 1 Basic Parameters



| | | | | | | | |
|---------------------|--------------------------|-------------|-------------------|--------------|--------------|--------------|------------------------------|
| 01-00 | Maximum Output Frequency | | | | | | Unit: 0.01 |
| Control mode | VF | VFPG | SVC | FOCPG | TQCPG | FOCPM | Factory setting: 60.00/50.00 |
| | Settings | | 10.00 to 120.00Hz | | | | |

-  This parameter determines the AC motor drive's Maximum Output Frequency. All the AC motor drive frequency command sources (analog inputs 0 to +10V, 4 to 20mA and -10V to +10V) are scaled to correspond to the output frequency range.

| | | | | | | | |
|---------------------|------------------------------|-------------|---------------|--------------|--------------|--------------|------------------------------|
| 01-01 | 1st Output Frequency Setting | | | | | | Unit: 0.01 |
| Control mode | VF | VFPG | SVC | FOCPG | TQCPG | FOCPM | Factory setting: 60.00/50.00 |
| | Settings | | 0.00~120.00Hz | | | | |

-  It is for the base frequency and motor rated frequency.
-  This value should be set according to the rated frequency of the motor as indicated on the motor nameplate. If the motor is 60Hz, the setting should be 60Hz. If the motor is 50Hz, it should be set to 50Hz.

| | | | | | | | |
|---------------------|----------------------------|-------------|---------------|--------------|--------------|--------------|------------------------|
| 01-02 | 1st Output Voltage Setting | | | | | | Unit: 0.1 |
| Control mode | VF | VFPG | SVC | FOCPG | TQCPG | FOCPM | |
| | Settings | 230V series | 0.1 to 255.0V | | | | Factory Setting: 220.0 |
| | | 460V series | 0.1 to 510.0V | | | | Factory Setting: 440.0 |

-  It is for the base frequency and motor rated frequency.
-  This value should be set according to the rated voltage of the motor as indicated on the motor nameplate. If the motor is 220V, the setting should be 220.0. If the motor is 200V, it should be set to 200.0.
-  There are many motor types in the market and the power system for each country is also difference. The economic and convenience method to solve this problem is to install the AC motor drive. There is no problem to use with the different voltage and frequency and also can amplify the original characteristic and life of the motor.

| | | | | | | | |
|---------------------|------------------------------|-------------|---------------|--|--|--|-----------------------|
| 01-03 | 2nd Output Frequency Setting | | | | | | Unit: 0.01 |
| Control mode | VF | VFPG | | | | | Factory setting: 0.50 |
| | Settings | | 0.00~120.00Hz | | | | |

| | | | | | |
|---------------------|------------------------------|-----------------------|-----------------------|-----------------------|--------------|
| 01-04 | ↗ 2nd Output Voltage Setting | | | | Unit: 0.1 |
| Control mode | VF | VFPG | | | |
| | Settings | 230V series | 0.1 to 255.0V | Factory Setting: 5.0 | |
| | | 460V series | 0.1 to 510.0V | Factory Setting: 10.0 | |
| 01-05 | 3rd Output Frequency Setting | | | | Unit: 0.01 |
| Control mode | VF | VFPG | Factory setting: 0.50 | | |
| | Settings | 0.00~120.00Hz | | | |
| 01-06 | ↗ 3rd Output Voltage Setting | | | | Unit: 0.1 |
| Control mode | VF | VFPG | | | |
| | Settings | 230V series | 0.1 to 255.0V | Factory Setting: 5.0 | |
| | | 460V series | 0.1 to 510.0V | Factory Setting: 10.0 | |
| 01-07 | 4th Output Frequency Setting | | | | Unit: 0.01 |
| Control mode | VF | VFPG | SVC | FOCPG | TQCPG |
| | Settings | 0.00~120.00Hz | | | |
| | | Factory Setting: 0.00 | | | |
| 01-08 | ↗ 4th Output Voltage Setting | | | | Unit: 0.1 |
| Control mode | VF | VFPG | | | |
| | Settings | 230V series | 0.1 to 255.0V | Factory Setting: 0.0 | |
| | | 460V series | 0.1 to 510.0V | Factory Setting: 0.0 | |

 V/f curve setting is usually set by the motor's allowable loading characteristics. Pay special attention to the motor's heat dissipation, dynamic balance, and bearing lubricity, if the loading characteristics exceed the loading limit of the motor.

 For the V/f curve setting, it should be $Pr.01-01 \geq Pr.01-03 \geq Pr.01-05 \geq Pr.01-07$. There is no limit for the voltage setting, but a high voltage at the low frequency may cause motor damage, overheat, stall prevention or over-current protection. Therefore, please use the low voltage at the low frequency to prevent motor damage.

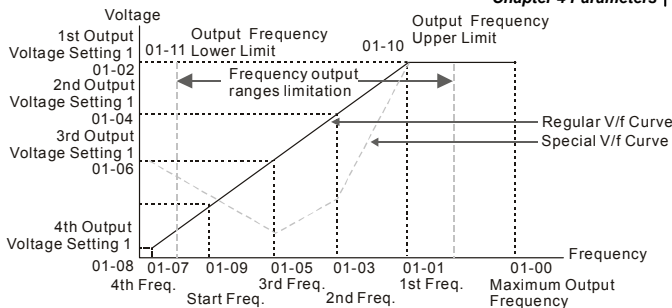
**V/f Curve**

| | | |
|--------------|------------------------|------------|
| 01-09 | Start Frequency | Unit: 0.01 |
|--------------|------------------------|------------|

| | | | | | |
|---------------------|-----------|-------------|------------|--------------|-----------------------|
| Control mode | VF | VFPG | SVC | FOCPG | Factory setting: 0.50 |
|---------------------|-----------|-------------|------------|--------------|-----------------------|

| | |
|-----------------|---------------|
| Settings | 0.00~120.00Hz |
|-----------------|---------------|

To distinguish which frequency should be start frequency, it needs to compare the value of min.

output frequency and start frequency. The larger value will be start frequency.

When min. output frequency > start frequency

When start frequency > min. output frequency



| | | |
|--------------|-------------------------------------|------------|
| 01-10 | Output Frequency Upper Limit | Unit: 0.01 |
|--------------|-------------------------------------|------------|

| | | | | | | |
|---------------------|-----------|-------------|------------|--------------|--------------|-------------------------|
| Control mode | VF | VFPG | SVC | FOCPG | FOCPM | Factory setting: 120.00 |
|---------------------|-----------|-------------|------------|--------------|--------------|-------------------------|

| | |
|-----------------|---------------|
| Settings | 0.00~120.00Hz |
|-----------------|---------------|

| | | |
|--------------|-------------------------------------|------------|
| 01-11 | Output Frequency Lower Limit | Unit: 0.01 |
|--------------|-------------------------------------|------------|

| | | | | | | |
|---------------------|-----------|-------------|------------|--------------|--------------|-----------------------|
| Control mode | VF | VFPG | SVC | FOCPG | FOCPM | Factory setting: 0.00 |
|---------------------|-----------|-------------|------------|--------------|--------------|-----------------------|

| | |
|-----------------|---------------|
| Settings | 0.00~120.00Hz |
|-----------------|---------------|

The upper/lower output frequency setting is used to limit the actual output frequency. If the frequency setting is lower than the start-up frequency, it will run with zero speed. If the frequency setting is higher than the upper limit, it will run with the upper limit frequency. If output frequency lower limit > output frequency upper limit, this function is invalid.

| | | |
|--------------|-----------------|------------|
| 01-12 | ↗ Accel. Time 1 | Unit: 0.01 |
| 01-14 | ↗ Accel. Time 2 | Unit: 0.01 |
| 01-16 | ↗ Accel. Time 3 | Unit: 0.01 |
| 01-18 | ↗ Accel. Time 4 | Unit: 0.01 |





| | | | | | | |
|---------------------|-----------|-------------|------------|--------------|--------------|-----------------------|
| Control mode | VF | VFPG | SVC | FOCPG | FOCPM | Factory setting: 3.00 |
| | Settings | | | | | 0.00~600.00 sec |

| | | |
|--------------|-----------------|------------|
| 01-13 | ↗ Decel. Time 1 | Unit: 0.01 |
| 01-15 | ↗ Decel. Time 2 | Unit: 0.01 |
| 01-17 | ↗ Decel. Time 3 | Unit: 0.01 |
| 01-19 | ↗ Decel. Time 4 | Unit: 0.01 |

| | | | | | | |
|---------------------|-----------|-------------|------------|--------------|--------------|-----------------------|
| Control mode | VF | VFPG | SVC | FOCPG | FOCPM | Factory setting: 2.00 |
| | Settings | | | | | 0.00~600.00 sec |

| | | |
|--------------|-------------------------|------------|
| 01-20 | ↗ JOG Acceleration Time | Unit: 0.01 |
| 01-21 | ↗ JOG Deceleration Time | Unit: 0.01 |

| | | | | | | |
|---------------------|-----------|-------------|------------|--------------|--------------|-----------------------|
| Control mode | VF | VFPG | SVC | FOCPG | FOCPM | Factory setting: 1.00 |
| | Settings | | | | | 0.00~600.00 sec |

-  The Acceleration Time is used to determine the time required for the AC motor drive to ramp from 0Hz to Maximum Output Frequency (Pr.01-00).
-  The Deceleration Time is used to determine the time require for the AC motor drive to decelerate from the Maximum Output Frequency (Pr.01-00) down to 0Hz.
-  The Acceleration/Deceleration Time 1, 2, 3, 4 are selected according to the Multi-function Input Terminals settings. The factory settings are acceleration time 1 and deceleration time 1.
-  The larger against torque and inertia torque of the load and the accel./decel. time setting is less than the necessary value, it will enable torque limit and stall prevention function. When it happens, actual accel./decel. time will be longer than the action above.

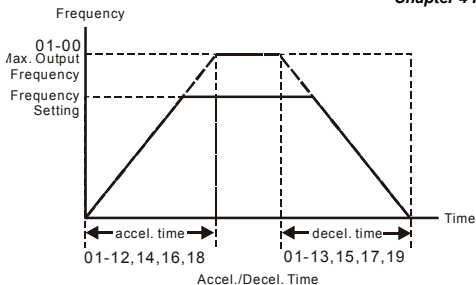
**01-22** JOG Frequency

Unit: 0.01

| Control mode | VF | VFGP | SVC | FOCPG | TQCPG | FOCPM |
|--------------|----|------|-----|-------|-------|-------|
| | | | | | | |

Factory setting: 6.00

Settings 0.00~120.00Hz

- 📖 Both external terminal JOG and key "JOG" on the keypad can be used. When the jog command is ON, the AC motor drive will accelerate from 0Hz to jog frequency (Pr.01-22). When the jog command is OFF, the AC motor drive will decelerate from Jog Frequency to zero. The used Accel./Decel. time is set by the Jog Accel./Decel. time (Pr.01-20, Pr.01-21).
- 📖 The JOG command can't be executed when the AC motor drive is running. In the same way, when the JOG command is executing, other operation commands are invalid except forward/reverse commands and STOP key on the digital keypad.

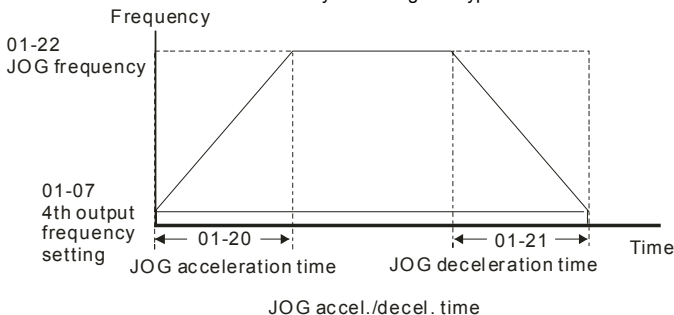

**01-23** Switch Frequency between 1st/4th Accel/decel

Unit: 0.01

| Control mode | VF | VFGP | SVC | FOCPG | FOCPM |
|--------------|----|------|-----|-------|-------|
| | | | | | |

Factory setting: 0.00

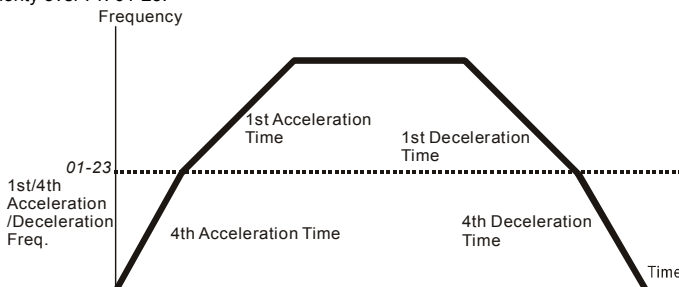

Settings 0.00~120.00Hz

-  This parameter selects the frequency point for transition from acceleration/deceleration time 1 to acceleration/deceleration time 4.
-  The transition from acceleration/deceleration time 1 to acceleration/deceleration time 4, may also be enabled by the external terminals (Pr. 02-01 to 02-08). The external terminal has priority over Pr. 01-23.



1st/4th Acceleration/Deceleration Switching

| | | | | | | |
|---------------------|--|-------------|------------|--------------|--------------|-----------------------|
| 01-24 | ↗ S-curve for Acceleration Departure Time S1 | | | | | Unit: 0.01 |
| 01-25 | ↗ S-curve for Acceleration Arrival Time S2 | | | | | Unit: 0.01 |
| Control mode | VF | VFPG | SVC | FOCPG | FOCPM | Factory setting: 1.00 |
| Settings | 0.00~25.00 sec | | | | | |
| 01-26 | ↘ S-curve for Deceleration Departure Time S3 | | | | | Unit: 0.01 |
| 01-27 | ↘ S-curve for Deceleration Arrival Time S4 | | | | | Unit: 0.01 |
| 01-30 | ↘ S-curve for Deceleration Arrival Time S5 | | | | | Unit: 0.01 |
| Control mode | VF | VFPG | SVC | FOCPG | FOCPM | Factory setting: 1.00 |
| Settings | 0.00~25.00 sec | | | | | |

-  It is used to give the smoothest transition between speed changes. The accel./decel. curve can adjust the S-curve of the accel./decel. When it is enabled, the drive will have different accel./decel. curve by the accel./decel. time.
-  The Actual Accel. Time = selected accel. Time + (Pr.01-24 + Pr.01-25)/2
The Actual Decel. Time = selected decel. Time + (Pr.01-26 + Pr.01-27 + Pr.01-30*2)/2

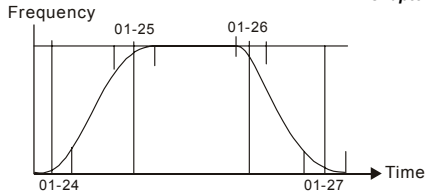

01-29 **Switch Frequency for S3/S4 Changes to S5** Unit: 0.01

Control mode VF VFPG SVC FOC PG FOC PM Factory setting: 0.00

Settings 0.00~120.00Hz

It is used to set the switch frequency between S4 and S5 for smooth stop.

It is recommended to set this parameter to the leveling speed of elevator.

Frequency

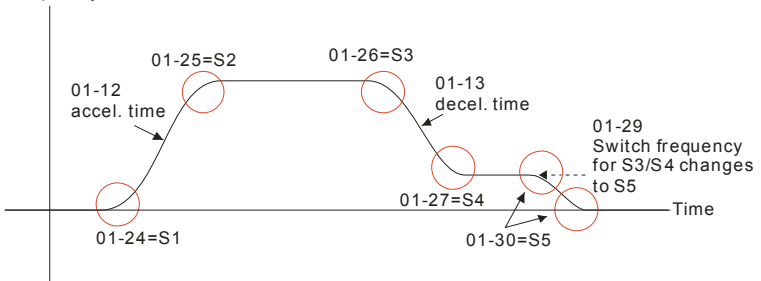

01-28 **Mode Selection when Frequency < Fmin**

Control mode VF VFPG SVC Factory setting: 0

Settings 0 Output Waiting
1 Zero-speed operation
2 Fmin (4th output frequency setting)

When the AC motor drive is at 0Hz, it will operate by this parameter.

When it is set to 1 or 2, voltage will be output by Fmin corresponding output voltage.

01-31 **Deceleration Time when Operating without RUN Command**

Unit: 0.01

Control mode VF VFPG SVC FOC PG FOC PM Factory setting: 2.00

Settings 0.00~600.00 Sec

-  The AC motor drive will stop by the setting of this parameter when canceling RUN command.
Refer to the figure in Pr.01-29 for details.

Group 2 Digital Input/Output Parameters

02-00 2-wire/3-wire Operation Control

| Control mode | VF | VFPG | SVC | FOCPG | TQCPG | FOCPM | Factory setting: 0 |
|--------------|----|------|---|-------|-------|-------|--------------------|
| Settings | | 0 | FWD/STOP, REV/STOP | | | | |
| | | 1 | FWD/STOP, REV/STOP (Line Start Lockout) | | | | |
| | | 2 | RUN/STOP, REV/FWD | | | | |
| | | 3 | RUN/STOP, REV/FWD (Line Start Lockout) | | | | |
| | | 4 | 3-wire | | | | |
| | | 5 | 3-wire (Line Start Lockout) | | | | |

Three of the six methods include a "Line Start Lockout" feature. When line start lockout is enabled, the drive will not run once applying the power. The Line Start Lockout feature doesn't guarantee the motor will never start under this condition. It is possible the motor may be set in motion by a malfunctioning switch.

This parameter is used to control operation from external terminals. There are three different control modes.

| 02-00 | Control Circuits of the External Terminal |
|--|---|
| 0, 1 2-wire operation control (1) FWD/STOP REV/STOP | |
| 2, 3 2-wire operation control (2) RUN/STOP REV/FWD | |
| 4, 5 3-wire operation control | |



02-01 Multi-Function Input Command 1 (MI1)
(it is Stop terminal for 3-wire operation)

Factory Setting: 1

| | | |
|--------------|--|--------------------|
| 02-02 | Multi-Function Input Command 2 (MI2) | Factory Setting: 2 |
| 02-03 | Multi-Function Input Command 3 (MI3) | Factory Setting: 3 |
| 02-04 | Multi-Function Input Command 4 (MI4) | Factory Setting: 4 |
| 02-05 | Multi-Function Input Command 5 (MI5) | Factory Setting: 0 |
| 02-06 | Multi-Function Input Command 6 (MI6) | Factory Setting: 0 |
| 02-07 | Multi-Function Input Command 7 (MI7) | Factory Setting: 0 |
| 02-08 | Multi-Function Input Command 8 (MI8) (specific terminal for Enable) | Factory Setting: 0 |
| Settings | 0-43 | |

| Settings | Control Mode | | | | | |
|--|--------------------------|--------------------------|--------------------------|--------------------------|--------------------------|--------------------------|
| | VF | VFPG | SVC | FOCPG | TQCPG | FOCPM |
| 0: no function | <input type="checkbox"/> | <input type="checkbox"/> | <input type="checkbox"/> | <input type="checkbox"/> | <input type="checkbox"/> | <input type="checkbox"/> |
| 1: multi-step speed command 1 | <input type="checkbox"/> | <input type="checkbox"/> | <input type="checkbox"/> | <input type="checkbox"/> | <input type="checkbox"/> | <input type="checkbox"/> |
| 2: multi-step speed command 2 | <input type="checkbox"/> | <input type="checkbox"/> | <input type="checkbox"/> | <input type="checkbox"/> | <input type="checkbox"/> | <input type="checkbox"/> |
| 3: multi-step speed command 3 | <input type="checkbox"/> | <input type="checkbox"/> | <input type="checkbox"/> | <input type="checkbox"/> | <input type="checkbox"/> | <input type="checkbox"/> |
| 4: multi-step speed command 4 | <input type="checkbox"/> | <input type="checkbox"/> | <input type="checkbox"/> | <input type="checkbox"/> | <input type="checkbox"/> | <input type="checkbox"/> |
| 5: Reset | <input type="checkbox"/> | <input type="checkbox"/> | <input type="checkbox"/> | <input type="checkbox"/> | <input type="checkbox"/> | <input type="checkbox"/> |
| 6: JOG command | <input type="checkbox"/> | <input type="checkbox"/> | <input type="checkbox"/> | <input type="checkbox"/> | <input type="checkbox"/> | <input type="checkbox"/> |
| 7: acceleration/deceleration speed inhibit | <input type="checkbox"/> | <input type="checkbox"/> | <input type="checkbox"/> | <input type="checkbox"/> | <input type="checkbox"/> | <input type="checkbox"/> |
| 8: the 1st, 2nd acceleration/deceleration time selection | <input type="checkbox"/> | <input type="checkbox"/> | <input type="checkbox"/> | <input type="checkbox"/> | <input type="checkbox"/> | <input type="checkbox"/> |
| 9: the 3rd, 4th acceleration/deceleration time selection | <input type="checkbox"/> | <input type="checkbox"/> | <input type="checkbox"/> | <input type="checkbox"/> | <input type="checkbox"/> | <input type="checkbox"/> |
| 10: EF input (07-28) | <input type="checkbox"/> | <input type="checkbox"/> | <input type="checkbox"/> | <input type="checkbox"/> | <input type="checkbox"/> | <input type="checkbox"/> |
| 11: Reserved | | | | | | |
| 12: Stop output | <input type="checkbox"/> | <input type="checkbox"/> | <input type="checkbox"/> | <input type="checkbox"/> | <input type="checkbox"/> | <input type="checkbox"/> |
| 13: Disable auto accel./decel. function | <input type="checkbox"/> | <input type="checkbox"/> | <input type="checkbox"/> | <input type="checkbox"/> | <input type="checkbox"/> | <input type="checkbox"/> |
| 14: Reserved | | | | | | |
| 15: operation speed command form AUI1 | <input type="checkbox"/> | <input type="checkbox"/> | <input type="checkbox"/> | <input type="checkbox"/> | <input type="checkbox"/> | <input type="checkbox"/> |
| 16: operation speed command form ACI | <input type="checkbox"/> | <input type="checkbox"/> | <input type="checkbox"/> | <input type="checkbox"/> | <input type="checkbox"/> | <input type="checkbox"/> |
| 17: operation speed command form AUI2 | <input type="checkbox"/> | <input type="checkbox"/> | <input type="checkbox"/> | <input type="checkbox"/> | <input type="checkbox"/> | <input type="checkbox"/> |
| 18: Emergency Stop (07-28) | <input type="checkbox"/> | <input type="checkbox"/> | <input type="checkbox"/> | <input type="checkbox"/> | <input type="checkbox"/> | <input type="checkbox"/> |
| 19-23: Reserved | | | | | | |
| 24: FWD JOG command | <input type="checkbox"/> | <input type="checkbox"/> | <input type="checkbox"/> | <input type="checkbox"/> | <input type="checkbox"/> | <input type="checkbox"/> |
| 25: REV JOG command | <input type="checkbox"/> | <input type="checkbox"/> | <input type="checkbox"/> | <input type="checkbox"/> | <input type="checkbox"/> | <input type="checkbox"/> |
| 26: Reserved | | | | | | |
| 27: ASR1/ASR2 selection | <input type="checkbox"/> | <input type="checkbox"/> | <input type="checkbox"/> | <input type="checkbox"/> | <input type="checkbox"/> | <input type="checkbox"/> |
| 28: Emergency stop (EF1) (Motor coasts to stop) | <input type="checkbox"/> | <input type="checkbox"/> | <input type="checkbox"/> | <input type="checkbox"/> | <input type="checkbox"/> | <input type="checkbox"/> |
| 29-30: Reserved | | | | | | |
| 31: High torque bias (by Pr.07-21) | <input type="checkbox"/> | <input type="checkbox"/> | <input type="checkbox"/> | <input type="checkbox"/> | <input type="checkbox"/> | <input type="checkbox"/> |

| Settings | Control Mode | | | | | |
|--------------------------------------|-----------------------|-----------------------|-----------------------|-----------------------|-----------------------|-----------------------|
| | VF | VFP | SVC | FOCPG | TQCPG | FOCPM |
| 32: Middle torque bias (by Pr.07-22) | <input type="radio"/> | <input type="radio"/> | <input type="radio"/> | <input type="radio"/> | <input type="radio"/> | <input type="radio"/> |
| 33: Low torque bias (by Pr.07-23) | <input type="radio"/> | <input type="radio"/> | <input type="radio"/> | <input type="radio"/> | <input type="radio"/> | <input type="radio"/> |
| 34-37: Reserved | | | | | | |
| 38: Disable write EEPROM function | <input type="radio"/> | <input type="radio"/> | <input type="radio"/> | <input type="radio"/> | <input type="radio"/> | <input type="radio"/> |
| 39: Torque command direction | | | | | <input type="radio"/> | |
| 40: Enable drive function | <input type="radio"/> | <input type="radio"/> | <input type="radio"/> | <input type="radio"/> | <input type="radio"/> | <input type="radio"/> |
| 41: Reserved | | | | | | |
| 42: Mechanical brake | <input type="radio"/> | <input type="radio"/> | <input type="radio"/> | <input type="radio"/> | <input type="radio"/> | <input type="radio"/> |
| 43: EPS function | <input type="radio"/> | <input type="radio"/> | <input type="radio"/> | <input type="radio"/> | <input type="radio"/> | <input type="radio"/> |

-  This parameter selects the functions for each multi-function terminal.
-  If Pr.02-00 is set to 3-wire operation control. Terminal MI1 is for STOP terminal. Therefore, MI1 is not allowed for any other operation.

| Settings | Functions | Descriptions |
|----------|---|---|
| 0 | No Function | |
| 1 | Multi-step speed command 1 | |
| 2 | Multi-step speed command 2 | 15 step speeds could be conducted through the digital statuses of the 4 terminals, and 17 in total if the master speed and JOG are included. (Refer to Pr. 04-00~04-14) |
| 3 | Multi-step speed command 3 | |
| 4 | Multi-step speed command 4 | |
| 5 | Reset | |
| 6 | JOG Command | JOG operation |
| 7 | Acceleration/deceleration Speed Inhibit | When this function is enabled, acceleration and deceleration is stopped and the AC motor drive starts to accel./decel. from the inhibit point. |
| 8 | The 1 st , 2 nd acceleration or deceleration time selection | The acceleration/deceleration time of the drive could be selected from this function or the digital statuses of the terminals; there are 4 acceleration/deceleration speeds in total for selection. |
| 9 | The 3 rd , 4 th acceleration or deceleration time selection | |
| 10 | EF Input | External fault input terminal and decelerates by Pr.07-28. (EF fault will be recorded) |
| 11 | Reserved | |
| 12 | Stop output | |

| Settings | Functions | Descriptions |
|----------|---|--|
| 13 | Disable auto accel./decel. function | It is used to disable auto accel./decel. function. |
| 14 | Reserved | |
| 15 | Operation speed command form AUI1 | When this function is enabled, the source of the frequency will force to be AUI1. |
| 16 | Operation speed command form ACI | When this function is enabled, the source of the frequency will force to be ACI. |
| 17 | Operation speed command form AUI2 | When this function is enabled, the source of the frequency will force to be AUI2. |
| 18 | Emergency Stop | When this function is enabled, the drive will ramp to stop by Pr.07-28 setting. |
| 19-23 | Reserved | |
| 24 | FWD JOG command | When this function is enabled, the drive will execute forward Jog command. |
| 25 | REV JOG command | When this function is enabled, the drive will execute reverse Jog command. |
| 26 | Reserved | |
| 27 | ASR1/ASR2 selection | ON: speed will be adjusted by ASR 2 setting. OFF: speed will be adjusted by ASR 1 setting. |
| 28 | Emergency stop (EF1) (Motor coasts to stop) | When it is ON, the drive will execute emergency stop. (it will have fault code record) |
| 29-30 | Reserved | |
| 31 | High torque bias (by Pr.07-21) | The high torque bias is according to the Pr.07-21 setting. |
| 32 | Middle torque bias (by Pr.07-22) | The middle torque bias is according to the Pr.07-22 setting. |
| 33 | Low torque bias (by Pr.07-23) | The low torque bias is according to the Pr.07-23 setting. |
| 34-37 | Reserved | |
| 38 | Disable write EEPROM function | When this function is enabled, you can't write into EEPROM. |
| 39 | Torque command direction | When the torque command source is ACI, it can change torque direction by enabling this function. |
| 40 | Enable drive function | When this function is enabled, the drive function can be executed. This function can be used with multi-function output (setting Pr.02-11~Pr.02-14 to 15) and (Pr.02-31 and Pr.02-32). |

| Settings | Functions | Descriptions |
|----------|------------------|---|
| 41 | Reserved | |
| 42 | Mechanical brake | When drive receives RUN command, the corresponding output terminal (setting 12) will be enabled after Pr.02-29 time. It will check if this function is enabled within the detection time (Pr.02-35). If NOT, the fault of mechanical brake occurs and fault code "MBF" will be displayed. |
| 43 | EPS function | If power is cut during running, the drive will stop when DC bus voltage is less than low voltage level. After power is cut, drive will run by the frequency depend on EPS when EPS is applied and this function is ON. |

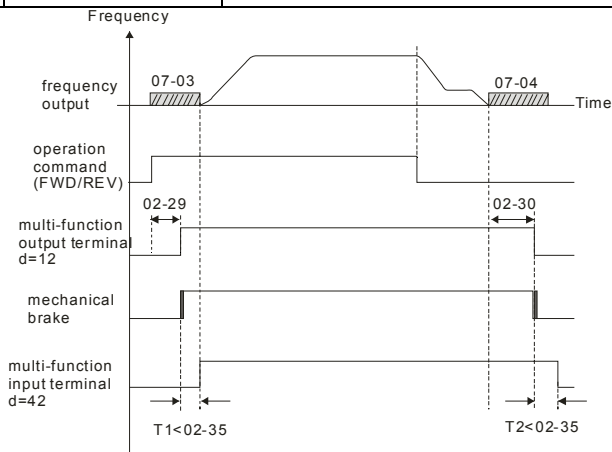
**02-09** Digital Input Response Time

Unit: 0.001

Control mode VF VFPG SVC FOC PG TQCPG FOC PM

Factory setting: 0.005

Settings 0.001~30.000 sec

This parameter is used for digital input terminal signal delay and confirmation. The delay time is confirmation time to prevent some uncertain interferences that would result in error (except for the counter input) in the input of the digital terminals (FWD, REV and MI1~8). Under this condition, confirmation for this parameter could be improved effectively, but the response time will be somewhat delayed.

02-10 ✓ Digital Input Operation Direction

Unit: 1

| | | | | | | | |
|--------------|-----------|------|-----|-------|-------|-------|--------------------|
| Control mode | VF | VFPG | SVC | FOCPG | TQCPG | FOCPM | Factory setting: 0 |
| Settings | 0 ~ 65535 | | | | | | |

 This parameter is used to set the input signal level and it won't be affected by the SINK/SOURCE status.

 Bit0 is for FWD terminal, bit1 is for REV terminal and bit2 to bit9 is for MI1 to MI8.

 User can change terminal status by communicating.

For example, MI1 is set to 1 (multi-step speed command 1), MI2 is set to 2 (multi-step speed command 2). Then the forward + 2nd step speed command=1001(binary)=9 (Decimal). Only need to set Pr.02-10=9 by communication and it can forward with 2nd step speed. It doesn't need to wire any multi-function terminal.

| | | | | | | | | | |
|------|------|------|------|------|------|------|------|------|------|
| bit9 | bit8 | bit7 | bit6 | bit5 | bit4 | bit3 | bit2 | bit1 | bit0 |
| MI8 | MI7 | MI6 | MI5 | MI4 | MI3 | MI2 | MI1 | REV | FWD |

02-11 Multi-function Output 1 RA, RB, RC (Relay1)

Factory Setting: 11

02-12 Multi-function Output 2 MRA, MRC (Relay2)

Factory Setting: 1

02-13 Multi-function Output 3 (MO1)**02-14** Multi-function Output 4 (MO2)**02-15** Multi-function Output 5 (MO3) (need to use with EMVL-IODA01)**02-16** Multi-function Output 6 (MO4) (need to use with EMVL-IODA01)**02-17** Multi-function Output 7 (MO5) (need to use with EMVL-IODA01)**02-18** Multi-function Output 8 (MO6) (need to use with EMVL-IODA01)**02-19** Multi-function Output 9 (MO7) (need to use with EMVL-IODA01)**02-20** Multi-function Output 10 (MO8) (need to use with EMVL-IODA01)**02-21** Multi-function Output 11 (MO9) (need to use with EMVL-IODA01)**02-22** Multi-function Output 12 (MO10) (need to use with EMVL-IODA01)

Factory Setting: 0

Settings 0-41

| Settings | Control Mode | | | | | |
|-------------------------|-----------------------|-----------------------|-----------------------|-----------------------|-----------------------|-----------------------|
| | VF | VFPG | SVC | FOCPG | TQCPG | FOCPM |
| 0: No function | <input type="radio"/> | <input type="radio"/> | <input type="radio"/> | <input type="radio"/> | <input type="radio"/> | <input type="radio"/> |
| 1: Operation indication | <input type="radio"/> | <input type="radio"/> | <input type="radio"/> | <input type="radio"/> | <input type="radio"/> | <input type="radio"/> |

| Settings | Control Mode | | | | | |
|--|-----------------------|-----------------------|-----------------------|-----------------------|-----------------------|-----------------------|
| | VF | VFPG | SVC | FOCPG | TQCPG | FOCPM |
| 2: Operation speed attained | <input type="radio"/> | <input type="radio"/> | <input type="radio"/> | <input type="radio"/> | <input type="radio"/> | <input type="radio"/> |
| 3: Desired frequency attained 1 (Pr.02-25) | <input type="radio"/> | <input type="radio"/> | <input type="radio"/> | <input type="radio"/> | <input type="radio"/> | <input type="radio"/> |
| 4: Desired frequency attained 2 (Pr.02-27) | <input type="radio"/> | <input type="radio"/> | <input type="radio"/> | <input type="radio"/> | <input type="radio"/> | <input type="radio"/> |
| 5: Zero speed (frequency command) | <input type="radio"/> | <input type="radio"/> | <input type="radio"/> | <input type="radio"/> | <input type="radio"/> | <input type="radio"/> |
| 6: Zero speed with stop (frequency command) | <input type="radio"/> | <input type="radio"/> | <input type="radio"/> | <input type="radio"/> | <input type="radio"/> | <input type="radio"/> |
| 7: Over torque (OT1) (Pr.06-05-06-07) | <input type="radio"/> | <input type="radio"/> | <input type="radio"/> | <input type="radio"/> | <input type="radio"/> | <input type="radio"/> |
| 8: Over torque (OT2) (Pr.06-08-06-10) | <input type="radio"/> | <input type="radio"/> | <input type="radio"/> | <input type="radio"/> | <input type="radio"/> | <input type="radio"/> |
| 9: Drive ready | <input type="radio"/> | <input type="radio"/> | <input type="radio"/> | <input type="radio"/> | <input type="radio"/> | <input type="radio"/> |
| 10: User-defined Low-voltage Detection (LV) | <input type="radio"/> | <input type="radio"/> | <input type="radio"/> | <input type="radio"/> | <input type="radio"/> | <input type="radio"/> |
| 11: Malfunction indication | <input type="radio"/> | <input type="radio"/> | <input type="radio"/> | <input type="radio"/> | <input type="radio"/> | <input type="radio"/> |
| 12: Mechanical brake release (Pr.02-29, Pr.02-30) | <input type="radio"/> | <input type="radio"/> | <input type="radio"/> | <input type="radio"/> | <input type="radio"/> | <input type="radio"/> |
| 13: Overheat (Pr.06-14) | <input type="radio"/> | <input type="radio"/> | <input type="radio"/> | <input type="radio"/> | <input type="radio"/> | <input type="radio"/> |
| 14: Brake chopper signal | <input type="radio"/> | <input type="radio"/> | <input type="radio"/> | <input type="radio"/> | <input type="radio"/> | <input type="radio"/> |
| 15: Motor-controlled magnetic contactor output | <input type="radio"/> | <input type="radio"/> | <input type="radio"/> | <input type="radio"/> | <input type="radio"/> | <input type="radio"/> |
| 16: Slip error (σSL) | <input type="radio"/> | <input type="radio"/> | <input type="radio"/> | <input type="radio"/> | <input type="radio"/> | <input type="radio"/> |
| 17: Malfunction indication 1 | <input type="radio"/> | <input type="radio"/> | <input type="radio"/> | <input type="radio"/> | <input type="radio"/> | <input type="radio"/> |
| 18: Reserved | | | | | | |
| 19: Brake chopper output error | <input type="radio"/> | <input type="radio"/> | <input type="radio"/> | <input type="radio"/> | <input type="radio"/> | <input type="radio"/> |
| 20: Warning output | <input type="radio"/> | <input type="radio"/> | <input type="radio"/> | <input type="radio"/> | <input type="radio"/> | <input type="radio"/> |
| 21: Over voltage warning | <input type="radio"/> | <input type="radio"/> | <input type="radio"/> | <input type="radio"/> | <input type="radio"/> | <input type="radio"/> |
| 22: Over-current stall prevention warning | <input type="radio"/> | <input type="radio"/> | <input type="radio"/> | <input type="radio"/> | <input type="radio"/> | <input type="radio"/> |
| 23: Over-voltage stall prevention warning | <input type="radio"/> | <input type="radio"/> | <input type="radio"/> | <input type="radio"/> | <input type="radio"/> | <input type="radio"/> |
| 24: Operation mode indication (Pr.00-15≠0) | <input type="radio"/> | <input type="radio"/> | <input type="radio"/> | <input type="radio"/> | <input type="radio"/> | <input type="radio"/> |
| 25: Forward command | <input type="radio"/> | <input type="radio"/> | <input type="radio"/> | <input type="radio"/> | <input type="radio"/> | <input type="radio"/> |
| 26: Reverse command | <input type="radio"/> | <input type="radio"/> | <input type="radio"/> | <input type="radio"/> | <input type="radio"/> | <input type="radio"/> |
| 27: Output when current >= Pr.02-33 | <input type="radio"/> | <input type="radio"/> | <input type="radio"/> | <input type="radio"/> | <input type="radio"/> | <input type="radio"/> |
| 28: Output when current < Pr.02-33 | <input type="radio"/> | <input type="radio"/> | <input type="radio"/> | <input type="radio"/> | <input type="radio"/> | <input type="radio"/> |
| 29: Output when frequency >= Pr.02-34 | <input type="radio"/> | <input type="radio"/> | <input type="radio"/> | <input type="radio"/> | <input type="radio"/> | <input type="radio"/> |
| 30: Output when frequency < Pr.02-34 | <input type="radio"/> | <input type="radio"/> | <input type="radio"/> | <input type="radio"/> | <input type="radio"/> | <input type="radio"/> |
| 31-32: Reserved | | | | | | |
| 33: Zero speed (actual output frequency) | <input type="radio"/> | <input type="radio"/> | <input type="radio"/> | <input type="radio"/> | <input type="radio"/> | <input type="radio"/> |
| 34: Zero speed with Stop (actual output frequency) | <input type="radio"/> | <input type="radio"/> | <input type="radio"/> | <input type="radio"/> | <input type="radio"/> | <input type="radio"/> |
| 35: Fault output option 1 (Pr.06-22) | <input type="radio"/> | <input type="radio"/> | <input type="radio"/> | <input type="radio"/> | <input type="radio"/> | <input type="radio"/> |
| 36: Fault output option 2 (Pr.06-23) | <input type="radio"/> | <input type="radio"/> | <input type="radio"/> | <input type="radio"/> | <input type="radio"/> | <input type="radio"/> |
| 37: Fault output option 3 (Pr.06-24) | <input type="radio"/> | <input type="radio"/> | <input type="radio"/> | <input type="radio"/> | <input type="radio"/> | <input type="radio"/> |
| 38: Fault output option 4 (Pr.06-25) | <input type="radio"/> | <input type="radio"/> | <input type="radio"/> | <input type="radio"/> | <input type="radio"/> | <input type="radio"/> |
| 39: Reserved | | | | | | |
| 40: Speed attained (including zero speed) | <input type="radio"/> | <input type="radio"/> | <input type="radio"/> | <input type="radio"/> | <input type="radio"/> | <input type="radio"/> |
| 41: Reserved | | | | | | |

| Settings | Functions | Descriptions |
|----------|--------------------------|--|
| 0 | No Function | |
| 1 | AC Drive Operational | Active when there is an output from the drive or RUN command is ON. |
| 2 | Operation speed attained | Active when the AC motor drive reaches the output frequency setting. |

| Settings | Functions | Descriptions |
|----------|---|---|
| 3 | Desired Frequency Attained 1 (Pr.02-25) | Active when the desired frequency (Pr.02-25) is attained. |
| 4 | Desired Frequency Attained 2 (Pr.02-27) | Active when the desired frequency (Pr.02-27) is attained. |
| 5 | Zero Speed (frequency command) | Active when frequency command =0. (the drive should be at RUN mode) |
| 6 | Zero Speed with Stop (frequency command) | Active when frequency command =0 or stop. |
| 7 | Over Torque (OT1) (Pr.06-05~06-07) | Active when detecting over-torque. Refer to Pr.06-05 (over-torque detection selection-OT1), Pr.06-06 (over-torque detection level-OT1) and Pr.06-07 (over-torque detection time-OT1). |
| 8 | Over Torque (OT2) (Pr.06-08~06-10) | Active when detecting over-torque. Refer to Pr.06-08 (over-torque detection selection-OT2), Pr.06-09 (over-torque detection level-OT2) and Pr.06-10 (over-torque detection time-OT2). |
| 9 | Drive Ready | Active when the drive is ON and no abnormality detected. |
| 10 | User-defined Low-voltage Detection | Active when the DC Bus voltage is too low. (refer to Pr.06-00 low voltage level) |
| 11 | Malfunction Indication | Active when fault occurs (except Lv stop). |
| 12 | Mechanical Brake Release (Pr.02-29, Pr.02-30) | When drive runs after Pr.02-29, it will be ON. This function should be used with DC brake and it is recommended to use contact "b"(N.C). |
| 13 | Overheat (Pr.06-14) | Active when IGBT or heat sink overheats to prevent OH turn off the drive. (refer to Pr.06-14) |
| 14 | Brake Chopper Signal | The output will be activated when the drive needs help braking the load. A smooth deceleration is achieved by using this function. (refer to Pr.07-00) |
| 15 | Motor-controlled Magnetic Contactor Output | Active when the setting is set to 15. |
| 16 | Slip Error (oSL) | Active when the slip error is detected. |
| 17 | Malfunction indication 1 | Activate after 10ms when fault occurs (except Lv stop). |
| 18 | Reserved | |
| 19 | Brake Chopper Output Error | Active when the brake chopper error is detected. |

| Settings | Functions | Descriptions |
|----------|--|---|
| 20 | Warning Output | Active when the warning is detected. |
| 21 | Over-voltage Warning | Active when the over-voltage is detected. |
| 22 | Over-current Stall Prevention Warning | Active when the over-current stall prevention is detected. |
| 23 | Over-voltage Stall prevention Warning | Active when the over-voltage stall prevention is detected. |
| 24 | Operation Mode Indication | Active when the operation command is controlled by external terminal. (Pr.00-15≠0) |
| 25 | Forward Command | Active when the operation direction is forward. |
| 26 | Reverse Command | Active when the operation direction is reverse. |
| 27 | Output when Current >= Pr.02-33 | Active when current is >= Pr.02-33. |
| 28 | Output when Current < Pr.02-33 | Active when current is < Pr.02-33. |
| 29 | Output when frequency >= Pr.02-34 | Active when frequency is >= Pr.02-34. |
| 30 | Output when Frequency < Pr.02-34 | Active when frequency is < Pr.02-34. |
| 31-32 | Reserved | |
| 33 | Zero Speed (actual output frequency) | Active when the actual output frequency is 0. (the drive should be at RUN mode) |
| 34 | Zero Speed with Stop (actual output frequency) | Active when the actual output frequency is 0 or Stop. (the drive should be at RUN mode) |
| 35 | Fault output option 1 | Active when Pr.06-22 is ON. |
| 36 | Fault output option 2 | Active when Pr.06-23 is ON. |
| 37 | Fault output option 3 | Active when Pr.06-24 is ON. |
| 38 | Fault output option 4 | Active when Pr.06-25 is ON. |
| 39 | Reserved | |

| Settings | Functions | Descriptions |
|----------|---------------------------------------|---|
| 40 | Speed Attained (including zero speed) | Active when the output frequency reaches frequency setting. |
| 41 | Reserved | |

02-23 ✓ Multi-output Direction

Unit:1

Control mode **VF** **VFPG** **SVC** **FOCPG** **TQCPG** **FOCPM** Factory setting: 0

Settings 0 ~ 65535

This parameter is bit setting. If the bit is 1, the multi-function output terminal will be act with opposite direction. For example, if Pr.02-11 is set to 1 and forward bit is 0, Relay 1 will be ON when the drive is running and OFF when the drive is stop.

The multi-function output terminals MO3~MO10 need to use with EMVL-IODA01.

| | | | | | | | | | | | |
|--------|--------|-------|-------|-------|-------|-------|-------|-------|-------|-------|-------|
| Bit 11 | Bit 10 | Bit 9 | Bit 8 | Bit 7 | Bit 6 | Bit 5 | Bit 4 | Bit 3 | Bit 2 | Bit 1 | Bit 0 |
| MO10 | MO9 | MO8 | MO7 | MO6 | MO5 | MO4 | MO3 | MO2 | MO1 | MRA | RA |

02-24 ✓ Serial Start Signal Selection

Control mode **VF** **VFPG** **SVC** **FOCPG** **FOCPM** Factory setting: 0

Settings 0 by FWD/REV

1 by Enable

This parameter is used to select serial start method of electromagnetic valve.

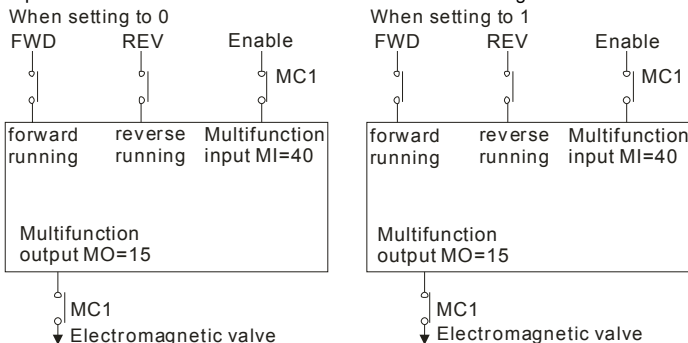

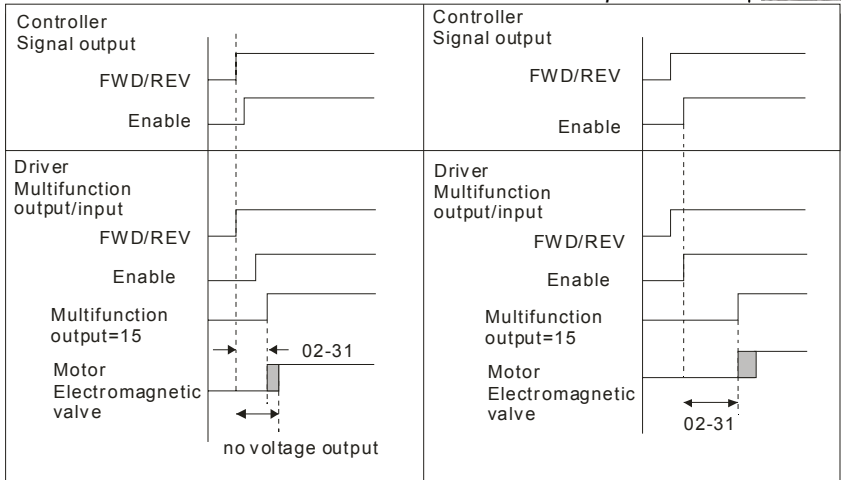
**02-25** ✓ Desired Frequency Attained 1

Unit: 0.01

Control mode VF VFPG SVC FOC PG FOC PM

Factory setting: 60.00/50.00

02-26 ✓ The Width of the Desired Frequency Attained 1

Unit: 0.01

Control mode VF VFPG SVC FOC PG FOC PM

Factory setting: 2.00

02-27 ✓ Desired Frequency Attained 2

Unit: 0.01

Control mode VF VFPG SVC FOC PG FOC PM

Factory setting: 60.00/50.00

02-28 ✓ The Width of the Desired Frequency Attained 2

Unit: 0.01

Control mode VF VFPG SVC FOC PG FOC PM

Factory setting: 2.00

Settings 0.00 ~ 120.00Hz

Once output frequency reaches desired frequency and the corresponding multi-function output terminal is set to 3 or 4 (Pr.02-11~Pr.02-22), this multi-function output terminal will be ON.

02-29 Brake Release Delay Time when Elevator Starts

Unit:0.001

Control mode VF VFPG SVC FOC PG TQCPG FOC PM

Factory setting: 0.250

02-30 Brake Engage Delay Time when Elevator Stops

Unit:0.001

Control mode VF VFPG SVC FOC PG TQCPG FOC PM

Factory setting: 0.250

Settings 0.000~65.000 Sec

- When the AC motor drive runs after Pr.02-29 delay time, the corresponding multi-function output terminal (12: mechanical brake release) will be ON. This function should be used with DC brake.
- When the AC motor drive stops 12 after Pr.02-30 delay time, the corresponding multi-function output terminal (12: mechanical brake release) will be OFF.

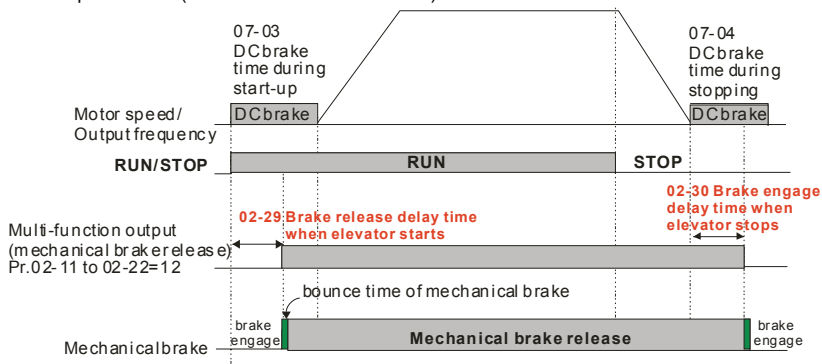

| | | |
|---------------------|--|------------------------|
| 02-31 | ✓ Turn On Delay of Magnetic Contact between Drive and Motor | Unit:0.001 |
| 02-32 | ✓ Turn Off Delay of Magnetic Contact between Drive and Motor | Unit:0.001 |
| Control mode | VF VFPG SVC FOCPG TQCPG FOCPM | Factory setting: 0.200 |
| Settings | 0.000~65.000 Sec | |

- After running, it is used with setting 40 of multifunction input terminal and settings 15 of multifunction output terminals. When multifunction output terminals is ON, the drive starts output after Pr.02-31 delay time. When drive stops output, multifunction output terminals will release after Pr.02-32 delay time.

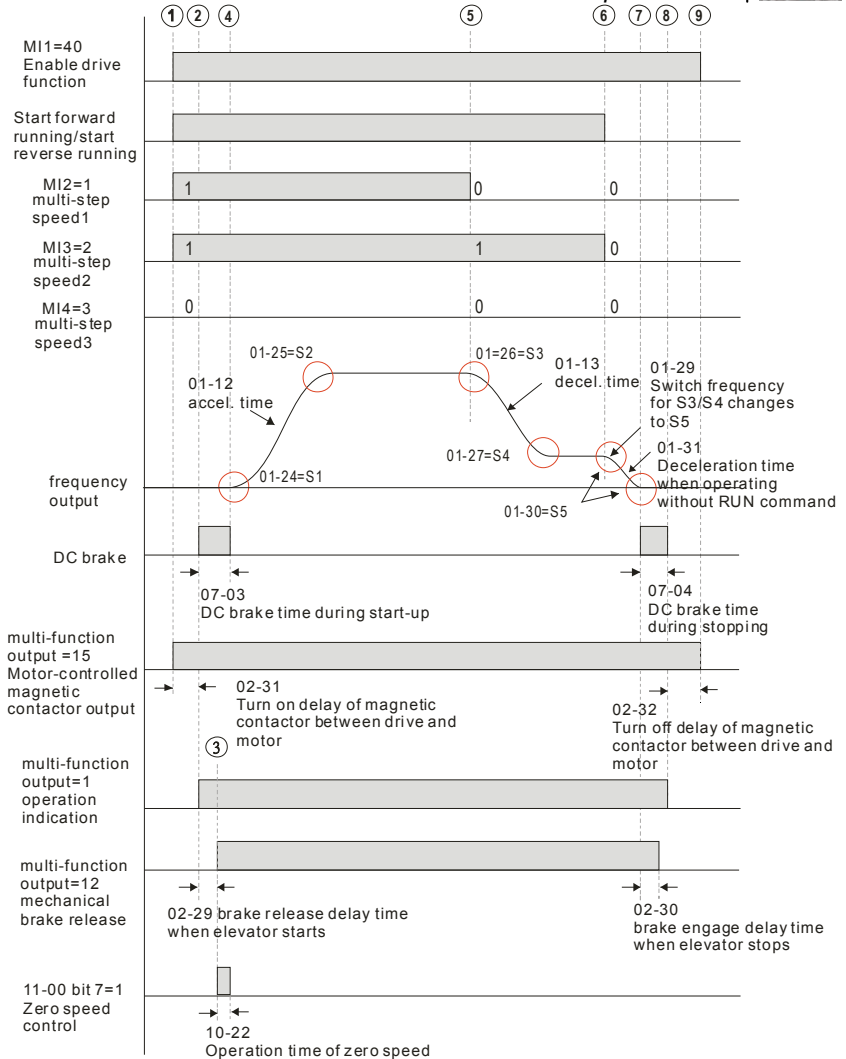

- ① elevator starts running ⑤ start deceleration ⑨ motor release
- ② electromagnetic valves is ON ⑥ the end of creep
- ③ brake release ⑦ start DC brake time during stopping
- ④ the end of DC brake time ⑧ the end of DC brake time during stopping
- at start-up

| | | | | | | | |
|---------------------|---|------|-----|-------|-------|-------|--------------------|
| 02-33 | Output Current Level Setting for External Terminals | | | | | | Unit:1 |
| Control mode | VF | VFPG | SVC | FOCPG | TQCPG | FOCPM | Factory setting: 0 |
| Settings | 0~100% | | | | | | |

 When output current is \geq Pr.02-33, it will activate multi-function output terminal (Pr.02-11 to Pr.02-22 is set to 27).

 When output current is $<$ Pr.02-33, it will activate multi-function output terminal (Pr.02-11 to Pr.02-22 is set to 28).

| | | | | | | | |
|---------------------|--|------|-----|-------|-------|-------|-----------------------|
| 02-34 | Output Boundary for External Terminals | | | | | | Unit:0.01 |
| Control mode | VF | VFPG | SVC | FOCPG | TQCPG | FOCPM | Factory setting: 0.00 |
| Settings | 0.00~ \pm 120.00Hz | | | | | | |

 When output frequency is \geq 02-34, it will activate the multi-function terminal (Pr.02-11 to Pr.02-22 is set to 29).

 When output frequency is $<$ 02-34, it will activate the multi-function terminal (Pr.02-11 to Pr.02-22 is set to 30).

| | | | | | | | |
|---------------------|------------------------------------|------|-----|-------|-------|-------|-----------------------|
| 02-35 | Detection Time of Mechanical Brake | | | | | | Unit: 0.01 |
| Control mode | VF | VFPG | SVC | FOCPG | TQCPG | FOCPM | Factory setting: 0.00 |
| Settings | 0.00 ~ 10.00 sec | | | | | | |

 When mechanical brake function (setting 42 of Pr.02-01~02-08) is not enabled within this setting time, it will display fault code 64 (MBF) mechanical brake error.

Group 3 Analog Input/Output Parameters**03-00**  Analog Input 1 (AUI1)

Factory Setting: 1



03-01  Analog Input 2 (ACI)

Factory Setting: 0

03-02  Analog Input 3 (AUI2)

Factory Setting: 0

| Settings | Control Mode | | | | | |
|--|-----------------------|-----------------------|-----------------------|-----------------------|-----------------------|-----------------------|
| | VF | VFPG | SVC | FOCPG | TQCPG | FOCPM |
| 0: No function | <input type="radio"/> | <input type="radio"/> | <input type="radio"/> | <input type="radio"/> | <input type="radio"/> | <input type="radio"/> |
| 1: Frequency command (torque limit under TQR control mode) | <input type="radio"/> | <input type="radio"/> | <input type="radio"/> | <input type="radio"/> | <input type="radio"/> | <input type="radio"/> |
| 2: Torque command (torque limit under speed mode) | | | | | <input type="radio"/> | |
| 3: Torque compensation command | <input type="radio"/> | <input type="radio"/> | <input type="radio"/> | <input type="radio"/> | <input type="radio"/> | <input type="radio"/> |
| 4-5: Reserved | | | | | | |
| 6: P.T.C. thermistor input value | <input type="radio"/> | <input type="radio"/> | <input type="radio"/> | <input type="radio"/> | <input type="radio"/> | <input type="radio"/> |
| 7: Positive torque limit | | | | <input type="radio"/> | | <input type="radio"/> |
| 8: Negative torque limit | | | | <input type="radio"/> | | <input type="radio"/> |
| 9: Regenerative torque limit | | | | <input type="radio"/> | | <input type="radio"/> |
| 10: Positive/negative torque limit | | | | <input type="radio"/> | | <input type="radio"/> |
| 11: Preload Input | | | | | | <input type="radio"/> |

-  When it is frequency command or TQR speed limit, the corresponding value for 0~±10V/4~20mA is 0 – max. output frequency(Pr.01-00)
-  When it is torque command or torque limit, the corresponding value for 0~±10V/4~20mA is 0 – max. output torque (Pr.07-14).
-  When it is torque compensation, the corresponding value for 0~±10V/4~20mA is 0 – rated torque.

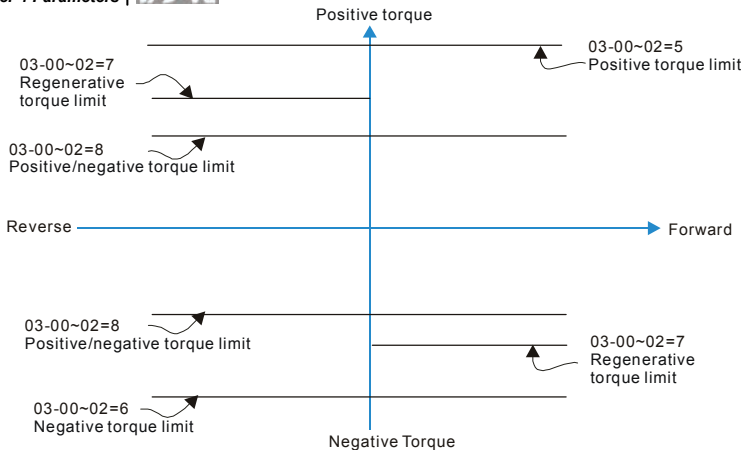

07-19: Source of torque offset
 03-00~02: Analog input selections (AU1/AC1/AU12)
 03-03~05: Analog input bias (AU1/AC1/AU12)
 03-06~08: AU1/AC1/AU12 bias mode

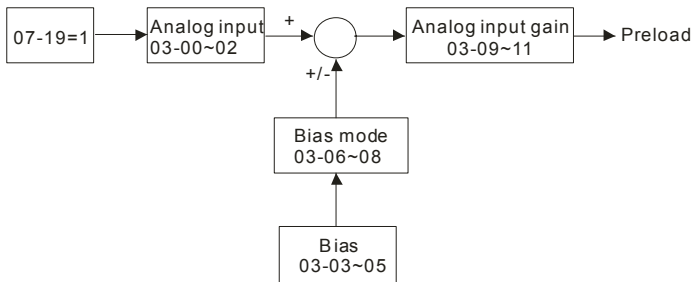

| | | | | | | | |
|---------------------|---------------------------|------|-----|-------|-------|-------|----------------------|
| 03-03 | Analog Input Bias 1 (AU1) | | | | | | Unit: 0.1 |
| Control mode | VF | VFGP | SVC | FOCPG | TQCPG | FOCPM | Factory setting: 0.0 |
| Settings | -100.0~100.0% | | | | | | |

It is used to set the corresponding AU1 voltage of the external analog input 0.

| | | | | | | | |
|---------------------|---------------------------|------|-----|-------|-------|-------|----------------------|
| 03-04 | Analog Input Bias 1 (AC1) | | | | | | Unit: 0.1 |
| Control mode | VF | VFGP | SVC | FOCPG | TQCPG | FOCPM | Factory setting: 0.0 |
| Settings | -100.0~100.0% | | | | | | |

 It is used to set the corresponding ACI voltage of the external analog input 0.

| | | | | | | | |
|--------------|------------------------------|------|-----|-------|-------|-------|----------------------|
| 03-05 | ↗ Analog Input Bias 1 (AUI2) | | | | | | Unit: 0.1 |
| Control mode | VF | VFPG | SVC | FOCPG | TQCPG | FOCPM | Factory setting: 0.0 |
| Settings | -100.0~100.0% | | | | | | |

 It is used to set the corresponding AUI2 voltage of the external analog input 0.

 The relation between external input voltage/current and setting frequency is equal to -10~+10V (4-20mA) corresponds to 0-60Hz.

| | | | | | | | |
|--------------|--------------------------------------|------|-----|-------|-------|-------|--------------------|
| 03-06 | ↗ Positive/negative Bias Mode (AUI1) | | | | | | Factory setting: 0 |
| Control mode | VF | VFPG | SVC | FOCPG | TQCPG | FOCPM | |

| | | | | | | | |
|--------------|-------------------------------------|------|-----|-------|-------|-------|--------------------|
| 03-07 | ↗ Positive/negative Bias Mode (ACI) | | | | | | Factory setting: 0 |
| Control mode | VF | VFPG | SVC | FOCPG | TQCPG | FOCPM | |

| | | | | | | | |
|--------------|--------------------------------------|--|-----|-------|-------|-------|--------------------|
| 03-08 | ↗ Positive/negative Bias Mode (AUI2) | | | | | | Factory setting: 0 |
| Control mode | VF | VFPG | SVC | FOCPG | TQCPG | FOCPM | |
| Settings | 0 | Zero bias | | | | | |
| | 1 | Lower than bias=bias | | | | | |
| | 2 | Greater than bias=bias | | | | | |
| | 3 | The absolute value of the bias voltage while serving as the center | | | | | |
| | 4 | Serve bias as the center | | | | | |

 In a noisy environment, it is advantageous to use negative bias to provide a noise margin. It is recommended NOT to use less than 1V to set the operating frequency.

| | | | | | | | |
|--------------|------------------------------|------|-----|-------|-------|-------|------------------------|
| 03-09 | ↗ Analog Input Gain 1 (AUI1) | | | | | | Unit: 0.1 |
| Control mode | VF | VFPG | SVC | FOCPG | TQCPG | FOCPM | Factory setting: 100.0 |

| | | | | | | | |
|--------------|-----------------------------|------|-----|-------|-------|-------|------------------------|
| 03-10 | ↗ Analog Input Gain 1 (ACI) | | | | | | Unit: 0.1 |
| Control mode | VF | VFPG | SVC | FOCPG | TQCPG | FOCPM | Factory setting: 100.0 |

| | | | | | | | |
|--------------|------------------------------|------|-----|-------|-------|-------|------------------------|
| 03-11 | ↗ Analog Input Gain 1 (AUI2) | | | | | | Unit: 0.1 |
| Control mode | VF | VFPG | SVC | FOCPG | TQCPG | FOCPM | Factory setting: 100.0 |
| Settings | -500.0~500.0% | | | | | | |

Parameters 03-03 to 03-11 are used when the source of frequency command is the analog voltage/current signal.

| | | | | | | | |
|--------------|----------------------------------|------|-----|-------|-------|-------|-----------------------|
| 03-12 | ✓ Analog Input Delay Time (AUI1) | | | | | | Unit: 0.01 |
| Control mode | VF | VFPG | SVC | FOCPG | TQCPG | FOCPM | Factory setting: 0.01 |
| 03-13 | ✓ Analog Input Delay Time (ACI) | | | | | | Unit: 0.01 |
| Control mode | VF | VFPG | SVC | FOCPG | TQCPG | FOCPM | Factory setting: 0.01 |

| | | | | | | | |
|--------------|----------------------------------|------|-----|-------|-------|-------|-----------------------|
| 03-14 | ✓ Analog Input Delay Time (AUI2) | | | | | | Unit: 0.01 |
| Control mode | VF | VFPG | SVC | FOCPG | TQCPG | FOCPM | Factory setting: 0.01 |
| Settings | 0.00 to 2.00 sec | | | | | | |

Interferences commonly exist with analog signals, such as those entering AUI, ACI and AUI2. These interferences constantly affect the stability of analog control and using the Input Noise Filter will create a more stable system.

If Pr. 03-14 is large, the control will be stable, yet the response to the input will be slow. If Pr. 03-14 is small, the control may be unstable, yet the response to the input will be fast.

| | | | | | | | |
|--------------|--------------------------|--|-----|-------|-------|-------|--------------------|
| 03-15 | ✓ Loss of the ACI Signal | | | | | | Factory setting: 0 |
| Control mode | VF | VFPG | SVC | FOCPG | TQCPG | FOCPM | |
| Settings | 0 | Disable | | | | | |
| | 1 | Continue operation at the last frequency | | | | | |
| | 2 | Decelerate to stop | | | | | |
| | 3 | Stop immediately and display E.F. | | | | | |

This parameter determines the behavior when ACI (4-20mA) is lost.

| | | | | | | |
|--------------|----------|--|--|--|--|--|
| 03-16 | Reserved | | | | | |
|--------------|----------|--|--|--|--|--|

| | | | | | | |
|--------------|-----------------------------|--|--|--|--|--|
| 03-17 | ✓ Analog Output Selection 1 | | | | | |
| 03-20 | ✓ Analog Output Selection 2 | | | | | |
| Settings | 0-20 | | | | | |
| | Factory Setting: 0 | | | | | |

| Settings | Control Mode | | | | | |
|---------------------------|--------------------------|--------------------------|--------------------------|--------------------------|--------------------------|--------------------------|
| | VF | VFPG | SVC | FOCPG | TQCPG | FOCPM |
| 0: Output frequency (Hz) | <input type="checkbox"/> | <input type="checkbox"/> | <input type="checkbox"/> | <input type="checkbox"/> | <input type="checkbox"/> | <input type="checkbox"/> |
| 1: Frequency command (Hz) | <input type="checkbox"/> | <input type="checkbox"/> | <input type="checkbox"/> | <input type="checkbox"/> | <input type="checkbox"/> | <input type="checkbox"/> |
| 2: Motor speed (RPM) | <input type="checkbox"/> | <input type="checkbox"/> | <input type="checkbox"/> | <input type="checkbox"/> | <input type="checkbox"/> | <input type="checkbox"/> |
| 3: Output current (rms) | <input type="checkbox"/> | <input type="checkbox"/> | <input type="checkbox"/> | <input type="checkbox"/> | <input type="checkbox"/> | <input type="checkbox"/> |
| 4: Output voltage | <input type="checkbox"/> | <input type="checkbox"/> | <input type="checkbox"/> | <input type="checkbox"/> | <input type="checkbox"/> | <input type="checkbox"/> |
| 5: DC Bus Voltage | <input type="checkbox"/> | <input type="checkbox"/> | <input type="checkbox"/> | <input type="checkbox"/> | <input type="checkbox"/> | <input type="checkbox"/> |
| 6: Power factor | <input type="checkbox"/> | <input type="checkbox"/> | <input type="checkbox"/> | <input type="checkbox"/> | <input type="checkbox"/> | <input type="checkbox"/> |
| 7: Power | <input type="checkbox"/> | <input type="checkbox"/> | <input type="checkbox"/> | <input type="checkbox"/> | <input type="checkbox"/> | <input type="checkbox"/> |
| 8: Output torque | <input type="checkbox"/> | <input type="checkbox"/> | <input type="checkbox"/> | <input type="checkbox"/> | <input type="checkbox"/> | <input type="checkbox"/> |
| 9: AUI1 | <input type="checkbox"/> | <input type="checkbox"/> | <input type="checkbox"/> | <input type="checkbox"/> | <input type="checkbox"/> | <input type="checkbox"/> |
| 10: ACI | <input type="checkbox"/> | <input type="checkbox"/> | <input type="checkbox"/> | <input type="checkbox"/> | <input type="checkbox"/> | <input type="checkbox"/> |
| 11: AUI2 | <input type="checkbox"/> | <input type="checkbox"/> | <input type="checkbox"/> | <input type="checkbox"/> | <input type="checkbox"/> | <input type="checkbox"/> |
| 12: q-axis current | <input type="checkbox"/> | <input type="checkbox"/> | <input type="checkbox"/> | <input type="checkbox"/> | <input type="checkbox"/> | <input type="checkbox"/> |
| 13: q-axis feedback value | <input type="checkbox"/> | <input type="checkbox"/> | <input type="checkbox"/> | <input type="checkbox"/> | <input type="checkbox"/> | <input type="checkbox"/> |
| 14: d-axis current | <input type="checkbox"/> | <input type="checkbox"/> | <input type="checkbox"/> | <input type="checkbox"/> | <input type="checkbox"/> | <input type="checkbox"/> |
| 15: d-axis feedback value | <input type="checkbox"/> | <input type="checkbox"/> | <input type="checkbox"/> | <input type="checkbox"/> | <input type="checkbox"/> | <input type="checkbox"/> |
| 16: q-axis voltage | <input type="checkbox"/> | <input type="checkbox"/> | <input type="checkbox"/> | <input type="checkbox"/> | <input type="checkbox"/> | <input type="checkbox"/> |
| 17: d-axis voltage | <input type="checkbox"/> | <input type="checkbox"/> | <input type="checkbox"/> | <input type="checkbox"/> | <input type="checkbox"/> | <input type="checkbox"/> |
| 18: Torque command | <input type="checkbox"/> | <input type="checkbox"/> | <input type="checkbox"/> | <input type="checkbox"/> | <input type="checkbox"/> | <input type="checkbox"/> |
| 19-20: Reserved | | | | | | |

03-18 Analog Output Gain 1

Unit: 0.1

03-21 Analog Output Gain 2

Unit: 0.1

| Control mode | VF | VFPG | SVC | FOCPG | TQCPG | FOCPM |
|--------------|----|------|-----|-------|-------|-------|
|--------------|----|------|-----|-------|-------|-------|

Factory setting: 100.0

Settings 0 to 200.0%



This parameter is set the corresponding voltage of the analog output 0.

03-19 Analog Output Value in REV Direction 1**03-22** Analog Output Value in REV Direction 2

| Control mode | VF | VFPG | SVC | FOCPG | TQCPG | FOCPM |
|--------------|----|------|-----|-------|-------|-------|
|--------------|----|------|-----|-------|-------|-------|

Factory setting: 0

| | | |
|----------|---|--|
| Settings | 0 | Absolute value in REV direction |
| | 1 | Output 0V in REV direction |
| | 2 | Enable output voltage in REV direction |

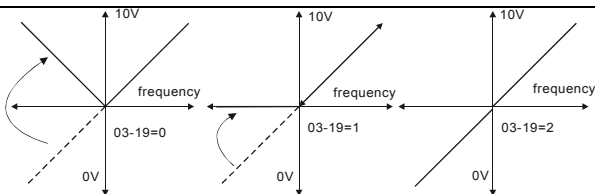

Selection for the analog output direction

Group 4 Multi-Step Speed Parameters

| | | |
|---------------------|---|-----------------------|
| 04-00 | ↗ Zero Step Speed Frequency | Unit: 0.01 |
| 04-01 | ↗ 1st Step Speed Frequency | Unit: 0.01 |
| 04-02 | ↗ 2nd Step Speed Frequency | Unit: 0.01 |
| 04-03 | ↗ 3rd Step Speed Frequency | Unit: 0.01 |
| 04-04 | ↗ 4th Step Speed Frequency | Unit: 0.01 |
| 04-05 | ↗ 5th Step Speed Frequency | Unit: 0.01 |
| 04-06 | ↗ 6th Step Speed Frequency | Unit: 0.01 |
| 04-07 | ↗ 7th Step Speed Frequency | Unit: 0.01 |
| 04-08 | ↗ 8th Step Speed Frequency | Unit: 0.01 |
| 04-09 | ↗ 9th Step Speed Frequency | Unit: 0.01 |
| 04-10 | ↗ 10th Step Speed Frequency | Unit: 0.01 |
| 04-11 | ↗ 11th Step Speed Frequency | Unit: 0.01 |
| 04-12 | ↗ 12th Step Speed Frequency | Unit: 0.01 |
| 04-13 | ↗ 13th Step Speed Frequency | Unit: 0.01 |
| 04-14 | ↗ 14th Step Speed Frequency | Unit: 0.01 |
| 04-15 | ↗ 15th Step Speed Frequency | Unit: 0.01 |
| Control mode | VF VFP SVC FOCPG FOCPM | Factory setting: 0.00 |
| | Settings | 0.00 to 120.00 Hz |

 The Multi-Function Input Terminals (refer to Pr.02-01 to 02-08) are used to select one of the AC motor drive Multi-step speeds. The speeds (frequencies) are determined by Pr.04-00 to 04-15 as shown above.

Group 5 IM Motor Parameters

05-00 Motor Auto Tuning

Control mode VF

Factory setting: 0

| | | |
|----------|---|--|
| Settings | 0 | No function |
| | 1 | Rolling test (Rs, Rr, Lm, Lx, no-load current) |
| | 2 | Static Test |

 Starting auto tuning by pressing RUN key and it will write the measure value into Pr.05-05 to Pr.05-09 (Rs, Rr, Lm, Lx, no-load current).

 The steps to AUTO-Tuning are: (when setting to 1)

1. Make sure that all the parameters are set to factory settings and the motor wiring is correct.
2. Make sure the motor has no-load before executing auto-tuning and the shaft is not connected to any belt or gear motor. It is recommended to set to 2 if the motor can't separate from the load.
3. Fill in Pr.01-02, Pr.01-01, Pr.05-01, Pr.05-02, Pr.05-03 and Pr.05-04 with correct values. Refer to motor capacity to set accel./decel. time.
4. When Pr.05-00 is set to 1, the AC motor drive will execute auto-tuning immediately after receiving a "RUN" command. (NOTE: the motor will run!)
5. After executing, please check if all values are filled in Pr.05-05 to Pr.05-09.
6. Equivalent circuit

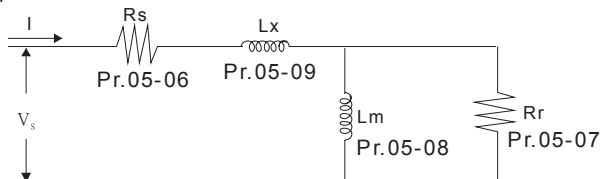

Equivalent circuit for VFD-VL series

 If Pr.05-00 is set to 2, it needs to input Pr.05-05.

**NOTE**

1. In torque/vector control mode, it is not recommended to have motors run in parallel.
2. It is not recommended to use torque/vector control mode if motor rated power exceeds the rated power of the AC motor drive.
3. The no-load current is usually 20~50% X rated current.

4. The rated speed can't be larger or equal to 120f/p. (f: output frequency Pr.01-01, p: Number of Motor Poles Pr.05-04)

| | | | | | | |
|---------------------|----------------------------|------------|------------|--------------|--------------|----------------------|
| 05-01 | Full-load Current of Motor | | | | | Unit: 0.01 |
| Control mode | VF | VFP | SVC | FOCPG | TQCPG | Factory setting: ### |
| | Settings | 40 to 120% | | | | |

 This value should be set according to the rated frequency of the motor as indicated on the motor nameplate. The factory setting is 90% X rated current.

Example: if the rated current for 7.5hp (5.5kW) models is 25A and the factory setting is 22.5A. In this way, the current range will be from 10A (25*40%) to 30A (25*120%).

| | | | | | |
|---------------------|----------------------|-------------------|--------------|----------------------|----------------------|
| 05-02 | Rated Power of Motor | | | Unit: 0.01 | |
| Control mode | SVC | FOCPG | TQCPG | Factory setting: ### | |
| | Settings | 0.00 to 655.35 kW | | | Factory Setting: ### |

 It is used to set rated power of the motor. The factory setting is the power of the drive.

| | | | | | |
|---------------------|----------------------------|----------------|--------------|--------------|-----------------------|
| 05-03 | Rated Speed of Motor (rpm) | | | | Unit: 1 |
| Control mode | VFP | SVC | FOCPG | TQCPG | Factory setting: 1710 |
| | Settings | 0 to 65535 rpm | | | |



 It is used to set the rated speed of the motor and need to set according to the value indicated on the motor nameplate.

| | | | | | | |
|---------------------|-----------------------|------------|------------|--------------|--------------|--------------------|
| 05-04 | Number of Motor Poles | | | | | Unit: 4 |
| Control mode | VF | VFP | SVC | FOCPG | TQCPG | Factory setting: 4 |
| | Settings | 2 to 48 | | | | |

 It is used to set the number of motor poles (must be an even number).

| | | | | | |
|---------------------|--------------------------|------------|--------------|--------------|----------------------|
| 05-05 | No-load Current of Motor | | | | Unit: Amp |
| Control mode | VFP | SVC | FOCPG | TQCPG | Factory setting: ### |
| | Settings | 0 to 100% | | | |

 The factory setting is 40% X rated current.

| | | |
|--|---|------------------------|
| 05-06 | Rs of Motor | Unit: 0.001 |
| Control mode | SVC FOCPG TQCPG | Factory setting: 0.000 |
| 05-07 | Rr of Motor | Unit: 0.001 |
| Control mode | SVC FOCPG TQCPG | Factory setting: 0.000 |
| | Settings | 0.000~65.535Ω |
| 05-08 | Lm of Motor | Unit: 0.1 |
| Control mode | SVC FOCPG TQCPG | Factory setting: 0.0 |
| 05-09 | Lx of Motor | Unit: 0.1 |
| Control mode | SVC FOCPG TQCPG | Factory setting: 0.0 |
| | Settings | 0.0~6553.5mH |
| 05-10 | ⚡ Torque Compensation Time Constant | Unit: 0.001 |
| Control mode | SVC | Factory setting: 0.020 |
| | Settings | 0.001 to 10.000 sec |
| 05-11 | ⚡ Slip Compensation Time Constant | Unit: 0.001 |
| Control mode | SVC | Factory setting: 0.100 |
| | Settings | 0.001 to 10.000 sec |
|  | Setting Pr.05-10 and Pr.05-11 change the response time for the compensation. | |
|  | When Pr.05-10 and Pr.05-11 are set to 10 seconds, its response time for the compensation will be the longest. But if the settings are too short, unstable system may occur. | |
| 05-12 | ⚡ Torque Compensation Gain | Unit: 1 |
| Control mode | VF VFPG | Factory setting: 0 |
| | Settings | 0 to10 |
|  | This parameter may be set so that the AC motor drive will increase its voltage output to obtain a higher torque. | |
| 05-13 | ⚡ Slip Compensation Gain | Unit: 0.01 |
| Control mode | SVC VFPG SVC | Factory setting: 0.00 |
| | Settings | 0.00 to10.00 |

When the asynchronous motor is driven by the drive, the load and slip will be increased. This parameter can be used to correct frequency and lower the slip to make the motor can run near the synchronous speed under rated current. When the output current is larger than the motor no-load current, the drive will compensate the frequency by Pr.05-13 setting. If the actual speed is slower than expectation, please increase the setting and vice versa.

It is only valid in SVC mode.

| | | | | | |
|--------------|-------------------------|-----|-------|--|--------------------|
| 05-14 | ↗ Slip Deviation Level | | | | Unit: 1 |
| Control mode | VFPG | SVC | FOCPG | | Factory setting: 0 |
| Settings | 0 to 1000% (0: disable) | | | | |

| | | | | | |
|--------------|------------------------------------|-----|-------|--|----------------------|
| 05-15 | ↗ Detection time of Slip Deviation | | | | Unit: 0.1 |
| Control mode | VFPG | SVC | FOCPG | | Factory setting: 1.0 |
| Settings | 0.0 to 10.0 sec | | | | |

| | | | | | |
|--------------|-----------------------|-------------------------|-------|--|--------------------|
| 05-16 | ↗ Over Slip Treatment | | | | Unit: 1 |
| Control mode | VFPG | SVC | FOCPG | | Factory setting: 0 |
| Settings | 0 | Warn and keep operation | | | |
| | 1 | Warn and ramp to stop | | | |
| | 2 | Warn and coast to stop | | | |

Pr.05-14 to Pr.05-16 are used to set allowable slip level/time and over slip treatment when the drive is running.

| | | | | |
|--------------|-------------------------|------|-----|-----------------------|
| 05-17 | ↗ Hunting Gain | | | Unit: 1 |
| Control mode | VF | VFPG | SVC | Factory setting: 2000 |
| Settings | 0 to 10000 (0: disable) | | | |

The motor will have current wave motion in some specific area. It can improve this situation by setting this parameter. (When it is high frequency or run with PG, Pr.05-17 can be set to 0. when the current wave motion happens in the low frequency, please increase Pr.05-17.)

| | | | | | | |
|--------------|--|------|-----|-------|-------|---------------------|
| 05-18 | Accumulative Motor Operation Time (Min.) | | | | | Unit: 1 |
| Control mode | VF | VFPG | SVC | FOCPG | TQCPG | Factory setting: 00 |
| Settings | 00 to 1439 | | | | | |

| | | |
|--------------|---|---------|
| 05-19 | Accumulative Motor Operation Time (Day) | Unit: 1 |
|--------------|---|---------|

| | | |
|---------------------|--|---------------------|
| Control mode | VF VFPG SVC FOCPG TQCPG | Factory setting: 00 |
|---------------------|--|---------------------|

| | |
|-----------------|-------------|
| Settings | 00 to 65535 |
|-----------------|-------------|

 Pr. 05-18 and Pr.05-19 are used to record the motor operation time. They can be cleared by setting to 00 and time which is less than 60 seconds will not be recorded.

| | | |
|--------------|--|---------|
| 05-20 |  Core Loss Compensation | Unit: 1 |
|--------------|--|---------|

| | | |
|---------------------|------------|---------------------|
| Control mode | SVC | Factory setting: 10 |
|---------------------|------------|---------------------|

| | |
|-----------------|-----------|
| Settings | 0 to 250% |
|-----------------|-----------|

Group 6 Protection Parameters**06-00** Low Voltage Level

Unit: 0.1

| Control mode | VF | VFPG | SVC | FOCPG | TQCPG | FOCPM | |
|--------------|-------------|------|----------------|-------|-------|-------|------------------------|
| Settings | 230V series | | 160.0~220.0Vdc | | | | Factory Setting: 180.0 |
| | 460V series | | 320.0~440.0Vdc | | | | Factory Setting: 360.0 |

It is used to set the Lv level.

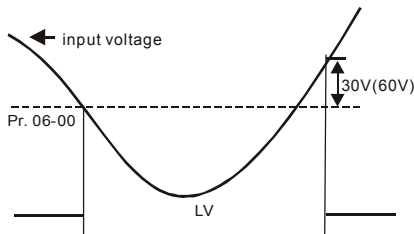
**06-01** ✓ Phase-loss Protection

| Control mode | VF | VFPG | SVC | FOCPG | TQCPG | FOCPM | Factory setting: 2 |
|--------------|----|------|-------------------------|-------|-------|-------|--------------------|
| Settings | 0 | | Warn and keep operation | | | | |
| | 1 | | Warn and ramp to stop | | | | |
| | 2 | | Warn and coast to stop | | | | |

It is used to set the phase-loss treatment. The phase-loss will effect driver's control characteristic and life.

06-02 ✓ Over-Current Stall Prevention during Acceleration

Unit: 1

| Control mode | VF | VFPG | SVC | | Factory setting: 00 |
|--------------|----|------|-----------------------|--|---------------------|
| Settings | | | 00~250% (00: disable) | | |

During acceleration, the AC drive output current may increase abruptly and exceed the value specified by Pr.06-02 due to rapid acceleration or excessive load on the motor. When this function is enabled, the AC drive will stop accelerating and keep the output frequency constant until the current drops below the maximum value.

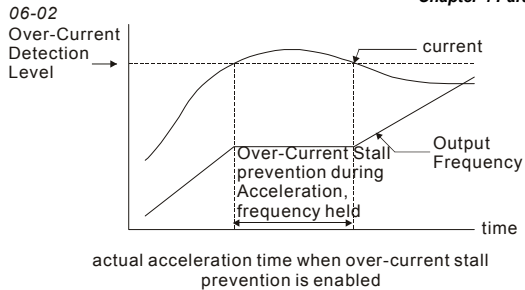
**06-03** **Over-current Stall Prevention during Operation**

Unit: 1

Control mode

VF

VFPG

SVC

Factory setting: 00

Settings 00 to 250% (00: disable)

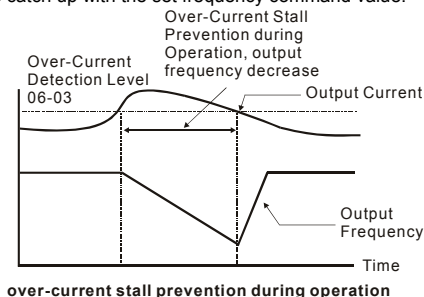

If the output current exceeds the setting specified in Pr.06-03 when the drive is operating, the drive will decrease its output frequency by Pr.06-04 setting to prevent the motor stall. If the output current is lower than the setting specified in Pr.06-03, the drive will accelerate (by Pr.06-04) again to catch up with the set frequency command value.

**06-04** **Accel./Decel. Time Selection of Stall Prevention at constant speed**

Control mode

VF

VFPG

SVC

Factory setting: 0

| Settings | 0 | by current accel/decel time |
|----------|---|-----------------------------|
| | 1 | by the 1st accel/decel time |
| | 2 | by the 2nd accel/decel time |
| | 3 | by the 3rd accel/decel time |
| | 4 | by the 4th accel/decel time |
| | 5 | by auto accel/decel time |

It is used to set the accel./decel. time selection when stall prevention occurs at constant speed.

| 06-05 / Over-torque Detection Selection (OT1) | | | | | | | Factory setting: 0 |
|--|----|------|-----|-------|-------|-------|--|
| Control mode | VF | VFPG | SVC | FOCPG | TQCPG | FOCPM | |
| Settings | | | 0 | | | | Over-Torque detection disabled. |
| | | | 1 | | | | Over-torque detection during constant speed operation, continue to operate after detection |
| | | | 2 | | | | Over-torque detection during constant speed operation, stop operation after detection |
| | | | 3 | | | | Over-torque detection during operation, continue to operate after detection |
| | | | 4 | | | | Over-torque detection during operation, stop operation after detection |

| 06-06 / Over-torque Detection Level (OT1) | | | | | | | Unit: 1 |
|--|----|------|------------|-------|-------|-------|----------------------|
| Control mode | VF | VFPG | SVC | FOCPG | TQCPG | FOCPM | Factory setting: 150 |
| Settings | | | 10 to 250% | | | | |

| 06-07 / Over-torque Detection Time (OT1) | | | | | | | Unit: 0.1 |
|---|----|------|-----------------|-------|-------|-------|----------------------|
| Control mode | VF | VFPG | SVC | FOCPG | TQCPG | FOCPM | Factory setting: 0.1 |
| Settings | | | 0.0 to 60.0 sec | | | | |

| 06-08 / Over-torque Detection Selection (OT2) | | | | | | | Factory setting: 0 |
|--|----|------|-----|-------|-------|-------|--|
| Control mode | VF | VFPG | SVC | FOCPG | TQCPG | FOCPM | |
| Settings | | | 0 | | | | Over-Torque detection disabled. |
| | | | 1 | | | | Over-torque detection during constant speed operation, continue to operate after detection |
| | | | 2 | | | | Over-torque detection during constant speed operation, stop operation after detection |
| | | | 3 | | | | Over-torque detection during operation, continue to operate after detection |
| | | | 4 | | | | Over-torque detection during operation, stop operation after detection |

| 06-09 / Over-torque Detection Level (OT2) | | | | | | | Unit: 1 |
|--|----|------|------------|-------|-------|-------|----------------------|
| Control mode | VF | VFPG | SVC | FOCPG | TQCPG | FOCPM | Factory setting: 150 |
| Settings | | | 10 to 250% | | | | |

06-10 / Over-torque Detection Time (OT2)

Unit: 0.1

Control mode VF VFPG SVC FOCPG TQCPG FOCPM

Factory setting: 0.1

Settings 0.0 to 60.0 sec

 Pr.06-05 and Pr.06-08 determine the operation mode of the drive after the over-torque is detected via the following method: if the output current exceeds the over-torque detection level (Pr.06-06) and also exceeds the Pr.06-07 Over-Torque Detection Time, the fault code "OT1/OT2" is displayed. If a Multi-Functional Output Terminal is to over-torque detection, the output is on. Please refer to Pr.02-11~02-22 for details.

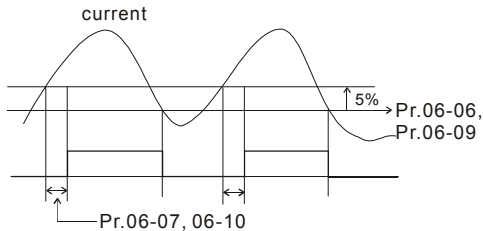
**06-11** / Current Limit

Unit: 1

Control mode FOCPG TQCPG

Factory setting: 150

Settings 0 to 250%

 It is used to set the current limit.

06-12 Electronic Thermal Relay Selection

Control mode VF VFPG SVC FOCPG TQCPG FOCPM

Factory setting: 2

| | | |
|----------|---|----------------|
| Settings | 0 | Inverter motor |
| | 1 | Standard motor |
| | 2 | Disabled |

 It is used to prevent self-cooled motor overheats under low speed. User can use electrical thermal relay to limit driver's output power.

06-13 / Electronic Thermal Characteristic

Unit: 0.1

Control mode VF VFPG SVC FOCPG TQCPG FOCPM

Factory setting: 60.0

Settings 30.0 to 600.0 sec

The parameter is set by the output frequency, current and operation time of the drive for activating the I^2t electronic thermal protection function. The function will be activated for the 150% * setting current for the setting of Pr.06-13.

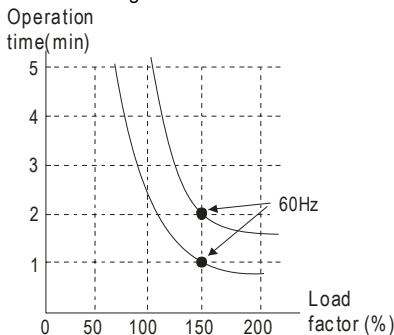

| | | |
|---------------------|------------------------------------|-----------------------|
| 06-14 | ✓ Heat Sink Over-heat (OH) Warning | Unit: 0.1 |
| Control mode | VF VFPG SVC FOCPG TQCPG FOCPM | Factory setting: 85.0 |
| Settings | 0.0 to 110.0 °C | |

| | | |
|---------------------|---|---------------------|
| 06-15 | ✓ Stall Prevention Limit Level | Unit: 1 |
| Control mode | VF VFPG SVC | Factory setting: 50 |
| Settings | 0 to 100% (refer to Pr.06-02, Pr.06-03) | |

When the operating frequency is larger than Pr.01-01, Pr06-02=150%, Pr. 06-03=100% and Pr. 06-15=80%:

Stall Prevention Level during acceleration = $06-02 \times 06-15 = 150 \times 80\% = 120\%$.

Stall Prevention Level at constant speed = $06-03 \times 06-15 = 100 \times 80\% = 80\%$.

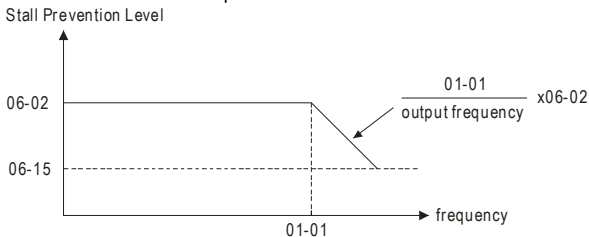

| | |
|--------------|---------------------------------|
| 06-16 | Present Fault Record |
| 06-17 | Second Most Recent Fault Record |
| 06-18 | Third Most Recent Fault Record |
| 06-19 | Fourth Recent Fault Record |
| 06-20 | Fifth Most Recent Fault Record |
| 06-21 | Sixth Most Recent Fault Record |

| Control mode | VF | VFPG | SVC | FOCPG | TQCPG | FOCPM | Factory setting: 0 |
|--------------|----|------|---|-------|-------|-------|--------------------|
| Readings | 0 | | No fault | | | | |
| | 1 | | Over-current during acceleration (ocA) | | | | |
| | 2 | | Over-current during deceleration (ocd) | | | | |
| | 3 | | Over-current during constant speed (ocn) | | | | |
| | 4 | | Ground fault (GFF) | | | | |
| | 5 | | IGBT short-circuit (occ) | | | | |
| | 6 | | Over-current at stop (ocS) | | | | |
| | 7 | | Over-voltage during acceleration (ovA) | | | | |
| | 8 | | Over-voltage during deceleration (ovd) | | | | |
| | 9 | | Over-voltage during constant speed (ovn) | | | | |
| | 10 | | Over-voltage at stop (ovS) | | | | |
| | 11 | | Low-voltage during acceleration (LvA) | | | | |
| | 12 | | Low-voltage during deceleration (Lvd) | | | | |
| | 13 | | Low-voltage during constant speed (Lvn) | | | | |
| | 14 | | Low-voltage at stop (LvS) | | | | |
| | 15 | | Phase loss (PHL) | | | | |
| | 16 | | IGBT heat sink over-heat (oH1) | | | | |
| | 17 | | Heat sink over-heat (oH2)(for 40HP above) | | | | |
| | 18 | | TH1 open loop error (tH1o) | | | | |
| | 19 | | TH2 open loop error (tH2o) | | | | |
| | 20 | | Fan error signal output | | | | |
| | 21 | | Over-load (oL) (150% 1Min) | | | | |
| | 22 | | Motor over-load (EoL1) | | | | |
| | 23 | | Reserved | | | | |
| | 24 | | Motor PTC overheat (oH3) | | | | |
| | 25 | | Reserved | | | | |
| | 26 | | Over-torque 1 (ot1) | | | | |
| | 27 | | Over-torque 1 (ot2) | | | | |
| | 28 | | Reserved | | | | |

| | |
|----|---------------------------------------|
| 29 | Reserved |
| 30 | Memory write-in error (cF1) |
| 31 | Memory read-out error (cF2) |
| 32 | Isum current detection error (cd0) |
| 33 | U-phase current detection error (cd1) |
| 34 | V-phase current detection error (cd2) |
| 35 | W-phase current detection error (cd3) |
| 36 | Clamp current detection error (Hd0) |
| 37 | Over-current detection error (Hd1) |
| 38 | Over-voltage detection error (Hd2) |
| 39 | Ground current detection error (Hd3) |
| 40 | Auto tuning error (AuE) |
| 41 | PID feedback loss (AFE) |
| 42 | PG feedback error (PGF1) |
| 43 | PG feedback loss (PGF2) |
| 44 | PG feedback stall (PGF3) |
| 45 | PG slip error (PGF4) |
| 46 | PG ref input error (PGr1) |
| 47 | PG ref loss (PGr2) |
| 48 | Analog current input error (ACE) |
| 49 | External fault input (EF) |
| 50 | Emergency stop (EF1) |
| 51 | Reserved |
| 52 | Password error (PcodE) |
| 53 | Reserved |
| 54 | Communication error (cE1) |
| 55 | Communication error (cE2) |
| 56 | Communication error (cE3) |
| 57 | Communication error (cE4) |
| 58 | Communication Time-out (cE10) |

| | |
|-------|------------------------------|
| 59 | PU time-out (cP10) |
| 60 | Brake chopper error (bF) |
| 61-62 | Reserved |
| 63 | Safety loop error (Sry) |
| 64 | Mechanical brake error (MBF) |
| 65 | PGF5 hardware error |

 It will record when the fault occurs and force stopping. For the Lv, it will record when it is operation, or it will warn without record.

06-30 Setting Method of Fault Output

| Control mode | VF | VFP | SVC | FOCPG | TQCPG | FOCPM | Factory setting: 0 |
|--------------|----|-----|-------------------------------|-------|-------|-------|--------------------|
| Settings | | 0 | By settings of Pr.06-22~06-25 | | | | |
| | | 1 | By the binary setting | | | | |

 It is used with the settings 35~38 of Pr.02-11~02-22 (Multi-function Output). The fault output selection 1~4 corresponds to Bit 0~3.

 This parameter provides two setting methods for the fault output: setting 0: it is set by the settings of Pr.06-22~Pr.06-25; setting 1: it is set by the binary setting and please refer to the following example for details.

Example:

Assume that

Pr.02-15 (Multi-function Output 5 (MO3)) is set to 35 Fault output option 1 (Pr.06-22).

Pr.02-17 (Multi-function Output 7 (MO5)) is set to 36 Fault output option 2 (Pr.06-23).

Pr.02-19 (Multi-function Output 9 (MO7)) is set to 37 Fault output option 3 (Pr.06-24).

Pr.02-21 (Multi-function Output 11 (MO9)) is set to 38 Fault output option 4 (Pr.06-25).

Assume that external faults output with the following signal: MO3=1, MO5=1, MO7=0 and MO9=1. The corresponding Bit 3~0 is 1011.

| Bit 3 | Bit 2 | Bit 1 | Bit 0 | Fault code |
|-------|-------|-------|-------|---|
| - | - | - | - | 0: No fault |
| 0 | 0 | 0 | 1 | 1: Over-current during acceleration (ocA) |
| | | | | 2: Over-current during deceleration (ocd) |
| | | | | 3: Over-current during constant speed (ocn) |
| | | | | 4: Ground fault (GFF) |
| | | | | 5: IGBT short-circuit (occ) |
| 0 | 0 | 1 | 0 | 6: Over-current at stop (ocS) |
| | | | | 7: Over-voltage during acceleration (ovA) |
| | | | | 8: Over-voltage during deceleration (ovd) |

| Bit 3 | Bit 2 | Bit 1 | Bit 0 | Fault code |
|-------|-------|-------|-------|--|
| | | | | 9: Over-voltage during constant speed (ovn) 10: Over-voltage at stop (ovS) |
| 0 | 0 | 1 | 1 | 11: Low-voltage during acceleration (LvA) 12: Low-voltage during deceleration (Lvd) 13: Low-voltage during constant speed (Lvn) 14: Low-voltage at stop (LvS) 15: Phase loss (PHL) |
| 0 | 1 | 0 | 0 | 16: IGBT heat sink over-heat (oH1) 17: Heat sink over-heat (oH2)(for 40HP above) 18: TH1 open loop error (tH1o) 19: TH2 open loop error (tH2o) |
| 1 | 0 | 0 | 0 | 20: Fan error signal output |
| 0 | 1 | 0 | 1 | 21: over-load (oL) (150% 1Min) |
| 0 | 1 | 1 | 0 | 22: Motor 1 over-load (EoL1) 24: Motor PTC overheat (oH3) |
| 0 | 1 | 1 | 1 | 26: over-torque 1 (ot1) 27: over-torque 1 (ot2) |
| 1 | 0 | 0 | 0 | 30: Memory write-in error (cF1) 31: Memory read-out error (cF2) 32: Isum current detection error (cd0) 33: U-phase current detection error (cd1) 34: V-phase current detection error (cd2) 35: W-phase current detection error (cd3) 36: Clamp current detection error (Hd0) 37: Over-current detection error (Hd1) 38: Over-voltage detection error (Hd2) 39: Ground current detection error (Hd3) |
| 1 | 0 | 0 | 1 | 40: Auto tuning error (AuE) |
| 1 | 0 | 1 | 0 | 41: PID feedback loss (AFE) 42: PG feedback error (PGF1) 43: PG feedback loss (PGF2) |
| 0 | 1 | 1 | 1 | 44: PG feedback stall (PGF3) |
| 1 | 0 | 1 | 0 | 45: PG slip error (PGF4) 46: PG ref input error (PGr1) 47: PG ref loss (PGr2) |
| 1 | 0 | 1 | 1 | 48: Analog current input error (ACE) 49: External fault input (EF) 50: Emergency stop (EF1) |
| 1 | 0 | 0 | 1 | 52: Password error (Pcode) |
| 1 | 1 | 0 | 0 | 54: Communication error (cE1) 55: Communication error (cE2) 56: Communication error (cE3) 57: Communication error (cE4) 58: Communication Time-out (cE10) 59: PU time-out (cP10) |
| 1 | 0 | 0 | 0 | 60: Brake chopper error (bF) |
| 1 | 0 | 1 | 1 | 63: Safety loop error (Sry) |
| 1 | 0 | 0 | 0 | 64: Mechanical brake error (MBF) 65: PGF5 hardware error |

| | | |
|---------------------|--|--------------------|
| 06-22 | ✗ Fault Output Option 1 | Unit: 1 |
| 06-23 | ✗ Fault Output Option 2 | Unit: 1 |
| 06-24 | ✗ Fault Output Option 3 | Unit: 1 |
| 06-25 | ✗ Fault Output Option 4 | Unit: 1 |
| Control mode | VF VFP SVC FOCPG TQCPG FOCPM | Factory setting: 0 |

Settings 0 to 65535 sec (refer to bit table for fault code)

-  These parameters can be used with multi-function output (set Pr.02-11 to Pr.02-22 to 35-38) for the specific requirement. When the fault occurs, the corresponding terminals will be activated (It needs to convert binary value to decimal value to fill in Pr.06-22 to Pr.06-25).

| Fault code | Bit0 | Bit1 | Bit2 | Bit3 | Bit4 | Bit5 | Bit6 |
|---|---------|-------|------|------|------|------|------|
| | current | Volt. | OL | SYS | FBK | EXI | CE |
| 0: No fault | | | | | | | |
| 1: Over-current during acceleration (ocA) | ● | | | | | | |
| 2: Over-current during deceleration (ocd) | ● | | | | | | |
| 3: Over-current during constant speed (ocn) | ● | | | | | | |
| 4: Ground fault (GFF) | | | | | | ● | |
| 5: IGBT short-circuit (occ) | ● | | | | | | |
| 6: Over-current at stop (ocS) | ● | | | | | | |
| 7: Over-voltage during acceleration (ovA) | | ● | | | | | |
| 8: Over-voltage during deceleration (ovd) | | ● | | | | | |
| 9: Over-voltage during constant speed (ovn) | | ● | | | | | |
| 10: Over-voltage at stop (ovS) | | ● | | | | | |
| 11: Low-voltage during acceleration (LvA) | | ● | | | | | |
| 12: Low-voltage during deceleration (Lvd) | | ● | | | | | |
| 13: Low-voltage during constant speed (Lvn) | | ● | | | | | |
| 14: Low-voltage at stop (LvS) | | ● | | | | | |

| Fault code | Bit0 | Bit1 | Bit2 | Bit3 | Bit4 | Bit5 | Bit6 |
|---|---------|-------|------|------|------|------|------|
| | current | Volt. | OL | SYS | FBK | EXI | CE |
| 15: Phase loss (PHL) | | | | | | ● | |
| 16: IGBT heat sink over-heat (oH1) | | | ● | | | | |
| 17: Heat sink over-heat (oH2)(for 40HP above) | | | ● | | | | |
| 18: TH1 open loop error (tH1o) | | | ● | | | | |
| 19: TH2 open loop error (tH2o) | | | ● | | | | |
| 20: Fan error signal output | | | | | | ● | |
| 21: over-load (oL) (150% 1Min) | | | ● | | | | |
| 22: Motor 1 over-load (EoL1) | | | ● | | | | |
| 23: Reserved | | | | | | | |
| 24: Motor PTC overheat (oH3) | | | ● | | | | |
| 25: Reserved | | | | | | | |
| 26: over-torque 1 (ot1) | | | ● | | | | |
| 27: over-torque 1 (ot2) | | | ● | | | | |
| 28: Reserved | | | | | | | |
| 29: Reserved | | | | | | | |
| 30: Memory write-in error (cF1) | | | | ● | | | |
| 31: Memory read-out error (cF2) | | | | ● | | | |
| 32: Isum current detection error (cd0) | | | | ● | | | |
| 33: U-phase current detection error (cd1) | | | | ● | | | |
| 34: V-phase current detection error (cd2) | | | | ● | | | |
| 35: W-phase current detection error (cd3) | | | | ● | | | |
| 36: Clamp current detection error (Hd0) | | | | ● | | | |
| 37: Over-current detection error (Hd1) | | | | ● | | | |
| 38: Over-voltage detection error (Hd2) | | | | ● | | | |

| Fault code | Bit0 | Bit1 | Bit2 | Bit3 | Bit4 | Bit5 | Bit6 |
|--|---------|-------|------|------|------|------|------|
| | current | Volt. | OL | SYS | FBK | EXI | CE |
| 39: Ground current detection error (Hd3) | | | | ● | | | |
| 40: Auto tuning error (AuE) | | | | ● | | | |
| 41: PID feedback loss (AFE) | | | | | ● | | |
| 42: PG feedback error (PGF1) | | | | | ● | | |
| 43: PG feedback loss (PGF2) | | | | | ● | | |
| 44: PG feedback stall (PGF3) | | | | | ● | | |
| 45: PG slip error (PGF4) | | | | | ● | | |
| 46: PG ref input error (PGr1) | | | | | ● | | |
| 47: PG ref loss (PGr2) | | | | | | ● | |
| 48: Analog current input error (ACE) | | | | | | ● | |
| 49: External fault input (EF) | | | | | | ● | |
| 50: Emergency stop (EF1) | | | | | | ● | |
| 51: Reserved | | | | | | | |
| 52: Password error (PcodE) | | | | ● | | | |
| 53: Reserved | | | | | | | |
| 54: Communication error (cE1) | | | | | | | ● |
| 55: Communication error (cE2) | | | | | | | ● |
| 56: Communication error (cE3) | | | | | | | ● |
| 57: Communication error (cE4) | | | | | | | ● |
| 58: Communication Time-out (cE10) | | | | | | | ● |
| 59: PU time-out (cP10) | | | | | | | ● |
| 60: Brake chopper error (bF) | | | | | | ● | |
| 61-62: Reserved | | | | | | | |
| 63: Safety loop error (Sry) | | | | ● | | | |
| 64: Mechanical brake error (MBF) | | | | | | ● | |
| 65: PGF5 hardware error | | | | ● | | | |

06-26 / PTC (Positive Temperature Coefficient) Detection Selection

| Control mode | VF | VFPG | SVC | FOCPG | TQCPG | FOCPM | Factory setting: 0 |
|--------------|----|------|-----|-------------------------|-------|-------|--------------------|
| Settings | | 0 | | Warn and keep operating | | | |
| | | 1 | | Warn and ramp to stop | | | |

 It is used to set the treatment after detecting PTC.

06-27 / PTC Level Unit: 0.1

| Control mode | VF | VFPG | SVC | FOCPG | TQCPG | FOCPM | Factory setting: 50.0 |
|--------------|----|---------------|-----|-------|-------|-------|-----------------------|
| Settings | | 0.0 to 100.0% | | | | | |

 It is used to set the PTC level, and the corresponding value for 100% is max. analog input value.

06-28 / Filter Time for PTC Detection Unit: 0.01

| Control mode | VF | VFPG | SVC | FOCPG | TQCPG | FOCPM | Factory setting: 0.20 |
|--------------|----|-------------------|-----|-------|-------|-------|-----------------------|
| Settings | | 0.00 to 10.00 sec | | | | | |

06-29 EPS Voltage Unit: 0.1

| Control mode | VF | VFPG | SVC | FOCPG | TQCPG | FOCPM | Factory setting: 48.0 |
|--------------|----|---------------|-----|-------|-------|-------|-----------------------|
| Settings | | 48.0~375.0Vdc | | | | | |
| | | 96.0~750.0Vdc | | | | | Factory setting: 96.0 |

 It is used with the setting 43 (EPS function) of Pr.02-01~02-08 (Multi-Function Input Command).

Group 7 Special Parameters

| | | |
|--------------|---|-----------|
| 07-00 |  Brake Chopper Level | Unit: 0.1 |
|--------------|---|-----------|

| Control mode | VF | VFPG | SVC | FOCPG | TQCPG | FOCPM | |
|--------------|-------------|------|----------------|-------|-------|-------|------------------------|
| Settings | 230V series | | 350.0~450.0Vdc | | | | Factory Setting: 380.0 |
| | 460V series | | 700.0~900.0Vdc | | | | Factory Setting: 760.0 |

 This parameter sets the DC-bus voltage at which the brake chopper is activated.

| | | |
|--------------|------------------------|---------|
| 07-01 | Brake ED Value Setting | Unit: 1 |
|--------------|------------------------|---------|

| Control mode | VF | VFPG | SVC | FOCPG | TQCPG | FOCPM | |
|--------------|----|------|------------------------|-------|-------|-------|----------------------|
| Settings | | | 0 to 100% (0: disable) | | | | Factory Setting: 100 |

| | | |
|--------------|--|---------|
| 07-02 |  DC Brake Current Level | Unit: 1 |
|--------------|--|---------|

| Control mode | VF | VFPG | SVC | | | | |
|--------------|----|------|-----------|--|--|--|--------------------|
| Settings | | | 0 to 100% | | | | Factory Setting: 0 |

 This parameter sets the level of DC Brake Current output to the motor during start-up and stopping. When setting DC Brake Current, the Rated Current (Pr.00-01) is regarded as 100%. It is recommended to start with a low DC Brake Current Level and then increase until proper holding torque has been attained.

 When it is in FOCPG/TQCPG/FOCPM mode, it can enable DC brake function by setting to any value.

| | | |
|--------------|---|-----------|
| 07-03 |  DC Brake Time during Start-up | Unit: 0.1 |
|--------------|---|-----------|

| Control mode | VF | VFPG | SVC | FOCPG | FOCPM | |
|--------------|----|------|-----------------|-------|-------|----------------------|
| Settings | | | 0.0 to 60.0 sec | | | Factory Setting: 0.0 |

 This parameter determines the duration of the DC Brake current after a RUN command.

| | | |
|--------------|---|-----------|
| 07-04 |  DC Brake Time during Stopping | Unit: 0.1 |
|--------------|---|-----------|

| Control mode | VF | VFPG | SVC | FOCPG | FOCPM | |
|--------------|----|------|-----------------|-------|-------|----------------------|
| Settings | | | 0.0 to 60.0 sec | | | Factory Setting: 0.0 |

 This parameter determines the duration of the DC Brake current during stopping.

| | | |
|--------------|--------------------------|------------|
| 07-05 | Start-Point for DC Brake | Unit: 0.01 |
|--------------|--------------------------|------------|

| | | | | | |
|--------------|----|------|-----|-------|-----------------------|
| Control mode | VF | VFPG | SVC | FOCPG | Factory Setting: 0.00 |
|--------------|----|------|-----|-------|-----------------------|

| | |
|----------|------------------|
| Settings | 0.00 to 120.00Hz |
|----------|------------------|

- This parameter determines the frequency when DC Brake will begin during deceleration. When the setting is less than start frequency (Pr.01-09), start-point for DC brake will begin from the min. frequency.

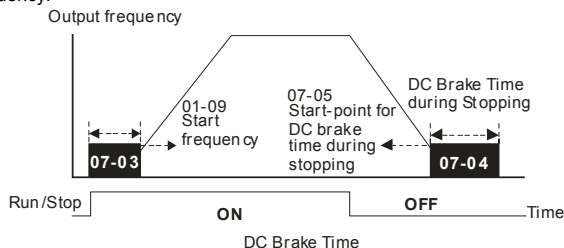

| | | |
|--------------|----------------------------|---------|
| 07-06 | DC Brake Proportional Gain | Unit: 1 |
|--------------|----------------------------|---------|

| | | | | |
|--------------|----|------|-----|---------------------|
| Control mode | VF | VFPG | SVC | Factory Setting: 50 |
|--------------|----|------|-----|---------------------|

| | |
|----------|------------|
| Settings | 1 to 500Hz |
|----------|------------|

- It is used to set the output voltage gain when DC brake.

| | | |
|--------------|----------------------|------------|
| 07-07 | Dwell Time at Accel. | Unit: 0.01 |
|--------------|----------------------|------------|

| | | | | | | |
|--------------|----|------|-----|-------|-------|-----------------------|
| Control mode | VF | VFPG | SVC | FOCPG | FOCPM | Factory Setting: 0.00 |
|--------------|----|------|-----|-------|-------|-----------------------|

| | |
|----------|--------------------|
| Settings | 0.00 to 600.00 sec |
|----------|--------------------|

| | | |
|--------------|---------------------------|------------|
| 07-08 | Dwell Frequency at Accel. | Unit: 0.01 |
|--------------|---------------------------|------------|

| | | | | | | |
|--------------|----|------|-----|-------|-------|-----------------------|
| Control mode | VF | VFPG | SVC | FOCPG | FOCPM | Factory Setting: 0.00 |
|--------------|----|------|-----|-------|-------|-----------------------|

| | |
|----------|-------------------|
| Settings | 0.00 to 120.00 Hz |
|----------|-------------------|

| | | |
|--------------|----------------------|------------|
| 07-09 | Dwell Time at Decel. | Unit: 0.01 |
|--------------|----------------------|------------|

| | | | | | | |
|--------------|----|------|-----|-------|-------|-----------------------|
| Control mode | VF | VFPG | SVC | FOCPG | FOCPM | Factory Setting: 0.00 |
|--------------|----|------|-----|-------|-------|-----------------------|

| | |
|----------|--------------------|
| Settings | 0.00 to 600.00 sec |
|----------|--------------------|

| | | |
|--------------|---------------------------|------------|
| 07-10 | Dwell Frequency at Decel. | Unit: 0.01 |
|--------------|---------------------------|------------|

| | | | | | | |
|--------------|----|------|-----|-------|-------|-----------------------|
| Control mode | VF | VFPG | SVC | FOCPG | FOCPM | Factory Setting: 0.00 |
|--------------|----|------|-----|-------|-------|-----------------------|

| | |
|----------|-------------------|
| Settings | 0.00 to 120.00 Hz |
|----------|-------------------|

- In the heavy load situation, Dwell can make stable output frequency temporarily.

Pr.07-07 to Pr.07-10 are for heavy load to prevent OV or OC occurs.

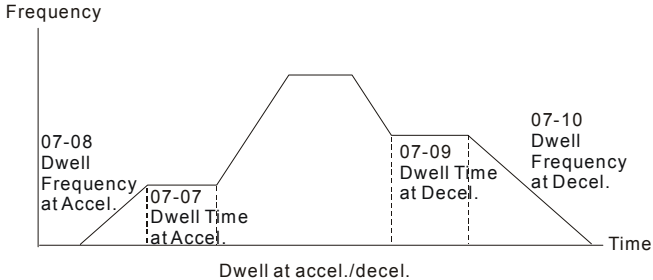

07-11 Fan Control

| Control mode | VF | VFPG | SVC | FOCPG | TQCPG | FOCPM | Factory Setting: 2 |
|--------------|----|------|--|-------|-------|-------|--------------------|
| Settings | | 0 | Fan always ON | | | | |
| | | 1 | 1 minute after AC motor drive stops, fan will be OFF | | | | |
| | | 2 | AC motor drive runs and fan ON, AC motor drive stops and fan OFF | | | | |
| | | 3 | Fan ON to run when preliminary heat sink temperature attained | | | | |
| | | 4 | Fan always OFF | | | | |

This parameter is used for the fan control.

When setting to 3, fan will start to run until temperature is less than 40°C if temperature exceeds 40°C.

07-12 Torque Command

Unit: 0.1

| Control mode | TQCPG | Factory Setting: 0.0 |
|--------------|---|----------------------|
| Settings | -100.0 to 100.0% (Pr. 07-14 setting=100%) | |

This parameter is torque command. When Pr.07-14 is 250% and Pr.07-12 is 100%, the actual torque command = 250X100% X motor rated torque.

07-13 Torque Command Source

| Control mode | TQCPG | Factory Setting: 2 |
|--------------|-------|------------------------------------|
| Settings | 0 | Digital keypad |
| | 1 | RS485 serial communication (RJ-11) |
| | 2 | Analog signal (Pr.03-00) |

 This parameter is torque command source and the torque command is in Pr.07-12.

| | | |
|---------------------|---------------------------------|----------------------|
| 07-14 | ✓ Maximum Torque Command | Unit: 1 |
| Control mode | VF VFPG SVC FOC PG TQCPG FOC PM | Factory Setting: 100 |
| Settings | 0 to 500% | |

 This parameter is for the max. torque command (motor rated torque is 100%).

| | | |
|---------------------|---------------------------------|------------------------|
| 07-15 | ✓ Filter Time of Torque Command | Unit: 0.001 |
| Control mode | TQCPG | Factory Setting: 0.000 |
| Settings | 0.000 to 1.000 sec | |

 When the setting is too long, the control will be stable but the control response will be delay.
When the setting is too short, the response will be quickly but the control maybe unstable.
User can adjust the setting by the control and response situation.

| | | |
|---------------------|---|--------------------|
| 07-16 | Speed Limit Selection | Factory Setting: 0 |
| Control mode | TQCPG | Factory Setting: 0 |
| Settings | 0 By Pr.07-17 and Pr.07-18 1 Frequency command source (Pr.00-14) | |

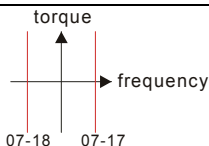

Pr.07-16=0
Running/opposite running direction are limited by Pr.07-17 and Pr.07-18.

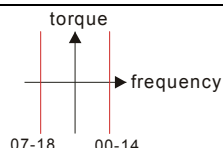

Pr.07-16=1
When it is forward running, running direction is limited by Pr.00-14
opposite running direction is limited by Pr.07-18.

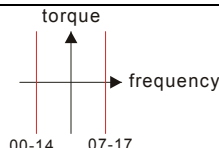

Pr.07-16=1
When it is reverse running, running direction is limited by Pr.07-17
opposite running direction is limited by Pr.00-14.

| | | |
|---------------------|---------------------------|---------------------|
| 07-17 | ✓ Torque Mode+Speed Limit | Unit: 1 |
| 07-18 | ✓ Torque Mode-Speed Limit | Unit: 1 |
| Control mode | TQCPG | Factory Setting: 10 |
| Settings | 0 to 120% | |

 These parameters are used in the torque mode to limit the running direction and opposite direction. (Pr.01-00 max. output frequency=100%)

07-19 / Source of Torque Offset

| Control mode | SVC | FOCPG | TQCPG | FOCPM | Factory Setting: 0 |
|--------------|-----|--|-------|-------|--------------------|
| Settings | 0 | Disable | | | |
| | 1 | Analog input (Pr.03-00) | | | |
| | 2 | Torque offset setting (Pr.07-20) | | | |
| | 3 | Control by external terminal (by Pr.07-21 to Pr.07-23) | | | |

 This parameter is the source of torque offset.

 When it is set to 3, the source of torque offset will decide to Pr.07-21, Pr.07-22 and Pr.07-23 by the multi-function input terminals setting (19, 20 or 21).

| 02-01~02-08 is set to 19 | 02-01~02-08 is set to 20 | 02-01~02-08 is set to 21 | Torque offset |
|--------------------------|--------------------------|--------------------------|-------------------|
| OFF | OFF | OFF | None |
| OFF | OFF | ON | 07-25 |
| OFF | ON | OFF | 07-24 |
| OFF | ON | ON | 07-25+07-24 |
| ON | OFF | OFF | 07-23 |
| ON | OFF | ON | 07-23+07-25 |
| ON | ON | OFF | 07-23+07-24 |
| ON | ON | ON | 07-23+07-24+07-25 |

07-20 / Torque Offset Setting

Unit: 0.1

| Control mode | SVC | FOCPG | TQCPG | FOCPM | Factory Setting: 0.0 |
|--------------|---------------|-------|-------|-------|----------------------|
| Settings | 0.0 to 100.0% | | | | |

 This parameter is torque offset. The motor rated torque is 100%.

07-21 / High Torque Offset

Unit: 0.1

| Control mode | SVC | FOCPG | TQCPG | FOCPM | Factory Setting: 30.0 |
|--------------|---------------|-------|-------|-------|-----------------------|
| Settings | 0.0 to 100.0% | | | | |

07-22 / Middle Torque Offset

Unit: 0.1

| Control mode | SVC | FOCPG | TQCPG | FOCPM | Factory Setting: 20.0 |
|--------------|---------------|-------|-------|-------|-----------------------|
| Settings | 0.0 to 100.0% | | | | |

07-23 / Low Torque Offset

Unit: 0.1

Control mode SVC FOC PG TQCPG FOC PM

Factory Setting: 10.0

Settings 0.0 to 100.0%

When it is set to 3, the source of torque offset will decide to Pr.07-21, Pr.07-22 and Pr.07-23 by the multi-function input terminals setting (19, 20 or 21). The motor rated torque is 100%.

07-24 / Forward Motor Torque Limit

Unit: 1

07-25 / Forward Regenerative Torque Limit

Unit: 1

07-26 / Reverse Motor Torque Limit

Unit: 1

07-27 / Reverse Regenerative Torque Limit

Unit: 1

Control mode FOC PG TQCPG FOC PM

Factory Setting: 200

Settings 0 to 500%

The motor rated torque is 100%. The settings for Pr.07-24 to Pr.07-27 will compare with Pr.03-00=5, 6, 7, 8. The minimum of the comparison result will be torque limit.

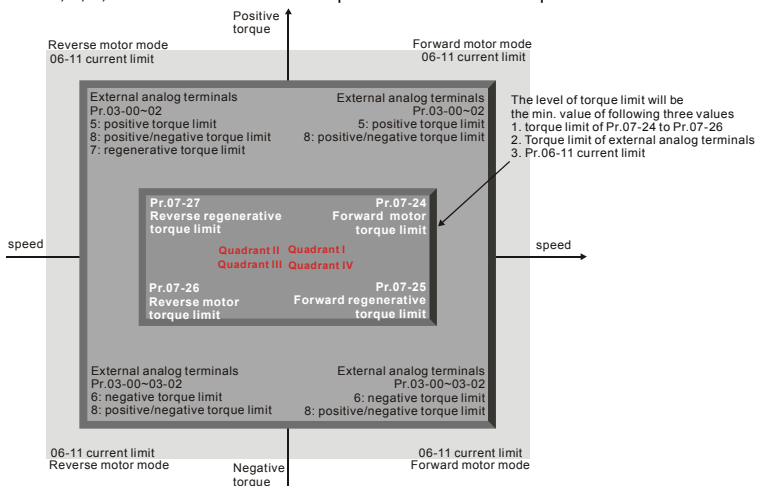

07-28  Emergency Stop (EF) & Forced Stop Selection

| Control mode | VF | VFPG | SVC | FOCPG | TQCPG | FOCPM | Factory Setting: 0 |
|--------------|----|------|-----|-------|-------|-------|--------------------|
|--------------|----|------|-----|-------|-------|-------|--------------------|

| | | | | | | | |
|----------|---|------------------------|--|--|--|--|--|
| Settings | 0 | Coast to stop | | | | | |
| | 1 | By deceleration Time 1 | | | | | |
| | 2 | By deceleration Time 2 | | | | | |
| | 3 | By deceleration Time 3 | | | | | |
| | 4 | By deceleration Time 4 | | | | | |
| | 5 | By Pr.01-31 | | | | | |

 When the multi-function input terminal is set to 10 or 14 and it is ON, the AC motor drive will be operated by Pr.07-28.

07-29  Time for Decreasing Torque at Stop

Unit: 0.001

| Control mode | FOCPG | TQCPG | FOCPM | Factory Setting: 0.000 |
|--------------|-------|-------|-------|------------------------|
|--------------|-------|-------|-------|------------------------|

| | | | |
|----------|--------------------|--|--|
| Settings | 0.000 to 1.000 sec | | |
|----------|--------------------|--|--|

 It is used to set the time for decreasing torque to 0%.

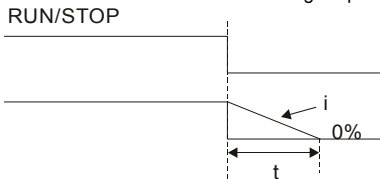

$$\frac{i}{00-01} \times \frac{100\%}{300\%} \times (07-29) = t$$

Group 8 PM Motor Parameters

08-00 Motor Auto Tuning

Control mode

FOCPM

Factory setting: 0

| | | |
|----------|---|--|
| Settings | 0 | No function |
| | 1 | Only for the unloaded motor, auto measure the angle between magnetic field and PG origin (08-09) |
| | 2 | For PM motor parameters |
| | 3 | Auto measure the angle between magnetic field and PG origin (08-09) |

 For setting 1: It can auto measure the angle between magnetic field and PG origin. Please notice the following items when measuring:

1. Please unload before tuning.
2. If brake is controlled by drive, the drive will act by the normal operation to finish tuning after wiring and setting brake control parameters.
3. If brake is controlled by the host controller, it needs to make sure that brake is in release state before tuning.

 For setting 2: Starting auto tuning by pressing RUN key and it will write the measure value into Pr.08-05 to Pr.08-07 (Rs, Lq).

The steps to AUTO-Tuning are: (Dynamic measure)

1. Make sure that all the parameters are set to factory settings and the motor wiring is correct.
2. Motor: Fill in Pr.08-01, Pr.08-02, Pr.08-03 and Pr.08-04 with correct values. Refer to motor capacity to set accel./decel. time.
3. When Pr.08-00 is set to 2, the AC motor drive will execute auto-tuning immediately after receiving a "RUN" command. (NOTE: the motor will run! The shaft needs to be locked with external force.)
4. After executing, please check if all values are filled in Pr.08-05 and Pr.08-07.

 For setting 3: It can auto measure the angle between magnetic field and PG origin. Please notice the following items when measuring:

1. It can be loaded motor or unloaded motor before tuning.
2. If brake is controlled by drive, the drive will act by the normal operation to finish tuning after wiring and setting brake control parameters.
3. If brake is controlled by the host controller, it needs to make sure that brake is in release state before tuning.

**NOTE**

- The rated speed can't be larger or equal to 120f/p.
- Please notice that if the electromagnetic valve and brake is not controlled by the AC motor drive, please release it by manual.
- It is recommended to set Pr.08-00 to 1 (unloaded motor) for the accurate calculation. If it needs to execute this function with loaded motor, please balance the carriage before execution.
- if it doesn't allow balancing the carriage in the measured environment, it can set Pr.08-00=3 for executing this function. It can execute this function with loaded motor by setting Pr.08-00=3. It will have a difference of 15~30° by the different encoder type.
- It will display the warning message "Auto tuning" on the digital keypad during measuring until the measure is finished. Then, the result will be saved into Pr.08-09.
- It will display "Auto Tuning Err" on the keypad when stopping by the fault of the AC motor drive or human factor to show the failed detection. At this moment, please check the connections of the wirings of the AC motor drives. If it displays "PG Fbk Error" on the digital keypad, please change the setting of Pr.10-02 (if it is set to 1, please change it to 2). If it displays "PG Fbk Loss" on the digital keypad, please check the feedback of Z-phase pulse.

08-01 Full-load Current of MotorControl mode **FOCPM**Factory setting: **###**

Settings 40 to 120%



This value should be set according to the rated frequency of the motor as indicated on the motor nameplate. The factory setting is 90% X rated current.

Example: if the rated current for 7.5hp (5.5kW) models is 25A and the factory setting is 22.5A.

In this way, the current range will be from 10A (25*40%) to 30A (25*120%).

08-02  Rated Power of Motor

Unit: 0.01

Control mode **FOCPM**Factory setting: **###**

Settings 0.00 to 655.35 kW



It is used to set rated power of the motor. The factory setting is the power of the drive.

| | | |
|---------------------|------------------------------|-----------------------|
| 08-03 | ✓ Rated Speed of Motor (rpm) | Unit: 1 |
| Control mode | FOCPM | Factory setting: 1710 |
| | Settings | 0 to 65535 |

 It is used to set the rated speed of the motor and need to set according to the value indicated on the motor nameplate.

| | | |
|---------------------|-----------------------|--------------------|
| 08-04 | Number of Motor Poles | |
| Control mode | FOCPM | Factory setting: 4 |
| | Settings | 2 to 96 |

 It is used to set the number of motor poles (must be an even number).

| | | |
|---------------------|--------------|------------------------|
| 08-05 | Rs of Motor | Unit: 0.001 |
| Control mode | FOCPM | Factory setting: 0.000 |
| | Settings | 0.000~65.535Ω |



| | | |
|---------------------|--------------|----------------------|
| 08-06 | Ld of Motor | Unit: 0.1 |
| Control mode | FOCPM | Factory setting: 0.0 |

| | | |
|---------------------|--------------|----------------------|
| 08-07 | Lq of Motor | Unit: 0.1 |
| Control mode | FOCPM | Factory setting: 0.0 |
| | Settings | 0.0~6553.5mH |

| | | |
|---------------------|--|------------------------|
| 08-08 | Reserved | |
| 08-09 | Angle between Magnetic Field and PG Origin | Unit: 0.1 |
| Control mode | FOCPM | Factory setting: 360.0 |
| | Settings | 0.0~360.0° |

 This function is used to measure the angle between magnetic field and PG origin.

| | | |
|---------------------|-------------------------------|-----------------------|
| 08-10 | Magnetic Field Re-orientation | |
| Control mode | FOCPM | Factory setting: 0 |
| | Settings | 0 Disable 1 Enable |

-  This function is used for searching magnetic field position and only for permanent magnet motor.
-  When it doesn't have origin-adjustment for encoder (Pr.08-09 is 360.0), it can only ensure that the motor operation efficiency can be up to 86% of the best efficiency. In this situation, when the operation efficiency needs to be improved, user can re-power on or set Pr.08-10 to 1 to get the magnetic field orientation.

Group 9: Communication Parameters

When the AC motor drive is controlled by RS-485 serial communication, a converter, VFD-USB01 or IFD8500, should be connected between the AC motor drive and PC.

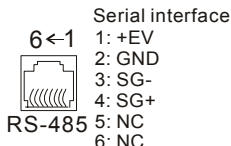
**09-00** ✓ Communication Address

| Control mode | VF | VFPG | SVC | FOCPG | TQCPG | FOCPM | Factory Setting: 1 |
|--------------|----|------|----------|-------|-------|-------|--------------------|
| Settings | | | 1 to 254 | | | | |

If the AC motor drive is controlled by RS-485 serial communication, the communication address for this drive must be set via this parameter. And the communication address for each AC motor drive must be different and unique.

09-01 ✓ Transmission Speed

Unit: 0.1

| Control mode | VF | VFPG | SVC | FOCPG | TQCPG | FOCPM | Factory Setting: 9.6 |
|--------------|----|------|------------------|-------|-------|-------|----------------------|
| Settings | | | 4.8 to 115.2kbps | | | | |

This parameter is used to set the transmission speed between the RS485 master (PLC, PC, etc.) and AC motor drive.

09-02 ✓ Transmission Fault Treatment

| Control mode | VF | VFPG | SVC | FOCPG | TQCPG | FOCPM | Factory Setting: 3 |
|--------------|----|------|-----|--------------------------|-------|-------|--------------------|
| Settings | | | 0 | Warn and keep operating | | | |
| | | | 1 | Warn and RAMP to stop | | | |
| | | | 2 | Reserved | | | |
| | | | 3 | No action and no display | | | |

This parameter is set to how to react if transmission errors occur.

09-03 ✓ Time-out Detection

Unit: 0.1

| Control mode | VF | VFPG | SVC | FOCPG | TQCPG | FOCPM | Factory Setting: 0.0 |
|--------------|----|------|--------------------------------|-------|-------|-------|----------------------|
| Settings | | | 0.0 ~ 100.0 sec (0.0: disable) | | | | |

It is used to set the communication time-out time.

09-04 Communication Protocol

| Control mode | VF | VFPG | SVC | FOCPG | TQCPG | FOCPM | Factory Setting: 13 |
|--------------|----|-----------------------------------|-------------------------------------|-------|-------|-------|---------------------|
| Settings | | 0 | Modbus ASCII mode, protocol <7,N,1> | | | | |
| | | 1 | Modbus ASCII mode, protocol <7,N,2> | | | | |
| | | 2 | Modbus ASCII mode, protocol <7,E,1> | | | | |
| | | 3 | Modbus ASCII mode, protocol <7,O,1> | | | | |
| | | 4 | Modbus ASCII mode, protocol <7,E,2> | | | | |
| | | 5 | Modbus ASCII mode, protocol <7,O,2> | | | | |
| | | 6 | Modbus ASCII mode, protocol <8,N,1> | | | | |
| | | 7 | Modbus ASCII mode, protocol <8,N,2> | | | | |
| | | 8 | Modbus ASCII mode, protocol <8,E,1> | | | | |
| | | 9 | Modbus ASCII mode, protocol <8,O,1> | | | | |
| | | 10 | Modbus ASCII mode, protocol <8,E,2> | | | | |
| | | 11 | Modbus ASCII mode, protocol <8,O,2> | | | | |
| | | 12 | Modbus RTU mode, protocol <8,N,1> | | | | |
| | | 13 | Modbus RTU mode, protocol <8,N,2> | | | | |
| | | 14 | Modbus RTU mode, protocol <8,E,1> | | | | |
| | | 15 | Modbus RTU mode, protocol <8,O,1> | | | | |
| | | 16 | Modbus RTU mode, protocol <8,E,2> | | | | |
| | 17 | Modbus RTU mode, protocol <8,O,2> | | | | | |

1. Control by PC or PLC

- ★ A VFD-VL can be set up to communicate on Modbus networks using one of the following modes: ASCII (American Standard Code for Information Interchange) or RTU (Remote Terminal Unit). Users can select the desired mode along with the serial port communication protocol in Pr.09-04.
- ★ Code Description:

ASCII mode:

Each 8-bit data is the combination of two ASCII characters. For example, a 1-byte data:

64 Hex, shown as '64' in ASCII, consists of '6' (36Hex) and '4' (34Hex).

| Character | '0' | '1' | '2' | '3' | '4' | '5' | '6' | '7' |
|------------|-----|-----|-----|-----|-----|-----|-----|-----|
| ASCII code | 30H | 31H | 32H | 33H | 34H | 35H | 36H | 37H |

| Character | '8' | '9' | 'A' | 'B' | 'C' | 'D' | 'E' | 'F' |
|------------|-----|-----|-----|-----|-----|-----|-----|-----|
| ASCII code | 38H | 39H | 41H | 42H | 43H | 44H | 45H | 46H |

RTU mode:

Each 8-bit data is the combination of two 4-bit hexadecimal characters. For example, 64 Hex.

2. Data Format

Chapter 4 Parameters | V7-VL

10-bit character frame (For ASCII):

(7.N.2)

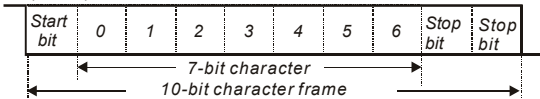

(7.E.1)

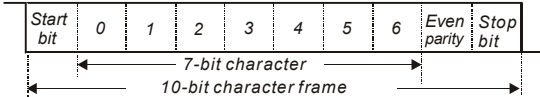

(7.O.1)

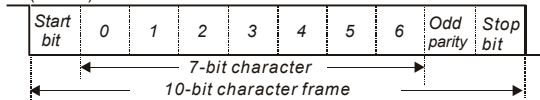

11-bit character frame (For RTU):

(8.N.2)

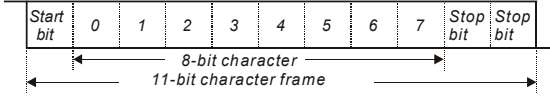

(8.E.1)

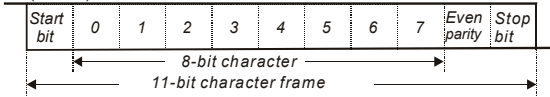

(8.O.1)

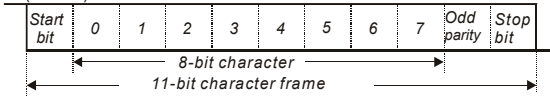

3. Communication Protocol

3.1 Communication Data Frame:

ASCII mode:

| | |
|----------------------------|---|
| STX | Start character ':' (3AH) |
| Address Hi | Communication address: 8-bit address consists of 2 ASCII codes |
| Address Lo | |
| Function Hi | Command code: 8-bit command consists of 2 ASCII codes |
| Function Lo | |
| DATA (n-1) to DATA 0 | Contents of data: Nx8-bit data consist of 2n ASCII codes n<=16, maximum of 32 ASCII codes |
| LRC CHK Hi | LRC check sum: 8-bit check sum consists of 2 ASCII codes |
| LRC CHK Lo | |
| END Hi | End characters: END1= CR (0DH), END0= LF(0AH) |
| END Lo | |

RTU mode:

| | |
|----------------------------|---|
| START | A silent interval of more than 10 ms |
| Address | Communication address: 8-bit address |
| Function | Command code: 8-bit command |
| DATA (n-1) to DATA 0 | Contents of data: n×8-bit data, n≤16 |
| CRC CHK Low | CRC check sum: 16-bit check sum consists of 2 8-bit characters |
| CRC CHK High | |
| END | A silent interval of more than 10 ms |

3.2 Address (Communication Address)

Valid communication addresses are in the range of 0 to 254. A communication address equal to 0, means broadcast to all AC drives (AMD). In this case, the AMD will not reply any message to the master device.

00H: broadcast to all AC drives

01H: AC drive of address 01

0FH: AC drive of address 15

10H: AC drive of address 16

:

FEH: AC drive of address 254

For example, communication to AMD with address 16 decimal (10H):

ASCII mode: Address='1','0' => '1'=31H, '0'=30H

RTU mode: Address=10H

3.3 Function (Function code) and DATA (data characters)

The format of data characters depends on the function code.

03H: read data from register

06H: write single register

08H: loop detection

10H: write multiple registers

The available function codes and examples for VFD-VL are described as follows:

(1) 03H: multi read, read data from registers.

Example: reading continuous 2 data from register address 2102H, AMD address is 01H.

ASCII mode:

| Command message: | |
|-----------------------------------|-----|
| STX | ':' |
| Address | '0' |
| | '1' |
| Function | '0' |
| | '3' |
| Starting data address | '2' |
| | '1' |
| | '0' |
| | '2' |
| Number of data (count by word) | '0' |
| | '0' |

| Response message: | |
|---|-----|
| STX | ':' |
| Address | '0' |
| | '1' |
| Function | '0' |
| | '3' |
| Number of data (Count by byte) | '0' |
| | '4' |
| Content of starting address 2102H | '1' |
| | '7' |
| | '7' |
| | '0' |

Command message:

| | |
|-----------|-----|
| | '0' |
| | '2' |
| | 'D' |
| LRC Check | '7' |
| END | CR |
| | LF |

Response message:

| | |
|-----------------------------|-----|
| Content of address 2103H | '0' |
| | '0' |
| | '0' |
| | '0' |
| LRC Check | '7' |
| | '1' |
| END | CR |
| | LF |

RTU mode:

Command message:

| | |
|-----------------------------------|-----|
| Address | 01H |
| Function | 03H |
| Starting data address | 21H |
| | 02H |
| Number of data (count by word) | 00H |
| | 02H |
| CRC CHK Low | 6FH |
| CRC CHK High | F7H |

Response message:

| | |
|-----------------------------------|-----|
| Address | 01H |
| Function | 03H |
| Number of data (count by byte) | 04H |
| | |
| Content of address 2102H | 17H |
| | 70H |
| Content of address 2103H | 00H |
| | 00H |
| CRC CHK Low | FEH |
| CRC CHK High | 5CH |

(2) 06H: single write, write single data to register.

Example: writing data 6000(1770H) to register 0100H. AMD address is 01H.

ASCII mode:

Command message:

| | |
|--------------|-----|
| STX | ':' |
| Address | '0' |
| | '1' |
| Function | '0' |
| | '6' |
| Data address | '0' |
| | '1' |
| | '0' |
| | '0' |
| Data content | '1' |
| | '7' |
| | '7' |
| | '0' |
| LRC Check | '7' |
| | '1' |
| END | CR |
| | LF |

Response message:

| | |
|--------------|-----|
| STX | ':' |
| Address | '0' |
| | '1' |
| Function | '0' |
| | '6' |
| Data address | '0' |
| | '1' |
| | '0' |
| | '0' |
| Data content | '1' |
| | '7' |
| | '7' |
| | '0' |
| LRC Check | '7' |
| | '1' |
| END | CR |
| | LF |

RTU mode:

Command message:

| | |
|--------------|-----|
| Address | 01H |
| Function | 06H |
| Data address | 01H |
| | 00H |
| Data content | 17H |
| | 70H |

Response message:

| | |
|--------------|-----|
| Address | 01H |
| Function | 06H |
| Data address | 01H |
| | 00H |
| Data content | 17H |
| | 70H |

| | |
|--------------|-----|
| CRC CHK Low | 86H |
| CRC CHK High | 22H |

| | |
|--------------|-----|
| CRC CHK Low | 86H |
| CRC CHK High | 22H |

(3) 10H: write multiple registers (write multiple data to registers)

Example: Set the multi-step speed,

Pr.04-00=50.00 (1388H), Pr.04-01=40.00 (0FA0H). AC drive address is 01H.

ASCII Mode:

| Command message: | |
|--------------------------------|-----|
| STX | '.' |
| Address 1 | '0' |
| Address 0 | '1' |
| Function 1 | '1' |
| Function 0 | '0' |
| Starting data address | '0' |
| | '5' |
| | '0' |
| Number of data (count by word) | '0' |
| | '0' |
| | '2' |
| Number of data (count by byte) | '0' |
| | '4' |
| The first data content | '1' |
| | '3' |
| | '8' |
| | '8' |
| The second data content | '0' |
| | 'F' |
| | '0' |
| LRC Check | '9' |
| | 'A' |
| END | CR |
| | LF |

| Response message: | |
|--------------------------------|-----|
| STX | '.' |
| Address 1 | '0' |
| Address 0 | '1' |
| Function 1 | '1' |
| Function 0 | '0' |
| Starting data address | '0' |
| | '5' |
| | '0' |
| Number of data (count by word) | '0' |
| | '0' |
| | '2' |
| LRC Check | 'E' |
| | '8' |
| END | CR |
| | LF |

RTU mode:

| Command message: | |
|--------------------------------|------|
| Address | 01H |
| Function | 10H |
| Starting data address | 05H |
| | 00H |
| Number of data (count by word) | 00H' |
| Number of data (count by byte) | 02H |
| | 04 |
| The first data content | 13H |
| | 88H |
| The second data content | 0FH |
| | A0H |
| CRC Check Low | '9' |
| CRC Check High | 'A' |

| Response message: | |
|--------------------------------|-----|
| Address | 01H |
| Function | 10H |
| Starting data address | 05H |
| | 00H |
| Number of data (count by word) | 00H |
| Number of data (count by byte) | 02H |
| CRC Check Low | 41H |
| CRC Check High | 04H |

3.4 Check sum

ASCII mode:

LRC (Longitudinal Redundancy Check) is calculated by summing up, module 256, the values of the bytes from ADR1 to last data character then calculating the hexadecimal representation of the 2's-complement negation of the sum.

For example, reading 1 word from address 0401H of the AC drive with address 01H.

| | |
|-----------------------|-----|
| STX | ':' |
| Address 1 | '0' |
| Address 0 | '1' |
| Function 1 | '0' |
| Function 0 | '3' |
| Starting data address | '0' |
| | '4' |
| | '0' |
| | '1' |
| Number of data | '0' |
| | '0' |
| | '0' |
| | '1' |
| LRC Check 1 | 'F' |
| LRC Check 0 | '6' |
| END 1 | CR |
| END 0 | LF |

01H+03H+04H+01H+00H+01H=0AH, the 2's-complement negation of 0AH is **F6H**.

RTU mode:

| | |
|-----------------------------------|-----|
| Address | 01H |
| Function | 03H |
| Starting data address | 21H |
| | 02H |
| Number of data (count by word) | 00H |
| | 02H |
| CRC CHK Low | 6FH |
| CRC CHK High | F7H |

CRC (Cyclical Redundancy Check) is calculated by the following steps:

Step 1: Load a 16-bit register (called CRC register) with FFFFH.

Step 2: Exclusive OR the first 8-bit byte of the command message with the low order byte of the 16-bit CRC register, putting the result in the CRC register.

Step 3: Examine the LSB of CRC register.

Step 4: If the LSB of CRC register is 0, shift the CRC register one bit to the right with MSB zero filling, then repeat step 3. If the LSB of CRC register is 1, shift the CRC register one bit to the right with MSB zero filling, Exclusive OR the CRC register with the polynomial value A001H, then repeat step 3.

Step 5: Repeat step 3 and 4 until eight shifts have been performed. When this is done, a complete 8-bit byte will have been processed.

Step 6: Repeat step 2 to 5 for the next 8-bit byte of the command message. Continue doing this until all bytes have been processed. The final contents of the CRC register are the CRC value. When transmitting the CRC value in the message, the upper and lower bytes of the CRC value must be swapped, i.e. the lower order byte will be transmitted first.

The following is an example of CRC generation using C language. The function takes two arguments:

Unsigned char* data ← a pointer to the message buffer

Unsigned char length ← the quantity of bytes in the message buffer

The function returns the CRC value as a type of unsigned integer.

```
Unsigned int crc_chk(unsigned char* data, unsigned char length){
    int j;
    unsigned int reg_crc=0xFFFF;
    while(length--){
        reg_crc ^= *data++;
        for(j=0;j<8;j++){
            if((reg_crc & 0x01){ /* LSB(b0)=1 */
                reg_crc=(reg_crc>>1) ^ 0xA001;
            }else{
                reg_crc=reg_crc >>1;
            }
        }
    }
    return reg_crc;
}
```

3.5 Address list

The contents of available addresses are shown as below:

| Content | Address | Function | |
|---------------------|---------|---|--|
| AC drive Parameters | GGnnH | GG means parameter group, nn means parameter number, for example, the address of Pr 4-01 is 0401H. Referencing to chapter 5 for the function of each parameter. When reading parameter by command code 03H, only one parameter can be read at one time. | |
| Command Write only | 2000H | Bit 0-3 | 0: No function 1: Stop 2: Run 3: Jog + Run |
| | | Bit 4-5 | 00B: No function 01B: FWD 10B: REV 11B: Change direction |
| | | Bit 6-7 | 00B: 1st accel/decel 01B: 2nd accel/decel 10B: 3rd accel/decel 11B: 4th accel/decel |
| | | Bit 8-11 | Represented 16 step speeds. |

| Content | Address | Function | |
|--------------------------|--|--|--|
| Status monitor Read only | | Bit 12 | 1: disable bit 06-11 |
| | | Bit 13~14 | 00B: No function |
| | | | 01B: operated by digital keypad |
| | | | 02B: operated by Pr.00-15 setting 03B: change operation source |
| | | Bit 15 | Reserved |
| | 2001H | Frequency command | |
| | 2002H | Bit 0 | 1: EF (external fault) on |
| | | Bit 1 | 1: Reset |
| | | Bit 2 | 1: B.B. ON |
| | | Bit 3-15 | Reserved |
| | 2100H | Fault code: refer to Pr.06-16 to Pr.06-21 | |
| | 2119H | Bit 0-Bit 1 | 00: Stop |
| | | | 01: deceleration |
| | | | 10: Ready for operation |
| | | | 11: operation |
| | | Bit 2 | 1:JOG command |
| | | Bit 3-Bit 4 | 00: FWD command, FWD output |
| | | | 01: FWD command, REV output |
| | | | 10: REV command, FWD output |
| | | | 11: Reserved |
| | | Bit 5 | Reserved |
| | | Bit 6 | Reserved |
| | | Bit 7 | Reserved |
| | | Bit 8 | 1: Master frequency Controlled by communication interface |
| | | Bit 9 | 1: Master frequency controlled by analog/external terminals signal |
| | Bit 10 | 1: Operation command controlled by communication interface | |
| | Bit 11 | 1: Parameters have been locked | |
| | Bit 12 | 1: enable to copy parameter from keypad | |
| | Bit 13-15 | Reserved | |
| | 2102H | Frequency command (F) | |
| | 2103H | Output frequency (H) | |
| | 2104H | Output current (AXXX.X) | |
| | 2105H | DC-BUS Voltage (UXXX.X) | |
| 2106H | Output voltage (EXXX.X) | | |
| 2107H | Current step number of Multi-Step Speed Operation | | |
| 2116H | Multi-function display (Pr.00-04) | | |
| 2201H | Pr.00-05 user-defined setting | | |
| 2203H | AUI1 analog input (XXX.XX %) | | |
| 2204H | ACI analog input (XXX.XX %) | | |
| 2205H | AUI2 analog input (XXX.XX %) | | |
| 2206H | Display temperature of IGBT (°C) | | |
| 2207H | Display temperature of heatsink (°C) (only for model 40HP and above) | | |
| 2208H | Digital input state | | |
| 2209H | Digital output state | | |

3.6 Exception response:

The AC motor drive is expected to return a normal response after receiving command messages from the master device. The following depicts the conditions when no normal response is replied to the master device.

The AC motor drive does not receive the messages due to a communication error; thus, the AC motor drive has no response. The master device will eventually process a timeout condition.

The AC motor drive receives the messages without a communication error, but cannot handle them. An exception response will be returned to the master device and an error message "CExx" will be displayed on the keypad of AC motor drive. The xx of "CExx" is a decimal code equal to the exception code that is described below.

In the exception response, the most significant bit of the original command code is set to 1, and an exception code which explains the condition that caused the exception is returned.

Example of an exception response of command code 06H and exception code 02H:

| ASCII mode: | |
|----------------|-----|
| STX | ':' |
| Address Low | '0' |
| Address High | '1' |
| Function Low | '8' |
| Function High | '6' |
| Exception code | '0' |
| | '2' |
| LRC CHK Low | '7' |
| LRC CHK High | '7' |
| END 1 | CR |
| END 0 | LF |

| RTU mode: | |
|----------------|-----|
| Address | 01H |
| Function | 86H |
| Exception code | 02H |
| CRC CHK Low | C3H |
| CRC CHK High | A1H |

The explanation of exception codes:

| Exception code | Explanation |
|----------------|--|
| 01 | Illegal function code: The function code received in the command message is not available for the AC motor drive. |
| 02 | Illegal data address: The data address received in the command message is not available for the AC motor drive. |
| 03 | Illegal data value: The data value received in the command message is not available for the AC drive. |
| 04 | Slave device failure: The AC motor drive is unable to perform the requested action. |
| 10 | Communication time-out: If Pr.09-03 is not equal to 0.0, Pr.09-02=0~1, and there is no communication on the bus during the Time Out detection period (set by Pr.09-03), "cE10" will be shown on the keypad. |

Control mode VF VFPG SVC FOCPG TQCPG FOCPM

Factory Setting: 2.0

Settings 0.0 ~ 200.0 ms

📖 This parameter is the response delay time after AC drive receives communication command as shown in the following.

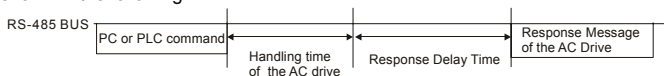

Group 10 Speed Feedback Control Parameters**10-00** PG Signal Type

| Control mode | VFPG | FOCPG | TQCPG | FOCPM | Factory Setting: 0 |
|--------------|------|---------------------|-------|-------|--------------------|
| Settings | 0 | No function | | | |
| | 1 | ABZ | | | |
| | 2 | ABZ+ Hall | | | |
| | 3 | SIN/COS+Sinusoidal | | | |
| | 4 | SIN/COS+Endat | | | |
| | 5 | SIN/COS | | | |
| | 6 | SIN/COS + Hiperface | | | |

 When Pr.10-00 is set to 3, encoder will have one sine and one cosine signal for each revolution. The signal must be: 0.75 to 1.2Vpp for the amplitude with phase angle $90^{\circ} \pm 5$ elec. (EX: ERN 1185 ERN 1387)

 When setting is 4 or 6, it needs to wait for 2 seconds after applying the power to execute RUN command.

 Detection of the electromagnetic pole:

Setting 1 or 5: The AC motor drive will output short circuit to detect the position of the electromagnetic pole. At this moment, the motor will generate a little noise.

Setting 2: The AC motor drive will detect the position of the electromagnetic pole by the UVW signal of encoder.

Setting 3: The AC motor drive will detect the position of the electromagnetic pole by the sine signal of encoder.

Setting 4 or 6: The AC motor drive will detect the position of the electromagnetic pole by the communication signal of encoder.

 Reference table for tuning

| Setting of PG signal type | PG signal type | Applicable PG card | Pr.08-00=1 | Pr.08-00=3 |
|---------------------------|--------------------|--------------------|----------------|-----------------|
| 10-00=1 | A, B, Z | EMVL-PGABO/ABL | Motor will run | Motor will run |
| 10-00=2 | A, B, Z+U, V, W | EMVL-PGABL | Motor will run | Motor won't run |
| 10-00=3 | SIN/COS+Sinusoidal | EMVL-PGH01/02 | Motor will run | Motor will run |

| Setting of PG signal type | PG signal type | Applicable PG card | Pr.08-00=1 | Pr.08-00=3 |
|---------------------------|---------------------|--------------------|----------------|-----------------|
| 10-00=4 | SIN/COS+Endat | EMVL-PGS01 | Motor will run | Motor won't run |
| 10-00=5 | SIN/COS | EMVL-PGH01/02 | Motor will run | Motor will run |
| 10-00=6 | SIN/COS + Hiperface | EMVL-PGS01 | Motor will run | Motor won't run |

10-01 Encoder Pulse

Unit: 1

Control mode **VFGP FOCPG TQCPG FOCPM**

Factory Setting: 600

Settings 1 to 20000

A Pulse Generator (PG) or encoder is used as a sensor that provides a feedback signal of the motor speed. This parameter defines the number of pulses for each cycle of the PG control.

10-02 Encoder Input Type Setting

Control mode **VFGP FOCPG TQCPG FOCPM**

Factory Setting: 0

Settings 0 Disable

Phase A leads in a forward run command and phase B leads in a reverse run command

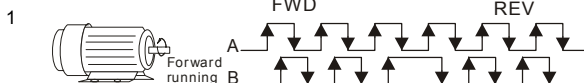

Phase B leads in a forward run command and phase A leads in a reverse run command

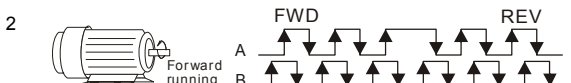

Phase A is a pulse input and phase B is a direction input. (low input=reverse direction, high input=forward direction)



Phase A is a pulse input and phase B is a direction input. (low input=forward direction, high input=reverse direction)

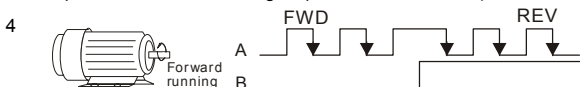



It is helpful for the stable control by inputting correct pulse type.

10-03 Encoder Feedback Fault Treatment (PGF1, PGF2)

| Control mode | VFPG | FOCPG | TQCPG | Factory Setting: |
|--------------|------|-------------------------|-------|------------------|
| Settings | 0 | Warn and keep operation | | |
| | 1 | Warn and RAMP to stop | | |
| | 2 | Warn and stop operation | | |

10-04 Detection Time for Encoder Feedback Fault

Unit: 0.1

| Control mode | VFPG | FOCPG | TQCPG | FOCPM | Factory Setting: |
|--------------|------|-----------------|-------|-------|------------------|
| Settings | | 0.0 to 10.0 sec | | | 1.0 |

When PG loss, encoder signal error, pulse signal setting error or signal error, if time exceeds the detection time for encoder feedback fault (Pr.10-04), the PG signal error will occur. Refer to the Pr.10-03 for encoder feedback fault treatment.

10-05 Encoder Stall Level (PGF5)

Unit: 1

| Control mode | VFPG | SVC | FOCPG | FOCPM | Factory Setting: |
|--------------|------|------------------------|-------|-------|------------------|
| Settings | | 0 to 120% (0: disable) | | | 115 |

This parameter determines the maximum encoder feedback signal allowed before a fault occurs. (max. output frequency Pr.01-00 =100%)

10-06 Encoder Stall Detection Time

Unit: 0.1

| Control mode | VFPG | SVC | FOCPG | FOCPM | Factory Setting: |
|--------------|------|----------------|-------|-------|------------------|
| Settings | | 0.0 to 2.0 sec | | | 0.1 |

10-07 Encoder Slip Range (PGF7)

Unit: 1

| Control mode | VFPG | SVC | FOCPG | FOCPM | Factory Setting: |
|--------------|------|-----------------------|-------|-------|------------------|
| Settings | | 0 to 50% (0: disable) | | | 50 |

10-08 ✓ Encoder Slip Detection Time

Unit: 0.1

Control mode **VFGP SVC FOCPG FOCPM**

Factory Setting: 0.5

Settings 0.0 to 10.0 sec

10-09 ✓ Encoder Stall and Slip Error TreatmentControl mode **VFGP SVC FOCPG FOCPM**

Factory Setting: 2

Settings 0 Warn and keep operating
 1 Warn and RAMP to stop
 2 Warn and COAST to stop

 When the value of (rotation speed – motor frequency) exceeds Pr.10-07 setting, detection time exceeds Pr.10-08 or motor frequency exceeds Pr.10-05 setting, it will start to accumulate time. If detection time exceeds Pr.10-06, the encoder feedback signal error will occur. Refer to Pr.10-09 encoder stall and slip error treatment.

10-10 Mode Selection for UVW InputControl mode **VFGP FOCPG TQCPG FOCPM**

Factory Setting: 0

Settings 0 Z signal is at the falling edge of U-phase
 1 Z signal is at the rising edge of U-phase

 Setting 0: when the operation is U->V->W, Z signal is at the falling edge of U-phase.
 Setting 1: when the operation is U->V->W, Z signal is at the rising edge of U-phase.

Pr.10-10=1

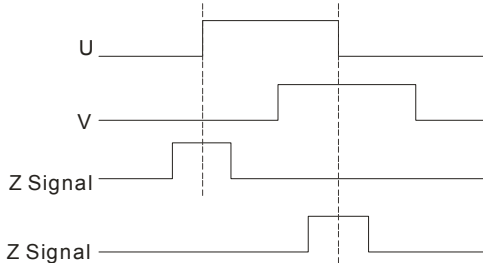

Pr.10-10=0

10-11 ✓ ASR (Auto Speed Regulation) Control (P) of Zero Speed

Unit: 0.1

Control mode **VF VFGP SVC FOCPG FOCPM**

Factory Setting: 100.0

Settings 0.0 to 500.0%

| | | | | | | |
|---------------------|---|-------------|------------|--------------|--------------|----------------------------------|
| 10-12 | ↗ ASR (Auto Speed Regulation) Control (I) of Zero Speed | | | | | Unit: 0.001 |
| Control mode | VF | VFPG | SVC | FOCPG | FOCPM | Factory Setting: 0.100 |
| | Settings | | | | | 0.000 to 10.000 sec |
| 10-13 | ↗ ASR (Auto Speed Regulation) control (P) 1 | | | | | Unit: 0.1 |
| Control mode | VF | VFPG | SVC | FOCPG | FOCPM | Factory Setting: 100.0 |
| | Settings | | | | | 0.0 to 500.0% |
| 10-14 | ↗ ASR (Auto Speed Regulation) control (I) 1 | | | | | Unit: 0.001 |
| Control mode | VF | VFPG | SVC | FOCPG | FOCPM | Factory Setting: 0.100 |
| | Settings | | | | | 0.000 to 10.000 sec |
| 10-15 | ↗ ASR (Auto Speed Regulation) control (P) 2 | | | | | Unit: 0.1 |
| Control mode | VF | VFPG | SVC | FOCPG | FOCPM | Factory Setting: 100.0 |
| | Settings | | | | | 0.0 to 500.0% |
| 10-16 | ↗ ASR (Auto Speed Regulation) control (I) 2 | | | | | Unit: 0.001 |
| Control mode | VF | VFPG | SVC | FOCPG | FOCPM | Factory Setting: 0.100 |
| | Settings | | | | | 0.000 to 10.000 sec |
| 10-17 | ↗ ASR 1/ASR2 Switch Frequency | | | | | Unit: 0.01 |
| Control mode | VF | VFPG | SVC | FOCPG | FOCPM | Factory Setting: 7.00 |
| | Settings | | | | | 0.00 o 120.00Hz 0.00: disable |

 ASR P determines Proportional control and associated gain (P). ASR I determines integral control and associated gain (I).

 When integral time is set to 0, it is disabled. Pr.10-17 defines the switch frequency for the ASR1 (Pr.10-13, Pr.10-14) and ASR2 (Pr.10-15, Pr.10-16).

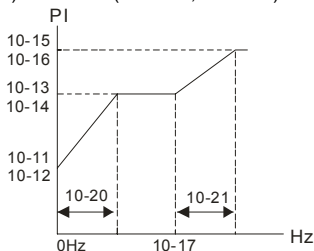

When using multi-function input terminals to switch ASR1/ASR2, the diagram will be shown as follows.

Setting multi-function input terminal to 17
(ASR1/ASR2 switch)

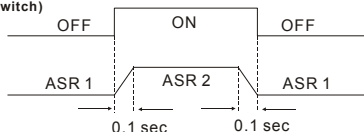

10-18 **ASR Primary Low Pass Filter Gain** Unit: 0.001

Control mode VF VFG SVC FOC PG FOC PM Factory Setting: 0.008

Settings 0.000 to 0.350 sec

It defines the filter time of the ASR command.

When setting to 1, this function is disabled.

10-19 **Zero Speed Gain (P)** Unit: 0.01

Control mode FOC PM Factory Setting: 80.00

Settings 0.00 to 655.00%

When Pr.11-00 is set to Bit 7=1, Pr.10-19 is valid.

10-20 **Zero Speed/ASR1 Width Adjustment** Unit: 0.01

Control mode VFG FOC PG FOC PM Factory Setting: 5.00

Settings 0.0 to 120.00Hz

10-21 **ASR1/ASR2 Width Adjustment** Unit: 0.01

Control mode VFG FOC PG FOC PM Factory Setting: 5.00

Settings 0.0 to 120.00Hz

These two parameters are used to decide width of slope of ASR command during zero speed to low speed or Pr.10-17 to high speed.

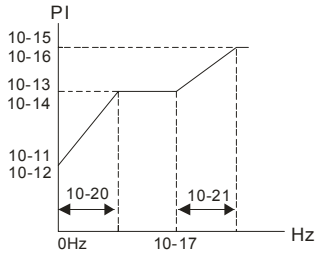

| | | |
|---------------------|---------------------------------|--|
| 10-22 | ↗ Operation Time of Zero Speed | Unit: 0.001 |
| Control mode | FOCPM | Factory Setting: 0.250 |
| | Settings | 0.001 to 65.535sec |
| 10-23 | ↗ Filter Time of Zero Speed | Unit: 0.001 |
| Control mode | FOCPM | Factory Setting: 0.004 |
| | Settings | 0.001 to 65.535sec |
| 10-24 | ↗ Time for Executing Zero Speed | Factory Setting: 0 |
| Control mode | FOCPM | Factory Setting: 0 |
| | Settings | 0 After the brake release set in Pr.02-29 |
| | | 1 After the brake signal input (Pr.02-01~02-08 is set to 42) |



When Pr.10-24=0, the zero speed control needs to be used with Pr.02-29. (refer to the explanations in Pr.02-32)

Group 11 Advanced Parameters**11-00** System ControlControl mode **FOCPG FOCPM**

Factory Setting: 0

| Settings | Bit 0=0 | No function |
|----------|----------|---|
| | Bit 0=1 | ASR Auto tuning, PDFF enable |
| | Bit 7=0 | No function |
| | Bit 7=1 | When position control is enabled, it doesn't need to set Pr.07-02 (DC Brake Current Level) |
| | Bit 15=0 | when power is applied, it will detect the position of magnetic field again |
| | Bit 15=1 | when power is applied, it will start from the magnetic field position of previous power failure |

 Bit 0=1: PDFF function is enabled and system will generate an ASR setting, Pr. 10-11~10-16 will be invalid and Pr.11-09 to 11-10 will be valid.

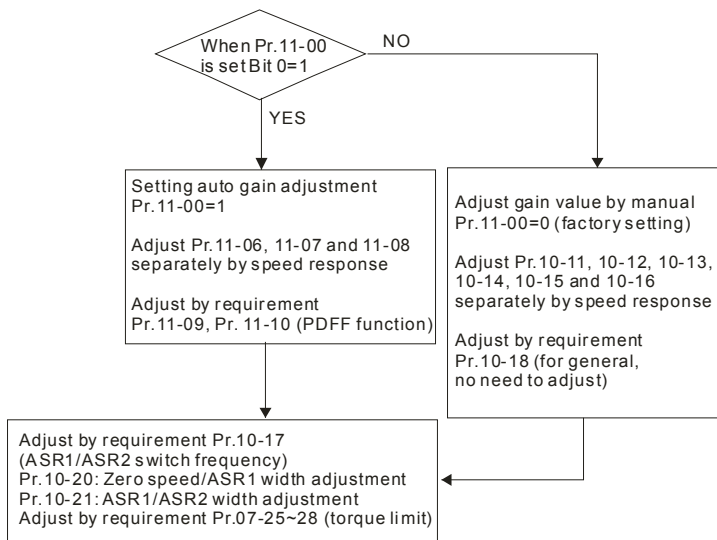

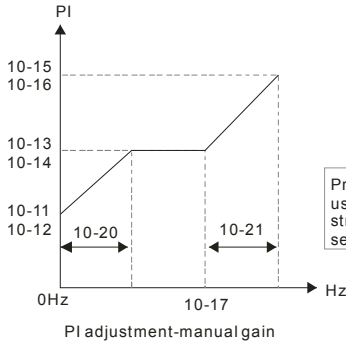

Pr. 11-06
use to adjust the
strength of zero-
servo lock

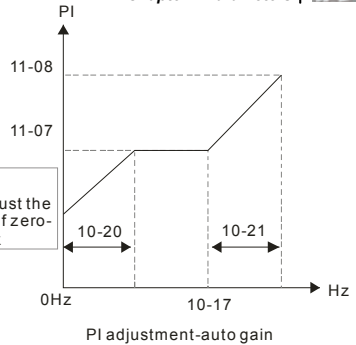

| | | |
|---------------------|-------------------------|-----------------------|
| 11-01 | ↗ Elevator Speed | Unit: 0.01 |
| Control mode | FOCPG FOCPM | Factory Setting: 1.00 |
| Settings | 0.10 to 3.00 m/s | |
| 11-02 | ↗ Sheave Diameter | Unit: 1 |
| Control mode | FOCPG FOCPM | Factory Setting: 400 |
| Settings | 100 to 2000 mm | |
| 11-03 | ↗ Mechanical Gear Ratio | Unit: 1 |
| Control mode | FOCPG FOCPM | Factory Setting: 1 |
| Settings | 1 to 100 | |
| 11-04 | ↗ Suspension Ratio | Unit: 1 |
| Control mode | FOCPG FOCPM | Factory Setting: 1 |
| Settings | 0 1:1 | |
| | 1 2:1 | |

suspension ration 1:1

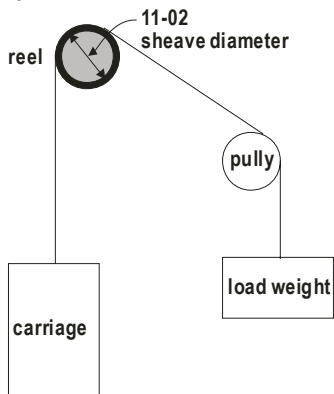

suspension ration 2:1

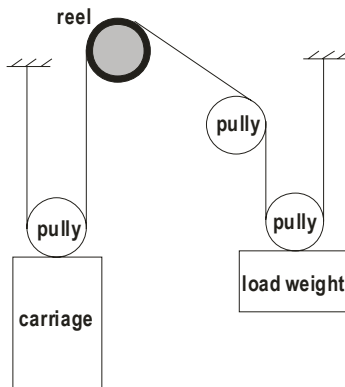
**11-05** ✓ Inertial Ratio

Unit: 1

Control mode FOC PG FOC PM

Factory Setting: 40

Settings 1 to 300%

The load inertia can be calculated by the settings of motor parameter, Pr.11-02 Sheave Diameter, Pr.11-14 Motor Current at Accel. and Pr.11-15 Elevator Acceleration. This parameter can be used to adjust inertia ratio of load.

11-06 ✓ Zero-speed Bandwidth

Unit: 1

11-07 ✓ Low-speed Bandwidth

Unit: 1

11-08 ✓ High-speed Bandwidth

Unit: 1

Control mode FOC PG FOC PM

Factory Setting: 10

Settings 0 to 40Hz

After estimating inertia and set Pr.11-00=1 (auto tuning), user can adjust parameters Pr.11-06, 11-07 and 11-08 separately by speed response. The larger number you set, the faster response you will get. Pr.11-08 is the switch frequency for low-speed/high-speed bandwidth.

11-09 ✓ PDF Gain Value

Unit: 1

Control mode FOC PG FOC PM

Factory Setting: 30

Settings 0 to 200%

 After finishing estimating and set Pr.11-00=1 (auto tuning), using Pr.11-09/11-10 to reduce overshoot. Please adjust PDFF gain value by actual situation.

 Besides traditional PI control, it also provides PDFF function to reduce overshoot for speed control.

1. Get system inertia

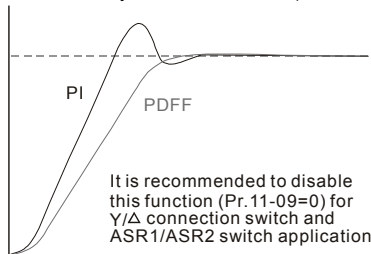

2. Set Pr.11-00 to 1

3. Adjust Pr.11-09/11-10 (the larger number is set and the suppressed overshoot function will be better. But it needs to be used by the actual condition)



| | | |
|---------------------|---|--------------------|
| 11-10 |  Gain for Speed Feed Forward | Unit: 1 |
| Control mode | FOCPG FOCPM | Factory Setting: 0 |
| | Settings 0 to 500 | |

 Pr.11-09 and Pr.11-10 will be enabled when Pr.11-00 is set to Bit0=1.

| | | |
|---------------------|--|-----------------------|
| 11-11 |  Notch Filter Depth | Unit: 1 |
| Control mode | FOCPG FOCPM | Factory Setting: 0 |
| | Settings 0 to 20 db | |
| 11-12 |  Notch Filter Frequency | Unit: 0.01 |
| Control mode | FOCPG FOCPM | Factory Setting: 0.00 |
| | Settings 0.00 to 200.00Hz | |

 This parameter is used to set resonance frequency of mechanical system. It can be used to suppress the resonance of mechanical system.

 The larger number you set Pr.11-11, the better suppression resonance function you will get.

 The notch filter frequency is the resonance of mechanical frequency.

| | | |
|--------------|--|-------------|
| 11-13 | ↗ Low-pass Filter Time of Keypad Display | Unit: 0.001 |
|--------------|--|-------------|

| | | |
|---------------------|---------------------------------|------------------------|
| Control mode | VF VFPG SVC FOC PG TQCPG FOC PM | Factory Setting: 0.500 |
|---------------------|---------------------------------|------------------------|

| | |
|----------|-------------------|
| Settings | 0.001 to 65.535 s |
|----------|-------------------|

 It is used to lower the blinking frequency of LCD display.

| | | |
|--------------|---------------------------|---------|
| 11-14 | ↗ Motor Current at Accel. | Unit: 1 |
|--------------|---------------------------|---------|

| | | |
|---------------------|-------|----------------------|
| Control mode | FOCPM | Factory Setting: 150 |
|---------------------|-------|----------------------|

| | |
|----------|------------|
| Settings | 50 to 200% |
|----------|------------|

| | | |
|--------------|-------------------------|-----------|
| 11-15 | ↗ Elevator Acceleration | Unit: 0.1 |
|--------------|-------------------------|-----------|

| | | |
|---------------------|-------|-----------------------|
| Control mode | FOCPM | Factory Setting: 0.75 |
|---------------------|-------|-----------------------|

| | |
|----------|-----------------|
| Settings | 0.60 to 2.00m/s |
|----------|-----------------|

Group 12 User-defined Parameters

12-00
|
12-31

User-defined Parameters

Control mode VF VFPG SVC FOC PG TQCPG FOC PM

Factory Setting: -

Settings -

- Users can enter the parameters from group 0 to group 11 into group 12 (it can save 32 parameters). The saved value can also be the parameter addresses (but the hexadecimal value needs to be converted to decimal value).
- Example 1: If you want to enter Pr.08-03 into Pr. 12-00, you only need to enter 0803 into Pr.12-00. Then it will display the setting of Pr.08-03 in Pr.13-00. Refer to the following figure for the operation of KPVL-CC01.

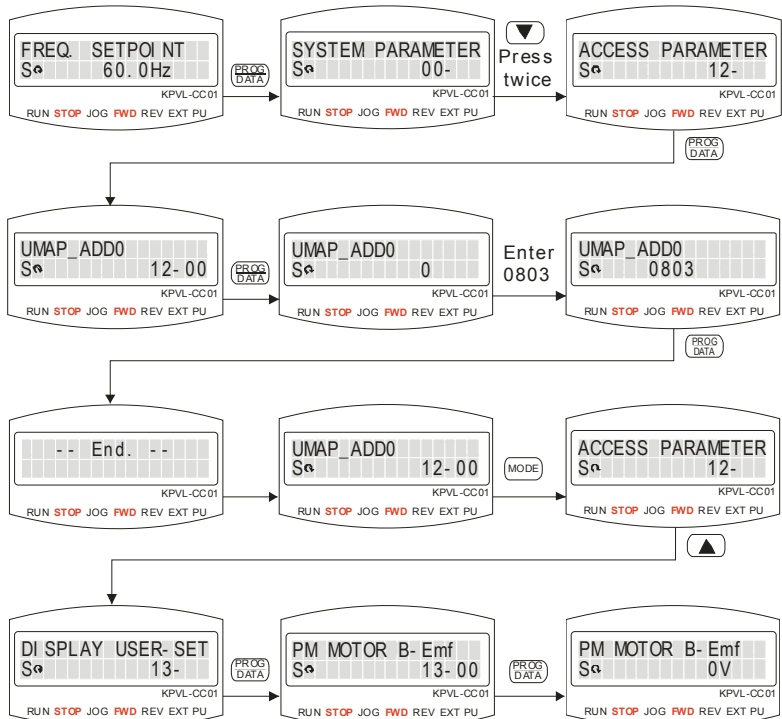

Example 2: If it needs to enter parameter address 2102H and 211BH by the digital keypad, 211BH needs to be converted to binary value before entering.

The setting method of 2102H

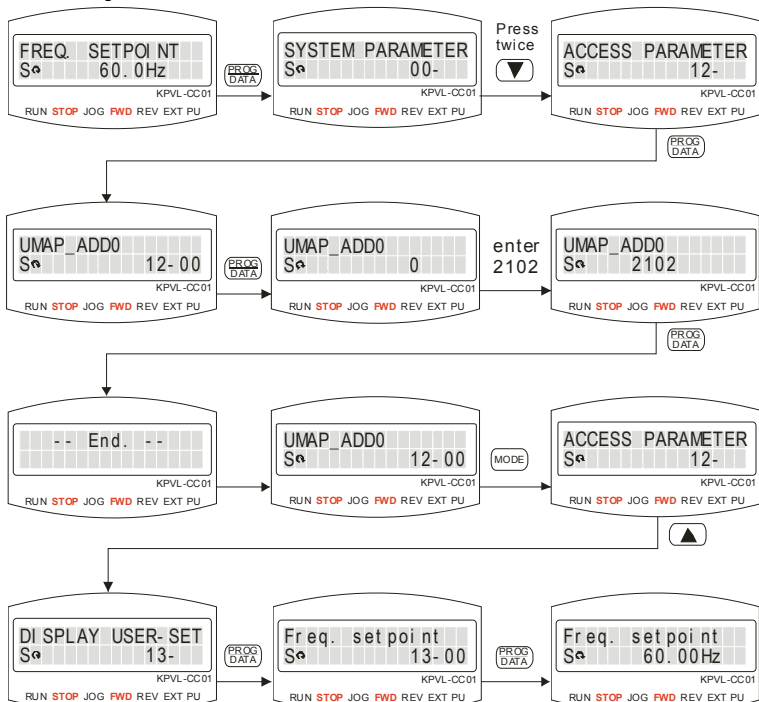

The setting method of 211BH

Convert 211BH (hexadecimal) to decimal value:

$$211B$$

$$1 \times 16^1 + 11 \times 16^0 = 16 + 11 = 27 \quad \text{input } 2127$$

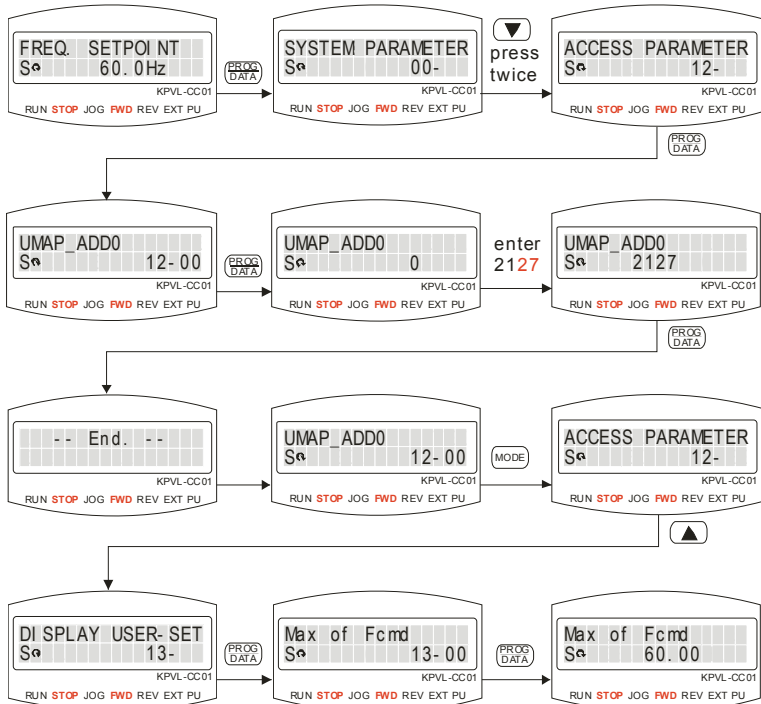

13-00

|

13-31

View User-defined Parameters

| Control mode | VF | VFPG | SVC | FOCPG | TQCPG | FOCPM | Factory Setting: - |
|--------------|----|------|-----|-------|-------|-------|--------------------|
| Settings | | | - | | | | |

 Refer to group 12 for details.

Chapter 5 Troubleshooting

5.1 Over Current (OC)

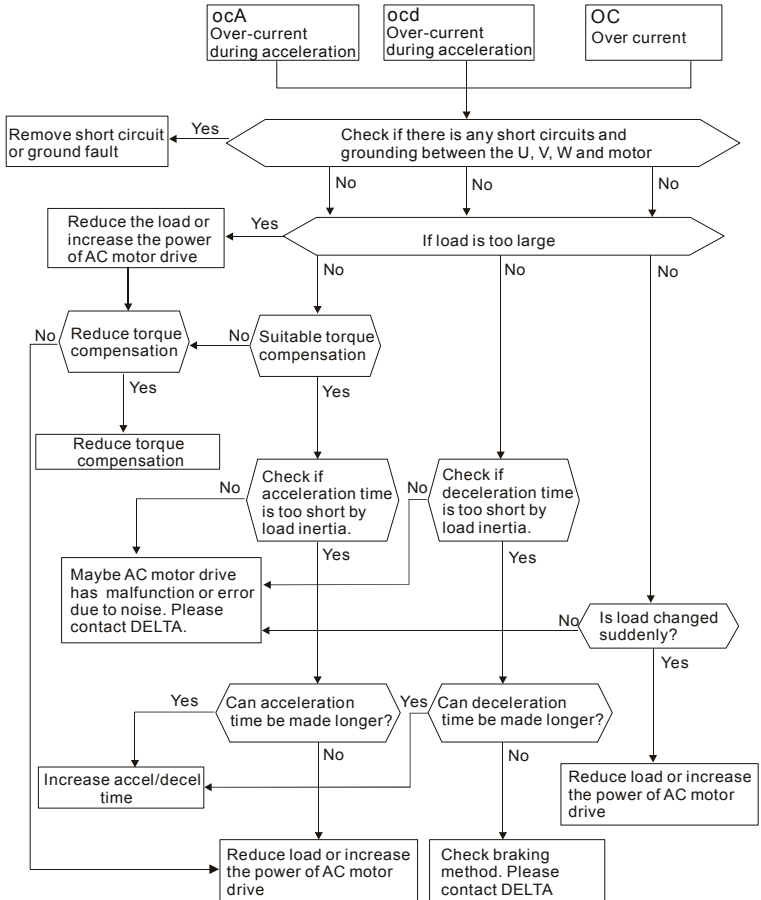

5.2 Ground Fault

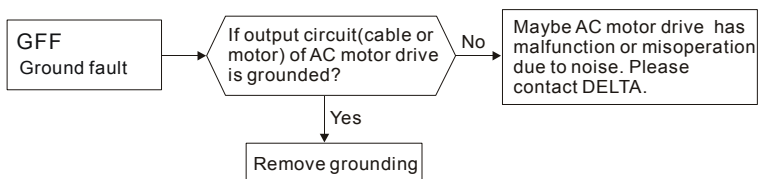

5.3 Over Voltage (OV)

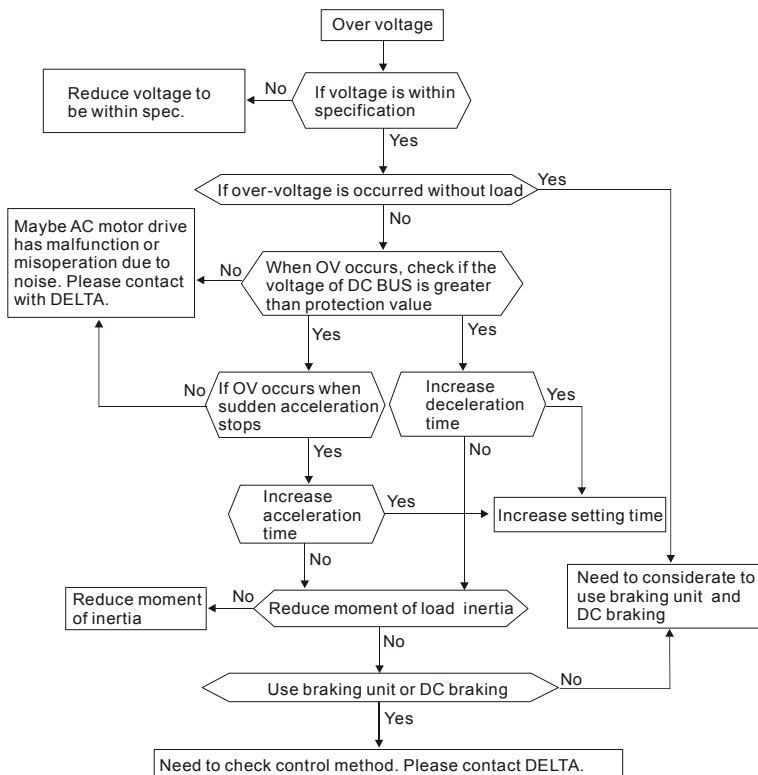

5.4 Low Voltage (Lv)

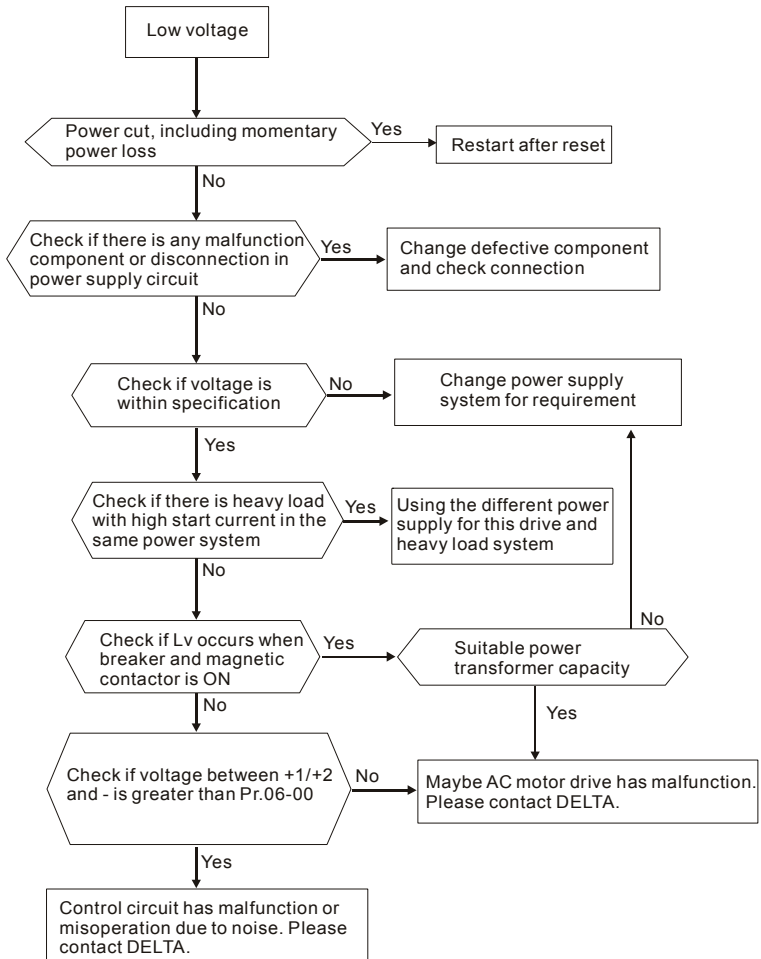

5.5 Over Heat (OH)

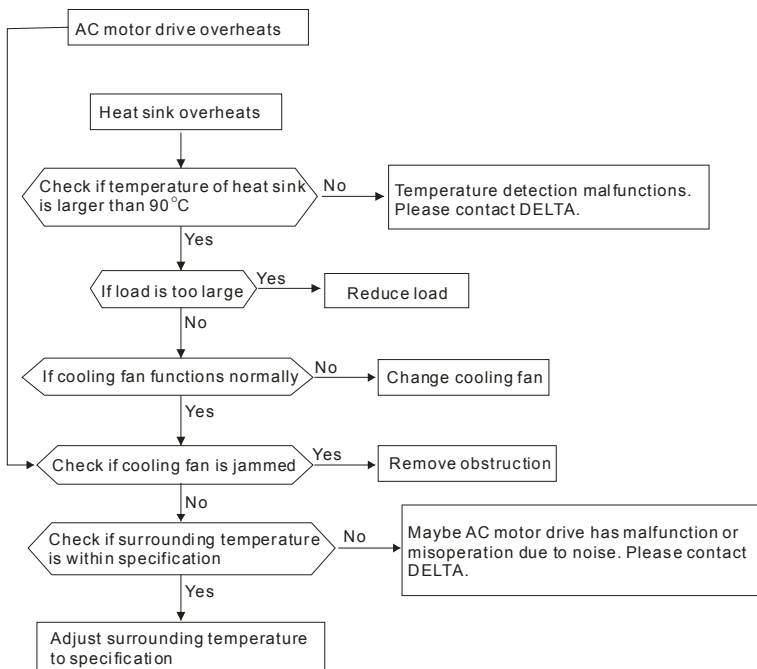

5.6 Overload

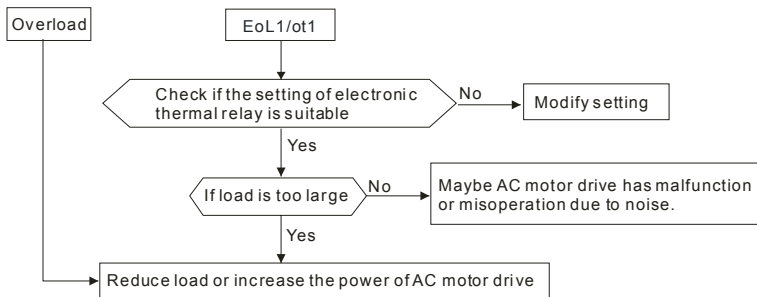

5.7 Display of KPVL-CC01 is Abnormal

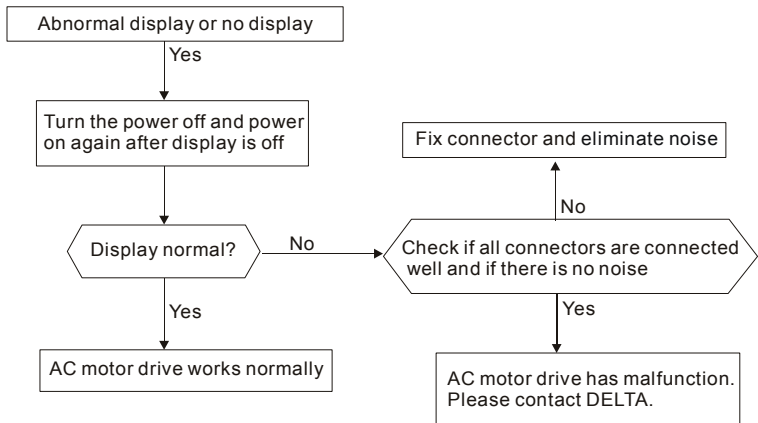

5.8 Phase Loss (PHL)

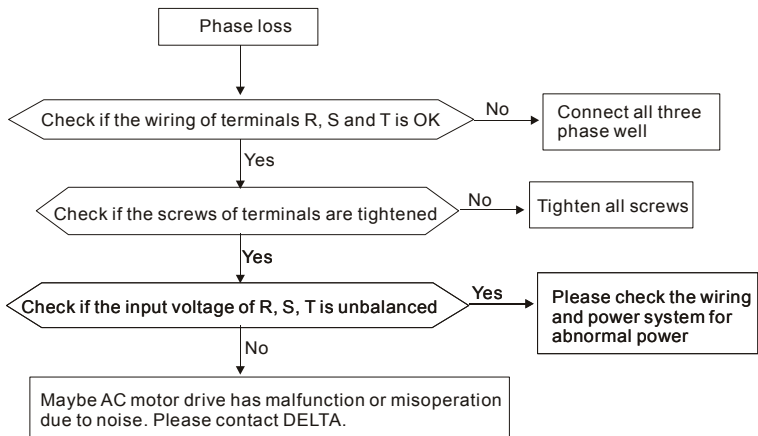

5.9 Motor cannot Run

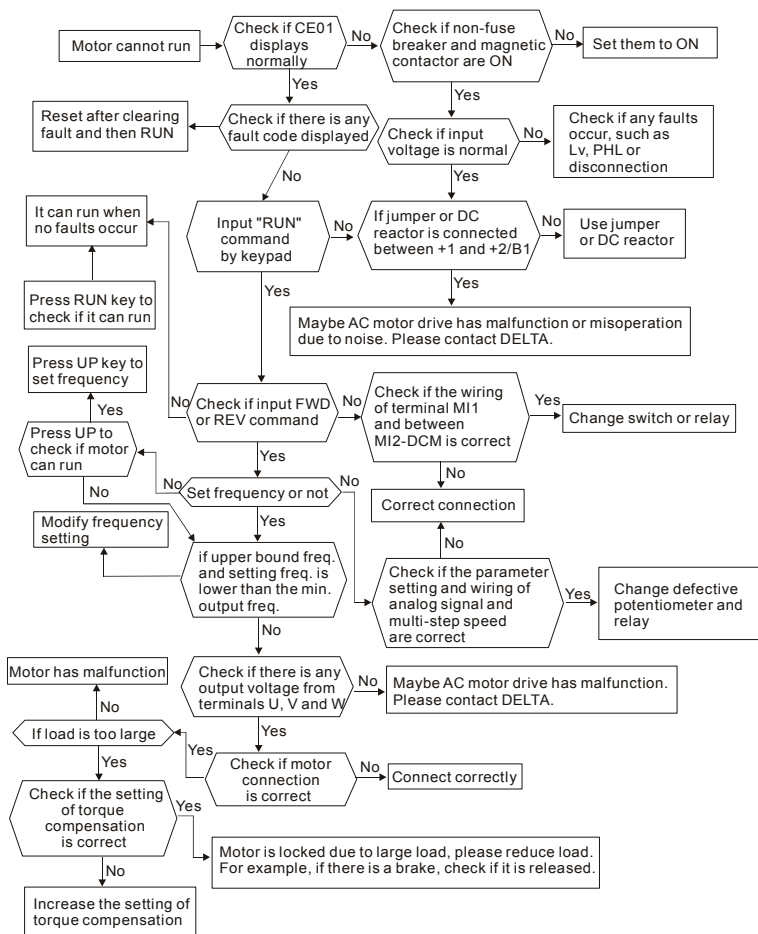

5.10 Motor Speed cannot be Changed

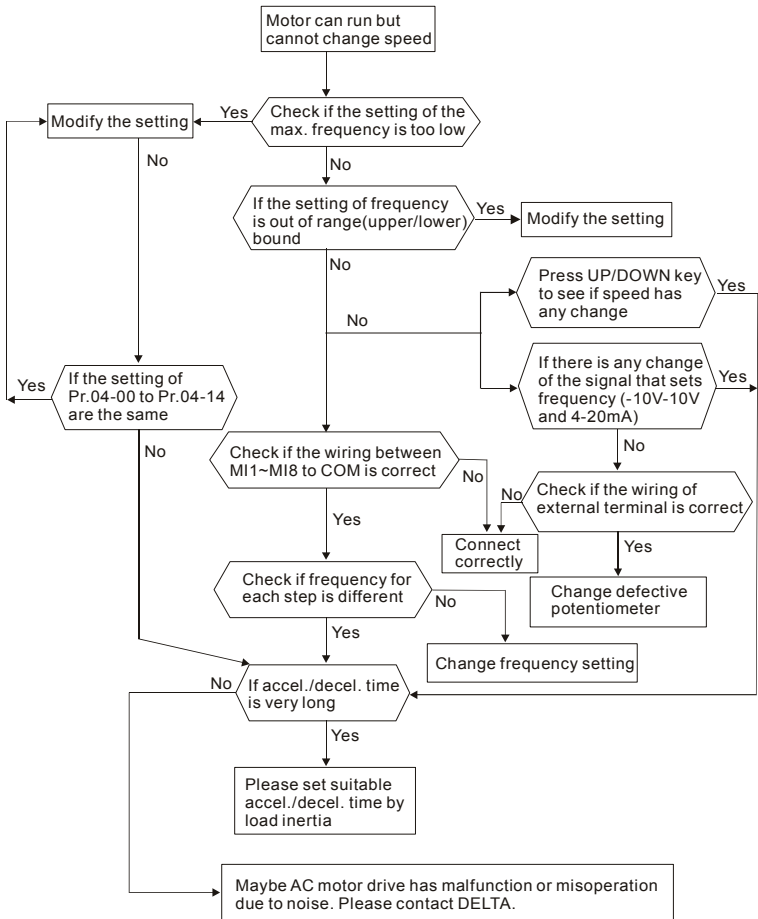

5.11 Motor Stalls during Acceleration

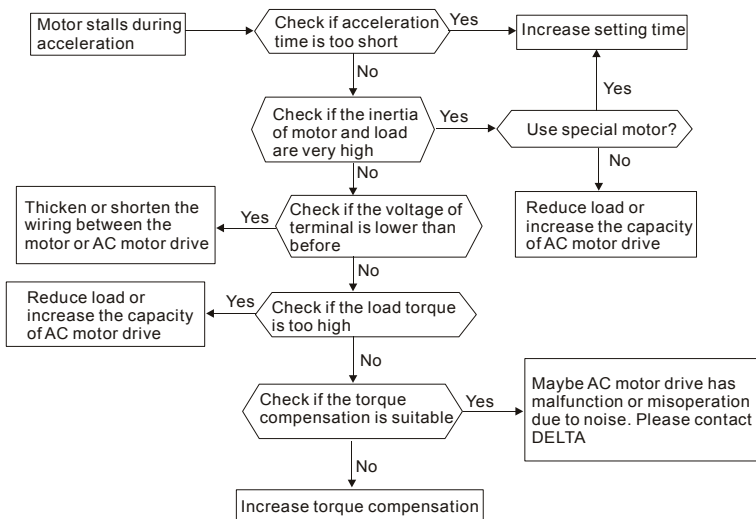

5.12 The Motor does not Run as Expected

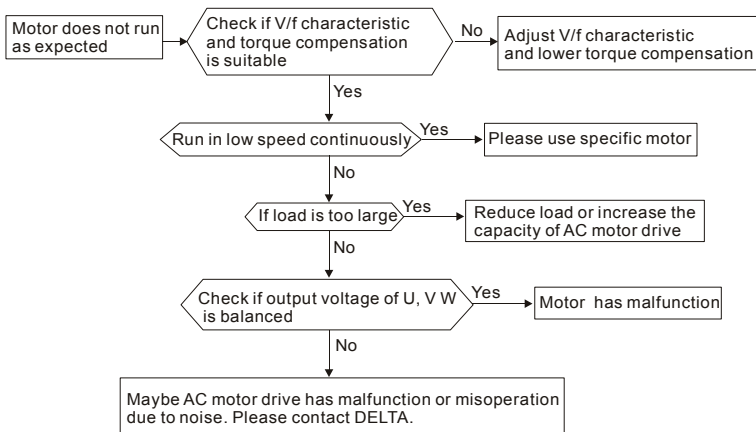

5.13 Electromagnetic/Induction Noise

There are many noises surround the AC motor drives and invade it by radiation or power circuit. It may cause the misoperation of control circuit and even damage the AC motor drive. Of course, that is a solution to increase the noise tolerance of AC motor drive. But it is not the best one due to the limit. Therefore, solve it from the outside as following will be the best.

1. Add surge killer on the relay or contact to suppress switching surge between ON/OFF.
2. Shorten the wiring length of the control circuit or serial circuit and separate from the main circuit wiring.
3. Comply with the wiring regulation for those shielded wire and use isolation amplifier for long wire.
4. The grounding terminal should comply with the local regulation and ground independently, i.e. not to have common ground with electric welding machine and power equipment.
5. Connect a noise filter at the input terminal of the AC motor drive to prevent noise from power circuit.

In a word, three-level solutions for electromagnetic noise are “no product”, “no spread” and “no receive”.

5.14 Environmental Condition

Since AC motor drive is an electronic device, you should comply with the environmental condition stated in the appendix A. Following are the remedial measures for necessary.

1. To prevent vibration, anti-vibration spacer is the last choice. The vibration tolerance must be within the specification. The vibration effect is equal to the mechanical stress and it cannot occur frequently, continuously or repeatedly to prevent damaging AC motor drive.
2. Store in a clean and dry location free from corrosive fumes/dust to prevent rustiness, poor contact. It also may cause short by low insulation in a humid location. The solution is to use both paint and dust-proof. For particular occasion, use the enclosure with whole-seal structure.
3. The surrounding temperature should be within the specification. Too high or low temperature will affect the lifetime and reliability. For semiconductor components, damage will occur once any specification is out of range. Therefore, it is necessary to clean and periodical check for the air cleaner and cooling fan besides having cooler and sunshade.

In addition, the microcomputer may not work in extreme low temperature and needs to have heater.

4. Store within a relative humidity range of 0% to 90% and non-condensing environment. Do not turn off the air conditioner and have exsiccator for it.

5.15 Affecting Other Machines

AC motor drive may affect the operation of other machine due to many reasons. The solutions are as follows.

■ High Harmonic at Power Side

If there is high harmonic at power side during running, the improved methods are:

1. Separate power system: use transformer for AC motor drive.
2. Use reactor at the power input terminal of AC motor drive or decrease high harmonic by multiple circuit.
3. If there is phase lead capacitor, it should use serial reactor to prevent capacitor damage from high harmonic.

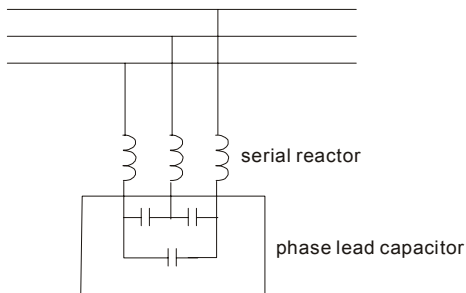

■ Motor Temperature Rises

When the motor is induction motor with ventilation-cooling-type used in variety speed operation, bad cooling will happen in the low speed. Therefore, it may overheat. Besides, high harmonic is in output waveform to increase copper loss and iron loss. Following measures should be used by load situation and operation range when necessary.

1. Use the motor with independent power ventilation or increase the horsepower.
2. Use inverter duty motor.
3. Do NOT run in the low speed

Chapter 6 Fault Code Information and Maintenance

6.1 Fault Code Information

The AC motor drive has a comprehensive fault diagnostic system that includes several different alarms and fault messages. Once a fault is detected, the corresponding protective functions will be activated. The following faults are displayed as shown on the AC motor drive digital keypad display. The six most recent faults can be read from the digital keypad or communication.

The AC motor drive is made up by numerous components, such as electronic components, including IC, resistor, capacity, transistor, and cooling fan, relay, etc. These components can't be used permanently. They have limited-life even under normal operation. Preventive maintenance is required to operate this AC motor drive in its optimal condition, and to ensure a long life.

Basic check-up items to detect if there were any abnormalities during operation are:



- Wait 5 seconds after a fault has been cleared before performing reset via keypad of input terminal.
- When the power is off after 5 minutes for $\leq 22\text{kW}$ models and 10 minutes for $\geq 30\text{kW}$ models, please confirm that the capacitors have fully discharged by measuring the voltage between DC+ and DC-. The voltage between DC+ and DC- should be less than 25VDC.
- Only qualified personnel can install, wire and maintain AC motor drives. Please take off any metal objects, such as watches and rings, before operation. And only insulated tools are allowed.
- Never reassemble internal components or wiring.
- Make sure that installation environment comply with regulations without abnormal noise, vibration and smell.

6.1.1 Common Problems and Solutions

Following fault name will only be displayed when using with optional digital keypad KPVL-CC01.

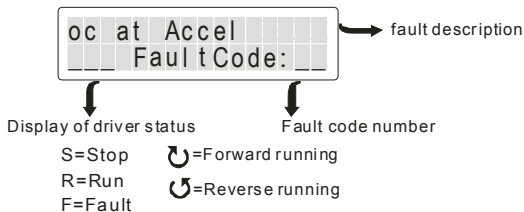







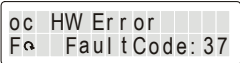

| Display | Description |
|---------|--|
| | <p>Over-current during acceleration (Output current exceeds triple rated current during acceleration.)</p> <p>Corrective Actions:</p> <ol style="list-style-type: none"> Short-circuit at motor output: Check for possible poor insulation at the output lines. Acceleration Time too short: Increase the Acceleration Time. AC motor drive output power is too small: Replace the AC motor drive with the next higher power model. |
| | <p>Over-current during deceleration (Output current exceeds triple rated current during deceleration.)</p> <p>Corrective Actions:</p> <ol style="list-style-type: none"> Short-circuit at motor output: Check for possible poor insulation at the output line. Deceleration Time too short: Increase the Deceleration Time. AC motor drive output power is too small: Replace the AC motor drive with the next higher power model. |
| | <p>Over-current during steady state operation (Output current exceeds triple rated current during constant speed.)</p> <p>Corrective Actions:</p> <ol style="list-style-type: none"> Short-circuit at motor output: Check for possible poor insulation at the output line. Sudden increase in motor loading: Check for possible motor stall. AC motor drive output power is too small: Replace the AC motor drive with the next higher power model. |

| Display | Description |
|--|--|
| <div style="border: 1px solid black; padding: 5px; width: fit-content;"> Ground Fault Fa FaultCode: 04 </div> | <p>Ground fault</p> <p>Corrective Actions: When (one of) the output terminal(s) is grounded, short circuit current is more than 50% of AC motor drive rated current, the AC motor drive power module may be damaged. NOTE: The short circuit protection is provided for AC motor drive protection, not for protection of the user.</p> <ol style="list-style-type: none"> 1. Check the wiring connections between the AC motor drive and motor for possible short circuits, also to ground. 2. Check whether the IGBT power module is damaged. 3. Check for possible poor insulation at the output line. |
| <div style="border: 1px solid black; padding: 5px; width: fit-content;"> Short Fault Fa FaultCode: 05 </div> | <p>Short-circuit is detected between upper bridge and lower bridge of the IGBT module.</p> <p>Corrective Actions: Return to the factory</p> |
| <div style="border: 1px solid black; padding: 5px; width: fit-content;"> oc at Stop Fa FaultCode: 06 </div> | <p>Over-current at stop</p> <p>Corrective Actions: Return to the factory</p> |
| <div style="border: 1px solid black; padding: 5px; width: fit-content;"> ov at Accel Fa FaultCode: 07 </div> | <p>DC BUS over-voltage during acceleration (230V: DC 450V; 460V: DC 900V)</p> <p>Corrective Actions:</p> <ol style="list-style-type: none"> 1. Check if the input voltage falls within the rated AC motor drive input voltage range. 2. Check for possible voltage transients. 3. If DC BUS over-voltage due to regenerative voltage, please increase the Deceleration Time or add an optional brake resistor. |
| <div style="border: 1px solid black; padding: 5px; width: fit-content;"> ov at Decel Fa FaultCode: 08 </div> | <p>DC BUS over-voltage during deceleration (230V: DC 450V; 460V: DC 900V)</p> <p>Corrective Actions:</p> <ol style="list-style-type: none"> 1. Check if the input voltage falls within the rated AC motor drive input voltage range. 2. Check for possible voltage transients. 3. If DC BUS over-voltage due to regenerative voltage, please increase the Deceleration Time or add an optional brake resistor. |
| <div style="border: 1px solid black; padding: 5px; width: fit-content;"> ov at Normal SPD Fa FaultCode: 09 </div> | <p>DC BUS over-voltage during constant speed (230V: DC 450V; 460V: DC 900V)</p> <p>Corrective Actions:</p> <ol style="list-style-type: none"> 1. Check if the input voltage falls within the rated AC motor drive input voltage range. 2. Check for possible voltage transients. 3. If DC BUS over-voltage due to regenerative voltage, please increase the Deceleration Time or add an optional brake resistor. |

| Display | Description |
|---|---|
| <div style="border: 1px solid black; padding: 5px; width: fit-content;"> ov at Stop Fα Fault Code: 10 </div> | DC BUS over-voltage at stop Corrective Actions: <ol style="list-style-type: none"> 1. Check if the input voltage falls within the rated AC motor drive input voltage range. 2. Check for possible voltage transients. |
| <div style="border: 1px solid black; padding: 5px; width: fit-content;"> Lv at Accel Fα Fault Code: 11 </div> | DC BUS voltage is less than Pr.06-00 during acceleration. Corrective Actions: <ol style="list-style-type: none"> 1. Check if the input voltage is normal 2. Check for possible sudden load |
| <div style="border: 1px solid black; padding: 5px; width: fit-content;"> Lv at Decel Fα Fault Code: 12 </div> | DC BUS voltage is less than Pr.06-00 during deceleration. Corrective Actions: <ol style="list-style-type: none"> 1. Check if the input voltage is normal 2. Check for possible sudden load |
| <div style="border: 1px solid black; padding: 5px; width: fit-content;"> Lv at Normal SPD Fα Fault Code: 13 </div> | DC BUS voltage is less than Pr.06-00 during constant speed. Corrective Actions: <ol style="list-style-type: none"> 1. Check if the input voltage is normal 2. Check for possible sudden load |
| <div style="border: 1px solid black; padding: 5px; width: fit-content;"> Lv at Stop Fα Fault Code: 14 </div> | Low voltage at stop Corrective Actions: <ol style="list-style-type: none"> 1. Check if the input voltage is normal 2. Check for possible sudden load |
| <div style="border: 1px solid black; padding: 5px; width: fit-content;"> Phase Loss Fα Fault Code: 15 </div> | Phase loss Corrective Actions: Check Power Source Input if all 3 input phases are connected without loose contacts. |
| <div style="border: 1px solid black; padding: 5px; width: fit-content;"> IGBT Over Heat Fα Fault Code: 16 </div> | IGBT overheating IGBT temperature exceeds protection level 1 to 15HP: 90 °C 20 to 100HP: 100 °C Corrective Actions: <ol style="list-style-type: none"> 1. Ensure that the ambient temperature falls within the specified temperature range. 2. Make sure that the ventilation holes are not obstructed. 3. Remove any foreign objects from the heatsinks and check for possible dirty heat sink fins. 4. Check the fan and clean it. 5. Provide enough spacing for adequate ventilation. |

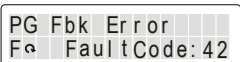
| Display | Description |
|---|---|
| Heat Sink oH F α Fault Code: 17 | <p>IGBT overheating IGBT temperature exceeds protection level 40 to100HP: 100 °C</p> <p>Corrective Actions:</p> <ol style="list-style-type: none"> 1. Ensure that the ambient temperature falls within the specified temperature range. 2. Make sure that the ventilation holes are not obstructed. 3. Remove any foreign objects from the heatsinks and check for possible dirty heat sink fins. 4. Check the fan and clean it. 5. Provide enough spacing for adequate ventilation. |
| IGBT HW Err F α Fault Code: 18 | <p>IGBT hardware failure</p> <p>Corrective Actions: Return to the factory</p> |
| Heat Sink HW Err F α Fault Code: 19 | <p>Heatsink overheating</p> <p>Corrective Actions: Return to the factory</p> |
| Fan Locked F α Fault Code: 20 | <p>Fan failure</p> <p>Corrective Actions:</p> <ol style="list-style-type: none"> 1. Make sure that the fan is not obstructed. 2. Return to the factory |
| Inverter oL F α Fault Code: 21 | <p>Overload The AC motor drive detects excessive drive output current. NOTE: The AC motor drive can withstand up to 150% of the rated current for a maximum of 60 seconds.</p> <p>Corrective Actions:</p> <ol style="list-style-type: none"> 1. Check whether the motor is overloaded. 2. Take the next higher power AC motor drive model. |
| Thermal Relay 1 F α Fault Code: 22 | <p>Motor 1 overload</p> <p>Corrective Actions:</p> <ol style="list-style-type: none"> 1. Check whether the motor is overloaded. 2. Check whether the rated current of motor (Pr.05-01) is suitable 3. Take the next higher power AC motor drive model. |
| Motor Over Heat F α Fault Code: 24 | <p>Motor overheating The AC motor drive detects that the internal temperature exceeds Pr.06-30 (PTC level)</p> <p>Corrective Actions:</p> <ol style="list-style-type: none"> 1. Make sure that the motor is not obstructed. 2. Ensure that the ambient temperature falls within the specified temperature range. 3. Take the next higher power AC motor drive model. |

| Display | Description |
|---|--|
| Over Torque 1 F _a Fault Code: 26 | Electronic Thermal Relay 1 Protection Corrective Actions: <ol style="list-style-type: none"> 1. Check whether the motor is overloaded. 2. Check whether motor rated current setting (Pr.05-01) is suitable 3. Check electronic thermal relay function 4. Take the next higher power AC motor drive model. |
| Over Torque 2 F _a Fault Code: 27 | Electronic Thermal Relay 2 Protection Corrective Actions: <ol style="list-style-type: none"> 1. Check whether the motor is overloaded. 2. Check whether motor rated current setting (Pr.05-01) is suitable 3. Check electronic thermal relay function 4. Take the next higher power AC motor drive model. |
| EEPROM Write Err F _a Fault Code: 30 | Internal EEPROM can not be programmed. Corrective Actions: <ol style="list-style-type: none"> 1. Press "RESET" key to the factory setting. 2. Return to the factory. |
| EEPROM Read Err F _a Fault Code: 31 | Internal EEPROM can not be read. Corrective Actions: <ol style="list-style-type: none"> 1. Press "RESET" key to the factory setting. 2. Return to the factory. |
| Isum Sensor Err F _a Fault Code: 32 | Hardware failure in current detection Corrective Actions: Re-power on to try it. If fault code is still displayed on the keypad, please return to the factory. |
| Ias Sensor Err F _a Fault Code: 33 | U-phase error Corrective Actions: Re-power on to try it. If fault code is still displayed on the keypad, please return to the factory. |
| Ibs Sensor Err F _a Fault Code: 34 | V-phase error Corrective Actions: Re-power on to try it. If fault code is still displayed on the keypad, please return to the factory. |
| Ics Sensor Err F _a Fault Code: 35 | W-phase error Corrective Actions: Re-power on to try it. If fault code is still displayed on the keypad, please return to the factory. |
| cc HW Error F _a Fault Code: 36 | CC (current clamp) Corrective Actions: Re-power on to try it. If fault code is still displayed on the keypad, please return to the factory. |

| Display | Description |
|---|--|
|  | OC hardware error Corrective Actions: Re-power on to try it. If fault code is still displayed on the keypad, please return to the factory. |
|  | OV hardware error Corrective Actions: Re-power on to try it. If fault code is still displayed on the keypad, please return to the factory. |
|  | GFF hardware error Corrective Actions: Re-power on to try it. If fault code is still displayed on the keypad, please return to the factory. |
|  | Auto tuning error Corrective Actions: <ol style="list-style-type: none"> 1. Check cabling between drive and motor 2. Check the motor capacity and parameters settings 3. Retry again |
|  | PID loss (ACI) Corrective Actions: <ol style="list-style-type: none"> 1. Check the wiring of the PID feedback 2. Check the PID parameters settings |
|  | PG feedback error Corrective Actions: Check if Pr.10-01 is not set to 0 when it is PG feedback control |
|  | PG feedback loss Corrective Actions: Check the wiring of the PG feedback |
|  | PG feedback stall Corrective Actions: <ol style="list-style-type: none"> 1. Check the wiring of the PG feedback 2. Check if the setting of PI gain and deceleration is suitable 3. Return to the factory |
|  | PG slip error Corrective Actions: <ol style="list-style-type: none"> 1. Check the wiring of the PG feedback 2. Check if the setting of PI gain and deceleration is suitable 3. Return to the factory |

| Display | Description |
|---|---|
| PG Ref Error F _a Fault Code: 46 | Pulse input error Corrective Actions: 1. Check the pulse wiring 2. Return to the factory |
| PG Ref Loss F _a Fault Code: 47 | Pulse input loss Corrective Actions: 1. Check the pulse wiring 2. Return to the factory |
| ACI Loss F _a Fault Code: 48 | ACI loss Corrective Actions: 1. Check the ACI wiring 2. Check if the ACI signal is less than 4mA |
| External Fault F _a Fault Code: 49 | External Fault Corrective Actions: 1. Input EF (N.O.) on external terminal is closed to GND. Output U, V, W will be turned off. 2. Give RESET command after fault has been cleared. |
| Emergency Stop F _a Fault Code: 50 | Emergency stop Corrective Actions: 1. When the multi-function input terminals MI1 to MI8 are set to emergency stop and the AC motor drive stops output. 2. Press RESET after fault has been cleared. |
| Base Block F _a Fault Code: 51 | Base Block Corrective Actions: 1. When the multi-function input terminals MI1 to MI8 are set to base block and the AC motor drive stops output. 2. Press RESET after fault has been cleared. |
| Password Error F _a Fault Code: 52 | Password is locked Corrective Actions: Keypad will be locked. Turn the power ON after power OFF to re-enter the correct password. See Pr.00-07 and 00-08. |
| PC Err Command F _a Fault Code: 54 | Illegal function code Corrective Actions: Check if the function code is correct (function code must be 03, 06, 10, 63) |
| PC Err Address F _a Fault Code: 55 | Illegal data length Corrective Actions: Check if the communication data length is correct. |
| PC Err Data F _a Fault Code: 56 | Illegal data value Corrective Actions: Check if the data value exceeds max./min. value. |

| Display | Description |
|--|--|
| PC Slave Fault F α FaultCode: 57 | illegal communication address Corrective Actions: Check if the communication address is correct. |
| PC Time Out F α FaultCode: 58 | Communication time-out Corrective Actions: Check if the wiring for the communication is correct. |
| PU Time Out F α FaultCode: 59 | Keypad (KPVLC001) communication time-out Corrective Actions: 1. Check if the wiring for the communication is correct 2. Check if there is any wrong with the keypad |
| Brk Chopper Fail F α FaultCode: 60 | Brake chopper fail Corrective Actions: Press RESET key to correct it. If fault code is still displayed on the keypad, please return to the factory. |
| Safety Relay Err F α FaultCode: 63 | Safety loop error Corrective Actions: 1. Check if the jumper JP18 is short circuit. 2. Re-power on to try it. If fault code is still displayed on the keypad, please return to the factory. |
| Mech Brake Fail F α FaultCode: 64 | Mechanical brake error Corrective Actions: 1. Check if the mechanical brake signal is correct. 2. Check if the detection time setting of mechanical brake (Pr.02-35) is correct. |
| PG HW Error F α FaultCode: 65 | PG hardware error Corrective Actions: 1. Check if the wiring of PG feedback is correct. 2. If fault code is still displayed on the keypad with correct PG feedback, please return to the factory. |

6.1.2 Reset

There are three methods to reset the AC motor drive after solving the fault:

1. Press  key on KPVLC001.
2. Set external terminal to "RESET" and then set to be ON.
3. Send "RESET" command by communication.



Make sure that RUN command or signal is OFF before executing RESET to prevent damage or personal injury due to immediate operation.

6.2 Maintenance and Inspections

Before the check-up, always turn off the AC input power and remove the cover. Wait at least 10 minutes after all display lamps have gone out, and then confirm that the capacitors have fully discharged by measuring the voltage between DC+ and DC-. The voltage between DC+ and DC- should be less than 25VDC.

■ Ambient environment

| Check Items | Methods and Criterion | Maintenance Period | | |
|---|--|--------------------|-----------|----------|
| | | Daily | Half Year | One Year |
| Check the ambient temperature, humidity, vibration and see if there are any dust, gas, oil or water drops | Visual inspection and measurement with equipment with standard specification | ○ | | |
| If there are any dangerous objects | Visual inspection | ○ | | |

■ Voltage

| Check Items | Methods and Criterion | Maintenance Period | | |
|---|---|--------------------|-----------|----------|
| | | Daily | Half Year | One Year |
| Check if the voltage of main circuit and control circuit is correct | Measure with multimeter with standard specification | ○ | | |

■ Keypad

| Check Items | Methods and Criterion | Maintenance Period | | |
|----------------------------------|-----------------------|--------------------|-----------|----------|
| | | Daily | Half Year | One Year |
| Is the display clear for reading | Visual inspection | ○ | | |
| Any missing characters | Visual inspection | ○ | | |

■ **Mechanical parts**

| Check Items | Methods and Criterion | Maintenance Period | | |
|---|-----------------------------|--------------------|-----------|----------|
| | | Daily | Half Year | One Year |
| If there is any abnormal sound or vibration | Visual and aural inspection | | ○ | |
| If there are any loose screws | Tighten the screws | | ○ | |
| If any part is deformed or damaged | Visual inspection | | ○ | |
| If there is any color change by overheating | Visual inspection | | ○ | |
| If there is any dust or dirt | Visual inspection | | ○ | |

■ **Main circuit**

| Check Items | Methods and Criterion | Maintenance Period | | |
|---|--|--------------------|-----------|----------|
| | | Daily | Half Year | One Year |
| If there are any loose or missing screws | Tighten or replace the screw | ○ | | |
| If machine or insulator is deformed, cracked, damaged or with color change due to overheating or ageing | Visual inspection NOTE: Please ignore the color change of copper plate | | ○ | |
| If there is any dust or dirt | Visual inspection | | ○ | |

■ **Terminals and wiring of main circuit**

| Check Items | Methods and Criterion | Maintenance Period | | |
|---|-----------------------|--------------------|-----------|----------|
| | | Daily | Half Year | One Year |
| If the terminal or the plate is color change or deformation due to overheat | Visual inspection | | ○ | |
| If the insulator of wiring is damaged or color change | Visual inspection | | ○ | |
| If there is any damage | Visual inspection | ○ | | |

■ **DC capacity of main circuit**

| Check Items | Methods and Criterion | Maintenance Period | | |
|--|-----------------------|--------------------|-----------|----------|
| | | Daily | Half Year | One Year |
| If there is any leak of liquid, color change, crack or deformation | Visual inspection | ○ | | |
| If the safety valve is not removed? If valve is inflated? | Visual inspection | ○ | | |
| Measure static capacity when required | | ○ | | |

■ **Resistor of main circuit**

| Check Items | Methods and Criterion | Maintenance Period | | |
|--|---|--------------------|-----------|----------|
| | | Daily | Half Year | One Year |
| If there is any peculiar smell or insulator cracks due to overheat | Visual inspection, smell | ○ | | |
| If there is any disconnection | Visual inspection | ○ | | |
| If connection is damaged? | Measure with multimeter with standard specification | ○ | | |

■ **Transformer and reactor of main circuit**

| Check Items | Methods and Criterion | Maintenance Period | | |
|--|------------------------------------|--------------------|-----------|----------|
| | | Daily | Half Year | One Year |
| If there is any abnormal vibration or peculiar smell | Visual, aural inspection and smell | ○ | | |

■ **Magnetic contactor and relay of main circuit**

| Check Items | Methods and Criterion | Maintenance Period | | |
|--------------------------------|-----------------------------|--------------------|-----------|----------|
| | | Daily | Half Year | One Year |
| If there are any loose screws | Visual and aural inspection | ○ | | |
| If the contact works correctly | Visual inspection | ○ | | |

■ **Printed circuit board and connector of main circuit**

| Check Items | Methods and Criterion | Maintenance Period | | |
|---|--|--------------------|-----------|----------|
| | | Daily | Half Year | One Year |
| If there are any loose screws and connectors | Tighten the screws and press the connectors firmly in place. | | ○ | |
| If there is any peculiar smell and color change | Visual and smell inspection | | ○ | |
| If there is any crack, damage, deformation or corrosion | Visual inspection | | ○ | |
| If there is any liquid is leaked or deformation in capacity | Visual inspection | | ○ | |

■ **Cooling fan of cooling system**

| Check Items | Methods and Criterion | Maintenance Period | | |
|--|---|--------------------|-----------|----------|
| | | Daily | Half Year | One Year |
| If there is any abnormal sound or vibration | Visual, aural inspection and turn the fan with hand (turn off the power before operation) to see if it rotates smoothly | | ○ | |
| If there is any loose screw | Tighten the screw | | ○ | |
| If there is any color change due to overheat | Change fan | | ○ | |

■ **Ventilation channel of cooling system**

| Check Items | Methods and Criterion | Maintenance Period | | |
|--|-----------------------|--------------------|-----------|----------|
| | | Daily | Half Year | One Year |
| If there is any obstruction in the heat sink, air intake or air outlet | Visual inspection | | ○ | |



Please use the neutral cloth for clean and use dust cleaner to remove dust when necessary.

This page intentionally left blank

Appendix A Specifications

There are 230V and 460V models for customers to choose by their requirement.

| Voltage Class | | 230V Class | | | | | | | |
|-----------------------------------|---|---------------------------------------|------|------|-----|------|-----|------|-----|
| Model Number VFD-XXXVL | | 055 | 075 | 110 | 150 | 185 | 220 | 300 | 370 |
| Max. Applicable Motor Output (kW) | | 5.5 | 7.5 | 11 | 15 | 18.5 | 22 | 30 | 37 |
| Max. Applicable Motor Output (hp) | | 7.5 | 10 | 15 | 20 | 25 | 30 | 40 | 50 |
| Output Rating | Rated Output Capacity (kVA) | 9.5 | 12.5 | 19 | 25 | 29 | 34 | 46 | 55 |
| | Rated Output Current for General Purposes (A) | 21.9 | 27.1 | 41.1 | 53 | 70 | 79 | 120 | 146 |
| | **Rated Output Current for Elevators (A) | 25 | 31 | 47 | 60 | 80 | 90 | 150 | 183 |
| | Maximum Output Voltage (V) | 3-Phase Proportional to Input Voltage | | | | | | | |
| | Output Frequency (Hz) | 0.00~120.00 Hz | | | | | | | |
| Input Rating | Carrier Frequency (kHz) | 12kHz | | | | | | 9kHz | |
| | Rated Input Current (A) | 25 | 31 | 47 | 60 | 80 | 90 | 106 | 126 |
| | Rated Voltage/Frequency | 3-phase 200-240V, 50/60Hz | | | | | | | |
| | Voltage Tolerance | ±10%(180~264 V) | | | | | | | |
| | Frequency Tolerance | ±5%(47~63 Hz) | | | | | | | |
| | Cooling Method | Fan Cooled | | | | | | | |
| | Weight (kg) | 8 | 10 | 10 | 13 | 13 | 13 | 36 | 36 |

| Voltage Class | | 460V Class | | | | | | | | | | |
|-----------------------------------|---|---------------------------------------|------|-----|-----|------|------|-----|-----|------|-----|-----|
| Model Number VFD-XXXVL | | 055 | 075 | 110 | 150 | 185 | 220 | 300 | 370 | 450 | 550 | 750 |
| Max. Applicable Motor Output (kW) | | 5.5 | 7.5 | 11 | 15 | 18.5 | 22 | 30 | 37 | 45 | 55 | 75 |
| Max. Applicable Motor Output (hp) | | 7.5 | 10 | 15 | 20 | 25 | 30 | 40 | 50 | 60 | 75 | 100 |
| Output Rating | Rated Output Capacity (kVA) | 9.9 | 13.7 | 18 | 24 | 29 | 34 | 46 | 56 | 69 | 80 | 100 |
| | Rated Output Current for General Purposes (A) | 12.3 | 15.8 | 21 | 27 | 34 | 41 | 60 | 73 | 91 | 110 | 150 |
| | **Rated Output Current for Elevators (A) | 14 | 18 | 24 | 31 | 39 | 47 | 75 | 91 | 113 | 138 | 188 |
| | Maximum Output Voltage (V) | 3-phase Proportional to Input Voltage | | | | | | | | | | |
| | Output Frequency (Hz) | 0.00~120.00 Hz | | | | | | | | | | |
| Input Rating | Carrier Frequency (kHz) | 15kHz | | | | | 9kHz | | | 6kHz | | |
| | Rated Input Current (A) | 14 | 18 | 24 | 31 | 39 | 47 | 56 | 67 | 87 | 101 | 122 |
| | Rated Voltage | 3-phase 380 to 480 V, 50/60Hz | | | | | | | | | | |
| | Voltage Tolerance | ±10%(342~528 V) | | | | | | | | | | |
| | Frequency Tolerance | ±5%(47~63 Hz) | | | | | | | | | | |
| | Cooling Method | Fan Cooled | | | | | | | | | | |
| | Weight (kg) | 8 | 10 | 10 | 13 | 13 | 13 | 36 | 36 | 36 | 50 | 50 |



**Rated Output Current for Elevators (A)

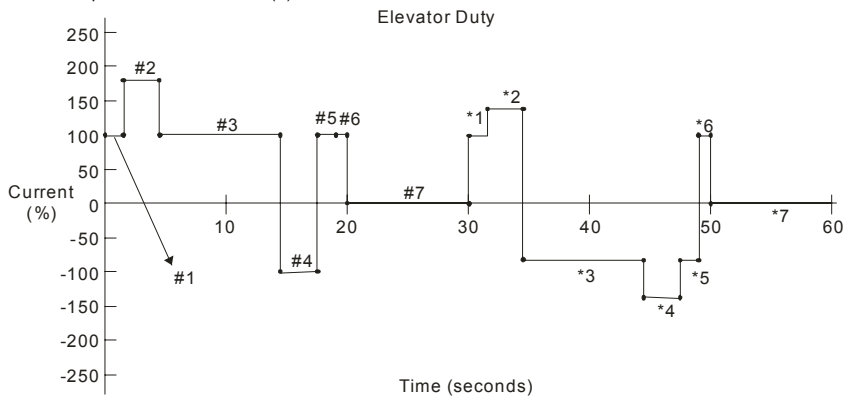

| Event | Description | Time(s) | Current |
|-------|-------------|---------|---------|
| #1 | Per torque | 1.5 | 100% |
| #2 | Accel up | 3 | 175% |
| #3 | Cruise | 10 | 100% |
| #4 | Decel up | 3 | 115% |
| #5 | Post | 1.5 | 140% |
| #6 | Per torque | 1 | 100% |
| #7 | Rest | 10 | 0% |
| *1 | Per torque | 1.5 | 100% |
| *2 | Accel up | 3 | 140% |
| *3 | Cruise | 10 | 80% |
| *4 | Decel up | 3 | 140% |
| *5 | Post | 1.5 | 140% |
| *6 | Per torque | 1 | 100% |
| *7 | Rest | 10 | 0% |

General Specifications

| | | |
|----------------------------|---|--|
| Control Characteristics | Control System | 1: V/f, 2: VF+PG, 3: SVC, 4: FOC+PG, 5: TQR+PG, 6:FOC+PM |
| | Start Torque | Starting torque is 150% at 0.5Hz and 0Hz with control modes FOC + PG and FOC+PM |
| | Speed Control Range | 1:100 Sensorless vector (up to 1:1000 when using PG card) |
| | Speed Control Resolution | ±0.5% Sensorless vector (up to±0.02% when using PG card) |
| | Speed Response Ability | 5Hz (up to 30Hz for vector control) |
| | Max. Output Frequency | 0.00 to 120.00Hz |
| | Output Frequency Accuracy | Digital command ±0.005%, analog command ±0.5% |
| | Frequency Setting Resolution | Digital command ±0.01Hz, analog command: 1/4096(12-bit) of the max. output frequency |
| | Torque Limit | Max. is 200% torque current |
| | Torque Accuracy | ±5% |
| | Accel/Decel Time | 0.00 to 600.00/0.0 to 6000.0 seconds |
| | V/f Curve | Adjustable V/f curve using 4 independent points and square curve |
| | Frequency Setting Signal | 0-+10V, ±10V, 4-20mA |
| Brake Torque | About 20% | |
| Protection Characteristics | Motor Protection | Electronic thermal relay protection |
| | Over-current Protection | The current forces 220% of the over-current protection and 300% of the rated current |
| | Ground Leakage Current Protection | Higher than 50% rated current |
| | Overload Ability | Constant torque: 150% for 60 seconds, variable torque: 200% for 3 seconds |
| | Over-voltage Protection | Over-voltage level: Vdc > 400/800V; low-voltage level: Vdc < 200/400V |
| | Over-voltage Protection for the Input Power | Varistor (MOV) |
| | Over-temperature Protection | Built-in temperature sensor |
| Environmental Conditions | Compensation for the Momentary Power Loss | Up to 5 seconds for parameter setting |
| | Protection Level | NEMA 1/IP20 |
| | Operation Temperature | -10°C to 45°C |
| | Storage Temperature | -20°C to 60°C |
| | Ambient Humidity | Below 90% RH (non-condensing) |
| | Vibration | 9.80665m/s ² (1G) less than 20Hz, 5.88m/s ² (0.6G) at 20 to 50Hz |
| Installation Location | Altitude 1,000 m or lower, keep from corrosive gasses, liquid and dust | |
| Approvals |  | |

This page intentionally left blank

Appendix B Accessories

General Precautions



CAUTION

- This VFD-VL AC motor drive has gone through rigorous quality control tests at the factory before shipment. If the package is damaged during shipping, please contact your dealer.
 - The accessories produced by Delta are only for using with Delta AC motor drive. Do NOT use with other drive to prevent damage.
-

B.1 All Brake Resistors & Brake Units Used in AC Motor Drives

| Voltage | Applicable Motor | | Full Load Torque Nm | Resistor value spec for each AC Motor Drive | Brake Torque 10%ED | Min. Equivalent Resistor Value for each AC Motor Drive |
|-------------|------------------|------|---------------------|---|--------------------|--|
| | hp | kW | | | | |
| 230V Series | 7.5 | 5.5 | 3.111 | 2400W 16Ω | 125 | 16Ω |
| | 10 | 7.5 | 4.148 | 3000W 12Ω | 125 | 12Ω |
| | 15 | 11 | 6.186 | 4800W 9Ω | 125 | 9Ω |
| | 20 | 15 | 8.248 | 4800W 6.8Ω | 125 | 6.8Ω |
| | 25 | 18.5 | 10.281 | 6000W 6Ω | 125 | 6Ω |
| | 30 | 22 | 12.338 | 9600W 5Ω | 125 | 5Ω |
| | 40 | 30 | 16.497 | 6000W 5Ω | 125 | 5Ω |
| | 50 | 37 | 20.6 | 9600W 4Ω | 125 | 4Ω |
| 460V Series | 7.5 | 5.5 | 3.111 | 500W 50Ω | 125 | 50Ω |
| | 10 | 7.5 | 4.148 | 1000W 40Ω | 125 | 40Ω |
| | 15 | 11 | 6.186 | 1000W 33Ω | 125 | 33Ω |
| | 20 | 15 | 8.248 | 1500W 25Ω | 125 | 25Ω |
| | 25 | 18.5 | 10.281 | 4800W 21Ω | 125 | 21Ω |
| | 30 | 22 | 12.338 | 4800W 19Ω | 125 | 19Ω |
| | 40 | 30 | 16.497 | 6000W 20Ω | 125 | 20Ω |
| | 50 | 37 | 20.6 | 9600W 16Ω | 125 | 16Ω |
| | 60 | 45 | 24.745 | 9600W 13.6Ω | 125 | 13.6Ω |
| | 75 | 55 | 31.11 | 12000W 10Ω | 125 | 10Ω |
| 100 | 75 | 42.7 | 19200W 6.8Ω | 125 | 6.8Ω | |

NOTE

1. Please select the recommended resistance value (Watt) and the duty-cycle value (ED%).
2. Definition for Brake Usage ED%

Explanation: The definition of the brake usage ED(%) is for assurance of enough time for the brake unit and brake resistor to dissipate away heat generated by braking. When the brake resistor heats up, the resistance would increase with temperature, and brake torque would decrease accordingly. Recommended cycle time is one minute.

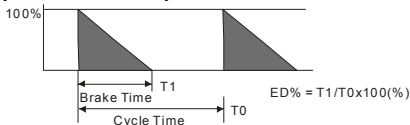

3. For safety consideration, install an overload relay between the brake unit and the brake resistor. In conjunction with the magnetic contactor (MC) prior to the drive, it can perform complete protection against abnormality. The purpose of installing the thermal overload relay is to protect

the brake resistor from damage due to frequent brake, or due to brake unit keeping operating resulted from unusual high input voltage. Under such circumstance, just turn off the power to prevent damaging the brake resistor.

4. If damage to the drive or other equipment are due to the fact that the brake resistors and the brake modules in use are not provided by Delta, the warranty will be void.
5. Take into consideration the safety of the environment when installing the brake resistors.
6. If the minimum resistance value is to be utilized, consult local dealers for the calculation of the Watt figures.
7. Please select thermal relay trip contact to prevent resistor over load. Use the contact to switch power off to the AC motor drive!
8. When using more than 2 brake units, equivalent resistor value of parallel brake unit can't be less than the value in the column "Minimum Equivalent Resistor Value for Each AC Drive" (the right-most column in the table).
9. Please read the wiring information in the user manual of brake unit thoroughly prior to taking into operation.

B.1.1 Dimensions and Weights for Brake Resistors

(Dimensions are in millimeter)

Order P/N: BR080W200, BR080W750, BR300W070, BR300W100, BR300W250, BR300W400, BR400W150, BR400W040

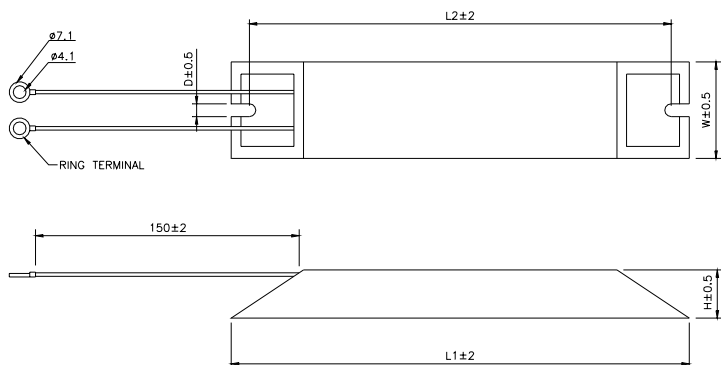

| Model no. | L1 | L2 | H | D | W | Max. Weight (g) |
|-----------|-----|-----|----|-----|----|-----------------|
| BR080W200 | 140 | 125 | 20 | 5.3 | 60 | 160 |
| BR080W750 | | | | | | |
| BR300W070 | 215 | 200 | 30 | 5.3 | 60 | 750 |
| BR300W100 | | | | | | |
| BR300W250 | | | | | | |
| BR300W400 | | | | | | |
| BR400W150 | 265 | 250 | 30 | 5.3 | 60 | 930 |
| BR400W040 | | | | | | |

Order P/N: BR500W030, BR500W100, BR1K0W020, BR1K0W075

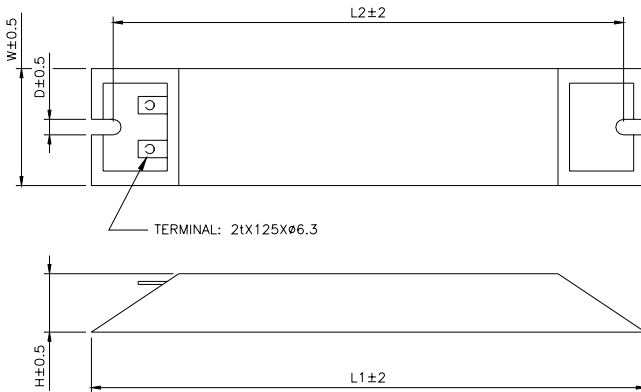

| Model no. | L1 | L2 | H | D | W | Max. Weight (g) |
|-----------|-----|-----|----|-----|-----|-----------------|
| BR500W030 | 335 | 320 | 30 | 5.3 | 60 | 1100 |
| BR500W100 | | | | | | |
| BR1K0W020 | 400 | 385 | 50 | 5.3 | 100 | 2800 |
| BR1K0W075 | | | | | | |

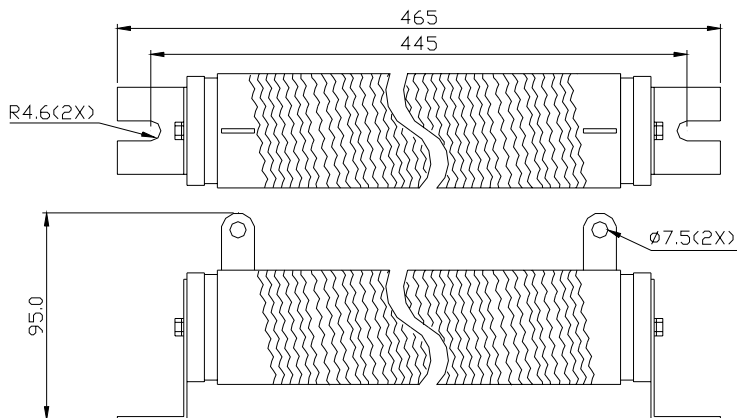

B.1.2 Specifications for Brake Unit

| | | 230V Series | | 460V Series | | |
|----------------------------|---------------------------------------|--|------|-----------------------------------|------|-----------------------------------|
| | | 2015 | 2022 | 4030 | 4045 | 4132 |
| Output Rating | Max. Motor Power (kW) | 15 | 22 | 30 | 45 | 132 |
| | Max. Peak Discharge Current (A) 10%ED | 40 | 60 | 40 | 60 | 240 |
| | Continuous Discharge Current (A) | 15 | 20 | 15 | 18 | 75 |
| | Brake Start-up Voltage (DC) | 330/345/360/380 /400/415 \pm 3V | | 660/690/720/760/ 800/830 \pm 6V | | 618/642/667/690 /725/750 \pm 6V |
| Input Rating | DC Voltage | 200~400VDC | | 400~800VDC | | |
| Protection | Heat Sink Overheat | Temperature over +95°C (203 °F) | | | | |
| | Alarm Output | Relay contact 5A 120VAC/28VDC (RA, RB, RC) | | | | |
| | Power Charge Display | Blackout until bus (+~-) voltage is below 50VDC | | | | |
| Environment | Installation Location | Indoor (no corrosive gases, metallic dust) | | | | |
| | Operating Temperature | -10°C ~ +50°C (14°F to 122°F) | | | | |
| | Storage Temperature | -20°C ~ +60°C (-4°F to 140°F) | | | | |
| | Humidity | 90% Non-condensing | | | | |
| | Vibration | 9.8m/s ² (1G) under 20Hz 2m/s ² (0.2G) at 20~50Hz | | | | |
| Wall-mounted Enclosed Type | | IP50 | | | IP10 | |

B.1.3 Dimensions for Brake Unit

(Dimensions are in millimeter[inch])

VFDB2015, VFDB2022, VFDB4030, VFDB4045

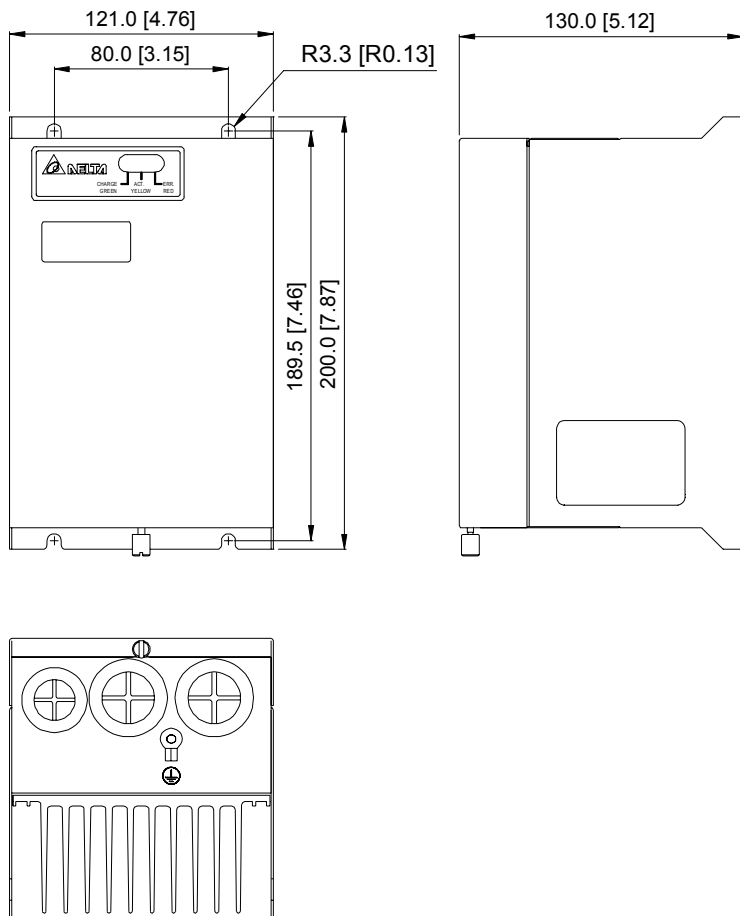

VFDB4132

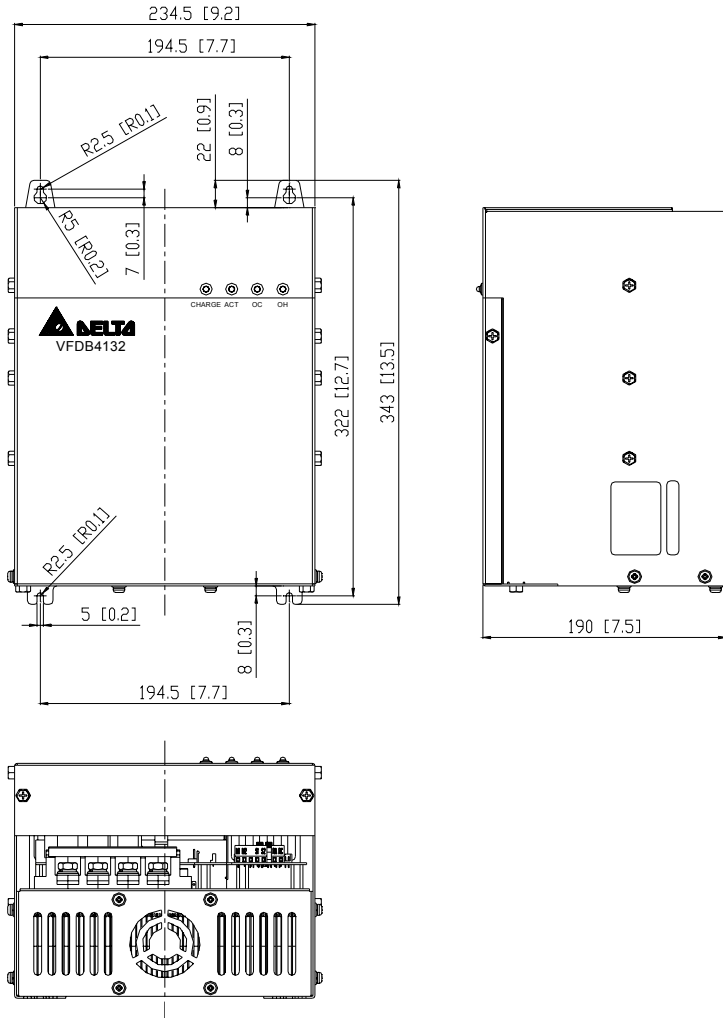

B.2 Non-fuse Circuit Breaker Chart

For 1-phase/3-phase drives, the current rating of the breaker shall be within 2-4 times maximum input current rating.

| 3-phase | | | |
|-------------|-------------------------------|-------------|-------------------------------|
| Model | Recommended Input Current (A) | Model | Recommended Input Current (A) |
| VFD055VL23A | 50 | VFD220VL23A | 175 |
| VFD055VL43A | 30 | VFD220VL43A | 100 |
| VFD075VL23A | 60 | VFD300VL23A | 225 |
| VFD075VL43A | 40 | VFD300VL43A | 125 |
| VFD110VL23A | 100 | VFD370VL23A | 250 |
| VFD110VL43A | 50 | VFD370VL43A | 150 |
| VFD150VL23A | 125 | VFD450VL43A | 175 |
| VFD150VL43A | 60 | VFD550VL43A | 250 |
| VFD185VL23A | 150 | VFD750VL43A | 300 |
| VFD185VL43A | 75 | | |

B.3 Fuse Specification Chart

Smaller fuses than those shown in the table are permitted.

| Model | I (A) Input | I (A) Output | Line Fuse | |
|-------------|----------------|-----------------|-----------|--------------|
| | | | I (A) | Bussmann P/N |
| VFD055VL23A | 26 | 25 | 50 | JJN-50 |
| VFD055VL43A | 14 | 13 | 30 | JJN-30 |
| VFD075VL23A | 34 | 33 | 60 | JJN-60 |
| VFD075VL43A | 19 | 18 | 40 | JJN-40 |
| VFD110VL23A | 50 | 49 | 100 | JJN-100 |
| VFD110VL43A | 25 | 24 | 50 | JJN-50 |
| VFD150VL23A | 60 | 65 | 125 | JJN-125 |
| VFD150VL43A | 32 | 32 | 60 | JJN-60 |
| VFD185VL23A | 75 | 75 | 150 | JJN-150 |
| VFD185VL43A | 39 | 38 | 75 | JJN-70 |
| VFD220VL23A | 90 | 90 | 175 | JJN-175 |
| VFD220VL43A | 49 | 45 | 100 | JJN-100 |

| Model | I (A) Input | I (A) Output | Line Fuse | |
|-------------|----------------|-----------------|-----------|--------------|
| | | | I (A) | Bussmann P/N |
| VFD300VL23A | 110 | 120 | 225 | JJN-225 |
| VFD300VL43A | 60 | 60 | 125 | JJN-125 |
| VFD370VL23A | 142 | 145 | 250 | JJN-250 |
| VFD370VL43A | 63 | 73 | 150 | JJN-150 |
| VFD450VL43A | 90 | 91 | 175 | JJN-175 |
| VFD550VL43A | 130 | 110 | 250 | JJN-250 |
| VFD750VL43A | 160 | 150 | 300 | JJN-300 |

B.4 AC Reactor

B.4.1 AC Input Reactor Recommended Value

460V, 50/60Hz, 3-Phase

| kW | HP | Fundamental Amps | Max. continuous Amps | Inductance (mH) | |
|------|-----|------------------|----------------------|-----------------|--------------|
| | | | | 3% impedance | 5% impedance |
| 5.5 | 7.5 | 12 | 18 | 2.5 | 4.2 |
| 7.5 | 10 | 18 | 27 | 1.5 | 2.5 |
| 11 | 15 | 25 | 37.5 | 1.2 | 2 |
| 15 | 20 | 35 | 52.5 | 0.8 | 1.2 |
| 18.5 | 25 | 35 | 52.5 | 0.8 | 1.2 |
| 22 | 30 | 45 | 67.5 | 0.7 | 1.2 |
| 30 | 40 | 55 | 82.5 | 0.5 | 0.85 |
| 37 | 50 | 80 | 120 | 0.4 | 0.7 |
| 45 | 60 | 80 | 120 | 0.4 | 0.7 |
| 55 | 75 | 100 | 150 | 0.3 | 0.45 |
| 75 | 100 | 130 | 195 | 0.2 | 0.3 |

B.4.2 AC Output Reactor Recommended Value

230V, 50/60Hz, 3-Phase

| kW | HP | Fundamental Amps | Max. continuous Amps | Inductance (mH) | |
|------|-----|------------------|----------------------|-----------------|--------------|
| | | | | 3% impedance | 5% impedance |
| 5.5 | 7.5 | 25 | 37.5 | 0.5 | 1.2 |
| 7.5 | 10 | 35 | 52.5 | 0.4 | 0.8 |
| 11 | 15 | 55 | 82.5 | 0.25 | 0.5 |
| 15 | 20 | 80 | 120 | 0.2 | 0.4 |
| 18.5 | 25 | 80 | 120 | 0.2 | 0.4 |
| 22 | 30 | 100 | 150 | 0.15 | 0.3 |
| 30 | 40 | 130 | 195 | 0.1 | 0.2 |
| 37 | 50 | 160 | 240 | 0.075 | 0.15 |

| kW | HP | Fundamental Amps | Max. continuous Amps | Inductance (mH) | |
|------|-----|------------------|----------------------|-----------------|--------------|
| | | | | 3% impedance | 5% impedance |
| 5.5 | 7.5 | 18 | 27 | 1.5 | 2.5 |
| 7.5 | 10 | 18 | 27 | 1.5 | 2.5 |
| 11 | 15 | 25 | 37.5 | 1.2 | 2 |
| 15 | 20 | 35 | 52.5 | 0.8 | 1.2 |
| 18.5 | 25 | 45 | 67.5 | 0.7 | 1.2 |
| 22 | 30 | 45 | 67.5 | 0.7 | 1.2 |
| 30 | 40 | 80 | 120 | 0.4 | 0.7 |
| 37 | 50 | 80 | 120 | 0.4 | 0.7 |
| 45 | 60 | 100 | 150 | 0.3 | 0.45 |
| 55 | 75 | 130 | 195 | 0.2 | 0.3 |
| 75 | 100 | 160 | 240 | 0.15 | 0.23 |

B.4.3 Applications for AC Reactor

Connected in input circuit

| Application 1 | Question |
|---|---|
| When more than one AC motor drive is connected to the same power, one of them is ON during operation. | When applying to one of the AC motor drive, the charge current of capacity may cause voltage ripple. The AC motor drive may damage when over current occurs during operation. |

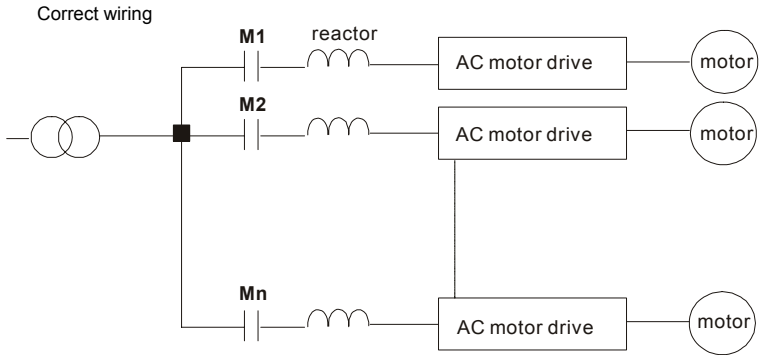

| Application 2 | Question |
|--|---|
| Silicon rectifier and AC motor drive is connected to the same power. | Surges will be generated at the instant of silicon rectifier switching on/off. These surges may damage the mains circuit. |

Correct wiring

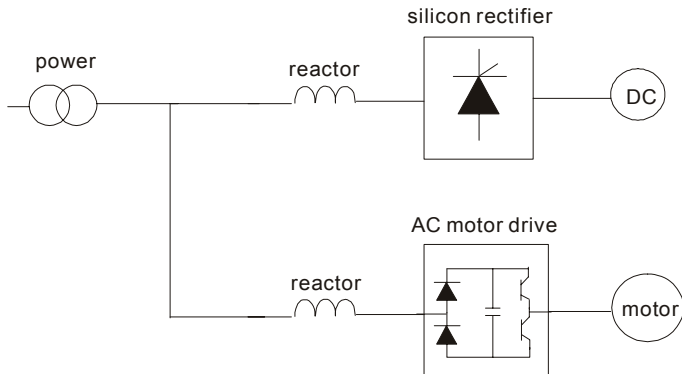

| Application 3 | Question |
|--|--|
| Used to improve the input power factor, to reduce harmonics and provide protection from AC line disturbances (surges, switching spikes, short interruptions, etc.). AC line reactor should be installed when the power supply capacity is 500kVA or more and exceeds 6 times the inverter capacity, or the mains wiring distance $\leq 10\text{m}$. | When power capacity is too large, line impedance will be small and the charge current will be too large. That may damage AC motor drive due to higher rectifier temperature. |

Correct wiring

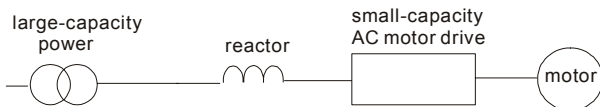

B.5 Zero Phase Reactor (RF220X00A)

Dimensions are in millimeter and (inch)

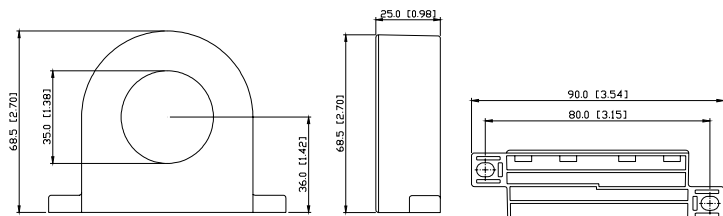

| Cable type (Note) | Recommended Wire Size | | | Qty. | Wiring Method |
|----------------------|-----------------------|-----------------|----------------------------|------|---------------|
| | AWG | mm ² | Nominal (mm ²) | | |
| Single-core | ≤ 10 | ≤ 5.3 | ≤ 5.5 | 1 | Diagram A |
| | ≤ 2 | ≤ 33.6 | ≤ 38 | 4 | Diagram B |
| Three-core | ≤ 12 | ≤ 3.3 | ≤ 3.5 | 1 | Diagram A |
| | ≤ 1 | ≤ 42.4 | ≤ 50 | 4 | Diagram B |

Note: 600V Insulated unshielded Cable.

Diagram A

Please wind each wire 4 times around the core. The reactor must be put at inverter output as close as possible.

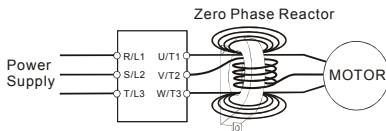
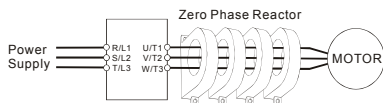

Diagram B

Please put all wires through 4 cores in series without winding.



Note 1: The table above gives approximate wire size for the zero phase reactors but the selection is ultimately governed by the type and diameter of cable fitted i.e. the cable must fit through the center hole of zero phase reactors.

Note 2: Only the phase conductors should pass through, not the earth core or screen.

Note 3: When long motor output cables are used an output zero phase reactor may be required to reduce radiated emissions from the cable.

B.6 DC Choke Recommended Values

230V DC Choke

| Input voltage | kW | HP | DC Amps | Inductance (mh) |
|------------------------------|------|-----|---------|-----------------|
| 230Vac 50/60Hz 3-Phase | 5.5 | 7.5 | 32 | 0.85 |
| | 7.5 | 10 | 40 | 0.75 |
| | 11 | 15 | 62 | Built-in |
| | 15 | 20 | 92 | Built-in |
| | 18.5 | 25 | 110 | Built-in |
| | 22 | 30 | 125 | Built-in |
| | 30 | 40 | - | Built-in |
| | 37 | 50 | - | Built-in |

460V DC Choke

| Input voltage | kW | HP | DC Amps | Inductance (mh) |
|------------------------------|------|-----|---------|-----------------|
| 460Vac 50/60Hz 3-Phase | 5.5 | 7.5 | 18 | 3.75 |
| | 7.5 | 10 | 25 | 4.00 |
| | 11 | 15 | 32 | Built-in |
| | 15 | 20 | 50 | Built-in |
| | 18.5 | 25 | 62 | Built-in |
| | 22 | 30 | 80 | Built-in |
| | 30 | 40 | 92 | Built-in |
| | 37 | 50 | 110 | Built-in |
| | 45 | 60 | 125 | Built-in |
| | 55 | 75 | 200 | Built-in |
| | 75 | 100 | 240 | Built-in |

B.7 Digital Keypad KPVL-CC01

The digital keypad is the display of VFD-VL series. The following keypad appearance is only for reference and please see the product for actual appearance.

B.7.1 Description of the Digital Keypad KPVL-CC01

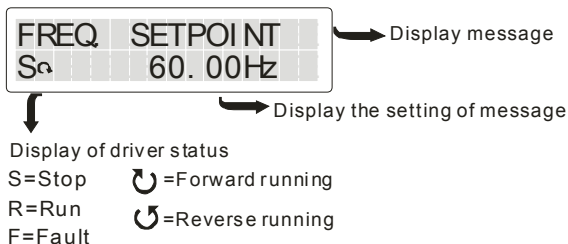

| Display Message | Descriptions |
|-----------------------|--|
| <p>Press MODE key</p> | Displays the AC drive Master Frequency |
| <p>Press MODE key</p> | Displays the actual output frequency present at terminals U/T1, V/T2, and W/T3 |

| Display Message | Descriptions |
|---|---|
| DC- BUS VOLTAGE R α 716.0Vdc Press MODE key | Displays the voltage of DC BUS |
| OUTPUT CURRENT S α 0.00Amps Press MODE key | Displays the output current present at terminals U/T1, V/T2, and W/T3 |
| OUTPUT VOLTAGE S α 0.0Volt Press MODE key | Displays the output voltage of motor |
| U: Output Current S α 0.0Amps Press MODE key | User defined unit (Where U= Pr.00-04) |
| PARAM COPY S α READ 1 | Copy the first set of parameter groups from the drive to the keypad. It can save two sets of parameter groups to keypad. (one set is from group 0 to group 13) |
| PARAM COPY S α SAVE 1 v1.00 | Save the first set of parameter groups from the keypad to other drive. The firmware version is 1.00. |
| SYSTEM PARAMETER S α 00- | Displays the group number |
| Rated Current 27.10Amp | Displays the actual stored value of the selected parameter |
| External Fault F α FaultCode: 60 | External Fault |
| -- End. -- | Display "End" for approximately 1 second if input has been accepted by pressing PROG/DATA key. After a parameter value has been set, the new value is automatically stored in memory. |
| -- Err. -- | Display "Err", if the input is invalid. |

B.7.2 How to Operate the Digital Keypad KPVL-CC01

Selection Mode

FREQ. SETPOINT
S_a 60.00Hz



OUTPUT FREQ.
S_a 0.00Hz



DC- BUS VOLTAGE
S_a 253.0Vdc



OUTPUT CURRENT
S_a 0.00Amps



OUTPUT VOLTAGE
S_a 0.0Volt



U: Output Current
S_a 0.0Amps



return to the start-up display

In the selection mode, press



PARAM DATA

to set the parameters.

To set parameters

SYSTEM PARAMETER
S_a 00-



Rated Current
S_a 00-01



Rated Current
S_a 27.10Amps



Parameter Reset
S_a 00-02



Parameter Reset
S_a 10



-- End. --



Parameter Reset
S_a 00-02



return to the previous display

In the parameters mode, it will display parameters and parameters definitions

To copy parameters

From drive to KPVL-CC01

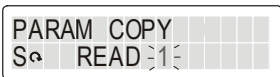

Press and hold on for about 5 seconds

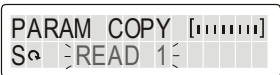

When "READ 1" starts blinking, it starts to save to KPVL-CC01.

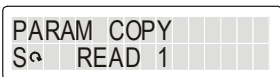

Finish to save parameters

From KPVL-CC01 to drive

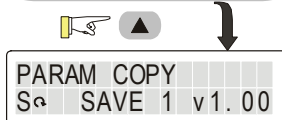

Press and hold on for about 5 seconds



When "SAVE 1" starts blinking, it starts to save to KPVL-CC01. V1.00 is the firmware version. It fails to save to KPVL-CC01 when it displays V ---. It needs to save parameters from drive to KPVL-CC01 first.

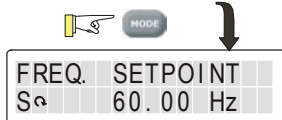

When entering error parameters setting

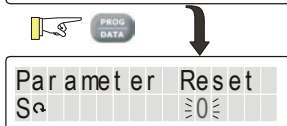

Enter parameter settings

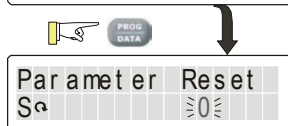

Please re-enter the correct value when the setting is blinking.

B.7.3 Dimension of the Digital Keypad

Unit: mm [inch]

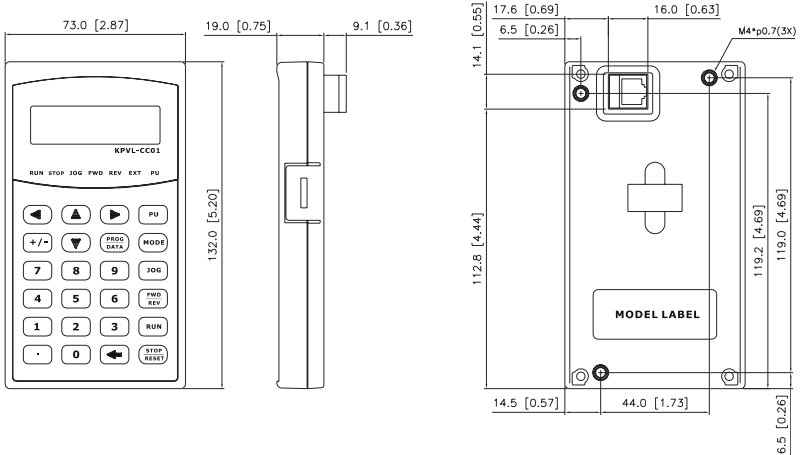

B.7.4 Recommended Position the Rubber Magnet of the Digital Keypad

This rubber magnet is shipped with the digital keypad. Users can adhere to anywhere of the back of the digital keypad to stick on the case of the AC motor drive. Please don't stick on the communication port to prevent reducing magnetic force.

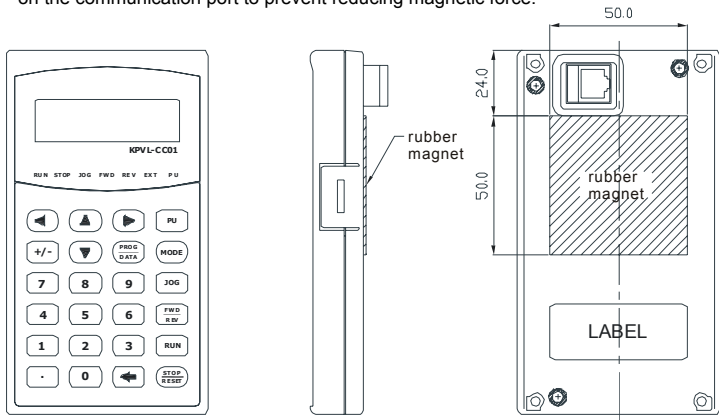

B.8 PG Card (for Encoder)

B.8.1 EMVL-PGABL

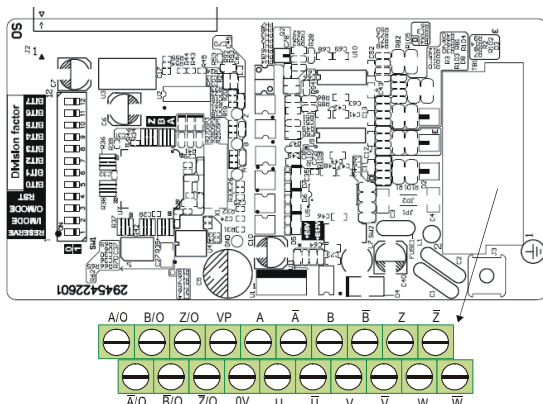

1. Terminals descriptions

| Terminal Symbols | | Descriptions | Specifications |
|------------------|---|--|---|
| TB1 | VP | Power source of encoder (use SW2 to switch 12V/5V) | Voltage: +5V±0.5V or +12V±1V Current: 200mA max. |
| | 0V | Power source common for encoder | Reference level of the power of encoder |
| | A, \bar{A} , B, \bar{B} , Z, \bar{Z} | Incremental line driver input | Line driver RS422 Max. input frequency: 100 kHz |
| | U, \bar{U} , V, \bar{V} , W, \bar{W} | Absolute line driver input (UVW 3-bit code) | Line driver RS422 Max. input frequency: 50 kHz |
| | A/O, \bar{A} /O, B/O, \bar{B} /O, Z/O, Z/O | Signal output for PG feedback card and can be used as a frequency divider. | Line driver RS422 Max. output frequency: 100 kHz |
| J3 |  | Grounding | Connected to the grounding of the power of the AC motor drive and used for PG shielding |

2. Wire length

| Types of Pulse Generators | Maximum Wire Length | Wire Gauge |
|---------------------------|---------------------|--------------------------------------|
| Line Driver | 100m | 1.25mm ² (AWG16) or above |

3. Types of Pulse Generators (Encoders)

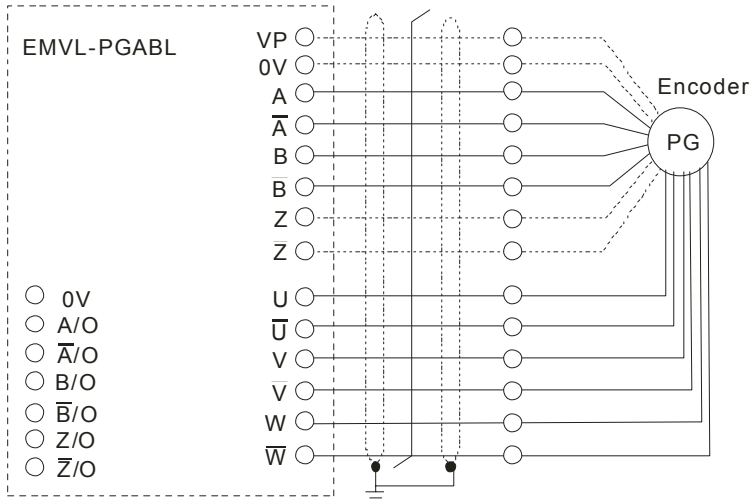
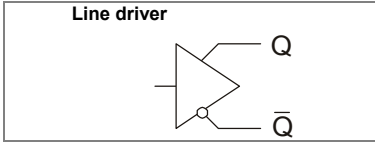

4. Output Signal Setting of the Frequency Divider

It generates the output signal of division factor "n" after dealing with the input pulse. Please set by the switch SW1 on the card.

RESERVE: reserved bit (PIN1)

I/MODE: input type setting of the division pulse (PIN 2)

O/MODE: output type setting of the division pulse (PIN 3)

RST: clock reset bit (PIN 4)

Division factor: setting of division factor n: 1~256 (PIN5~12)

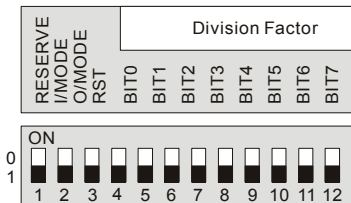

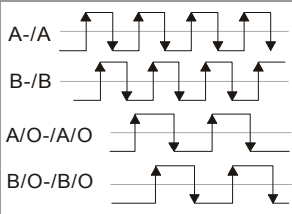
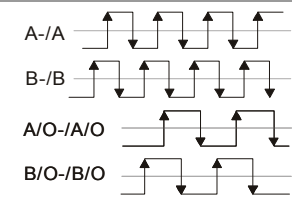
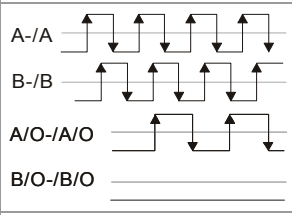
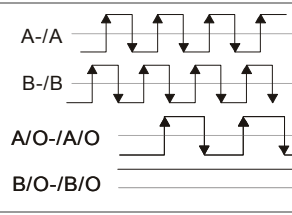
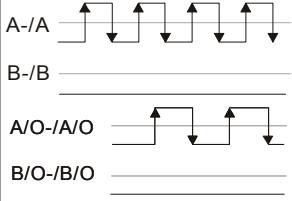
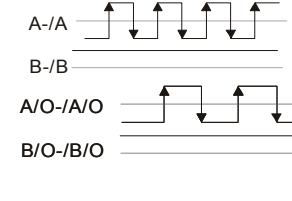
| RESERVE | I/MODE | O/MODE | RST | Division factor | |
|---------|--------|--------|-----|---|---|
| | | | | A leads B | B leads A |
| X | 0 | 0 | 1 |  |  |
| X | 0 | 1 | 1 |  |  |
| X | 1 | X | 1 |  |  |

 **NOTE**

- When the switch is ON, it means logic 0.
- A-/A and B-/B are the input signals of PG card. A/O-/A/O and B/O-/B/O are the line driver outputs of the frequency divider measured by the differential probe.
- PIN1 is reserved.
- PIN 5~12 are the denominator for the frequency divider. PIN 5 is the low bit (EX: the setting of XXXX10101010 is that the input signal divides by 85).

- When PIN 2 and PIN 3 are set to 0, the input signals (A-/A and B-/B) of PG card should be square wave and A/O-/A/O and B/O-/B/O are the outputs of frequency divider.
- When PIN 2 is set to 0 and PIN 3 is set to 1, the input signals (A-/A and B-/B) of PG card should be square wave and B/O-/B/O is the indication of phase A and B. (EX: LOW means A leads B and HIGH means B leads A). A/O-/A/O is the output of frequency divider.
- When PIN 2 is set to 1 and PIN 3 is set to X, B-/B should be the input signal of direction indication. (EX: when B-/B is LOW, it means that A leads B. When B-/B is HIGH, it means that B leads A. A-/A is a square wave input. B/O-/B/O and B-/B should be input synchronously. A/O-/A/O is the output of frequency divider.
- Z/O-/Z/O of the PG card will act by the input signal of Z-/Z and don't have the function of frequency divider.
- When changing the denominator of the frequency divider or input/output type, it needs to clear the counter value by clock reset bit (PIN4) before operation. Please set the switch to 1 after reset.

B.8.2 EMVL-PGABO

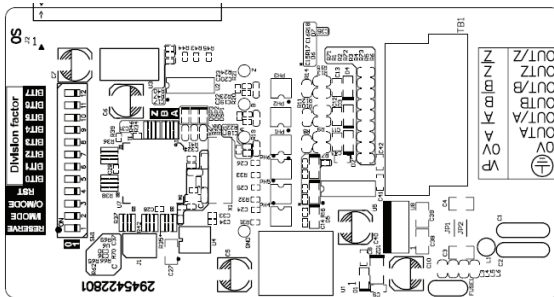

3. Terminals descriptions

| Terminal Symbols | | Descriptions | Specifications |
|------------------|--|---------------------------------|--|
| TB1 | VP | Power source of encoder | Voltage: +12V±1V Current: 200mA max. |
| | 0V | Power source common for encoder | Reference level of the power of encoder |
| | A, \bar{A} , B, \bar{B} , Z, \bar{Z} | Incremental line driver input | Open collector signal input. Max. bandwidth is 100kHz Please notice that \bar{A} , \bar{B} , \bar{Z} and 0V should be short circuit. |

| Terminal Symbols | | Descriptions | Specifications |
|------------------|--|--|---|
| TB1 | A/O, \bar{A} /O, B/O, \bar{B} /O, Z/O, \bar{Z} /O | Signal output for PG feedback card and can be used as a frequency divider. | Line driver RS422 Max. output frequency: 100 kHz |
| | \oplus | Grounding | Connected to the grounding of the power of the AC motor drive and used for PG shielding |

2. Wire length

| Output Type of the Encoder | Maximum Wire Length | Wire Gauge |
|----------------------------|---------------------|--------------------------------------|
| Open collector | 50m | 1.25mm ² (AWG16) or above |

3. Output Type of Encoder

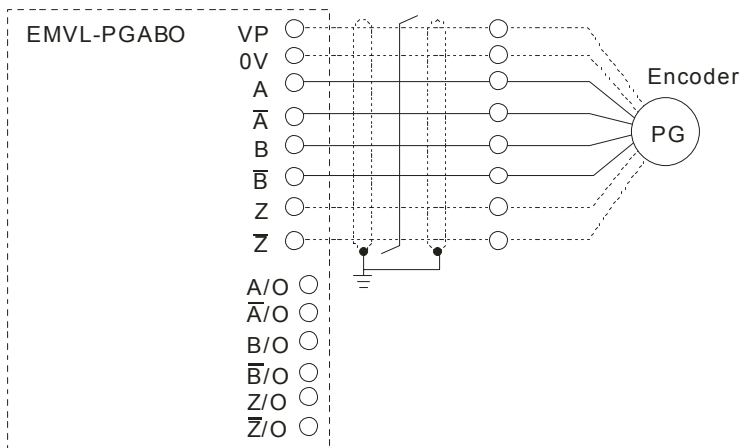
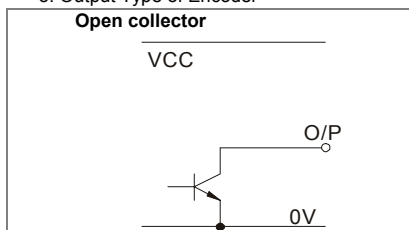

4. Output Signal Setting of the Frequency Divider

It generates the output signal of division factor "n" after dealing with the input pulse. Please set by the switch SW1 on the card.

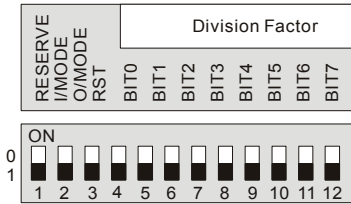

RESERVE: reserved bit (PIN1)

I/MODE: input type setting of the division pulse (PIN 2)

O/MODE: output type setting of the division pulse (PIN 3)

RST: clock reset bit (PIN 4)

Division factor: setting for division factor n: 1~256 (PIN5~12)

Settings and explanations

| RESERVE | I/MODE | O/MODE | RST | Division factor | |
|---------|--------|--------|-----|-----------------|-----------|
| | | | | A leads B | B leads A |
| X | 0 | 0 | 1 | | |
| X | 0 | 1 | 1 | | |
| X | 1 | X | 1 | | |

NOTE

- When the switch is ON, it means logic 0.
- A-/A and B-/B are the input signals of PG card. A/O-/A/O and B/O-/B/O are the line driver outputs of the frequency divider measured by the differential probe.
- PIN1 is reserved.
- PIN 5~12 are the denominator for the frequency divider. PIN 5 is the low bit (EX: the setting of XXXX10101010 is that the input signal divides by 85).
- When PIN 2 and PIN 3 are set to 0, the input signals (A-/A and B-/B) of PG card should be square wave and A/O-/A/O and B/O-/B/O are the outputs of frequency divider.
- When PIN 2 is set to 0 and PIN 3 is set to 1, the input signals (A-/A and B-/B) of PG card should be square wave and B/O-/B/O is the indication of phase A and B. (EX: LOW means A leads B and HIGH means B leads A). A/O-/A/O is the output of frequency divider.
- When PIN 2 is set to 1 and PIN 3 is set to X, B-/B should be the input signal of direction indication. (EX: when B-/B is LOW, it means that A leads B. When B-/B is HIGH, it means that B leads A. A-/A is a square wave input. B/O-/B/O and B-/B should be input synchronously. A/O-/A/O is the output of frequency divider.
- Z/O-/Z/O of the PG card will act by the input signal of Z-/Z and don't have the function of frequency divider.
- When changing the denominator of the frequency divider or input/output type, it needs to clear the counter value by clock reset bit (PIN4) before operation. Please set the switch to 1 after reset.

B.8.3 EMVL-PGH01 (only for Heidenhain ERN1387)

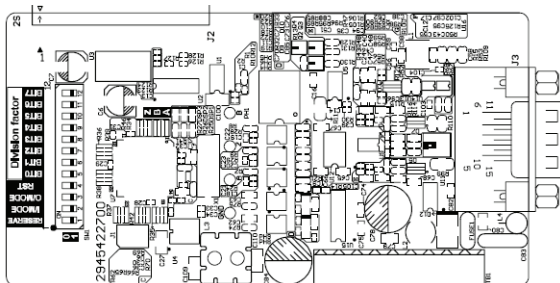

1. Sinusoidal Encoder Function

VFD-VL series

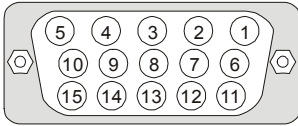

| Pin NO | Terminal Name | Pin NO | Terminal Name |
|--------|---------------|--------|---------------|
| 1 | B- | 9 | +5V |
| 2 | NC | 10 | SIN |
| 3 | Z+ | 11 | SIN' |
| 4 | Z- | 12 | COS |
| 5 | A+ | 13 | COS' |
| 6 | A- | 14 | NC |
| 7 | 0V | 15 | NC |
| 8 | B+ | | |

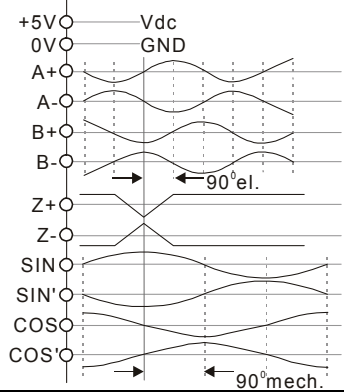

Heidenhain ERN1387

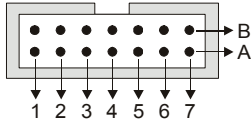

| Pin NO | Terminal Name | Pin NO | Terminal Name |
|--------|---------------|--------|---------------|
| 5a | B- | 1b | UP |
| NC | NC | 1a | C- |
| 4b | R+ | 7b | C+ |
| 4a | R- | 2b | D+ |
| 6a | A+ | 6a | D- |
| 2a | A- | - | - |
| 5b | 0V | - | - |
| 3b | B+ | | |

2. Terminals descriptions

| Terminal Symbols | Descriptions | Specifications | |
|------------------|------------------------|---|--|
| J3 | +5V | Specific power output of encoder | Voltage: +5V±0.5V Current: 200mA max. |
| | 0V | Power source common for encoder | Reference level of the power of encoder |
| | A+, A-, B+, B-, Z+, Z- | Sine line driver input (incremental signal) | |

| Terminal Symbols | | Descriptions | Specifications |
|------------------|--|--|---|
| S2 | SIN, SIN', COS, COS' | Sine line driver input signal (absolute signal) | |
| | A/O, \bar{A} /O, B/O, \bar{B} /O, Z/O, \bar{Z} /O | Signal output for PG feedback card and can be used as a frequency divider. | Line driver RS422 Max. output frequency: 100 kHz |

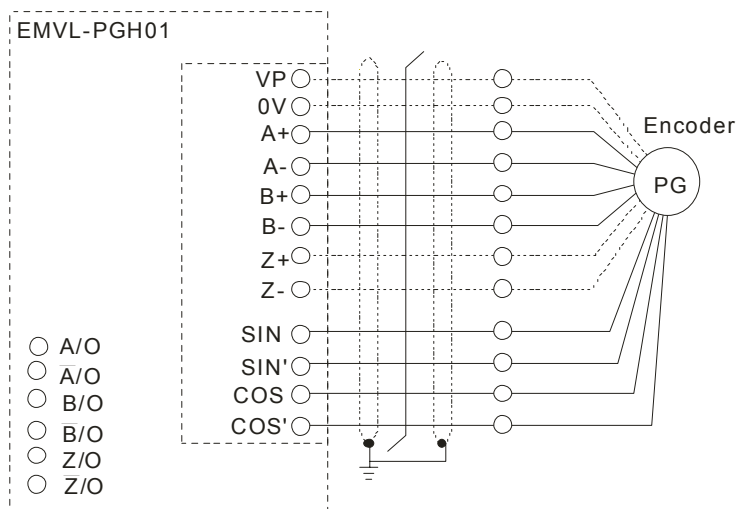

4. Output Signal Setting of the Frequency Divider

It generates the output signal of division factor "n" after dealing with the input pulse. Please set by the switch SW1 on the card.

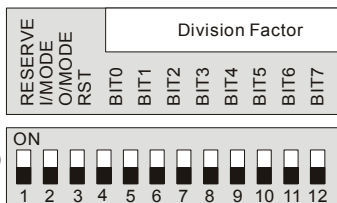

RESERVE: reserved bit (PIN1)

I/MODE: input type setting of the division pulse (PIN 2)

O/MODE: output type setting of the division pulse (PIN 3)

RST: clock reset bit (PIN 4)

Division factor: setting for division factor n:
1~256 (PIN5~12)

Settings and explanations

| RESERVE | I/MODE | O/MODE | RST | Division factor | |
|---------|--------|--------|-----|------------------------------------|-----------|
| | | | | A leads B | B leads A |
| X | 0 | 0 | 1 | | |
| X | 0 | 1 | 1 | | |
| X | 1 | X | 1 | This setting is NOT for EMVL-PGH01 | |

**NOTE**

- When the switch is ON, it means logic 0.
- A-/A and B-/B are the input signals of PG card. A/O-/A/O and B/O-/B/O are the line drivers of the frequency divider measured by the differential probe.
- PIN1 is reserved.
- PIN 5~12 are the denominator for the frequency divider. PIN 5 is the low bit (EX: the setting of XXXX10101010 is that the input signal divides by 85).
- When PIN 2 and PIN 3 are set to 0, the input signals (A-/A and B-/B) of PG card should be square wave and A/O-/A/O and B/O-/B/O are the outputs of frequency divider.
- When PIN 2 is set to 0 and PIN 3 is set to 1, the input signals (A-/A and B-/B) of PG card should be square wave and B/O-/B/O is the indication of phase A and B. (EX: LOW means A leads B and HIGH means B leads A). A/O-/A/O is the output of frequency divider.
- When PIN 2 is set to 1 and PIN 3 is set to X, B-/B should be the input signal of direction indication. (EX: when B-/B is LOW, it means that A leads B. When B-/B is HIGH, it means

that B leads A. A-/A is a square wave input. B/O-/B/O and B-/B should be input synchronously. A/O-/A/O is the output of frequency divider.

- Z/O-/Z/O of the PG card will act by the input signal of Z-/Z and don't have the function of frequency divider.
- When changing the denominator of the frequency divider or input/output type, it needs to clear the counter value by clock reset bit (PIN4) before operation. Please set the switch to 1 after reset.

B.8.4 EMVL-PGS01

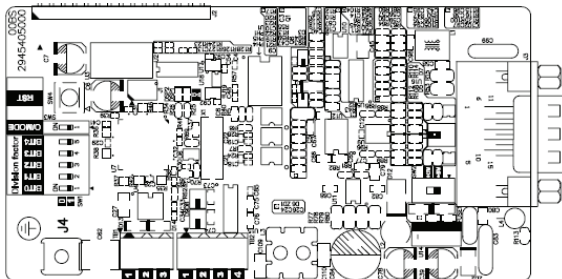

Applicable encoders for EMVL-PGS01:

- *EnDat2.1*: EQN425, EQN1325, ECN113, ECN413, ECN1113, ECN1313
- *HIPERFACE*: SRS50/60

1. Pin description

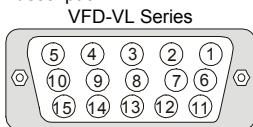

| VFD-VL Series Pin No. | Corresponding terminal | |
|--------------------------|------------------------|------------|
| | EnDat | HIPERFACE® |
| 1 | B- | REFSIN |
| 2 | 0V | 0V |
| 3 | 0V | 0V |
| 4 | 0V | 0V |
| 5 | A+ | +COS |
| 6 | A- | REFCOS |
| 7 | 0V | 0V |
| 8 | B+ | +SIN |
| 9 | VP | VP |
| 10 | Data+ | Data+ |
| 11 | Data- | Data- |
| 12 | CLOCK+ | - |
| 13 | CLOCK- | - |
| 14 | VP | VP |
| 15 | 0V | 0V |

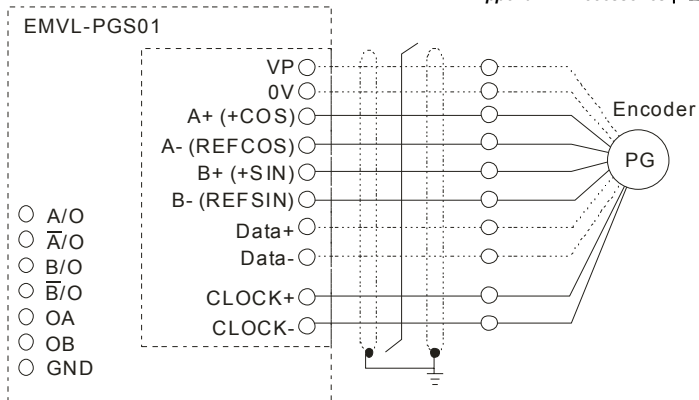

2. Terminals descriptions

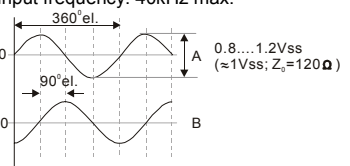
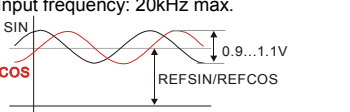
| Terminal Symbols | Descriptions | Specifications | |
|------------------|---|--|---|
| J3 | VP | Power source of encoder (use SW2 to switch 12V/5V) | Voltage: +5VDC±5% or +8.3 VDC±6% Current: 250mA max. |
| | 0V | Power source common for encoder | Reference level of the power of encoder |
| | A+, A-, B+, B- | Sine line drive input (incremental signal) | Input frequency: 40kHz max.  |
| | +SIN, +COS REFSIN, REFCOS | Sine line drive input (incremental signal) | Input frequency: 20kHz max.  |
| | CLOCK+, CLOCK- | CLOCK line drive output | Line Driver RS422 Level output |
| | Data+, Data- | | RS485 communication interface Terminal resistor: about 130 Ω |
| TB1 | A/O, \bar{A} /O, B/O, \bar{B} /O | Signal output for PG feedback card and can be used as a frequency divider. | Line Driver RS422 Level output |
| TB2 | OA OB | Open collector output signal and can be used as a frequency divider | <ul style="list-style-type: none"> Transistor open collector output Max. 24VDC, 30mA $VOL \leq 1.5V(IOL=30mA)$ $IOH \leq 200\mu A(VOH=24VDC)$ |
| | GND | Open collector output common | Reference level of NPN transistor open collector output |

| Terminal Symbols | | Descriptions | Specifications |
|------------------|---|--------------|---|
| J4 |  | Grounding | Connected to the grounding of the power of the AC motor drive and used for PG shielding |

4. Output Signal Setting of the Frequency Divider

It generates the output signal of division factor "n" after dealing with the input pulse. Please set by the switch SW1 on the card.

O/MODE: output type setting of the division pulse

RST: clock reset bit

Division factor: setting for division factor n:
1~31

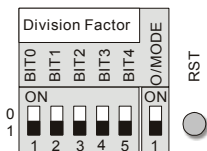

Settings and explanations

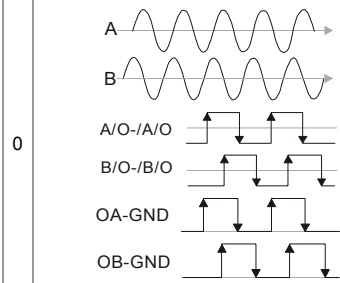
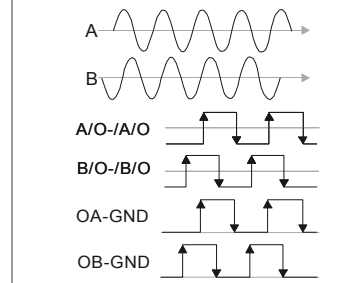
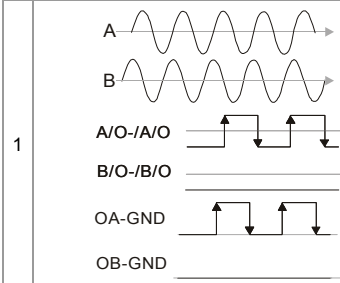
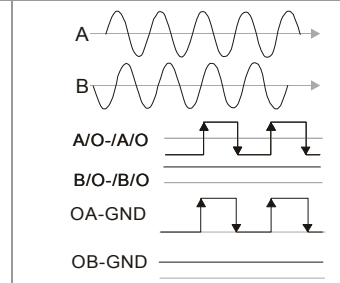
| O/MODE | Division factor | |
|--------|---|---|
| | A leads B | B leads A |
| 0 |  |  |
| 1 |  |  |

**NOTE**

- When the switch is ON, it means logic 0.
- A-/A and B-/B are the input signals of PG card. A/O-/A/O and B/O-/B/O are the line driver outputs of the frequency divider measured by the differential probe.
- Bit 0-4 are the denominators for the frequency divider. Bit 0 is the low bit (EX: the setting of 10110 is that the input signal divides by 13).
- When the output pulse type of frequency divider is set to 0, A/O-/A/O, B/O-/B/O, OA-GND and OB-GND are the outputs of frequency divider.
- When the output pulse type of frequency divider is set to 1, B/O-/B/O and OB-GND are the indication of phase A and B. (EX: LOW means A leads B and HIGH means B leads A). A/O-/A/O and OA-GND are the output of frequency dividers.
- When changing the denominator of the frequency divider or output type, it needs to clear the counter value by clock reset bit before operation.

B.9 AMD-EMI Filter Cross Reference

| AC Drives | Model Number | FootPrint |
|--|--------------|-----------|
| VFD055VL43A, VFD075VL43A, VFD110VL43A, | RF110B43CA | Y |
| VFD055VL23A, VFD075VL23A, VFD150V43A, VFD185VL43A | 50TDS4W4C | N |
| VFD110VL23A, VFD150VL23A, VFD220VL43A, VFD300VL43A, VFD370VL43A | 100TDS84C | N |
| VFD550VL43A, VFD750VL43A | 200TDDS84C | N |
| VFD185VL23A, VFD220VL23A, VFD300VL23A, VFD450VL43A, | 150TDS84C | N |
| VFD370VL23A, | 180TDS84C | N |

Installation

All electrical equipment, including AC motor drives, will generate high-frequency/low-frequency noise and will interfere with peripheral equipment by radiation or conduction when in operation. By using an EMI filter with correct installation, much interference can be eliminated. It is recommended to use DELTA EMI filter to have the best interference elimination performance.

We assure that it can comply with following rules when AC motor drive and EMI filter are installed and wired according to user manual:

- **EN61000-6-4**
- **EN61800-3: 1996**
- **EN55011 (1991) Class A Group 1**

General precaution

1. EMI filter and AC motor drive should be installed on the same metal plate.
2. Please install AC motor drive on footprint EMI filter or install EMI filter as close as possible to the AC motor drive.
3. Please wire as short as possible.
4. Metal plate should be grounded.
5. The cover of EMI filter and AC motor drive or grounding should be fixed on the metal plate and the contact area should be as large as possible.

Choose suitable motor cable and precautions

Improper installation and choice of motor cable will affect the performance of EMI filter. Be sure to observe the following precautions when selecting motor cable.

1. Use the cable with shielding (double shielding is the best).
2. The shielding on both ends of the motor cable should be grounded with the minimum length and maximum contact area.
3. Remove any paint on metal saddle for good ground contact with the plate and shielding.

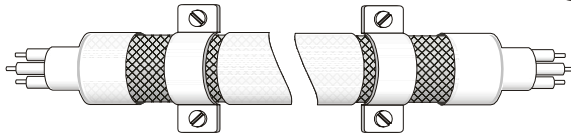
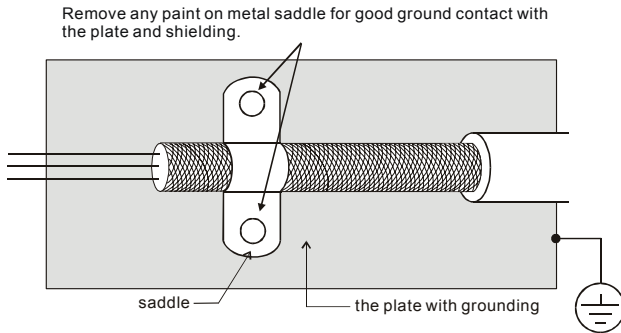

Saddle on both ends

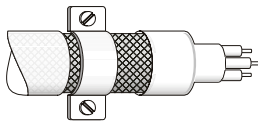

Saddle on one end

The length of motor cable

When motor is driven by an AC motor drive of PWM type, the motor terminals will experience surge voltages easily due to components conversion of AC motor drive and cable capacitance. When the motor cable is very long (especially for the 460V series), surge voltages may reduce insulation quality. To prevent this situation, please follow the rules below:

- Use a motor with enhanced insulation.
- Connect an output reactor (optional) to the output terminals of the AC motor drive
- The length of the cable between AC motor drive and motor should be as short as possible (10 to 20 m or less)
- For models 7.5hp/5.5kW and above:

| Insulation level of motor | 1000V | 1300V | 1600V |
|---------------------------|----------------|----------------|----------------|
| 460VAC input voltage | 66 ft (20m) | 328 ft (100m) | 1312 ft (400m) |
| 230VAC input voltage | 1312 ft (400m) | 1312 ft (400m) | 1312 ft (400m) |

 **NOTE**

When a thermal O/L relay protected by motor is used between AC motor drive and motor, it may malfunction (especially for 460V series), even if the length of motor cable is only 165 ft (50m) or less. To prevent it, please use AC reactor and/or lower the carrier frequency (Pr. 00-17 PWM carrier frequency).

 **NOTE**

Never connect phase lead capacitors or surge absorbers to the output terminals of the AC motor drive.

- If the length is too long, the stray capacitance between cables will increase and may cause leakage current. It will activate the protection of over current, increase leakage current or not insure the correction of current display. The worst case is that AC motor drive may damage.
- If more than one motor is connected to the AC motor drive, the total wiring length is the sum of the wiring length from AC motor drive to each motor.

B.9.1 Dimensions

Dimensions are in millimeter and (inch)

Order P/N: RF110B43CA

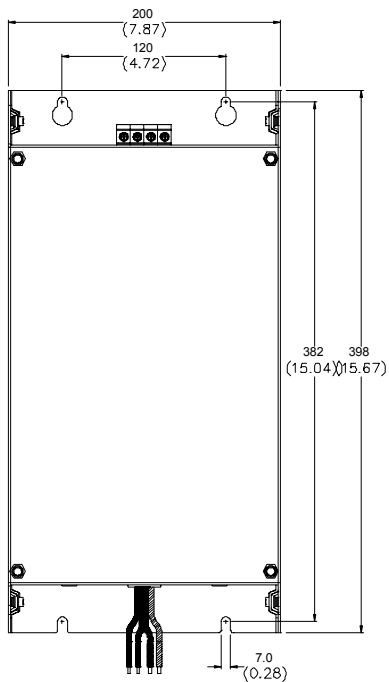
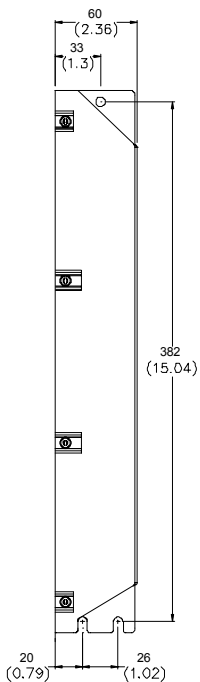
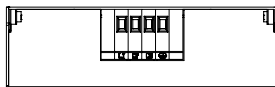

Order P/N: 50TDS4W4C

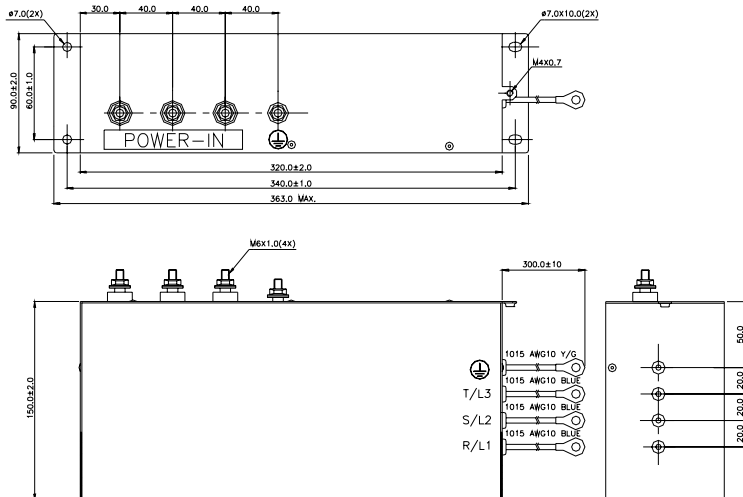

Order P/N: 100TDS84C

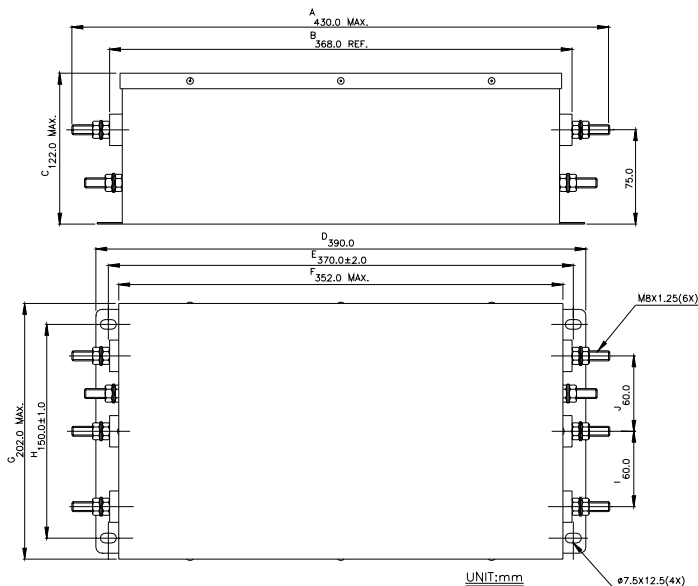

Order P/N: 200TDDS84C

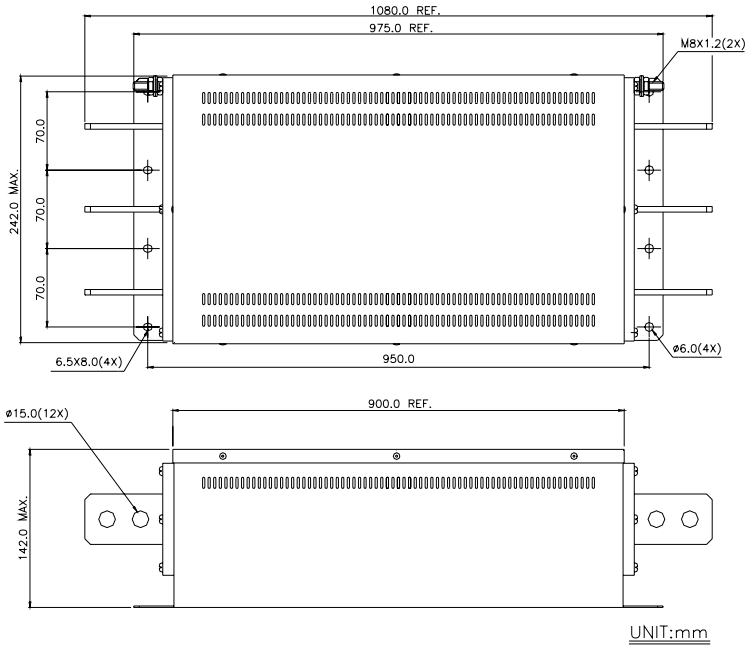

Order P/N: 150TDS84C

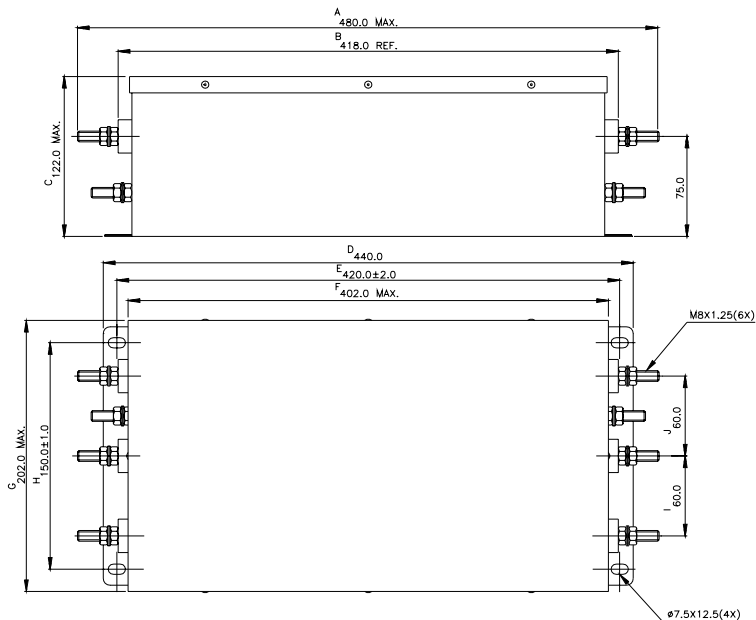

Order P/N: 180TDS84C

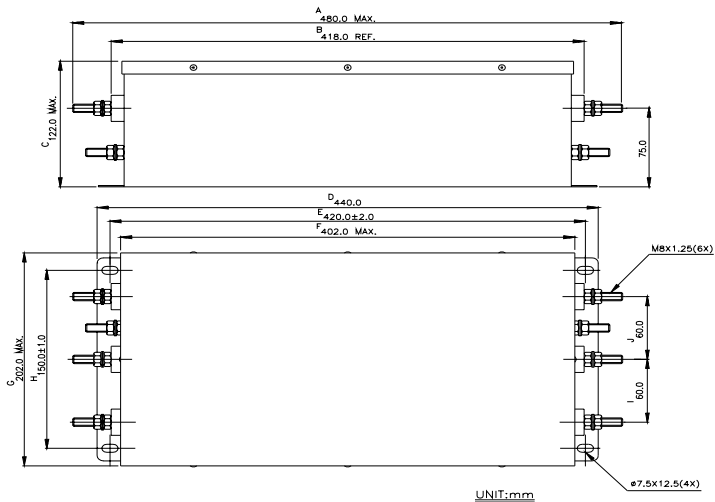

UNIT:mm

B.10 EMVL-IOA01

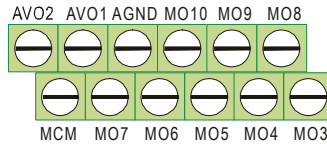
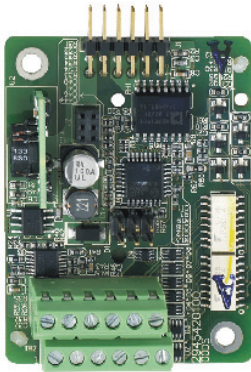

| Terminals | Descriptions |
|--|--|
| AVO1-AGND AVO2-AGND | Multifunction analog voltage output terminal -10.0V~10.0V The analog output is defined by Pr.03-17 and Pr.03-20. |
| MO3~MO10 Multifunction output terminals (photocoupler) | The AC motor drive outputs every monitor signal, such as operation indication, frequency attained and overload indication by the transistor (open collector). Refer to Pr.02-15~02-22 multifunction output terminals for details. Max: +24V/5mA |

B.11 Safety Relay EMVL-SAF01

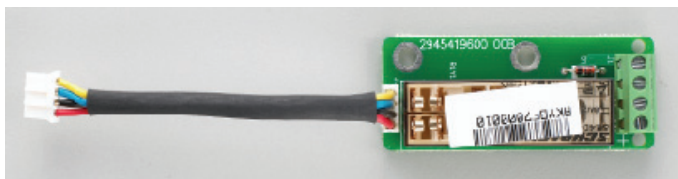

B.11.1 Functions of the Terminals

| Terminals | Descriptions | Specifications | |
|-----------|--------------|--------------------------------------|---|
| J1 | S1 | +24VDC power Input | <ul style="list-style-type: none"> • Min. activation voltage: +19Vdc • Impedance: 720+10%Ω • Rated power: about 800mW |
| | S2 | +24VDC, reference level of the power | |
| J1 | S3 | A dry contact of a relay | <ul style="list-style-type: none"> • Rated current: 8 A • Rated voltage/max. switch voltage: 240/400 VAC • Contact material: AgSnO2 • Contact impedance: <ul style="list-style-type: none"> ≤ 100 mOhm / 1 A / 24 VDC ≤ 20 Ohm / 10 mA / 5 VDC • Mechanical endurance: 10x10⁶ cycles • Rated operation frequency: 6 min⁻¹ / 150 min⁻¹ (loaded/unloaded) |
| | S4 | A dry contact of a relay | |

B.11.2 Wiring of the Safety Relay

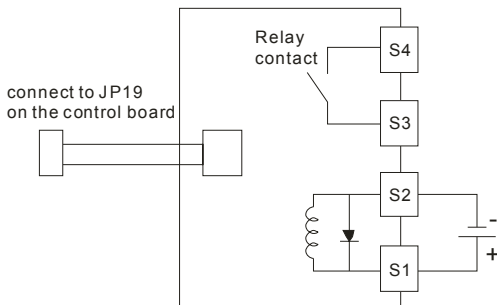

Descriptions

1. When the power +24VDC is applied to S1 and S2 (S1 is +), the relay contacts of S3 and S4 are ON. When the power +24VDC isn't applied to S1 and S2, the relay contacts of S3 and S4 are OFF. At the meanwhile, EMVL-ASF01 can stop the output of the AC motor drive by connecting to JP19 on the control board. It can also be used with MI8 to achieve two safety-loop protections via hardware.
2. Multifunction input MI8
 - (1) Please remove JP1 from the control board before using safety-loop function. At the meanwhile, the multifunction input MI8 can control the output of the AC motor drive.
 - (2) operation method:
MI8 is ON: the AC motor drive can output
MI8 is OFF: the AC motor drive can't output
NOTE: Please insert JP1 into the control board when this function is disabled.
3. Safety-Relay EMVL-SAF01
 - (1) Please connect the power of J3 to JP19 on the control board and remove JP18 on the control board.
 - (2) Operation method:
When the power is applied to S1-S2: It is ON and the AC motor drive can output
When the power isn't applied to S1-S2: it is OFF and the AC motor drive can't output
 - (3) S3-S4 are the monitor contacts and user can check the safety-loop by this contact.



NOTE

- Please notice that when J3 of relay board is connected to JP19 of control board, JP18 must be removed when using EMVL-SAF01.
- Please supply the power +24VDC to S1 and S2 before the AC motor drive is powered on to drive relay.

This page intentionally left blank

Appendix C How to Select the Right AC Motor Drive

The choice of the right AC motor drive for the application is very important and has great influence on its lifetime. If the capacity of AC motor drive is too large, it cannot offer complete protection to the motor and motor maybe damaged. If the capacity of AC motor drive is too small, it cannot offer the required performance and the AC motor drive maybe damaged due to overloading.

But by simply selecting the AC motor drive of the same capacity as the motor, user application requirements cannot be met completely. Therefore, a designer should consider all the conditions, including load type, load speed, load characteristic, operation method, rated output, rated speed, power and the change of load capacity. The following table lists the factors you need to consider, depending on your requirements.

| Item | | Related Specification | | | |
|---|-------------------------------|----------------------------------|--------------|-------------------|-----------------|
| | | Speed and torque characteristics | Time ratings | Overload capacity | Starting torque |
| Load type | Friction load and weight load | | | | |
| | Liquid (viscous) load | ● | | | ● |
| | Inertia load | | | | |
| | Load with power transmission | | | | |
| Load speed and torque characteristics | Constant torque | ● | ● | | |
| | Constant output | | | | |
| | Decreasing torque | | | | |
| | Decreasing output | | | | |
| Load characteristics | Constant load | ● | ● | ● | ● |
| | Shock load | | | | |
| | Repetitive load | ● | ● | ● | ● |
| | High starting torque | | | | |
| | Low starting torque | | | | |
| Continuous operation, Short-time operation | | | ● | ● | |
| Long-time operation at medium/low speeds | | | | | |
| Maximum output current (instantaneous) | | ● | | ● | |
| Constant output current (continuous) | | | | | |
| Maximum frequency, Base frequency | | ● | | | |
| Power supply transformer capacity or percentage impedance | | | | | |
| Voltage fluctuations and unbalance | | | | ● | ● |
| Number of phases, single phase protection | | | | | |
| Frequency | | | | | |
| Mechanical friction, losses in wiring | | | | ● | ● |
| Duty cycle modification | | | ● | | |

C.1 Capacity Formulas

1. When one AC motor drive operates one motor

The starting capacity should be less than 1.5x rated capacity of AC motor drive

The starting capacity=

$$\frac{k \times N}{973 \times \eta \times \cos \varphi} \left(T_L + \frac{GD^2}{375} \times \frac{N}{t_A} \right) \leq 1.5 \times \text{the_capacity_of_AC_motor_drive}(kVA)$$

2. When one AC motor drive operates more than one motor

2.1 The starting capacity should be less than the rated capacity of AC motor drive

- Acceleration time ≤ 60 seconds

The starting capacity=

$$\frac{k \times N}{\eta \times \cos \varphi} [n_r + n_s(k_s - 1)] = P_{Cl} \left[1 + \frac{n_s}{n_r} (k_s - 1) \right] \leq 1.5 \times \text{the_capacity_of_AC_motor_drive}(kVA)$$

- Acceleration time ≥ 60 seconds

The starting capacity=

$$\frac{k \times N}{\eta \times \cos \varphi} [n_r + n_s(k_s - 1)] = P_{Cl} \left[1 + \frac{n_s}{n_r} (k_s - 1) \right] \leq \text{the_capacity_of_AC_motor_drive}(kVA)$$

2.2 The current should be less than the rated current of AC motor drive(A)

- Acceleration time ≤ 60 seconds

$$n_r + I_M \left[1 + \frac{n_s}{n_r} (k_s - 1) \right] \leq 1.5 \times \text{the_rated_current_of_AC_motor_drive}(A)$$

- Acceleration time ≥ 60 seconds

$$n_r + I_M \left[1 + \frac{n_s}{n_r} (k_s - 1) \right] \leq \text{the_rated_current_of_AC_motor_drive}(A)$$

2.3 When it is running continuously

- The requirement of load capacity should be less than the capacity of AC motor drive(kVA)
The requirement of load capacity=

$$\frac{k \times P_M}{\eta \times \cos \varphi} \leq \text{the_capacity_of_AC_motor_drive}(kVA)$$

- The motor capacity should be less than the capacity of AC motor drive

$$k \times \sqrt{3} \times V_M \times I_M \times 10^{-3} \leq \text{the_capacity_of_AC_motor_drive}(kVA)$$

- The current should be less than the rated current of AC motor drive(A)

$$k \times I_M \leq \text{the_rated_current_of_AC_motor_drive}(A)$$

Symbol explanation

| | |
|----------------|---|
| P_M | : Motor shaft output for load (kW) |
| η | : Motor efficiency (normally, approx. 0.85) |
| $\cos \varphi$ | : Motor power factor (normally, approx. 0.75) |
| V_M | : Motor rated voltage(V) |
| I_M | : Motor rated current(A), for commercial power |
| k | : Correction factor calculated from current distortion factor (1.05-1.1, depending on PWM method) |
| P_{C1} | : Continuous motor capacity (kVA) |
| k_S | : Starting current/rated current of motor |
| n_T | : Number of motors in parallel |
| n_S | : Number of simultaneously started motors |
| GD^2 | : Total inertia (GD^2) calculated back to motor shaft (kg m^2) |
| T_L | : Load torque |
| t_A | : Motor acceleration time |
| N | : Motor speed |

C.2 General Precaution

Selection Note

1. When the AC Motor Drive is connected directly to a large-capacity power transformer (600kVA or above) or when a phase lead capacitor is switched, excess peak currents may occur in the power input circuit and the converter section may be damaged. To avoid this, use an AC input reactor (optional) before AC Motor Drive mains input to reduce the current and improve the input power efficiency.
2. When a special motor is used or more than one motor is driven in parallel with a single AC Motor Drive, select the AC Motor Drive current $\geq 1.25 \times$ (Sum of the motor rated currents).
3. The starting and accel./decel. characteristics of a motor are limited by the rated current and the overload protection of the AC Motor Drive. Compared to running the motor D.O.L. (Direct On-Line), a lower starting torque output with AC Motor Drive can be expected. If higher starting torque is required (such as for elevators, mixers, tooling machines, etc.) use an AC Motor Drive of higher capacity or increase the capacities for both the motor and the AC Motor Drive.
4. When an error occurs on the drive, a protective circuit will be activated and the AC Motor Drive output is turned off. Then the motor will coast to stop. For an emergency stop, an external mechanical brake is needed to quickly stop the motor.

Parameter Settings Note

1. The AC Motor Drive can be driven at an output frequency up to 400Hz (less for some models) with the digital keypad. Setting errors may create a dangerous situation. For safety, the use of the upper limit frequency function is strongly recommended.
2. High DC brake operating voltages and long operation time (at low frequencies) may cause overheating of the motor. In that case, forced external motor cooling is recommended.
3. Motor accel./decel. time is determined by motor rated torque, load torque, and load inertia.
4. If the stall prevention function is activated, the accel./decel. time is automatically extended to a length that the AC Motor Drive can handle. If the motor needs to decelerate within a certain time with high load inertia that can't be handled by the AC Motor Drive in the required time, either use an external brake resistor and/or brake unit, depending on the

model, (to shorten deceleration time only) or increase the capacity for both the motor and the AC Motor Drive.

C.3 How to Choose a Suitable Motor

Standard motor

When using the AC Motor Drive to operate a standard 3-phase induction motor, take the following precautions:

1. The energy loss is greater than for an inverter duty motor.
2. Avoid running motor at low speed for a long time. Under this condition, the motor temperature may rise above the motor rating due to limited airflow produced by the motor's fan. Consider external forced motor cooling.
3. When the standard motor operates at low speed for long time, the output load must be decreased.
4. The load tolerance of a standard motor is as follows:

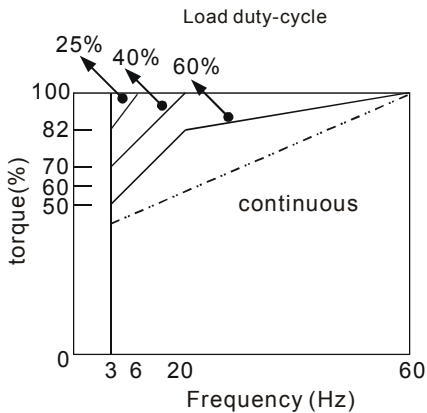

5. If 100% continuous torque is required at low speed, it may be necessary to use a special inverter duty motor.
6. Motor dynamic balance and rotor endurance should be considered once the operating speed exceeds the rated speed (60Hz) of a standard motor.
7. Motor torque characteristics vary when an AC Motor Drive instead of commercial power supply drives the motor. Check the load torque characteristics of the machine to be connected.

8. Because of the high carrier frequency PWM control of the VFD series, pay attention to the following motor vibration problems:
 - Resonant mechanical vibration: anti-vibration (damping) rubbers should be used to mount equipment that runs at varying speed.
 - Motor imbalance: special care is required for operation at 50 or 60 Hz and higher frequency.
 - To avoid resonances, use the Skip frequencies.
9. The motor fan will be very noisy when the motor speed exceeds 50 or 60Hz.

Special motors:

1. Pole-changing (Dahlander) motor:

The rated current is differs from that of a standard motor. Please check before operation and select the capacity of the AC motor drive carefully. When changing the pole number the motor needs to be stopped first. If over current occurs during operation or regenerative voltage is too high, please let the motor free run to stop (coast).
2. Submersible motor:

The rated current is higher than that of a standard motor. Please check before operation and choose the capacity of the AC motor drive carefully. With long motor cable between AC motor drive and motor, available motor torque is reduced.
3. Explosion-proof (Ex) motor:

Needs to be installed in a safe place and the wiring should comply with the (Ex) requirements. Delta AC Motor Drives are not suitable for (Ex) areas with special precautions.
4. Gear reduction motor:

The lubricating method of reduction gearbox and speed range for continuous operation will be different and depending on brand. The lubricating function for operating long time at low speed and for high-speed operation needs to be considered carefully.
5. Synchronous motor:

The rated current and starting current are higher than for standard motors. Please check before operation and choose the capacity of the AC motor drive carefully. When the AC motor drive operates more than one motor, please pay attention to starting and changing the motor.

Power Transmission Mechanism

Pay attention to reduced lubrication when operating gear reduction motors, gearboxes, belts and chains, etc. over longer periods at low speeds. At high speeds of 50/60Hz and above, lifetime reducing noises and vibrations may occur.

Motor torque

The torque characteristics of a motor operated by an AC motor drive and commercial mains power are different.

Below you'll find the torque-speed characteristics of a standard motor (4-pole, 15kW):

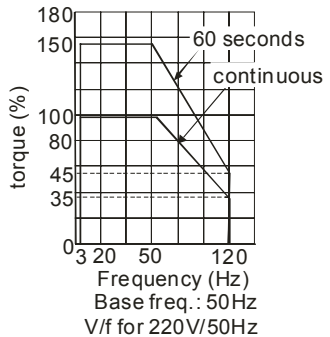
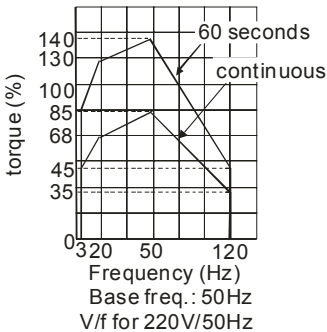
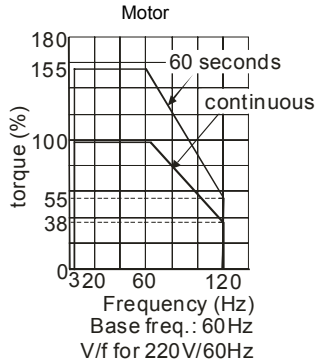
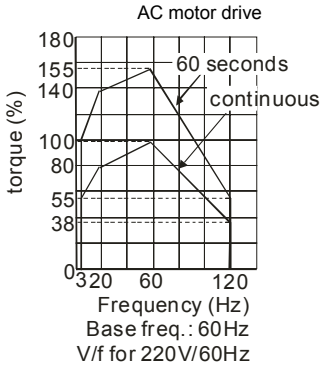

This page intentionally left blank.

Free Manuals Download Website

<http://myh66.com>

<http://usermanuals.us>

<http://www.somanuals.com>

<http://www.4manuals.cc>

<http://www.manual-lib.com>

<http://www.404manual.com>

<http://www.luxmanual.com>

<http://aubethermostatmanual.com>

Golf course search by state

<http://golfingnear.com>

Email search by domain

<http://emailbydomain.com>

Auto manuals search

<http://auto.somanuals.com>

TV manuals search

<http://tv.somanuals.com>