

Dell™ Photo Printer 540

Owner's Manual

Look Inside For:

- Ordering Photo Print Packs
- Getting Started
- Using Your Printer
- Printing With a Computer
- Care and Maintenance
- Troubleshooting

Ordering Photo Print Packs

You can order Dell™ Photo Print Packs, which contain the photo cartridge and photo paper for your printer, and other supplies online at www.dell.com/supplies or by phone.

USA	877-465-2968 (877-Ink2You)
Austria	08 20 - 24 05 30 35
Belgium	02.713 1590
Canada	877-501-4803
Caribbean Islands	Please contact your local distributor.
Columbia	800-9-155676
Denmark	3287 5215
Finland	09 2533 1411
France	0825387247
Germany	0800 2873355
Ireland	1850 707 407
Italy	800602705
Luxembourg	02.713 1590
Mexico	001-866-851-1754
Netherlands	020 - 674 4881
Norway	231622 64
Paraguay	Please contact your local distributor.
Peru	Please contact your local distributor.
Portugal	Please contact your local distributor.
Puerto Rico	866-851-1760
Spain	902120385
Sweden	08 587 705 81
UK	0870 907 4574
Uruguay	Please contact your local distributor.
Venezuela	Please contact your local distributor.

Your printer has been designed to print using:

Item:	Part number:
Dell Photo Print Pack	0D6605

Notes, Notices, and Cautions



NOTE: A NOTE indicates important information that helps you make better use of your printer.



NOTICE: A NOTICE indicates either potential damage to hardware or loss of data and tells you how to avoid the problem.



CAUTION: A CAUTION indicates a potential for property damage, personal injury, or death.

Information in this document is subject to change without notice.

© 2004 Dell Inc. All rights reserved.

Reproduction in any manner whatsoever without the written permission of Dell Inc. is strictly forbidden.

Trademarks used in this text: *Dell* and the *DELL* logo are trademarks of Dell Inc.; *Microsoft* and *Windows* are registered trademarks of Microsoft Corporation.

Other trademarks and trade names may be used in this document to refer to either the entities claiming the marks and names or their products. Dell Inc. disclaims any proprietary interest in trademarks and trade names other than its own.

Model 540

October 2004 P/N 4J1412 Rev. A01

Contents

Ordering Photo Print Packs	2
Notes, Notices, and Cautions	3
CAUTION: SAFETY INSTRUCTIONS	9
1 Getting Started	
 Accessing Your <i>User's Guide</i>	11
 Understanding the Printer Parts	11
 Setting Up Your Printer	14
 Loading the Photo Cartridge	14
 Loading the Photo Paper	15
 Changing Settings—Press Menu	17
Select Menu Items	17
Print Options Menu	17
Photo Quality Menu	17
Photo Display Menu	18
Photo Management Menu	19
Printer Settings Menu	19
Maintenance Menu	20
2 Using Your Printer	
 Printing Without a Computer	21
Printing Tips	21
Printing From a Memory Card	21
Selecting Photos to Print	22
Printing From Your Pictbridge-enabled or Other Compatible Camera	24
Canceling Printing	24
Removing Perforated Tabs From Prints	24
 Printing With a Computer	25
Printing Tips	25

Windows-Based Operating System Requirements	25
Printing From a Computer	26
Choosing a Color Mode	27
Canceling printing.	27
Saving and Copying Photos to Your Computer.	28
3 Care and Maintenance	
General Care of the Printer	29
Cleaning the Paper Feed Roller	30
Handling and Storing the Photo Paper and Photo Cartridge	30
4 Troubleshooting	
Setup Problems	31
General Problems	32
Error Messages	32
Printing Problems	33
.	36
More Troubleshooting Options	37
5 Contacting Dell	
Technical Assistance	39
Automated Order-Status Service	39
Contacting Dell	39

6 Appendix

U.S. Terms and Conditions of Sale	57
Limited Warranties and Return Policy	60
Limited Warranty for Dell-Branded Hardware Products (U.S. Only)	60
Total Satisfaction Return Policy (U.S. Only)	63
Limited Warranty Terms for Dell-Branded Hardware Products (Canada Only)	64
Total Satisfaction Return Policy (Canada Only)	67
Dell Software and Peripherals (Canada Only)	67
1-Year End-User Manufacturer Guarantee (Latin America and the Caribbean Only)	68
68	
Dell™ Photo Print Pack Limited Warranties	69
Dell™ Photo Print Pack Limited Warranty (U.S. and Canada Only)	69
Dell™ Photo Print Pack Limited Warranty (Latin America Only)	69
Regulatory Notices	70
NOM Information (Mexico Only)	71
Dell™ Software License Agreement	71
Limited Warranty	72
U.S. Government Restricted Rights	72
General	72
Printer Specifications	73

CAUTION: SAFETY INSTRUCTIONS

Use the following safety guidelines to help ensure your own personal safety and to help protect your Dell™ Photo Printer 540 and working environment from potential damage.

 **CAUTION:** Do not set up this product or make any electrical or cabling connections, such as the power supply cord, during a lightning storm.

 **CAUTION:** Do not expose this product to liquid, moisture, or extreme temperatures. Power supplies and battery chargers are intended for indoor use only. The use of controls, adjustments, or procedures other than those specified herein may result in exposure to shock and/or electrical or mechanical hazards.

 **NOTICE:** Do not disassemble this product; there are no user-serviceable parts inside. Refer servicing to qualified service personnel.

- Use only the power supply provided with this product or the manufacturer's authorized replacement power supply.
- Connect the power cable to an electrical outlet that is near the product and easily accessible.
- Refer service or repairs, other than those described in the user documentation, to a professional service person.
- Read and follow these instructions before using Dell products. Always follow basic safety procedures.
- The use of an accessory attachment that is not recommended by Dell, such as an AC adapter, may cause fire, electric shock, or injury.
- Do not allow chemicals, such as suntan lotion, to come into contact with the painted surface of the printer.
- If the printer has been subjected to inclement weather or you suspect water has gotten inside the printer, turn off the printer and remove the paper tray and photo cartridge. Allow all components to air-dry for at least 24 hours before using the printer again. If this does not resolve the problem, contact customer support (see page 39).
- The printer and the power supply contain a small amount of lead in the circuit board. Disposal of this material may be regulated due to environmental considerations.
- Disposal of the photo cartridge is not regulated and should not be subject to state or local landfill, incineration, or recycling requirements.
- For more disposal or recycling information, contact your local authorities. In the US, visit the Electronics Industry Alliance Web site at www.eaie.org.



Getting Started

Accessing Your *User's Guide*

Click Start → All Program(s) → Dell Printers → Dell Photo Printer 540 → View Dell User's Guide.

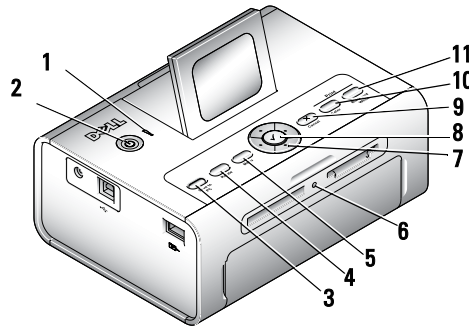

Understanding the Printer Parts

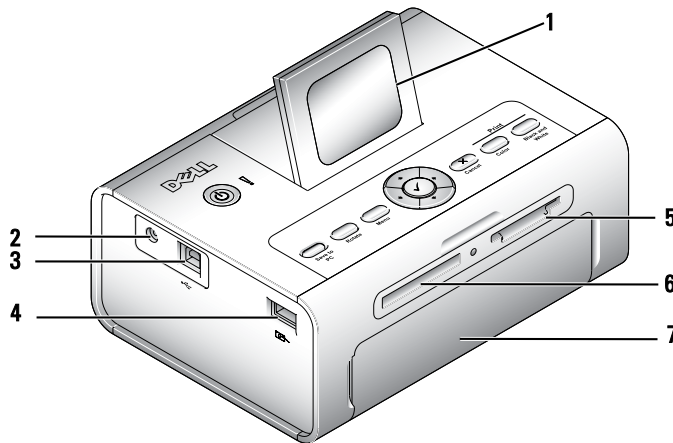

	Lights and Buttons	Description
1	Error indicator light !	Glows amber when an error condition exists.
2	Power button 	Turn your printer on or off; button is lit when power is on.
3	Save to PC	Establishes a connection with your computer that allows you to save photos from your memory card, USB storage device, or camera directly to the computer.
4	Rotate	Rotates a photo 90 degrees each time button is pressed. (For display purposes only. Does not change orientation of a printed photo.)
5	Menu	Change settings and customize printing options. (See page 17.)
6	Memory card light	Light blinks while checking card, then glows steady green.
7	Navigation (Arrow) buttons 	Navigate through photos and menus.

	Lights and Buttons	Description
8	Select ✓	Choose the photo or option that appears on the Liquid Crystal Display (LCD).
9	Cancel ✕	Cancel the current print job or back out of the menus.
10	Print Color	Print color copy of the selected photo(s).
11	Print Black & White	Print black and white copy of the selected photo(s).



	Part	Description
1	LCD	Display photos, printer status, messages, menu options, or settings.
2	Power connector	Supply power to the printer.
3	USB connector to PC 	Connect your printer to a computer.
4	Camera or USB storage device connector 	Connect a PictBridge-enabled or other compatible camera or USB storage device.
5	Memory card slot	Memory card slot for Secure Digital (SD), Memory Stick (MS), MMC (MultiMedia Card), and Smart Media (SM) cards.
6	Memory card slot	Memory card slot for CompactFlash (CF).
7	Paper tray door	Provides access to insert the paper tray

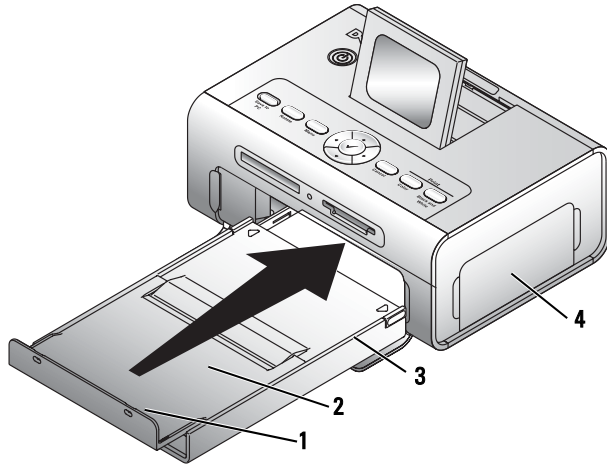

	Part	Description
1	Paper stop	Maintains orderly stack of finished prints.
2	Top paper tray cover	Finished prints are stacked here.
3	Bottom paper tray cover	Keeps dust off photo paper.
4	Photo cartridge door	Provides access to load photo cartridge.

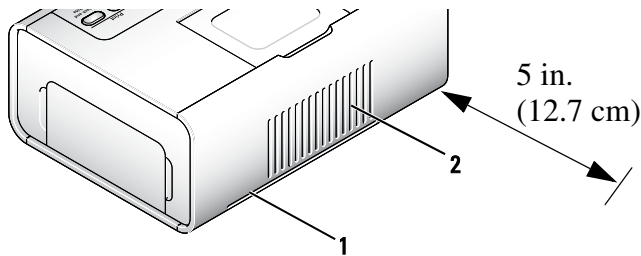

	Part	Description
1	Slot for photo paper path	Photo paper exits here during printing passes. Do not block the slot. 5 in. (12.7 cm) clearance is required.
2	Air vents	Provide ventilation and cooling to the printer. Do not block the vents.
3	Express Service Code	Located on the bottom of the printer. This is used to identify your printer when you use support.dell.com or contact technical support.

Setting Up Your Printer

 **NOTE:** The Dell Photo Printer 540 supports Microsoft® Windows® 2000 and Windows XP.

Follow the instructions on your *Setting Up Your Printer* poster to install the hardware (and software, if using your printer with a computer). For setup troubleshooting, see page 31.

Loading the Photo Cartridge

 **NOTE:** Use only the photo cartridge from a Dell Photo Print Pack. Do not use any other type of photo cartridge in your printer. Do not expose your photo cartridge to extreme temperatures. (See information on photo print pack packaging.)

- 1 If there is slack in the print ribbon, remove it by pushing in on the spool, then rotating the spool clockwise a maximum of one half turn.

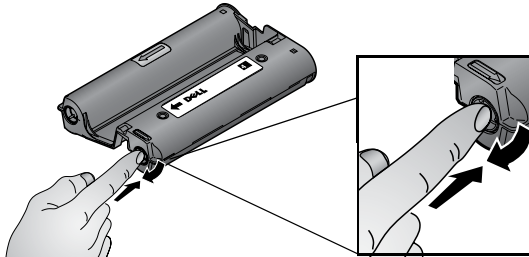

 **NOTE:** Be careful not to rotate the spool more than necessary. Doing so could reduce the number of prints you are able to make.

- 2 Open the photo cartridge door.

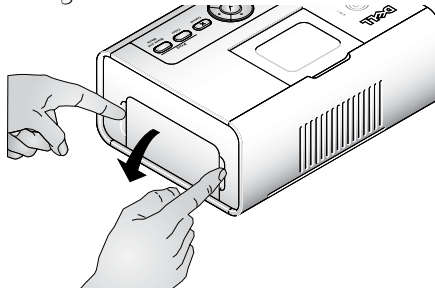

- Slide the photo cartridge in, label side up, with the arrow pointing toward the printer. Push the photo cartridge until it clicks into place.

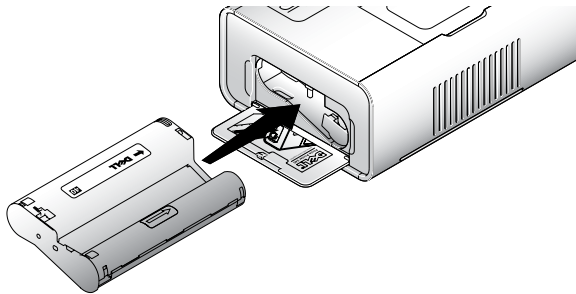

- Close the photo cartridge door.
- To remove the photo cartridge, push up on the green lever and slide the photo cartridge out.

 **NOTE:** The photo cartridge may lock in place if there is a paper jam. Do not attempt to remove the photo cartridge without first clearing the paper jam.

 **NOTE:** Warning messages and reorder instructions are displayed on the LCD when the photo cartridge is low. When there are 5 or fewer prints remaining, the error light blinks

Loading the Photo Paper

 **NOTE:** Use only the perforated photo paper from a Dell Photo Print Pack. Do not use inkjet paper or any other photo paper. Do not remove perforated tabs from the photo paper until a photo is printed.

- If the paper tray is in the printer, pull it out.
- Open the top paper tray cover.

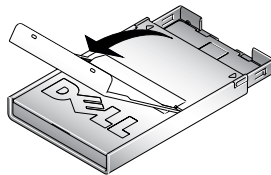

- Open the bottom paper tray cover by grasping the sides as indicated by the arrows. Do not insert your fingers under the cover to open it.

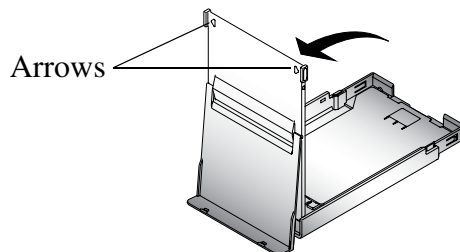

- 4 Fan the photo paper to keep the sheets from sticking together.

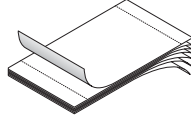

- 5 Load the photo paper into the paper tray, with the glossy side up and the Dell logo side down.

NOTE: Do not load more than 20 sheets of photo paper in the paper tray. Do not load photo paper that is missing perforated tabs. To avoid fingerprints, hold the photo paper by the edges and do not touch the glossy side of the paper.

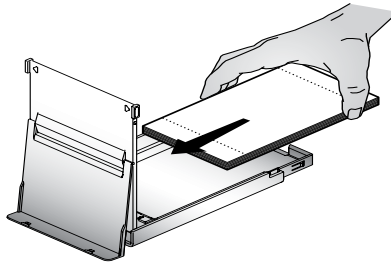

- 6 Close the bottom paper tray cover. The top paper tray cover must remain open; it catches finished prints.

- 7 Open the paper tray door.

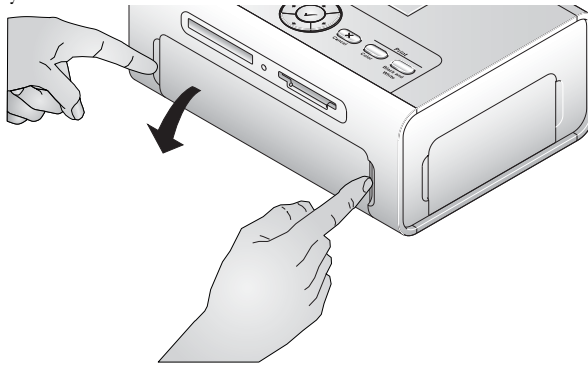

- 8 With the top paper tray cover open, insert the paper tray into the printer.

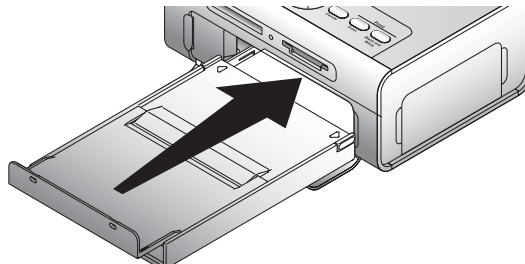

Changing Settings—Press Menu

Press the Menu button to customize your photo and printer settings.

Select Menu Items

- 1 Press the Menu button.
- 2 Press ▲ ▼ until the menu heading you want appears on the display, then press Select (✓).
- 3 Continue scrolling ▲ ▼ until the option you want is highlighted.
- 4 Press Select (✓) and follow the directions on the LCD.

 **NOTE:** The option currently selected is noted with a checkmark.

Print Options Menu

From the Print Options sub-menu:	You can:
PRINT	Specify a print mode: <ul style="list-style-type: none">• Color (default)• Black and White
LAYOUT	Specify a print layout for an entire print job: <ul style="list-style-type: none">• 1 4x6 (10 x 15 cm) photo/sheet (default)• 1 3.5x5 (9 x 13 cm) photo/sheet• 2 photos/sheet (54 x 85 mm)• 4 photos/sheet (wallet setting, 51 x 76 mm)• 9 photos/sheet (34 x 50.7 mm)
PRINT INDEX	Prints an index (thumbnail) of all photos on your card (maximum 25 thumbnails per sheet).
PRINT ALL	Print all photos on your memory card.

Photo Quality Menu

From the Photo Quality sub-menu:	You can:
AUTO BRIGHTNESS	Specify automatic brightness control for all your photos: <ul style="list-style-type: none">• On (default)• Off

From the Photo Quality sub-menu:	You can:
PHOTO BRIGHTNESS	<p>Change the brightness level (for the current photo only).</p> <p>Press ◀ or ▶ :</p> <ul style="list-style-type: none"> • Brightest • Brighter • Normal (default) • Darker • Darkest
COLOR MODE	<p>Specify natural or vivid colors:</p> <ul style="list-style-type: none"> • Natural (default) • Vivid

Photo Display Menu



From the Photo Display sub-menu:	You can:
SLIDE SHOW	<p>Sequentially display all photos on the installed card. Specify how long each photo is displayed. The slide show begins with the photo most recently displayed</p> <ul style="list-style-type: none"> • 3 seconds (default) • 5 seconds • 10 seconds <p>Press Cancel to stop the slide show.</p> <p> NOTE: To print any photo while it is displayed, press Print Color or Print Black and White. Follow the directions on the display to cancel or resume the slide show.</p>
ROTATE	<p>Press ◀ to rotate the current photo counterclockwise. Press ▶ to rotate the current photo clockwise.</p> <p> NOTE: The Rotate feature changes the orientation of the photo on the screen, not in print.</p>



Photo Management Menu

From the Photo Management sub-menu:	You can:
PHOTO NAVIGATION	<p>Specify what is displayed on the LCD when you install a card or camera: the main photo view or your card/camera folder structure.</p> <ul style="list-style-type: none">• Photo View (default)—display individual photos on the installed card or camera, starting with the current or most recent photo.• Folder View—displays the folder structure on the installed card, if present. Navigate as you would on a computer. If there are no folders, navigation defaults to Photo View.
ERASE ALL PHOTOS	<p> NOTE: This function permanently erases all photos from your card.</p> <ul style="list-style-type: none">• Erase All Photos from Memory• Cancel
SAVE TO PC	<p>Establishes a connection with your computer that allows you to save photos from your memory card, USB storage device, or camera directly to the computer. Same functionality as pressing the Save to PC button. For details, see page 28.</p>

Printer Settings Menu

From the Printer Settings sub-menu:	You can:
RESTORE DEFAULTS	<p>Reset all photo and printer settings to the defaults.</p> <ul style="list-style-type: none">• Yes• No
LANGUAGE	<p>Select a language for the display.</p>
COUNTRY	<p>Select your country; this provides a number to order Dell photo print packs.</p>
POWER SAVE	<p>Specify how long the printer remains inactive before entering auto sleep mode.</p> <ul style="list-style-type: none">• 1 Minute• 5 Minutes• 10 Minutes (default)• 15 Minutes

Maintenance Menu

From the sub-menu:	You can:
PRINTS REMAINING	<p>Check if the photo cartridge is low; if so, directions are displayed.</p> <ul style="list-style-type: none"> •  6-15 prints remaining •  1-5 prints remaining •  0 prints remaining
CHANGE CARTRIDGE	Display directions for changing the photo cartridge.
ADD PHOTO PAPER	Display directions for adding photo paper.
PRINTER DIAGNOSTICS	<p>Help diagnose print quality problems and provide printer identification information.</p> <ul style="list-style-type: none"> • Test Print • Service Tag—display your printer's service tag identification information.

Using Your Printer

Printing Without a Computer

This section describes how to print directly from a memory card, USB storage device, or PictBridge-enabled or other compatible camera.

Printing Tips

- Before you print, make sure the power is connected, and the photo cartridge and photo paper are loaded. For help, see your *Setting Up Your Printer* poster.
- Printing starts when you press **Print**. The photo paper cycles 4 times during the printing process. The first 3 passes apply layers of yellow, magenta, and cyan color. The fourth pass applies the Dell Clear Life Coating that protects and preserves the photo.



NOTE: If you remove the card or disconnect the camera during printing, then printing will stop when the current photo is printed.

- For advanced print options (color and auto brightness, layouts, index prints, etc.), press the **Menu** button. For help, see page 17.



NOTICE: Wait until a print is finished before removing it from the paper tray. Failure to do so can cause paper misfeeds or jams and can damage the printer.



NOTICE: Do not load more than 20 sheets into the paper tray.



Printing From a Memory Card

You can print directly from a CF (CompactFlash), SD (Secure Digital), MS (Memory Stick), MMC (MultiMedia Card), or SM (Smart Media), or a USB memory key.



NOTE: Your printer reads only one memory source at a time. Printing is disabled if multiple sources (cards or camera) are loaded or connected.

Inserting Memory Cards

-  **NOTICE:** Insert memory cards with the memory card label facing up.
-  **NOTE:** When you insert a memory card, a drive will appear on your computer. The photos on the memory card will not appear in this drive until you press Save to PC.
-  **NOTE:** Only photos within the first five levels of folders are displayed in Photo View mode. Use Folder View mode to navigate photos at deeper levels.

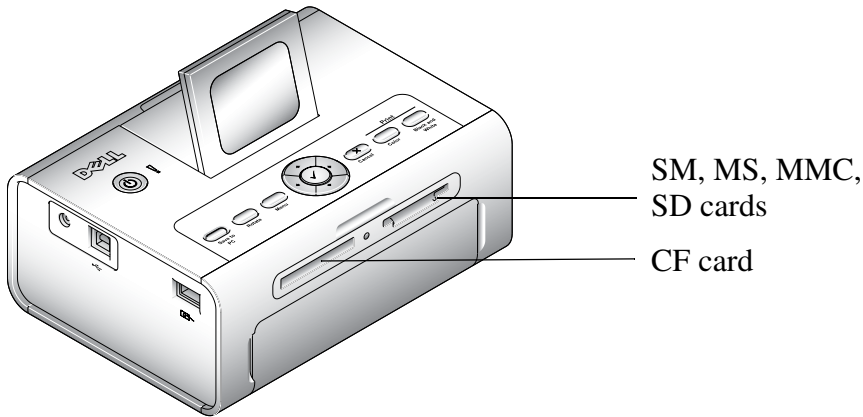

Selecting Photos to Print

- 1 Press ◀ or ▶ to scroll through photos. Press ✓ to select a photo for printing. (Press ✓ a second time to deselect that photo.)
- 2 For more than one copy of any photo, press ▲ or ▼ to increase or decrease the number of copies. Selecting zero (0) deselects the photo for printing.
- 3 To select more photos to print, repeat Steps 1 and 2. To deselect all photos, press **Cancel** for 2 seconds.
- 4 Press **Print Color** or **Print Black and White** to begin printing all selected photos. After the print job is complete, all photos are deselected.



Choosing a Layout Option

- 1 Press the Menu button, then select **Print Options** → **Layout**.
- 2 Press ◀ or ▶ to scroll through photo layouts. Press ✓ to select a layout.
- 3 Press **Print Color** or **Print Black and White** to begin printing all selected photos. The selected layout applies to this print job only. The layout then reverts to the default 1-up 4x6 photo.

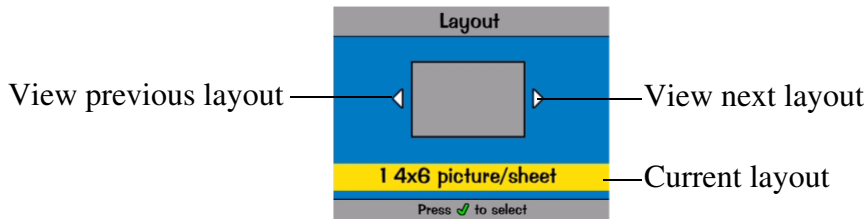

Examples:

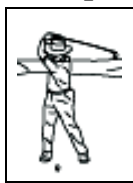

1-up

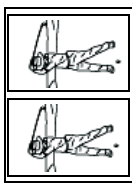

2-up
2 copies
of Photo 1

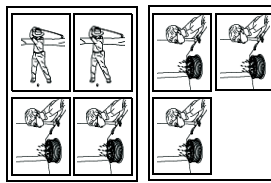

4-up
2 copies of Photo 1;
5 copies of Photo 2



9-up
6 copies of Photo 1;
9 copies of Photo 2;
2 copies of Photo 3

Printing a Print Order (Pre-Selected Photos)

When you pre-select, or tag, photos for printing on your camera, you create a print order (DPOF: Digital Print Order File). Your printer detects the print order and automatically displays the set of photos, allowing one-touch printing.

- 1 Insert your memory card.
If your card contains a print order, this message is displayed:
A print order was found. View camera photo selections?
View Selected (Displays selected photos only.)
View All (Displays all photos on the card.)
- 2 Highlight a choice, then press **Select** (✓).
- 3 If **View Selected** was the selected choice, all photos in the print order are displayed as already selected. Press **Print Color** or **Print Black and White** to print the photo selections defined by the print order or use the ✓ button to make changes to the print order. If **View All** was the selected choice, select photos to print as described in "Selecting Photos to Print" on page 22.

Printing From Your PictBridge-enabled or Other Compatible Camera

You can print photos from any PictBridge-enabled camera or other compatible device. Make sure the card slots are empty before you plug in the camera cable.

- 1 Plug the USB cable from the camera into the camera port connector  on the side of the printer.

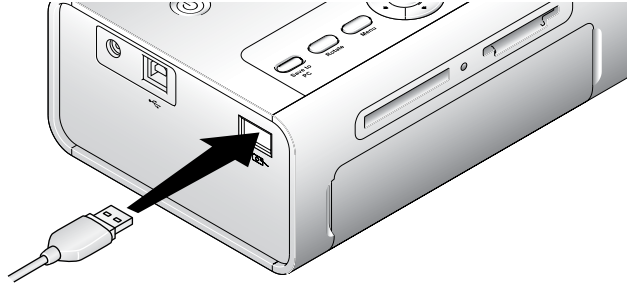

If a photo is printing when you plug the camera cable in, the camera is detected when printing is completed.

- 2 If your camera is PictBridge enabled, then use your camera display to review photos, choose printing options, and print. (If your camera is not PictBridge enabled, then use your printer LCD.)

Canceling Printing

To stop printing, press **Cancel** and follow the directions on the LCD.

Printing is canceled upon completion of the current printing pass. The unfinished print is ejected into the paper tray.

Removing Perforated Tabs From Prints

 **NOTE:** Remove perforated tabs from prints only after printing. Photo paper missing perforated tabs will not feed properly.

- 1 Fold the tabs up, then down.
- 2 Remove and discard each tab.

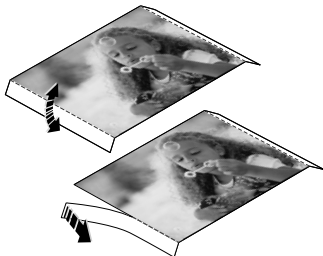

Printing With a Computer



Printing Tips

See page 21 for helpful printing tips.

Windows-Based Operating System Requirements

Minimum	Recommended
Windows 2000 Professional, Service Pack 2 and 3	Windows XP Home Edition and Home Edition, Service Pack 1. Windows XP Professional and Professional, Service Pack 1
Pentium II processor	Pentium IV processor
200 MHz	2.0 GHz
48 MB RAM	256 MB RAM
100 MB available free space	500 MB available free space
USB port	USB port
CD-ROM	CD-ROM
800 x 600 display [16 bit]	1024 x 768 (32 bit)

Installing Printer Drivers and Software

- 1 Make sure the power cable is connected to the printer and the printer is on.
- 2 Insert the **Drivers and Utilities** CD into your computer.
- 3 Plug the USB cable (sold separately) into the USB connector  on your computer.
- 4 Plug the other end of the USB cable into the square USB connector  on the printer.
- 5 Follow the on-screen instructions to install the printer drivers and printer documentation. Select **Typical** to install all components. Select **Custom** to install specific components.
- 6 Insert the remaining two CDs, one at a time, to install your photo editing software programs. Follow the on-screen instructions on the printer.

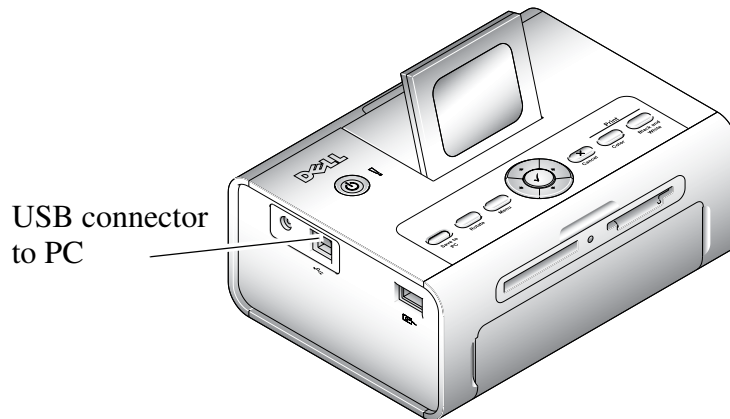

Printing From a Computer

To Print

- 1 Turn on your computer and printer, and make sure they are connected with a USB cable.
- 2 Using your preferred application, open the photos you want to print.
- 3 Access printer settings by selecting **Print** or **Page Setup** from the **File** menu (depending on your application and operating system).
- 4 Make sure the printer is selected as the current printer and that the paper size is set to 4 x 6 in. (102 x 152 mm).
- 5 Change any other settings as needed, then click **OK** or **Print**. (Depending on your application and operating system, you may first need to return to the main menu and select **Print** from the **File** menu.)

 **NOTE:** Print selections made from the printer in standalone mode (use of printer without a computer) are not used when you send a print job from the computer.

Choosing a Color Mode

Color mode is an automatic color correction feature that helps you easily create high-quality prints in no time. The Dell Photo Printer 540 features three color mode options:

Natural—high-quality, natural color for everyday photo-making (default).

Vivid—richer, more vivid colors.

None—to disable automatic color correction.

Change the color mode:

- 1 From the **Start** menu, select **Settings**, then select **Printers**.
- 2 Right-click the **Photo Printer** icon, then select **Printing Preferences**.
- 3 Click the **Advanced** button.
- 4 Under Document Options, select **Printer Features**, then select **Color Mode**.
- 5 Select a color mode option, then click **OK**.
- 6 Click **OK** when complete.

Canceling printing

You can cancel printing from the printer or from the computer.

Canceling Printing From the Printer

Press the **Cancel** button on the printer.

Canceling Printing From a Computer:

- 1 Double-click the **Printer** icon in the system tray.
- 2 Click the print job you want to cancel.
- 3 Select **Document**, then select **Cancel**.

Saving and Copying Photos to Your Computer

- 1 With the printer turned on, insert a memory card in the appropriate slot or connect a camera (not PictBridge enabled) via the camera port connector .
- 2 Press the **Save to PC** button on the printer.
If you have loaded Photo Manager software, the Photo Manager Wizard launches. Follow the prompts to transfer photos to your computer using the Photo Manager software.

If Using Windows Explorer

- 1 Double-click the **My Computer** icon on your desktop (or right-click the **Start** button and select **Explore**).
- 2 Double-click the **Removable Disk** icon. (The exact drive letter depends on your system.)
- 3 Navigate to the appropriate directory for your photos. (If the card came from a digital camera, the photos are stored in /DCIM/<camera name>/.)
- 4 Double-click a photo to open it in your default application.

Care and Maintenance



CAUTION: Before performing any of the procedures listed in this section, read and follow the Safety Instructions on page 9.

General Care of the Printer



NOTICE: Always disconnect the power before cleaning. Do not use harsh or abrasive cleaners or organic solvents on the printer or any of its parts.

- To clean the printer, wipe the outside of the printer with a clean, dry cloth.
- Support the printer and tray by placing it on a flat, level surface. Do not block the air vents.
- Avoid blocking the back of the printer and paper tray exit.
- Keep power cables and USB cables away from the paper path.
- Keep the surrounding area vacuumed and litter-free.
- Protect the printer from tobacco smoke, dust, sand, and liquid spills.
- Avoid placing objects on the printer.
- Keep the printer, accessories, and supplies away from direct sunlight and out of high-temperature environments such as a vehicle parked in the sun.
- When storing, remove the paper tray, then close the paper tray cover (see page 15) and paper tray door to keep out dust and debris. Store photo paper flat.

Cleaning the Paper Feed Roller

To prevent misfeeds and to make sure your photos are the best quality, keep the feed roller clean. Inspect the roller weekly for debris particles, and clean if necessary.

- 1 Unplug the AC power adapter.
- 2 Remove the paper tray from the printer, and leave the paper tray door open.
- 3 Lightly moisten a lint-free cloth with water.
- ➔ **NOTICE:** Do not use cotton or cotton swabs to clean the feed roller.
- 4 Use the moistened cloth to gently wipe clean the surface of the feed roller. Advance the feed roller with your thumb as necessary, and continue cleaning.
- 5 Allow the feed roller to fully dry before plugging the AC power adapter back in.

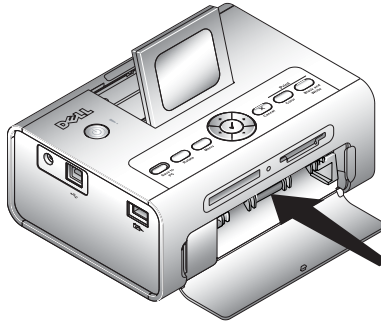

Handling and Storing the Photo Paper and Photo Cartridge

- For best quality prints, store the photo paper and photo cartridge in a location where the temperature does not exceed 85 °F (30 °C).
- To avoid getting fingerprints on the ribbon, handle the photo cartridge by the spool ends.
- To avoid fingerprints on your prints, handle the photo paper by the edges or by the perforated tabs. Do not touch the glossy side of the paper.
- When storing the printer, remove the paper tray, then close the paper tray cover and paper tray door to keep out dust and debris. Store paper flat.
- Keep the photo paper and photo cartridge away from direct sunlight and out of high-temperature environments such as a vehicle parked in the sun.

Troubleshooting

Setup Problems

If you experience problems while setting up your printer, make sure:

- You select your language and default country, and then press **Select** on the operator panel. If you skipped selecting your language or default country during the setup process, see: "Default Country Was Not Set" on page 32.
- Your operating system is compatible with your printer. The Dell Photo Printer 540 supports Windows XP and 2000.

PRINTER DOES NOT PRINT

- Make sure the photo cartridge is properly installed and there is photo paper in the tray.
- Use an undamaged USB cable.
- Check your printer status to make sure your photo is not being held in the print queue or paused. To check printer status:
 - Click **Start** → **Control Panel** → **Printers and Other Hardware** → **Printers and Faxes** (Windows XP). Click **Start** → **Settings** → **Printers** (Windows 2000).
 - Double-click the **Dell Photo Printer 540** icon, and then click **Printer**.
 - Click **Printer**, and make sure no check mark appears next to **Pause Printing**.
- A camera is properly connected.
- A memory card is properly inserted (label side up, fully inserted into the proper slot).
- Print a test page:
 - Click **Start** → **All Programs** (or **Programs**) → **Dell Printers** → **Dell Photo Printer 540** → **Printing Preferences**.
 - Click the **Maintenance** tab.
 - From the Maintenance tab, click **Print Test Page**.

DISPLAY LANGUAGE IS INCORRECT —If the language on the printer display is not the language you prefer, change the language:

- 1 Click **Menu** → **Printer Settings** → **Language**.
- 2 Use the navigation arrow buttons until **Language** appears on the display, then press **✓**.
- 3 Use the navigation arrows and **✓** buttons to set your language as the default.

DEFAULT COUNTRY WAS NOT SET—If you did not select the default country during the setup process:

- 1 Click Menu → Printer Settings → Country.
- 2 Use the navigation arrow buttons until the desired country appears on the display, then press ✓.
- 3 Use the navigation arrows and ✓ buttons to set your country as the default.

CAMERA AND PRINTER DO NOT COMMUNICATE.

Make sure camera is in the correct file transfer mode. See your camera Owner's Manual.

General Problems

ANYTIME YOUR PRINTER HAS A PROBLEM, MAKE SURE:

- Your printer is on.
- The photo paper is loaded correctly. For help, see "Loading the Photo Paper" on page 15.
- Unplug the power supply from the electrical outlet. Reconnect the power supply (see your *Setup Diagram*). Turn the power on.

IF YOUR PRINTER IS *NOT* ATTACHED TO A COMPUTER, MAKE SURE:

- You read and follow any messages on the LCD.
- The power supply is plugged into your printer and an electrical outlet.

IF YOUR PRINTER *IS* ATTACHED TO A COMPUTER, MAKE SURE:

- The USB cable is securely attached to your computer and to your printer. For help, see the *Setting Up Your Printer* poster.
- Both your computer and your printer are on.
- The Dell Photo Printer 540 is the selected printer. (It should not be set as the default if there is another printer connected.)
- Restart your computer. If problems persist, see "Uninstalling and reinstalling the software" in your *User's Guide*. For help accessing your *User's Guide*, see page 11.

Error Messages

If an error occurs, the Error light glows amber and an error message is displayed on the printer LCD. Follow the directions on the LCD to resolve the problem.

Printing Problems

PHOTO PAPER DOES NOT FEED

 **NOTE:** Use only Dell photo paper from a Dell Photo Print Pack for your printer. Do not use inkjet paper or any other paper.

The paper tray may be empty. Load photo paper (page 15) and re-install the paper tray. Check the photo paper:

- 1 Remove the paper tray (page 15).
- 2 Inspect the paper supply: make sure photo paper is not damaged in any way, or removable tabs have not been detached. Replace with new photo paper if necessary.
- 3 Carefully “fan” the photo paper to keep the sheets from sticking together.
- 4 Reload the paper tray **using no more than 20 sheets**.
- 5 Re-install the paper tray, then press ✓ to resume printing.

Clean the paper feed roller (page 30).

MULTIPLE SHEETS OF PHOTO PAPER ARE PULLED THROUGH PRINTER—Remove the paper tray (page 15).

- 1 Remove the paper supply from the paper tray.
- 2 Carefully “fan” the photo paper to keep the sheets from sticking together.
- 3 Reload the paper tray using **no more than 20 sheets**.
- 4 Re-install the paper tray, then press **Print** to resume printing.

PRINTER IS JAMMED

 **NOTE:** Use only Dell photo paper from a Dell Photo Print Pack for your printer. Do not use inkjet paper or any other photo paper.

- If the Error indicator light is lit:

- 1 Remove the paper tray (page 15).
- 2 Disconnect the AC power adapter, wait 5 seconds, then plug it back in.
If the paper does not automatically eject, carefully remove the paper manually.

 **NOTE:** Always check the paper slot on the back of the printer for jammed paper:

- 3 Remove the paper supply from the paper tray. Carefully “fan” the paper to keep the sheets from sticking together.
 - 4 Reload the paper tray using **no more than 20 sheets**.
 - 5 Re-install the paper tray, then press ✓ to resume printing.
- If the Error light is still lit, check the photo cartridge:

 **NOTE:** The photo cartridge may lock in place if there is a paper error. Do not attempt to remove the photo cartridge without first clearing the paper jam.

Remove the photo cartridge, remove any slack from the ribbon, then re-install the photo cartridge (page 14). Press **Print** to resume printing.

PRINTING STOPS DURING MID-PRINT (PAPER STOPS FEEDING, AND ERROR INDICATOR LIGHT IS ON)

 **NOTE:** Use only Dell photo paper from a Dell Photo Print Pack for your printer. Do not use inkjet paper or any other photo paper.

- Check the photo paper:
 - 1 Remove the paper tray.
 - 2 Check the paper slot on the back of the printer.
 - 3 Remove loose paper from the printer.
 - 4 Inspect the paper supply: make sure removable tabs have not been detached from the photo paper. Reload with new photo paper if necessary.
 - 5 Carefully “fan” the photo paper to keep the sheets from sticking together.
 - 6 Reload the paper tray using **no more than 20 sheets**.
 - 7 Re-install the paper tray, then press ✓ to resume printing.
- Clean the paper feed roller (page 30).

PRINT IS SMUDGED

Fingerprints may be on glossy side of paper. Handle paper by the edges or by the removable tabs.

PRINT IS SPOTTED

Check to see if the photo paper is dirty, and use a dry, lint-free cloth to wipe clean. For excessive dirt or debris, thoroughly clean the paper tray, and load new photo paper (page 15).

 **NOTE:** When storing photo paper, remove and close the paper tray and close the paper tray door on the printer. These steps keep dust and debris from collecting on the photo paper or inside the printer.

PRINT IS TOO LIGHT

 **NOTE:** Use only Dell photo paper from a Dell Photo Print Pack for your printer. Do not use inkjet paper or any other photo paper.

- Photo brightness can be changed by selecting Photo Quality--> Photo Brightness (page 17) or --> Automatic photo brightness.
- Make sure the photo paper is loaded with the Dell logo facing down. Reload if necessary (page 15).
- Try re-taking the photo with the flash off. See your camera user’s guide for details.
- Adjust the exposure compensation on your camera (if available), and try re-taking the photo. See your camera user’s guide for details.
- Edit the photo using Dell Photo Imaging software on your computer. See the Photo Imaging software Help for details.

PRINT IS TOO DARK OR IS DISCOLORED

- Photo brightness can be changed by selecting Photo Quality--> Photo Brightness (page 17) or --> Automatic photo brightness.
- Try re-taking the photo with the flash on, or move within the flash range of the camera. See your camera user's guide for details.
- Adjust the exposure compensation on your camera (if available), and try re-taking the photo. See your camera user's guide for details.
- Edit the photo using Dell Photo Imaging software on your computer. See the Photo Imaging software Help for details.
- Make sure the printer is not placed in direct sunlight or is not operating in a high-temperature environment.
- Make sure the cooling vents are not blocked or dirty (page 13).

PHOTOS ARE CROPPED

- Set your camera to Best (3:2) photo quality, if available. See your camera user's guide for details.
- Adjust cropped photos using Dell Photo Imaging software on your computer.
- If you are printing from an application on your computer, select the proper paper size in print options.

A SELECTED PHOTO DOES NOT PRINT

The image file may be corrupt. Review the photo on the camera, LCD, or computer and delete if necessary.

NOTHING HAPPENS WHEN YOU TRY TO PRINT FROM A MEMORY CARD

- Check the power connections. See the *Setting Up Your Printer* poster.
- Remove the paper tray, check that photo paper is properly loaded, and re-install (page 15).
- Make sure the photo cartridge is properly installed (page 14).
- Make sure a memory card is inserted and that there is at least one photo on the memory card (page 21).

NOTHING HAPPENS WHEN YOU TRY TO PRINT FROM PICTBRIDGE OR OTHER COMPATIBLE CAMERA

- Check the USB connections from the camera to the printer (page 24).
- Re-establish the connection: disconnect, then reconnect the USB cable from the camera to the printer.
- Make sure there is at least one photo in the camera's internal memory or memory card.

NOTHING HAPPENS WHEN YOU TRY TO PRINT (FROM COMPUTER)

- Check the USB connections from the printer to the computer (page 26).
- The computer may be transferring images. Wait a few seconds, then try again.
- Access the printer menu for your system. Remove check marks next to Pause Printing and Offline, if checked.
- Close unnecessary software applications. Disconnect then reconnect the USB cable from the printer to the computer (page 26).
- Make sure Drivers and Utilities software is installed (page 25). Install if necessary.
- Uninstall, then reinstall Drivers and Utilities software (page 25).
- Make sure your computer meets the minimum system requirements (page 25). Upgrade your system if necessary.

PRINTING IS SLOW—

NOTE: When printing a large number of prints, printing may slow down to prevent the print head from overheating.

- Make sure the printer is not placed in direct sunlight or is not operating in a high-temperature environment.
- Make sure the cooling vents are not blocked or dirty (page 13).
- Close unnecessary software applications.
- Make sure your computer meets the minimum system requirements (page 25). Upgrade your system if necessary.

UNABLE TO REMOVE PHOTO CARTRIDGE (ERROR LIGHT GLOWS STEADY.)

NOTE: The photo cartridge may lock in place if there is a paper error. Do not attempt to remove the photo cartridge without first clearing the paper error.

- Check to see if the paper tray is empty or if paper is missing perforated tabs. Reload photo paper if necessary (page 15), then try again.
- Make sure photo paper is not jammed. Clear the jam if necessary, then try again.

PHOTO PAPER RUNS OUT BEFORE THE PHOTO CARTRIDGE (OR VICE VERSA)

- Supply mismatch can result from several different situations, including:
 - Scrapping of photo paper as a result of jams or other errors
 - Gradual advancement of the print ribbon as a result of removing ribbon slack or clearing jams

Supply mismatch is likely to occur as you continue to use your printer. If you wish to keep your photo cartridge and photo paper supply synchronized, discard unused photo cartridge or photo paper when one or the other is fully depleted.

Transfer/communication problems

NOTHING HAPPENS WHEN YOU TRY TO TRANSFER PHOTOS TO THE COMPUTER

- Press the **Save to PC** button on the printer.
- Check the power and USB connections from the printer to computer (page 26).
- If you are trying to transfer photos from a PictBridge-enabled camera (page 24), check the USB connections between the printer and the camera.
- Close unnecessary software applications, and minimize remaining application windows. Follow any messages on the screen that may have been hidden by other windows.
- Disconnect then reconnect the USB cable from the printer to the computer (page 26).
- Make sure Drivers and Utilities software is installed (page 26). Install if necessary.
- Uninstall, then reinstall Drivers and Utilities software (page 26).
- Make sure your computer meets the minimum system requirements (page 25). Upgrade your system if necessary.
-

More Troubleshooting Options

Go to support.dell.com for help.

Contacting Dell

Technical Assistance

If you need help with a technical problem, Dell is ready to assist you.

- 1 Call technical support from a telephone near or at the printer so that technical support can assist you with any necessary procedures. When calling Dell, use your Express Service Code to help expedite the routing of your call to the proper support personnel.

The Express Service Code is located on data plate on the bottom of the printer.

NOTE: Dell's Express Service Code system may not be available in all countries.

- 2 In the U.S., Business customers should call 1-877-459-7298, and Consumer (Home and Home Office) customers should call 1-800-624-9896.

If you are calling from a different country or are in a different Service area, see "Contacting Dell" for your local telephone number.

- 3 Follow the menu prompts in the automated telephone system to speak with a technical support representative.

Automated Order-Status Service

To check on the status of any Dell™ products that you have ordered, you can go to support.dell.com, or you can call the automated order-status service. A recording prompts you for the information needed to locate and report on your order. See "Contacting Dell" for the telephone number to call for your region.

Contacting Dell

To contact Dell electronically, you can access the following websites:

- www.dell.com
- support.dell.com (technical support)
- premiersupport.dell.com (technical support for educational, government, healthcare, and medium/large business customers, including Premier, Platinum, and Gold customers)

For specific web addresses for your country, find the appropriate country section in the table below.

NOTE: Toll-free numbers are for use within the country for which they are listed.

When you need to contact Dell, use the electronic addresses, telephone numbers, and codes provided in the following table. If you need assistance in determining which codes to use, contact a local or an international operator.

Country (City) International Access Code Country Code City Code	Department Name or Service Area, Website and E-Mail Address	Area Codes, Local Numbers, and Toll-Free Numbers
Anguilla	General Support	toll-free: 800-335-0031
Antigua and Barbuda	General Support	1-800-805-5924
Argentina (Buenos Aires) International Access Code: 00 Country Code: 54 City Code: 11	Website: www.dell.com.ar E-mail: us_latin_services@dell.com E-mail for desktop and portable computers: la-techsupport@dell.com E-mail for servers and EMC: la_enterprise@dell.com Customer Care Tech Support Tech Support Services Sales	toll-free: 0-800-444-0730 toll-free: 0-800-444-0733 toll-free: 0-800-444-0724 0-810-444-3355
Aruba	General Support	toll-free: 800-1578
Australia (Sydney) International Access Code: 0011 Country Code: 61 City Code: 2	E-mail (Australia): au_tech_support@dell.com E-mail (New Zealand): nz_tech_support@dell.com Home and Small Business Government and Business Preferred Accounts Division (PAD) For servers and storage For desktop and portable computers Customer Care Corporate Sales Transaction Sales Fax	1-300-65-55-33 toll-free: 1-800-633-559 toll-free: 1-800-060-889 toll-free: 1-800-505-095 toll-free: 1-800-733-314 toll-free: 1-800-819-339 toll-free: 1-800-808-385 toll-free: 1-800-808-312 toll-free: 1-800-818-341

Country (City) International Access Code Country Code City Code	Department Name or Service Area, Website and E-Mail Address	Area Codes, Local Numbers, and Toll-Free Numbers
Austria (Vienna)	Website: support.euro.dell.com	
International Access Code: 900	E-mail: tech_support_central_europe@dell.com	
Country Code: 43	Home/Small Business Sales	0820 240 530 00
City Code: 1	Home/Small Business Fax	0820 240 530 49
	Home/Small Business Customer Care	0820 240 530 14
	Preferred Accounts/Corporate Customer Care	0820 240 530 16
	Home/Small Business Technical Support	0820 240 530 14
	Preferred Accounts/Corporate Technical Support	0660 8779
	Switchboard	0820 240 530 00
Bahamas	General Support	toll-free: 1-866-278-6818
Barbados	General Support	1-800-534-3066
Belgium (Brussels)	Website: support.euro.dell.com	
International Access Code: 00	E-mail for French Speaking Customers: support.euro.dell.com/be/fr/emaildell/	
Country Code: 32	Technical Support	02 481 92 88
City Code: 2	Technical Support Fax	02 481 92 95
	Customer Care	02 713 15 .65
	Corporate Sales	02 481 91 00
	Fax	02 481 92 99
	Switchboard	02 481 91 00
Bermuda	General Support	1-800-342-0671
Bolivia	General Support	toll-free: 800-10-0238
Brazil	Website: www.dell.com/br	
International Access Code: 00	Customer Support, Technical Support	0800 90 3355
Country Code: 55	Technical Support Fax	51 481 5470
City Code: 51	Customer Care Fax	51 481 5480
	Sales	0800 90 3390
British Virgin Islands	General Support	toll-free: 1-866-278-6820
Brunei	Customer Technical Support (Penang, Malaysia)	604 633 4966
Country Code: 673	Customer Service (Penang, Malaysia)	604 633 4949
	Transaction Sales (Penang, Malaysia)	604 633 4955

Country (City) International Access Code Country Code City Code	Department Name or Service Area, Website and E-Mail Address	Area Codes, Local Numbers, and Toll-Free Numbers
Canada (North York, Ontario) International Access Code: 011	Online Order Status: www.dell.ca/ostatus AutoTech (automated technical support) Customer Care (Home Sales/Small Business) Customer Care (med./large business, government) Technical Support (Home Sales/Small Business) Technical Support (med./large bus., government) Sales (Home Sales/Small Business) Sales (med./large bus., government) Spare Parts Sales & Extended Service Sales	toll-free: 1-800-247-9362 toll-free: 1-800-847-4096 toll-free: 1-800-326-9463 toll-free: 1-800-847-4096 toll-free: 1-800-387-5757 toll-free: 1-800-387-5752 toll-free: 1-800-387-5755 1 866 440 3355
Cayman Islands	General Support	1-800-805-7541
Chile (Santiago) Country Code: 56 City Code: 2	Sales, Customer Support, and Technical Support	toll-free: 1230-020-4823

Country (City) International Access Code Country Code City Code	Department Name or Service Area, Website and E-Mail Address	Area Codes, Local Numbers, and Toll-Free Numbers
China (Xiamen) Country Code: 86 City Code: 592	Technical Support website: support.dell.com.cn Technical Support E-mail: cn_support@dell.com Technical Support Fax Technical Support (Dimension™ and Inspiron™) Technical Support (OptiPlex™, Latitude™, and Dell Precision™) Technical Support (servers and storage) Technical Support (projectors, PDAs, printers, switches, routers, and so on) Customer Advocacy Customer Advocacy Fax Home and Small Business Preferred Accounts Division Large Corporate Accounts GCP Large Corporate Accounts Key Accounts Large Corporate Accounts North Large Corporate Accounts North Government and Education Large Corporate Accounts East Large Corporate Accounts East Government and Education Large Corporate Accounts Queue Team Large Corporate Accounts South Large Corporate Accounts West Large Corporate Accounts Spare Parts	818 1350 toll-free: 800 858 2969 toll-free: 800 858 0950 toll-free: 800 858 0960 toll-free: 800 858 2920 toll-free: 800 858 2060 592 818 1308 toll-free: 800 858 2222 toll-free: 800 858 2557 toll-free: 800 858 2055 toll-free: 800 858 2628 toll-free: 800 858 2999 toll-free: 800 858 2955 toll-free: 800 858 2020 toll-free: 800 858 2669 toll-free: 800 858 2572 toll-free: 800 858 2355 toll-free: 800 858 2811 toll-free: 800 858 2621
Colombia	General Support	980-9-15-3978
Costa Rica	General Support	0800-012-0435

Country (City) International Access Code Country Code City Code	Department Name or Service Area, Website and E-Mail Address	Area Codes, Local Numbers, and Toll-Free Numbers
Czech Republic (Prague)	Website: support.euro.dell.com	
International Access Code: 00	E-mail: czech_dell@dell.com	
Country Code: 420	Technical Support	02 2186 27 27
City Code: 2	Technical Support Fax	02 2186 27 28
	Customer Care	02 2186 27 11
	Customer Care Fax	02 2186 27 14
	Switchboard	02 2186 27 11
Denmark (Copenhagen)	Website: support.euro.dell.com	
International Access Code: 00	E-mail Support (portable computers): den_nbk_support@dell.com	
Country Code: 45	E-mail Support (desktop computers): den_support@dell.com	
	E-mail Support (servers): Nordic_server_support@dell.com	
	Technical Support	7023 0182
	Customer Care (Relational)	7023 0184
	Home/Small Business Customer Care	3287 5505
	Switchboard (Relational)	3287 1200
	Switchboard Fax (Relational)	3287 1201
	Switchboard (Home/Small Business)	3287 5000
	Switchboard Fax (Home/Small Business)	3287 5001
Dominica	General Support	toll-free: 1-866-278-6821
Dominican Republic	General Support	1-800-148-0530
Ecuador	General Support	toll-free: 999-119
El Salvador	General Support	01-899-753-0777

Country (City) International Access Code Country Code City Code	Department Name or Service Area, Website and E-Mail Address	Area Codes, Local Numbers, and Toll-Free Numbers
Finland (Helsinki) International Access Code: 990 Country Code: 358 City Code: 9	Website: support.euro.dell.com E-mail: fin_support@dell.com E-mail Support (servers): Nordic_support@dell.com	
	Technical Support	09 253 313 60
	Technical Support Fax	09 253 313 81
	Relational Customer Care	09 253 313 38
	Home/Small Business Customer Care	09 693 791 94
	Fax	09 253 313 99
	Switchboard	09 253 313 00
France (Paris) (Montpellier) International Access Code: 00 Country Code: 33 City Codes: (1) (4)	Website: support.euro.dell.com E-mail: support.euro.dell.com/fr/fr/emaildell/ Home and Small Business	
	Technical Support	0825 387 270
	Customer Care	0825 823 833
	Switchboard	0825 004 700
	Switchboard (calls from outside of France)	04 99 75 40 00
	Sales	0825 004 700
	Fax	0825 004 701
	Fax (calls from outside of France)	04 99 75 40 01
	Corporate	
	Technical Support	0825 004 719
	Customer Care	0825 338 339
	Switchboard	01 55 94 71 00
	Sales	01 55 94 71 00
	Fax	01 55 94 71 01

Country (City) International Access Code Country Code City Code	Department Name or Service Area, Website and E-Mail Address	Area Codes, Local Numbers, and Toll-Free Numbers
Germany (Langen)	Website: support.euro.dell.com	
International Access Code: 00	E-mail: tech_support_central_europe@dell.com	
Country Code: 49	Technical Support	06103 766-7200
City Code: 6103	Home/Small Business Customer Care	0180-5-224400
	Global Segment Customer Care	06103 766-9570
	Preferred Accounts Customer Care	06103 766-9420
	Large Accounts Customer Care	06103 766-9560
	Public Accounts Customer Care	06103 766-9555
	Switchboard	06103 766-7000
Greece	Website: support.euro.dell.com	
International Access Code: 00	E-mail: support.euro.dell.com/gr/en/emailldell/	
Country Code: 30	Technical Support	00800-44 14 95 18
	Gold Service Technical Support	00800-44 14 00 83
	Switchboard	2108129810
	Gold Service Switchboard	2108129811
	Sales	2108129800
	Fax	2108129812
Grenada	General Support	toll-free: 1-866-540-3355
Guatemala	General Support	1-800-999-0136
Guyana	General Support	toll-free: 1-877-270-4609
Hong Kong	Website: support.ap.dell.com	
International Access Code: 001	E-mail: apsupport@dell.com	
Country Code: 852	Technical Support (Dimension™ and Inspiron™)	2969 3188
	Technical Support (OptiPlex™, Latitude™, and Dell Precision™)	2969 3191
	Technical Support (PowerApp™, PowerEdge™, PowerConnect™, and PowerVault™)	2969 3196
	Gold Queue EEC Hotline	2969 3187
	Customer Advocacy	3416 0910
	Large Corporate Accounts	3416 0907
	Global Customer Programs	3416 0908
	Medium Business Division	3416 0912

Country (City) International Access Code Country Code City Code	Department Name or Service Area, Website and E-Mail Address	Area Codes, Local Numbers, and Toll-Free Numbers
	Home and Small Business Division	2969 3155
India	Technical Support	1600 33 8045
	Sales	1600 33 8044
Ireland (Cherrywood)	Website: support.euro.dell.com	
International Access Code: 16	E-mail: dell_direct_support@dell.com	
Country Code: 353	Technical Support	1850 543 543
City Code: 1	U.K. Technical Support (dial within U.K. only)	0870 908 0800
	Home User Customer Care	01 204 4014
	Small Business Customer Care	01 204 4014
	U.K. Customer Care (dial within U.K. only)	0870 906 0010
	Corporate Customer Care	1850 200 982
	Corporate Customer Care (dial within U.K. only)	0870 907 4499
	Ireland Sales	01 204 4444
	U.K. Sales (dial within U.K. only)	0870 907 4000
	Fax/Sales Fax	01 204 0103
	Switchboard	01 204 4444
Italy (Milan)	Website: support.euro.dell.com	
International Access Code: 00	E-mail: support.euro.dell.com/it/it/emaildell/	
Country Code: 39	Home and Small Business	
City Code: 02	Technical Support	02 577 826 90
	Customer Care	02 696 821 14
	Fax	02 696 821 13
	Switchboard	02 696 821 12
	Corporate	
	Technical Support	02 577 826 90
	Customer Care	02 577 825 55
	Fax	02 575 035 30
	Switchboard	02 577 821
Jamaica	General Support (dial from within Jamaica only)	1-800-682-3639

Country (City) International Access Code Country Code City Code	Department Name or Service Area, Website and E-Mail Address	Area Codes, Local Numbers, and Toll-Free Numbers
Japan (Kawasaki)	Website: support.jp.dell.com	
International Access Code: 001	Technical Support (servers)	toll-free: 0120-198-498
Country Code: 81	Technical Support outside of Japan (servers)	81-44-556-4162
City Code: 44	Technical Support (Dimension™ and Inspiron™)	toll-free: 0120-198-226
	Technical Support outside of Japan (Dimension and Inspiron)	81-44-520-1435
	Technical Support (Dell Precision™, OptiPlex™, and Latitude™)	toll-free:0120-198-433
	Technical Support outside of Japan (Dell Precision, OptiPlex, and Latitude)	81-44-556-3894
	Technical Support (PDAs, projectors, printers, routers)	toll-free: 0120-981-690
	Technical Support outside of Japan (PDAs, projectors, printers, routers)	81-44-556-3468
	Faxbox Service	044-556-3490
	24-Hour Automated Order Service	044-556-3801
	Customer Care	044-556-4240
	Business Sales Division (up to 400 employees)	044-556-1465
	Preferred Accounts Division Sales (over 400 employees)	044-556-3433
	Large Corporate Accounts Sales (over 3500 employees)	044-556-3430
	Public Sales (government agencies, educational institutions, and medical institutions)	044-556-1469
	Global Segment Japan	044-556-3469
	Individual User	044-556-1760
	Switchboard	044-556-4300
Korea (Seoul)	Technical Support	toll-free: 080-200-3800
International Access Code: 001	Sales	toll-free: 080-200-3600
Country Code: 82	Customer Service (Seoul, Korea)	toll-free: 080-200-3800
City Code: 2	Customer Service (Penang, Malaysia)	604 633 4949
	Fax	2194-6202
	Switchboard	2194-6000

Country (City) International Access Code Country Code City Code	Department Name or Service Area, Website and E-Mail Address	Area Codes, Local Numbers, and Toll-Free Numbers
Latin America	Customer Technical Support (Austin, Texas, U.S.A.)	512 728-4093
	Customer Service (Austin, Texas, U.S.A.)	512 728-3619
	Fax (Technical Support and Customer Service) (Austin, Texas, U.S.A.)	512 728-3883
	Sales (Austin, Texas, U.S.A.)	512 728-4397
	SalesFax (Austin, Texas, U.S.A.)	512 728-4600 or 512 728-3772
Luxembourg	Website: support.euro.dell.com	
International Access Code: 00	E-mail: tech_be@dell.com	
Country Code: 352	Technical Support (Brussels, Belgium)	3420808075
	Home/Small Business Sales (Brussels, Belgium)	toll-free: 080016884
	Corporate Sales (Brussels, Belgium)	02 481 91 00
	Customer Care (Brussels, Belgium)	02 481 91 19
	Fax (Brussels, Belgium)	02 481 92 99
	Switchboard (Brussels, Belgium)	02 481 91 00
Macao	Technical Support	toll-free: 0800 582
Country Code: 853	Customer Service (Penang, Malaysia)	604 633 4949
	Transaction Sales	toll-free: 0800 581
Malaysia (Penang)	Technical Support (Dell Precision, OptiPlex, and Latitude)	toll-free: 1 800 88 0193
International Access Code: 00		
Country Code: 60	Technical Support (Dimension and Inspiron)	toll-free: 1 800 88 1306
City Code: 4	Technical Support (PowerEdge and PowerVault)	toll-free: 1800 88 1386
	Customer Service	04 633 4949
	Transaction Sales	toll-free: 1 800 888 202
	Corporate Sales	toll-free: 1 800 888 213

Country (City) International Access Code Country Code City Code	Department Name or Service Area, Website and E-Mail Address	Area Codes, Local Numbers, and Toll-Free Numbers
Mexico International Access Code: 00 Country Code: 52	Customer Technical Support Sales Customer Service Main	001-877-384-8979 or 001-877-269-3383 50-81-8800 or 01-800-888-3355 001-877-384-8979 or 001-877-269-3383 50-81-8800 or 01-800-888-3355
Montserrat	General Support	toll-free: 1-866-278-6822
Netherlands Antilles	General Support	001-800-882-1519
Netherlands (Amsterdam) International Access Code: 00 Country Code: 31 City Code: 20	Website: support.euro.dell.com Technical Support Technical Support Fax Home/Small Business Customer Care Relational Customer Care Home/Small Business Sales Relational Sales Home/Small Business Sales Fax Relational Sales Fax Switchboard Switchboard Fax	020 674 45 00 020 674 47 66 020 674 42 00 020 674 4325 020 674 55 00 020 674 50 00 020 674 47 75 020 674 47 50 020 674 50 00 020 674 47 50
New Zealand International Access Code: 00 Country Code: 64	E-mail (New Zealand): nz_tech_support@dell.com E-mail (Australia): au_tech_support@dell.com Technical Support (for desktop and portable computers) Technical Support (for servers and storage) Home and Small Business Government and Business Sales Fax	0800 443 563 0800 505 098 0800 446 255 0800 444 617 0800 441 567 0800 441 566
Nicaragua	General Support	001-800-220-1006

Country (City) International Access Code Country Code City Code	Department Name or Service Area, Website and E-Mail Address	Area Codes, Local Numbers, and Toll-Free Numbers
Norway (Lysaker)	Website: support.euro.dell.com	
International Access Code: 00	E-mail Support (portable computers):	
Country Code: 47	nor_nbk_support@dell.com	
	E-mail Support (desktop computers):	
	nor_support@dell.com	
	E-mail Support (servers):	
	nordic_server_support@dell.com	
	Technical Support	671 16882
	Relational Customer Care	671 17514
	Home/Small Business Customer Care	23162298
	Switchboard	671 16800
	Fax Switchboard	671 16865
Panama	General Support	001-800-507-0962
Peru	General Support	0800-50-669
Poland (Warsaw)	Website: support.euro.dell.com	
International Access Code: 011	E-mail: pl_support_tech@dell.com	
Country Code: 48	Customer Service Phone	57 95 700
City Code: 22	Customer Care	57 95 999
	Sales	57 95 999
	Customer Service Fax	57 95 806
	Reception Desk Fax	57 95 998
	Switchboard	57 95 999
Portugal	Website: support.euro.dell.com	
International Access Code: 00	E-mail: support.euro.dell.com/pt/en/emailldell/	
Country Code: 351	Technical Support	707200149
	Customer Care	800 300 413
	Sales	800 300 410 or 800 300 411 or 800 300 412 or 21 422 07 10
	Fax	21 424 01 12
Puerto Rico	General Support	1-800-805-7545
St. Kitts and Nevis	General Support	toll-free: 1-877-441-4731

Country (City) International Access Code Country Code City Code	Department Name or Service Area, Website and E-Mail Address	Area Codes, Local Numbers, and Toll-Free Numbers
St. Lucia	General Support	1-800-882-1521
St. Vincent and the Grenadines	General Support	toll-free: 1-877-270-4609
Singapore (Singapore)	Technical Support (Dimension and Inspiron)	toll-free: 1800 394 7430
International Access Code: 005 Country Code: 65	Technical Support (Optiplex, Latitude, and Precision)	toll-free: 1800 394 7488
	Technical Support (PowerEdge and PowerVault)	toll-free: 1800 394 7478
	Customer Service (Penang, Malaysia)	604 633 4949
	Transaction Sales	toll-free: 800 6011 054
	Corporate Sales	toll-free: 800 6011 053
South Africa (Johannesburg)	Website: support.euro.dell.com	
International Access Code: 09/091	E-mail: dell_za_support@dell.com	
Country Code: 27	Gold Queue	011 709 7713
City Code: 11	Technical Support	011 709 7710
	Customer Care	011 709 7707
	Sales	011 709 7700
	Fax	011 706 0495
	Switchboard	011 709 7700
Southeast Asian and Pacific Countries	Customer Technical Support, Customer Service, and Sales (Penang, Malaysia)	604 633 4810
Spain (Madrid)	Website: support.euro.dell.com	
International Access Code: 00	E-mail: support.euro.dell.com/es/es/emaildell/	
Country Code: 34	Home and Small Business	
City Code: 91	Technical Support	902 100 130
	Customer Care	902 118 540
	Sales	902 118 541
	Switchboard	902 118 541
	Fax	902 118 539
	Corporate	
	Technical Support	902 100 130
	Customer Care	902 115 236
	Switchboard	91 722 92 00
	Fax	91 722 95 83

Country (City) International Access Code Country Code City Code	Department Name or Service Area, Website and E-Mail Address	Area Codes, Local Numbers, and Toll-Free Numbers
Sweden (Upplands Vasby) International Access Code: 00 Country Code: 46 City Code: 8	Website: support.euro.dell.com E-mail: swe_support@dell.com E-mail Support for Latitude and Inspiron: Swe-nbk_kats@dell.com E-mail Support for OptiPlex: Swe_kats@dell.com E-mail Support for Servers: Nordic_server_support@dell.com	
	Technical Support	08 590 05 199
	Relational Customer Care	08 590 05 642
	Home/Small Business Customer Care	08 587 70 527
	Employee Purchase Program (EPP) Support	20 140 14 44
	Technical Support Fax	08 590 05 594
	Sales	08 590 05 185
Switzerland (Geneva) International Access Code: 00 Country Code: 41 City Code: 22	Website: support.euro.dell.com E-mail: Tech_support_central_Europe@dell.com E-mail for French-speaking HSB and Corporate Customers: support.euro.dell.com/ch/fr/emaildell/	
	Technical Support (Home and Small Business)	0844 811 411
	Technical Support (Corporate)	0844 822 844
	Customer Care (Home and Small Business)	0848 802 202
	Customer Care (Corporate)	0848 821 721
	Fax	022 799 01 90
	Switchboard	022 799 01 01
Taiwan International Access Code: 002 Country Code: 886	Technical Support (portable and desktop computers) Technical Support (servers and storage) Corporate Sales	toll-free: 00801 86 1011 toll-free: 00801 60 1256 toll-free: 00801 651 227
Thailand International Access Code: 001 Country Code: 66	Technical Support (Optiplex, Latitude, and Precision) Technical Support (PowerEdge and PowerVault) Customer Service (Penang, Malaysia) Sales	toll-free: 1800 0060 07 toll-free: 1800 0600 09 604 633 4949 toll-free: 0880 060 09

Country (City) International Access Code Country Code City Code	Department Name or Service Area, Website and E-Mail Address	Area Codes, Local Numbers, and Toll-Free Numbers
Trinidad/Tobago	General Support	1-800-805-8035
Turks and Caicos Islands	General Support	toll-free: 1-866-540-3355
U.K. (Bracknell)	Website: support.euro.dell.com	
International Access Code: 00	Customer Care website: support.euro.dell.com/uk/en/ECare/Form/Home.asp	
Country Code: 44		
City Code: 1344	E-mail: dell_direct_support@dell.com	
	Technical Support (Corporate/Preferred Accounts/PAD [1000+ employees])	0870 908 0500
	Technical Support (direct/PAD and general)	0870 908 0800
	Global Accounts Customer Care	01344 373 186
	Home and Small Business Customer Care	0870 906 0010
	Corporate Customer Care	01344 373 185
	Preferred Accounts (500–5000 employees) Customer Care	0870 906 0010
	Central Government Customer Care	01344 373 193
	Local Government & Education Customer Care	01344 373 199
	Health Customer Care	01344 373 194
	Home and Small Business Sales	0870 907 4000
	Corporate/Public Sector Sales	01344 860 456
	Home and Small Business Fax	0870 907 4006
Uruguay	General Support	toll-free: 000-413-598-2521

Country (City) International Access Code Country Code City Code	Department Name or Service Area, Website and E-Mail Address	Area Codes, Local Numbers, and Toll-Free Numbers
U.S.A. (Austin, Texas)	Automated Order-Status Service	toll-free: 1-800-433-9014
International Access Code: 011 Country Code: 1	AutoTech (portable and desktop computers) Consumer (Home and Home Office) Technical Support Customer Service DellNet™ Service and Support	toll-free: 1-800-247-9362 toll-free: 1-800-624-9896 toll-free: 1-800-624-9897 toll-free: 1-877-Dellnet (1-877-335-5638)
	Employee Purchase Program (EPP) Customers Financial Services website: www.dellfinancialservices.com Financial Services (lease/loans) Financial Services (Dell Preferred Accounts [DPA])	toll-free: 1-800-695-8133 toll-free: 1-877-577-3355 toll-free: 1-800-283-2210
	Business Customer Service and Technical Support Employee Purchase Program (EPP) Customers Printers and Projectors Technical Support Public (government, education, and healthcare) Customer Service and Technical Support Employee Purchase Program (EPP) Customers Dell Sales	toll-free: 1-800-822-8965 toll-free: 1-800-695-8133 toll-free: 1-877-459-7298 toll-free: 1-800-456-3355 toll-free: 1-800-234-1490 toll-free: 1-800-289-3355 or toll-free: 1-800-879-3355
	Dell Outlet Store (Dell refurbished computers) Software and Peripherals Sales Spare Parts Sales Extended Service and Warranty Sales Fax Dell Services for the Deaf, Hard-of-Hearing, or Speech-Impaired	toll-free: 1-888-798-7561 toll-free: 1-800-671-3355 toll-free: 1-800-357-3355 toll-free: 1-800-247-4618 toll-free: 1-800-727-8320 toll-free: 1-877-DELLTTY (1-877-335-5889)
U.S. Virgin Islands	General Support	1-877-673-3355
Venezuela	General Support	8001-3605

Appendix

U.S. Terms and Conditions of Sale

These terms and conditions (“Agreement”) apply to your purchase of computer systems and/or related products and/or services and support sold in the United States (“Product”) by the Dell entity named on the invoice or acknowledgement (“Dell”) provided to you. By accepting delivery of the Product, you accept and are bound to the terms and conditions of this Agreement. If you do not wish to be bound by this Agreement, you must notify Dell immediately and return your purchase pursuant to Dell’s Total Satisfaction Return Policy.

(See: <http://support.dell.com/ContactUs/ByPhone.aspx?c=us&l=en&s=gen> for our contact information.) If returned, Product(s) must remain in the boxes in which they were shipped. THIS AGREEMENT SHALL APPLY UNLESS (I) YOU HAVE A SEPARATE PURCHASE AGREEMENT WITH DELL, IN WHICH CASE THE SEPARATE AGREEMENT SHALL GOVERN; OR (II) OTHER DELL TERMS AND CONDITIONS APPLY TO THE TRANSACTION.

1 Other Documents.

This Agreement may NOT be altered, supplemented, or amended by the use of any other document(s) unless otherwise agreed to in a written agreement signed by both you and Dell. If you do not receive an invoice or acknowledgement in the mail, via e-mail, or with your Product, information about your purchase may be obtained at <https://support.dell.com/dellcare/Invoice.aspx> or by contacting your sales representative.

2 Payment Terms; Orders; Quotes; Interest.

Payment terms are within Dell’s sole discretion, and, unless otherwise agreed to by Dell, payment must be made at the time of purchase. Payment for Product may be made by credit card, wire transfer, or some other prearranged payment method. Dell may invoice parts of an order separately. Your order is subject to cancellation by Dell, at Dell’s sole discretion. Unless you and Dell have agreed to a different discount, Dell’s standard pricing policy for Dell-branded systems, which include both hardware and services in one discounted price, allocates the discount off list price applicable to the service portion of the system to be equal to the overall calculated percentage discount off list price on the entire system. Dell is not responsible for pricing, typographical, or other errors, in any offer by Dell and reserves the right to cancel any orders resulting from such errors.

3 Shipping Charges; Taxes; Title; Risk of Loss.

Shipping and handling are additional unless otherwise expressly indicated at the time of sale. Loss or damage that occurs during shipping by a carrier selected by Dell is Dell’s responsibility. Loss or damage that occurs during shipping by a carrier selected by you is your responsibility. You must notify Dell within 30 days of the date of your invoice or acknowledgement if you believe any part of your purchase is missing, wrong or damaged. Unless you provide Dell with a valid and correct tax exemption certificate applicable to your purchase of Product and the Product ship-to location, you are responsible for sales and other taxes associated with the order. Shipping dates are estimates only. Title to software will remain with the applicable licensor(s).

4 Warranties.

THE LIMITED WARRANTIES APPLICABLE TO DELL-BRANDED HARDWARE PRODUCT CAN BE FOUND AT <http://www.dell.com/policy/legal/warranty.htm> OR IN THE DOCUMENTATION DELL PROVIDES WITH THE PRODUCT. DELL MAKES NO WARRANTIES FOR SERVICE, SOFTWARE, OR NON-DELL BRANDED PRODUCT. SUCH PRODUCT IS PROVIDED BY DELL “AS IS.” WARRANTY AND SERVICE FOR NON-DELL BRANDED PRODUCT, IF ANY, IS PROVIDED BY THE ORIGINAL MANUFACTURER, NOT BY DELL. DELL

MAKES NO EXPRESS WARRANTIES EXCEPT THOSE STATED IN DELL'S APPLICABLE WARRANTY STATEMENT IN EFFECT ON THE DATE OF THE INVOICE, PACKING SLIP OR ACKNOWLEDGEMENT. WARRANTIES AND SERVICE WILL BE EFFECTIVE, AND DELL WILL BE OBLIGATED TO HONOR ANY SUCH WARRANTIES AND SERVICES, ONLY UPON DELL'S RECEIPT OF PAYMENT IN FULL FOR THE ITEM TO BE WARRANTED OR SERVICED.

5 Software.

All software is provided subject to the license agreement that is part of the software package and you agree that you will be bound by such license agreement.

6 Return Policies; Exchanges.

New and refurbished Product that you purchase directly from Dell (and not a third party) you may return or exchange only in accordance with Dell's return policy in effect on the date of the invoice or acknowledgement. Any returns or exchanges will be made in accordance with Dell's exchange policies in effect on the date of the return or exchange. You must contact us directly before you attempt to return Product to obtain a Return Material Authorization Number for you to include with your return. You must return Product to us in their original or equivalent packaging. You are responsible for risk of loss, shipping and handling fees for returning or exchanging Product. Additional fees may apply. Dell's return policy for Dell-branded Product can be found at:

<http://www.dell.com/policy/legal/warranty.htm>. Non-Dell branded software and peripheral return policies can be found at: http://rcommerce.us.dell.com/rcomm/include/dw_policies.htm.

Refurbished Product return policies can be found at:

http://www.dell.com/us/en/dfh/topics/segtopic_nav_info_002_info.htm. If you fail to follow the return or exchange instructions and policies provided by Dell, Dell is not responsible whatsoever for Product that is lost, damaged, modified or otherwise processed for disposal or resale. If you are returning all components in an order, you will be credited the full amount paid for the order. At Dell's discretion, credit for partial returns may be less than invoice or individual component prices due to bundled or promotional pricing.

7 Changed or Discontinued Product.

Dell's policy is one of ongoing update and revision. Dell may revise and discontinue Product at any time without notice to you and this may affect information saved in your online "cart." Dell will ship Product that has the functionality and performance of the Product ordered, but changes between what is shipped and what is described in a specification sheet or catalog are possible. Parts used in repairing or servicing Product may be new, equivalent-to-new, or reconditioned.

8 Service and Support.

Service offerings may vary from Product to Product. If you purchase optional services and support from Dell, Dell and/or your third-party service provider will provide such service and support to you in the United States in accordance with the terms and conditions located at

http://www.dell.com/us/en/gen/services/service_service_contracts.htm or as mailed to you. You may contact Dell for more information, see <http://www1.us.dell.com/content/topics/segtopic.aspx/contact/contact?c=us&l=en&s=gen> for contact information. Dell and/or the third-party service provider may at their discretion, revise their general and optional service and support programs and the terms and conditions that govern them without prior notice to you. Dell has no obligation to provide service or support until Dell has received full payment for the Product or service/support contract you purchased. Dell is not obligated to provide service or support you purchase through a third party and not Dell.

9 Limitation of Liability.

DELL DOES NOT ACCEPT LIABILITY BEYOND THE REMEDIES SET FORTH HEREIN, INCLUDING BUT NOT LIMITED TO ANY LIABILITY FOR PRODUCT NOT BEING AVAILABLE FOR USE, LOST PROFITS, LOSS OF BUSINESS OR FOR LOST OR CORRUPTED DATA OR SOFTWARE, OR THE PROVISION OF SERVICES AND SUPPORT. EXCEPT AS EXPRESSLY PROVIDED HEREIN, DELL WILL NOT BE LIABLE FOR ANY CONSEQUENTIAL, SPECIAL, INDIRECT, OR PUNITIVE DAMAGES, EVEN IF ADVISED OF THE POSSIBILITY OF SUCH DAMAGES, OR FOR ANY CLAIM BY ANY THIRD PARTY. YOU AGREE THAT FOR

ANY LIABILITY RELATED TO THE PURCHASE OF PRODUCT, DELL IS NOT LIABLE OR RESPONSIBLE FOR ANY AMOUNT OF DAMAGES ABOVE THE AMOUNT INVOICED FOR THE APPLICABLE PRODUCT. NOTWITHSTANDING ANYTHING IN THIS AGREEMENT TO THE CONTRARY, THE REMEDIES SET FORTH IN THIS AGREEMENT SHALL APPLY EVEN IF SUCH REMEDIES FAIL THEIR ESSENTIAL PURPOSE. DELL IS NOT LIABLE TO YOU FOR WARRANTIES, SUPPORT, OR SERVICE MADE BY OR PURCHASED FROM A THIRD PARTY AND NOT DIRECTLY FROM DELL. DELL IS NOT RESPONSIBLE FOR REPRESENTATIONS OR OMISSIONS MADE BY A THIRD PARTY.

10 Applicable Law; Not For Resale or Export.

You agree to comply with all applicable laws and regulations of the various states and of the United States. You agree and represent that you are buying only for your own internal use only, and not for resale or export. Dell has separate terms and conditions governing resale of Product by third parties and transactions outside the United States. Terms and conditions for resale are located at: <http://www.dell.com/policy/legal/termsofsale.htm>.

11 Governing Law.

THIS AGREEMENT AND ANY SALES THERE UNDER SHALL BE GOVERNED BY THE LAWS OF THE STATE OF TEXAS, WITHOUT REGARD TO CONFLICTS OF LAWS RULES.

12 Headings.

The section headings used herein are for convenience of reference only and do not form a part of these terms and conditions, and no construction or inference shall be derived there from.

13 Binding Arbitration.

ANY CLAIM, DISPUTE, OR CONTROVERSY (WHETHER IN CONTRACT, TORT, OR OTHERWISE, WHETHER PREEXISTING, PRESENT OR FUTURE, AND INCLUDING STATUTORY, COMMON LAW, INTENTIONAL TORT AND EQUITABLE CLAIMS) BETWEEN CUSTOMER AND DELL, its agents, employees, principals, successors, assigns, affiliates (collectively for purposes of this paragraph, "Dell") arising from or relating to this Agreement, its interpretation, or the breach, termination or validity thereof, the relationships which result from this Agreement (including, to the full extent permitted by applicable law, relationships with third parties who are not signatories to this Agreement), Dell's advertising, or any related purchase SHALL BE RESOLVED EXCLUSIVELY AND FINALLY BY BINDING ARBITRATION ADMINISTERED BY THE NATIONAL ARBITRATION FORUM (NAF) under its Code of Procedure then in effect (available via the Internet at <http://www.arb-forum.com> → , or via telephone at 1-800-474-2371). The arbitration will be limited solely to the dispute or controversy between customer and Dell. NEITHER CUSTOMER NOR DELL SHALL BE ENTITLED TO JOIN OR CONSOLIDATE CLAIMS BY OR AGAINST OTHER CUSTOMERS, OR ARBITRATE ANY CLAIM AS A REPRESENTATIVE OR CLASS ACTION OR IN A PRIVATE ATTORNEY GENERAL CAPACITY. This transaction involves interstate commerce, and this provision shall be governed by the Federal Arbitration Act 9 U.S.C. sec. 1-16 (FAA). Any award of the arbitrator(s) shall be final and binding on each of the parties, and may be entered as a judgment in any court of competent jurisdiction. Dell will be responsible for paying any arbitration filing fees and fees required to obtain a hearing to the extent such fees exceed the amount of the filing fee for initiating a claim in the court of general jurisdiction in the state in which you reside. Each party shall pay for its own costs and attorneys' fees, if any. However, if any party prevails on a statutory claim that affords the prevailing party attorneys' fees, or if there is a written agreement providing for fees, the Arbitrator may award reasonable fees to the prevailing party, under the standards for fee shifting provided by law. Information may be obtained and claims may be filed with the NAF at P.O. Box 50191, Minneapolis, MN 55405. (REV 4/04)

Limited Warranties and Return Policy

Dell-branded hardware products purchased in the U.S. or Canada come with either a 90-day, 1-year, 2-year, 3-year, or 4-year limited warranty depending on the product purchased. To determine which warranty came with your hardware product(s), see your packing slip or invoice. The following sections describe the limited warranties for the U.S., the limited warranties for Canada, the manufacturer guarantee for Latin America and the Caribbean, and the Intel® Pentium® and Celeron® warranty for the U.S. and Canada.

Limited Warranty for Dell-Branded Hardware Products (U.S. Only)

What is covered by this limited warranty?

This limited warranty covers defects in materials and workmanship in your—our end-user customer's—Dell-branded hardware products, including Dell-branded peripheral products.

What is not covered by this limited warranty?

This limited warranty does not cover:

- Software, including the operating system and software added to the Dell-branded hardware products through our factory-integration system, third-party software, or the reloading of software
- Non-Dell-branded and Solution Provider Direct products and accessories
- Problems that result from:
 - External causes such as accident, abuse, misuse, or problems with electrical power
 - Servicing not authorized by Dell
 - Usage that is not in accordance with product instructions
 - Failure to follow the product instructions or failure to perform preventive maintenance
 - Problems caused by using accessories, parts, or components not supplied by Dell
- Products with missing or altered Service Tags or serial numbers
- Products for which Dell has not received payment

THIS WARRANTY GIVES YOU SPECIFIC LEGAL RIGHTS, AND YOU MAY ALSO HAVE OTHER RIGHTS WHICH VARY FROM STATE TO STATE (OR JURISDICTION TO JURISDICTION). DELL'S RESPONSIBILITY FOR MALFUNCTIONS AND DEFECTS IN HARDWARE IS LIMITED TO REPAIR AND REPLACEMENT AS SET FORTH IN THIS WARRANTY STATEMENT. ALL EXPRESS AND IMPLIED WARRANTIES FOR THE PRODUCT, INCLUDING BUT NOT LIMITED TO ANY IMPLIED WARRANTIES AND CONDITIONS OF MERCHANTABILITY AND FITNESS FOR A PARTICULAR PURPOSE, ARE LIMITED IN TIME TO THE TERM OF THE LIMITED WARRANTY PERIOD REFLECTED ON YOUR PACKING SLIP OR INVOICE. NO WARRANTIES, WHETHER EXPRESS OR IMPLIED, WILL APPLY AFTER THE LIMITED WARRANTY PERIOD HAS EXPIRED. SOME STATES DO NOT ALLOW LIMITATIONS ON HOW LONG AN IMPLIED WARRANTY LASTS, SO THIS LIMITATION MAY NOT APPLY TO YOU.

WE DO NOT ACCEPT LIABILITY BEYOND THE REMEDIES PROVIDED FOR IN THIS LIMITED WARRANTY OR FOR CONSEQUENTIAL OR INCIDENTAL DAMAGES, INCLUDING, WITHOUT LIMITATION, ANY LIABILITY FOR THIRD-PARTY CLAIMS AGAINST YOU FOR DAMAGES, FOR PRODUCTS NOT BEING AVAILABLE FOR USE, OR FOR LOST DATA OR LOST SOFTWARE. OUR LIABILITY WILL BE NO MORE THAN THE AMOUNT YOU PAID FOR THE PRODUCT THAT IS THE SUBJECT OF A CLAIM. THIS IS THE MAXIMUM AMOUNT FOR WHICH WE ARE RESPONSIBLE.

SOME STATES DO NOT ALLOW THE EXCLUSION OR LIMITATION OF INCIDENTAL OR CONSEQUENTIAL DAMAGES, SO THE ABOVE LIMITATION OR EXCLUSION MAY NOT APPLY TO YOU.

How long does this limited warranty last?

This limited warranty lasts for the time period indicated on your packing slip or invoice, except for the following Dell-branded hardware:

- Portable computer batteries carry a 1-year limited warranty.
- Projector lamps carry a 90-day limited warranty.
- Memory carries a lifetime limited warranty.
- Monitors carry the longer of either a 3-year limited warranty or the remainder of the warranty for the Dell computer to which the monitor will be connected.
- PDAs, MP3 players, earphones, remote inline controls, and AC adapters carry a 1-year limited warranty.
- Other add-on hardware carries the longer of either a 1-year limited warranty for new parts and a 90-day limited warranty for reconditioned parts or, for both new and reconditioned parts, the remainder of the warranty for the Dell computer on which such parts are installed.

The limited warranty on all Dell-branded products begins on the date of the packing slip or invoice. The warranty period is not extended if we repair or replace a warranted product or any parts. Dell may change the availability of limited warranties, at its discretion, but any changes will not be retroactive.

What do I do if I need warranty service?

Before the warranty expires, please call us at the relevant number listed in the following table. Please also have your Dell Service Tag or order number available.

Web Support	support.dell.com/ContactUs/ContactUsHome.aspx?c=us&l=en&s=gen
Individual Home Consumers:	U.S. Only
Technical Support	1-800-624-9896
Customer Service	1-800-624-9897
Individual Home Consumers who purchased through an Employee Purchase Program:	
Technical Support and Customer Service	1-800-822-8965
Home and Small Business Commercial Customers:	
Technical Support and Customer Service	1-800-456-3355
Medium, Large, or Global Commercial Customers, Healthcare Customers, and Value-Added Resellers (VARs):	
Technical Support and Customer Service	1-877-459-7278
Government and Education Customers:	
Technical Support and Customer Service	1-877-459-7278
Dell-Branded Memory	1-888-363-5150

What will Dell do?

During the 90 days of the 90-day limited warranty and the first year of all other limited warranties: During the 90 days of the 90-day limited warranty and the first year of all other limited warranties, we will repair any Dell-branded hardware products returned to us that prove to be defective in materials or workmanship. If we are not able to repair the product, we will replace it with a comparable product that is new or refurbished.

When you contact us, we will issue a Return Material Authorization Number for you to include with your return. You must return the products to us in their original or equivalent packaging, prepay shipping charges, and insure the shipment or accept the risk if the product is lost or damaged in shipment. We will return the repaired or replacement products to you. We will pay to ship the repaired or replaced products to you if you use an address in the United States (excluding Puerto Rico and U.S. possessions and territories). Otherwise, we will ship the product to you freight collect.

If we determine that the product is not covered under this warranty, we will notify you and inform you of service alternatives that are available to you on a fee basis.

NOTE: Before you ship the product(s) to us, make sure to back up the data on the hard drive(s) and any other storage device(s) in the product(s). Remove any confidential, proprietary, or personal information and removable media such as floppy disks, CDs, or PC Cards. We are not responsible for any of your confidential, proprietary, or personal information; lost or corrupted data; or damaged or lost removable media.

During the remaining years: For the remaining period of the limited warranty, we will replace any defective part with new or refurbished parts, if we agree that it needs to be replaced. When you contact us, we will require a valid credit card number at the time you request a replacement part, but we will not charge you for the replacement part as long as you return the original part to us within 30 days after we ship the replacement part to you. If we do not receive the original part within 30 days, we will charge to your credit card the then-current standard price for that part.

We will pay to ship the part to you if you use an address in the United States (excluding Puerto Rico and U.S. possessions and territories). Otherwise, we will ship the part freight collect. We will also include a prepaid shipping container with each replacement part for your use in returning the replaced part to us.

NOTE: Before you replace parts, make sure to back up the data on the hard drive(s) and any other storage device(s) in the product(s). We are not responsible for lost or corrupted data.

What if I purchased a service contract?

If your service contract is with Dell, service will be provided to you under the terms of the service agreement. Please refer to that contract for details on how to obtain service.

If you purchased through us a service contract with one of our third-party service providers, please refer to that contract for details on how to obtain service.

How will you fix my product?

We use new and refurbished parts made by various manufacturers in performing warranty repairs and in building replacement parts and systems. Refurbished parts and systems are parts or systems that have been returned to Dell, some of which were never used by a customer. All parts and systems are inspected and tested for quality. Replacement parts and systems are covered for the remaining period of the limited warranty for the product you bought. Dell owns all parts removed from repaired products.

May I transfer the limited warranty?

Limited warranties on systems may be transferred if the current owner transfers ownership of the system and records the transfer with us. The limited warranty on Dell-branded memory may not be transferred. You may record your transfer by going to Dell's website:

- If you are an Individual Home Consumer, go to www.dell.com/us/en/dhs/topics/sbtopic_015_ccare.htm

- If you are a Home Office, Small, Medium, Large, or Global Commercial Customer, go to www.dell.com/us/en/biz/topics/sbtopic_ccare_nav_015_ccare.htm
- If you are a Government, Education, or Healthcare Customer, or an Individual Home Consumer who purchased through an Employee Purchase Program, go to www.dell.com/us/en/pub/topics/sbtopic_015_ccare.htm

If you do not have Internet access, call your customer care representative or call 1-800-624-9897.

All requests to transfer ownership are at Dell's sole discretion. All such transfers will be subject to the terms and conditions of the original service or limited warranty agreement and Dell's terms and conditions of sale located at www.dell.com. Dell cannot guarantee the authenticity of the products, limited warranties, service or support, or the accuracy of the listings of products you purchase from a third party.

Total Satisfaction Return Policy (U.S. Only)

We value our relationship with you and want to make sure that you are satisfied with your purchases. That is why we offer a Total Satisfaction return policy for most products that you, the end-user customer, purchase directly from Dell. Under this policy, you may return to Dell products that you purchased directly from Dell for a credit or a refund of the purchase price paid, less shipping and handling and applicable return fees as follows:

New Hardware Products and Accessories — Unless you have a separate agreement with Dell, all hardware, accessories, peripherals, parts, and unopened software still in its sealed package, excluding the products listed below, may be returned within twenty-one (21) days from the date on the packing slip or invoice. New Dell PowerEdge™, PowerConnect™, and PowerVault™ products may be returned within thirty (30) days from the date on the packing slip or invoice except that new PowerEdge SC servers and n series products purchased from the Small and Medium Business Sales Division may only be returned within fourteen (14) days from the date on the packing slip or invoice. To return applications software or an operating system that has been installed by Dell, you must return the entire computer. A different return policy applies to nondefective products purchased through Dell's Software and Peripherals division by customers of our Small and Medium Business divisions. Those products may be returned within twenty-one (21) days from the date on the packing slip or invoice, but a fifteen percent (15%) return fee will be deducted from any refund or credit. The Total Satisfaction Return Policy and Software and Peripherals division return policy are not available for Dell | EMC storage products, EMC-branded products, Unisys-branded products, PowerVault™, 160T tape libraries, enterprise software, non-Dell branded enterprise products, software and/or software licenses purchased under any type of volume purchase agreement or any non-Dell customized hardware and/or software product(s).

Reconditioned or Refurbished Dell-Branded Hardware Products and Parts — All reconditioned or refurbished PowerEdge, PowerConnect, and PowerVault products may be returned within thirty (30) days from the date on the packing slip or invoice. All other reconditioned or refurbished Dell-branded hardware products and parts may be returned within fourteen (14) days of the date on the packing slip or invoice.

How to Return — To return products, e-mail or call Dell customer service to receive a Credit Return Authorization Number within the return policy period applicable to the product you want to return. You must obtain a Credit Return Authorization Number in order to return the product. See “Contacting Dell” or “Getting Help” in your customer documentation (or go to www.dell.com/us/en/gen/contact.htm) to find the appropriate contact information for obtaining customer assistance.

You must ship the products to Dell within five (5) days of the date that Dell issues the Credit Return Authorization Number. You must also return the products to Dell in their original packaging, in as-new condition along with any media, documentation, and all other items that were included in the original shipment, prepay shipping charges, and insure the shipment or accept the risk of loss or damage during shipment.

NOTE: Before you ship the product(s) to us, make sure to back up the data on the hard drive(s) and any other storage device(s) in the product(s). Remove any confidential, proprietary, or personal information and removable media such as floppy disks, CDs, or PC Cards. We are not responsible for any of your confidential, proprietary, or personal information; lost or corrupted data; or damaged or lost removable media.

Limited Warranty Terms for Dell-Branded Hardware Products (Canada Only)

What is covered by this limited warranty?

This limited warranty covers defects in materials and workmanship in your—our end-user customer's—Dell-branded hardware products, including Dell-branded peripheral products.

What is not covered by this limited warranty?

This limited warranty does not cover:

- Software, including the operating system and software added to the Dell-branded hardware products through our factory-integration system, or the reloading of the software
- Non-Dell branded and Solution Provider Direct products and accessories
- Problems that result from:
 - External causes such as accident, abuse, misuse, or problems with electrical power
 - Servicing not authorized by Dell
 - Usage that is not in accordance with product instructions
 - Failure to follow the product instructions or failure to perform preventive maintenance
 - Problems caused by using accessories, parts, or components not supplied by Dell
- Products with missing or altered Service Tags or serial numbers
- Products for which Dell has not received payment

THIS WARRANTY GIVES YOU SPECIFIC LEGAL RIGHTS, AND YOU MAY ALSO HAVE OTHER RIGHTS WHICH VARY FROM PROVINCE TO PROVINCE. DELL'S RESPONSIBILITY FOR MALFUNCTIONS AND DEFECTS IN PRODUCT IS LIMITED TO REPAIR AND REPLACEMENT AS SET FORTH IN THIS WARRANTY STATEMENT, FOR THE TERM OF THE WARRANTY PERIOD REFLECTED ON YOUR PACKING SLIP OR INVOICE. EXCEPT FOR THE EXPRESS WARRANTIES CONTAINED IN THIS WARRANTY STATEMENT, DELL DISCLAIMS ALL OTHER WARRANTIES AND CONDITIONS, EXPRESS OR IMPLIED, INCLUDING WITHOUT LIMITATION IMPLIED WARRANTIES AND CONDITIONS OF MERCHANTABILITY AND FITNESS FOR A PARTICULAR PURPOSE, STATUTORY OR OTHERWISE. SOME PROVINCES DO NOT ALLOW THE EXCLUSION OF CERTAIN IMPLIED WARRANTIES OR CONDITIONS, OR LIMITATIONS ON HOW LONG AN IMPLIED WARRANTY OR CONDITION LASTS. THEREFORE, THE FOREGOING EXCLUSIONS AND LIMITATIONS MAY NOT APPLY TO YOU.

WE DO NOT ACCEPT LIABILITY BEYOND THE REMEDIES PROVIDED FOR IN THIS WARRANTY STATEMENT OR FOR SPECIAL, INDIRECT, CONSEQUENTIAL, OR INCIDENTAL DAMAGES, INCLUDING, WITHOUT LIMITATION, ANY LIABILITY FOR THIRD-PARTY CLAIMS AGAINST YOU FOR DAMAGES, FOR PRODUCTS NOT BEING AVAILABLE FOR USE, OR FOR LOST DATA OR LOST SOFTWARE. OUR LIABILITY WILL BE NO MORE THAN THE AMOUNT YOU PAID FOR THE PRODUCT THAT IS THE SUBJECT OF A CLAIM. THIS IS THE MAXIMUM AMOUNT FOR WHICH WE ARE RESPONSIBLE.

SOME PROVINCES DO NOT ALLOW THE EXCLUSION OR LIMITATION OF SPECIAL, INDIRECT, INCIDENTAL, OR CONSEQUENTIAL DAMAGES, SO THE ABOVE LIMITATION OR EXCLUSION MAY NOT APPLY TO YOU.

How long does this limited warranty last?

This limited warranty lasts for the time period indicated on your packing slip or invoice, except that the limited warranty on Dell-branded batteries lasts only 1 year and the limited warranty on the lamps for Dell-branded projectors lasts only 90 days. The limited warranty begins on the date of the packing slip or invoice. The warranty period is not extended if

we repair or replace a warranted product or any parts. Dell may change the terms and availability of limited warranties, at its discretion, but any changes will not be retroactive (that is, the warranty terms in place at the time of purchase will apply to your purchase).

What do I do if I need warranty service?

Before the warranty expires, please call us at the relevant number listed in the following table. Please also have your Dell Service Tag or order number available.

Web Support	support.dell.com/ContactUs/ContactUsHome.aspx?c=us&l=en&s=gen
Individual Home Consumers; Home Office and Small Business Customers:	Canada Only
Technical Support and Customer Service	1-800-847-4096
Medium, Large, and Global Commercial Customers; Government, Education, and Healthcare Customers; and Value-Added Resellers (VARs):	
Technical Support	1-800-387-5757
Customer Service	1-800-326-9463
Government or Education Customers, or Individual Home Consumers who purchased through an Employee Purchase Program:	
Technical Support	1-800-387-5757
Customer Service	1-800-326-9463 (Extension 8221 for Individual Consumers)
Dell-Branded Memory	1-888-363-5150

What will Dell do?

During the 90 days of the 90-day limited warranty and the first year of all other limited warranties: During the 90 days of the 90-day limited warranty and the first year of all other limited warranties, we will repair any Dell-branded hardware products returned to us that prove to be defective in materials or workmanship. If we are not able to repair the product, we will replace it with a comparable product that is new or refurbished.

When you contact us, we will issue a Return Material Authorization Number for you to include with your return. You must return the products to us in their original or equivalent packaging, prepay shipping charges, and insure the shipment or accept the risk if the product is lost or damaged in shipment. We will return the repaired or replacement products to you. We will pay to ship the repaired or replaced products to you if you use an address in Canada. Otherwise, we will ship the product to you freight collect.

If we determine that the problem is not covered under this warranty, we will notify you and inform you of service alternatives that are available to you on a fee basis.

NOTE: Before you ship the product(s) to us, make sure to back up the data on the hard drive(s) and any other storage device(s) in the product(s). Remove any confidential, proprietary, or personal information and removable media such as floppy disks, CDs, or PC Cards. We are not responsible for any of your confidential, proprietary, or personal information; lost or corrupted data; or damaged or lost removable media.

During the remaining years following the first year of all limited warranties: We will replace any defective part with new or refurbished parts, if we agree that it needs to be replaced. When you contact us, we will require a valid credit card number at the time you request a replacement part, but we will not charge you for the replacement part as long as you return the original part to us within 30 days after we ship the replacement part to you. If we do not receive the original part within 30 days, we will charge to your credit card the then-current standard price for that part.

We will pay to ship the part to you if you use an address in Canada. Otherwise, we will ship the part freight collect. We will also include a prepaid shipping container with each replacement part for your use in returning the replaced part to us.

NOTE: Before you replace parts, make sure to back up the data on the hard drive(s) and any other storage device(s) in the product(s). We are not responsible for lost or corrupted data.

What if I purchased a service contract?

If your service contract is with Dell, service will be provided to you under the terms of the service contract. Please refer to that contract for details on how to obtain service. Dell's service contracts can be found online at www.dell.ca or by calling Customer Care at 1-800-847-4096. If you purchased through us a service contract with one of our third-party service providers, please refer to that contract (mailed to you with your packing slip or invoice) for details on how to obtain service.

How will you fix my product?

We use new and refurbished parts made by various manufacturers in performing warranty repairs and in building replacement parts and systems. Refurbished parts and systems are parts or systems that have been returned to Dell, some of which were never used by a customer. All parts and systems are inspected and tested for quality. Replacement parts and systems are covered for the remaining period of the limited warranty for the product you bought. Dell owns all parts removed from repaired products.

May I transfer the limited warranty?

Limited warranties on systems may be transferred if the current owner transfers ownership of the system and records the transfer with us. The limited warranty on Dell-branded memory may not be transferred. You may record your transfer by going to Dell's website.

- For Canada-purchased computers (in-country transfers) and to transfer from one customer to another, go to www.dell.ca/ca/en/gen/topics/segtopic_ccare_nav_013_ccare.htm
- For out-of-country transfers (outside of the original country of purchase), go to www.dell.com/us/en/biz/topics/sbtopic_ccare_nav_016_ccare.htm

If you do not have Internet access, call Dell at 1-800-847-4096 (Home Consumer customers) or 1-800-326-9463 (Corporate Commercial or Government customers).

All requests to transfer ownership are at Dell's sole discretion. All such transfers will be subject to the terms and conditions of the original service or limited warranty agreement and Dell's terms and conditions of sale located at www.dell.com. Dell cannot guarantee the authenticity of the products, limited warranties, service or support, or the accuracy of the listings of products you purchase from a third party.

Total Satisfaction Return Policy (Canada Only)

If you are an end-user customer who bought new products directly from Dell, you may return them to Dell up to 30 days after you receive them for a refund or credit of the product purchase price. If you are an end-user customer who bought reconditioned or refurbished products from Dell, you may return them to Dell within 14 days after the date on the packing slip or invoice for a refund or credit of the product purchase price. In either case, the refund or credit will not include any shipping and handling charges shown on your packing slip or invoice and will be subject to a fifteen percent (15%) restocking fee, unless otherwise prohibited by law. If you are an organization that bought the products under a written agreement with Dell, the agreement may contain different terms for the return of products than specified by this policy.

To return products, you must call Dell Customer Service at 1-800-847-4096 to receive a Credit Return Authorization Number. To expedite the process of your refund or credit, Dell expects you to return the products to Dell in their original packaging within 5 days of the date that Dell issues the Credit Return Authorization Number. You must also prepay shipping charges and insure the shipment or accept the risk of loss or damage during shipment. You may return software for a refund or credit only if the sealed package containing the diskette(s) or CD(s) is unopened. Returned products must be in as-new condition, and all of the manuals, diskette(s), CD(s), power cables, and other items included with a product must be returned with it. For customers who want to return, for refund or credit only, either application or operating system software that has been installed by Dell, the whole system must be returned, along with any media and documentation that may have been included in the original shipment.

The “Total Satisfaction” Return Policy does not apply to Dell | EMC storage products. It also does not apply to products purchased through Dell's Software and Peripherals division. For those products, please instead refer to Dell's Software and Peripheral's then-current return policy (see the following section, “Dell Software and Peripherals [Canada Only]”).

Dell Software and Peripherals (Canada Only)

Third-Party Software and Peripherals Products

Similar to other resellers of software and peripherals, Dell does not warrant third-party products. Third-party software and peripheral products are covered by the warranties provided by the original manufacturer or publisher only. Third-party manufacturer warranties vary from product to product. Consult your product documentation for specific warranty information. More information may also be available from the manufacturer or publisher.

While Dell offers a wide selection of software and peripheral products, we do not specifically test or guarantee that all of the products we offer work with any or all of the various models of Dell computers, nor do we test or guarantee all of the products we sell on the hundreds of different brands of computers available today. If you have questions about compatibility, we recommend and encourage you to contact the third-party software and peripheral product manufacturer or publisher directly.

Dell-Branded Peripheral Products

Dell does provide a limited warranty for new Dell-branded peripheral products (products for which Dell is listed as the manufacturer) such as monitors, batteries, memory, docking stations, and projectors. To determine which limited warranty applies to the product you purchased, see the Dell packing slip or invoice and/or the product documentation that accompanied your product. Descriptions of Dell's limited warranties are described in preceding sections.

1-Year End-User Manufacturer Guarantee (Latin America and the Caribbean Only)

Guarantee

Dell Inc. ("Dell") warrants to the end user in accordance with the following provisions that its branded hardware products, purchased by the end user from a Dell company or an authorized Dell distributor in Latin America or the Caribbean, will be free from defects in materials, workmanship, and design affecting normal use, for a period of 1 year from the original purchase date. Products for which proper claims are made will, at Dell's option, be repaired or replaced at Dell's expense. Dell owns all parts removed from repaired products. Dell uses new and reconditioned parts made by various manufacturers in performing repairs and building replacement products.

Exclusions

This Guarantee does not apply to defects resulting from: improper or inadequate installation, use, or maintenance; actions or modifications by unauthorized third parties or the end user; accidental or willful damage; or normal wear and tear.

Making a Claim

Claims must be made in Latin America or the Caribbean by contacting the Dell point of sale within the guarantee period. The end user must always supply proof of purchase, indicating name and address of the seller, date of purchase, model and serial number, name and address of the customer, and details of symptoms and configuration at the time of malfunction, including peripherals and software used. Otherwise, Dell may refuse the guarantee claim. Upon diagnosis of a warranted defect, Dell will make arrangements and pay for ground freight and insurance to and from Dell's repair/replacement center. The end user must ensure that the defective product is available for collection properly packed in original or equally protective packaging together with the details listed above and the return number provided to the end user by Dell.

Limitation and Statutory Rights

Dell makes no other warranty, guarantee or like statement other than as explicitly stated above, and this Guarantee is given in place of all other guarantees whatsoever, to the fullest extent permitted by law. In the absence of applicable legislation, this Guarantee will be the end user's sole and exclusive remedy against Dell or any of its affiliates, and neither Dell nor any of its affiliates shall be liable for loss of profit or contracts, or any other indirect or consequential loss arising from negligence, breach of contract, or howsoever.

This Guarantee does not impair or affect mandatory statutory rights of the end user against and/or any rights resulting from other contracts concluded by the end user with Dell and/or any other seller.

Dell World Trade LP

One Dell Way, Round Rock, TX 78682, USA

Dell Computadores do Brasil Ltda (CNPJ No. 72.381.189/0001-10)

Avenida Industrial Belgraf, 400
92990-000 - Eldorado do Sul - RS - Brasil

Dell Computer de Chile Ltda

Coyancura 2283, Piso 3- Of.302,
Providencia, Santiago - Chile

Dell Computer de Colombia Corporation

Carrera 7 #115-33 Oficina 603
Bogota, Colombia

Dell Computer de Mexico SA de CV
Paseo de la Reforma 2620 - 11° Piso
Col. Lomas Altas
11950 México, D.F.

Dell™ Photo Print Pack Limited Warranties

Dell™ Photo Print Pack Limited Warranty (U.S. and Canada Only)

Dell Inc. warrants to the original purchaser of genuine Dell Photo Print Pack(s) that the Dell Photo Print Pack(s) will be free from defects in material and workmanship for two years beginning on the date of invoice. If this product proves defective in either material or workmanship, the defective portion will be replaced without charge during the limited warranty period if returned to Dell. You must first call our toll-free number to get your return authorization. In the U.S., call 1-800-822- 8965; in Canada, call 1-800-387-5757. If we are not able to replace the product because it has been discontinued or is not available, we will either replace it with a comparable product or reimburse you for the product purchase cost, at Dell's sole option. This limited warranty does not apply to any portion of Dell Photo Print Pack(s) that have been improperly stored or due to problems resulting from misuse, abuse, accident, neglect, mishandling, incorrect environments, or wear from ordinary use.

THIS WARRANTY GIVES YOU SPECIFIC LEGAL RIGHTS, AND YOU MAY ALSO HAVE OTHER RIGHTS WHICH VARY FROM STATE TO STATE (OR JURISDICTION TO JURISDICTION). DELL'S RESPONSIBILITY FOR MALFUNCTIONS AND DEFECTS IN HARDWARE IS LIMITED TO REPLACEMENT AS SET FORTH IN THIS WARRANTY STATEMENT. FOR CANADIAN CUSTOMERS, EXCEPT FOR THE EXPRESS WARRANTIES CONTAINED IN THIS WARRANTY STATEMENT, DELL DISCLAIMS ALL OTHER WARRANTIES AND CONDITIONS, EXPRESS OR IMPLIED, STATUTORY OR OTHERWISE, FOR THE PRODUCT. FOR U.S. CUSTOMERS, ALL EXPRESS AND IMPLIED WARRANTIES FOR THE PRODUCT, INCLUDING BUT NOT LIMITED TO ANY IMPLIED WARRANTIES AND CONDITIONS OF MERCHANTABILITY AND FITNESS FOR A PARTICULAR PURPOSE ARE LIMITED IN TIME TO THE TERM OF THIS LIMITED WARRANTY. NO WARRANTIES, WHETHER EXPRESS OR IMPLIED, WILL APPLY AFTER THE LIMITED WARRANTY PERIOD HAS EXPIRED. SOME STATES OR JURISDICTIONS DO NOT ALLOW THE EXCLUSION OF CERTAIN IMPLIED WARRANTIES OR CONDITIONS, OR LIMITATIONS ON HOW LONG AN IMPLIED WARRANTY OR CONDITION LASTS, SO THIS LIMITATION MAY NOT APPLY TO YOU. THIS WARRANTY COVERAGE TERMINATES IF YOU SELL OR OTHERWISE TRANSFER THIS PRODUCT TO ANOTHER PARTY. DELL DOES NOT ACCEPT LIABILITY BEYOND THE REMEDIES PROVIDED FOR IN THIS LIMITED WARRANTY OR FOR SPECIAL, INDIRECT, CONSEQUENTIAL OR INCIDENTAL DAMAGES, INCLUDING, WITHOUT LIMITATION, ANY LIABILITY FOR THIRD-PARTY CLAIMS AGAINST YOU FOR DAMAGES, FOR PRODUCTS NOT BEING AVAILABLE FOR USE, OR FOR LOST DATA OR LOST SOFTWARE. DELL'S LIABILITY WILL BE NO MORE THAN THE AMOUNT YOU PAID FOR THE PRODUCT THAT IS THE SUBJECT OF A CLAIM. THIS IS THE MAXIMUM AMOUNT FOR WHICH DELL IS RESPONSIBLE. SOME STATES OR JURISDICTIONS DO NOT ALLOW THE EXCLUSION OR LIMITATION OF SPECIAL, INDIRECT, INCIDENTAL OR CONSEQUENTIAL DAMAGES, SO THE ABOVE LIMITATION OR EXCLUSION MAY NOT APPLY TO YOU.

Dell™ Photo Print Pack Limited Warranty (Latin America Only)

Dell Inc. warrants to the original purchaser of genuine Dell Photo Print Pack(s) that the Dell Photo Print Pack(s) will be free from defects resulting from material or manufacturing process for two years beginning on the date of invoice.

If this product presents defects resulting from either material or manufacturing process, the defective portion will be replaced without charge during the limited warranty period if returned to Dell.

In order to obtain the necessary information to enable the replacement, call the appropriate toll-free number. In Mexico, call 001-877-533-6230; in Puerto Rico, call 1-877-839-5123. In cases in which either the product has been discontinued or is not available, Dell reserves the right, at its sole discretion, to choose between replacing it by a similar product or reimbursing you for the purchase cost. This limited warranty does not apply to any portion of Dell Photo Print Pack(s) that have been improperly stored or due to problems resulting from misuse, abuse, accident, neglect, mishandling, incorrect environments, or wear from ordinary use.

Dell's liability for the malfunction or defect of hardware after the period of the legal warranty (and specifically the period of the legal warranty of defective products stated in the consumer protections rules), is limited to either the substitution of the product or the reimbursement as stated above. This warranty coverage terminates if you sell or otherwise transfer this product to a third party.

Dell does not accept any additional liability for patrimonial, emotional or any other kind of damage caused to the consumer and/or to a third party, which exceeds the established liability either in this limited warranty or in legal rules that may apply.

Regulatory Notices

Electromagnetic Interference (EMI) is any signal or emission, radiated in free space or conducted along power or signal leads, that endangers the functioning of a radio navigation or other safety service or seriously degrades, obstructs, or repeatedly interrupts a licensed radio communications service. Radio communications services include but are not limited to AM/FM commercial broadcast, television, cellular services, radar, air-traffic control, pager, and Personal Communication Services (PCS). These licensed services, along with unintentional radiators such as digital devices, including computers, contribute to the electromagnetic environment.

Electromagnetic Compatibility (EMC) is the ability of items of electronic equipment to function properly together in the electronic environment. While this computer has been designed and determined to be compliant with regulatory agency limits for EMI, there is no guarantee that interference will not occur in a particular installation. If this equipment does cause interference with radio communications services, which can be determined by turning the equipment off and on, you are encouraged to try to correct the interference by one or more of the following measures:

- Reorient the receiving antenna.
- Relocate the computer with respect to the receiver.
- Move the computer away from the receiver.
- Plug the computer into a different outlet so that the computer and the receiver are on different branch circuits.

If necessary, consult a Dell Technical Support representative or an experienced radio/television technician for additional suggestions.

For additional regulatory information, see the *User's Guide* that accompanied your computer.

NOM Information (Mexico Only)

The following information is provided on the device(s) described in this document in compliance with the requirements of the official Mexican standards (NOM):

Exporter:	Dell Inc. One Dell Way Round Rock, TX 78682
Importer:	Dell Computer de México, S.A. de C.V. Paseo de la Reforma 2620 - 11° Piso Col. Lomas Altas 11950 México, D.F.
Ship to:	Dell Computer de México, S.A. de C.V. al Cuidado de Kuehne & Nagel de México S. de R.L. Avenida Soles No. 55 Co. Peñon de los Baños 15520 México, D.F.
Model No.:	540
Supply voltage:	90V to 260V AC
Frequency:	50/60 Hz
Current consumption:	50 watts maximum
Output voltage:	24 V DC
Output current:	2.5 A

Dell™ Software License Agreement

This is a legal agreement between you, the user, and Dell Products, L.P. (“Dell”). This agreement covers all software that is distributed with the Dell product, for which there is no separate license agreement between you and the manufacturer or owner of the software (collectively the “Software”). By opening or breaking the seal on the Software packet(s), installing or downloading the Software, or using the Software that has been preloaded or is embedded in your computer, you agree to be bound by the terms of this agreement. If you do not agree to these terms, promptly return all Software items (disks, written materials, and packaging) and delete any preloaded or embedded Software.

You may use one copy of the Software on only one computer at a time. If you have multiple licenses for the Software, you may use as many copies at any time as you have licenses. “Use” means loading the Software in temporary memory or permanent storage on the computer. Installation on a network server solely for distribution to other computers is not “use” if (but only if) you have a separate license for each computer to which the Software is distributed. You must ensure that the number of persons using the Software installed on a network server does not exceed the number of licenses that you have. If the number of users of Software installed on a network server will exceed the number of licenses, you must purchase additional licenses until the number of licenses equals the number of users before allowing additional users to use the Software. If you are a commercial customer of Dell or a Dell affiliate, you hereby grant Dell, or an agent selected by Dell, the right to perform an audit of your use of the Software during normal business hours, you agree to cooperate with Dell in such audit, and you agree to provide Dell with all records reasonably related to your use of the Software. The audit will be limited to verification of your compliance with the terms of this agreement.

The Software is protected by United States copyright laws and international treaties. You may make one copy of the Software solely for backup or archival purposes or transfer it to a single hard disk provided you keep the original solely for backup or archival purposes. You may not rent or lease the Software or copy the written materials accompanying the Software, but you may transfer the Software and all accompanying materials on a permanent basis if you retain no copies

and the recipient agrees to the terms hereof. Any transfer must include the most recent update and all prior versions. You may not reverse engineer, decompile or disassemble the Software. If the package accompanying your computer contains compact discs, 3.5" and/or 5.25" disks, you may use only the disks appropriate for your computer. You may not use the disks on another computer or network, or loan, rent, lease, or transfer them to another user except as permitted by this agreement.

Limited Warranty

Dell warrants that the Software disks will be free from defects in materials and workmanship under normal use for ninety (90) days from the date you receive them. This warranty is limited to you and is not transferable. Any implied warranties are limited to ninety (90) days from the date you receive the Software. Some jurisdictions do not allow limits on the duration of an implied warranty, so this limitation may not apply to you. The entire liability of Dell and its suppliers, and your exclusive remedy, shall be (a) return of the price paid for the Software or (b) replacement of any disk not meeting this warranty that is sent with a return authorization number to Dell, at your cost and risk. This limited warranty is void if any disk damage has resulted from accident, abuse, misapplication, or service or modification by someone other than Dell. Any replacement disk is warranted for the remaining original warranty period or thirty (30) days, whichever is longer.

Dell does NOT warrant that the functions of the Software will meet your requirements or that operation of the Software will be uninterrupted or error free. You assume responsibility for selecting the Software to achieve your intended results and for the use and results obtained from the Software.

DELL, ON BEHALF OF ITSELF AND ITS SUPPLIERS, DISCLAIMS ALL OTHER WARRANTIES, EXPRESS OR IMPLIED, INCLUDING, BUT NOT LIMITED TO, IMPLIED WARRANTIES OF MERCHANTABILITY AND FITNESS FOR A PARTICULAR PURPOSE, FOR THE SOFTWARE AND ALL ACCOMPANYING WRITTEN MATERIALS. This limited warranty gives you specific legal rights; you may have others, which vary from jurisdiction to jurisdiction.

IN NO EVENT SHALL DELL OR ITS SUPPLIERS BE LIABLE FOR ANY DAMAGES WHATSOEVER (INCLUDING, WITHOUT LIMITATION, DAMAGES FOR LOSS OF BUSINESS PROFITS, BUSINESS INTERRUPTION, LOSS OF BUSINESS INFORMATION, OR OTHER PECUNIARY LOSS) ARISING OUT OF USE OR INABILITY TO USE THE SOFTWARE, EVEN IF ADVISED OF THE POSSIBILITY OF SUCH DAMAGES. Because some jurisdictions do not allow an exclusion or limitation of liability for consequential or incidental damages, the above limitation may not apply to you.

U.S. Government Restricted Rights

The software and documentation are "commercial items" as that term is defined at 48 C.F.R. 2.101, consisting of "commercial computer software" and "commercial computer software documentation" as such terms are used in 48 C.F.R. 12.212. Consistent with 48 C.F.R. 12.212 and 48 C.F.R. 227.7202-1 through 227.7202-4, all U.S. Government end users acquire the software and documentation with only those rights set forth herein. Contractor/manufacturer is Dell Products, L.P., One Dell Way, Round Rock, Texas 78682.

General

This license is effective until terminated. It will terminate upon the conditions set forth above or if you fail to comply with any of its terms. Upon termination, you agree that the Software and accompanying materials, and all copies thereof, will be destroyed. This agreement is governed by the laws of the State of Texas. Each provision of this agreement is severable. If a provision is found to be unenforceable, this finding does not affect the enforceability of the remaining provisions, terms, or conditions of this agreement. This agreement is binding on successors and assigns. Dell agrees and you agree to waive, to the maximum extent permitted by law, any right to a jury trial with respect to the Software or this agreement. Because this waiver may not be effective in some jurisdictions, this waiver may not apply to

you. You acknowledge that you have read this agreement, that you understand it, that you agree to be bound by its terms, and that this is the complete and exclusive statement of the agreement between you and Dell regarding the Software.

Printer Specifications

Printing process	Thermal dye transfer
Operating environment (for optimum photo quality)	Temperature: 50 to 95 °F (10 to 35 °C) Humidity: 10% to 86% RH
Power	Output: 24V DC Input: 90V to 132V AC @ 50/60 Hz, connection via in-line AC power adapter (US and Canada only) 90V to 260V AC @ 50/60 Hz, connection via AC power adapter (all other countries) Consumption while printing: 50 watts maximum
Print speed	Standalone: 75 sec. for first print (< 60 sec. for prints 2-5) Via computer: 60 sec. (< 60 sec. for prints 2-5) NOTE: Print speed is dependent on photo size, number of continuous prints, and environmental conditions.
Size (Depth, width, height)	Without paper tray: 5.4 x 7.4 x 3.2 in. (137 x 189 x 81 mm)
	With paper tray: 13.2 x 7.4 x 3.2 in. (336 x 189 x 81 mm)
Weight	Without paper tray: 2.69 lbs (1.22 Kg)
	With paper tray: 3.2 lbs (1.45 Kg)
Print size	4 x 6 in. (102 x 152 mm)
Photo paper size	4 x 7.25 in. (102 x 184 mm) with perforated tabs
Photo resolution	300 ppi, continuous tone

Index

B

buttons, operator panel
Arrows, 11
Cancel, 11
Menu, 11
Power, 11
Print B&W, 12

C

Cancel button, 11
canceling printing, 27
changing settings, 17
color, automatic
correction, 27
computer
printing from, 26
cooling vents, 35-36
Copy (Select mode)
button, 11

D

Dell
contacting, 39

L

loading
photo cartridge, 14
photo paper, 15

M

maintenance, 29

P

photo cartridge
loading, 14
photo paper
loading, 15
photos
automatic color correction, 27
printing
canceling, 27
from a computer, 26
problems, 33
without a computer, 21

S

safety information, 9
settings, changing, 17
setup, 14
support
contacting Dell, 39

T

troubleshooting
printing, 33
transfer/communication, 36

V

vents, cooling, 35-36

W

warranty, 60

Free Manuals Download Website

<http://myh66.com>

<http://usermanuals.us>

<http://www.somanuals.com>

<http://www.4manuals.cc>

<http://www.manual-lib.com>

<http://www.404manual.com>

<http://www.luxmanual.com>

<http://aubethermostatmanual.com>

Golf course search by state

<http://golfingnear.com>

Email search by domain

<http://emailbydomain.com>

Auto manuals search

<http://auto.somanuals.com>

TV manuals search

<http://tv.somanuals.com>