

Dell™ Axim™ X51/X51v
Owner's Manual

www.dell.com | support.dell.com

Notes, Notices, and Cautions



NOTE: A NOTE indicates important information that helps you make better use of your computer.



NOTICE: A NOTICE indicates either potential damage to hardware or loss of data and tells you how to avoid the problem.



CAUTION: A CAUTION indicates a potential for property damage, personal injury, or death.

Abbreviations and Acronyms

For a complete list of abbreviations and acronyms, see the "Glossary" on page 135.

**Information in this document is subject to change without notice.
© 2006 Dell Inc. All rights reserved.**

Reproduction in any manner whatsoever without the written permission of Dell Inc. is strictly forbidden.

Trademarks used in this text: *Dell*, the *DELL* logo, *Axim*, *TrueMobile*, *Dimension*, *Inspiron*, *OptiPlex*, *Latitude*, *Dell Precision*, *PowerApp*, *PowerVault*, *PowerEdge*, *PowerConnect*, and *DellNet* are trademarks of Dell Inc.; *Intel*, *Pentium*, and *Celeron* are registered trademarks and *XScale* and *StrataFlash* are trademarks of Intel Corporation; *Microsoft*, *Windows*, *Windows Media*, and *ActiveSync* are registered trademarks and *Windows Mobile* is a trademark of Microsoft Corporation; *Bluetooth* is a registered trademark owned by Bluetooth SIG, Inc. and is used by Dell Inc. under license.

Other trademarks and trade names may be used in this document to refer to either the entities claiming the marks and names or their products. Dell Inc. disclaims any proprietary interest in trademarks and trade names other than its own.

Models HC03U, HC03UL, and HD04U

March 2006

P/N NC341

Rev. A02

Contents

Before You Begin	9
Related Information	9
Contacting Dell	10
1 Getting Started	37
Unpacking Your Device	37
Front, Side, and Back Views	39
Front and Side Views	39
Back View	41
Using the Battery	42
Installing and Removing the Battery	42
Charging the Battery	44
Using Your Axim	45
Changing the Display Mode on Your Device	46
2 Operating the Axim	47
Using the Power Button	47
Using the Stylus	47

Connecting to a Computer	48
Using the Cradle	48
Using the Sync Cable	50
Connecting to a Projector	51
Using Cards	52
CompactFlash Cards	52
Secure Digital Memory Cards	53
Resetting the Axim	53
Soft Reset	53
Hard Reset	54
Using Microsoft® Windows Mobile™ Version 5.0 Software for Pocket PC Premium Edition Mobile 5.0	56
Status Icons	56
Programs	57
Program Buttons	57
Switcher Bar	58
Navigation Bar and Command Bar	59
Pop-Up Menus	60
Searching for Information	61
Backing Up Data	62
Backing Up and Synchronization of Data	63
Manual Back Up By Dragging Files	63
Confirming Backup	64

Entering Information	64
Entering Text Using the Input Panel	65
Typing With the Soft Keyboard	66
Letter Recognizer	67
Block Recognizer	67
Transcriber	68
Writing on the Screen	68
Editing Written Text	69
Drawing on the Screen	72
Creating a Drawing	72
Editing a Drawing	73
Recording a Message	73
Using My Text	74
Adjusting Settings	74
Personal Tab	75
System Tab	75
Connections Tab	76
3 Communicating and Scheduling	77
About the Microsoft® ActiveSync® Program	77
Installing and Using ActiveSync	78
About Microsoft® Pocket Outlook	79
Categories	79
Creating a Category	79
Calendar	80
Using the Summary Screen	81
Creating Meeting Requests	81

Contacts	82
Finding a Contact	83
Using the Summary Screen	83
Tasks	83
Notes	85
Messaging	86
Synchronizing E-Mail Messages	86
Connecting Directly to an E-Mail Server	87
Using the Message List	87
Composing Messages	88
Managing E-Mail Messages and Folders	89
Notifications	91
Beaming an Item	91
Using File Explorer	92
4 Getting Connected	93
Using Wi-Fi (802.11b)	93
If the Network Card is Set Up	94
If the Wireless Network is Broadcasting SSID	94
If the Wireless Network is Not Broadcasting SSID	95
Using Odyssey Client	96
Adding a Network	96
Using Cisco® LEAP Wireless LAN Security	98

Using Odyssey Client to Get a Certificate of Authority	99
Using Infrared	100
Using Bluetooth® Wireless Technology	100
Creating a Modem Connection	101
Creating an Ethernet Connection	103
Creating a VPN Connection	103
Ending a Connection	104
Connecting Directly to an E-Mail Server	105
Getting Help on Connecting	105
5 Adding and Removing Programs	107
Adding Programs Using Microsoft® ActiveSync®	107
Downloading Programs From the Internet	108
Adding a Program to the Start Menu	109
Removing Programs	109
6 Using Companion Programs	111
Word Mobile	111
Excel Mobile	113
Tips for Working in Excel Mobile	115

PowerPoint Mobile	115
MSN Messenger	116
Setting Up	117
Working With Contacts	117
Chatting With Contacts	118
Microsoft Windows Media® Player for Pocket PC	118
Using Internet Explorer Mobile	119
Mobile Favorites	119
Conserving Memory	120
Mobile Favorites Folder	120
Favorite Links	121
Browsing Mobile Favorites and the Web	121
7 Maintenance and Troubleshooting	123
Maintaining the Axim	123
Installing the Diagnostic Utility	123
Troubleshooting	124
File Download Security Warning	127
8 Appendix	129
Specifications	129
Glossary	135
Index	137

Before You Begin

Related Information

The following table guides you to the information you are looking for in the relevant device and computer documentation.

What Are You Looking For?	Find It Here:
How to set up my device and information on the accessories, connectors, and buttons on my device	The placemat setup diagram and the <i>Dell™ Owner's Manual</i>
Information on using my device	<i>Dell Owner's Manual</i> and Pocket PC Help NOTE: To view Help, tap the Start button and tap Help .
Additional programs that can be installed on my device	<i>Dell Getting Started</i> CD
Information on using programs on my device	Pocket PC Help and, if available, tap Help within a specific program
Connecting to and synchronizing with a computer	<i>Dell Owner's Manual</i> and Microsoft® ActiveSync® <i>Help</i> on your computer To view <i>Help</i> , launch MS ActiveSync, click Help → Microsoft ActiveSync Help . NOTE: For more ActiveSync help: http://www.microsoft.com/windows/mobile/help/activesync/default.aspx
Last-minute updates and detailed technical information	The readme files, located in the ActiveSync folder on the computer and on the <i>Dell Getting Started</i> CD.
Up-to-date information about your Pocket PC	www.microsoft.com/windowsmobile and support.dell.com

What Are You Looking For?	Find It Here:
My Service Tag and/or Express Service Code	Label located in the battery slot underneath the battery (remove the battery)
Product Key	Located on the COA (Certificate of Authenticity) label on the Getting Started CD

Contacting Dell

To contact Dell electronically, you can access the following websites:

- www.dell.com
- support.dell.com (support)

For specific web addresses for your country, find the appropriate country section in the table below.



NOTE: Toll-free numbers are for use within the country for which they are listed.



NOTE: In certain countries, support specific to Dell XPS™ portable computers is available at a separate telephone number listed for participating countries. If you do not see a telephone number listed that is specific for XPS portable computers, you may contact Dell through the support number listed and your call will be routed appropriately.

When you need to contact Dell, use the electronic addresses, telephone numbers, and codes provided in the following table. If you need assistance in determining which codes to use, contact a local or an international operator.

Country (City) International Access Code Country Code City Code	Department Name or Service Area, Website and E-Mail Address	Area Codes, Local Numbers, and Toll-Free Numbers
Anguilla	General Support	toll-free: 800-335-0031
Antigua and Barbuda	General Support	1-800-805-5924
Argentina (Buenos Aires) International Access Code: 00 Country Code: 54 City Code: 11	Website: www.dell.com.ar E-mail: us_latin_services@dell.com E-mail for desktop and portable computers: la-techsupport@dell.com E-mail for servers and EMC [®] storage products: la_enterprise@dell.com	Customer Care toll-free: 0-800-444-0730 Technical Support toll-free: 0-800-444-0733 Technical Support Services toll-free: 0-800-444-0724 Sales 0-810-444-3355
Aruba	General Support	toll-free: 800-1578
Australia (Sydney) International Access Code: 0011 Country Code: 61 City Code: 2	Website: support.ap.dell.com E-mail: support.ap.dell.com/contactus General Support	13DELL-133355

Country (City) International Access Code Country Code City Code	Department Name or Service Area, Website and E-Mail Address	Area Codes, Local Numbers, and Toll-Free Numbers
Austria (Vienna)	Website: support.euro.dell.com	
International Access Code: 900	E-mail: tech_support_central_europe@dell.com	
Country Code: 43	Home/Small Business Sales	0820 240 530 00
City Code: 1	Home/Small Business Fax	0820 240 530 49
	Home/Small Business Customer Care	0820 240 530 14
	Preferred Accounts/Corporate Customer Care	0820 240 530 16
	Support for XPS portable computers only	0820 240 530 81
	Home/Small Business Support for all other Dell computers	0820 240 530 14
	Preferred Accounts/Corporate Support	0660 8779
	Switchboard	0820 240 530 00
Bahamas	General Support	toll-free: 1-866-278- 6818
Barbados	General Support	1-800-534-3066
Belgium (Brussels)	Website: support.euro.dell.com	
International Access Code: 00	Tech Support for XPS portable computers only	02 481 92 96
Country Code: 32	Tech Support for all other Dell computers	02 481 92 88
City Code: 2	Tech Support Fax	02 481 92 95
	Customer Care	02 713 15 65
	Corporate Sales	02 481 91 00
	Fax	02 481 92 99
	Switchboard	02 481 91 00

Country (City) International Access Code Country Code City Code	Department Name or Service Area, Website and E-Mail Address	Area Codes, Local Numbers, and Toll-Free Numbers
Bermuda	General Support	1-800-342-0671
Bolivia	General Support	toll-free: 800-10-0238
Brazil	Website: www.dell.com/br	
International Access Code: 00	Customer Support, Tech Support	0800 90 3355
Country Code: 55	Technical Support Fax	51 481 5470
City Code: 51	Customer Care Fax	51 481 5480
	Sales	0800 90 3390
British Virgin Islands	General Support	toll-free: 1-866-278-6820
Brunei	Technical Support (Penang, Malaysia)	604 633 4966
Country Code: 673	Customer Care (Penang, Malaysia)	604 633 4888
	Transaction Sales (Penang, Malaysia)	604 633 4955

Country (City) International Access Code Country Code City Code	Department Name or Service Area, Website and E-Mail Address	Area Codes, Local Numbers, and Toll-Free Numbers
Canada (North York, Ontario)	Online Order Status: www.dell.ca/ostatus	
International Access Code: 011	AutoTech (automated Hardware and Warranty Support)	toll-free: 1-800-247-9362
	Customer Service (Home Sales/Small Business)	toll-free: 1-800-847-4096
	Customer Service (med./large business, government)	toll-free: 1-800-326-9463
	Customer Service (printers, projectors, televisions, handhelds, digital jukebox, and wireless)	toll-free: 1-800-847-4096
	Hardware Warranty Support (Home Sales/Small Business)	toll-free: 1-800-906-3355
	Hardware Warranty Support (med./large bus., government)	toll-free: 1-800-387-5757
	Hardware Warranty Support (printers, projectors, televisions, handhelds, digital jukebox, and wireless)	1-877-335-5767
	Sales (Home Sales/Small Business)	toll-free: 1-800-387-5752
	Sales (med./large bus., government)	toll-free: 1-800-387-5755
	Spare Parts Sales & Extended Service Sales	1 866 440 3355
Cayman Islands	General Support	1-800-805-7541
Chile (Santiago)	Sales and Customer Support	toll-free: 1230-020-4823
Country Code: 56		
City Code: 2		

Country (City) International Access Code Country Code City Code	Department Name or Service Area, Website and E-Mail Address	Area Codes, Local Numbers, and Toll-Free Numbers
China (Xiamen) Country Code: 86 City Code: 592	Technical Support website: support.dell.com.cn Technical Support E-mail: cn_support@dell.com Customer Care E-mail: customer_cn@dell.com Technical Support Fax	592 818 1350
	Technical Support (Dell™ Dimension™ and Inspiron)	toll-free: 800 858 2968
	Technical Support (OptiPlex™, Latitude™, and Dell Precision™)	toll-free: 800 858 0950
	Technical Support (servers and storage)	toll-free: 800 858 0960
	Technical Support (projectors, PDAs, switches, routers, and so on)	toll-free: 800 858 2920
	Technical Support (printers)	toll-free: 800 858 2311
	Customer Care	toll-free: 800 858 2060
	Customer Care Fax	592 818 1308
	Home and Small Business	toll-free: 800 858 2222
	Preferred Accounts Division	toll-free: 800 858 2557
	Large Corporate Accounts GCP	toll-free: 800 858 2055
	Large Corporate Accounts Key Accounts	toll-free: 800 858 2628
	Large Corporate Accounts North	toll-free: 800 858 2999
	Large Corporate Accounts North Government and Education	toll-free: 800 858 2955
	Large Corporate Accounts East	toll-free: 800 858 2020

Country (City) International Access Code Country Code City Code	Department Name or Service Area, Website and E-Mail Address	Area Codes, Local Numbers, and Toll-Free Numbers
China (Xiamen) Country Code: 86 City Code: 592 <i>(continued)</i>	Large Corporate Accounts East Government and Education Large Corporate Accounts Queue Team Large Corporate Accounts South Large Corporate Accounts West Large Corporate Accounts Spare Parts	toll-free: 800 858 2669 toll-free: 800 858 2572 toll-free: 800 858 2355 toll-free: 800 858 2811 toll-free: 800 858 2621
Colombia	General Support	980-9-15-3978
Costa Rica	General Support	0800-012-0435
Czech Republic (Prague) International Access Code: 00 Country Code: 420	Website: support.euro.dell.com E-mail: czech_dell@dell.com Technical Support Customer Care Fax Technical Fax Switchboard	 22537 2727 22537 2707 22537 2714 22537 2728 22537 2711

Country (City) International Access Code Country Code City Code	Department Name or Service Area, Website and E-Mail Address	Area Codes, Local Numbers, and Toll-Free Numbers
Denmark (Copenhagen) International Access Code: 00 Country Code: 45	Website: support.euro.dell.com	
	Technical Support for XPS portable computers only	7010 0074
	Technical Support for all other Dell computers	7023 0182
	Customer Care (Relational)	7023 0184
	Home/Small Business Customer Care	3287 5505
	Switchboard (Relational)	3287 1200
	Switchboard Fax (Relational)	3287 1201
	Switchboard (Home/Small Business)	3287 5000
	Switchboard Fax (Home/Small Business)	3287 5001
Dominica	General Support	toll-free: 1-866-278- 6821
Dominican Republic	General Support	1-800-148-0530
Ecuador	General Support	toll-free: 999-119
El Salvador	General Support	01-899-753-0777
Finland (Helsinki) International Access Code: 990 Country Code: 358 City Code: 9	Website: support.euro.dell.com	
	Technical Support	09 253 313 60
	Customer Care	09 253 313 38
	Fax	09 253 313 99
	Switchboard	09 253 313 00

Country (City) International Access Code Country Code City Code	Department Name or Service Area, Website and E-Mail Address	Area Codes, Local Numbers, and Toll-Free Numbers
France (Paris) (Montpellier)	Website: support.euro.dell.com Home and Small Business	
International Access Code: 00	Technical Support for XPS portable computers only	0825 387 129
Country Code: 33	Technical Support for all other Dell computers	0825 387 270
City Codes: (1) (4)	Customer Care	0825 823 833
	Switchboard	0825 004 700
	Switchboard (calls from outside of France)	04 99 75 40 00
	Sales	0825 004 700
	Fax	0825 004 701
	Fax (calls from outside of France)	04 99 75 40 01
	Corporate	
	Technical Support	0825 004 719
	Customer Care	0825 338 339
	Switchboard	01 55 94 71 00
	Sales	01 55 94 71 00
	Fax	01 55 94 71 01

Country (City) International Access Code Country Code City Code	Department Name or Service Area, Website and E-Mail Address	Area Codes, Local Numbers, and Toll-Free Numbers
Germany (Langen) International Access Code: 00 Country Code: 49 City Code: 6103	Website: support.euro.dell.com E-mail: tech_support_central_europe@dell.com Technical Support for XPS portable computers only Technical Support for all other Dell computers Home/Small Business Customer Care Global Segment Customer Care Preferred Accounts Customer Care Large Accounts Customer Care Public Accounts Customer Care Switchboard	06103 766-7222 06103 766-7200 0180-5-224400 06103 766-9570 06103 766-9420 06103 766-9560 06103 766-9555 06103 766-7000
Greece International Access Code: 00 Country Code: 30	Website: support.euro.dell.com Technical Support Gold Service Technical Support Switchboard Gold Service Switchboard Sales Fax	00800-44 14 95 18 00800-44 14 00 83 2108129810 2108129811 2108129800 2108129812
Grenada	General Support	toll-free: 1-866-540-3355
Guatemala	General Support	1-800-999-0136
Guyana	General Support	toll-free: 1-877-270-4609

Country (City) International Access Code Country Code City Code	Department Name or Service Area, Website and E-Mail Address	Area Codes, Local Numbers, and Toll-Free Numbers
Hong Kong	Website: support.ap.dell.com	
International Access Code: 001	Technical Support E-mail: HK_support@Dell.com	
Country Code: 852	Technical Support (Dimension and Inspiron)	2969 3188
	Technical Support (OptiPlex, Latitude, and Dell Precision)	2969 3191
	Technical Support (PowerApp™, PowerEdge™, PowerConnect™, and PowerVault™)	2969 3196
	Customer Care	3416 0910
	Large Corporate Accounts	3416 0907
	Global Customer Programs	3416 0908
	Medium Business Division	3416 0912
	Home and Small Business Division	2969 3105
India	E-mail: india_support_desktop@dell.com india_support_notebook@dell.com india_support_Server@dell.com	
	Technical Support	1600338045 and 1600448046
	Sales (Large Corporate Accounts)	1600 33 8044
	Sales (Home and Small Business)	1600 33 8046

Country (City) International Access Code Country Code City Code	Department Name or Service Area, Website and E-Mail Address	Area Codes, Local Numbers, and Toll-Free Numbers
Ireland (Cherrywood)	Website: support.euro.dell.com E-mail: dell_direct_support@dell.com	
International Access Code: 00	Technical Support for XPS portable computers only	1850 200 722
Country Code: 353	Technical Support for all other Dell computers	1850 543 543
City Code: 1	U.K. Technical Support (dial within U.K. only)	0870 908 0800
	Home User Customer Care	01 204 4014
	Small Business Customer Care	01 204 4014
	U.K. Customer Care (dial within U.K. only)	0870 906 0010
	Corporate Customer Care	1850 200 982
	Corporate Customer Care (dial within U.K. only)	0870 907 4499
	Ireland Sales	01 204 4444
	U.K. Sales (dial within U.K. only)	0870 907 4000
	Fax/Sales Fax	01 204 0103
	Switchboard	01 204 4444

Country (City) International Access Code Country Code City Code	Department Name or Service Area, Website and E-Mail Address	Area Codes, Local Numbers, and Toll-Free Numbers
Italy (Milan)	Website: support.euro.dell.com	
International Access Code: 00	Home and Small Business	
Country Code: 39	Technical Support	02 577 826 90
City Code: 02	Customer Care	02 696 821 14
	Fax	02 696 821 13
	Switchboard	02 696 821 12
	Corporate	
	Technical Support	02 577 826 90
	Customer Care	02 577 825 55
	Fax	02 575 035 30
	Switchboard	02 577 821
Jamaica	General Support (dial from within Jamaica only)	1-800-682-3639

Country (City) International Access Code Country Code City Code	Department Name or Service Area, Website and E-Mail Address	Area Codes, Local Numbers, and Toll-Free Numbers
Japan (Kawasaki)	Website: support.jp.dell.com	
International Access Code: 001	Technical Support (servers)	toll-free: 0120-198-498
Country Code: 81	Technical Support outside of Japan (servers)	81-44-556-4162
City Code: 44	Technical Support (Dimension and Inspiron)	toll-free: 0120-198-226
	Technical Support outside of Japan (Dimension and Inspiron)	81-44-520-1435
	Technical Support (Dell Precision, OptiPlex, and Latitude)	toll-free:0120-198-433
	Technical Support outside of Japan (Dell Precision, OptiPlex, and Latitude)	81-44-556-3894
	Technical Support (PDAs, projectors, printers, routers)	toll-free: 0120-981-690
	Technical Support outside of Japan (PDAs, projectors, printers, routers)	81-44-556-3468
	Faxbox Service	044-556-3490
	24-Hour Automated Order Service	044-556-3801
	Customer Care	044-556-4240
	Business Sales Division (up to 400 employees)	044-556-1465
	Preferred Accounts Division Sales (over 400 employees)	044-556-3433
	Large Corporate Accounts Sales (over 3500 employees)	044-556-3430

Country (City) International Access Code Country Code City Code	Department Name or Service Area, Website and E-Mail Address	Area Codes, Local Numbers, and Toll-Free Numbers
Japan (Kawasaki) International Access Code: 001 Country Code: 81 City Code: 44 (continued)	Public Sales (government agencies, educational institutions, and medical institutions)	044-556-1469
	Global Segment Japan	044-556-3469
	Individual User	044-556-1760
	Switchboard	044-556-4300
Korea (Seoul) International Access Code: 001 Country Code: 82 City Code: 2	E-mail: krsupport@dell.com	
	Support	toll-free: 080-200-3800
	Support (Dimension, PDA, Electronics and Accessories)	toll-free: 080-200-3801
	Sales	toll-free: 080-200-3600
	Fax	2194-6202
	Switchboard	2194-6000
Latin America	Customer Technical Support (Austin, Texas, U.S.A.)	512 728-4093
	Customer Service (Austin, Texas, U.S.A.)	512 728-3619
	Fax (Technical Support and Customer Service) (Austin, Texas, U.S.A.)	512 728-3883
	Sales (Austin, Texas, U.S.A.)	512 728-4397
	SalesFax (Austin, Texas, U.S.A.)	512 728-4600 or 512 728-3772
Luxembourg	Website: support.euro.dell.com	
	Support	342 08 08 075
	Home/Small Business Sales	+32 (0)2 713 15 96
	Corporate Sales	26 25 77 81
	Customer Care	+32 (0)2 481 91 19
	Fax	26 25 77 82

Country (City) International Access Code Country Code City Code	Department Name or Service Area, Website and E-Mail Address	Area Codes, Local Numbers, and Toll-Free Numbers
Macao Country Code: 853	Technical Support	toll-free: 0800 105
	Customer Service (Xiamen, China)	34 160 910
	Transaction Sales (Xiamen, China)	29 693 115
Malaysia (Penang)	Website: support.ap.dell.com	
International Access Code: 00 Country Code: 60 City Code: 4	Technical Support (Dell Precision, OptiPlex, and Latitude)	toll-free: 1 800 880 193
	Technical Support (Dimension, Inspiron, and Electronics and Accessories)	toll-free: 1 800 881 306
	Technical Support (PowerApp, PowerEdge, PowerConnect, and PowerVault)	toll-free: 1800 881 386
	Customer Care	toll-free: 1800 881 306 (option 6)
	Transaction Sales	toll-free: 1 800 888 202
	Corporate Sales	toll-free: 1 800 888 213
Mexico International Access Code: 00 Country Code: 52	Customer Technical Support	001-877-384-8979 or 001-877-269-3383
	Sales	50-81-8800 or 01-800-888-3355
	Customer Service	001-877-384-8979 or 001-877-269-3383
	Main	50-81-8800 or 01-800-888-3355
	General Support	toll-free: 1-866-278-6822
Netherlands Antilles	General Support	001-800-882-1519

Country (City) International Access Code Country Code City Code	Department Name or Service Area, Website and E-Mail Address	Area Codes, Local Numbers, and Toll-Free Numbers
Netherlands (Amsterdam)	Website: support.euro.dell.com	
International Access Code: 00	Technical Support for XPS portable computers only	020 674 45 94
Country Code: 31	Technical Support for all other Dell computers	020 674 45 00
City Code: 20	Technical Support Fax	020 674 47 66
	Home/Small Business Customer Care	020 674 42 00
	Relational Customer Care	020 674 4325
	Home/Small Business Sales	020 674 55 00
	Relational Sales	020 674 50 00
	Home/Small Business Sales Fax	020 674 47 75
	Relational Sales Fax	020 674 47 50
	Switchboard	020 674 50 00
	Switchboard Fax	020 674 47 50

Country (City) International Access Code Country Code City Code	Department Name or Service Area, Website and E-Mail Address	Area Codes, Local Numbers, and Toll-Free Numbers
New Zealand	Website: support.ap.dell.com	
International Access Code: 00	E-mail: support.ap.dell.com/contactus	
Country Code: 64	General Support	0800 441 567
Nicaragua	General Support	001-800-220-1006
Norway (Lysaker)	Website: support.euro.dell.com	
International Access Code: 00	Technical Support for XPS portable computers only	815 35 043
Country Code: 47	Technical Support for all other Dell products	671 16882
	Relational Customer Care	671 17575
	Home/Small Business Customer Care	23162298
	Switchboard	671 16800
	Fax Switchboard	671 16865
Panama	General Support	001-800-507-0962
Peru	General Support	0800-50-669
Poland (Warsaw)	Website: support.euro.dell.com	
International Access Code: 011	E-mail: pl_support_tech@dell.com	
Country Code: 48	Customer Service Phone	57 95 700
City Code: 22	Customer Care	57 95 999
	Sales	57 95 999
	Customer Service Fax	57 95 806
	Reception Desk Fax	57 95 998
	Switchboard	57 95 999

Country (City) International Access Code Country Code City Code	Department Name or Service Area, Website and E-Mail Address	Area Codes, Local Numbers, and Toll-Free Numbers
Portugal	Website: support.euro.dell.com	
International Access Code: 00	Technical Support	707200149
Country Code: 351	Customer Care	800 300 413
	Sales	800 300 410 or 800 300 411 or 800 300 412 or 21 422 07 10
	Fax	21 424 01 12
Puerto Rico	General Support	1-800-805-7545
St. Kitts and Nevis	General Support	toll-free: 1-877-441-4731
St. Lucia	General Support	1-800-882-1521
St. Vincent and the Grenadines	General Support	toll-free: 1-877-270-4609
Singapore (Singapore)	Website: support.ap.dell.com	
International Access Code: 005	Technical Support (Dimension, Inspiron, and Electronics and Accessories)	toll-free: 1800 394 7430
Country Code: 65	Technical Support (OptiPlex, Latitude, and Dell Precision)	toll-free: 1800 394 7488
	Technical Support (PowerApp, PowerEdge, PowerConnect, and PowerVault)	toll-free: 1800 394 7478
	Customer Care	toll-free: 1 800 394 7430 (option 6)
	Transaction Sales	toll-free: 1 800 394 7412
	Corporate Sales	toll-free: 1 800 394 7419

Country (City) International Access Code Country Code City Code	Department Name or Service Area, Website and E-Mail Address	Area Codes, Local Numbers, and Toll-Free Numbers
Slovakia (Prague)	Website: support.euro.dell.com	
International Access Code: 00	E-mail: czech_dell@dell.com	
Country Code: 421	Technical Support	02 5441 5727
	Customer Care	420 22537 2707
	Fax	02 5441 8328
	Tech Fax	02 5441 8328
	Switchboard (Sales)	02 5441 7585
South Africa (Johannesburg)	Website: support.euro.dell.com	
International Access Code:	E-mail: dell_za_support@dell.com	
09/091	Gold Queue	011 709 7713
Country Code: 27	Technical Support	011 709 7710
City Code: 11	Customer Care	011 709 7707
	Sales	011 709 7700
	Fax	011 706 0495
	Switchboard	011 709 7700
Southeast Asian and Pacific Countries	Technical Support, Customer Service, and Sales (Penang, Malaysia)	604 633 4810

Country (City) International Access Code Country Code City Code	Department Name or Service Area, Website and E-Mail Address	Area Codes, Local Numbers, and Toll-Free Numbers
Spain (Madrid)	Website: support.euro.dell.com	
International Access Code: 00	Home and Small Business	
Country Code: 34	Technical Support	902 100 130
City Code: 91	Customer Care	902 118 540
	Sales	902 118 541
	Switchboard	902 118 541
	Fax	902 118 539
	Corporate	
	Technical Support	902 100 130
	Customer Care	902 115 236
	Switchboard	91 722 92 00
	Fax	91 722 95 83
Sweden (Upplands Vasby)	Website: support.euro.dell.com	
International Access Code: 00	Technical Support for XPS portable computers only	0771 340 340
Country Code: 46	Technical Support for all other Dell products	08 590 05 199
City Code: 8	Relational Customer Care	08 590 05 642
	Home/Small Business Customer Care	08 587 70 527
	Employee Purchase Program (EPP) Support	20 140 14 44
	Technical Support Fax	08 590 05 594
	Sales	08 590 05 185

Country (City) International Access Code Country Code City Code	Department Name or Service Area, Website and E-Mail Address	Area Codes, Local Numbers, and Toll-Free Numbers
Switzerland (Geneva) International Access Code: 00 Country Code: 41 City Code: 22	Website: support.euro.dell.com E-mail: Tech_support_central_Europe@ dell.com Technical Support for XPS portable computers only Technical Support (Home and Small Business) for all other Dell products Technical Support (Corporate) Customer Care (Home and Small Business) Customer Care (Corporate) Fax Switchboard	0848 33 88 57 0844 811 411 0844 822 844 0848 802 202 0848 821 721 022 799 01 90 022 799 01 01
Taiwan International Access Code: 002 Country Code: 886	Website: support.ap.dell.com E-mail: ap_support@dell.com Technical Support (OptiPlex, Latitude, Inspiron, Dimension, and Electronics and Accessories) Technical Support (PowerApp, PowerEdge, PowerConnect, and PowerVault) Customer Care Transaction Sales Corporate Sales	toll-free: 00801 86 1011 toll-free: 00801 60 1256 toll-free: 00801 60 1250 (option 5) toll-free: 00801 65 1228 toll-free: 00801 651 227

Country (City) International Access Code Country Code City Code	Department Name or Service Area, Website and E-Mail Address	Area Codes, Local Numbers, and Toll-Free Numbers
Thailand	Website: support.ap.dell.com	
International Access Code: 001	Technical Support (OptiPlex, Latitude, and Dell Precision)	toll-free: 1800 0060 07
Country Code: 66	Technical Support (PowerApp, PowerEdge, PowerConnect, and PowerVault)	toll-free: 1800 0600 09
	Customer Care	toll-free: 1800 006 007 (option 7)
	Corporate Sales	toll-free: 1800 006 009
	Transaction Sales	toll-free: 1800 006 006
Trinidad/Tobago	General Support	1-800-805-8035
Turks and Caicos Islands	General Support	toll-free: 1-866-540-3355

Country (City) International Access Code Country Code City Code	Department Name or Service Area, Website and E-Mail Address	Area Codes, Local Numbers, and Toll-Free Numbers
U.K. (Bracknell)	Website: support.euro.dell.com	
International Access Code: 00	Customer Care website: support.euro.dell.com/uk/en/ECare/Form/Home.asp	
Country Code: 44	E-mail: dell_direct_support@dell.com	
City Code: 1344	Technical Support (Corporate/Preferred Accounts/PAD [1000+ employees])	0870 908 0500
	Technical Support for XPS portable computers only	0870 366 4180
	Technical Support (direct and general) for all other products	0870 908 0800
	Global Accounts Customer Care	01344 373 186
	Home and Small Business Customer Care	0870 906 0010
	Corporate Customer Care	01344 373 185
	Preferred Accounts (500–5000 employees) Customer Care	0870 906 0010
	Central Government Customer Care	01344 373 193
	Local Government & Education Customer Care	01344 373 199
	Health Customer Care	01344 373 194
	Home and Small Business Sales	0870 907 4000
	Corporate/Public Sector Sales	01344 860 456
	Home and Small Business Fax	0870 907 4006
Uruguay	General Support	toll-free: 000-413-598- 2521

Country (City) International Access Code Country Code City Code	Department Name or Service Area, Website and E-Mail Address	Area Codes, Local Numbers, and Toll-Free Numbers
U.S.A. (Austin, Texas) International Access Code: 011 Country Code: 1	Automated Order-Status Service	toll-free: 1-800-433-9014
	AutoTech (portable and desktop computers)	toll-free: 1-800-247-9362
	Hardware and Warranty Support (Dell TV, Printers, and Projectors) for Relationship customers	toll-free 1-877-459-7298
	Americas Consumer XPS support	toll-free: 1-800-232-8544
	Consumer (Home and Home Office) Support for all other Dell products	toll-free: 1-800-624-9896
	Customer Service	toll-free: 1-800-624-9897
	Employee Purchase Program (EPP) Customers	toll-free: 1-800-695-8133
	Financial Services website: www.dellfinancialservices.com	
	Financial Services (lease/loans)	toll-free: 1-877-577-3355
	Financial Services (Dell Preferred Accounts [DPA])	toll-free: 1-800-283-2210
	Business	
	Customer Service and Support	toll-free: 1-800-456-3355
	Employee Purchase Program (EPP) Customers	toll-free: 1-800-695-8133
	Support for printers, projectors, PDAs, and MP3 players	toll-free: 1-877-459-7298
Public (government, education, and healthcare)		

Country (City) International Access Code Country Code City Code	Department Name or Service Area, Website and E-Mail Address	Area Codes, Local Numbers, and Toll-Free Numbers
U.S.A. (Austin, Texas) International Access Code: 011 Country Code: 1 <i>(continued)</i>	Customer Service and Support	toll-free: 1-800-456-3355
	Employee Purchase Program (EPP) Customers	toll-free: 1-800-695-8133
	Dell Sales	toll-free: 1-800-289-3355
		or toll-free: 1-800-879- 3355
	Dell Outlet Store (Dell refurbished computers)	toll-free: 1-888-798-7561
	Software and Peripherals Sales	toll-free: 1-800-671-3355
	Spare Parts Sales	toll-free: 1-800-357-3355
	Extended Service and Warranty Sales	toll-free: 1-800-247-4618
Fax	toll-free: 1-800-727-8320	
Dell Services for the Deaf, Hard- of-Hearing, or Speech-Impaired	toll-free: 1-877- DELLITY (1-877-335-5889)	
U.S. Virgin Islands	General Support	1-877-673-3355
Venezuela	General Support	8001-3605

Getting Started

Dell Axim X51 and Dell Axim X51v are Dell's newest PDAs (Personal Digital Assistant). Axim X51 refers to the low and mid configurations while Axim X51v refers to the high configuration which has VGA support. See the table for "Accessories" on page 37. The Axim X51/X51v offers:

- built-in wireless (for Mid and High configurations only)
- QVGA and VGA screens
- Small size and weight
- VGA output on Axim X51v

Unpacking Your Device

Your Axim PDA comes with standard accessories and some extra items depending on the model you purchased. Your device packaging contains important information such as the product key on the *Getting Started* CD cover and the order number on the packing slip. Ensure that you note these down for later use.

While unpacking your device for the first time, check for the following list of items. If you find any item missing, contact Dell support. See, "Contacting Dell" on page 10.

Accessories			
Contents	High	Mid	Low
Axim X51	624 MHz, Wireless, Bluetooth	520 MHz, Wireless, Bluetooth	416 MHz, Bluetooth
Cradle	Standard	Standard	Optional
USB Sync cable	Optional	Optional	Standard
Adapter Connector	Standard	Standard	Standard
standard carrying case	Standard	Standard	Standard
Dell Owner's Manual	Standard	Standard	Standard

Accessories

Contents	High	Mid	Low
Dell Getting Started CD	Standard	Standard	Standard
AC adapter & power cable	Standard	Standard	Standard
standard battery (1100 mAH)	Standard	Standard	Standard
High capacity battery (2200 mAH)	Optional	Optional	Optional
Screen Protector	Optional	Optional	Optional

Optional: Needs to be ordered separately.

See the following illustration for the standard and optional accessories.

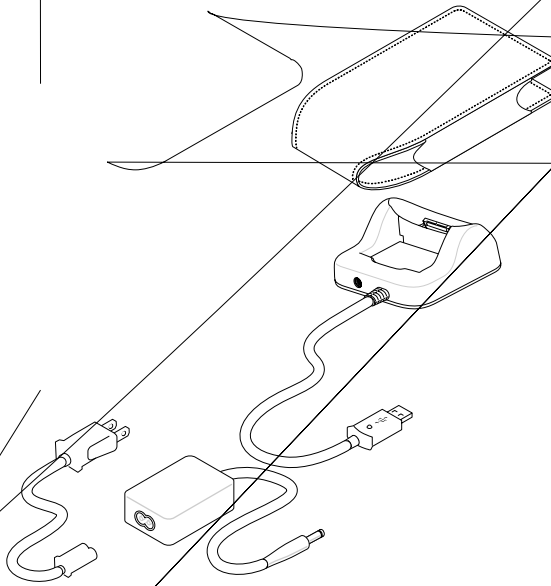

Front, Side, and Back Views

CAUTION: Before performing any of the procedures in this section, read and follow the safety instructions in the *Product Information Guide*.

Front and Side Views

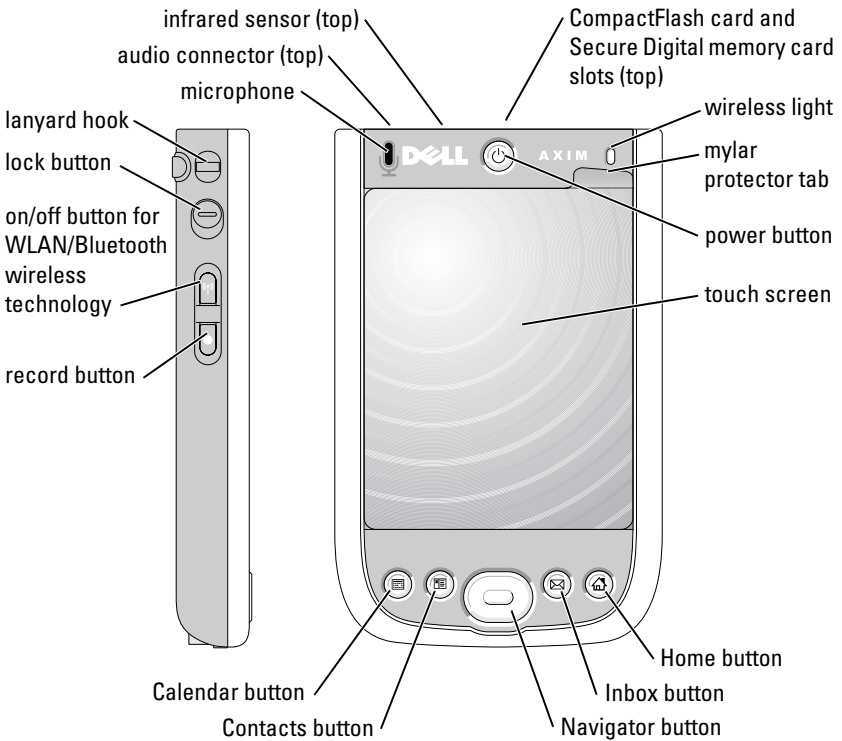

INFRARED SENSOR — Transfer files from your device to another infrared-compatible device without using any cable connection.

MICROPHONE — Use to record audio.

COMPACTFLASH CARD AND SECURE DIGITAL MEMORY CARD SLOTS — See "Using Cards" on page 52 for information on using CompactFlash cards and Secure Digital memory cards.

POWER BUTTON — Press the power button to turn the device on or off. Press and hold the power button to dim the display. Press and hold again to light the display. Use Power Button tab to configure power button to turn off power completely. This saves your battery power.

TOUCH SCREEN — Enter information through your touchscreen using the stylus. See "Entering Information" on page 64.

SCREEN PROTECTOR — Use screen protectors to protect your device's touchscreen. You must change the protectors with usage to enhance the life of the touchscreen.

ON/OFF BUTTON FOR WLAN/BLUETOOTH® WIRELESS TECHNOLOGY — On wireless devices, the button turns both WLAN and Bluetooth wireless technology on and off. Tap it twice to confirm the turning off or on of WLAN/ Bluetooth. Turn off the wireless devices to conserve power. On Bluetooth devices, the button turns Bluetooth wireless technology on and off.

Current Wireless Status		Switch	New Wireless Status	
WLAN	Bluetooth		WLAN	Bluetooth
Off	Off	→	On	On
On	Off		Off	Off
Off	On		Off	Off
On	On		Off	Off

HOME BUTTON — Press to launch the Home window or to turn on the device.

NAVIGATOR BUTTON — Press the right, left, top, or bottom of the Navigator button to move the cursor on the screen. Press the center to enter a selection.

CONTACTS BUTTON — Press to launch Contacts or to turn on the device.

CALENDAR BUTTON — Press to launch Calendar or to turn on the device.

RECORD BUTTON — See "Recording a Message" on page 73 for information on using the record button.

LOCK BUTTON — Use this to lock the device and its touchscreen so that the device does not respond to inadvertent pressing of keys.

Back View

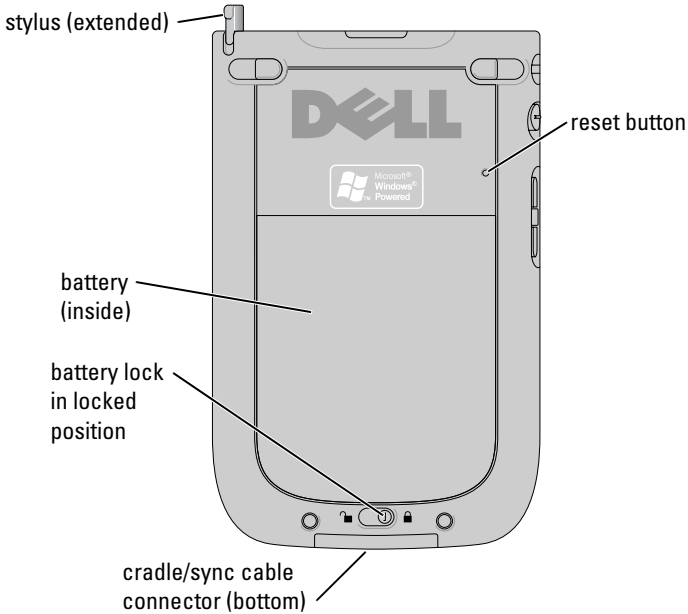

BATTERY LOCK — Use this switch to release and remove the main battery. See "Installing and Removing the Battery" on page 42.

BATTERY — See "Using the Battery" on page 42 for information on the main battery.

CRADLE/SYNC CABLE CONNECTOR — Connect a cradle or sync cable. See "Connecting to a Computer" on page 48.

RESET BUTTON — See "Resetting the Axim" on page 53 for information on using the reset button.

STYLUS — Use the stylus to write or draw on the screen. To remove the stylus, pull it straight up and out of the holder. To avoid losing the stylus, store the stylus in the holder when you are not using it. Ensure that the stylus is oriented correctly when you replace it in the slot.

Using the Battery

Your device ships with a standard 1100 mAH battery with an expected minimum of 5-8 hours of use. A 2200 mAH battery can also be purchased. The 2200 mAH battery has a minimum battery life of 10-16 hours.

NOTICE: Do not use your device for extended periods of time at least 8 hours for the first time.

Before you use your device, you must charge the battery. Turn on your device using the power button. After the device is on, you can start your device by touching the screen. The system will display the battery charge level. For more information, see the user manual.

Installation

To install the battery, follow these steps:

1. Remove the battery cover.
2. Align the battery with the contacts in the battery slot, and lower the battery into the slot.

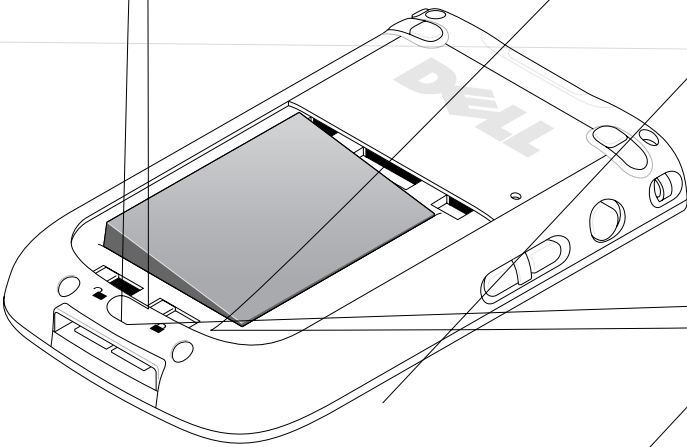

- 4 Close the battery cover.
- 5 Lock the battery cover by sliding the battery lock to the right.

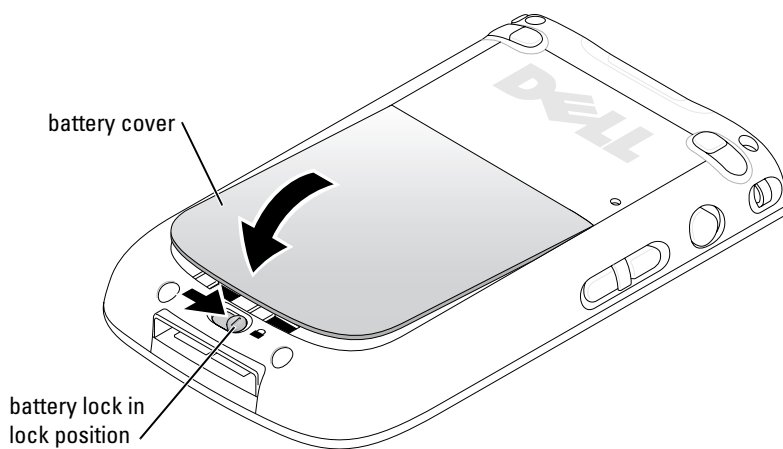

To remove the battery:

- 1 Slide the battery lock to the left to unlock the battery cover.
- 2 Lift the battery cover.

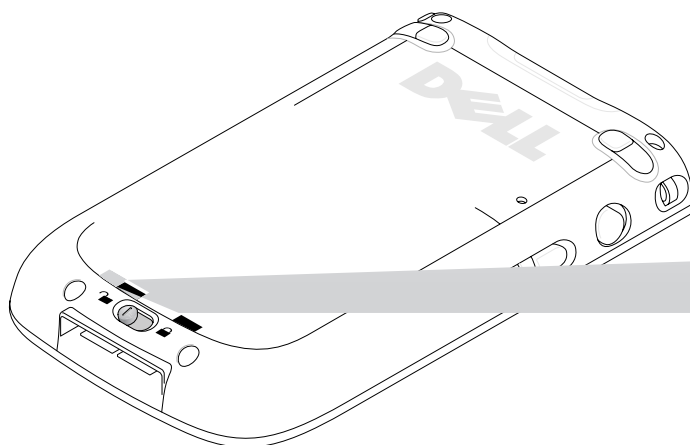

- 3 Pull the tab to lift the battery out of the slot.

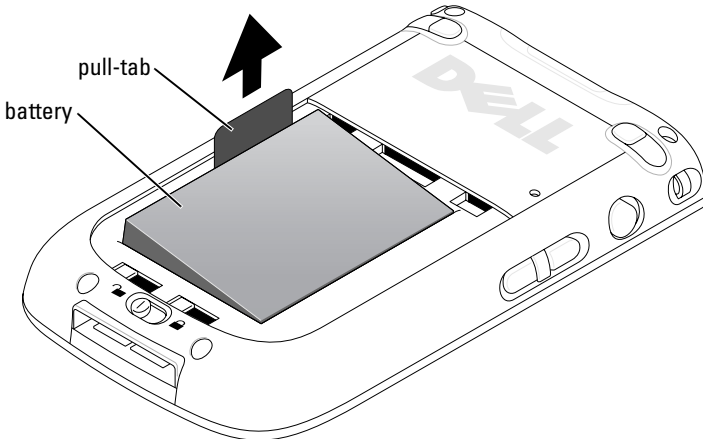

NOTE: Your Service Tag is located underneath the battery in the battery slot. You need your Service Tag to access Dell Support at support.dell.com or to call Dell for customer service or technical support. The Dell Express Service Code is also located here.

Charging the Battery

You must charge your battery before using it for the first time. Subsequently, recharge the battery every time it runs low (power button light flashes amber).

Use one of the following options to charge the main battery:

- Connect the AC adapter to the charger adapter and then connect the charger adapter to the device.
- Connect the AC adapter to the sync cable and then connect the sync cable to the device. See, "Using the Sync Cable" on page 50.
- Connect the AC adapter to the cradle, and insert the device into the cradle. See "Using the Cradle" on page 48 for more information.

The standard battery pack (1100mAh) completely charges within 5 hours; the higher battery pack (2200mAh) completely charges within 10 hours.

If the main battery is critically low, the device enters "sleep" mode and the device turns off.

To recover from a critically low battery:

- 1 Plug in the AC adapter or replace the main battery with a charged battery.
- 2 Press the power button to turn on the device.

By default, the device turns off if the device is left unused for a period of time. This is called the sleep mode. For information on setting the amount of time during which the device can remain idle before it turns off, see "System Tab" on page 75.

To save power, you can turn off the power of the Axim without losing any data. The data is stored in Flash ROM and hence is not lost when the device is switched off.

Using Your Axim

When you turn on your device, the **Today** screen appears. You can also view the **Today** screen by tapping the **Start** button and then tapping **Today**. The **Today** screen displays the date and information about the device owner, today's calendar, and important tasks. To customize the **Today** screen:

- 1 Tap **Start** → **Settings**.
- 2 Tap the **Personal** tab → **Today**.

Use the **Appearance** tab to change the background of the **Today** screen.

Use the **Items** tab to change the items that appear on the **Today** screen.

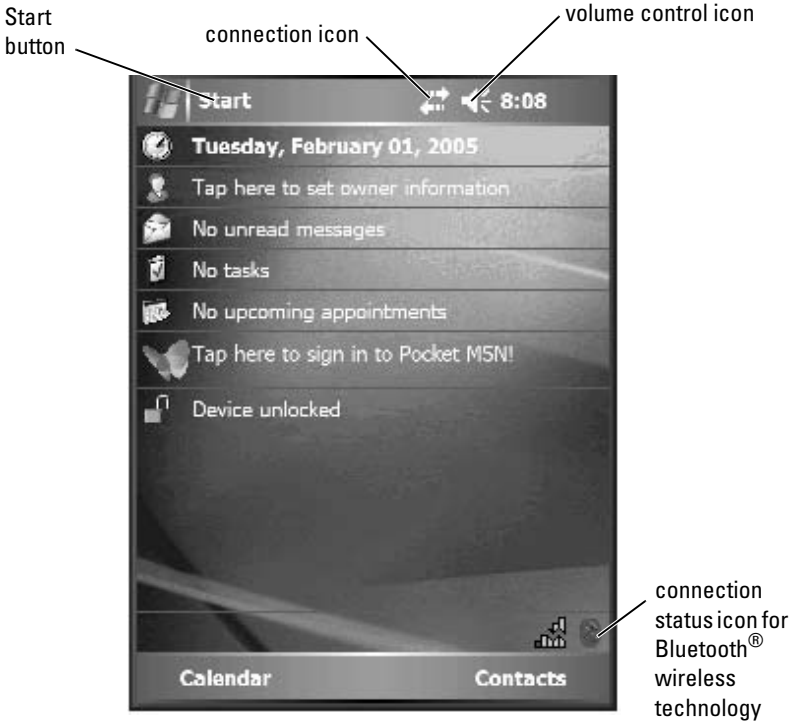

Changing the Display Mode on Your Device

The Axim X51/X51v with Microsoft® Windows Mobile™ Version 5.0 software for Pocket PC Premium Edition can display the screen in both landscape and portrait views.

To change the display mode from landscape to portrait:

- 1 Tap **Start** → **Settings**.
- 2 In the **Settings** window, tap **System** → **Screen**.
- 3 In the **Screen** window, tap **Portrait** to select portrait mode.

 **NOTE:** To change the display mode from portrait to landscape, tap **Landscape**.

- 4 Tap **OK** and close the window.

Operating the Axim

Using the Power Button

Press the power button to turn the device on or off. Press and hold the power button to dim the display. This is the power saver mode. Press and hold again to light the display. Use **Power Button** tab to configure power button to turn off power completely. This saves your battery power.

- When the device is connected to external power and the main battery is fully charged, the power button light is solid green.
- When the main battery charge is low, the power button light flashes amber.
- When the battery is being charged, the power button light is solid amber.
- When the device relays a notification, the power button light rapidly flashes green.



NOTE: When the battery charge is critically low, the date and time settings are retained for 168 hours. Date and time settings can be preserved for 5 minutes in absence of any kind of power (AC adapter or main battery). When the Axim is without power for more than 5 minutes, the date and time settings are lost. However, data stored in flash ROM is safe.

Using the Stylus

Your device has a stylus for selecting items and entering information. On the device, the stylus replaces the mouse:

- Tap — Touch the screen once with the stylus to open items and select options.
- Drag — Hold the stylus on the screen and drag to select text and images. Drag on a list to select multiple items.
- Tap and hold — Tap and hold the stylus on an item to see a list of actions available for that item. On the pop-up menu that appears, tap the action you want to perform.

See "Entering Information" on page 64 for more information.

Connecting to a Computer

You can either connect your device to a computer using a cradle or directly to a computer using a sync cable. Connect your device to a computer to:

- Add programs to your device. See "Adding Programs Using Microsoft® ActiveSync®" on page 107 for more information.
- Synchronize data on your device with data on your computer.

For information on synchronizing your data, see the following resources:

- ActiveSync Help on your computer
- ActiveSync Help on your device

Using the Cradle



NOTE: Depending on the configuration of your device, the cradle is optional.

You can use the cradle to:

- Synchronize the data on your device with the data on your computer.
- Connect the device to an electrical outlet to conserve battery power.
- Charge the main battery. See "Using the Battery" on page 42 for more information.
- Charge a spare battery. Please note that the spare battery is optional.



NOTE: Before connecting your device to a computer for the first time, install ActiveSync on the computer using the *Dell™ Getting Started CD*.

To connect your device to the cradle:

- 1 Connect the AC adapter to the cradle and to an electrical outlet.
- 2 Place the Axim in the docking cradle near your computer.
- 3 Connect the USB sync cable to the cradle and the computer.

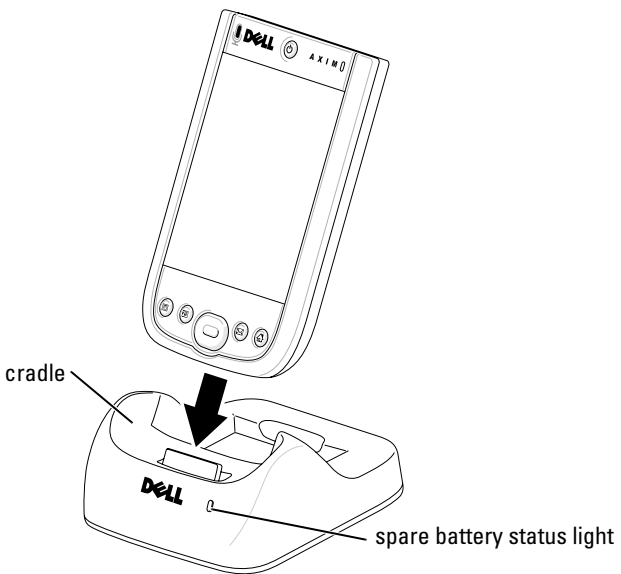
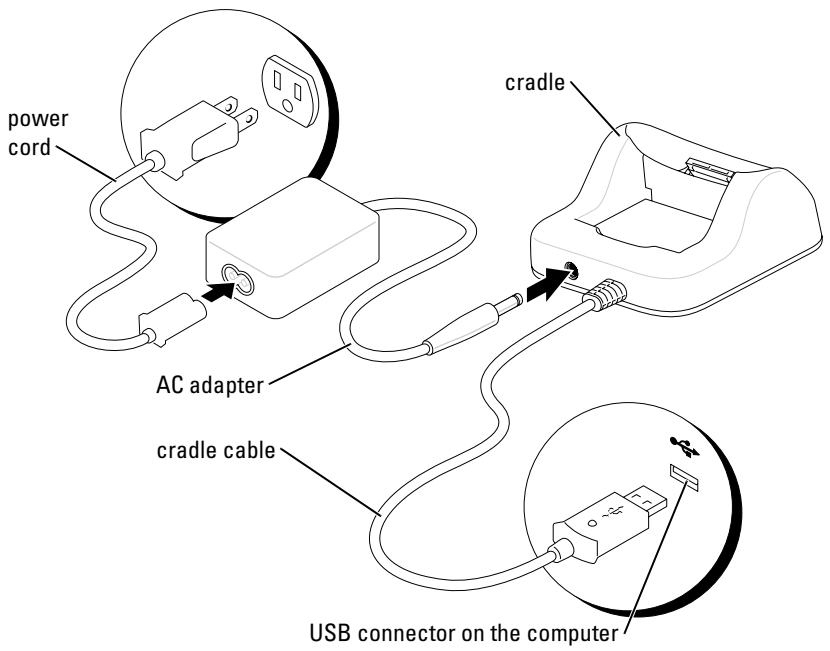

When the device is docked in the cradle, the power button on the device turns on and the connection status icon appears on the command bar (see page 56).

 **NOTE:** The power button on the device indicates the charge status of the main battery. See the description of the power button lights on page 47 for more information.

The spare battery status light on the cradle operates as follows:

- Green — The spare battery is fully charged.
- Amber — The spare battery is charging.

To remove the device from the cradle, pull the device straight up and out of the cradle.

Using the Sync Cable

Use the sync cable to connect your device directly to the computer without using the cradle.

 **NOTE:** The sync cable is optional depending on the configuration of your device.

To connect the sync cable:

- 1 Connect the sync cable connector to your device. Ensure that the Dell logo is facing upwards.
- 2 Connect the USB connector of the cable to the USB connector on your computer.

 **NOTICE:** To avoid damaging the sync cable connector, press the two buttons on the sides of the connector to release the lock before inserting or pulling out the connector.

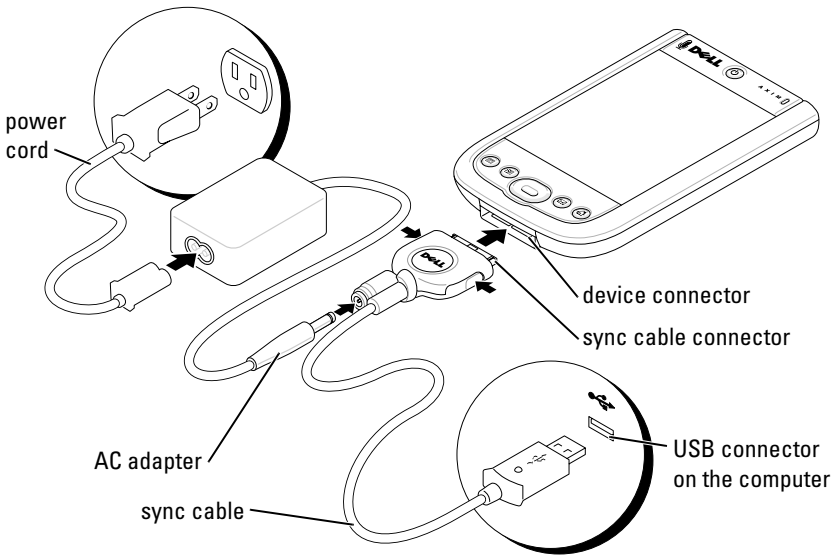

Connecting to a Projector

You can connect the device to a projector using a VGA cable.

NOTE: The VGA option is available only with the Axim X51v model. The VGA cable will not ship with your device unless you order it.

NOTE: You need to install the **Viewer** program from the Dell *Getting Started* CD for the device to detect the projector. To configure the program, see the **Help** section in the program.

To connect the device to the projector, connect the sync connector on the VGA cable to the device, and then connect the other connector of the VGA cable to the projector cable. Run the **Viewer** program for the device to detect the projector.

ng C

device supports Core i7, i5, i3, and Celeron processors. The smartphone supports Core i7, i5, i3, and Celeron processors. All three memory options are available in sizes of 1 GB or 2 GB.

mpactFlas

er device supports CompactFlash Type II cards. Some common types of cards include:

Modem — A modem is a device that connects your computer to the Internet. It is a line for modern communication.

Wireless communication — A wireless communication card is a type of card that allows you to connect to the Internet without a cable connection. It is a type of card that allows you to connect to the Internet without a cable connection.

Bluetooth wireless communication — Bluetooth wireless communication is a type of card that allows you to connect to the Internet without a cable connection. It is a type of card that allows you to connect to the Internet without a cable connection.

Storage — Storage is a type of card that allows you to store data on your computer. It is a type of card that allows you to store data on your computer.

When you do not have a card, you can use a Flash card. A Flash card is a type of card that allows you to store data on your computer. It is a type of card that allows you to store data on your computer.

When you do not have a card, you can use a card slot. A card slot is a type of slot that allows you to insert a card into your computer. It is a type of slot that allows you to insert a card into your computer.

When you do not have a card, you can use a CompactFlash card. A CompactFlash card is a type of card that allows you to store data on your computer. It is a type of card that allows you to store data on your computer.

If a blank is inserted into a card slot, you can use it to store data on your computer. It is a type of card that allows you to store data on your computer.



the
Flash

NOTE: Do not
the orientation

See the docu

Secure Digital Memory Cards

Use Secure Digital memory cards to save or back up data.

To install a Secure Digital memory card:

- 1 If a card or plastic blank is already installed, press in to release it, and then remove it.

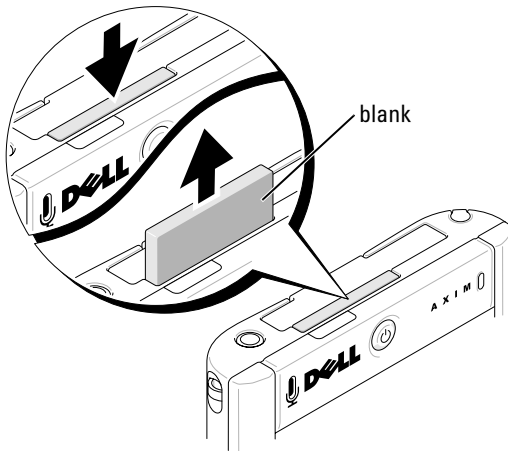

- 2 Ensure that the card is oriented correctly, and slide it into the slot until you feel a click.

NOTICE: Do not force the card. If you feel resistance, remove the card, check the orientation, and reinsert it.

See the documentation that came with the card for more information.

Resetting the Axim

Soft Reset

When you do a soft reset, the device deletes any data or active programs that has not been saved in the flash memory. In other words, your saved files and programs are not deleted. Try a soft reset if the device does not respond when you tap the display or press a button. The soft reset is disabled when Axim is in full power off mode.

To do a soft reset, use the stylus to press the reset button.

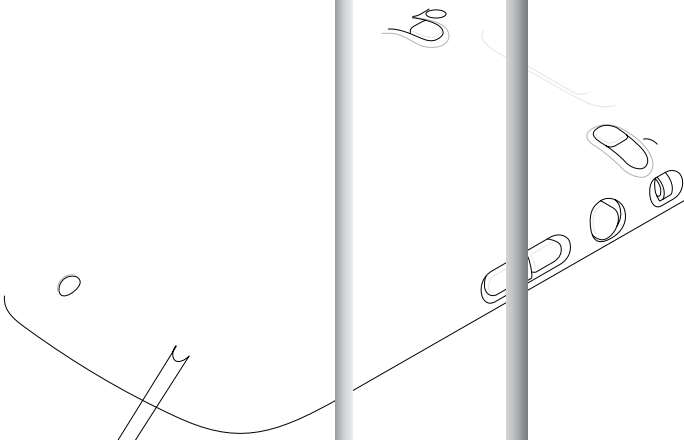

Hard Reset

NOTICE: When you do a hard reset, you lose all the data stored in your device's Flash memory, and any programs that you installed on your device.

Do a hard reset if:

- You want to restore the device to factory default settings.
- You forget your password and need to reset it.
- Your device is experiencing severe operational problems and you have already attempted a soft reset.

NOTICE: It is strongly recommended that you back up your data before you do a hard reset.

To do a hard reset:

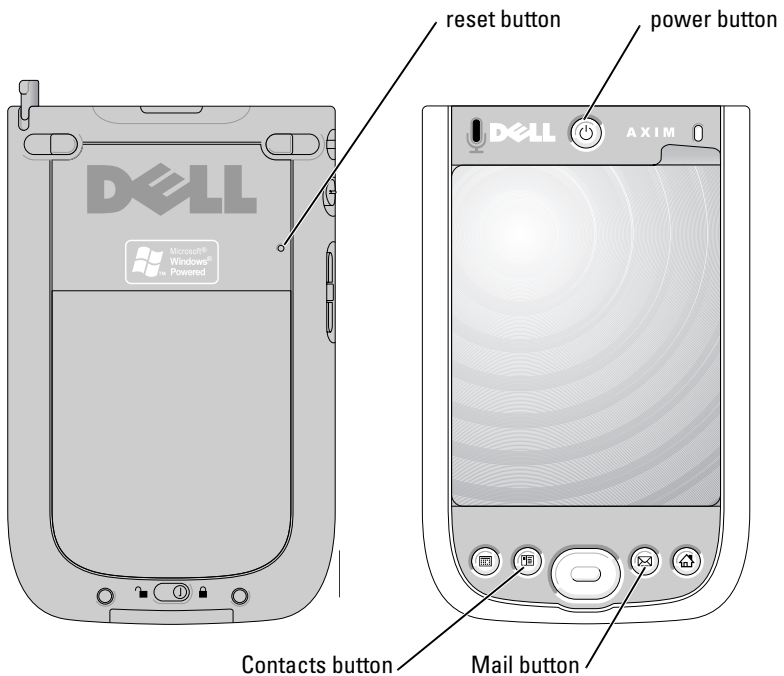

- 1 Press the **Power** button to turn the Axim unit **On**.
- 2 Press and hold the **Power** button down while using the Axim stylus to press the **Reset** button at the same time.
- 3 Release the **Power** button and the **Reset** button.
The **To clear all data in the memory** screen appears.
- 4 Press the **Contacts** button on the Axim to delete all of the data in the memory of the Axim handheld.
- 5 Press the **Mail** button on the Axim to cancel the operation without losing data.















Using Microsoft® Windows Mobile™ Version 5.0 Software for Pocket PC Premium Edition Mobile 5.0

The Windows Mobile 5.0 operating system comes with a host of new features and interface improvements. The screen view and touchpad is similar to Windows™ XP for computers. RAM is only used for running applications. Flash ROM is where all application, PIM data, and file storage happens. For details, visit the www.microsoft.com website.

Status Icons

 **NOTE:** If there is not enough space to display all notification icons on the device, tap , icon to view the hidden list of icons.

Icon	Description
	New e-mail or text message (SMS)
	New instant message
	Battery level
	Low battery
	Battery charging
	No battery
	Sync Error
	Volume off
	Bluetooth

Icon	Description
	Wi-Fi on
	Wi-Fi data call
	Help icon

Programs

You can switch from one program to another by selecting a program from the Start menu. To access programs that are not listed in the Start menu, tap Start → Programs, and then tap the program name.



NOTE: Some programs have abbreviated labels for check boxes and drop-down menus. To see the full spelling of an abbreviated label, tap and hold the stylus on the label. Drag the stylus off the label so that the command is not carried out.

Program Buttons

You can also switch to some programs by pressing a program button. Your device has four program buttons located on the front of the device. The icons on the buttons identify the programs which they start. By default, the buttons launch Home, Messaging, Contacts, and Calendar.

Switcher Bar

You can also use Switcher Bar to switch to or close the open programs.
To launch Switcher Bar:







- 1 Tap **Start** → **Settings**.
- 2 Tap **System** → **Switcher Bar**.





The Switcher Bar icon, , appears in the navigation bar.

Tap  to view a list of all open programs. In the **Switcher Bar** menu:

- Tap **Brightness settings** or **Power settings** to configure those settings.
- Tap a program name to switch to that program.
- Tap **Exit current program** to close the current program.
- Tap **Exit all programs** to close all open programs.
- Tap **Exit Switcher Bar** to close the menu.

The following table contains a partial list of programs that are on your device. See the *Dell™ Getting Started* CD for additional programs that you can install on your device.

Icon	Program	Description
	ActiveSync	Synchronize information between your device and your computer.
	Calendar	Keep track of your appointments and create meeting requests.
	Contacts	Keep track of your friends and colleagues.
	Messaging	Send and receive e-mail messages.
	Internet Explorer Mobile	Browse websites and WAP sites, and download new programs and files from the Internet.
	Notes	Create handwritten or typed notes, drawings, or recordings.
	Tasks	Keep track of your tasks.

Icon	Program	Description
	Excel Mobile	Create new workbooks or view and edit Excel workbooks that you created on your computer.
	Pocket MSN	Send and receive instant messages with your MSN Messenger contacts.
	Word Mobile	Create new documents or view and edit Word documents that you created on your computer.
	PowerPoint Mobile	View PowerPoint presentation slides.

Navigation Bar and Command Bar

The navigation bar is located at the top of the screen. It displays the active program and current time, and allows you to switch to other programs or close screens.

Use the command bar at the bottom of the screen to perform tasks in programs. The command bar includes menu names, icons, and the input panel icon. To create a new item in the current program, tap **New**. To see the name of an icon, tap and hold the stylus on the icon. Drag the stylus off the icon so that the command is not carried out.

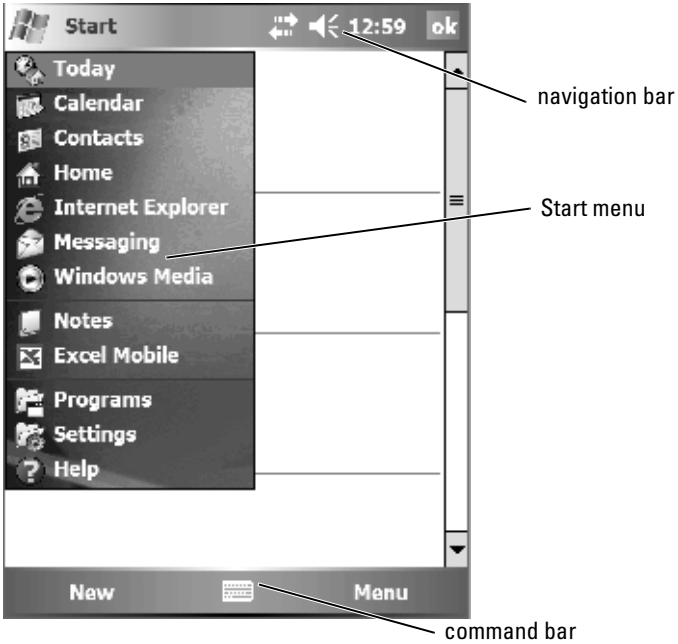

Pop-Up Menu

With pop-up menus, you can quickly select an action for an item. For example, you can use the pop-up menu in the contact list to delete a contact, make a copy, or send an e-mail message to a contact. The actions in the pop-up menu vary from program to program. To access a pop-up menu, tap and hold the stylus on an item name. When the menu appears, lift the stylus and tap the action you want to perform. To close the menu without performing an action, tap anywhere outside the menu.

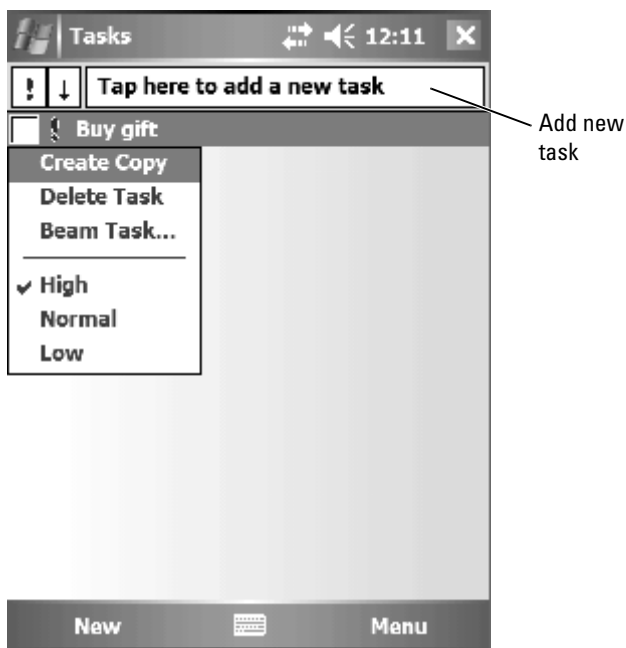

Searching for Information

The Search feature on your device helps you to quickly locate information.

To search for files or other items:

- 1 Tap **Start** → **Programs** → **Search**.
- 2 In **Search for**, enter the file name, word, or other information you want. If you have looked for this item before, tap the **Search for** arrow to select the item from the list.
- 3 In **Type**, select a data type to help narrow your search.
- 4 Tap **Search**.
The **My Documents** folder and subfolders are searched.
- 5 In the **Results** list, tap the item you want to open.

You can also use File Explorer to find files on your device and to organize your files into folders. On the Start menu, tap Programs → File Explorer.

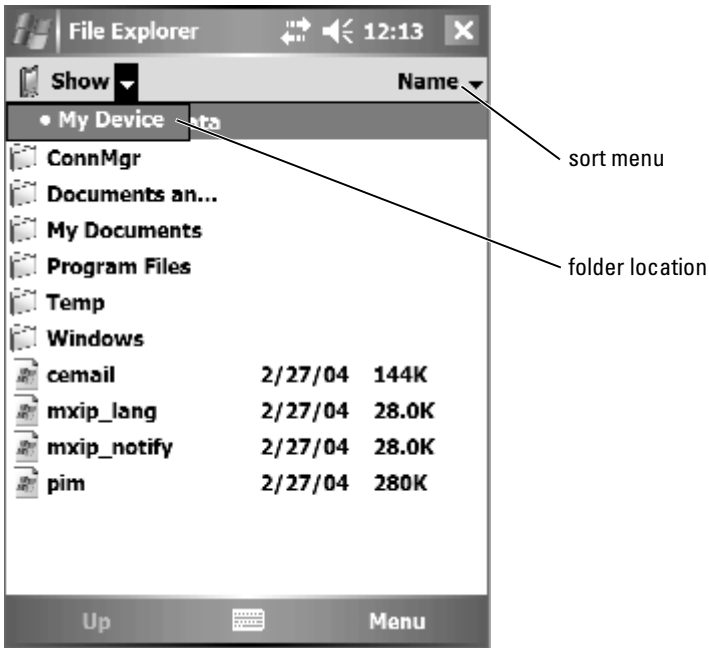

Backing Up Data

To prevent or minimize data loss, you should periodically back up the data stored on your device. Use ActiveSync to synchronize the files on your device with the files on your computer. You can also drag and drop files from your device to your computer using Windows Explorer. See the ActiveSync Help on your computer for additional information. Also see, "Installing and Using ActiveSync" on page 78.

Use ActiveSync to create backup files and store the files on your host computer. For more information on the two methods of backing up files, see "Backing Up and Synchronization of Data" on page 63 and "Manual Back Up By Dragging Files" on page 63.

Backing Up and Synchronization of Data

Synchronization compares the data on your Axim with the data on your host computer and updates both with the most recent data. ActiveSync does not automatically synchronize all types of data. Synchronization only backs up the data types selected in the Options settings. Options are selected first when establishing a standard partnership and can be changed at any time by clicking the Options icon on the Microsoft ActiveSync window. ActiveSync automatically creates a folder on your host computer in the My Documents folder called Pocket_PC My Documents. It also creates a shortcut on the host computer's desktop to hold the synchronized data.

The two types of synchronization are:

Automatic synchronization — Data is backed up automatically when ActiveSync is activated by docking and at other set intervals.

Manual synchronization — If the automatic syncing feature is turned off, you can back up files at any time by using the Sync button to start the synchronization process.

To start manual synchronization:

- 1 Connect the Axim to the host computer.
- 2 From the Microsoft ActiveSync screen on your host computer, click the Sync button.

Synchronization begins and the status displays at the bottom part of the screen.

Manual Back Up By Dragging Files



NOTICE: You must manually back up files that are not selected in the Options settings. Manually backed up files are dragged to a separate folder on the desktop of your host computer.

Only data types that have been selected when establishing a partnership, or by changing the Sync Option selections are backed up (synchronized) automatically. You can back up other data by manually dragging files to a separate folder on your host computer.

For example, create a folder on your desktop called **Other Axim Files**. Use **Other Axim Files** to hold files that are not saved automatically.

- 1 From the **Microsoft ActiveSync** screen, click **Explore**. The **Mobile Device** window appears.
- 2 From the **Mobile Device** window, browse to any file or folder.
- 3 Select the file or folder and drag it to the **Other Axim Files** folder on your host computer.

Confirming Backup

Confirm that all the data you want is backed up on your host computer. Any data not backed up before you upgrade to Windows Mobile Version 5.0 for Pocket PC Premium Edition is lost. Check the following items:

- E-mail inbox in Outlook
- Calendar entries in Outlook
- Contacts in Outlook
- Task entries in Outlook
- Notes in Outlook
- Favorites
- Files that have been synchronized and placed automatically in the **Pocket_PC My Documents** folder
- Files that have been manually dragged to the **Other Axim Files** folder on your host computer
- Previous ROM dragged to the **Other Axim Files** folder

Entering Information

You have several options for entering information:

- Use the input panel to enter typed text using the soft keyboard or another input method.
- Write directly on the screen using the stylus.
- Draw pictures on the screen with the stylus.
- Speak into your device microphone to record a message.

Use Microsoft® ActiveSync® to synchronize or copy information from your computer to your device. For more information, see ActiveSync Help on your computer.

 **NOTE:** Some of the functions mentioned in this section may not be supported by the operating system in some languages.

Entering Text Using the Input Panel

Use the input panel to enter information into any program on your device. You can type using the soft keyboard or write with the stylus using Letter Recognizer, Block Recognizer, or Transcriber. The characters appear as typed text on the screen.

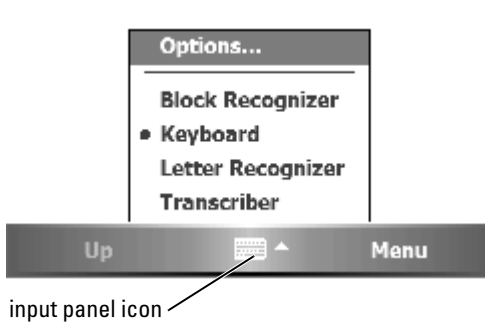

To show or hide the input panel, tap the input panel icon. Tap the arrow next to the input panel icon to change the input method.

When you use the input panel, your device anticipates the word you are typing or writing and displays it above the input panel. When you tap the displayed word, the word is inserted at the insertion point. The more you use your device, the more words it learns to anticipate.

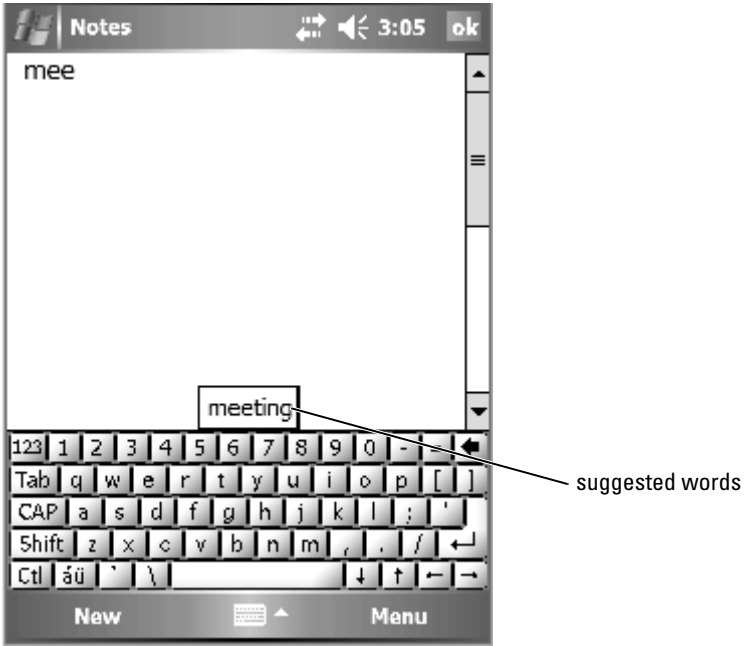

To change word suggestion options, for example, the number of words suggested:

- 1 Tap Start → Settings → Personal → Input.
- 2 Tap the **Word Completion** tab.
- 3 Select the desired settings and tap OK.

Typing With the Soft Keyboard

- 1 Tap the input selection arrow and tap **Keyboard**.
- 2 Tap the keys on the soft keyboard with your stylus.

Letter Recognizer

Letter Recognizer allows you to use your stylus to write letters on the screen as you would write them on paper.

 **NOTE:** Letter Recognizer is included with the English, French, German, Italian, and Spanish operating systems. Other versions do not support Letter Recognizer.

- 1 Tap the input selection arrow and tap **Letter Recognizer**.
- 2 Write characters, numbers, and symbols in the designated writing area.
 - Enter capital letters by writing in the ABC (left) area of the box.
 - Enter lower case letters by writing in the abc (middle) area of the box.
 - Enter numbers by writing in the 123 (right) area of the box.
 - Enter punctuation and symbols by tapping in any area of the box and then writing the desired character.

The letters are converted to typed text on the screen. For specific instructions on using Letter Recognizer, tap the question mark next to the writing area.

 **NOTE:** Tap **Demo** to learn the character strokes that the device can recognize.

Block Recognizer

Block Recognizer allows you to use character strokes that are similar to those used on other handheld devices.

 **NOTE:** Block Recognizer is included with the English, French, German, Italian, and Spanish operating systems. Other versions do not support Block Recognizer.

- 1 Tap the input selection arrow and tap **Block Recognizer**.
- 2 Write characters, numbers, and symbols in the designated writing area.
 - Enter letters by writing in the abc (left) area of the box.
 - Enter numbers by writing in the 123 (right) area of the box.
 - Enter symbols and punctuation by tapping in either area of the box and then writing the desired character.

The character strokes are converted to typed text on the screen. For specific instructions on using Block Recognizer, tap the question mark next to the writing area.

 **NOTE:** Tap **Demo** to learn the character strokes that the device can recognize.

Transcriber

Transcriber allows you to write anywhere on the screen using the stylus similar to the way that you would write on paper. Unlike Letter Recognizer and Block Recognizer, you can write a sentence or more, and then pause to let Transcriber change the written characters to typed characters.



NOTE: Transcriber is included with the English, French, and German operating systems. Other versions do not support Transcriber.

- 1 Start a program such as Word Mobile.
- 2 Tap the Input Panel icon at the bottom center of the screen and tap the input selection arrow to the right of the icon.
- 3 Tap **Transcriber**.
The Transcriber introductory screen appears.
- 4 With your stylus, write anywhere on the screen.

When you pause, Transcriber converts your written characters to typed characters. For specific instructions on using Transcriber, tap the question mark in the lower right hand corner of the screen.

Writing on the Screen

In any program that accepts written text, such as the Notes program and the Notes tab in some programs, you can use your stylus to write directly on the screen. You can edit and format what you have written and convert the information to text at a later time.



Editing Written Text

To edit or format written text:

- 1 Drag the stylus across the text that you want to select.
- 2 Tap and hold the selected text.
- 3 Tap the appropriate editing command in the pop-up menu.

You can also tap **Menu** → **Edit** at the bottom of the screen to select editing commands.

To convert written text to print-style text, tap **Menu** → **Tools** and tap **Recognize**.

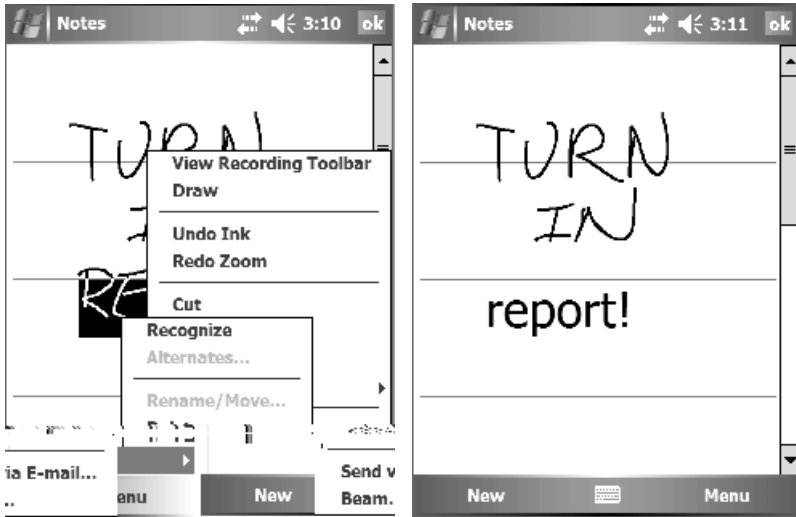

If you want to convert only certain words, select them before tapping **Recognize** (or tap and hold the selected words and then tap **Recognize** on the pop-up menu). If a word is not recognized, it is not converted to print-style text.

If the conversion is incorrect, you can select different words from a list of alternatives or return to the original written text:

- 1 Tap and hold the incorrect word.
- 2 On the pop-up menu, tap **Alternates**.
A menu with a list of alternative words appears.
- 3 Tap the correct word, or tap the written text at the top of the menu to return to the original written text.

Tips for getting good recognition:

- Write neatly.
- Write on the lines and draw descenders below the line. Write the cross of the "t" and apostrophes below the top line so that they are not confused with the word above. Write periods and commas above the line.
- For better recognition, try changing the zoom level to 300 percent by tapping **Menu** → **Zoom**.

Drawing on the Screen

You can draw on the screen the same way that you write on the screen. However, selecting and editing drawings is different than selecting and editing written text. For example, selected drawings can be resized, while written text cannot.

Creating a Drawing

 **NOTE:** To zoom in or out on your drawing, tap **Menu** → **Zoom** and tap a zoom level.

Cross three ruled lines on your first stroke. A drawing box appears. Subsequent strokes that touch or are inside of the drawing box become part of the drawing. Drawings that do not cross three ruled lines are treated as written text.

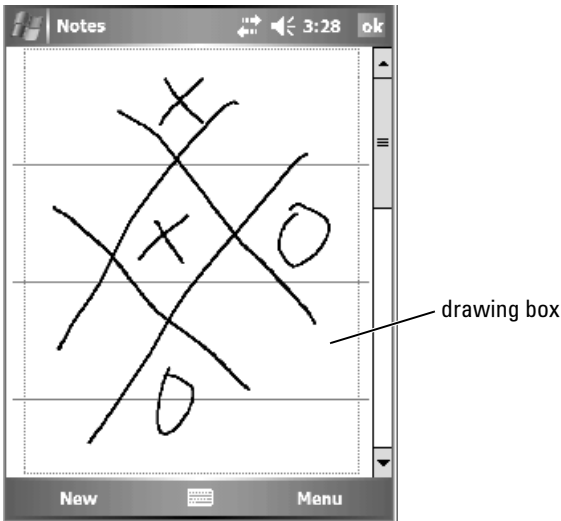

Editing a Drawing

To edit or format a drawing, you must first select it:

- 1 Tap and hold the stylus on the drawing until the selection handles appear.
To select multiple drawings, drag to select the drawings.
- 2 You can cut, copy, and paste selected drawings by tapping and holding the selected drawings and then tapping an editing command on the pop-up menu.
You can also tap **Menu** → **Edit** at the bottom of the screen to select editing commands.

To resize a drawing, drag a selection handle.

Recording a Message

In a program where you can write or draw on the screen, you can also quickly capture thoughts, reminders, and phone numbers by recording a message.

- In **Calendar**, **Tasks**, and **Contacts**, you can include a recording in the **Notes** tab.
- In the **Notes** program, you can either create a stand-alone recording or include a recording in a written note. If you want to include the recording in a note, open the note first.
- In the **Messaging** program, you can add a recording to an e-mail message.

To record a message:

- 1 Hold the microphone near your mouth or other source of sound.
- 2 Press and hold the **Record** button on the side of your device until it beeps.
- 3 While holding down the **Record** button, make your recording.
- 4 To stop recording, release the **Record** button.

The device beeps twice. The new recording appears in the note list or as an embedded icon.



NOTE: You can also make a recording by tapping the **Record** icon on the Recording toolbar.

To play a recording, tap the name of the recording in the list or tap the speaker icon in the note.

Using My Text

When using Messaging or MSN Messenger, use My Text to quickly insert preset or frequently used messages. To insert a message, tap Menu → My Text and tap a message.

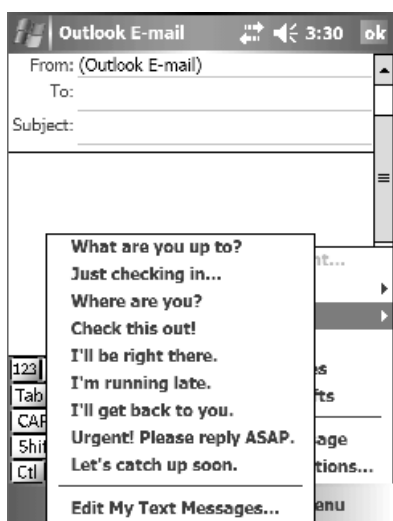

 **NOTE:** You can add text to a My Text message after you insert the message.

To edit a My Text message:

- 1 Tap Menu → My Text → Edit My Text Messages.
- 2 Make the changes and tap OK.

Adjusting Settings

You can adjust the device settings to suit the way you work. To see available options, tap Start → Settings.

 **NOTE:** Depending on the features of your device, you might have additional tabs and additional items on the tabs.

See your device Help for additional information on adjusting settings (tap Start → Help).

Personal Tab

- **Buttons** — Assign the programs that launch when you press the device buttons.
- **Input** — Adjust the settings for input method, word completion, and other options.
- **Menus** — Add or remove items from the **Start** menu.
- **Owner Information** — Enter your contact information.
- **Password** — Set a password to protect the data stored on your device.
- **Sounds & Notification** — Adjust the volume and set notifications. See "Notifications" on page 91 for more information.
- **Today** — Customize the look and the information that is displayed on the Today screen.
- **MSN Options** — Settings you can use to create a custom Pocket MSN experience.

System Tab

- **About** — Find information about Windows Mobile 5.0 and your device.
- **Brightness** — Adjust the brightness settings to conserve power.
- **Certificates** — View or delete certificates stored on your device. Certificates help establish your identity and the identity of other computers to prevent unauthorized users from accessing your data.
- **Clock & Alarms** — Change the time and set the alarm.
- **Memory** — Allocate memory for data and program storage. View free and used memory, storage card memory, and running programs.
- **Error Reporting** — Send information needed by technical support groups to diagnose a program error for a device running Windows Mobile software. For this your device must be connected to the Internet.
- **GPS** — Configure the settings when you have a GPS device connected to understand the exact location you are in, with the help of the maps. Note that your Axim does not have a built-in GPS device.

- **Mirror Mode** — This is available only in the X51v model. Mirror mode allows users to see the same image on both the PDA screen and on an external display using a VGA cable. When enabled, an icon will be displayed on the command bar. To disable mirror mode, click on the icon or clear the checkbox.
- **Microphone** — Adjust the microphone volume.
- **Power** — Check the battery or charge status. Use the **Advanced** tab to set the amount of time that the device can remain idle before it turns off. Use Power Button tab to configure power button to turn off power completely. This saves your battery power.
- **Regional Settings** — View and change the formatting for regional settings such as currency, time, and date.
- **Remove Programs** — Remove programs from your device. For more information, see "Adding and Removing Programs" on page 107.
- **Screen** — Adjust the screen if your device is not responding accurately to taps, and select the screen orientation that you want to use.
- **Switcher Bar** — Adjust the settings of the Switcher Bar program launcher utility.
- **System Information** — View technical information about your device.

Connections Tab

- **Beam** — Receive infrared beams from other devices.
- **Bluetooth** — Turn on and off the radio with Bluetooth[®] wireless technology, and create and edit bonded devices. By default, the radio is off.
- **Connections** — Add and configure modem and server connections.
- **Dell WLAN Utility** — Available only on devices with internal Wi-Fi. Use the WLAN utility to connect to the wireless network using EAP/TTLS.
- **Network Cards** — Configure your network adapter settings.
- **Odyssey Client** — Provides secure authentication and connection of wireless LAN (WLAN). Note that this is available only for the Mid and Hi end Axim versions.

Communicating and Scheduling

About the Microsoft® ActiveSync® Program

Microsoft ActiveSync 4.1 is the latest synchronization software for the Axim. ActiveSync transfers files and data between your device and a computer. It can upload drivers and programs to the device. ActiveSync should be installed before connecting the device to a computer. You can find the ActiveSync installation program on the Dell *Getting Started* CD.

You can synchronize the information on your computer with the information on your device using ActiveSync. This compares the data on your device with the data on your computer and updates both with the most recent information. For example:

- Keep Microsoft Pocket Outlook data up-to-date by synchronizing your device with Microsoft Outlook data on your computer.
- Synchronize Microsoft Word and Microsoft Excel files between your device and your computer. Your files are automatically converted to the correct format.





NOTE: By default, ActiveSync does not automatically synchronize all types of information. You can change ActiveSync options to synchronize specific types of information.

With ActiveSync, you can also:

- Copy (rather than synchronize) files between your device and your computer.
- Control when synchronization occurs. For example, you can synchronize continuously or only when you select the synchronize command.
- Select which information types are synchronized and control how much data is synchronized. For example, you can choose how many weeks of past appointments you want synchronized.

To synchronize your data, you need both the Microsoft Windows® and Pocket PC versions of ActiveSync. You must install the Windows version of ActiveSync on your computer using the Dell™ *Getting Started* CD. The Pocket PC version is already installed on your device.

 **NOTE:** Before connecting your device to a computer for the first time, ensure that you install ActiveSync on the computer using the *Dell™ Getting Started CD*.

 **NOTE:** If your Axim fails to synchronize, check your computer security software to see if you have any firewall running. Firewalls may block the communication from your computer to your Axim.

Installing and Using ActiveSync

To install ActiveSync:

- 1 Insert the *Dell Getting Started CD*.
- 2 Click **Getting Started** to access the main menu.
- 3 Click **Start Here**.
- 4 Click **Install ActiveSync** and follow the instructions on the screen.

After the installation is complete, connect your device to your computer. The ActiveSync Setup Wizard enables you to:

- Set up a partnership so that you can synchronize information between your device and your computer
- Customize your synchronization settings

Your first synchronization process automatically begins when you complete the wizard.

 **NOTE:** The device must be powered on for the synchronization process to occur.

During your first synchronization, information that was stored in Outlook on your computer is copied to Calendar, Contacts, and Tasks on your device.

After you set up ActiveSync and complete the first synchronization process, you can initiate synchronization from your device. To switch to ActiveSync on your device, tap **Start → ActiveSync**.

To find information on using ActiveSync on your device, open ActiveSync on your device and tap **Start → Help**.

To find information on using ActiveSync on your computer, click **Help → Microsoft ActiveSync Help**.

 **NOTE:** For more ActiveSync help, visit:<http://www.microsoft.com/windowsmobile/help/activesync/default.msp>

About Microsoft® Pocket Outlook

Pocket Outlook includes Calendar, Contacts, Tasks, Messaging, and Notes. You can use these programs individually or together. For example, e-mail addresses stored in Contacts can be used to address e-mail messages in Messaging.

 **NOTE:** Pocket Outlook is pre-installed on your device. If not already installed, your Dell *Getting Started* CD has a copy of the Pocket Outlook installation program. Ensure that you install Pocket Outlook and not Outlook Express. Note that you can only install Pocket Outlook once from the program, as it is a licensed version.

Using Microsoft ActiveSync®, you can synchronize information on your computer in Microsoft Outlook or Microsoft Exchange. You can also synchronize this information directly with an Exchange server. Each time you synchronize, ActiveSync compares the changes you made on your device and computer or server and updates both with the latest information. For information on using ActiveSync, see ActiveSync Help on your computer.

You can switch to any of the following programs through the Start menu.

 **NOTE:** For detailed information about Calendar, Contacts, Tasks, Messaging, and Notes, among other things, see Help on your device.

Categories

Use categories to group related contacts, tasks, and appointments. For example, you can assign work-related contacts to the Business category and personal contacts to the Personal category so that you can quickly find contact information. You can also create your own categories, such as Family, to group your relatives' contact information.

Creating a Category

To create a category:

- 1 From the program, tap an existing item or create a new one.
- 2 For a new item in **Calendar**, **Contacts**, and **Tasks**, tap **Categories**.
- 3 Tap **New**, enter the category name, and tap **Done**.
The new category is automatically assigned to the item.

- 4 For an existing item in **Calendar** and **Tasks**, tap **Edit** → **Categories**.
- 5 For an existing item in **Contacts**, tap **Menu** → **Edit** → **Categories**.
- 6 Tap **OK** to return to the appointment, contact, or task.

Calendar

Use Calendar to schedule appointments, including meetings and other events. You can check your appointments in one of several views (Agenda, Day, Week, Month, and Year) and easily switch views by using the View menu. Tap the Today icon to view the current date.

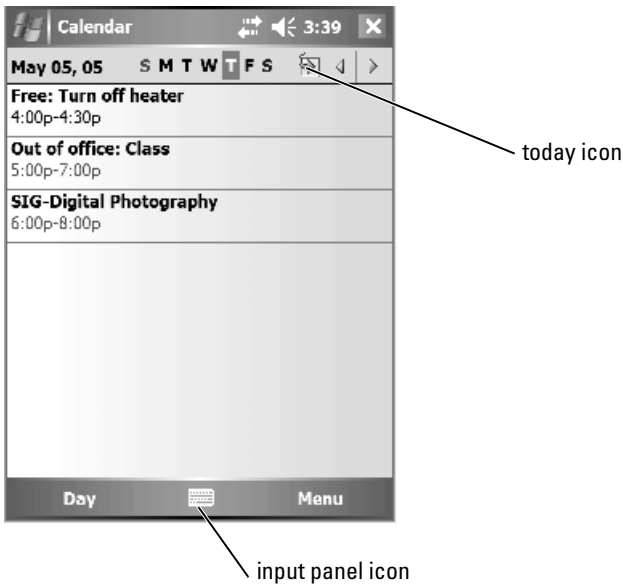

NOTE: To customize Calendar, such as changing the first day of the week, tap **Menu** and tap **Options**.

To create an appointment:

- 1 Tap **Start** → **Calendar**.
- 2 Tap **Menu** → **New Appointment**.
- 3 Enter a name for the appointment, and enter information such as start and end times.
- 4 To schedule an all-day event, in the **All Day** box, tap **Yes**.
- 5 When finished, tap **OK** to return to the calendar.

To receive a reminder for an appointment:

- 1 Tap **Start** → **Calendar** → **Menu** → **Options** → **Appointments** tab.
- 2 Select the **Set reminders for new items** check box.
- 3 Set the time when you want the reminder to alert you.
- 4 Tap **OK** to return to the calendar.

Using the Summary Screen

When you tap an appointment in Calendar, a summary screen appears. To change the appointment, tap **Edit**.

Creating Meeting Requests

You can use Calendar to set up meetings with users of Outlook or Pocket Outlook. The meeting request is automatically created when you synchronize Messaging or when you connect to your e-mail server. To set how you want meeting requests sent, tap **Menu** and tap **Options**.

To schedule a meeting:

- 1 Tap **Start** → **Calendar**.
- 2 Schedule a new appointment, or open an existing one and tap **Edit**.
- 3 Tap **Attendees**.
- 4 Tap the name of the contact you want to invite.
- 5 To invite each additional attendee, tap **Add** and tap the name.
- 6 Tap **OK**.

The meeting request will be sent to the attendees the next time you synchronize your device with your PC.

For more information on sending and receiving meeting requests, tap **Start** → **Help** → **Calendar** or **Messaging**.

Contacts

Use Contacts to maintain a list of your friends and colleagues. You can quickly share Contacts information with other device users using the infrared port.

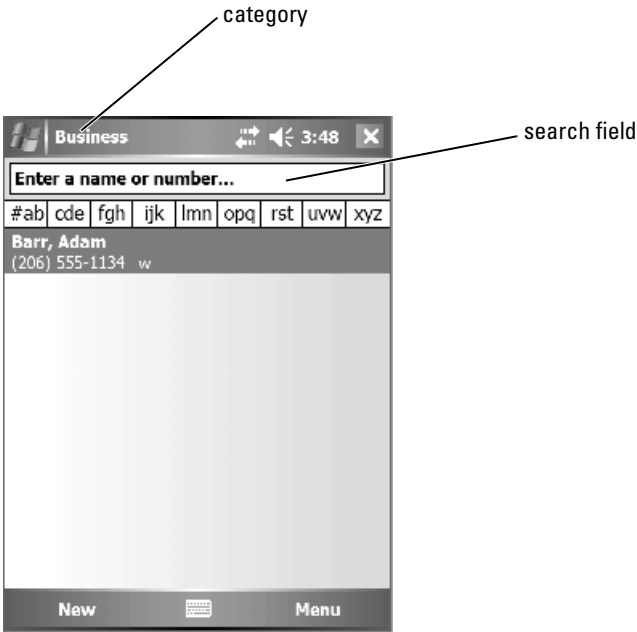

NOTE: To change the way information is displayed in the list, tap **Menu** → **Options**.

To create a contact:

- 1 Tap **Start** → **Contacts** → **New**.
- 2 Using the input panel, enter a name and other contact information. Scroll down to see all available fields.
- 3 To assign the contact to a category, tap **Categories** and select a category from the list.

In the contact list, you can display contacts by category.

- 4 To add notes, tap the **Notes** tab. You can enter text, draw, or create a recording. For more information on creating notes, see "Notes" on page 85.
- 5 When you have finished entering information, tap **OK** to return to the calendar.

Finding a Contact

To find a contact:

- 1 Tap **Start** → **Contacts**.
- 2 If you are not in Name view, tap **Menu** → **View By** → **Name**.
- 3 Do one of the following:
 - Begin entering a name or phone number in the provided text box until the contact you want is displayed. To show all contacts again, tap the text box and clear the text, or tap the arrow to the right of the text box.
 - Use the alphabetical index displayed at the top of the contact list.
 - Filter the list by categories. In the contact list, tap **Menu** → **Filter**. Then tap a category you have assigned to a contact. To show all contacts again, select **All Contacts**.
- 4 To view the names of companies your contacts work for, tap **View** in the contact list and tap **By Company**. The number of contacts that work for that company is displayed to the right of the company name.

Using the Summary Screen

When you tap a contact in the contact list, a summary screen appears. To change the contact information, tap **Edit**.

Tasks



NOTE: To change the way information is displayed in the list, tap **Menu** → **Options**.

Use **Tasks** to list things that you need to do.

To create a task:

- 1 Tap **Start** → **Programs** → **Tasks**.
 - 2 Tap **New**, enter a subject for the task, and fill in information such as start and due dates.
 - 3 When finished, tap **OK**.
 - 4 To copy an existing task from the task list, select the task you want to copy. Tap **Menu** → **Edit** → **Copy**, and then tap **Menu** → **Edit** → **Paste**.
 - 5 To add notes, tap the **Notes** tab. You can enter text, draw, or create a recording. For more information on creating notes, see "Notes" on page 85.
- NOTE:** To quickly create a task with only a subject, tap **Menu** → **Tool** → **Options** →

Notes

Quickly capture thoughts, reminders, ideas, drawings, and phone numbers with Notes. You can create a written note or a recording. You can also include a recording in a note. If a note is open when you create the recording, it is included in the note as an icon. If a note is not open, the recording is saved as a stand-alone recording.

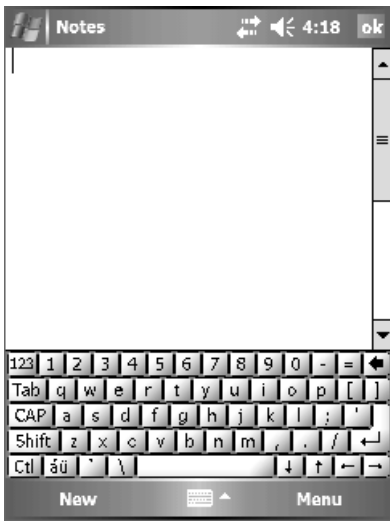

To create a note:

- 1 Tap **Start** → **Programs** → **Notes** → **New**.
- 2 Create your note by writing, drawing, typing, or recording. For more information on using the input panel, writing and drawing on the screen, and creating recordings, see "Entering Information" on page 64.

Messaging

Use Messaging to send and receive e-mail messages:

- Synchronize e-mail messages using Exchange or Outlook on your computer.
- Send and receive e-mail messages by connecting directly to an e-mail server through an ISP or a network.



NOTE: To create an e-mail account for your device, contact your internet service provider. Dell does not provide this service.

Synchronizing E-Mail Messages

You can synchronize e-mail messages along with the rest of your data if you enable Messaging synchronization in ActiveSync. For information on enabling Messaging synchronization, see **ActiveSync Help** on your computer.



NOTE: You can also synchronize e-mail messages with your computer from a remote location. For more information, see "Getting Connected" on page 93.

During synchronization:

- Messages are copied from the e-mail folders of Exchange or Outlook on your computer to the ActiveSync folder in Messaging on your device. By default, you receive:
 - Messages from the past 3 days
 - The first 100 lines of each message
 - File attachments of less than 100 KB in size
- E-mail messages in the **Outbox** folder on your device are transferred to Exchange or Outlook on your computer, and then sent from those programs.
- E-mail messages in subfolders on your computer must be selected in ActiveSync to be transferred.

Connecting Directly to an E-Mail Server

In addition to synchronizing e-mail messages with your computer, you can send and receive e-mail messages by connecting to an e-mail server using a modem or network card connected to your device. You need to set up a remote connection to a network or an ISP, and a connection to your e-mail server. For more information, see "Getting Connected" on page 93.

When you connect to the e-mail server:

- New messages are downloaded to the device **Inbox** folder.
- Messages in the device **Outbox** folder are sent.
- Messages that have been deleted on the e-mail server are removed from the device **Inbox** folder.

Messages that you receive directly from an e-mail server are linked to your e-mail server rather than to your computer. When you delete a message on your device, it is also deleted from the e-mail server the next time you connect, depending on the settings you selected in ActiveSync.

When you are working online, you read and respond to messages while connected to the e-mail server. Messages are sent as soon as you tap **Send**, which saves space on your device.

After you have downloaded new message headers or partial messages, you can disconnect from the e-mail server and then decide which messages to download completely. The next time you connect, Messaging downloads the messages you have marked for retrieval and sends the messages you have composed.

Using the Message List

Messages you receive are displayed in the message list. By default, the most recently received messages are displayed first in the list.

When you receive a message, tap to open it. Unread messages are displayed in bold.

The original messages remain on the e-mail server or your computer. You can mark the messages that you want to retrieve in full during your next synchronization or e-mail server connection. In the message list, tap and hold the message that you want to retrieve. On the pop-up menu, tap **Mark for Download**. The icons in the Inbox message list indicate message status.

You specify your downloading preferences when you set up the service or select your synchronization options. You can change the settings at any time:

- Change options for Messaging synchronization using ActiveSync options. For more information, see **ActiveSync Help** on your computer.
- Change options for direct e-mail server connections in Messaging on your device. Tap **Menu** → **Options**. On the **Account** tab, tap the service that you want to change. Tap and hold the service and select **Delete** to remove a service.

Composing Messages

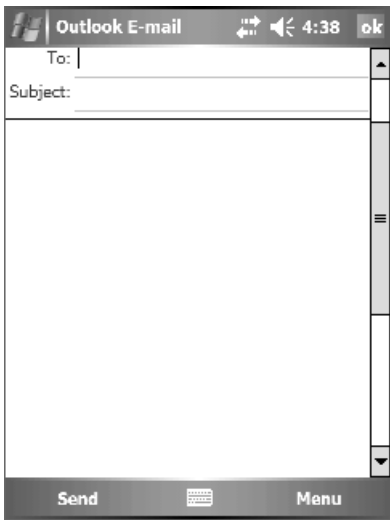

To compose and send a message:

- 1 In the message list, tap **Menu** → **Switch Accounts** and select the account.
- 2 Tap **New**.
- 3 Enter the e-mail address of one or more recipients, separating them with a semicolon. To access addresses and phone numbers from Contacts, tap **To**.
- 4 Enter your message. To quickly add common messages, tap **Menu** → **My Text** and tap a desired message.
- 5 To check the spelling, tap **Menu** → **Spell Check**.
- 6 Tap **Send**.

If you are working offline, the message is moved to the **Outbox** folder and sent the next time you connect to the network.

Managing E-Mail Messages and Folders

By default, messages are displayed in one of the five folders for each service you have created: **Inbox**, **Deleted Items**, **Drafts**, **Outbox**, or **Sent Items**. The **Deleted Items** folder contains messages that have been deleted on the device. The behavior of the **Deleted Items** and **Sent Items** folders depends on the options you have selected. To change the options, tap **Menu** → **Tools** in the message list and tap **Options**. On the **Message** tab, select your options.

To create, rename, or delete a folder, tap **Menu** → **Tools** → **Manage Folders**. To move a message to another folder, tap and hold the message in the message list and tap **Move to** on the pop-up menu.

Folder Behavior With a Direct Connection to an E-Mail Server

The behavior of the folders you create depends on whether you use ActiveSync, POP3, or IMAP4.

- *If you use ActiveSync*, e-mail messages in the **Inbox** folder in Outlook are automatically synchronized with your device. You can synchronize additional folders by designating them for ActiveSync. The folders you create and the messages you move are then mirrored on the server. For example, if you move messages from the **Inbox** folder to a folder named **Family**, and you have designated **Family** for synchronization, the server creates a copy of the **Family** folder and copies the messages into that folder. You can then read the messages while away from your computer.
- *If you use POP3* and you move e-mail messages to a folder you created, the link is broken between the messages on the device and their copies on the e-mail server. The next time you connect, the e-mail server detects that the messages are missing from the device Inbox and deletes them from the server. This prevents you from having duplicate copies of a message. However, you can access these folder contents from the device only.
- *If you use IMAP4*, the folders you create and the e-mail messages you move are mirrored on the server. Therefore, messages are available to you any time you connect to your e-mail server, whether it is from your device or computer. This synchronization of folders occurs whenever you connect to the server, create new folders, rename, or delete folders when connected.

Notifications

You can set your device to remind you when you have something to do. For example, if you have set up an appointment in Calendar, a task with a due date in Tasks, or an alarm in Clock, you are notified in one of the following ways:

- A message box appears on the screen
- A sound, which you can specify, plays
- A light flashes on your device

To configure the reminders and sounds for your device:

- 1 Tap **Start** → **Settings**.
- 2 On the **Personal** tab, tap **Sounds & Notifications**.
 - **Sounds** tab — Adjust the volume and enable sounds
 - **Notifications** tab — Set notifications for specific events

Beaming an Item

In the Calendar, Contacts, Notes, Tasks, Excel Mobile, Word Mobile, PowerPoint Mobile, and Pictures programs, you can beam files and information to other devices using Bluetooth or infrared.

- 1 From the program, select the item you want to beam, such as an appointment in **Calendar**, a task in **Tasks**, a contact card in **Contacts**, or a file in **File Manager**.
- 2 Tap **Menu** → **Beam** [type of item].
- 3 Do one of the following:
 - If using Bluetooth, tap the device to which you want to send the item.
 - If using infrared, align the infrared (IR) ports at close range until the target device name appears, and then tap the device to which you want to send the item.

Using File Explorer

File Explorer lets you browse the folder contents on your device. The root folder is called My Device. My Device is similar to My Computer on the computer and contains My Documents, Program Files, Temp, Storage Card, and Windows folders, among others.

To find an item:

- 1** Tap **Programs** → **File Explorer**.
The **My Documents** folder and its subfolders appear.
- 2** Tap the folder list (labeled **My Documents** by default) and tap the folder you want to explore.
- 3** To open an item, tap it.
- 4** To quickly delete, rename, or copy an item, tap and hold the item.
- 5** To select multiple items, tap and drag. Then, tap and hold the selected items, and tap a command.

Getting Connected

You can use your device to exchange information with other mobile devices or with a computer, a network, or the Internet. You can use any of the following connection options:

- Use the infrared (IR) port on your device to send and receive files between two devices. See the following section, "Using Infrared," for more information.
- Connect to your Internet Service Provider (ISP). Once you are connected, you can send and receive e-mail messages using Messaging, and view Web or WAP pages using Internet Explorer Mobile. The communication software for creating an ISP connection is already installed on your device. Your service provider provides the software needed to install other services, such as paging and fax services.
- Connect to the network at the company or organization where you work. Once connected, you can send and receive e-mail messages using Messaging, view Web or WAP pages using Internet Explorer Mobile, and synchronize with your computer.
- Connect to your computer to synchronize remotely. Once you are connected, you can synchronize information such as your Pocket Outlook information. See Microsoft ActiveSync[®] Help on your computer or Connections Help on the device for more information.

Using Wi-Fi (802.11b)

Wi-Fi provides your device access to WLAN (Wireless Local Area Network.) Short for wireless fidelity, Wi-Fi refers to any type of 802.11 network, whether 802.11b, 802.11a, or dual-band. Wi-Fi certified products from different manufacturers are interoperable.

 **NOTE:** Mid and High configurations of the Axim have Wi-Fi 802.11b built in and the drivers factory installed. For a Low configuration device, you must purchase the 802.11b SD card, insert it in your device, and load the drivers.

 **NOTE:** The default Wireless Networking Client utility for your device is the Dell WLAN utility. The following configuration steps are for the Dell WLAN utility.

Configure wireless networking for your device in one of the following scenarios:

- Network Card is set up
- Wireless Network is broadcasting SSID
- Wireless Network is not broadcasting SSID

If the Network Card is Set Up

Normally the internal wireless card is already set up. There are times when you must choose the network card. On the Axim X51/X51v configurations that have built-in wireless, the network card is associated with the enabled wireless. If wireless is not enabled or you are using a socket card for wireless connection, then choose the network card:

- 1 Tap **Start** → **Settings** → **Connections**.
- 2 Tap **Network Cards**.
- 3 Choose either **Internet** or **Work** from the menu.
- 4 Choose the network card to connect to the network. For the Axim X51/X51v with built-in wireless, choose **Dell Axim X51/X51v WLAN Wireless Adapter**.
- 5 Choose whether the network card assigns an IP address or receives an IP address automatically.
- 6 Enter the Server IP addresses if required and tap **OK**.

If the Wireless Network is Broadcasting SSID

- 1 Press the wireless button to enable wireless capability. The green LED in the right top corner of the device indicates that the wireless is functional.
- 2 Tap **Start** → **Settings** → **Connections**.
- 3 To add, edit, or delete a profile, select the corresponding action and tap **Network Cards**.
- 4 In the **Configure Wireless Networks** window, select one of the available network names and tap **OK**.

If the Wireless Network is Not Broadcasting SSID

The Configure Wireless Networks window only shows wireless networks that broadcast a Network Name (SSID) and those that have been added. Add the network if it is not listed. Contact your network administrator for the following information:

- SSID (network name)
- Authentication
- Data Encryption
- Keys (if the key is not provided automatically)
- Log in if necessary

To configure the wireless network:

- 1** From the **Configure Wireless Networks** window, tap **Add New**.
- 2** Provide the **Network Name (SSID)**.
- 3** Select either **Internet** or **Work** in the **Connects To** box.
 - Selecting **Internet** allows you to connect to your network but you will have to manually start a VPN connection, if needed.
 - Selecting **Work** automatically starts a VPN connection any time you connect to the network.
 - If you are having trouble connecting to your network, change the **Connects To** box to **Internet**.
- 4** Tap the **Network Key** tab.
- 5** Enter the **Authentication** and **Data Encryption** information. If a key is required, enter the network key.
- 6** Select the **802.1x** tab.
- 7** The **Authentication** and **Data Encryption** chosen on the previous screen determines whether this screen is available. If available choose the **EAP type** used on the network.
- 8** Tap **OK**.
- 9** If more than one network is listed, tap and hold the stylus on the network name you want to connect to. A pop-up menu appears. Tap **Connect**. After a few seconds you should see **Connected** next to the wireless network you selected.

Using Odyssey Client

Odyssey is a wireless LAN access control and security solution that provides strong security over the wireless link. It secures authentication and connection of wireless LAN (WLAN) users, ensuring that only authorized users can connect.

Odyssey is mostly used in place of a manufacturer's wireless networking client such as the Dell WLAN utility, Intel ProSET, or Windows XP's Zero Config Service.

To use Odyssey:

- Tap **Start** → **Settings** → **Connections Tab** → **Odyssey Client**. The main page appears with the following information:
 - Status of Odyssey
 - Network Name (SSID)
 - Access Point MAC
 - Packet information
- To enable the Odyssey Client tap **Settings** → **Enable Odyssey**.
- To configure a wireless profile, tap **Settings** → **Configure**. This provides you a list of existing profiles and allows you to add, edit, or delete profiles.

Adding a Network

To add a new profile:

- 1 Tap **Settings** → **Configure** → **Add**. The **Add Network Wizard** window appears.
- 2 Enter the network name, or select the box **Any** if you want the client to connect to any available network.
- 3 Tap **Scan** to view all available broadcasted networks. Enter a description if necessary.
- 4 Select between an ad-hoc or infrastructure network.
- 5 Tap **Next** when ready.

- 6** Enter security settings:
 - **Association Mode** allows for open, shared, or WPA association methods.
 - **Encryption Method** changes based on what mode is chosen. Options include none, WEP, and TKIP.
 - If 802.1x is used, check the box **Authenticate using 802.1X**.
 - For WPA-PSK, enter your **Passphrase** (key).
- 7** Depending on your selections, the next page appears. You could be asked to enter a WEP key or username and password.
- 8** Tap **Next**.
- 9** Here you can select EAP (Extensible Authentication Protocol) methods. Default settings only include EAP / TTLS.
 - a** If you need other EAP methods, tap **Add**.
 - b** After adding other EAP methods, tap **OK**.
 - c** Tap **Next**.
- 10** Enter an anonymous name to keep your login name private. This name will be used for outer visible authentication. Tap **Next**.
- 11** Depending on the EAP method you chose, select an inner authentication protocol. Tap **Next**.
- 12** Enter username and password and tap **Next**.
- 13** Tap **Finish**.
- 14** When done, the new profile is added to the networks to choose from. To select a profile to connect to, tap **OK** in the upper right corner.
- 15** When you return to the **Today** page, there will be a new icon in the systems tray for Odyssey.

Using Cisco[®] LEAP Wireless LAN Security

Your Dell Axim X51/X51v supports 802.1x network authentication between the client and server with a logon password using Cisco LEAP.

Cisco LEAP can be configured using the Odyssey Client application.

 **NOTE:** Before starting, ensure that the Wireless power is enabled using the Wireless On/Off button.

 **NOTE:** LEAP is not supported on a peer-to-peer network. LEAP is not supported on a low configuration Axim X51.

To start Odyssey Client:

- 1 Tap **Start** → **Settings** → **Connections** → **Odyssey Client** icon.
- 2 Tap **Settings** → **Enable Odyssey**.

To start using LEAP:

- 1 Obtain the following information from your network administrator:
 - Network name
 - Association mode
 - Encryption method
- 2 From the **Odyssey Client** window, tap **Settings** → **Configure** → **Add**.
- 3 Enter the network name (SSID) if known, or tap **Scan** to search for available Access Points. Tap **Next**.
- 4 LEAP will only support an infrastructure network, so do not change the default settings in the drop-down menu. Tap **Next**.
- 5 Fill in the **Association Mode** and **Encryption** method. Tap **Next**.
- 6 **EAP/TTLS** is the default EAP type. Tap **Add** and select **EAP/LEAP** in the window that opens up.

Unless you have an authentication certificate to use TTLS and have configured your system to support it, remove **EAP/TTLS**.

 **NOTE:** Failure to remove EAP/TTLS when it is not properly set up may prevent your wireless security system from functioning.

- 7 Tap **Next**.
- 8 Enter your user name and password. Tap **Next**.
- 9 Tap **Finish** to complete LEAP configuration.

- 10 Tap **OK**.
- 11 Select the network that you added from the drop-down menu and tap the box beside **Connect to**. The status displays as connected (authenticated) when this process is complete.

 **NOTE:** For further details, please refer to the Odyssey Client help file included in your device. You can access the help file at **Start** → **Help** → **Odyssey Client for Pocket PC** or tap **Help** from the **Odyssey Client** main screen.

Using Odyssey Client to Get a Certificate of Authority

There are two ways to get certification in Odyssey client.

- Certificate Enroller
- Import User Certificate

Use the Certificate Enroller to install a user certificate using Microsoft Certificate Services. Use Import User Certificate to install the **.pfx** certificate file stored in the device. To decide the certificate type, ask your network administrator.

To use the Certificate Enroller:

- 1 Using the Odyssey client, connect to a non 802.1x enabled wireless network on which the certificate server is located.
- 2 Tap **Start** → **Settings** → **Connections** → **Odyssey Client**.
- 3 Tap **Tools** → **Certificate Enroller**.
- 4 Enter the IP address of the certificate server in the **Server** field.
- 5 Enter the user name and the domain name in the **User name** field using the following rule:
Domain-name\User-name
- 6 Tap **Request**.

To use the Import User Certificate:

 **NOTE:** Before you install a certificate, you must know its RSA-type private key password.

- 1 Tap **Start** → **Settings** → **Connections** → **Odyssey Client**.
- 2 Tap **Tools** → **Import User Certificate**.

- 3 Tap **Browse** to navigate to a **.pfx** file you have stored on your device. Select the file, and tap **OK**.
- 4 Type in the RSA-type private key password for this certificate under **Private key password**. You can optionally click **Unmask** to make this password visible while you type it.
- 5 Tap **Install Certificate** when you are done.

Using Infrared

Infrared is used to send and receive information remotely, such as contacts and appointments, between two devices.

To send information:

- 1 Switch to the program where you created the item you want to send and locate the item in the list.
- 2 Align the infrared sensors so that they are unobstructed and within close range.
- 3 Tap and hold the item, and tap **Beam xxxx** on the pop-up menu, where xxxx is the item you want to beam.

You can also send items (excluding folders) from File Explorer. Tap and hold the item you want to send, and tap **Beam File** on the pop-up menu.

Using Bluetooth® Wireless Technology

Bluetooth is a wireless technology aimed at simplifying communications between devices and the Internet. It is an open specification for short-range communication of data and voice. For example, it can synchronize data between hand-held devices and other computers.

Supported Bluetooth Profiles:

- Generic Access
- Service Discovery Application
- Serial Port
- Generic Object Exchange Dial-up Networking
- Object PUSH
- HID

To configure a device with Bluetooth wireless technology in a Pocket PC environment:

- 1 Ensure that the two devices are turned on, discoverable, and within close range.
- 2 Tap **Start** → **Settings** → **Connections** tab.
- 3 Tap **Bluetooth** → **Devices** tab → **New Partnership**. Your device searches for other Bluetooth devices and displays them in the list.
- 4 Tap the name of the other device, and tap **Next**.
- 5 In the **Passkey** field, if you want to use a passkey (recommended for enhanced security), enter a alphanumeric passkey between 1 and 16 characters, and tap **Next**. Otherwise, leave **Passkey** blank, and tap **Next**.



NOTE: The **Passkey** for a remote Bluetooth device is usually found in the user manual for that device. The default **Passkey** for any Dell Axim is 1234.

- 6 Enter the same passkey for the other device.
- 7 Tap **Finish**.

An active connection with Bluetooth wireless technology is created and pairing of the two devices is complete.



NOTE: For more information about using Bluetooth wireless technology, tap **Start** → **Help** → **Setting Up Connections**.

Creating a Modem Connection

To create a modem connection:

- 1 Install a modem card and appropriate adapters to connect an external modem to your device through the serial port.
- 2 Obtain the following information from your ISP:
 - ISP dial-up access telephone number
 - Username and password
 - TCP/IP settings

Some ISPs require information in front of the username, for example, *MSN/username*.

- 3 Tap **Start** → **Settings** → **Connections** tab → **Connections**.

- 4** Under **My ISP** or **My Work Network**, tap **Add a new modem connection**.
 - 5** Enter a name for the connection, such as **ISP Connection**.
 - 6** From the **Select a modem** list, select your modem type, and tap **Next**.
If your modem type does not appear, try reinserting the modem card.
If you are using an external modem connected to your device with a cable, select **Hayes Compatible on COM1**. See the modem user guide for details.
 - 7** Enter the phone number just the way you would dial it. If you need an area code, be sure to include it. Tap **Next**.
 - 8** Enter your user name, password, and, if applicable, your domain. This information is provided by your ISP or network administrator.
-  **NOTE:** You should not need to change any settings in **Advanced**. Most ISPs now use a dynamically assigned address.
- 9** If the ISP you are connecting to does not use a dynamically assigned address, tap **Advanced**, tap the **TCP/IP** tab, and then enter the address.
 - 10** Tap **OK**.
 - 11** Select other required options and tap **Finish**.

When you open **Messaging**, **Internet Explorer Mobile**, or **MSN Messenger**, your device automatically connects. Once you are connected, you can:

- Send and receive e-mail messages using **Messaging**. Before you can use **Messaging**, you need to provide the information that **Messaging** needs to communicate with the e-mail server. See "Connecting Directly to an E-Mail Server" on page 105 for more information.
- See **Web and WAP** pages using **Internet Explorer Mobile**. For more information, see "Using Internet Explorer Mobile" on page 119.
- Send and receive instant messages with **MSN Messenger**. For more information, see "MSN Messenger" on page 116.

Creating an Ethernet Connection

The term Ethernet refers to the family of LAN products covered by the IEEE 802.3 standard. It defines what is commonly known as the CSMA/CD protocol.

To create an ethernet connection:

- 1 Contact your network administrator to obtain a user name, password, and domain name.
- 2 Install the network card driver, if required. For more information, see the documentation that came with your network card.
- 3 The **Network Settings** window appears automatically the first time you insert the network card, so that you can configure the network card. To change settings later, tap **Start** → **Settings** → **Connections** tab → **Connections**.
- 4 If you need to enter specific server information, tap the appropriate adapter, and then tap **Properties**. You may need to enter proxy server and VPN connection settings. For more information, see your network administrator.
 **NOTE:** Most networks use DHCP (Dynamic Host Configuration Protocol), so you do not need to change the connection settings unless your network administrator instructs you to do so.
- 5 If necessary, connect the network card to the network with a network cable. For more information, see the documentation that came with your network card.

Creating a VPN Connection

A Virtual Private Network (VPN) is constructed using public wires to connect nodes. These systems use encryption and other security mechanisms to ensure that only authorized users can access the network and that data cannot be intercepted.

- 1 Tap **Start** → **Settings** → **Connections** tab → **Connections**.
- 2 Tap **Add a new VPN server connection**.
 **NOTE:** If you have already created a VPN Server, tap **Edit My VPN Servers** then tap **New**.

- 3 Enter a name for the connection.
- 4 In the **Host name/IP** field, enter the VPN server name or IP address. Your network administrator provides you this information.
- 5 Depending on the type of authentication that you want to use with your device, tap **IPSec** or **PPTP** next to **VPN type**.
If you are unsure about which option to select, contact your network administrator.
- 6 Tap **Next** and enter your username, password, and, if required, domain.
- 7 Install the network card driver, if required. For more information, see the documentation that came with your network card.
- 8 Tap **Finish**.
- 9 To manually start a connection, tap and hold the connection, and tap **Connect**.



NOTE: A VPN connection requires physical connection to a network. Ensure the unit is linked to a wire or wireless network before you manually start a VPN connection.

Ending a Connection

To disconnect:

- To delete a connection, tap and hold the connection you want to remove, and tap **Delete**.
- When connected through a cable or cradle, detach your device from the cable or cradle.
- When connected through the infrared sensor, move the device away from the computer.
- When connected through a network (Ethernet) card, remove the card from your device.

Connecting Directly to an E-Mail Server

You can set up a connection to an e-mail server so that you can send and receive e-mail messages using a modem or network connection and Messaging on your device.



NOTE: The ISP or network must use a POP3 or IMAP4 e-mail server and an SMTP gateway.

You can use multiple e-mail services to receive your messages. For each e-mail service you intend to use, you must first set up and name the e-mail service. If you want to use the same service to connect to different mailboxes, set up and name each mailbox connection.

To set up an e-mail service:

- 1 In **Messaging** on your device, tap **Accounts** → **New Account**.
- 2 Follow the directions in the E-mail Setup wizard.

For more information, tap **Start** → **Help**.

To connect to your e-mail server, tap **Account** → **Connect**. For more information on using the Messaging program, see "Messaging" on page 86.

Getting Help on Connecting

For more information on getting connected, see the following resources:

- "Messaging" on page 86.
- Online Help on the device. Tap **Start** → **Help**. Tap **Messaging** or **Connections**.
- ActiveSync Help on your computer. In ActiveSync, click **Help** → **Microsoft ActiveSync Help**.
- See www.microsoft.com/windowsmobile for troubleshooting information.

Adding and Removing Programs

Some programs are already installed in the ROM when you received your device. You cannot remove these programs or accidentally lose the ROM contents. You can update ROM programs using installation programs with the *.pku extension. You can save data to Flash ROM.

You can install any program created for your device, as long as your device has sufficient memory. The most popular place to find software for your device is on the Microsoft® Windows Mobile™ Version 5.0 software for Pocket PC Premium Edition website: www.microsoft.com/windowsmobile.

Adding Programs Using Microsoft® ActiveSync®

Before installing software on your device, you need to install ActiveSync on your computer. See ActiveSync Help on your computer for more information.



NOTE: Customers need to have ActiveSync 4.0 or later revision before using Axim. ActiveSync 4.0 or later is available on the *Getting Started* CD. For more help on ActiveSync, visit the following website:
<http://www.microsoft.com/windowsmobile/help/activesync/default.msp>

- 1 Determine your device and processor type so that you know which version of the software to install:
 - a Tap **Start** → **Settings**.
 - b On the **System** tab, tap **About**.
 - c From the **Version** tab, record the processor information.
- 2 Download the software to your computer (or insert the *Getting Started* CD or floppy that contains the software into your computer). You may see a single *.exe or *.zip file, a **Setup.exe** file, or several versions of files for different device types and processors. Ensure that you select the program designed for the Pocket PC and your device processor type.

- 3** Read any installation instructions, readme files, or documentation that comes with the program. Many programs provide special installation instructions.
- 4** Connect your device to your computer.
- 5** Double-click the *.exe file.

If the file is an installer file, the installation wizard begins. Follow the directions on the screen. Once the software is installed on your computer, the installer automatically transfers the software to your device.

If the file is not an installer file, you receive an error message stating that the program is valid but that it is designed for a different type of computer. You need to move this file to your device. If you cannot find any installation instructions for the program in the readme file or documentation, use ActiveSync Explore to copy the program file to the **Program Files** folder on your device. For more information on copying files using ActiveSync, see ActiveSync Help on your computer.

To open a program after the installation is complete, tap **Start** → **Programs** and then tap the program icon.

Downloading Programs From the Internet

- 1** Determine your device and processor type so that you know which version of the software to install:
 - a** Tap **Start** → **Settings**.
 - b** On the **System** tab, tap **About**.
 - c** From the **Version** tab, record the processor information.
- 2** Using Internet Explorer Mobile, download the program to your device. You may see a single *.exe, or *.zip file, a **Setup.exe** file, or several versions of files for different device types and processors. Ensure that you select the program designed for the Pocket PC and your device processor type.
- 3** Read any installation instructions, readme files, or documentation that comes with the program. Many programs provide special installation instructions.
- 4** Tap the file, such as a *.exe file.

The installation wizard begins. Follow the directions on the screen.

Adding a Program to the Start Menu

1 Tap **Start** → **Settings**.

2 Tap **Menus** and then tap the check box for the program.

If the program is not listed, you can either use File Explorer on the device to move the program to the **Start Menu** folder, or use ActiveSync on the computer to create a shortcut to the program using the following steps:

- a** Use Explorer in ActiveSync to explore your device files and locate the program.
- b** Right-click the program and click **Create Shortcut**.
- c** Move the shortcut to the **Start Menu** folder in the Windows folder. The shortcut now appears on the **Start** menu. For more information, see ActiveSync Help on your computer.

Removing Programs

1 Tap **Start** → **Settings**.

2 Tap **System** → **Remove Programs**.

3 Tap and hold the name of the program, and tap **Delete** in the pop-up menu.

If the program does not appear in the list of installed programs, use File Explorer on your device to locate the program.

6

Using Companion Programs

Companion programs include Word Mobile, Excel Mobile, PowerPoint Mobile, and Windows Media Player for Pocket PC.

To use a companion program on your device, tap Start → Programs, and then tap the program name.



NOTE: Before connecting your device to a computer for the first time, install ActiveSync on the computer using the *Dell™ Getting Started CD*.

Word Mobile

Word Mobile works with Microsoft Word on your computer to give you easy access to copies of your documents. You can create new documents on your device, or you can copy documents from your computer to your device. Synchronize documents between your computer and your device to have up-to-date content in both locations.

Use Word Mobile to create documents, such as letters, meeting minutes, and travel reports.

To create a new file:

- 1 Tap Start → Programs → Word Mobile.
- 2 Tap New.

A blank document appears. Or, if you selected a template for new documents in the **Options** dialog box, the template appears with the appropriate text and formatting already provided.



You can open only one document at a time. If you open a second document, you are asked to save the first one. You can create, save, or edit a document in a variety of formats, including Word (.doc), Word template (.dot), Rich Text Format (.rtf), and Plain Text (.txt).

Word Mobile contains a list of the files stored on your device. Tap a file in the list to open it. To delete files, make copies, or send files, tap and hold a file in the list. Then select the appropriate action in the pop-up menu.

You can enter information in Word Mobile by typing, writing, drawing, or recording. These modes appear on the View menu. Each mode has its own toolbar, which you can show and hide by tapping the Show/Hide Toolbar icon on the command bar.

To change the zoom magnification, tap View → Zoom, and then select the percentage you want. Select a higher percentage to enter text and a lower percentage to see more of your document.

If you are opening a Word document created on a computer, select **Wrap to Window** on the **View** menu, so that you can see the entire document.

Excel Mobile

Excel Mobile works with Microsoft Excel on your computer to give you easy access to copies of your workbooks. You can create new workbooks on your device, or you can copy workbooks from your computer to your device. Synchronize workbooks between your computer and your device, to have up-to-date content in both locations.

Use Excel Mobile to create workbooks, such as expense reports and mileage logs.

To create a new file:

- 1** Tap **Start** → **Programs** → **Excel Mobile**.
- 2** Tap **New**.

A blank workbook appears. Or, if you selected a template for new workbooks in the **Options** dialog box, the template appears with the appropriate formulae and formatting already provided.

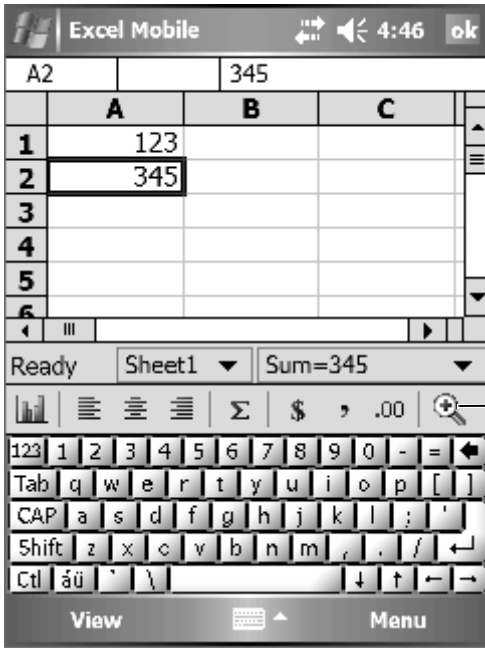

formatting toolbar

You can open only one workbook at a time. If you open a second workbook, you are asked to save the first one. You can create, save, or edit a workbook in a variety of formats, including Excel template (.xlt) and Excel (.xls).

Excel Mobile contains a list of the files stored on your device. Tap a file in the list to open it. To delete files, make copies, or send files, tap and hold a file in the list. Then select the appropriate action from the pop-up menu.

Excel Mobile provides fundamental spreadsheet tools, such as formulas, functions, sorting, and filtering. To display the toolbar, tap View → Toolbar.

Tips for Working in Excel Mobile

Use the following tips when working with large worksheets in Excel Mobile:

- Use Full Screen: Tap **View** → **Full Screen** to see as much of your worksheet as possible. To exit full-screen mode, tap **Restore**.
- Show and hide window elements: Tap **View** and then tap the elements you want to show or hide.
- Freeze panes on a worksheet: Select the cell where you want to freeze panes. Tap **View** → **Freeze Panes**. You might want to freeze the top and leftmost panes in a worksheet, to keep row and column labels visible as you scroll through a sheet.
- Split panes to view different areas of a large worksheet: Tap **View** → **Split**. Drag the split bar to where you want it. To remove the split, tap **View** → **Remove Split**.
- Show and hide rows and columns: To hide a row or column, select a cell in the row or column you want to hide. Tap **Menu** → **Format** → **Row** or **Column** → **Hide**. To show a hidden row or column, tap **Menu** → **Edit** → **Go To**, and then type a reference that is in the hidden row or column. Then tap **Menu** → **Format** → **Row** or **Column** → **Unhide**.

For more information on using Excel Mobile, tap **Start** → **Help**.

PowerPoint Mobile

PowerPoint Mobile works with Microsoft PowerPoint on your computer to give you easy access to copies of your presentation slides. Many presentation elements built into the slide shows, such as slide transitions and animations, will play back on the device. If the presentation is set up as a timed slide show, one slide will advance to the next automatically. Links to URLs are also supported.

PowerPoint features not supported on the device include:

- **Notes:** Notes written for slides will not be visible.
- **Rearranging or editing slides:** PowerPoint Mobile is a viewer only.

To start a presentation:

- 1 Tap **Start** → **Programs** → **PowerPoint Mobile**.
- 2 In the presentation list, tap the slide show you want to view.
- 3 Tap the current slide to advance to the next slide.
If the presentation is set up as a timed slide show, slides will advance automatically.

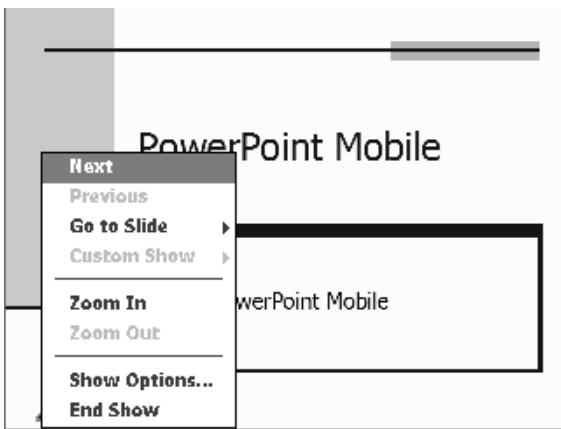

You can open only one document at a time. If you open a second document, you are asked to save and close the first one. You can view a document in a variety of formats, including PowerPoint (.ppt) and PowerPoint Mobile (.pps).

PowerPoint Mobile contains a list of the files stored on your device. Tap a file in the list to open it. To delete files, make copies, or send files, tap and hold a file in the list. Then select the appropriate action in the pop-up menu.

MSN Messenger

With the MSN Messenger instant message program, you can:

- See who is online.
- Send and receive instant messages.
- Have instant message conversations with groups of contacts.

To use MSN Messenger, you must have a Microsoft Passport account or a Microsoft Exchange e-mail account. You must have a Passport to use MSN Messenger Service. If you have a Hotmail or MSN account, you already have a Passport. Once you have obtained either a Microsoft Passport or a Microsoft Exchange account, you are ready to set up your account.

 **NOTE:** Sign up for a Microsoft Passport account at www.passport.com. Get a free Microsoft Hotmail e-mail address at www.hotmail.com.

To switch to MSN Messenger, tap Start → Programs → Pocket MSN → MSN Messenger.

 **NOTE:** Availability of MSN Messenger is subject to language base.

Setting Up

Before you can connect, you must enter Passport or Exchange account information.

To set up an account and sign in:

- 1 Tap Start → Programs → Pocket MSN → MSN Messenger.
- 2 Tap Menu → Options.
- 3 Enter your Passport or Exchange account information.
- 4 To sign in, tap the sign-in screen and enter your e-mail address and password.

Working With Contacts

The MSN Messenger window shows all of your messenger contacts at a glance, divided into Online and Not Online categories. From this view, while connected, you can chat, send an e-mail, block the contact from chatting with you, or delete contacts from your list using the pop-up menu.

 **NOTE:** If you already use MSN Messenger on your computer, your contacts show up on your device without having to be added.

To see who is online without them seeing you, tap **Menu** → **My Status** → **Appear Offline**.

If you block a contact, you appear offline but remain on the blocked contact's list. To unblock a contact, tap and hold the contact, and then tap **Unblock** on the pop-up menu.

Chatting With Contacts

- Tap a contact name to open a chat window. Enter your message in the text entry area at the bottom of the screen, or tap **My Text** to enter a preset message, and then tap **Send**.
- To invite another contact to a multiuser chat, tap **Menu** → **Chats** → **Invite**, and then tap the contact you want to invite.
- To switch back to the main window without closing a chat, tap the **Contacts** icon. To revert back to your chat window, tap **Chats**, and select the person with whom you were chatting.
- To know if the contact you are chatting with is responding, look for a message under the text entry area.

For more information on using MSN Messenger, tap **Start** → **Help**.

Microsoft Windows Media® Player for Pocket PC

Use Windows Media Player 10.0 for Pocket PC to play digital audio and video files that are stored on your device or on a network. To switch to Windows Media Player for Pocket PC, tap **Start** → **Windows Media**.

Use Windows Media Player on your computer to copy digital audio and video files to your Pocket PC. You can play Windows Media and MP3 files on your Pocket PC. For more information about using Windows Media Player for Pocket PC, tap **Start** → **Help**.

Using Internet Explorer Mobile

Use Internet Explorer Mobile to view Web or WAP pages:

- During synchronization with your computer, download your favorite links and mobile favorites that are stored in the **Mobile Favorites** subfolder in Internet Explorer on your computer.
- Connect to an Internet service provider (ISP) or network and browse the web. For more information on connecting to the Internet, see "Getting Connected" on page 93.

When the device is connected to an ISP or network, you can also download files and programs from the Internet or intranet.

To use Internet Explorer Mobile, tap Start → Internet Explorer Mobile.

Mobile Favorites

If you are using Microsoft Internet Explorer 5.0 or later on your computer, you can download mobile favorites to your device. Synchronizing mobile favorites downloads web content to your device, so that you can view pages while you are disconnected from your ISP and computer. Use the Internet Explorer plug-in installed with Microsoft ActiveSync® to create mobile favorites quickly.

To create a mobile favorite on your computer and download it to your device:

- 1** On your computer, open Internet Explorer and click **Tools → Create Mobile Favorite**.
- 2** To change the link name, enter a new name in the **Name** box.
- 3** Specify an update schedule next to **Update** (optional).
- 4** Click **OK**.
Internet Explorer downloads the latest version of the page to your computer.
- 5** In Internet Explorer on the computer, right-click the mobile favorite and click **Properties**.

- 6 In the **Download** tab, specify the number of levels deep you want to download. To conserve device memory, go only one level deep.
- 7 Synchronize your device and computer.

Mobile favorites stored in the **Mobile Favorites** folder in Internet Explorer are downloaded to your device.

If you did not specify an update schedule in step 3, you need to manually download content to keep the information updated on your computer and device. Before synchronizing with your device, click **TOOLS** in Internet Explorer on your computer and click **Synchronize**. The date in the **Last Updated** column was the last time content was downloaded to the computer. You can manually download content, if necessary.



NOTE: You can add an icon to the Internet Explorer toolbar for creating mobile favorites. In Internet Explorer on your computer, click **View** → **Toolbars**, and then click **Customize**.

Conserving Memory

Mobile favorites take up storage memory on your device. To minimize the amount of memory used:

- Turn off pictures and sounds or stop some mobile favorites from being downloaded to the device in the **Favorites** settings in the ActiveSync options. For more information, see ActiveSync Help on your computer.
- Limit the number of downloaded linked pages. In Internet Explorer on the computer, right-click the mobile favorite you want to change and click **Properties**. On the **Download** tab, specify **0** or **1** for the number of linked pages you want to download.

Mobile Favorites Folder

Only items stored in the Mobile Favorites subfolder (in the Favorites folder) in Internet Explorer on your computer are synchronized with your device. The folder was created automatically when you installed ActiveSync.

Favorite Links

During synchronization, the list of favorites in the Mobile Favorites folder on your computer is synchronized with Internet Explorer Mobile on your device. The computer and the device are updated, with changes made to either list, each time you synchronize. Unless you mark the favorite link as a mobile favorite, only the link is downloaded to your device—you need to connect to your ISP or network to view the content. For more information on synchronization, see ActiveSync Help on your computer.

Browsing Mobile Favorites and the Web

You can use Internet Explorer Mobile to browse mobile favorites and channels that you have downloaded to your device without connecting to the Internet. You can also connect to the Internet through an ISP or a network connection and browse the Web.



favorites icon

To view mobile favorites and channels:

- 1 Tap the favorites icon to display your list of favorites.
- 2 Tap the page you want to view.

The page that was downloaded the last time you synchronized with your computer appears. If the page is not on your device, the favorite is dimmed. You need to synchronize with your computer again to download the page to your device, or connect to the Internet to view the page.

To browse the Internet, set up a connection to your ISP or corporate network using **Connections**, as described in "Getting Connected" on page 93.



NOTE: To add a favorite link, go to the page you want to add, tap and hold the page, and then tap **Add to Favorites**.

To connect to and browse the Internet, you can either:

- Tap the **Favorites** icon and tap the favorite you want to view.
- In the address field that appears at the top of the Internet Explorer screen, enter the Web address you want and tap the icon to the right, or the down arrow to select previously entered addresses.

Maintenance and Troubleshooting

Maintaining the Axim

To conduct periodic maintenance of your device, use the Dell Axim Self Diagnostic Utility available on the Getting Started CD. This diagnostic utility tests many features of your device: buttons, operating system version, battery status, video play, LED, driver, mirror mode, Bluetooth, Wireless, and USB Link Test.

Installing the Diagnostic Utility

To install the utility:

- 1 Create an ActiveSync connection between the device and a computer.
- 2 Insert the *Getting Started* CD into the computer's CD-ROM drive.
- 3 Click **Getting Started** → **Enhance Your Experience** → **Tools**.
- 4 On the tools selection menu, select **Pocket PC Applications**.
- 5 Scroll down the list until you see **Dell Axim X51/X51v Self-Diagnostic Utility**.
- 6 Click **Details** → **Install**.
- 7 Follow the instructions on the screen to install the Self-Diagnostic Utility.

To run a diagnostic, tap **Start** → **Programs** → **Axim Self-Diagnostics**.

Troubleshooting

The following table lists some common problems you might face and their probable solutions. To troubleshoot, use a single solution from the bullet list or a combination of solutions in the given order.

For soft or hard reset, please refer to "Resetting the Axim" on page 53.

Problem	Solution
Accessory with form factor as Compact Flash II or Secure Digital Card has not been detected by the device.	<ul style="list-style-type: none">• Remove the card from the slot and soft reset the device.• If the card is not detected even after soft resetting the device, remove the card from the slot and hard reset the device.• Certain cards require their own software. Install the software, if necessary.
System not responding to screen taps	<ul style="list-style-type: none">• Clean the touchscreen.• Check the button lock on the left side of the system.• Clean the touchscreen.• Soft reset the device.
System not responding to button commands	<ul style="list-style-type: none">• Check the button lock on the left side of the system.• Tap Unlock on the Today screen if it is in locked state.• Check button assignment settings.• Soft reset the device.

Problem	Solution
Device gives memory error	<ul style="list-style-type: none"> • Run the device self diagnostics. • Soft reset the device. • Hard reset the device but do not clear data. • Hard reset the device and clear data.
Bluetooth Keyboard not working	<ul style="list-style-type: none"> • Hold Left CTRL, Left FN, Right FN for 3-5 seconds. • Soft reset the device, then: <ul style="list-style-type: none"> • Tap Start → Settings → Dell Axim Executive Keyboard • Tap Enable and try to setup the keyboard again • Replace the batteries in the keyboard. • Hard reset the device, then reinstall keyboard driver.
GPS Unit not showing in Bluetooth Manager after new search	Click New Partnership to start a fresh search for devices.
No GPS signal when placed on the dashboard	Many new cars from VW, BMW and Mercedes have a metal UV filter in the front window preventing GPS signals. Try placing the GPS unit near the rear window.

Problem	Solution
Waiting for GPS signal or no GPS Info in GPS Status Window	<ul style="list-style-type: none"> • Turn off and then turn on the GPS unit. • Check Bluetooth Manager for serial port connection. • Use Auto Detect in Navigation software to find correct COM port and Baud Rate. • Check GPS unit location - Top of unit must be able to "see" the sky.
Troubleshooting Microsoft ActiveSync with your Dell Axim HandHelds	<p>To view the Microsoft ActiveSync Help on your computer, launch Microsoft ActiveSync, and click Help→Microsoft ActiveSync.</p> <p>For more information on troubleshooting Microsoft ActiveSync, see http://www.microsoft.com/windowsmobile/help/activesync/default.msp</p>

For more troubleshooting steps, please refer to your soft copy manual in the CD shipped together with your keyboard.

File Download Security Warning

The following File Download Security Warning message appears when attempting to install software programs on your Dell system running Microsoft® Windows® XP Service Pack 2 (SP2).



As a safety precaution, the File Download Security Warning appears whenever you attempt to install a software program on your system. This occurs regardless of who makes the software you are attempting to install.

 **NOTE:** This warning does not indicate a problem with your Dell system.

A

Appendix

Specifications

System Information

Processor	Hi	Intel® XScale™ PXA270 processor at up to 624 MHz
	Med	Intel® XScale™ PXA270 processor at up to 520 MHz
	Low	Intel® XScale™ PXA270 processor at up to 416 MHz
Memory	Hi	64 MB/256 MB NAND Flash ROM
	Med	64 MB/128 MB NAND Flash ROM
	Low	64 MB/128 MB NAND Flash ROM
Operating System		Microsoft® Windows Mobile™ Version 5.0 software for Pocket PC Premium Edition

Display

Type		QVGA, VGA TFT Color 16-bit, touch-sensitive, transreflective display
Size	Hi	3.7 inches (VGA)
	Med	3.5 inches (QVGA TFT)
	Low	3.5 inches (QVGA TFT)
Resolution		240 x 320 at 65,536 colors (QVGA) 480 x 640 at 65,536 colors (VGA)
LCD brightness		QVGA: 100 nits VGA: 100 nits

Controls and Lights

Navigation	5-way navigation button
Buttons:	four program buttons: Calendar, Contacts, Messaging, Home power on/off on/off button for WLAN/Bluetooth® wireless technology voice record button reset button lock button
Lights:	synchronization/communication event notification charge status

Expansion Slots

Secure Digital memory card	one Secure Digital memory card slot (3.3v) supports 1-bit and 4-bit SDIO card
CompactFlash card	one CompactFlash Type II card slot (3.3v)

Ports and Connectors

Infrared	standard v1.2 (115 kbps)
Cradle/synchronization connector	36-pin connector
Audio	stereo headphone with mono microphone supported connector

Physical

Dimensions:

Length	119.0 mm (4.69 inches)
Width	73.0 mm (2.87 inches)
Height	16.9 mm (0.67 inch)

Weight	Hi	175 g (6.2 oz) VGA with standard battery
--------	----	--

NOTE: The weight described refers to the device, not including the CompactFlash card or the Secure Digital memory card.

	Med	167 g (5.9 oz) VGA with standard battery
	Low	167 g (5.9 oz) VGA with standard battery

Audio

Audio controller	WM8750L sound chip
Stereo conversion	16-bit stereo; 8.0-, 11.025-, 22.05-, and 44.1-KHz sample rate
Record	full duplex record and playback
Microphone/speaker	integrated
Headphone	stereo connector

Graphics

Hi	Marathon
----	----------

Wireless Connectivity

WLAN (802.11b)	Hi	802.11b
	Med	802.11b
	Low	SDIO card only (CF not supported)
Network standard		IEEE 802.11b
Data rate		1 Mbps, 2 Mbps, 5.5 Mbps, 11 Mbps
Modulation		CCK (11 Mbps, 5.5 Mbps); DQPSK (2 Mbps); DBSPK (1 Mbps)
Network architecture		ad-hoc and infrastructure
Operating frequencies		2.4–2.497 GHz
Operating channels		1–11 (North America); 1–13 (Europe and Japan)
RF output power		13.0 dBm maximum
Range		indoor — up to 10 m (120 ft) at 5 Mbps and 75 m at 0.5 Mbps
Client utility		automatic location profile, site survey, diagnostics, current link status, ping
Software support		Wi-Fi certified
Lights		green (WLAN status) blue (Bluetooth wireless technology status)
Switch		manual radio on/off (hardware button and software switch) to comply with aviation restrictions
Bluetooth wireless technology		2.4-GHz ISM band operation; compatible Bluetooth 1.2 wireless technology; includes manager for Bluetooth with wireless technology; Class II device; Max 4 dBm o/p power; 3.3V operation; UART interface

Power Supply

Battery type:

Main	1100-mAh lithium-ion removable, rechargeable battery (standard) 2200-mAh lithium-ion removable, rechargeable battery (optional)
Backup	Capacitor to preserve RTC data

AC adapter:

Supply voltage	100–240 VAC
Frequency	50–60 Hz
Current consumption	0.4 A
Output voltage	5.4 VDC
Output current	2.41 A

Environmental

Temperature range:

operating	0° to 40°C (32° to 104°F)
storage	–20° to 60°C (–4° to 140°F)

Thermal gradient:

operating	15°C (59°F) per hour maximum
storage	20°C (68°F) per hour maximum

Relative humidity (maximum):

operating	10% to 90% non-condensing
storage	5% to 95% non-condensing

Environmental (continued)

Altitude (maximum):

operating	0 to 3048 m (0 to 10,000 ft)
storage	0 to 12,190 m (0 to 40,000 ft)

Maximum shock (measured with a 2 ms half-sine pulse):

operating	200 G
storage	400 G

Maximum vibration (using a random-vibration spectrum that simulates user environment):

operating	2.6 GRMS
storage	3.41 GRMS

Glossary

802.11 (Wi-Fi) — A wireless technology standard for mid-range networking devices that allows for enabled devices to automatically recognize each other.

BLUETOOTH® WIRELESS TECHNOLOGY — A wireless technology standard for short-range (10 m [30 ft]) networking devices that allows for enabled devices to automatically recognize each other.

COMPACTFLASH CARD — A removable card that is used to expand the capabilities of a device. Common types of CompactFlash cards include memory and wireless cards.

CRADLE — A device that allows your handheld device to synchronize with a computer, recharge its battery, and run on AC power.

DHCP — dynamic host configuration protocol — A communication protocol that allows network administrators to manage and automate the assignment of Internet Protocol addresses to computers in a network.

IMAP — Internet message access protocol — A standard client/server protocol that allows you to access your e-mail from your device. Using IMAP, you can store and browse your e-mail on the ISP's server.

INFRARED SENSOR — A port that allows you to transfer data between the computer and infrared-compatible devices without using a cable connection.

ISP — Internet service provider — A company that allows you to access its host server to connect directly to the Internet, send and receive e-mail, and access websites. The ISP typically provides you with a software package, username, and access phone numbers for a fee.

LAN — local area network — A computer network covering a small area. A LAN usually is confined to a building or a few nearby buildings. A LAN can be connected to another LAN over any distance via telephone lines and radio waves to form a wide area network (WAN).

PIM — personal information manager — A program that stores and organizes your personal information, such as Calendar, Contacts, Messaging, and Tasks.

POP3 — post office protocol 3 — A standard client/server protocol that allows you to access your e-mail on the ISP's server. Using POP3, you must download your e-mail to your device to view and browse your messages.

RAM — random-access memory — The primary temporary storage area for program instructions and data. Any information stored in RAM is lost when you perform a reset.

RAS — remote access server — A type of server that allows users to access a network from a remote location.

ROM — read-only memory — Memory that stores data and programs that cannot be deleted or written to by the device. ROM, unlike RAM, retains its contents after you perform a reset. Some programs essential to the operation of your device reside in ROM.

SDRAM — synchronous dynamic random-access memory — A type of DRAM that is synchronized with the optimal clock speed of the microprocessor.

SECURE DIGITAL MEMORY CARD — A type of removable memory commonly used in digital cameras, handheld devices, cell phones, and other devices. Secure Digital memory cards are approximately the size of a postage stamp.

SERIAL CONNECTOR — An I/O port often used to connect devices such as a handheld digital device or digital camera to your computer.

SMS — short message service — A service that is capable of sending short messages to wireless devices.

SMTP — simple mail transfer protocol — A type of protocol used for sending and receiving e-mail. SMTP is typically coupled with POP3 or IMAP.

SYNC CABLE — A cable through which you can connect a handheld device to a computer to transfer or synchronize files.

SYNCHRONIZATION — An automated process that replaces the files in one location with the most updated files from another location. For example, you can synchronize the files on your computer with the files on your handheld device.

TCP/IP — transmission control protocol/Internet protocol — The basic communication language of the Internet. TCP/IP can also be used as a communication protocol in an intranet or extranet.

USB — universal serial bus — A hardware interface for a low-speed device such as a USB-compatible keyboard, mouse, joystick, scanner, set of speakers, printer, broadband devices (DSL and cable modems), imaging devices, or storage devices. Devices are plugged directly into a 4-pin socket on your computer or into a multiport hub that plugs into your computer. USB devices can be connected and disconnected while the computer is turned on, and they can also be daisy-chained together.

VPN — virtual private network — A set of communication protocols that allows remote users to securely access a network.

WAP — wireless application protocol — A standardization for the way that wireless devices access the Internet.

Index

A

- ActiveSync
 - installing, 78
- appointments
 - scheduling, 81
- audio
 - Media player, 118
 - notifications, 91

B

- battery
 - charging, 44
 - main, 42
 - using and installing, 42
- block recognizer, 67
- Bluetooth
 - settings, 76
- buttons
 - about, 47
 - Calendar, 40
 - Contacts, 40
 - Home, 40
 - locations, 39
 - navigator, 40
 - program buttons, 57
 - record, 40
 - reset, 41

C

- Calendar
 - about, 80
 - appointments, 81
 - meeting requests, 81
- Categories, 79
- command bar, 59
- communicating
 - with other devices, 93
- CompactFlash
 - about, 52
 - installing, 52
 - slot, 39
- computer
 - connecting to, 48, 51
- Contacts
 - about, 82
 - creating, 82
 - finding, 83
- cradle
 - connecting to a computer, 48

D

- data
 - backing up, 62
- delete
 - Using File Explorer, 92

- delete a contact, 60
- delete a file in Excel, 114
- delete a file in PowerPoint, 116
- delete a file in Word, 112
- device Buttons and the Stylus, 47
- disconnecting
 - dial-up connection, 104
 - from a cable or cradle, 104
 - from a network, 104
 - infrared sensor, 104
- drawing
 - creating, 72
- drawing on the Screen, 72

E

- editing
 - written text, 69
- e-mail
 - composing messages, 88
 - connecting to a server, 87, 105
 - message list, 87
 - Messaging, 86
 - organizing, 89
 - synchronizing, 86
- ethernet connection, 103
- Excel
 - about, 113
 - delete files, 114
 - tips, 115

- expansion slots
 - CompactFlash, 52
 - locations, 39

F

- File Download Security Warning, 127
- files
 - backing up, 62
 - finding and organizing, 61

H

- help
 - ActiveSync Help, 105
 - finding, 105

I

- icons
 - program, 58
 - status, 56
- infrared
 - using, 100
- input panel, 65
- Internet
 - connecting to, 93
- Internet Explorer
 - browsing the web, 121
 - favorite links, 121
 - mobile favorites, 119-120

K

keyboard
soft, 66

L

letter recognizer, 67

M

Media Player
about, 118

meeting requests
creating, 81

memory
conserving, 120

Messaging
about, 86

microphone
recording a message, 73

Microsoft® ActiveSync®, 77

Microsoft® Windows Mobile™
Version 5.0, 56

modem connection, 101

MSN Messenger
about, 116
setting up, 117
working with contacts, 117

My Text, 74
inserting, 74

N

navigation bar, 59

network
connecting to, 93

Notes
creating, 85

notifications
about, 91

P

Pocket Outlook
about, 79

pop-up menus, 60

PowerPoint
about, 115
delete files, 116

print-style text
converting written text
to, 67-68

programs
accessing, 57
adding and removing, 107
adding programs using
ActiveSync, 107
Calendar, 80
Contacts, 82
downloading, 108
Excel Mobile, 113
Media Player, 118
Messaging, 86
MSN Messenger, 116
Notes, 85

programs (*continued*)
 Pocket Outlook, 79
 PowerPoint Mobile, 115
 removing, 109
 Start menu, 109
 Switcher Bar, 58
 Tasks, 83
 Word Mobile, 111
projector, 51

R

recording
 voice messages, 73
reminders. *See* notifications
rename
 Using File Explorer, 92
reset
 button, 41
resetting the Axim, 53

S

Secure Digital card slot
 installing cards, 53
 location, 39
Service Tag, 10, 44
Settings, 74
settings
 Connections tab, 76
 Personal tab, 75
 System tab, 75

software. *See* programs
specifications, 129
stylus
 using, 47
Switcher Bar, 58
sync cable
 connecting to a computer, 50
synchronizing
 with your computer, 48

T

Tasks
 about, 83
 creating, 83
text
 converting written text to
 print-style text, 67-68
 editing, 69
 input panel, 65
 typing, 66
 written, 67-68
transcriber, 68

U

Unpacking Your Device, 37
using Cards, 52
Using File Explorer
 delete, 92
using the Batteries, 42

Using the Power Button, 47

Using Your Axim, 45

V

video

Media Player, 118

VPN connection, 103

W

Word

about, 111

delete files, 112

writing

block recognizer, 67

converting written text to
print-style text, 67-68

drawing, 72

letter recognizer, 67

on the screen, 68

transcriber, 68

Free Manuals Download Website

<http://myh66.com>

<http://usermanuals.us>

<http://www.somanuals.com>

<http://www.4manuals.cc>

<http://www.manual-lib.com>

<http://www.404manual.com>

<http://www.luxmanual.com>

<http://aubethermostatmanual.com>

Golf course search by state

<http://golfingnear.com>

Email search by domain

<http://emailbydomain.com>

Auto manuals search

<http://auto.somanuals.com>

TV manuals search

<http://tv.somanuals.com>