

Dell Storage Center SCv2080 Storage System Owner's Manual

Regulatory Model: E11J
Regulatory Type: E11J001



Notes, Cautions, and Warnings

 **NOTE:** A NOTE indicates important information that helps you make better use of your computer.

 **CAUTION:** A CAUTION indicates either potential damage to hardware or loss of data and tells you how to avoid the problem.

 **WARNING:** A WARNING indicates a potential for property damage, personal injury, or death.

Copyright © 2015 Dell Inc. All rights reserved. This product is protected by U.S. and international copyright and intellectual property laws. Dell™ and the Dell logo are trademarks of Dell Inc. in the United States and/or other jurisdictions. All other marks and names mentioned herein may be trademarks of their respective companies.

2015 - 03

Rev. A00

Contents

About this Guide.....	5
Revision History.....	5
Audience.....	5
Contacting Dell.....	5
Related Publications.....	5
1 About the SCv2080 Storage System.....	7
SCv2080 Storage System Hardware.....	7
SCv2080 Storage System Monitoring and Diagnostics.....	7
SCv2080 Storage System Front-Panel Features and Indicators.....	8
SCv2080 Storage System Back-Panel Features and Indicators.....	10
SCv2080 Storage Controller Features and Indicators	11
SCv2080 Storage System Fan Module Features and Indicators.....	16
SCv2080 Storage System PSU Features and Indicators.....	17
SCv2080 Storage System Drives.....	18
2 Replacing SCv2080 Components.....	19
Safety Precautions.....	19
Installation Safety Precautions.....	19
Electrical Safety Precautions.....	20
Electrostatic Discharge Precautions.....	20
General Safety Precautions.....	20
Pre-Replacement Procedures.....	21
Sending Diagnostic Data Using Dell SupportAssist.....	21
Contacting Dell Technical Support Services.....	21
Shutting Down a Storage Controller.....	21
Shutting Down the Storage System.....	22
Replacing PSUs.....	22
Identifying the Failed PSU.....	22
Replacing a PSU	23
Replacing Cooling Fan Modules.....	25
Identifying the Failed Cooling Fan Module.....	25
Replacing a Cooling Fan Module.....	26
Replacing Hard Drives.....	28
SCv2080 Storage System Drive Numbering.....	28
Identifying the Failed Hard Drive.....	28
Replacing a Hard Drive.....	29

Replacing the Storage Controller Battery.....	32
Replacing a Storage Controller.....	33
Identify the Failed Storage Controller.....	33
Replace a Single Storage Controller.....	35
Replace Both Storage Controllers in Succession.....	36
Replace Both Storage Controllers Simultaneously.....	38
Replacing Rack Rails.....	38
Post-Replacement Procedures.....	39
Start up the Storage System.....	39
Sending Diagnostic Data Using Dell SupportAssist.....	39
Contact Dell Technical Support Services.....	39
3 Troubleshooting SCv2080 Components.....	40
Troubleshooting PSUs.....	40
Troubleshooting Fan Modules.....	40
Troubleshooting Disk Drives.....	40
Troubleshooting Storage Controllers.....	41
4 SCv2080 Technical Specifications.....	42
Technical Specifications.....	42

About this Guide

This guide describes how to perform service and maintenance on an SCv2080 storage system.

Revision History

Document Number: J4580

Revision	Date	Description
A00	March 2015	Initial release

Audience

The information provided in this Owner's Manual is intended for use by Dell end users.

Contacting Dell

Dell provides several online and telephone-based support and service options. Availability varies by country and product, and some services may not be available in your area.

To contact Dell for sales, technical support, or customer service issues go to www.dell.com/support.

- For customized support, enter your system Service Tag on the support page and click **Submit**.
- For general support, browse the product list on the support page and select your product.

Related Publications

The following documentation is available for the SCv2080 storage system.

- *Dell Storage Center SCv2080 Storage System Getting Started Guide*
Provides information about an SCv2080 storage system, such as installation instructions and technical specifications.
- *Dell Storage Center SCv2080 Storage System Deployment Guide*
Provides information about an SCv2080 storage system, such as hardware features and deployment instructions.
- *Dell Storage Center Release Notes*
Contains information about new features and known and resolved issues for the Storage Center software.
- *Dell Storage Center SCv2000 Series Virtual Media Update Instructions*
Describes how to install Storage Center software on an SCv2000/SCv2020 storage system using virtual media. Installing Storage Center software using the Storage Center Virtual Media option is intended for use only by sites that cannot update Storage Center using standard methods.
- *Dell Storage Center Software Update Guide*

Describes how to upgrade Storage Center software from an earlier version to the current version.

- *Dell Storage Center Command Utility Reference Guide*
Provides instructions for using the Storage Center Command Utility. The Command Utility provides a command-line interface (CLI) to enable management of Storage Center functionality on Windows, Linux, Solaris, and AIX platforms.
- *Dell Storage Center Command Set for Windows PowerShell*
Provides instructions for getting started with Windows PowerShell cmdlets and scripting objects that interact with the Storage Center via the PowerShell interactive shell, scripts, and PowerShell hosting applications. Help for individual cmdlets is available online.
- *Dell Storage Client Administrator's Guide*
Provides information about the Dell Storage Client and how it can be used to manage a Storage Center.
- *Dell Enterprise Manager Administrator's Guide*
Contains in-depth feature configuration and usage information
- *Dell TechCenter*
Provides technical white papers, best practice guides, and frequently asked questions about Dell Storage products. Go to: <http://en.community.dell.com/techcenter/storage/>.

About the SCv2080 Storage System

The SCv2080 storage system provides the central processing capabilities for the Storage Center Operating System (OS) and management of RAID storage.

The SCv2080 storage system holds the physical disks that provide storage for the Storage Center. If additional storage is needed, the SCv2080 also supports a single SC180 expansion enclosure.

SCv2080 Storage System Hardware

The SCv2080 is a 5U storage system that supports up to 84 3.5-inch hot-swappable SAS hard drives installed in a two-drawer, three-row, 14-column configuration.

The SCv2080 ships with two redundant power supply units, five redundant cooling fans, and up to two redundant storage controllers. The storage controller contains multiple I/O ports that provide communication with front-end servers and back-end storage.

SCv2080 Storage System Monitoring and Diagnostics

The Storage Center OS generates alert messages for temperature, I/O module, fan module, disk, and power conditions for Storage Center components. Use the Dell Storage Client to view these alerts.

The SCv2080 also has LED indicators to notify you of a possible problem with the storage system.



NOTE: Dell OpenManage Server Administrator is not available for the SCv2080.

SCv2080 Storage System Front-Panel Features and Indicators

The SCv2080 front panel shows the storage system chassis and power status.

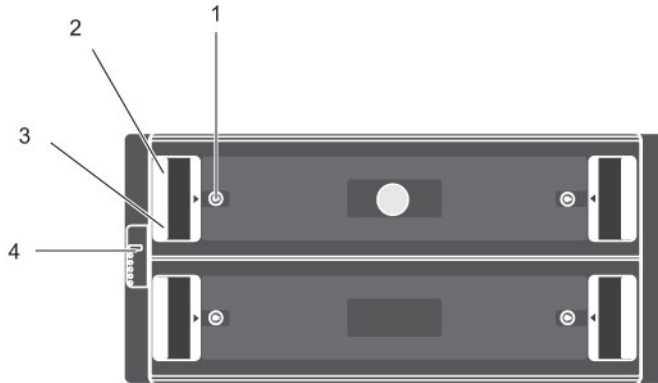











Figure 1. SCv2080 Front-Panel Features and Indicators

Item	Name	Panel	Description
1	Drawer-specific anti-tamper locks		Locks the drawer shut using a Torx T20 screwdriver until the red arrows point to the locked icon (away from the center of the chassis).
2	Drawer-specific left and right side status indicators		<ul style="list-style-type: none"> • Sideplane OK/Power Good: <ul style="list-style-type: none"> – Off – Sideplane card or cable fault – Green – Sideplane card and cable are functional (though a fault may be indicated by one or more of the following LEDs) • Drawer Fault: Amber – Sideplane card fault or drive failure causing loss of availability or redundancy • Logical Fault: <ul style="list-style-type: none"> – Amber (steady) – Host indicated drive fault – Amber (flashing) – Arrays in impacted state • Cable Fault: Amber – Cable fault

Item	Name	Panel	Description
3	Drawer-specific left and right side storage system activity indicators		Activity Bar Graph: Six variable-intensity LEDs dynamically displaying access of the drives in that specific drawer.
4	Status indicator for storage system	     	<ul style="list-style-type: none"> • Unit ID Display: A numerical display whose primary function is to display the unit identification number. • Input Switch: Not currently used (though it can be used to set the Unit ID Display, the ID will be automatically reset by the Storage Center Operating System) • Power On/Standby: <ul style="list-style-type: none"> – Off – The storage system does not have power – Green – The storage system is on (operational) – Amber – The storage system is in standby (not operational) • Module Fault: Amber when there is a hardware fault (additionally, an LED may be lit on a PSU, drawer, DDIC, fan module, or IO module indicating the part at fault) • Logical Status: Amber when there is a change of status or fault from something other than the storage system itself (this is usually associated with a disk drive as indicated by its own fault LED) • Drawer 1 Fault: Amber when a drive, cable, or sideplane fault has occurred in drawer 1 • Drawer 2 Fault: Amber when a drive, cable, or sideplane fault has occurred in drawer 2 <p> NOTE: Both drawer fault LEDs (and all contained DDIC LEDs) will flash when the storage system indicator is set to On in Storage Client.</p>

SCv2080 Storage System Back-Panel Features and Indicators

The back panel shows power, connectivity, and fault indicators.

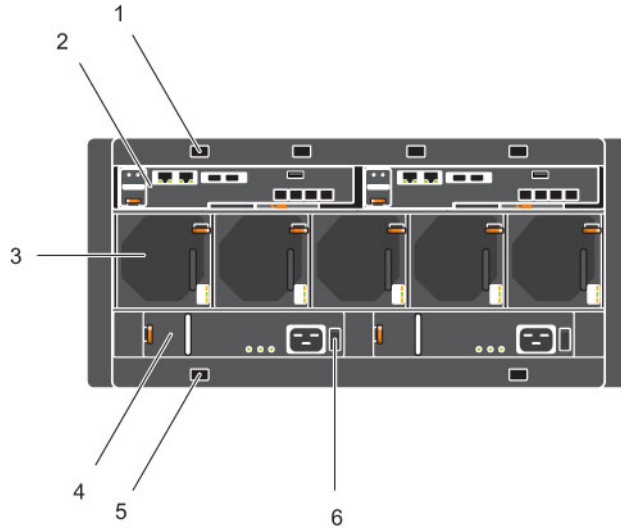

Figure 2. SCv2080 Back-Panel Features and Indicators

Item	Name	Icon	Description
1	Optional cable retention positions (4)	—	Locations for optional cable retention brackets.
2	Storage controller (2)	—	<p>Each storage controller module contains:</p> <ul style="list-style-type: none"> • Battery backup unit (BBU): Allows the storage controller to shut down gracefully when a loss of AC power is detected. • Back-end ports: Two 6 Gbps SAS ports • Front-end ports: Fibre Channel ports, iSCSI ports, or SAS ports • MGMT port: Embedded Ethernet/iSCSI port, which is used for system management <ul style="list-style-type: none"> NOTE: The MGMT port can share iSCSI traffic if the Flex Port license is installed. • REPL port: Embedded iSCSI port, which is typically used for replication to another Storage Center <ul style="list-style-type: none"> NOTE: A Flex Port license is required to connect host servers through the embedded iSCSI ports.
3	Cooling fans (5)	—	Fans that provide cooling for the storage system.
4	Power supply units (2)	—	2.8 kW power supply that provides power for the storage system.

Item	Name	Icon	Description
5	Optional cable retention positions (4)	—	Locations for optional cable retention brackets.
6	Power switch (2)	—	Controls power for the storage system. There is one switch for each power supply.

SCv2080 Storage Controller Features and Indicators

The SCv2080 includes two storage controllers in two interface slots.

The storage controllers support Fibre Channel, iSCSI, or SAS front-end ports.

SCv2080 Storage Controller with Fibre Channel Front-End Ports

Features and indicators on a storage controller with Fibre Channel front-end ports.

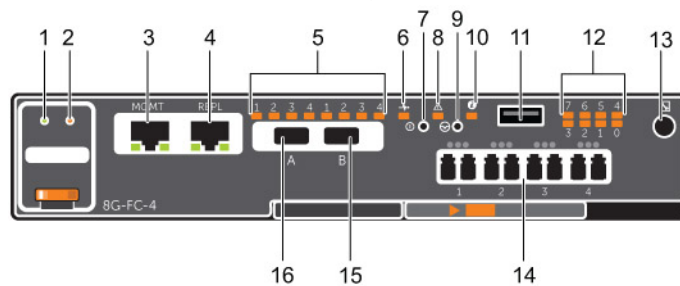

Figure 3. Storage Controller with Four 8 Gb Fibre Channel Front-End Ports

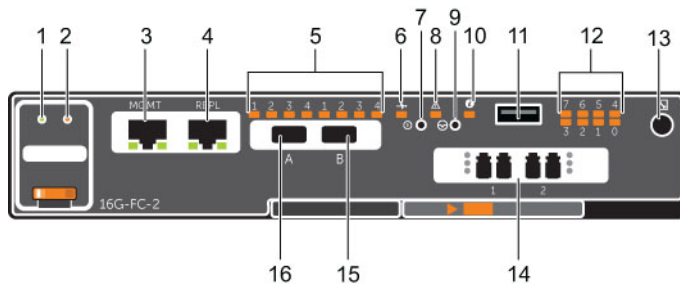













Figure 4. Storage Controller with Two 16 Gb Fibre Channel Front-End Ports

Item	Control/Feature	Icon	Description
1	Battery status indicator		<ul style="list-style-type: none"> Blinking green (on 0.5 sec. / off 1.5 sec.): Battery heartbeat Fast blinking green (on 0.5 sec. / off 0.5 sec.): Battery is charging Steady green: Battery is ready
2	Battery fault indicator		<ul style="list-style-type: none"> Off: No faults Blinking amber: Correctable fault detected Steady amber: Uncorrectable fault detected; replace battery
3	MGMT port	—	10 Mbps, 100 Mbps, or 1 Gbps Ethernet/iSCSI port used for storage system management and access to the BMC

Item	Control/Feature	Icon	Description
			 NOTE: To use the MGMT port as an iSCSI port for replication to another Storage Center, a Flex Port license and replication license are required. To use the MGMT port as a front-end connection to host servers, a Flex Port license is required.
4	REPL port	—	10 Mbps, 100 Mbps, or 1 Gbps Ethernet/iSCSI port used for replication to another Storage Center (requires a replication license)
			 NOTE: To use the RELP port as a front-end connection to host servers, a Flex Port license is required.
5	SAS activity indicators	—	<ul style="list-style-type: none"> • Off: Port is off • Steady green: Port is on, but without activity • Blinking green: Port is on and there is activity
6	Storage controller module status		On: Storage controller completed POST
7	Recessed power off button		Powers down the storage controller if held for more than five seconds
8	Storage controller module fault		<ul style="list-style-type: none"> • Off: No faults • Steady amber: Firmware has detected an error • Blinking amber: Storage controller is performing POST
9	Recessed reset button		Reboots the storage controller forcing it to restart at the POST process
10	Identification LED		<ul style="list-style-type: none"> • Off: Identification disabled • Blinking blue (for 15 sec.): Identification is enabled • Blinking blue (continuously): Storage controller shut down to the Advanced Configuration and Power Interface (ACPI) S5 state
11	USB port		
12	Diagnostic LEDs (8)	—	<ul style="list-style-type: none"> • Green LEDs 0–3: Low byte hex POST code • Green LEDs 4–7: High byte hex POST code
13	Serial port (3.5 mm mini jack)		Not for customer use.
14	Four or two Fibre Channel ports with three LEDs per port	—	<ul style="list-style-type: none"> • All off: No power • All on: Booting up • Blinking amber: 2 Gbps activity • Blinking green: 4 Gbps activity • Blinking yellow: 8 Gbps activity • Blinking amber and yellow: Beacon • All blinking (simultaneous): Firmware initialized • All blinking (alternating): Firmware fault
15	Mini-SAS port B		Back-end expansion port B

Item	Control/Feature	Icon	Description
16	Mini-SAS port A		Back-end expansion port A

SCv2080 Storage Controller with iSCSI Front-End Ports

Features and indicators on a storage controller with iSCSI front-end ports.

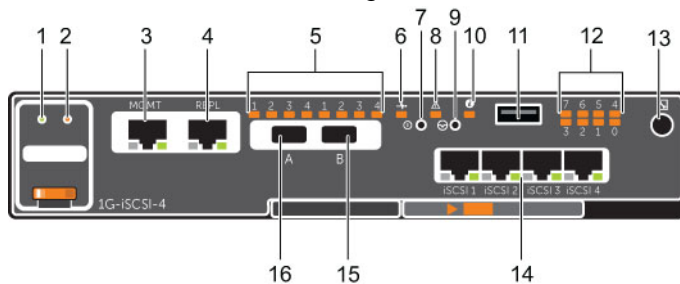

Figure 5. SCv2080 Storage Controller with Four 1 GbE iSCSI Front-End Ports

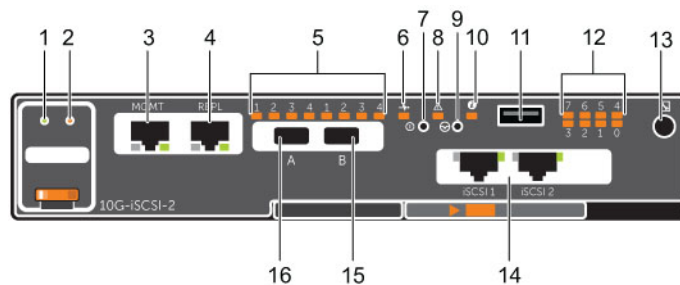















Figure 6. SCv2080 Storage Controller with Two 10 GbE iSCSI Front-End Ports

Item	Control/Feature	Icon	Description
1	Battery status indicator		<ul style="list-style-type: none"> Blinking green (on 0.5 sec. / off 1.5 sec.): Battery heartbeat Fast blinking green (on 0.5 sec. / off 0.5 sec.): Battery is charging Steady green: Battery is ready
2	Battery fault indicator		<ul style="list-style-type: none"> Off: No faults Blinking amber: Correctable fault detected Steady amber: Uncorrectable fault detected; replace battery
3	MGMT port	—	<p>10 Mbps, 100 Mbps, or 1 Gbps Ethernet port used for storage system management and access to the BMC</p> <p> NOTE: To use the MGMT port as an iSCSI port for replication to another Storage Center, a Flex Port license and replication license are required. To use the MGMT port as a front-end connection to host servers, a Flex Port license is required.</p>
4	REPL port	—	10 Mbps, 100 Mbps, or 1 Gbps Ethernet/iSCSI port used for replication to another Storage Center

Item	Control/Feature	Icon	Description
			 NOTE: To use the RELP port as a front-end connection to host servers, a Flex Port license is required.
5	SAS activity indicators	—	<ul style="list-style-type: none"> • Off: Port is off • Steady green: Port is on, but without activity • Blinking green: Port is on and there is activity
6	Storage controller module status		On: Storage controller completed POST
7	Recessed power off button		Powers down the storage controller if held for more than five seconds
8	Storage controller module fault		<ul style="list-style-type: none"> • Off: No faults • Steady amber: Firmware has detected an error • Blinking amber: Storage controller is performing POST
9	Recessed reset button		Reboots the storage controller forcing it to restart at the POST process
10	Identification LED		<ul style="list-style-type: none"> • Off: Identification disabled • Blinking blue (for 15 sec.): Identification is enabled • Blinking blue (continuously): Storage controller shut down to the Advanced Configuration and Power Interface (ACPI) S5 state
11	USB port		
12	Diagnostic LEDs (8)	—	<ul style="list-style-type: none"> • Green LEDs 0–3: Low byte hex POST code • Green LEDs 4–7: High byte hex POST code
13	Serial port (3.5 mm mini jack)		Not for customer use.
14	Four or two iSCSI ports with two LEDs per port	—	<ul style="list-style-type: none"> • Off: No power • Steady Amber: Link • Blinking Green: Activity
15	Mini-SAS port B		Back-end expansion port B
16	Mini-SAS port A		Back-end expansion port A

SCv2080 Storage Controller with SAS Front-End Ports

Features and indicators on a storage controller with SAS front-end ports.

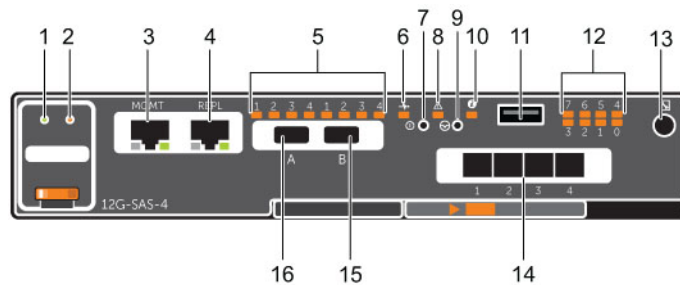









Figure 7. SCv2080 Storage Controller with Four 12 Gb SAS Front-End Ports

Item	Control/Feature	Icon	Description
1	Battery status indicator		<ul style="list-style-type: none"> Blinking green (on 0.5 sec. / off 1.5 sec.): Battery heartbeat Fast blinking green (on 0.5 sec. / off 0.5 sec.): Battery is charging Steady green: Battery is ready
2	Battery fault indicator		<ul style="list-style-type: none"> Off: No faults Blinking amber: Correctable fault detected Steady amber: Uncorrectable fault detected; replace battery
3	MGMT port	—	10 Mbps, 100 Mbps, or 1 Gbps Ethernet port used for storage system management and access to the BMC NOTE: To use the MGMT port as an iSCSI port for replication to another Storage Center, a Flex Port license and replication license are required. To use the MGMT port as a front-end connection to host servers, a Flex Port license is required.
4	REPL port	—	10 Mbps, 100 Mbps, or 1 Gbps Ethernet/iSCSI port used for replication to another Storage Center NOTE: To use the RELP port as a front-end connection to host servers, a Flex Port license is required.
5	SAS activity indicators	—	<ul style="list-style-type: none"> Off: Port is off Steady green: Port is on, but without activity Blinking green: Port is on and there is activity
6	Storage controller module status		On: Storage controller completed POST
7	Recessed power off button		Powers down the storage controller if held for more than five seconds
8	Storage controller module fault		<ul style="list-style-type: none"> Off: No faults Steady amber: Firmware has detected an error Blinking amber: Storage controller is performing POST

Item	Control/Feature	Icon	Description
9	Recessed reset button		Reboots the storage controller forcing it to restart at the POST process
10	Identification LED		<ul style="list-style-type: none"> • Off: Identification disabled • Blinking blue (for 15 sec.): Identification is enabled • Blinking blue (continuously): Storage controller shut down to the Advanced Configuration and Power Interface (ACPI) S5 state
11	USB port		
12	Diagnostic LEDs (8)	—	<ul style="list-style-type: none"> • Green LEDs 0–3: Low byte hex POST code • Green LEDs 4–7: High byte hex POST code
13	Serial port (3.5 mm mini jack)		Not for customer use.
14	Four Mini-SAS High Density (HD) ports	—	Front-end connectivity ports  NOTE: The mini-SAS HD ports are for front-end connectivity only and cannot be used for back-end expansion.
15	Mini-SAS port B		Back-end expansion port B
16	Mini-SAS port A		Back-end expansion port A

SCv2080 Storage System Fan Module Features and Indicators

SCv2080 storage systems include five fan modules in five interface slots.

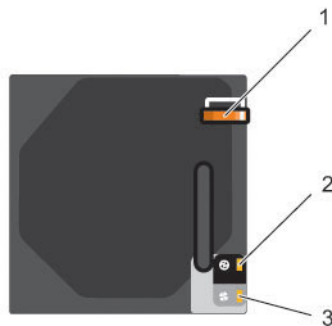



Figure 8. SCv2080 Fan Module Features and Indicators

Item	Control/Feature	Icon	Description
1	Release latch	—	Press the release latch to remove the fan module.
2	Module OK		Green — Module OK

Item	Control/Feature	Icon	Description
3	Fan fault		Amber — Loss of communication with the fan module, or reported fan speed is out of tolerance

SCv2080 Storage System PSU Features and Indicators

SCv2080 storage systems include two Power Supply Units (PSUs) in two interface slots.

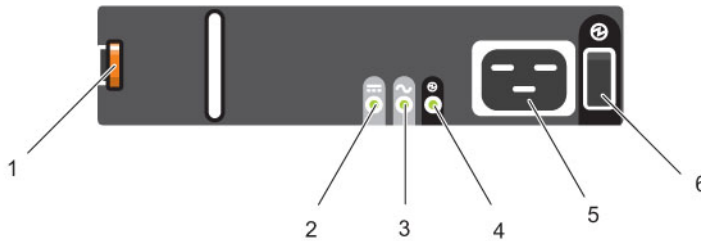





Figure 9. SCv2080 PSU Features and Indicators

Item	Control/Feature	Icon	Description
1	Release latch	—	Press the release latch to remove the PSU.
2	PSU fault		<ul style="list-style-type: none"> Amber (steady) — PSU fault, PSU not supplying power Amber (flashing) — PSU firmware is downloading
3	AC fault		<ul style="list-style-type: none"> Amber (steady) — AC power is not detected Amber (flashing) — PSU firmware is downloading
4	Power OK		<ul style="list-style-type: none"> Green (steady) — This PSU is providing power Green (flashing) — AC power is present, but this PSU is in standby mode (the other PSU is providing power)
5	Power outlet	—	Power outlet for the storage system.
6	Power switch	—	Controls power for the storage system.

Separate and unique conditions are indicated if all three LEDs are in the same state:

- If all three LEDs are off, then there is no AC power to either PSU.
- If all three LEDs are on, then the General Enclosure Management (GEM) software has lost communication with the PSU.

SCv2080 Storage System Drives

Dell Enterprise hard disk drives (HDDs) and Enterprise Solid-State Drives (eSSDs) are the only drives that can be installed in an SCv2080 storage system. If a non-Dell Enterprise drive is installed, Storage Center prevents the drive from being managed.

Each drive is installed in Disk Drive In Carrier (DDIC) and each DDIC includes one status indicator.

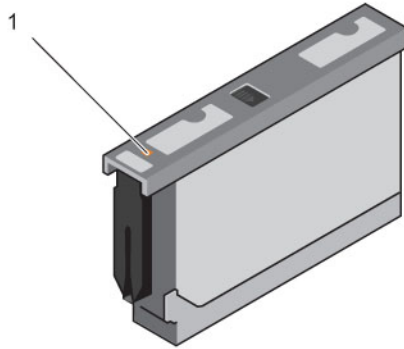

Figure 10. DDIC and Status Indicator

Item	Feature	Indicator Code
1	DDIC fault indicator	Amber — Drive fault Amber (flashing) — Flashes in one second intervals when drive or enclosure indicator is set to On in Dell Storage Client. With the drive indicator, the containing drawer fault LED will also flash; with the enclosure indicator, all drives' and both drawers' fault LEDs will flash.

Replacing SCv2080 Components

This section describes how to remove and install components of an SCv2080 storage system. This document assumes that the customer has received the replacement component and is ready to install it.

Safety Precautions

Always follow these safety precautions to avoid injury and damage to Storage Center equipment.

If equipment described in the document is used in a manner not specified by Dell, the protection provided by the equipment may be impaired. For your safety and protection, observe the rules described in the following sections.

 **NOTE:** See the safety and regulatory information that shipped with each Storage Center component. Warranty information may be included within this document or as a separate document.

Installation Safety Precautions

Follow these safety precautions:

- Dell recommends that only individuals with rack-mounting experience install an SCv2080 storage system in a rack.
- You need at least two people to lift the storage system chassis from the shipping box and three people to install it in the rack. The empty chassis weighs approximately 62kg (137 lbs).
- Make sure the storage system is fully grounded at all times to prevent damage from electrostatic discharge.
- When handling the storage system hardware, you should use an electrostatic wrist guard (not included) or a similar form of protection.

The storage system chassis **MUST** be mounted in a rack; the following safety requirements must be considered when doing so:

- The rack construction must be capable of supporting the total weight of the installed chassis and the design should incorporate stabilizing features suitable to prevent the rack tipping or being pushed over during installation or in normal use.
- When loading a rack with chassis, fill from the bottom up; empty from the top down.
- To avoid danger of the rack toppling over, do not slide more than one chassis out of the rack at a time.
- The storage system must be operated with low-pressure rear exhaust installation [back pressure created by rack doors and obstacles not to exceed 5 Pascals (0.5 mm water gauge)].
- The rack design should take into consideration the maximum operating ambient temperature for the unit, which is 35°C.

Electrical Safety Precautions

Always follow electrical safety precautions to avoid injury and damage to Storage Center equipment.

 **WARNING: Disconnect power from the storage system when removing or installing components that are not hot-swappable. When disconnecting power, first power down the storage system using the Dell Storage Client and then unplug the power cords from all the power supplies in the storage system.**

- Provide a suitable power source with electrical overload protection. All Storage Center components must be grounded before applying power. Make sure that there is a safe electrical earth connection to power supply cords. Check the grounding before applying power.
- The plugs on the power supply cords are used as the main disconnect device. Make sure that the socket outlets are located near the equipment and are easily accessible.
- Know the locations of the equipment power switches and the room's emergency power-off switch, disconnection switch, or electrical outlet.
- Do not work alone when working with high-voltage components.
- Use rubber mats specifically designed as electrical insulators.
- Do not remove covers from the power supply unit. Disconnect the power connection before removing a power supply from the storage system.
- Do not remove a faulty power supply unless you have a replacement model of the correct type ready for insertion. A faulty power supply must be replaced with a fully operational module power supply within 24 hours.
- Unplug the storage system chassis before you move it or if you think it has become damaged in any way. When powered by multiple AC sources, disconnect all supply power for complete isolation.

Electrostatic Discharge Precautions

Always follow electrostatic discharge (ESD) precautions to avoid injury and damage to Storage Center equipment.

Electrostatic discharge (ESD) is generated by two objects with different electrical charges coming into contact with each other. The resulting electrical discharge can damage electronic components and printed circuit boards. Follow these guidelines to protect your equipment from ESD:

- Dell recommends that you always use a static mat and static strap while working on components in the interior of the storage system chassis.
- Observe all conventional ESD precautions when handling plug-in modules and components.
- Use a suitable ESD wrist or ankle strap.
- Avoid contact with backplane components and module connectors.
- Keep all components and printed circuit boards (PCBs) in their antistatic bags until ready for use.

General Safety Precautions

Always follow general safety precautions to avoid injury and damage to Storage Center equipment.

- Keep the area around the storage system chassis clean and free of clutter.
- Place any system components that have been removed away from the storage system chassis or on a table so that they are not in the way of foot traffic.
- While working on the storage system chassis, do not wear loose clothing such as neckties and unbuttoned shirt sleeves, which can come into contact with electrical circuits or be pulled into a cooling fan.

- Remove any jewelry or metal objects from your body because they are excellent metal conductors that can create short circuits and harm you if they come into contact with printed circuit boards or areas where power is present.
- Do not lift a storage system chassis by the handles of the power supply units (PSUs). They are not designed to hold the weight of the entire chassis, and the chassis cover may become bent.
- Before moving a storage system chassis, remove the PSUs to minimize weight.
- Do not remove drives until you are ready to replace them.

 **NOTE:** To ensure proper storage system cooling, hard drive blanks must be installed in any hard drive slot that is not occupied.

Pre-Replacement Procedures

Perform the procedures described in this section before replacing a component of an SCv2080 storage system.

Sending Diagnostic Data Using Dell SupportAssist

Use Dell SupportAssist to send diagnostic data to Dell Technical Support Services.

1. Click **Send SupportAssist Data Now**. The **Send Support Assist Data Now** dialog box appears.
2. Select **Storage Center Configuration** and **Detailed Logs**.
3. Click **OK**.

Contacting Dell Technical Support Services

Contact Dell Technical Support Services to let them know that you are performing a repair.

Request that Dell Technical Support Services suspend alerts for the storage system and ask for a pre-installation system check.

Shutting Down a Storage Controller

If you are replacing a storage controller, use the Dell Storage Client to shut down the storage controller.

About this task

If the storage system has two storage controllers, shutting down one storage controller causes the Storage Center to fail over to the other storage controller, which continues to process I/O. If the storage system has only one storage controller, shutting it down results in a system outage.

Steps

1. Click the **Hardware** tab.
2. In the **Hardware** tab navigation pane, select the storage controller to shut down.
3. In the right pane, click **Shutdown/Restart Controller**. The **Shutdown/Restart Controller** dialog box appears.
4. Select **Shutdown** from the drop-down menu.
5. Click **OK**. The selected storage controller is shut down.

Shutting Down the Storage System

If you are replacing the storage system chassis or rack rails, use the Dell Storage Client to shut down the storage system.

About this task

 **CAUTION: Shutting down the storage system results in a system outage.**

Steps

1. Select **Actions** → **System** → **Shutdown/Restart**. The **Shutdown/Restart** dialog box appears.
2. Select **Shutdown** from the first drop-down menu.
3. Click **OK**.

After the storage system shuts down, unplug the power cables from the PSUs.

Replacing PSUs

The SCv2080 storage system supports two hot-swappable power supply units (PSUs). If one unit fails, the second unit continues to provide power to the storage system.

Identifying the Failed PSU

To determine which power supply unit (PSU) failed, use the Dell Storage Client.

1. Click the **Hardware** tab.
2. In the **Hardware** tab navigation pane, select the Storage Center.
3. In the **Hardware Alerts** area, find the hardware alert that identifies the enclosure with the failed power supply.

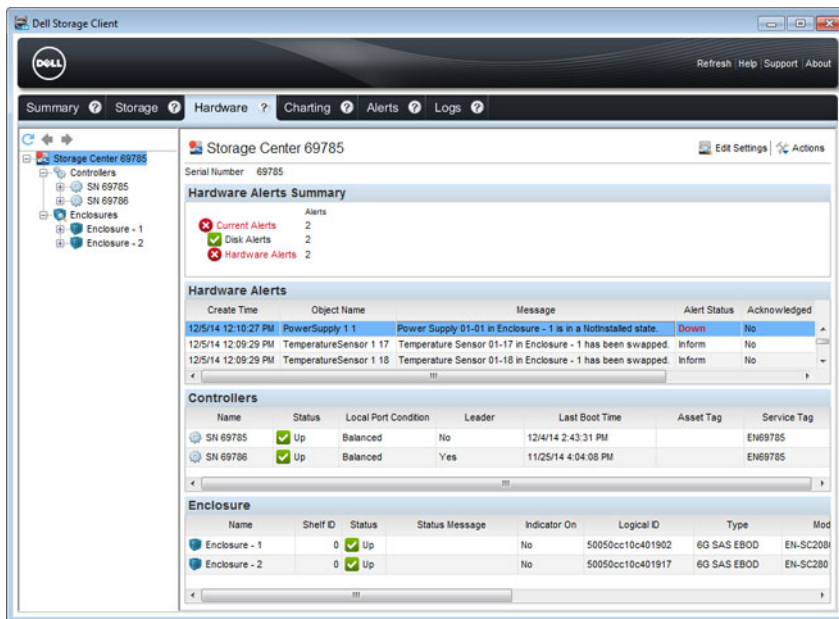

Figure 11. Hardware Alert Identifying the Enclosure with the Failed Power Supply

4. In the **Hardware** tab navigation pane, expand the enclosure identified in the previous step.

5. Select **Power Supplies**. The status of each power supply is displayed in the **Power Supplies** tab.
6. Select the failed power supply. The location of the failed power supply is displayed in the **Power Supply View** tab.

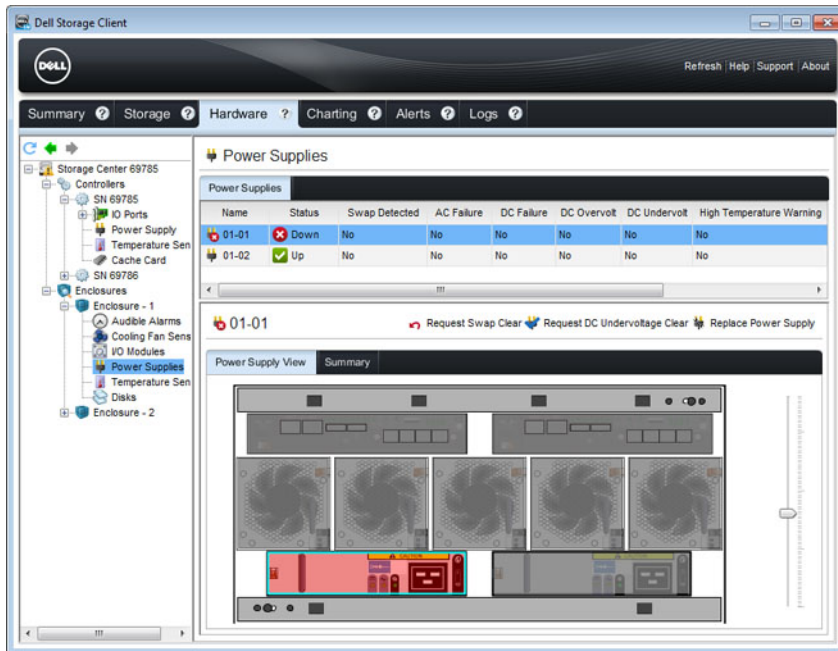

Figure 12. Rear View of the Enclosure Showing the Failed the Power Supply

Replacing a PSU

Use this procedure to replace a failed power supply unit (PSU).

Prerequisites

1. Use SupportAssist to send diagnostic data to Dell Technical Support Services.
2. Contact Dell Technical Support Services to let them know that you are performing a repair.

About this task

You can replace power supply units one at a time without shutting down the storage system.

Steps

1. Press the power switch to turn off the PSU.
2. Remove the power cable from the securing clip and disconnect the power cable from the PSU.
3. Push the release tab on the PSU to the right and slide it out of the chassis using the handle.

⚠ CAUTION: The PSUs are heavy. To avoid injury, use both hands while removing the module.

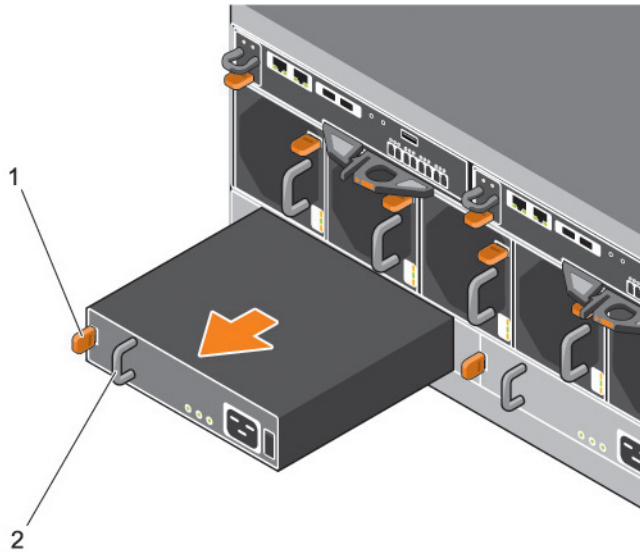

Figure 13. Removing a PSU

- | | |
|----------------|-----------|
| 1. Release tab | 2. Handle |
|----------------|-----------|
4. Slide the replacement power supply unit into the chassis until it is fully seated and the release tab clicks into place.
 5. Connect the power cable to the power supply unit and make sure the cable is plugged into a power outlet.
 6. Secure the power cable using the clip.

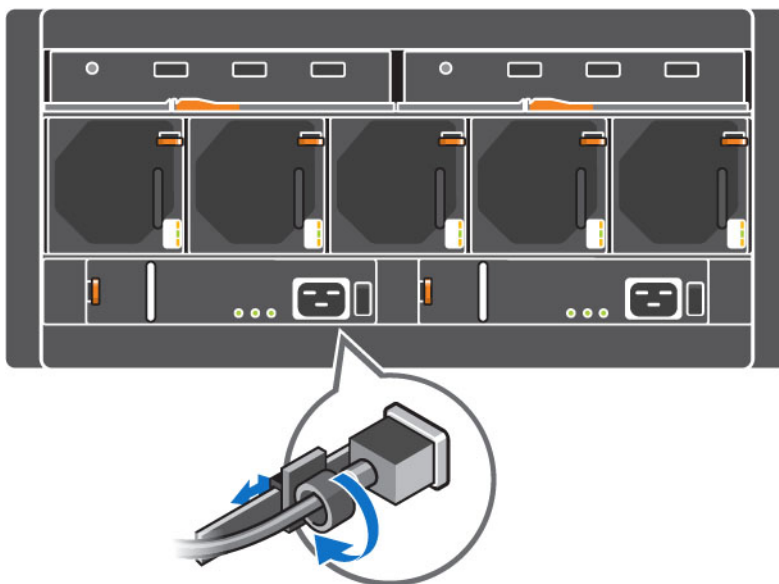

Figure 14. Securing the Power Cable

7. Press the power switch to turn on the PSU.

NOTE: Allow several seconds for the storage system to recognize the PSU and determine its status. When the PSU is functioning properly, the Power OK indicator turns green and the PSU fault and AC fault indicators are off.

8. In the Dell Storage Client, make sure that the replacement PSU is recognized and shown as up and running.

Next steps

1. Use SupportAssist to send diagnostic data to Dell Technical Support Services.
2. Contact Dell Technical Support Services to let them know that you completed a repair.

Replacing Cooling Fan Modules

The SCv2080 storage system supports five cooling fan modules. If one cooling fan module fails, the remaining fan modules continue to cool the storage system.

NOTE: When a cooling fan module fails, the fan speed in the remaining modules increases significantly to provide adequate cooling. The fan speed decreases gradually when a new cooling fan module is installed.

Identifying the Failed Cooling Fan Module

To determine which cooling fan module failed, use the Dell Storage Client.

1. Click the **Hardware** tab.
2. In the **Hardware** tab navigation pane, select the Storage Center.
3. In the **Hardware Alerts** area, find the hardware alert that identifies the enclosure with the failed cooling fan.

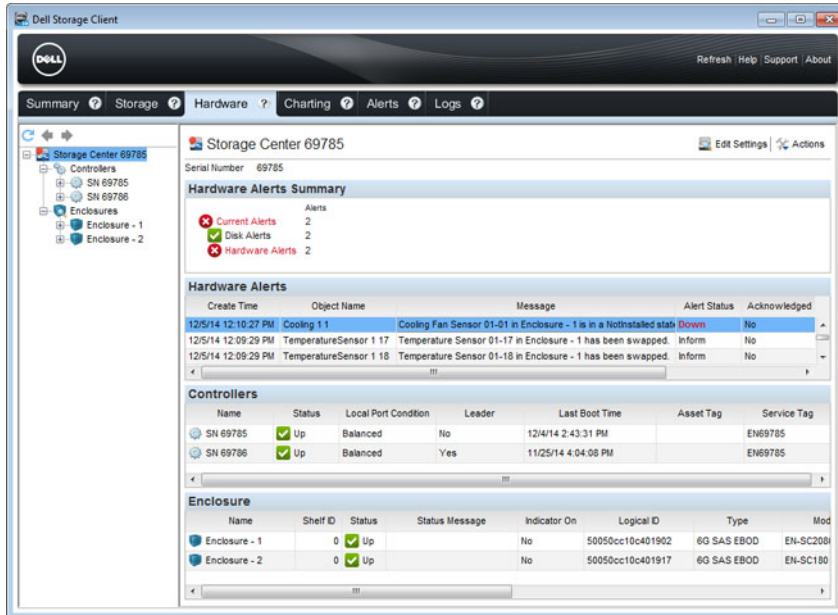

Figure 15. Hardware Alert Identifying the Enclosure with the Failed Cooling Fan

4. In the **Hardware** tab navigation pane, expand the enclosure identified in the previous step.
5. Select **Cooling Fans**. The status of each cooling fan is displayed in the **Cooling Fans** tab.

6. Select the failed cooling fan. The location of the failed cooling fan module is displayed in the **Fan View** tab.

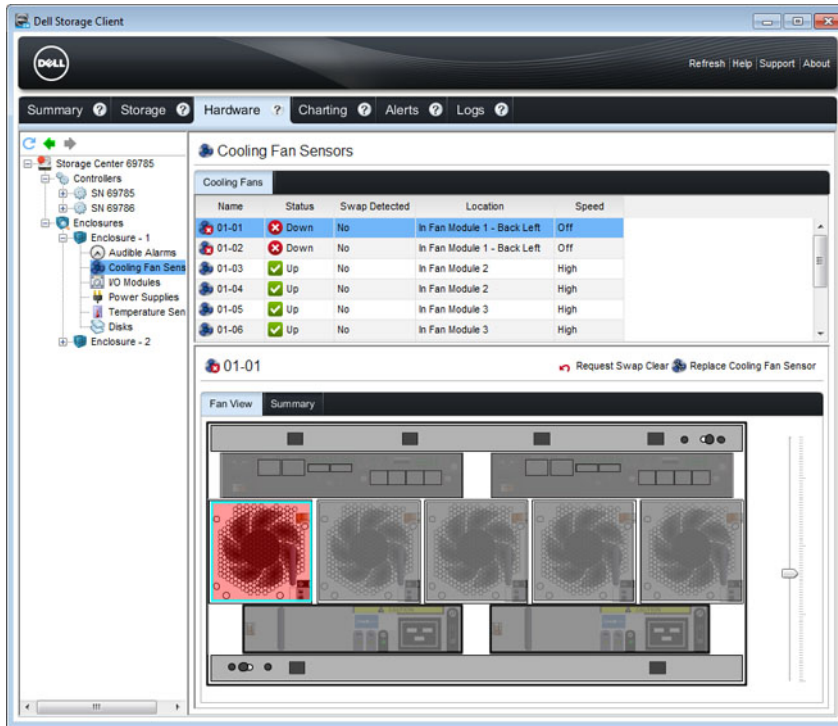

Figure 16. Rear View of the Enclosure Showing the Failed the Cooling Fan Module

Replacing a Cooling Fan Module

Use this procedure to replace a failed cooling fan module.

Prerequisites

1. Use SupportAssist to send diagnostic data to Dell Technical Support Services.
2. Contact Dell Technical Support Services to let them know that you are performing a repair.

About this task

You can replace cooling fan modules one at a time without shutting down the storage system.

Steps

1. Press the release tab and pull the fan module out of the chassis using the handle.

CAUTION: The fan modules are heavy. To avoid injury, use both hands while removing the module.

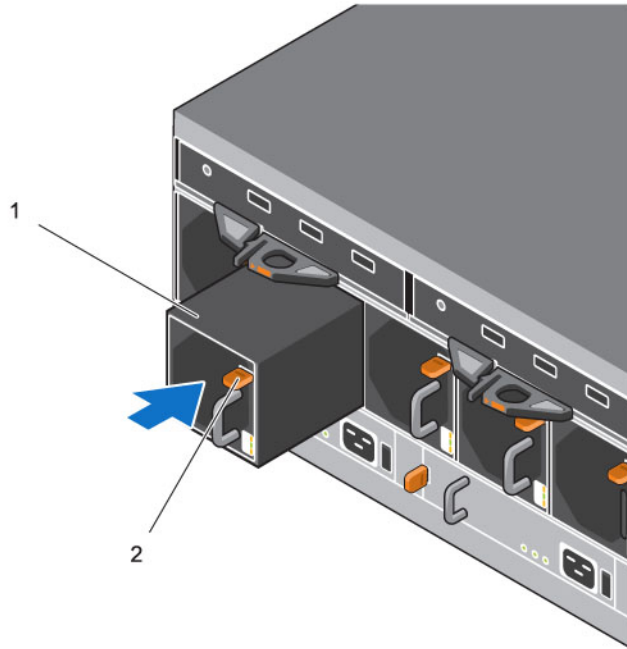

Figure 17. Removing a Fan Module

1. Fan module
 2. Release tab
2. Rotate the replacement fan module so that the release tab and handle are on the right side.
 3. Slide the replacement fan module into the chassis until it is fully seated and the release tab clicks into place.
- NOTE:** Allow several seconds for the enclosure to recognize the fan module and determine its status. When functioning properly, the fan module's Module OK LED turns green and the Battery fault and Fan fault LEDs are off. In addition, the cooling fan status indicator turns green in the Dell Storage Client.
4. In the Dell Storage Client, make sure that the replacement fan module is recognized and shown as up and running.

Next steps

1. Use SupportAssist to send diagnostic data to Dell Technical Support Services.
2. Contact Dell Technical Support Services to let them know that you completed a repair.

Replacing Hard Drives

The SCv2080 storage system supports up to 84 3.5-inch hot-swappable hard drives installed in a two-drawer, three-row, 14-column configuration. Hard drives are connected to a backplane using Disk Drive in Carrier (DDIC) hard drive carriers.

SCv2080 Storage System Drive Numbering

In an SCv2080 storage system the drives are installed in a two-drawer, three-row, 14-column configuration.

The drive slots are numbered 1–42 in the top drawer and 43–84 in the bottom drawer. Dell Storage Client identifies drives as *XX-YY*, where *XX* is the number of the unit ID of the storage system, and *YY* is the drive position inside the storage system.

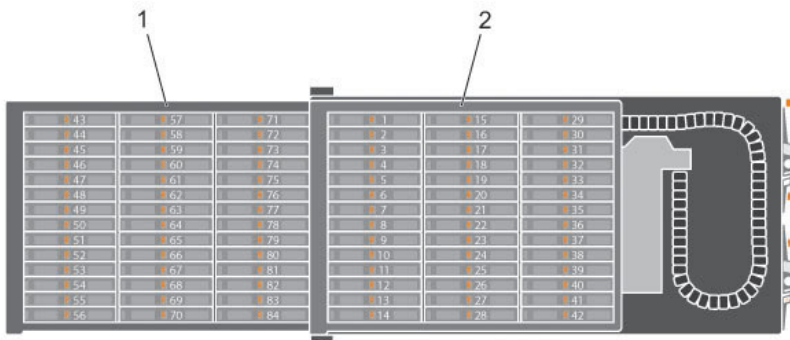

Figure 18. Hard Drive Drawers and Numbering

1. Bottom drawer
2. Top drawer

Identifying the Failed Hard Drive

To determine which hard drive failed, use the Dell Storage Client.

1. Click the **Hardware** tab.
2. In the **Hardware** tab navigation pane, select the Storage Center.
3. In the **Hardware Alerts** area, find the hardware alert that identifies the enclosure with the failed hard drive.
4. In the **Hardware** tab navigation pane, expand the enclosure identified in the previous step and select **Disks**. The status of each disk drawer is displayed in the **Disks** tab.
5. Expand the drawer with the failed hard drive and select the failed hard drive. The location of the failed hard drive is displayed in the **Disk View** tab.

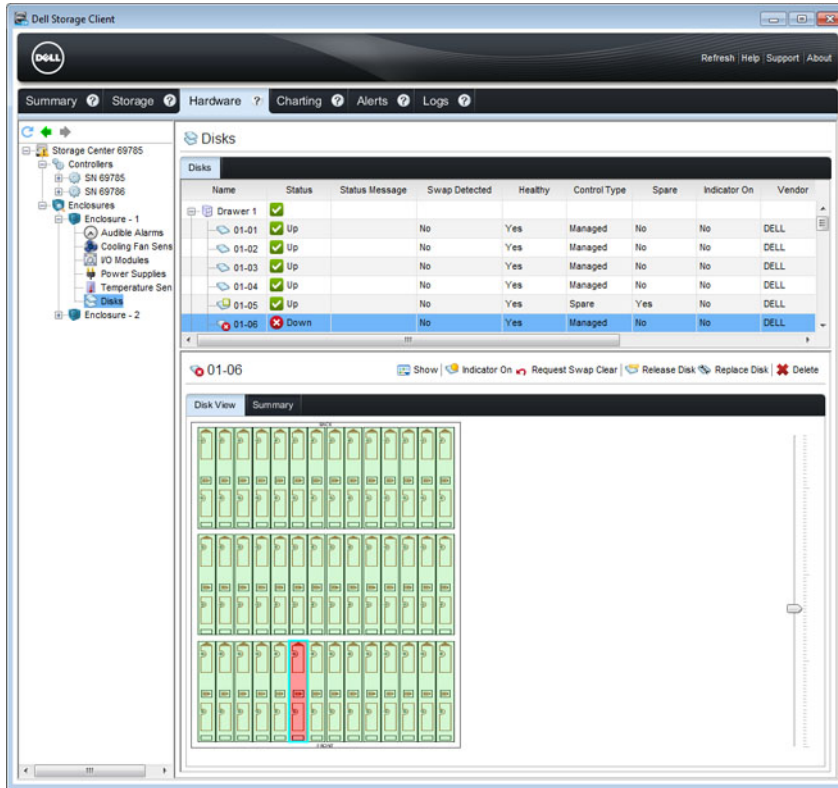

Figure 19. Inside Drawer View Showing the Failed Hard Drive

Replacing a Hard Drive

Use this procedure to replace a failed hard drive.

Prerequisites

1. Use SupportAssist to send diagnostic data to Dell Technical Support Services.
2. Contact Dell Technical Support Services to let them know that you are performing a repair.

About this task

Hard drives can be replaced one at a time without shutting down the storage system.

Steps

1. Find the SCv2080 and drawer containing the failed drive. The drawer fault LED will be lit.

CAUTION: Before opening a drawer, ensure that the Dell Storage Client does not display a temperature warning. This issue needs to be rectified first to avoid potential drive failure and data loss.

2. Push and hold both drawer latches toward the center of the drawer and pull the drawer all the way out until it stops.

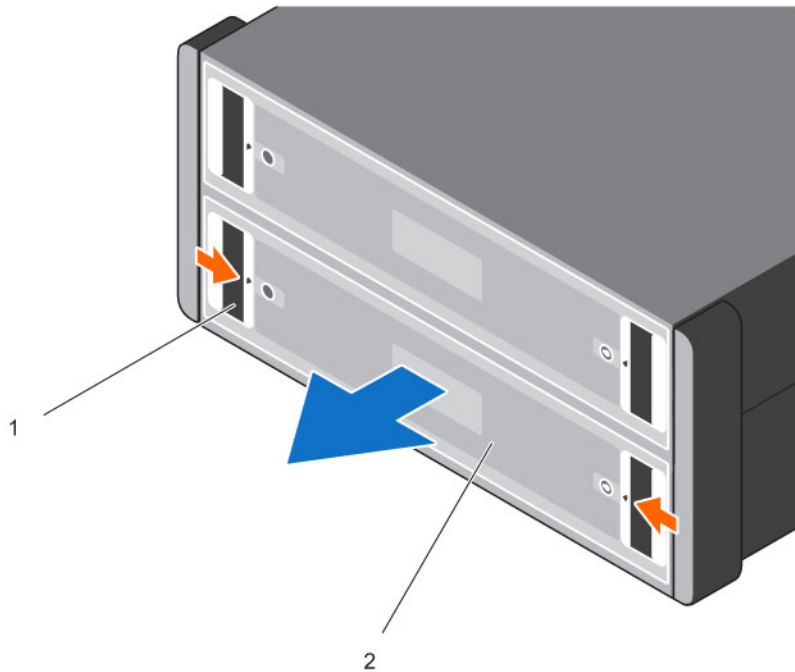

Figure 20. Opening a DDIC Drawer

1. Drawer latches (2 per drawer)
2. Drawer (2 per chassis)

⚠ CAUTION: If the SCv2080 operates for too long (depending on altitude) with drive drawers open, the enclosure can overheat, causing potential drive failure and data loss. Such use may invalidate the warranty.

3. Find the failed DDIC by the lit LED.
4. Press the release button to unlatch the DDIC.
5. Wait about ten (10) seconds for the drive to spin down.
6. Slide the DDIC up and out until it is free of the DDIC slot.

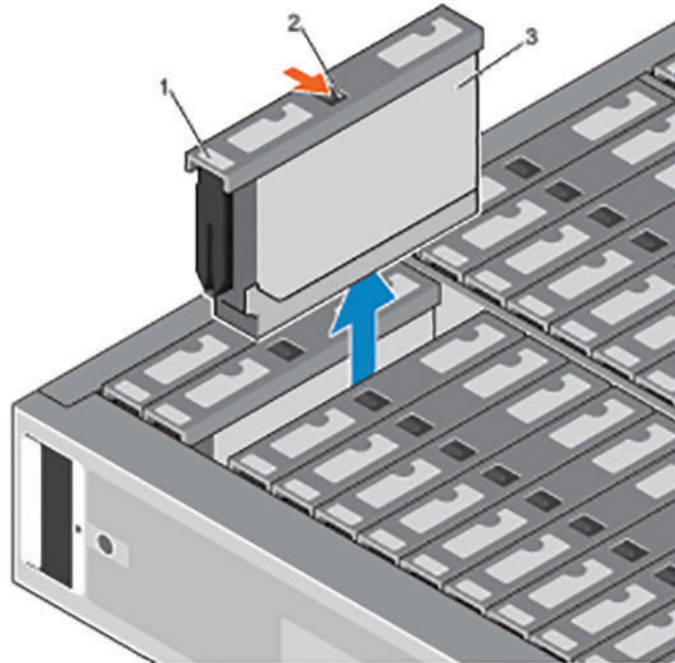

Figure 21. Removing a DDIC

1. Drive fault LED
2. Release button
3. DDIC

NOTE: Leave the drive in the carrier. The replacement drive will come in a carrier and attempting to remove the carrier can cause the carrier to break.

7. Lower the replacement DDIC into the slot then push and hold the DDIC down while sliding it toward the back of the enclosure until the DDIC latches to the backplane.

CAUTION: If the DDIC fails to latch, do not use it and request a replacement. If a faulty DDIC unlatches within a closed drawer, it can make the drawer unable to be opened.

CAUTION: To maintain proper airflow, the drawers must be populated with drives in whole rows at a time (there are three rows of 14 drives per drawer). The minimum number of drives in an enclosure is 28 (one full, front row in the top drawer and one full, front row in the bottom drawer), the number of populated rows between drawers must not differ by more than one. Populate the rows from the front to the rear of the enclosure.

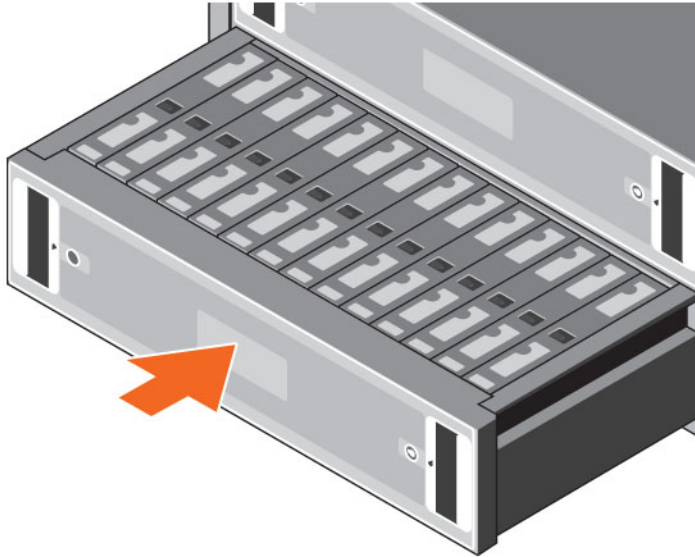



Figure 22. Closing a Drawer

8. Close the drawer.
 - a. Push and hold both drawer releases then push the drawer in slightly.
 - b. Let go of the releases and push the drawer the rest of the way in until it clicks shut.
9. In the Dell Storage Client, make sure that the replacement hard drive is recognized and shown as up and running. If the Dell Storage Client informs you that there are unassigned disks, see the *Dell Storage Client Administrator's Guide* for instructions on managing unassigned disks.
 -  **NOTE:** Allow several seconds for the enclosure to recognize the hard drive and determine its status. When functioning properly, the hard drive indicator turns green in the Dell Storage Client and the LED on the DDIC is off.

Next steps

1. Use SupportAssist to send diagnostic data to Dell Technical Support Services.
2. Contact Dell Technical Support Services to let them know that you have completed a repair.

Replacing the Storage Controller Battery

Each storage controller contains a hot-swappable battery. The battery supplies enough emergency power to back up vital information in the event of AC power loss.

Prerequisites

1. Use SupportAssist to send diagnostic data to Dell Technical Support Services.

About this task

Storage controller batteries can be replaced without shutting down the storage system.

Steps

1. Press the release tab and then slide the battery out of the storage controller.

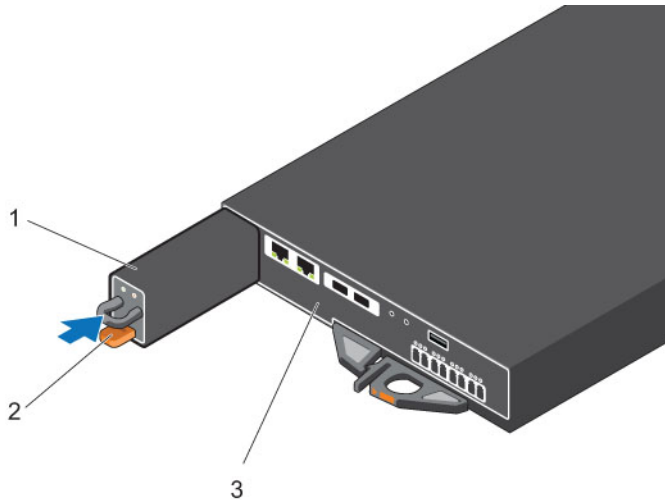

Figure 23. Replace the Storage Controller Battery

1. Battery
 2. Release tab
 3. Storage controller
2. Align the replacement battery with the slot on the storage controller.
 3. Slide the battery into the storage controller until the release tab clicks into place.

Next steps

1. Use SupportAssist to send diagnostic data to Dell Technical Support Services.

Replacing a Storage Controller

The SCv2080 storage system supports redundant hot-swappable storage controllers.

Storage controllers provide the following data path and storage management functions for the storage system:

- Monitoring and controlling some storage system environment elements such as temperature, fan, power supplies, and storage system LEDs
- Controlling access to hard drives
- Communicating storage attributes and states to the storage system

NOTE: Do not return the storage controller battery with the failed storage controller. A new battery is not included with a replacement storage controller.

Identify the Failed Storage Controller

To determine which storage controller failed, use the Dell Storage Client .

1. Click the **Hardware** tab.
2. In the **Hardware** tab navigation pane, select the Storage Center.
3. In the **Hardware Alerts** area, find the hardware alert that identifies the enclosure with the failed storage controller.

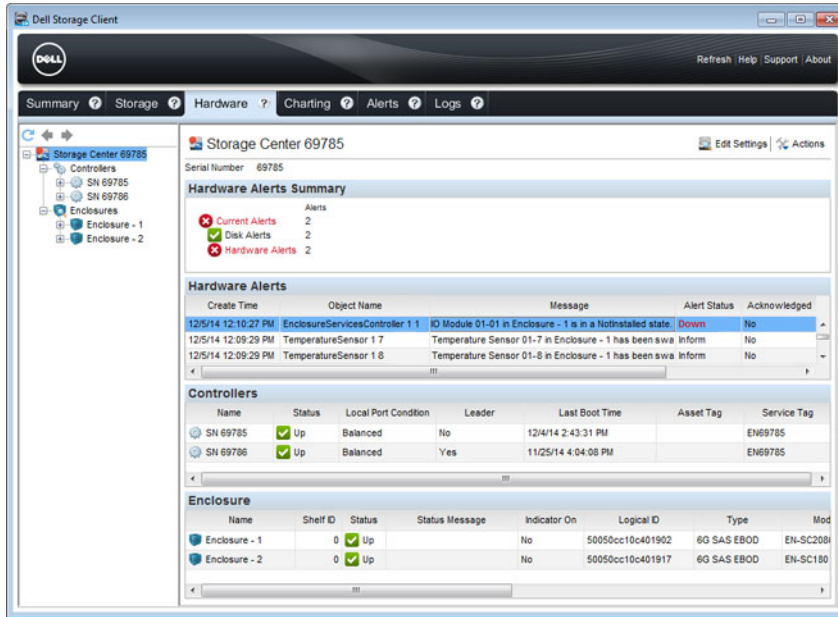

Figure 24. Hardware Alert Identifying the Enclosure with the Failed Storage Controller

4. In the Hardware tab navigation pane, expand the **Enclosures** entry.
5. Click **I/O Modules**. The status of each storage controller is displayed in the **I/O Modules** tab.
6. Select the failed storage controller to display its location in the **IO Module View** tab.

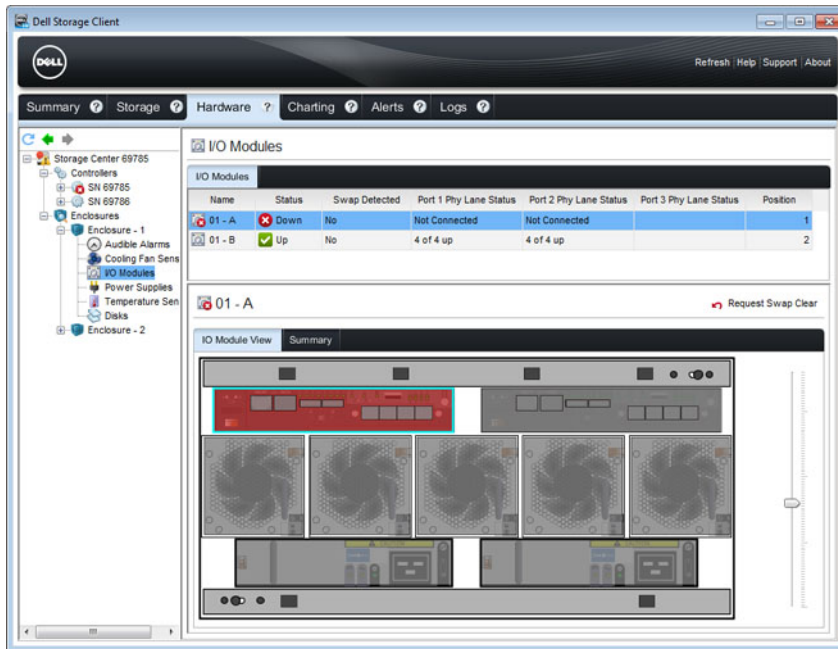

Figure 25. Rear View of the Enclosure Showing the Failed Storage Controller

Replace a Single Storage Controller

Use this procedure to replace a single failed storage controller.

Prerequisites

1. Use SupportAssist to send diagnostic data to Dell Technical Support Services.
2. Shut down the storage controller using the Dell Storage Client.

About this task

Storage controllers can be replaced one at a time without shutting down the storage system.

Steps

1. Make sure all of the cables are labeled.
2. Disconnect all of the cables from the storage controller that was shut down.
3. Remove the battery from the storage controller.
4. Squeeze the release tab on the storage controller release lever.
5. Pull the release lever away from the chassis.
6. Grasp the release lever and pull the storage controller away from the chassis.

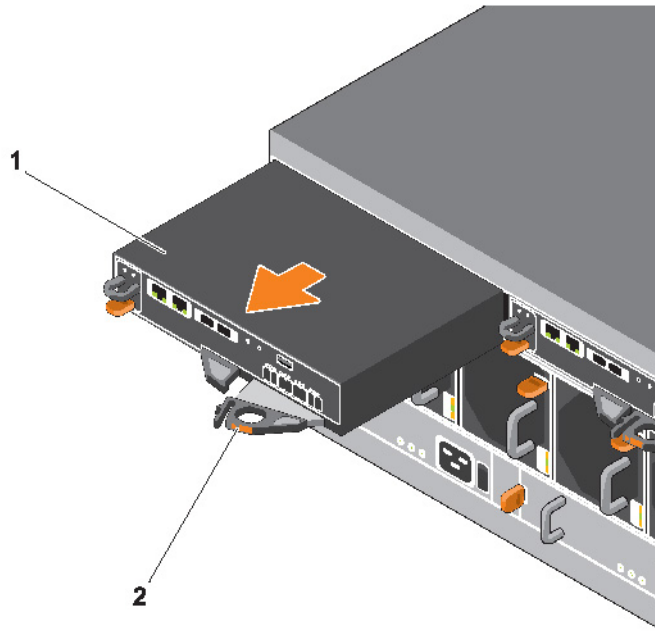



Figure 26. Replacing a Storage Controller

1. Storage controller
2. Release lever
7. Locate the battery removed in a previous step and insert it into the replacement storage controller.
 - a. Align the battery with the slot on the storage controller.
 - b. Slide the battery into the storage controller until the release tab clicks into place.
8. Insert the replacement storage controller into the chassis until it is fully seated.
9. Reconnect the cables to the storage controller.

10. Push the release lever toward the chassis until it clicks into place. The storage controller is powered on.

 **NOTE:** When a storage controller is powered on, there is a one-minute delay while the storage controller prepares to boot. During this time, the only indication that the storage controller is powered on are the LEDs on the storage controller. After the one-minute delay, the fans and LEDs turn on as an indication that the storage controller is starting up.

11. In the Dell Storage Client, make sure that the replacement storage controller is recognized and shown as up and running.

 **NOTE:** If the Storage Center software on the replacement storage controller is older than the software on the existing storage controller, the storage system updates the replacement storage controller with the software version on the existing storage controller. The Storage Center software update on the replacement storage controller may take from 15 to 45 minutes to complete.

12. Clear the swap status for the temperature sensor and I/O module.

- a. Click the **Hardware** tab.
- b. In the **Hardware** tab navigation pane, expand the enclosure.
- c. Select **Temperature Sensors**.
- d. In the right pane, right-click the sensor, then click **Request Swap Clear**.
- e. Select **I/O Modules**.
- f. In the right pane, right-click the module, then click **Request Swap Clear**.
- g. Click the **Alerts** tab.
- h. Right-click the alerts for the temperature sensor and I/O modules, then click **Acknowledge**.

 **NOTE:** The alerts may not appear immediately. If the alerts do not appear, wait 10 seconds and then click **Refresh**.

Next steps

1. Use SupportAssist to send diagnostic data to Dell Technical Support Services.

Replace Both Storage Controllers in Succession

Use this procedure to replace both storage controllers, one at a time.

Prerequisites

1. Use SupportAssist to send diagnostic data to Dell Technical Support Services.
2. Shut down the left storage controller.

About this task

This procedure is useful if you are swapping out degraded, but operational storage controllers.

Steps

1. Make sure all of the cables are labeled.
2. Disconnect all of the cables from the left storage controller
3. Remove the battery from the left storage controller.
4. Squeeze the release tab on the storage controller release lever.
5. Pull the release lever away from the chassis.
6. Grasp the release lever and pull the storage controller away from the chassis.

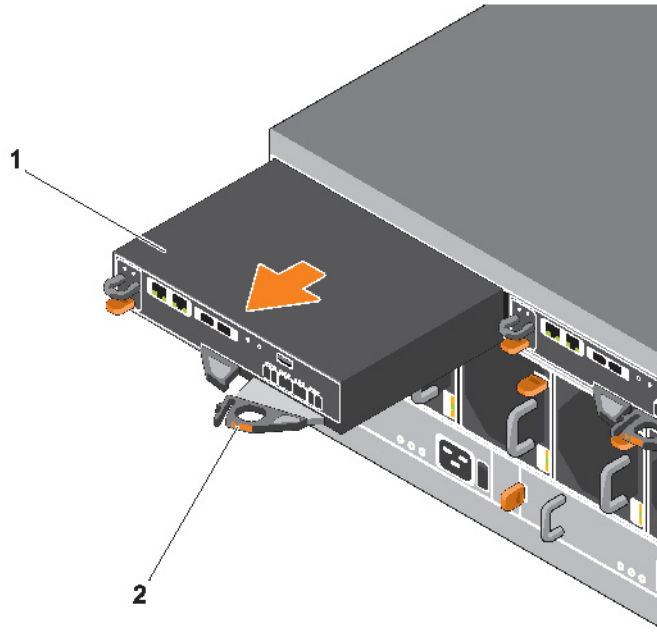



Figure 27. Replacing a Storage Controller

1. Storage controller
 2. Release level
7. Locate the battery removed in a previous step and insert it into the replacement storage controller.
 - a. Align the battery with the slot on the storage controller.
 - b. Slide the battery into the storage controller until the release tab clicks into place.
 8. Insert the replacement storage controller into the chassis until it is fully seated.
 9. Reconnect all the cables to the left storage controller.
 10. Push the release lever toward the chassis until it clicks into place. The storage controller is powered on.

NOTE: When a storage controller is powered on, there is a one-minute delay while the storage controller prepares to boot. During this time, the only indication that the storage controller is powered on are the LEDs on the storage controller. After the one-minute delay, the fans and LEDs turn on as an indication that the storage controller is starting up.
 11. In the Dell Storage Client, make sure that the replacement storage controller is recognized and shown as up and running.

NOTE: If the Storage Center software on the replacement storage controller is older than the software on the existing storage controller, the storage system updates the replacement storage controller with the software version on the existing storage controller. The Storage Center software update on the replacement storage controller may take from 15 to 45 minutes to complete.
 12. Clear the swap status for the temperature sensor and I/O module.
 - a. Click the **Hardware** tab.
 - b. In the **Hardware** tab navigation pane, expand the enclosure.
 - c. Select **Temperature Sensors**.

- d. In the right pane, right-click the sensor, then click **Request Swap Clear**.
- e. Select **I/O Modules**.
- f. In the right pane, right-click the module, then click **Request Swap Clear**.
- g. Click the **Alerts** tab.
- h. Right-click the alerts for the temperature sensor and I/O modules, then click **Acknowledge**.

 **NOTE:** The alerts may not appear immediately. If the alerts do not appear, wait 10 seconds and then click **Refresh**.

13. Clear the swap status for the temperature sensor and acknowledge the alert.
 - a. Click the **Hardware** tab.
 - b. In the **Hardware** tab navigation pane, expand the enclosure.
 - c. Select **Temperature Sensors**.
 - d. In the right pane, right-click the sensor, then click **Request Swap Clear**.
 - e. Click the **Alerts** tab.
 - f. Right-click the alert and select **Acknowledge**.

 **NOTE:** The alert may not appear immediately. If the alert does not appear, wait 10 seconds and then click **Refresh**.

14. Shut down the other storage controller and repeat the previous steps.

Next steps

1. Use SupportAssist to send diagnostic data to Dell Technical Support Services.

Replace Both Storage Controllers Simultaneously

If you need to replace both storage controllers at the same time, contact Dell Technical Support Services for assistance.

Replacing Rack Rails

Rack rails are used to install the SCv2080 storage system into a rack.

Prerequisites

1. Use SupportAssist to send diagnostic data to Dell Technical Support Services.
2. Contact Dell Technical Support Services to let them know that you are replacing the rack rails.
3. Shut down the storage system and storage system.

About this task

 **NOTE:** Replacing rack rails must be performed during a scheduled maintenance window when the Storage Center system is unavailable to the network.

Steps

1. Remove the Hold Down Brackets (HDBs).
 - a. Remove the fixing screws from the rear of the storage system.
 - b. Remove the HDBs from the rear of the rack.
2. Remove the storage system from the rack rails.

 **WARNING:** Do not attempt to lift the storage system by yourself. Always get assistance when lifting the storage system. If installed above the lower 20U of a rack, a customer-provided mechanical lift must be used to avoid injury.

3. Remove the rack rails from the rack.
4. Install the replacement rack rails in the rack.
5. Install the storage system in the rack rails.
6. Install the HDBs.
7. Start up the storage system and storage system.

Post-Replacement Procedures

After replacing a component in the SCv2080 storage system, start up the storage system if it was previously shut down and use SupportAssist to send diagnostic data to Dell Technical Support Services.

Start up the Storage System

If the storage system was previously shut down, perform this procedure to start it up.

1. Plug the power cables into the PSUs of the storage system.
2. Turn on the storage system by pressing the power switches on the PSUs.
 -  **NOTE:** When the SCv2080 storage system is powered on, there is a one-minute delay while the SCv2080 prepares to boot. During this time, the only indication that the SCv2080 is powered on are the LEDs on the storage controllers. After the one-minute delay, the SCv2080 fans and LEDs turn on as an indication that the storage system is starting to come up.
3. Use the Dell Storage Client to make sure the replacement part is recognized and shown as up and running.

Sending Diagnostic Data Using Dell SupportAssist

Use Dell SupportAssist to send diagnostic data to Dell Technical Support Services.

1. Click **Send SupportAssist Data Now**. The **Send Support Assist Data Now** dialog box appears.
2. Select **Storage Center Configuration** and **Detailed Logs**.
3. Click **OK**.

Contact Dell Technical Support Services

Contact Dell Technical Support Services to let them know that you completed a repair.

Request that Dell Technical Support Services re-enable alerts for the storage system and ask for a post-installation system check.

Troubleshooting SCv2080 Components

This section contains basic troubleshooting steps for components inside the SCv2080 storage systems.

Troubleshooting PSUs

Use these steps to troubleshoot Power Supply Units (PSUs).

1. Check the status of the PSU using the Dell Storage Client.
2. Determine the status of the PSU LEDs.
 - If the PSU fault indicator is lit, the PSU has failed.
 - If the Power OK LED is not lit, check the power cord and power source into which the power supply is plugged:
 - Connect another device to the power source and check whether the device works.
 - Connect the power cord to a different power source.
 - Replace the power cord.
 - If the AC fault LED is lit, this PSU is not supplying power, though the other PSU may still be supplying power.
3. Reseat the PSU by removing and reinstalling it.



NOTE: Allow several seconds for the storage system to recognize the PSU and determine its status.

Troubleshooting Fan Modules

Use these steps to troubleshoot fan modules.

1. Check the status of the fan module using the Dell Storage Client.
2. Determine the status of the fan module LEDs.

If the fan fault indicator is lit, the fan module has failed.
3. Reseat the fan module by removing and reinstalling it.



NOTE: Allow several seconds for the storage system to recognize the fan module and determine its status.

Troubleshooting Disk Drives

Use these steps to troubleshoot disk drives in carriers (DDICs).

1. Check the status of the disk drive using the Dell Storage Client.
2. Determine the status of the DDIC LED.
 - If the DDIC fault LED is lit, the hard drive has failed.

△ CAUTION: Confirm that the particular drive contains no user data. The Fault LED alone is not an indication the drive can be safely removed.

- If the DDIC fault LED is not lit, proceed to the next step.
3. Check the connectors and reseat the DDIC.

△ CAUTION: Perform this only on unmanaged drives or after you confirm that the particular drive contains no user data. The Fault LED alone is not an indication that you can safely remove the drive.

- a. Remove the DDIC.
- b. Check the DDIC and the backplane to ensure that the connectors are not damaged.
- c. Reinstall the DDIC. Make sure the DDIC contacts the backplane.

Troubleshooting Storage Controllers

Use these steps to troubleshoot storage controllers.

1. Check the status of the storage controller using the Dell Storage Client.
2. Check the pins and reseat the storage controller.
 - a. Remove the storage controller.
 - b. Verify that the pins on the storage system backplane and the storage controller are not bent.
 - c. Reinstall the storage controller.
3. Determine the status of the storage controller link status indicators. If the indicators are not green, check the cables.
 - a. Shut down the storage controller.
 - b. Reseat the cables on the storage controller.
 - c. Restart the storage controller.
 - d. Recheck the link status indicators. If the link status indicators are not green, replace the cables.

SCv2080 Technical Specifications



This section contains technical specifications of the SCv2080 storage system.

Technical Specifications

The technical specifications of the SCv2080 storage system are displayed in the following tables.

Drives	
SAS hard drives	Up to 84 3.5-inch SAS hot-swappable hard drives (6.0 Gbps)
Storage Controllers	
Storage controllers	Two hot-swappable storage controllers with the following IO options: <ul style="list-style-type: none"> • Two 16 Gbps Fibre Channel ports • Four 8 Gbps Fibre Channel ports • Two 10 Gbps iSCSI ports • Four 1 Gbps iSCSI ports • Four 12 Gbps SAS ports
Storage Connectivity	
Configurations	Storage Center supports up to 168 drives on a single redundant-path SAS chain An SCv2080 storage system supports one SC180 expansion enclosure
Redundant Array of Independent Disks (RAID)	
Controller	Two hot-swappable storage controllers
Management	RAID management using Dell Storage Client 2015 R1
Back-Panel Ports Connectors (per Storage Controller)	
Fibre Channel, iSCSI, or SAS connectors	Connection to a Fiber Channel fabric, iSCSI network, or a direct connection to servers with SAS HBAs
Ethernet connectors	MGMT: 10 Mbps, 100 Mbps, or 1 Gbps embedded Ethernet port used for Storage Center management REPL: 10 Mbps, 100 Mbps, or 1 Gbps embedded iSCSI port used for replication to another Storage Center
SAS connectors	6 Gbps SAS connectors for SAS port redundancy and an additional expansion enclosure

Back-Panel Ports Connectors (per Storage Controller)

	 NOTE: SAS connectors are SFF-8086/SFF-8088 compliant.
USB Connector	One USB 3.0 connector used for Storage Center updates
Serial connector	 NOTE: Not for customer use.

LED Indicators

Front panel	<ul style="list-style-type: none">• One two-digit LCD indicator for Unit ID, error code, and unit location identifier• One two-color LED indicator for power status• One single-color LED indicator for module fault status (enclosure as a whole)• One single-color LED indicator for logical fault status (drive, HBA, RAID controller, and so on)• One single-color LED indicator for drawer 1 fault status• One single-color LED indicator for drawer 2 fault status
Drawer	<ul style="list-style-type: none">• One single-color LED indicator for sideplane card and power status• One single-color LED indicator for drawer fault status• One single-color LED indicator for logical fault status• One single-color LED indicator for cable fault status• Six single-color LED indicators for data transfer status
Disk Drive In Carrier (DDIC)	One single-color LED for drive fault status
6 Gb SAS IO module	14 one-color LED status indicators, four each for the three SAS ports and two for the module status
Cooling module	<ul style="list-style-type: none">• One single-color LED indicator for module status• One single-color LED indicator for battery fault status (not currently used)• One single-color LED indicator for fan fault status
Power Supply Unit (PSU)	<ul style="list-style-type: none">• One single-color LED indicator for PSU fault status• One single-color LED indicator for AC power fault status• One single-color LED indicator for power status

Power Supplies

AC power supply (per power supply)	
Wattage	2.8 kW
Voltage	200–240 VAC (16 A)
Heat dissipation	191-147 W
Input frequency	50/60 Hz
Max input power	1791 VA
Input current	7.4 A@241 VAC

Power Supplies

Maximum inrush current Under typical line conditions and over the entire system ambient operating range, the inrush current may reach 55 A per power supply for 10 ms or less

Available Hard Drive Power (per Slot)

Supported hard drive power consumption (continuous) Up to 1.16 A at +5 V
Up to 1.6 A at +12 V

I/O Card Power (per Slot)

Maximum power consumed by I/O Card 11 W at +12 V
Maximum available power 100 W at +12 V
Minimum available power 1 W at +5 V (standby)

Physical

Height 22.23 cm (8.75 inches)
Width 48.26 cm (19 inches)
Depth 96 cm (38 inches)
Weight (maximum configuration) 130 kg (287 lb)
Weight without drives 62 kg (137 lb)

Environmental

For additional information about environmental measurements for specific storage system configurations, see dell.com/environmental_datasheets.

Temperature

Operating 5° to 35°C (41° to 95°F) with a maximum temperature gradation of 10°C per hour



NOTE: Maximum 35°C up to 2134 m (7000 ft), derate to 30°C for 2134 m to 3000 m (7000 ft to 10,000 ft)

Storage -40° to 70°C (-40° to 158°F) with a maximum temperature gradation of 20°C per hour

Relative humidity

Operating 20% to 80% (noncondensing) with a maximum humidity gradation of 10% per hour

Storage 5% to 100% (noncondensing)

Environmental

Maximum vibration

Operating 0.21 G at 5–500 Hz for 15 min

Storage 1.04 G at 2–200 Hz for 15 min

Maximum shock

Operating Half-sine shock 5 G +/- 5% with a pulse duration of 10 ms +/- 10% in operational orientations only

Storage

- Z-axis: 30 g 10 ms half sine
- X- and Y-axes: 20 g 10 ms half sine

Altitude

Operating –30.5 to 3000 m (–100 to 10,000 ft)

 **NOTE:** Maximum 35°C up to 2134 m (7000 ft), derate to 30°C for 2134 m to 3000 m (7000 ft to 10,000 ft).

Storage –300 to 12,192 m (–1000 to 40,000 ft)

Airborne Contaminant Level

Class G2 or lower as defined by ISA-S71.04-1985

Free Manuals Download Website

<http://myh66.com>

<http://usermanuals.us>

<http://www.somanuals.com>

<http://www.4manuals.cc>

<http://www.manual-lib.com>

<http://www.404manual.com>

<http://www.luxmanual.com>

<http://aubethermostatmanual.com>

Golf course search by state

<http://golfingnear.com>

Email search by domain

<http://emailbydomain.com>

Auto manuals search

<http://auto.somanuals.com>

TV manuals search

<http://tv.somanuals.com>