

Dell™ SmartPC™ 100N

Owner's Manual



Hints, Notices, and Cautions



HINT: A HINT indicates important information that helps you make better use of your computer.



NOTICE: A NOTICE indicates either potential damage to hardware or loss of data and tells you how to avoid the problem.



CAUTION: A CAUTION indicates a potential for property damage, personal injury, or death.

Abbreviations and Acronyms

For a complete list of abbreviations and acronyms, see the *Tell Me How* help file. To access the help file, see page 26.

**Information in this document is subject to change without notice.
© 2002 Dell Computer Corporation. All rights reserved.**

Reproduction in any manner whatsoever without the written permission of Dell Computer Corporation is strictly forbidden.

Trademarks used in this text: *Dell*, the *DELL* logo, *DellNet*, *TrueMobile*, *DellPlus*, *Inspiron*, *Dell Precision*, *Dimension*, *OptiPlex*, *Latitude*, and *SmartPC* are trademarks of Dell Computer Corporation; *Intel* is a registered trademark and *Celeron* is a trademark of Intel Corporation; *Microsoft* and *Windows* are registered trademarks of Microsoft Corporation; *EMC* is the registered trademark of EMC Corporation.

Other trademarks and trade names may be used in this document to refer to either the entities claiming the marks and names or their products. Dell Computer Corporation disclaims any proprietary interest in trademarks and trade names other than its own.

March 2002 P/N 8P550 Rev. A00

Contents

Safety and Use Instructions	7
Caution: Safety Instructions	7
When Using Your Computer	11
Ergonomic Computing Habits	13
When Removing or Installing Memory Modules	13
Protecting Against Electrostatic Discharge	13
Battery Disposal	14

1 Setting Up

Connecting a Printer	16
Parallel Printer	16
USB Printer	17
Installing the Printer Driver	18
Transferring Information to a New Computer (Windows® XP Only)	19
Setting Up a Home and Office Network (Windows XP Only)	19
Turning Off the Computer	20
Power Protection Devices	20
Surge Protectors	20
Line Conditioners	21
Uninterruptible Power Supply Devices	21

2 Solving Problems

Finding Solutions	24
------------------------------------	-----------

Accessing Help	26
Power Problems	26
Error Messages	28
Video and Display Problems	29
If the display is blank	29
If the display is difficult to read	30
If only part of the display is readable	30
Sound and Speaker Problems	31
If you have a problem with integrated speakers	31
Printer Problems	31
Modem and Internet Connection Problems	32
Scanner Problems	34
PC Card Problems	34
Touch Pad or Mouse Problems	35
External Keyboard Problems	35
Unexpected Characters	36
Drive Problems	36
If you cannot play a CD	36
If you cannot eject the CD drive tray	37
If you hear an unfamiliar scraping or grinding sound	37
If you have problems with a hard drive	37
General Program Problems	38
A program crashes	38
A program stops responding	38
A solid blue screen appears	38
Error messages appear	39
E-Mail Problems	39
If Your Computer Gets Wet	39

If You Drop or Damage Your Computer	40
Resolving Other Technical Problems	41
Reinstalling Drivers and Utilities	41
Reinstalling the Modem Driver	42
Using the Windows XP Device Driver Rollback	43
Resolving Software and Hardware Incompatibilities	44
Using System Restore	45
Creating a Restore Point	46
Restoring the Computer to an Earlier Operating State	46
Undoing the Last System Restore	47
Reinstalling Windows® XP	48
Enabling Hibernate Mode	49

3 Replacing Parts

Adding Memory	52
Replacing the Hard Drive	55
Returning a Hard Drive to Dell	57
Removing a Battery	57
Installing a Battery	58
Replacing a Daughter Card Modem	58

4 Appendix

Specifications	62
Standard Settings	67
Viewing the System Setup Screens	68
System Setup Screens	68

Returning Items for Warranty Repair or Credit	69
Contacting Dell	70
Regulatory Notices	85
CE Notice (European Union)	86
CE Mark Notice	87
 Index	 89

Safety and Use Instructions



Caution: Safety Instructions

The following information defines the meaning of *additional* symbols used *only* in "Safety and Use Instructions."



Risk of explosion



Aircraft



Risk of fire



Use of this feature may be prohibited on aircraft



Risk of electric shock



Caution: General (Safety Instructions, *continued*)

- Do not attempt to service the computer yourself unless you are an authorized service technician. Always follow installation instructions closely.
- If you use an extension power cable with your AC adapter, ensure that the total ampere rating of the products plugged in to the extension power cable does not exceed the ampere rating of the extension cable.



- Do not push objects into air vents or openings of your computer. Doing so can cause fire or electric shock by shorting out interior components.



- Place the AC adapter in a ventilated area, such as a desk top or on the floor, when you use it to run the computer or to charge the battery. Do not cover the AC adapter with papers or other items that will reduce cooling; also, do not use the AC adapter inside a carrying case.

- The AC adapter may become hot during normal operation of your computer. Use care when handling the adapter during or immediately after operation.
- Do not allow your portable computer to operate with the base resting directly on exposed skin for extended periods of time. The surface temperature of the base will rise during normal operation (particularly when AC power is present). Allowing sustained contact with exposed skin can cause discomfort or, eventually, a burn.



- Do not use your computer in a wet environment, for example, near a bath tub, sink, or swimming pool or in a wet basement.



- If your computer includes an integrated or optional (PC Card) modem, disconnect the modem cable if an electrical storm is approaching to avoid the remote risk of electric shock from lightning via the telephone line.



- To help avoid the potential hazard of electric shock, do not connect or disconnect any cables or perform maintenance or reconfiguration of this product during an electrical storm. Do not use your computer during an electrical storm unless all cables have been disconnected and the computer is operating on battery power.
- If your computer includes a modem, the cable used with the modem should be manufactured with a minimum wire size of 26 American wire gauge (AWG) and an FCC-compliant RJ-11 modular plug.
- PC Cards may become very warm during normal operation. Use care when removing PC Cards after their continuous operation.
- Before you clean your computer, remove power. Clean your computer with a soft cloth dampened with water. Do not use liquid or aerosol cleaners, which may contain flammable substances.



Caution: Power (Safety Instructions, *continued*)



- Use only the Dell-provided AC adapter approved for use with this computer. Use of another AC adapter may cause a fire or explosion.
- Before you connect the computer to an electrical outlet, check the AC adapter voltage rating to ensure that the required voltage and frequency match the available power source.
- To remove power from the computer, turn it off, remove the battery pack, and disconnect the AC adapter from the electrical outlet.



- To help prevent electric shock, plug the AC adapter and peripheral power cables into properly grounded power sources. These power cables may be equipped with three-prong plugs to provide an earth grounding connection. Do not use adapter plugs or remove the grounding prong from the power cable plug. If you use a power extension cable, use the appropriate type, two-prong or three-prong, to mate with the AC adapter power cable.
- Be sure that nothing rests on your AC adapter's power cable and that the cable is not located where it can be tripped over or stepped on.



- If you are using a multiple-outlet power strip, use caution when plugging the AC adapter's power cable into the power strip. Some power strips may allow you to insert the plug incorrectly. Incorrect insertion of the power plug could result in permanent damage to your computer, as well as risk of electric shock and/or fire. Ensure that the ground prong of the power plug is inserted into the mating ground contact of the power strip.



Caution: Battery (Safety Instructions, *continued*)



- Use only Dell battery modules that are approved for use with this computer. Use of other types may increase the risk of fire or explosion.



- Do not carry a battery pack in your pocket, purse, or other container where metal objects (such as car keys or paper clips) could short-circuit the battery terminals. The resulting excessive current flow can cause extremely high temperatures and may result in damage to the battery pack or cause fire or burns.

- The battery poses a burn hazard if you handle it improperly. Do not disassemble it. Handle a damaged or leaking battery pack with extreme care. If the battery is damaged, electrolyte may leak from the cells and may cause personal injury.

- Keep the battery away from children.



- Do not store or leave your computer or battery pack near a heat source such as a radiator, fireplace, stove, electric heater, or other heat-generating appliance or otherwise expose it to temperatures in excess of 60°C (140°F). When heated to excessive temperatures, battery cells could explode or vent, posing a risk of fire.



- Do not dispose of your computer's battery in a fire or with normal household waste. Battery cells may explode. Discard a used battery according to the manufacturer's instructions or contact your local waste disposal agency for disposal instructions. Dispose of a spent or damaged battery promptly.



Caution: Air Travel (Safety Instructions, *continued*)



- Certain Federal Aviation Administration regulations and/or airline-specific restrictions may apply to the operation of your Dell™ computer while you are on board an aircraft. For example, such regulations/restrictions may prohibit the use of any personal electronic device (PED) that has the capacity for intentional transmission of radio frequency or other electromagnetic signals while on an aircraft.



- In order to best comply with all such restrictions, if your Dell portable computer is equipped with Dell TrueMobile™ or some other wireless communication device, please disable this device before you board the aircraft and follow all instructions provided by airline personnel with regard to such device.



- Additionally, the use of any PED, such as a portable computer, may be prohibited in aircraft during certain critical phases of flight, for example, takeoff and landing. Some airlines may further define the critical flight phase as any time the aircraft is below 3050 m (10,000 ft). Please follow the airline's specific instructions as to when the use of a PED is allowed.

When Using Your Computer

Observe the following safe-handling guidelines to prevent damage to your computer:

- When setting up the computer for work, place it on a level surface.
- When traveling, do not check the computer as baggage. You can put your computer through an X-ray security machine, but never put your computer through a metal detector. If you have the computer checked by hand, be sure to have a charged battery available in case you are asked to turn on the computer.
- When traveling with the hard drive removed from the computer, wrap the drive in a nonconducting material, such as cloth or paper. If you have the drive checked by hand, be ready to install the drive in the computer. You can put the hard drive through an X-ray security machine, but never put the drive through a metal detector.

- When traveling, do not place the computer in overhead storage compartments where it could slide around. Do not drop your computer or subject it to other mechanical shocks.
 - Protect your computer, battery, and hard drive from environmental hazards such as dirt, dust, food, liquids, temperature extremes, and overexposure to sunlight.
 - When you move your computer between environments with very different temperature and/or humidity ranges, condensation may form on or within the computer. To avoid damaging the computer, allow sufficient time for the moisture to evaporate before using the computer.
-  **NOTICE:** When taking the computer from low-temperature conditions into a warmer environment or from high-temperature conditions into a cooler environment, allow the computer to acclimate to room temperature before turning on power.
- When you disconnect a cable, pull on its connector or on its strain-relief loop, not on the cable itself. As you pull out the connector, keep it evenly aligned to avoid bending any connector pins. Also, before you connect a cable make sure both connectors are correctly oriented and aligned.
 - Handle components with care. Hold a component such as a memory module by its edges, not its pins.
 - When preparing to remove a memory module from the system board or disconnect a peripheral device from the computer, turn off the computer, disconnect the AC adapter cable, and then wait 5 seconds before proceeding to help avoid possible damage to the system board.
 - Clean the display with a soft, clean cloth and commercial window cleaner that does not contain wax or abrasives. Apply the cleaner to the cloth; then stroke the cloth across the display in one direction, moving from the top of the display to the bottom. If the display contains grease or some other contaminant, use isopropyl alcohol instead of commercial window cleaner.
 - If your computer gets wet or is damaged, follow the procedures described in "If Your Computer Gets Wet" on page 39. If, after following these procedures, you confirm that your computer is not operating properly, contact Dell ("Contacting Dell" on page 70 for the appropriate contact information).

Ergonomic Computing Habits

 **CAUTION:** Improper or prolonged keyboard use may result in injury.

 **CAUTION:** Viewing the display or external monitor screen for extended periods of time may result in eye strain.

For comfort and efficiency, observe the ergonomic guidelines in the *Tell Me How* help file when setting up and using your computer (see "Accessing Help" on page 26).

When Removing or Installing Memory Modules

Before removing or installing memory modules, perform the following steps in the sequence indicated.

 **NOTICE:** The only time you should ever access the inside of your computer is when you are installing memory modules.

 **NOTICE:** Wait 5 seconds after turning off the computer before disconnecting a peripheral device or removing a memory module to help prevent possible damage to the system board.

- 1 Turn off your computer and any attached peripherals.
- 2 Disconnect your computer and peripherals from electrical outlets to reduce the potential for personal injury or shock. Also, disconnect any telephone or telecommunication lines from the computer.
- 3 Remove the main battery from the battery compartment and, if necessary, the secondary battery from the module bay.
- 4 Ground yourself by touching the unpainted metal surface of the I/O panel on the back of the computer.

While you work, periodically touch the I/O panel to dissipate any static electricity that might harm internal components.

Protecting Against Electrostatic Discharge

Static electricity can harm electronic components inside your computer. To prevent static damage, discharge static electricity from your body before you touch any of your computer's electronic components, such as a memory module. You can do so by touching an unpainted metal surface on the computer's I/O panel.

As you continue to work inside the computer, periodically touch an I/O connector to remove any static charge your body may have accumulated.

You can also take the following steps to prevent damage from electrostatic discharge (ESD):

- When unpacking a static-sensitive component from its shipping carton, do not remove the component from the antistatic packing material until you are ready to install the component. Just before unwrapping the antistatic packaging, be sure to discharge static electricity from your body.
- When transporting a sensitive component, first place it in an antistatic container or packaging.
- Handle all sensitive components in a static-safe area. If possible, use antistatic floor pads and workbench pads.

The following notice may appear throughout this document to remind you of these precautions:

 **NOTICE:** See “Protecting Against Electrostatic Discharge” in the safety instructions at the front of this guide.

Battery Disposal



Your computer uses a lithium-ion battery and a nickel-metal hydride (NiMH) coin-cell battery. For instructions about replacing the lithium-ion battery in your computer, refer to the section about replacing the battery in your Dell computer documentation. The coin-cell battery is a long-life battery, and it is very possible that you will never need to replace it. However, should you need to replace it, the procedure must be performed by an authorized service technician.

Do not dispose of the battery along with household waste. Contact your local waste disposal agency for the address of the nearest battery deposit site.

SECTION 1

Setting Up

Connecting a Printer

Transferring Information to a New Computer
(Windows[®] XP Only)

Setting Up a Home and Office Network
(Windows XP Only)

Turning Off the Computer

Power Protection Devices

Connecting a Printer

See the documentation that came with the printer for any recommended preparation procedures, such as:

- Removing the packaging
- Installing the toner or ink cartridge
- Loading paper

Then follow the instructions that came with the printer to connect it to the computer. If no information is provided, see the following sections.



HINT: For complete printer driver installation instructions, refer to your printer documentation.

Parallel Printer

- 1 Turn off the computer (see page 20).



NOTICE: Use only a standard parallel cable measuring 3 m (10 ft) or less to connect the printer to the computer. Use of a nonstandard cable may prevent the printer from working.

- 2 Attach the parallel printer cable to the parallel connector on the computer and tighten the two screws. Attach the cable to the parallel connector on the printer and snap the two clips into the two notches.

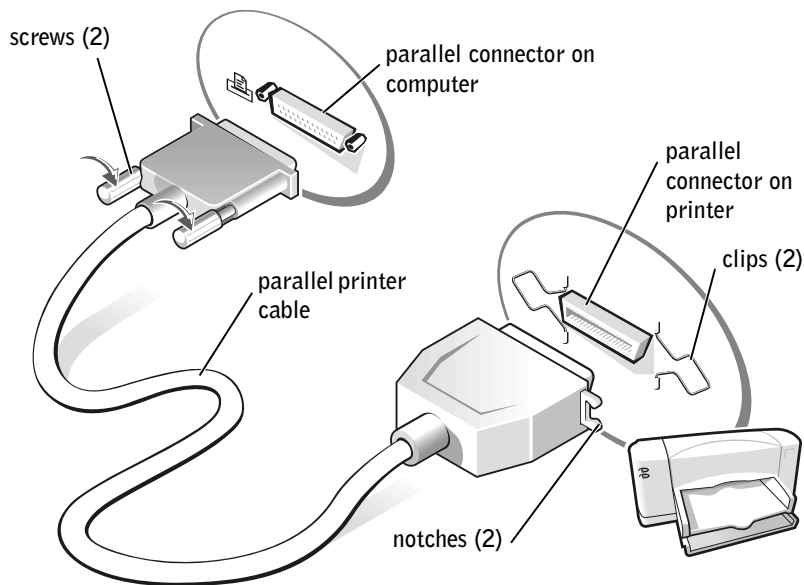

- 3 Turn on the printer and then turn on the computer. If the **Add New Hardware Wizard** window appears, click **Cancel**.
- 4 Install the printer driver if necessary (see page 18).

USB Printer

- 1 Install the printer driver if necessary (see page 18).
- 2 Attach the USB printer cable to the USB connector on the computer and the printer. The USB connectors fit only one way.

 **HINT:** You can connect USB devices while the computer is turned on.

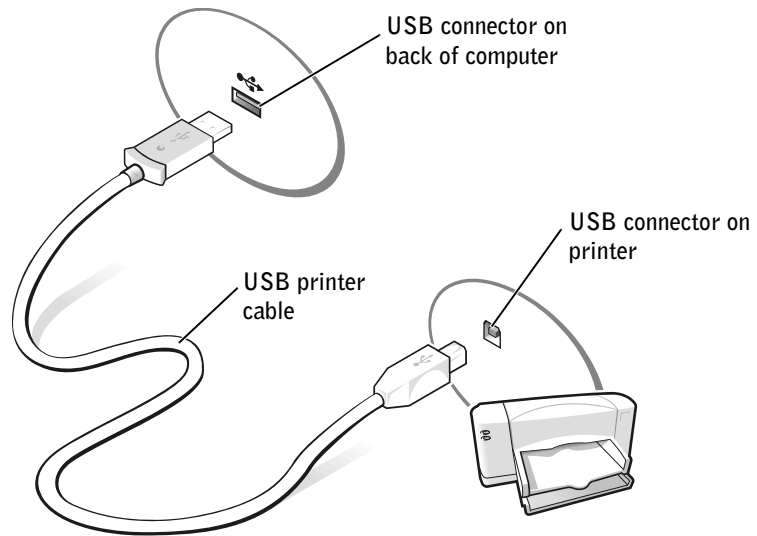

Installing the Printer Driver

If you need to install a printer driver, insert the installation CD into the CD drive. Then follow the prompts on the screen and use the instructions that came with the printer.

If your printer installation CD does not automatically run, click the **Start** button, click **Run**, and type `x:\setup.exe` (where *x* is the letter of your CD drive [usually drive D]). Then click **OK** and follow the prompts on your screen. If your printer installation CD still does not run, check the documentation that came with your printer for instructions on how to start the printer installation CD.

To determine whether your printer driver is installed on a computer running the Microsoft® Windows XP operating system, click the **Start** button, click **Control Panel**, click **Printers and Other Hardware**, and then click **View installed printers or fax printers**. If your printer model is listed in the **Printers** window, the printer is ready to use.

Transferring Information to a New Computer (Windows® XP Only)

Windows XP provides a **Files and Settings Transfer Wizard** to move data such as e-mails, window sizes, toolbar settings, and Internet bookmarks, from one computer to another. First you collect the data from the source computer, and then you import the data to the new computer.

If the source computer uses another Windows operating system, you can launch the wizard from the Windows XP *Operating System* CD or from a floppy disk created on a computer that is running Windows XP. You can transfer the data to the new computer over a network or you can store it on a removable medium, such as a floppy disk or a writable CD.

- 1 On the computer running Windows XP, click the **Start** button, point to **All Programs**→**Accessories**→**System Tools**, and then click **Files and Settings Transfer Wizard**.
- 2 On the welcome screen, click **Next**.
- 3 On the **Which computer is this?** screen, select **New Computer**, and then click **Next**.
- 4 Follow the instructions on the screen.

Setting Up a Home and Office Network (Windows XP Only)

Windows XP provides a **Network Setup Wizard** to guide you through the process of sharing files, printers, or an Internet connection between computers in a home or small office.

- 1 Click the **Start** button, point to **All Programs**→**Accessories**→**Communications**, and then click **Network Setup Wizard**.
- 2 On the welcome screen, click **Next**.
- 3 Click **checklist for creating a network**.

 **HINT:** Selecting the **This computer connects directly to the Internet** connection method enables the integrated firewall provided with Windows XP.

 **HINT:** If you are having difficulties turning off your computer, see "General Program Problems" on page 38.

- 4 Complete the checklist and required preparations, and then return to the **Network Setup Wizard**.
- 5 Follow the instructions on the screen.

Turning Off the Computer

 **NOTICE:** To prevent data loss, you must turn off your computer through the **Start** menu rather than by pressing the power button.

- 1 Save and close any open files and exit any open programs.
- 2 Click the **Start** button and then click **Turn off Computer**.
- 3 Click **Turn off**.

The computer automatically turns off after the shutdown process finishes.

Power Protection Devices

Several devices are available that protect against power fluctuations and failures:

- Surge protectors
- Line conditioners
- Uninterruptible power supplies (UPS)

Surge Protectors

Surge protectors and power strips equipped with surge protection help to prevent damage to your computer from voltage spikes that can occur during electrical storms or following power interruptions. The level of protection is usually commensurate with the cost of the surge protector. Some surge protector manufacturers include warranty coverage for certain types of damage. Dell recommends that you carefully read the device warranty when choosing a surge protector. Compare joule ratings to determine the relative effectiveness of different devices.

 **NOTICE:** Most surge protectors do not protect against lightning strikes. Dell recommends that you disconnect your computer from the electrical outlet when lightning occurs in your area.

 **NOTICE:** Surge protectors do not protect against power fluctuations or power interruptions.

Power surges on telephone lines can damage modems. Dell recommends that you disconnect the telephone line from the telephone wall jack during electrical storms. Many surge protectors have a telephone jack for modem protection. See the surge protector documentation for modem connection instructions.

 **NOTICE:** Network adapter protection is not available on surge protectors. Dell recommends that you disconnect the network cable from the network wall jack during electrical storms.

Line Conditioners

 **NOTICE:** Line conditioners do not protect against power interruptions.

Line conditioners are designed to maintain AC voltage at a fairly constant level. Line conditioners can cost up to several hundred dollars more than surge protectors.

Uninterruptible Power Supply Devices

 **NOTICE:** Loss of power while data is being saved to the hard drive may result in data loss or file damage.

A UPS protects against power fluctuations and interruptions. UPS devices contain a battery that provides temporary power to connected devices when AC power is interrupted. The battery charges while AC power is available. See the UPS manufacturer documentation for information on battery operating time and to ensure that the device is approved by Underwriters Laboratories (UL).

 **HINT:** To ensure maximum battery operating time, connect only your computer to a UPS. Connect other devices, such as a printer, to a separate power strip that provides surge protection.

SECTION 2

Solving Problems

- Finding Solutions
- Accessing Help
- Power Problems
- Error Messages
- Video and Display Problems
- Sound and Speaker Problems
- Printer Problems
- Modem and Internet Connection Problems
- Scanner Problems
- PC Card Problems
- Touch Pad or Mouse Problems
- External Keyboard Problems
- Unexpected Characters
- Drive Problems
- General Program Problems
- E-Mail Problems
- If Your Computer Gets Wet
- If You Drop or Damage Your Computer
- Resolving Other Technical Problems
- Reinstalling Drivers and Utilities
- Resolving Software and Hardware Incompatibilities
- Using System Restore
- Reinstalling Windows[®] XP
- Enabling Hibernate Mode

 **HINT:** If you have a problem with an external device, see the device documentation or contact the manufacturer.

Finding Solutions

Sometimes it's difficult to figure out where to go for answers. Use this chart to quickly find the answers to your questions.

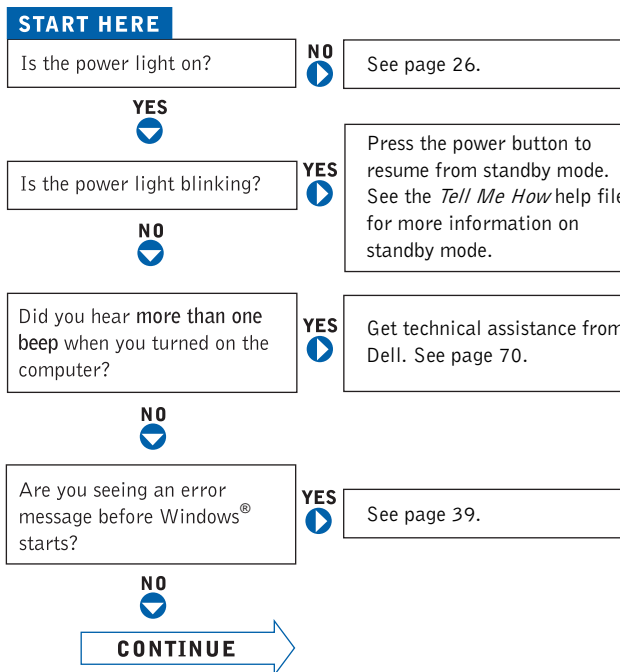

Are you having a problem with...

NO
▶

- ▶ video or the display? **YES** ▶ See page 29.
- ▶ sound or the speakers? **YES** ▶ See page 31.
- ▶ the printer? **YES** ▶ See page 31.
- ▶ the modem? **YES** ▶ See page 32.
- ▶ the scanner? **YES** ▶ See page 34.
- ▶ the touch pad? **YES** ▶ See page 35.
- ▶ the external keyboard? **YES** ▶ See page 35.
- ▶ unexpected characters? **YES** ▶ See page 36.
- ▶ the hard drive or a disk drive? **YES** ▶ See page 36.
- ▶ Windows error messages? **YES** ▶ See page 39.
- ▶ a program? **YES** ▶ See page 38.
- ▶ the Internet? **YES** ▶ See page 39.
- ▶ your e-mail? **YES** ▶ See page 39.

Are you having some other type of problem?

YES ▶ See page 38.

Accessing Help

TO ACCESS THE *Tell Me How* HELP FILE

Microsoft® Windows® XP

- 1 Click the **Start** button and then click **Help and Support**.
- 2 Click **User and system guides** and then click **User's guides**.
- 3 Click **Tell Me How**.

TO ACCESS HELP IN WINDOWS® XP

- 1 Click the **Start** button and then click **Help and Support**.
- 2 Type a word or phrase that describes your problem and then click the arrow icon.
- 3 Click the topic that describes your problem and then click **Display**.
- 4 Follow the instructions shown on the screen.

Power Problems



HINT: See the *Tell Me How* help file for information on standby mode. To access the help file, see page 26.

CHECK THE POWER LIGHT — When the power light is lit or blinking orange, the battery charge is low or depleted. Charge the battery.

If the power light is off, the computer is turned off or the battery is too hot to charge. Turn off the computer, disconnect the AC adapter, and then let the computer and battery cool before attempting to charge the battery.

CHARGE THE BATTERY — The battery charge may be depleted.

- 1 Reinstall the battery.
- 2 Use the AC adapter to connect the computer to an electrical outlet.
- 3 Turn on the computer.

CHECK THE BATTERY STATUS LIGHT — If the battery status light flashes orange or is a steady orange the battery charge is low or depleted. Connect the computer to an electrical outlet.

If the battery status light flashes green and orange, the battery is too hot to charge. Turn off the computer (see page 20), disconnect the computer from the electrical outlet, and then let the battery and computer cool to room temperature.

If the battery status light rapidly flashes orange, the battery may be defective. Contact Dell (see page 70).

TEST THE ELECTRICAL OUTLET — Ensure that the electrical outlet is working by testing it with another device, such as a lamp.

CHECK THE AC ADAPTER — Check the AC adapter cable connections. If the AC adapter has a light, ensure that the light is on.

CONNECT THE COMPUTER DIRECTLY TO AN ELECTRICAL OUTLET — Bypass power protection devices, power strips, and the extension cable to verify that the computer turns on.

ELIMINATE POSSIBLE INTERFERENCE — Turn off nearby fans, fluorescent lights, halogen lamps, or other appliances.

ADJUST THE POWER PROPERTIES — See the *Tell Me How* help file or search for the keyword *standby* in the Help and Support Center. To access help, see page 26.

RESET THE MEMORY MODULES — If the computer power light turns on but the display remains blank, reset the memory modules (see page 52).

Error Messages

If the message is not listed, see the documentation for the operating system or the application program that was running at the time the message appeared.

A FILENAME CANNOT CONTAIN ANY OF THE FOLLOWING CHARACTERS: \ / : * ? " < > | — Do not use these characters in filenames.

INSERT BOOTABLE MEDIA — The operating system is trying to boot to a nonbootable CD. Insert a bootable CD.

NOT ENOUGH MEMORY OR RESOURCES. CLOSE SOME PROGRAMS AND TRY AGAIN — You have too many programs open. Close all windows and open the program that you want to use.

OPERATING SYSTEM NOT FOUND — Contact Dell (see page 70).



A REQUIRED .DLL FILE WAS NOT FOUND — The program that you are trying to open is missing an essential file. Remove and then reinstall the program.



- 1 *Click the Start button.*
- 2 *Click Control Panel.*
- 3 *Click Add or Remove Programs.*
- 4 *Select the program you want to remove.*
- 5 *Click the Change or Remove Program icon.*
- 6 *See the program documentation for installation instructions.*

X:\ IS NOT ACCESSIBLE. THE DEVICE IS NOT READY — Insert a disk into the drive and try again.

Video and Display Problems

If the display is blank

CHECK THE  LIGHT — When the  light is blinking, the computer has power.

- If the  light is blinking, the computer is in standby mode—press the power button to exit standby mode.
- If the  light is off, press the power button.
- If the  light is on, your power management settings may have caused the display to turn off. Try pressing any key or move the cursor to exit standby mode.

CHECK THE BATTERY — If you are using a battery to power your computer, the battery charge may be depleted. Connect the computer to an electrical outlet using the AC adapter, and turn on the computer.



TEST THE ELECTRICAL OUTLET — Ensure that the electrical outlet is working by testing it with another device, such as a lamp.

CHECK THE AC ADAPTER — Check the AC adapter cable connections. If the AC adapter has a light, ensure that it is on.

CONNECT THE COMPUTER DIRECTLY TO AN ELECTRICAL OUTLET —

Bypass power protection devices, power strips, and the extension cable to verify that the computer turns on. To access the help file, see page 26.

ADJUST THE POWER PROPERTIES — See the *Tell Me How* help file or search for the keyword *standby* in the Help and Support Center. To access help, see page 26.

SWITCH THE VIDEO IMAGE — If your computer is attached to an external monitor, press   to switch the video image to the display.

 **HINT:** If you are using a program that requires a higher resolution than your computer supports, Dell recommends that you attach an external monitor to your computer.

If the display is difficult to read

ADJUST THE BRIGHTNESS — See the *Tell Me How* help file for instructions on adjusting the brightness. To access the help file, see page 26.

MOVE THE SUBWOOFER AWAY FROM THE COMPUTER OR MONITOR — If your external speaker system includes a subwoofer, ensure that the subwoofer is at least 60 cm (2 ft) away from the computer or external monitor.

ELIMINATE POSSIBLE INTERFERENCE — Turn off nearby fans, fluorescent lights, halogen lamps, or other appliances.

ROTATE THE COMPUTER TO FACE A DIFFERENT DIRECTION — Eliminate sunlight glare, which can cause poor picture quality.

ADJUST THE WINDOWS DISPLAY SETTINGS

- 1 Click the **Start** button and then click **Control Panel**.
- 2 Click **Appearance and Themes**.
- 3 Click the area you want to change or click the **Display** icon.
- 4 Try different settings for **Color quality** and **Screen resolution**.

SEE "ERROR MESSAGES" — If an error message appears, see page 28.

If only part of the display is readable

CONNECT AN EXTERNAL MONITOR

- 1 Turn off your computer and connect an external monitor to the computer.
- 2 Turn on the computer and the monitor and adjust the monitor brightness and contrast controls.

If the external monitor works, the computer display or video controller may be defective. Contact Dell (see page 70).

Sound and Speaker Problems

If you have a problem with integrated speakers

ADJUST THE WINDOWS® VOLUME CONTROL — Double-click the speaker icon in the lower-right corner of your screen. Ensure that the volume is turned up and that the sound is not muted. Adjust the volume, bass, or treble controls to eliminate distortion.

ADJUST THE VOLUME USING KEYBOARD SHORTCUTS — Press



to disable (mute) or reenable the integrated speakers.

REINSTALL THE SOUND (AUDIO) DRIVER — See page 41.

Printer Problems

CHECK THE PRINTER CABLE CONNECTIONS — Ensure that the printer cable is properly connected to the computer (see page 16).

TEST THE ELECTRICAL OUTLET — Ensure that the electrical outlet is working by testing it with another device, such as a lamp.

ENSURE THAT THE PRINTER IS TURNED ON — See the documentation supplied with the printer.

VERIFY THAT WINDOWS® RECOGNIZES THE PRINTER

- 1 Click the **Start** button.
- 2 Click **Control Panel**.
- 3 Click **Printers and Other Hardware**.
- 4 Click **View installed printers or fax printers**. If the printer model is listed, right-click the printer icon.
- 5 Click **Properties**, and then click the **Ports** tab.
- 6 Ensure that the **Print to the following port(s)** setting is set for your printer type:
 - For a parallel printer: **LPT1 (Printer Port)**
 - For a USB printer: **USB**

REINSTALL THE PRINTER DRIVER — See page 18.

Modem and Internet Connection Problems

- ➔ **NOTICE:** Connect the modem to an analog telephone wall jack only. Connecting the modem to a digital telephone network damages the modem.
- ➔ **NOTICE:** Modem and network connectors look similar. Do not plug a telephone line into the network connector.

 **HINT:** If you can connect to your Internet service provider (ISP), your modem is functioning properly. If you are sure that your modem is working properly and you still experience problems, contact your ISP.

CHECK THE TELEPHONE WALL JACK — Disconnect the telephone line from the modem and connect it to a telephone. Listen for a dial tone. Ensure that you have touchtone telephone service. Try connecting the modem to a different telephone wall jack.

Slow connection speeds can be caused by telephone noise as well as by telephone line or network conditions. Contact your telephone company or network administrator for more information.

CONNECT THE MODEM DIRECTLY TO THE TELEPHONE WALL JACK —

If you have other telephone devices sharing the line, such as an answering machine, fax machine, surge protector, or line splitter, then bypass them and use the telephone line to connect the modem directly to the telephone wall jack.

CHECK THE CONNECTION — Verify that the telephone line is connected to the modem.

CHECK THE TELEPHONE LINE — Try using a different telephone line. If you are using a line that is 3 m (10 ft) or more in length, try a shorter one.

IRREGULAR DIAL TONE — If you have voice mail service, you might hear an irregular dial tone when you have messages. Contact your telephone company for instructions on restoring a dial tone.

TURN OFF CALL WAITING (CATCH-PHONE) — See your telephone directory for instructions on deactivating this feature. Then adjust the dial-up networking connection properties.

- 1 Click the **Start** button and click **Control Panel**.
- 2 Click **Printers and Other Hardware**, click **Phone and Modem Options**, click the **Dialing Rules** tab, and then click **Edit...**
- 3 In the **Edit Location** window, ensure that **To disable call waiting, dial:** is checked, and then select the proper code as listed in your telephone directory.
- 4 Click **Apply** and click **OK**.
- 5 Close the **Phone and Modems Options** window.
- 6 Close the **Control Panel** window.

VERIFY THAT THE MODEM IS COMMUNICATING WITH WINDOWS

- 1 Click the **Start** button and click **Control Panel**.
- 2 Click **Printers and Other Hardware** and click **Phone and Modem Options**.
- 3 Click the **Modems** tab.
- 4 Click the COM port for your modem.
- 5 Click **Properties**, click the **Diagnostics** tab, and then click **Query Modem** to verify that the modem is communicating with Windows.

If all commands receive responses, the modem is operating properly.

Scanner Problems

CHECK THE POWER CABLE CONNECTION — Ensure that the scanner power cable is firmly connected to a working electrical power source and that the scanner is turned on. If the device is plugged into a surge protector, try plugging it directly into an electrical outlet.

CHECK THE SCANNER CABLE CONNECTION — Ensure that the scanner cable is firmly connected to the computer and to the scanner.

UNLOCK THE SCANNER — Ensure that your scanner is unlocked if it has a locking tab or button.

REINSTALL THE SCANNER DRIVER — See the scanner documentation for instructions.

PC Card Problems

CHECK THE PC CARD — Ensure that the PC Card is properly inserted into the connector.

ENSURE THAT THE CARD IS RECOGNIZED BY WINDOWS® — Double-click the **Unplug or Eject Hardware** icon in the Windows taskbar. Ensure that the card is listed.

IF YOU HAVE PROBLEMS WITH A DELL-PROVIDED PC CARD — Contact Dell (see page 70).

IF YOU HAVE PROBLEMS WITH A PC CARD NOT PROVIDED BY DELL — Contact the PC Card manufacturer.

Touch Pad or Mouse Problems

CHECK THE TOUCH PAD SETTINGS

- 1 Click the Start button, click Control Panel, and then click Printers and Other Hardware.
- 2 Click Mouse.
Try adjusting the settings.

CHECK THE MOUSE CABLE — Shut down the computer (see page 20). Disconnect the mouse cable and check it for damage. For PS/2 cables, check the cable connector for bent or broken pins. Firmly reconnect the cable.

If you are using a mouse extension cable, disconnect it and connect the mouse directly to the computer.

TO VERIFY THAT THE PROBLEM IS WITH THE MOUSE, CHECK THE TOUCH PAD

- 1 Turn off the computer.
- 2 Disconnect the mouse.
- 3 Turn on the computer.
- 4 At the Windows desktop, use the touch pad to move the cursor around, select an icon, and open it.

If the touch pad operates correctly, the mouse may be defective.

REINSTALL THE TOUCH PAD DRIVER — See page 41.

External Keyboard Problems

CHECK THE KEYBOARD CABLE — Shut down the computer (see page 20). Disconnect the keyboard cable and check it for damage. For PS/2 cables, check the cable connector for bent or broken pins. Firmly reconnect the cable.

If you are using a keyboard extension cable, disconnect it and connect the keyboard directly to the computer.

 **HINT:** When you attach an external keyboard, the integrated keyboard remains fully functional.

CHECK THE EXTERNAL KEYBOARD

- 1 Turn off the computer, wait 1 minute, and turn it on again.
- 2 Verify that the numbers, capitals, and scroll lock lights on the keyboard blink during the boot routine.
- 3 From the Windows® desktop, click the **Start** button, point to **Programs**, point to **Accessories**, and click **Notepad**.
- 4 Type some characters on the external keyboard and verify that they appear on the display.



If you cannot verify these steps, you may have a defective external keyboard.

TO VERIFY THAT THE PROBLEM IS WITH THE EXTERNAL KEYBOARD, CHECK THE INTEGRATED KEYBOARD

- 1 Turn off the computer.
- 2 Disconnect the external keyboard.
- 3 Turn on the computer.
- 4 From the Windows desktop, click the **Start** button, point to **Programs**, point to **Accessories**, and click **Notepad**.
- 5 Type some characters on the integrated keyboard and verify that they appear on the display.

If the characters appear now but did not with the external keyboard, you may have a defective external keyboard. Contact Dell (see page 70).

Unexpected Characters

Press  to disable the numeric keypad. Verify that the numbers lock light  is not lit.

Drive Problems

If you cannot play a CD

High-speed CD drive vibration is normal and may cause noise. This noise does not indicate a defect with the drive or the CD.

ENSURE THAT WINDOWS® RECOGNIZES THE DRIVE — In Windows XP, click the **Start** button and click **My Computer**. If the drive is not listed, perform a full scan with your antivirus software to check for and remove viruses. Viruses can sometimes prevent Windows from recognizing the drive. Insert a bootable disk and restart the computer. Verify that the  light is blinking, indicating normal operation.

TRY ANOTHER DISC — Insert another disc to eliminate the possibility that the original disc is defective.

ADJUST THE WINDOWS VOLUME CONTROL — Double-click the speaker icon in the lower-right corner of your screen. Ensure that the volume is turned up and that the sound is not muted.

CLEAN THE DRIVE OR DISC — See "Cleaning Your Computer" in the *Tell Me How* help file for instructions. To access the help file, see page 26.

If you cannot eject the CD drive tray

- 1 Ensure that the computer is turned off.
- 2 Straighten a paper clip and insert one end into the eject hole at the front of the drive; push firmly until the tray is partially ejected.
- 3 Gently pull out the tray until it stops.

If you hear an unfamiliar scraping or grinding sound

- Ensure that the sound is not caused by the program that is running.
- Ensure that the disc is inserted properly.

If you have problems with a hard drive

ALLOW THE COMPUTER TO COOL BEFORE TURNING IT ON — A hot hard drive may prevent the operating system from starting. Try allowing the computer to return to room temperature before turning it on.

 **HINT:** Software usually includes installation instructions in its documentation or on a floppy disk or CD.

CHECK THE DRIVE FOR ERRORS

- 1 In *Windows XP*, click the **Start** button and click **My Computer**.
- 2 Right-click the drive letter (local disk) that you want to scan for errors, and then click **Properties**.
- 3 Click the **Tools** tab.
- 4 Under **Error-checking**, click **Check Now**.
- 5 Click **Start**.



General Program Problems

A program crashes

SEE THE SOFTWARE DOCUMENTATION — Many software manufacturers maintain websites with information that may help you solve the problem. Ensure that you properly installed and configured the program. Reinstall the program if necessary.

A program stops responding

END THE PROGRAM

- 1 Simultaneously press   .
- 2 Click the **Applications** tab, and then select the program that is no longer responding.
- 3 Click the **End Task** button.

A solid blue screen appears

TURN THE COMPUTER OFF — If the computer does not respond to a keystroke or a proper shutdown (see page 20), press the power button until the computer turns off. Press the power button again to restart the computer. The solid blue screen appears because you were not able to perform a proper **Windows®** shutdown. **ScanDisk** automatically runs during the start-up process. Follow the instructions on the screen.

Error messages appear

REVIEW "ERROR MESSAGES" — Look up the message and take the appropriate action. See the software documentation.

E-Mail Problems

ENSURE THAT YOU ARE CONNECTED TO THE INTERNET — With the Outlook Express e-mail program open, click **File**. If **Work Offline** has a check mark next to it, click the check mark to remove it and connect to the Internet.

BE SURE THAT YOU HAVE SUBSCRIBED TO AN INTERNET SERVICE PROVIDER — Contact an Internet service provider to subscribe.

CONTACT YOUR INTERNET SERVICE PROVIDER — Contact your Internet service provider for assistance.

If Your Computer Gets Wet



CAUTION: Perform this procedure only after you are certain that it is safe to do so. If the computer is connected to an electrical outlet, Dell recommends that you turn off AC power at the circuit breaker before attempting to remove the power cables from the electrical outlet. Use the utmost caution when removing wet cables from a live power source.

- 1 Turn off the computer (see page 20), disconnect the AC adapter from the computer, and then disconnect the AC adapter from the electrical outlet.
- 2 Turn off any attached external devices, and disconnect them from their power sources and then from the computer.
- 3 Ground yourself by touching one of the metal connectors on the back of the computer.
- 4 Remove any installed PC Cards, and put them in a safe place to dry.
- 5 Remove the battery.
- 6 Wipe off the battery and put it in a safe place to dry.

- 7 Remove the hard drive (see page 55).
- 8 Remove the memory module (see page 52).
- 9 Open the display and place the computer right-side up across two books or similar props to let air circulate all around it. Let the computer dry for at least 24 hours in a dry area at room temperature.



NOTICE: Do not use artificial means, such as a hair dryer or a fan, to speed the drying process.



CAUTION: To help prevent electrical shock, verify that the computer is thoroughly dry before continuing with the rest of this procedure.

- 10 Ground yourself by touching one of the metal connectors on the back of the computer.
- 11 Replace the memory module, the memory module cover, and the screw.
- 12 Replace the hard drive.
- 13 Replace any PC Cards you removed.
- 14 Replace the battery.
- 15 Turn on the computer and verify that it is working properly.

If the computer does not start, or if you cannot identify the damaged components, contact Dell (see page 70).

If You Drop or Damage Your Computer

- 1 Save and close any open files, exit any open programs, and shut down the computer (see page 20).
- 2 Disconnect the AC adapter from the computer and from the electrical outlet.
- 3 Turn off any attached external devices, and disconnect them from their power sources and then from the computer.
- 4 Remove and reinstall the battery.
- 5 Turn on the computer.

If the computer does not start, or if you cannot identify the damaged components, contact Dell (see page 70).

Resolving Other Technical Problems

GO TO THE DELL | SUPPORT WEBSITE — Go to support.dell.com for help with general usage, installation, and troubleshooting questions.

E-MAIL DELL — Go to support.dell.com and then click E-Mail Dell in the **Communicate** list. Send an e-mail message to Dell about your problem; you can expect to receive an e-mail message from Dell within hours.

CONTACT DELL — If you cannot solve your problem using the Dell | Support website or e-mail service, call Dell for technical assistance (see page 70).

Reinstalling Drivers and Utilities

Dell ships your computer to you with required drivers and utilities already installed—no further installation or configuration is needed.

 **NOTICE:** The *Drivers and Utilities* CD may contain drivers for operating systems that are not on your computer. Ensure that you are installing software appropriate for your operating system.

To reinstall drivers for optional devices you may need the CD and documentation that came with those devices.

To reinstall a driver or utility from your *Drivers and Utilities* CD.

 **NOTICE:** The Dell | Support website, support.dell.com, and the *Drivers and Utilities* CD provide approved drivers for Dell™ computers. If you install drivers from other sources, your computer might not work correctly.

- 1 Save and close any open files, and exit any open programs.
- 2 Insert the *Drivers and Utilities* CD.

In most cases, the CD starts running automatically. If it does not, start Microsoft® Windows® Explorer, click your CD drive directory to display the CD contents, and then double-click the **autocd.exe** file. The first time that you run the CD, it might prompt you to install setup files. Click **OK**, and follow the instructions on the screen to continue.

- 3 From the **Language** pull-down menu in the toolbar, select your preferred language for the driver or utility (if available).

A welcome screen appears.

- 4 Click **Next**. The CD automatically scans your hardware to detect drivers and utilities used by your computer.

After the CD completes the hardware scan, you can also detect other drivers and utilities. Under **Search Criteria**, select the appropriate categories from the **System Model**, **Operating System**, and **Topic** pull-down menus.

A link or links appear(s) for the specific drivers and utilities used by your computer.

- 5 Click the link of a specific driver or utility to display information about the driver or utility that you want to install.
- 6 Click the **Install** button (if present) to begin installing the driver or utility. At the welcome screen, follow the screen prompts to complete the installation.

If no **Install** button is present, automatic installation is not an option. For installation instructions, either see the appropriate instructions in the following subsections, or click the **Extract** button, follow the extracting instructions, and read the readme file.

If instructed to navigate to the driver files, click the CD directory on the driver information window to display the files associated with that driver.

Reinstalling the Modem Driver

- 1 Save and close any open files, exit any open programs, and insert the *Drivers and Utilities* CD.
- 2 Click the **Start** button and click **Control Panel**.
- 3 Under **Pick a category**, click **Performance and Maintenance**.
- 4 Under **or pick a Control Panel icon**, click **System**.
- 5 Click the **Hardware** tab.
- 6 Click **Device Manager**.
- 7 Click **Modem** and click the appropriate modem.
- 8 Click **Action** and click **Update Driver**.

- 9 Click **Install from a list or specific location (Advanced)** and click **Next**.
- 10 Verify that **Search removable media** is selected, and then click **Next**.
- 11 When the name of the appropriate driver appears, click **Next**.
- 12 Click **Finish** and restart your computer.

Using the Windows XP Device Driver Rollback

If you install a new device driver that causes system instability, you can use the Windows XP Device Driver Rollback to replace the new device driver with the previously installed version of the device driver. If you cannot reinstall your previous driver by using the Device Driver Rollback process, then use System Restore (see page 45) to return your operating system to its previous operating state before you installed the new device driver. To use Device Driver Rollback:

- 1 Click the **Start** button and right-click **My Computer**.
- 2 Click **Properties**.
- 3 Click the **Hardware** tab and click **Device Manager**.
- 4 In the **Device Manager** window, right-click the device for which the new driver was installed and then click **Properties**.
- 5 Click the **Drivers** tab.
- 6 Click **Roll Back Driver**.

Resolving Software and Hardware Incompatibilities

In the Microsoft® Windows® XP operating system, IRQ conflicts occur if a device either is not detected during the operating system setup or is detected but incorrectly configured. To check for IRQ conflicts on your computer:

- 1 Click the **Start** button and click **Control Panel**.
- 2 Click **Performance and Maintenance** and click **System**.
- 3 Click the **Hardware** tab and click **Device Manager**.
- 4 In the **Device Manager** list, check for conflicts with the other devices.
Conflicts are indicated by a yellow exclamation point (!) beside the conflicting device or a red X if the device has been disabled.
- 5 Double-click any conflicting device listed to bring up the **Properties** window so that you can determine what needs to be reconfigured or removed from the Device Manager.
- 6 Resolve these conflicts before checking specific devices.
- 7 Double-click the malfunctioning device type in the **Device Manager** list.
- 8 Double-click the icon for the specific device in the expanded list.
The **Properties** window appears.
If an IRQ conflict exists, the **Device status** area in the **Properties** window reports what other devices are sharing the device's IRQ.
- 9 Resolve any IRQ conflicts.

You can also use the Windows XP Hardware Troubleshooter. To use the troubleshooter, click the **Start** button and click **Help and Support**. Type `hardware troubleshooter` in the **Search** field, and then click the arrow to start the search. Click **Hardware Troubleshooter** in the **Search Results** list. In the **Hardware Troubleshooter** list, click **I need to resolve a hardware conflict on my computer**, and then click **Next**.

Using System Restore

The Microsoft® Windows® XP operating system provides a System Restore feature that allows you to return your computer to an earlier operating state if changes to the computer's hardware or software (including new hardware or program installations), or other system settings, have left the computer in an undesirable operating state. You can also undo the last System Restore.

System Restore automatically creates system checkpoints. You can also manually create your own checkpoints by creating *restore points*. To limit the amount of hard disk space used, older restore points will be automatically purged.

To resolve an operating system problem, you can use System Restore from Safe Mode or Normal Mode to return your computer to an earlier operating state.

System Restore does not cause you to lose personal files stored in the **My Documents** folder, data files, or e-mail messages after restoring the computer to an earlier time. If you restore the computer to an operating state that existed before you installed a program, the program's data files are not lost, but you must reinstall the actual program again.

 **NOTICE:** It is important to make regular backups of your data files. System Restore does not monitor changes to or recover your data files. If the original data on the hard disk is accidentally erased or overwritten, or if it becomes inaccessible because of a hard disk malfunction, use your backup files to recover the lost or damaged data.

System Restore is enabled on your new computer. However, if you reinstall Windows XP with less than 200 MB of free hard-disk space available, System Restore is automatically disabled. Before you use System Restore, confirm that it is enabled:

- 1 Click the **Start** button and click **Control Panel**.
- 2 Click the **Performance and Maintenance**.
- 3 Click **System**.
- 4 Click the **System Restore** tab.
- 5 Ensure that **Turn off System Restore** is not checked.

Creating a Restore Point

Using the System Restore Wizard

In Windows XP you can either use the System Restore Wizard or manually create the restore points. To use the System Restore Wizard, click the **Start** button, click **Help and Support**, click **System Restore**, and then follow the instructions on the **System Restore Wizard** window. You can also create and name a restore point if you are logged on as the computer administrator or a user with administrator rights.

Manually Creating the Restore Points

- 1 Click the **Start** button, point to **All Programs**→**Accessories**→**System Tools**, and then click **System Restore**.
- 2 Click **Create a restore point**.
- 3 Click **Next**.
- 4 Type a name for the new restore point in the **Restore point description** field.

The present date and time are automatically added to the description of the new restore point.

- 5 Click **Create**.
- 6 Click **OK**.

Restoring the Computer to an Earlier Operating State

If problems occur after installing a device driver, first try using Device Driver Rollback (see page 43). If Device Driver Rollback does not resolve the problem, then use System Restore.



NOTICE: Before restoring the computer to an earlier operating state, save and close all open files and exit all open programs. Do not alter, open, or delete any files or programs until the system restoration is complete.

- 1 Click the **Start** button, point to **All Programs**→**Accessories**→**System Tools**, and then click **System Restore**.
- 2 Ensure that **Restore my computer to an earlier time** is selected and click **Next**.

- 3 Click a calendar date to which you want to restore your computer.

The **Select a Restore Point** screen provides a calendar that allows you to see and select restore points. All calendar dates with available restore points appear in bold.

- 4 Select a restore point and click **Next**.

If a calendar date has only one restore point, then that restore point is automatically selected. If two or more restore points are available, click the restore point that you want to use.

➔ **NOTICE:** Save and close all open files and exit all open programs. Do not alter, open, or delete any files or programs until the system restoration is complete.

- 5 Click **Next**.

The **Restoration Complete** screen appears after System Restore finishes collecting data, and then the computer automatically restarts.

- 6 After the computer restarts, click **OK**.

To change the restore point, you can either repeat the steps using a different restore point, or you can undo the restoration.

Undoing the Last System Restore

➔ **NOTICE:** Save and close all open files and exit all open programs. Do not alter, open, or delete any files or programs until the system restoration is complete.

- 1 Click the **Start** button, point to **All Programs**→ **Accessories**→ **System Tools**, and then click **System Restore**.

- 2 Select **Undo my last restoration** and click **Next**.

➔ **NOTICE:** Save and close all open files and exit all open programs. Do not alter, open, or delete any files or programs until the system restoration is complete.

- 3 Click **Next**.

- 4 The **System Restore** screen appears, and then the computer automatically restarts.



- 5 After the computer restarts, click **OK**.



 **HINT:** The CD that you need to place in your CD drive is titled *Operating System*.

Reinstalling Windows® XP

Before reinstalling the Microsoft® Windows XP operating system to correct a problem, try correcting the problem by using Windows System Restore (see page 45).

 **NOTICE:** The *Operating System* CD provides options for reinstalling the Windows XP operating system. The options can potentially overwrite files installed by Dell and possibly affect programs installed on your hard drive. Therefore, Dell does not recommend that you reinstall your operating system unless instructed to do so by a Dell technical support representative.

- 1 Insert the *Operating System* CD.
- 2 Shut down the computer (see page 20), and then turn on the computer.
- 3 Press any key when the `Press any key to boot from CD` message appears on the screen.
- 4 When the **Windows XP Setup** screen appears, press  to select **To set up Windows now**.
- 5 Read the information in the **License Agreement** window, and then press  on your keyboard to agree with the license information.
- 6 If your computer already has Windows XP installed and you want to recover your current Windows XP data, type `r` to select the repair option, and then go to step 14.

If you want to install a new copy of Windows XP, press  to select the fresh copy option and then press  on the next screen to select the highlighted partition (recommended). Then follow the instructions on the screen.

The **Windows XP Setup** screen appears and Windows XP begins to copy files and install the device drivers. The computer automatically restarts multiple times before it requires additional input.

- 7 When the **Welcome to Microsoft** screen appears, click the green arrow icon at the bottom of the screen to continue. Then follow the instructions on the screen to finish the installation.
- 8 When the **Regional Settings** screen appears, select the settings for your locale, and then click **Next**.

- 9 Enter your name and organization in the **Personalize Your Software** screen, and then click **Next**.
- 10 *If you are reinstalling Windows XP Home Edition*, enter a name for your computer when the **Computer Name** window appears, and then click **Next**.

If you are reinstalling Windows XP Professional, enter a name for your computer and a password when the **Computer Name and Administrator Password** window appears, and then click **Next**.

- 11 If you have a modem installed, the **Modem Dialing Information** screen appears. Enter the requested information and click **Next**.
- 12 Enter the date, time, and time zone in the **Date and Time Settings** window and click **Next**.

Windows XP begins to install its components and configure the computer. The computer automatically restarts.

- 13 When the **Welcome to Microsoft** screen appears, click the green arrow icon at the bottom of the screen to continue. Then follow the instructions on the screen to complete the installation.
- 14 Remove the CD from the drive.
- 15 Reinstall the appropriate drivers (see page 41).
- 16 Reinstall your virus protection software.

Enabling Hibernate Mode

- 1 Click the **Start** button, point to **Settings**, and then click **Control Panel**.
- 2 Double-click the **Power Management** icon.
- 3 Click the **Hibernate** tab.
- 4 Ensure that **Enable hibernate support** is selected, and click **Apply**.
- 5 Click **OK** to close the Control Panel.

SECTION 3

Replacing Parts

Adding Memory

Replacing the Hard Drive

Removing a Battery

Installing a Battery

Replacing a Daughter Card Modem

 **HINT:** Memory modules purchased from Dell are covered under your computer warranty.

Adding Memory

You can increase your computer memory by installing memory modules on the system board. See "Specifications" on page 62 for information on the memory supported by your computer. Be sure to add only memory modules that are intended for your computer.

 **CAUTION:** Before working inside your computer, read the "Safety and Use Instructions" on page 7.

- 1 Save and close any open files, exit any open programs, and shut down the computer (see page 20).
- 2 Remove any installed PC Cards.
- 3 Remove the installed battery, and disconnect the AC adapter cable and any cables or external devices from the computer. Wait 5 seconds before proceeding.
- 4 Ground yourself by touching a metal connector on the back of the computer, and continue to do so periodically during this procedure.

 **NOTICE:** While you work, periodically touch unpainted metal on the computer to dissipate static electricity that might harm internal components.

- 5 Remove the screw labeled "circle M" from the memory module cover.
- 6 Slide the cover out and lift it away from the computer.

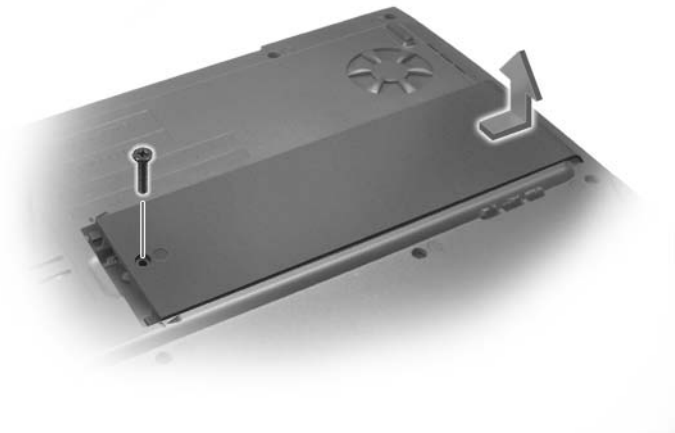

➔ **NOTICE:** To prevent damage to the memory module connector, do not use tools to spread the inner metal tabs that secure the memory module.

7 If you are replacing a memory module, remove the existing module.

➔ **NOTICE:** Handle memory modules by their edges, and do not touch the components on a module.

a Use your fingertips to carefully spread apart the securing clips on each end of the memory module connector.

The module should pop up.

b Remove the module from the connector.

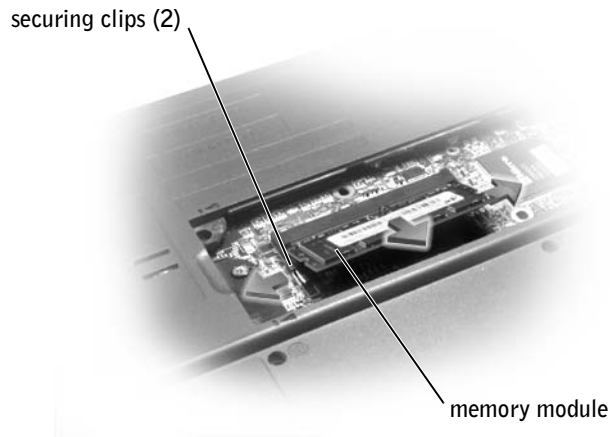

8 Ground yourself and install the new memory module:

a Align the notch in the module with the slot in the center of the connector.

b Slide the edge of the module firmly into the connector, and rotate the module down until you hear a click. If you do not hear the click, remove the module and reinstall it.

 **HINT:** If the memory module is not installed properly, the computer does not boot. No error message indicates this failure.

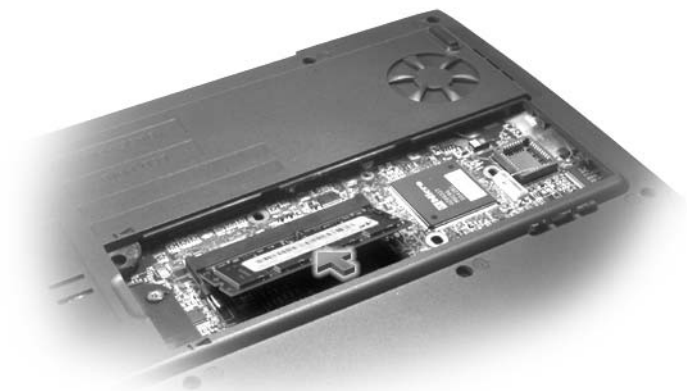

- 9 Replace the memory module cover:
 - a Place the memory module cover over the memory module compartment so that the end of the cover with the screw hole is lined up with the lines and arrows as shown in the following figure.
 - b Press down on the center of the memory module cover, and slide the memory module cover until it is secured.

➔ **NOTICE:** If the memory module cover is difficult to close, remove the module and reinstall it. Forcing the cover to close may damage your computer.





- 10 Replace and tighten the screw you removed in step 5.



- 11 Insert the battery into the battery bay, or connect the AC adapter to your computer and an electrical outlet.
- 12 Turn on the computer.

As the computer boots, it detects the additional memory and automatically updates the system configuration information.

Replacing the Hard Drive

-  **NOTICE:** To prevent data loss, turn off your computer (see page 20) before removing the hard drive. Do not remove the hard drive while the computer is on, in standby mode, or in hibernate mode.
-  **NOTICE:** Hard drives are extremely fragile; even a slight bump can damage the drive.
-  **CAUTION:** If you remove the hard drive from the computer when the drive is hot, *do not touch* the metal housing of the hard drive.
-  **CAUTION:** Before working inside your computer, read "Safety and Use Instructions" on page 7.

To replace the hard drive in the hard drive bay:

- 1 Make sure that the work surface is flat and clean to prevent scratching the computer cover.
- 2 Save and close any open files, exit any open programs, and shut down the computer (see page 20).
- 3 Disconnect the computer from the electrical outlet.
- 4 Wait 10 to 20 seconds and then disconnect any attached devices.
- 5 Remove any installed PC Cards, battery, and devices.
Handle components and cards by their edges, and avoid touching pins and contacts.
- 6 Ground yourself by touching a metal connector on the back of the computer, and continue to do so periodically during this procedure.

 **HINT:** Dell does not guarantee compatibility or provide support for hard drives from sources other than Dell.

HINT: You need the *Operating System* CD to install the Windows® operating system. You also need the *Drivers and Utilities* CD for your computer to install the drivers and utilities on the new hard drive.

7 Turn the computer over. Use a small screwdriver to remove the hard-drive screw, and place the screw in a safe location.

NOTICE: When the hard drive is not in the computer, store it in protective antistatic packaging. See "Protecting Against Electrostatic Discharge" on page 13.

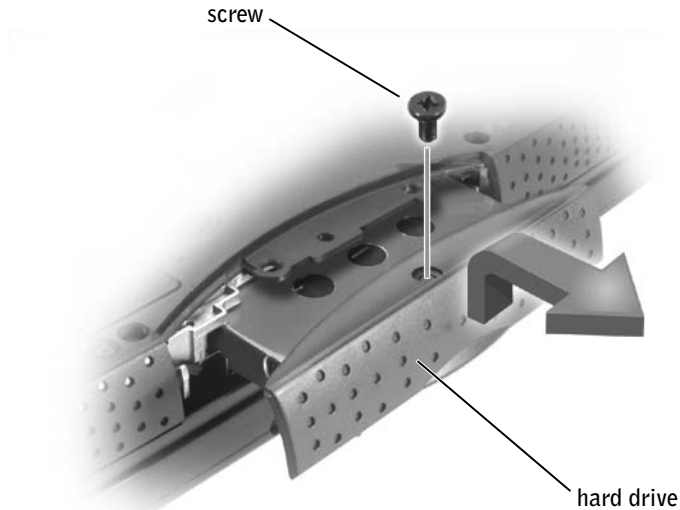

8 Lift up the hard-drive cover until you hear a click.

9 Slide the hard drive out of the computer.

10 Remove the new drive from its packaging.

Save the original packaging to use when storing or shipping the hard drive.

NOTICE: Use firm and even pressure to slide the drive into place. If you force the hard drive into place using excessive force, you may damage the connector.

11 Slide the drive into the bay until it is fully seated in the bay. Press the hard-drive cover down until you hear a click.

12 Replace and tighten the screw you removed in step 7.

13 Use the *Operating System* CD to install the operating system for your computer (see page 48).

- 14 Use the *Drivers and Utilities* CD to install the drivers and utilities for your computer (see page 41).

Returning a Hard Drive to Dell

Return your old hard drive to Dell in its original or comparable foam packaging. Otherwise, the hard drive may be damaged in transit.

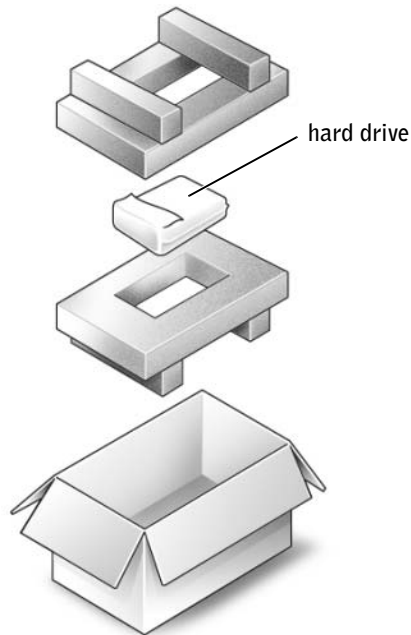

Removing a Battery

Before removing the battery, ensure that the computer is turned off or disconnected from an electrical outlet.

- 1 Unlock the battery as shown in the following graphic.
- 2 Slide and hold the battery latch all the way up until the left edge of the battery pops up.
- 3 Remove the battery.

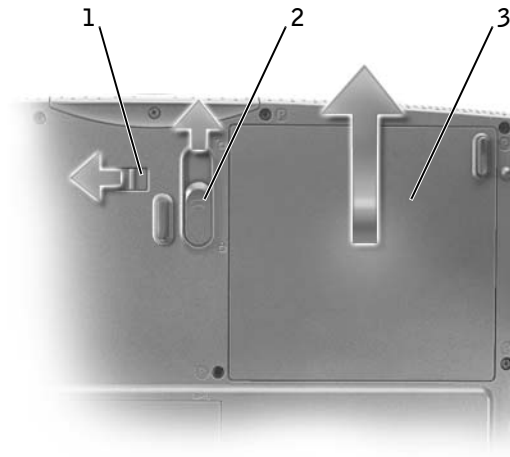

Installing a Battery

- 1 Ensure that the battery lock is in the unlocked position.
- 2 Slide the battery into the battery bay until the latch clicks.
- 3 Lock the battery.

Replacing a Daughter Card Modem

- 1 Make sure that the work surface is flat and clean to prevent scratching the computer cover.
- 2 Save and close any open files, exit any open programs, and shut down the computer (see page 20).
- 3 Disconnect the computer from the electrical outlet.
- 4 Wait 10 to 20 seconds and then disconnect any attached devices.
- 5 Remove any installed PC Cards, battery, and devices.
- 6 To ground yourself, periodically touch an unpainted metal surface on the back of the computer while you work.
- 7 Handle components and cards by their edges, and avoid touching pins and contacts.

- 8 Turn the computer over, and remove the screws from the modem cover.
- 9 Place your finger under the cover at the indentation and lift and slide the cover open.
- 10 Remove the existing modem:
 - a Remove the screws securing the modem to the system board, and set them aside.
 - b Pull straight up on the attached pull tab to lift the modem out of its connector on the system board and disconnect the modem cable.

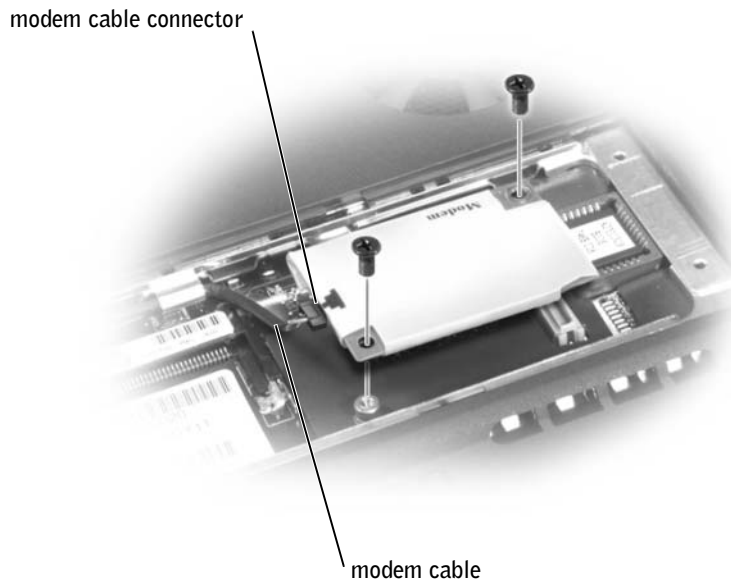

- 11 Connect the modem cable to the modem.
- ➔ **NOTICE:** The cable connectors are keyed for correct insertion; do not force the connections.
- 12 Align the modem with the screw holes and press the modem into the connector on the system board.

- 13** Install the screws to secure the modem to the system board.
- 14** Replace the modem cover.

SECTION 4

Appendix

Specifications

Standard Settings

Returning Items for Warranty Repair or Credit

Contacting Dell

Regulatory Notices

Specifications

Microprocessor

Microprocessor types	Mobile Intel® Celeron™ processor
L1 cache	32 KB (internal)
L2 cache	128 KB
External bus frequency	133 MHz

System Information

System chip set	Intel 830MG
Data bus width	64 bits
DRAM bus width	64 bits
Microprocessor address bus width	32 bits

PC Card

CardBus controller	O2 Micro OZ6912
PC Card connector	supports one Type II card
Cards supported	3.3 V and 5 V
PC Card connector size	68 pins
Data width (maximum)	PCMCIA 16 bits CardBus 32 bits

Memory

Architecture	PC133 SDRAM
Memory module socket	one user-accessible SODIMM sockets
Memory module capacities	128, 192, 256, 384, and 512 MB
Memory type	3.3-V SODIMM
Standard memory	128 MB
Maximum memory	512 MB
Memory access time: clock speed	133 MHz

Ports and Connectors

Parallel	25-hole connector; unidirectional, bidirectional, or ECP
Video	15-hole connector
Audio	microphone connector, stereo headphone/speakers connector
PS/2 keyboard/mouse	6-pin mini-DIN connector
USB (2)	4-pin USB-compliant connector
Modem	RJ-11 connector

Communications

Modem:	
Type	v.92 56K MDC
Controller	softmodem
Interface	internal AC 97 bus

Video

Video type	Intel integrated video graphics
Data bus	UMA
Video controller	Intel 830 MG
Video memory	UMA, shared with system memory
LCD interface	SPWG

Audio

Audio type	AC97 (Soft Audio)
Audio controller	Sigmatel 9700
Stereo conversion	18-bit (analog-to-digital and digital-to-analog)
Interfaces:	
Internal	PCI bus /AC 97

Audio *(continued)*

External	microphone-in connector, stereo headphones/speakers connector
Speaker	two 4-ohm speakers
Internal speaker amplifier	1.0-W channel into 4 ohms
Volume controls	keyboard shortcuts, program menus

Display

Type (active-matrix TFT)	XGA
Dimensions:	14.1 inch
Height	215.8 mm (8.5 inches)
Width	287.1 mm (11.3 inches)
Diagonal	359.16 mm (14.1 inches)
Maximum resolutions	1024 x 768 at 16.8 million colors
Response time (typical)	20-ms rise (maximum), 30-ms fall (maximum)
Operating angle	0° (closed) to 180°
Viewing angles:	
Horizontal	±40°
Vertical	+10°/-30°
Pixel pitch	0.28 x 0.28 mm
Power consumption:	
Panel with backlight (typical)	6.5 W
Controls	brightness can be controlled through keyboard shortcuts

Keyboard

Number of keys	85
Key travel	2.7 mm ± 0.3 (0.11 inch ± 0.016 inch)
Key spacing	19.05 mm ± 0.3 mm (0.75 inch ± 0.012 inch)
Layout	QWERTY

Touch Pad

X/Y position resolution (graphics table mode)	240 cpi
Size:	
Width	64.88 mm (2.55-inch) sensor-active area
Height	48.88-mm (1.92-inch) rectangle

Battery

Type	"smart" lithium ion
Dimensions:	
Depth	88.5 mm (3.48 inches)
Height	21.5 mm (0.83 inch)
Width	139.0 mm (5.47 inches)
Weight	0.40 kg (0.88 lb)
Voltage	14.8 VDC
Charge time (approximate):	
Computer on	3 hours
Computer off	2 hours
Operating life	approximately 2 to 4 hours
Life span (approximate)	400 discharge/charge cycles
Temperature range:	
Operating	0° to 35°C (32° to 95°F)
Storage	-40° to 65°C (-40° to 149°F)

AC Adapter

Input voltage	90 to 264 VAC
Input current (maximum)	1.7 A
Input frequency	47 to 63 Hz
Output current	4.5 A (maximum at 4-second pulse); 3.5 A (continuous)
Output power	70 W
Rated output voltage	20 VDC
Dimensions:	
Height	27.94 mm (1.1 inches)
Width	58.42 mm (2.3 inches)
Depth	133.85 mm (5.25 inches)
Weight (with cables)	0.4 kg (0.9 lb)
Temperature range:	
Operating	0° to 35°C (32° to 95°F)
Storage	-40° to 65°C (-40° to 149°F)

Physical

Height	328 mm (12.9 inches)
Width	274 mm (10.8 inches)
Depth	37 mm (1.45 inches)
Weight:	
With CD drive and 8-cell battery	3276.3 g (7.2 lb)

Environmental

Temperature range:

Operating	0° to 35°C (32° to 95°F)
Storage	-40° to 65°C (-40° to 149°F)

Relative humidity (maximum):

Operating	10% to 90% (noncondensing)
Storage	5% to 95% (noncondensing)

Maximum vibration:

Operating	0.9 GRMS
Storage	1.3 GRMS

Maximum shock: (measured with the hard drive in head-parked position and 2-ms half-sine pulse):

Operating	122 G
Storage	163 G

Altitude (maximum):

Operating	-15.2 to 3048 m (-50 to 10,000 ft)
Storage	-15.2 to 10,668 m (-50 to 35,000 ft)

Standard Settings

The system setup program contains the standard settings for your computer.





NOTICE: Unless you are an expert computer user or are directed to do so by Dell technical support, do not change the settings for this program. Certain changes might make your computer work incorrectly.

Viewing the System Setup Screens

- 1 Turn on (or restart) your computer.
- 2 When the Dell™ logo appears, press  immediately.

If you wait too long and the Windows® logo appears, continue to wait until you see the Windows desktop. Then shut down your computer (see page 20) and try again.

Depending on your computer, you may also be able to enter the system setup program by pressing   at any time while the computer is running.

System Setup Screens

The system setup screens display the current setup information and settings for your computer. Each screen is laid out with the system setup options listed at the left. To the right of each option is a field that displays the setting or value for that option. You can change settings that appear as white type on the screen. Options or values that you cannot change (because they are determined by the computer) appear less bright.

A box in the upper-right corner of the screen displays help information for the currently highlighted option; a box in the lower-right corner displays information about the computer. System setup key functions are listed across the bottom of the screen.

The screens display such information as:

- System configuration
- Boot (start-up) configuration and docking device configuration settings
- Basic device configuration settings
- Battery charge status
- Power management settings
- System security and hard-drive password settings

 **HINT:** To see information about a specific item on a system setup screen, highlight the item and refer to the **Help** area on the screen.

Boot Sequence Option	Description
Boot First Device	Tells the computer where to look first for the software it needs to start the operating system
Boot Second Device	Tells the computer where to look next if it cannot find the software on the drive identified in Boot First Device
Boot Third Device	Tells the computer where to look next if it cannot find the software on the drives identified in Boot First Device or Boot Second Device

Returning Items for Warranty Repair or Credit

Prepare all items being returned, whether for repair or credit, as follows:

- 1** Call Dell to obtain an authorization number, and write it clearly and prominently on the outside of the box.
For the telephone number to call, see "Contacting Dell" on page 70.
- 2** Include a copy of the invoice and a letter describing the reason for the return.
- 3** Include any accessories that belong with the item(s) being returned (power cables, software floppy disks, guides, and so on) if the return is for credit.
- 4** Pack the equipment to be returned in the original (or equivalent) packing materials.

You are responsible for paying shipping expenses. You are also responsible for insuring any product returned, and you assume the risk of loss during shipment to Dell. Collect On Delivery (C.O.D.) packages are not accepted.

Returns that are missing any of the preceding requirements will be refused at Dell's receiving dock and returned to you.

Contacting Dell

 **HINT:** Toll-free numbers are for use within the country for which they are listed.

When you need to contact Dell, use the telephone numbers, codes, and electronic addresses provided in the following table. If you need assistance in determining which codes to use, contact a local or an international operator.

Country (City) International Access Code Country Code City Code	Department Name or Service Area, Website and E-Mail Address	Area Codes, Local Numbers, and Toll-Free Numbers
Antigua and Barbuda	General Support	1-800-805-5924
Argentina (Buenos Aires)	Tech Support and Customer Care	toll-free: 0-800-444-0733
International Access Code: 00	Sales	1-810-444-3355
Country Code: 54	Tech Support Fax	11 4515 7139
City Code: 11	Customer Care Fax	11 4515 7138
	Website: www.dell.com.ar	
Australia (Sydney)	Home and Small Business	1-300-65-55-33
International Access Code: 0011	Government and Business	toll-free: 1-800-633-559
Country Code: 61	Preferred Accounts Division (PAD)	toll-free: 1-800-060-889
City Code: 2	Customer Care	toll-free: 1-800-819-339
	Corporate Sales	toll-free: 1-800-808-385
	Transaction Sales	toll-free: 1-800-808-312
	Fax	toll-free: 1-800-818-341
Austria (Vienna)	Home/Small Business Sales	01 795 67602
International Access Code: 900	Home/Small Business Fax	01 795 67605
Country Code: 43	Home/Small Business Customer Care	01 795 67603
City Code: 1	Preferred Accounts/Corporate Customer Care	0660 8056
	Home/Small Business Technical Support	01 795 67604
	Preferred Accounts/Corporate Technical Support	0660 8779
	Switchboard	01 491 04 0
	Website: support.euro.dell.com	
	E-mail: tech_support_central_europe@dell.com	
Barbados	General Support	1-800-534-3066

Country (City) International Access Code Country Code City Code	Department Name or Service Area, Website and E-Mail Address	Area Codes, Local Numbers, and Toll-Free Numbers
Belgium (Brussels)	Technical Support	02 481 92 88
International Access Code: 00	Customer Care	02 481 91 19
Country Code: 32	Home/Small Business Sales	toll-free: 0800 16884
City Code: 2	Corporate Sales	02 481 91 00
	Fax	02 481 92 99
	Switchboard	02 481 91 00
	Website: support.euro.dell.com	
	E-mail: tech_be@dell.com	
	E-mail for French Speaking Customers: support.euro.dell.com/be/fr/emaildell/	
Bermuda	General Support	1-800-342-0671
Brazil	Customer Support, Technical Support	0800 90 3355
International Access Code: 00	Tech Support Fax	51 481 5470
Country Code: 55	Customer Care Fax	51 481 5480
City Code: 51	Sales	0800 90 3390
	Website: www.dell.com/br	
Brunei	Customer Technical Support (Penang, Malaysia)	604 633 4966
Country Code: 673	Customer Service (Penang, Malaysia)	604 633 4949
	Transaction Sales (Penang, Malaysia)	604 633 4955
Canada (North York, Ontario)	Automated Order-Status System	toll-free: 1-800-433-9014
International Access Code: 011	AutoTech (Automated technical support)	toll-free: 1-800-247-9362
	Customer Care (From outside Toronto)	toll-free: 1-800-387-5759
	Customer Care (From within Toronto)	416 758-2400
	Customer Technical Support	toll-free: 1-800-847-4096
	Sales (Direct sales—from outside Toronto)	toll-free: 1-800-387-5752
	Sales (Direct sales—from within Toronto)	416 758-2200
	Sales (Federal government, education, and medical)	toll-free: 1-800-567-7542
	Sales (Major accounts)	toll-free: 1-800-387-5755
	TechFax	toll-free: 1-800-950-1329
Cayman Islands	General Support	1-800-805-7541

Country (City) International Access Code Country Code City Code	Department Name or Service Area, Website and E-Mail Address	Area Codes, Local Numbers, and Toll-Free Numbers
Chile (Santiago) Country Code: 56 City Code: 2	Sales, Customer Support, and Technical Support	toll-free: 1230-020-4823
China (Xiamen) Country Code: 86 City Code: 592	Home and Small Business Technical Support Corporate Accounts Technical Support Customer Experience Home and Small Business Preferred Accounts Division Large Corporate Accounts North Large Corporate Accounts East Large Corporate Accounts South Large Corporate Accounts GCP Large Corporate Accounts HK Large Corporate Accounts GCP HK	toll-free: 800 858 2437 toll-free: 800 858 2333 toll-free: 800 858 2060 toll-free: 800 858 2222 toll-free: 800 858 2062 toll-free: 800 858 2999 toll-free: 800 858 2020 toll-free: 800 858 2355 toll-free: 800 858 2055 toll-free: 800 964108 toll-free: 800 907308
Colombia	General Support	980-9-15-3978
Costa Rica	General Support	0800-012-0435
Czech Republic (Prague) International Access Code: 00 Country Code: 420 City Code: 2	Technical Support Customer Care Fax TechFax Switchboard Website: support.euro.dell.com E-mail: czech_dell@dell.com	02 22 83 27 27 02 22 83 27 11 02 22 83 27 14 02 22 83 27 28 02 22 83 27 11

Country (City) International Access Code Country Code City Code	Department Name or Service Area, Website and E-Mail Address	Area Codes, Local Numbers, and Toll-Free Numbers
Denmark (Copenhagen)	Technical Support	7023 0182
International Access Code: 00	Customer Care (Relational)	7023 0184
Country Code: 45	Home/Small Business Customer Care	3287 5505
	Switchboard (Relational)	3287 1200
	Fax Switchboard (Relational)	3287 1201
	Switchboard (Home/Small Business)	3287 5000
	Fax Switchboard (Home/Small Business)	3287 5001
	Website: support.euro.dell.com	
	E-mail Support (Portable Computers): den_nbk_support@dell.com	
	E-mail Support (Desktop Computers): den_support@dell.com	
	E-mail Support (Servers): Nordic_server_support@dell.com	
Dominican Republic	General Support	1-800-148-0530
El Salvador	General Support	01-899-753-0777
Finland (Helsinki)	Technical Support	09 253 313 60
International Access Code: 990	Technical Support Fax	09 253 313 81
Country Code: 358	Relational Customer Care	09 253 313 38
City Code: 9	Home/Small Business Customer Care	09 693 791 94
	Fax	09 253 313 99
	Switchboard	09 253 313 00
	Website: support.euro.dell.com	
	E-mail: fin_support@dell.com	
	E-mail Support (Servers): Nordic_support@dell.com	

Country (City) International Access Code Country Code City Code	Department Name or Service Area, Website and E-Mail Address	Area Codes, Local Numbers, and Toll-Free Numbers
France (Paris) (Montpellier) International Access Code: 00 Country Code: 33 City Codes: (1) (4)	Home and Small Business	
	Technical Support	0825 387 270
	Customer Care	0825 823 833
	Switchboard	0825 004 700
	Switchboard (Calls from outside of France)	04 99 75 40 00
	Sales	0825 004 700
	Fax	0825 004 701
	Fax (Calls from outside of France)	04 99 75 40 01
	Website: support.euro.dell.com	
	E-mail: support.euro.dell.com/fr/fr/emaildell/	
	Corporate	
	Technical Support	0825 004 719
	Customer Care	0825 338 339
	Switchboard	01 55 94 71 00
Sales	01 55 94 71 00	
Fax	01 55 94 71 01	
Website: support.euro.dell.com		
E-mail: support.euro.dell.com/fr/fr/emaildell/		
Germany (Langen) International Access Code: 00 Country Code: 49 City Code: 6103	Technical Support	06103 766-7200
	Home/Small Business Customer Care	0180-5-224400
	Global Segment Customer Care	06103 766-9570
	Preferred Accounts Customer Care	06103 766-9420
	Large Accounts Customer Care	06103 766-9560
	Public Accounts Customer Care	06103 766-9555
	Switchboard	06103 766-7000
	Website: support.euro.dell.com	
E-mail: tech_support_central_europe@dell.com		
Guatemala	General Support	1-800-999-0136

Country (City) International Access Code Country Code City Code	Department Name or Service Area, Website and E-Mail Address	Area Codes, Local Numbers, and Toll-Free Numbers
Hong Kong	Technical Support	toll-free: 800 96 4107
International Access Code: 001	Customer Service (Penang, Malaysia)	604 633 4949
Country Code: 852	Transaction Sales	toll-free: 800 96 4109
	Corporate Sales	toll-free: 800 96 4108
India	Technical Support	1600 33 8045
	Sales	1600 33 8044
Ireland (Cherrywood)	Ireland Technical Support	1850 543 543
International Access Code: 16	UK Technical Support (dial number within UK only)	0870 908 0800
Country Code: 353	Home User Customer Care	01 204 4095
City Code: 1	Small Business Customer Care	01 204 4444
	UK Customer Care (dial number within UK only)	0870 906 0010
	Corporate Customer Care	01 204 4003
	Ireland Sales	01 204 4444
	UK Sales (dial number within UK only)	0870 907 4000
	SalesFax	01 204 0144
	Fax	01 204 5960
	Switchboard	01 204 4444
	Website: support.euro.dell.com	
	E-mail: dell_direct_support@dell.com	

Country (City) International Access Code Country Code City Code	Department Name or Service Area, Website and E-Mail Address	Area Codes, Local Numbers, and Toll-Free Numbers
Italy (Milan) International Access Code: 00 Country Code: 39 City Code: 02	Home and Small Business	
	Technical Support	02 577 826 90
	Customer Care	02 696 821 14
	Fax	02 696 821 13
	Switchboard	02 696 821 12
	Website: support.euro.dell.com	
	E-mail: support.euro.dell.com/it/it/zdell/	
	Corporate	
	Technical Support	02 577 826 90
	Customer Care	02 577 825 55
Fax	02 575 035 30	
Switchboard	02 577 821	
Website: support.euro.dell.com		
E-mail: support.euro.dell.com/it/it/emaildell/		
Jamaica	General Support	1-800-682-3639

Country (City) International Access Code Country Code City Code	Department Name or Service Area, Website and E-Mail Address	Area Codes, Local Numbers, and Toll-Free Numbers
Japan (Kawasaki) International Access Code: 001 Country Code: 81 City Code: 44	Technical Support (Server)	toll-free: 0120-1984-35
	Technical Support Outside of Japan (Server)	81-44-556-4152
	Technical Support (Dimension™ and Inspiron™)	toll-free: 0120-1982-26
	Technical Support Outside of Japan (Dimension and Inspiron)	81-44-520-1435
	Technical Support (Dell Precision™, OptiPlex™, and Latitude™)	toll-free: 0120-1984-33
	Technical Support Outside of Japan (Dell Precision, OptiPlex, and Latitude)	81-44-556-3894
	24-Hour Automated Order Service	044 556-3801
	Customer Care	044 556-4240
	Business Sales Division (Up to 400 employees)	044 556-3494
	Preferred Accounts Division Sales (Over 400 employees)	044 556-3433
	Large Corporate Accounts Sales (Over 3500 employees)	044 556-3440
	Public Sales (Government agencies, educational institutions, and medical institutions)	044 556-3440
	Global Segment Japan	044 556-3469
	Individual User	044 556-1657
Faxbox Service	044 556-3490	
Switchboard	044 556-4300	
Website: support.jp.dell.com		
Korea (Seoul) International Access Code: 001 Country Code: 82 City Code: 2	Technical Support	toll-free: 080-200-3800
	Sales	toll-free: 080-200-3600
	Customer Service (Seoul, Korea)	toll-free: 080-200-3800
	Customer Service (Penang, Malaysia)	604 633 4949
	Fax	2194-6202
Switchboard	2194-6000	

Country (City) International Access Code Country Code City Code	Department Name or Service Area, Website and E-Mail Address	Area Codes, Local Numbers, and Toll-Free Numbers
Latin America	Customer Technical Support (Austin, Texas, U.S.A.)	512 728-4093
	Customer Service (Austin, Texas, U.S.A.)	512 728-3619
	Fax (Technical Support and Customer Service) (Austin, Texas, U.S.A.)	512 728-3883
	Sales (Austin, Texas, U.S.A.)	512 728-4397
	SalesFax (Austin, Texas, U.S.A.)	512 728-4600 or 512 728-3772
Luxembourg International Access Code: 00 Country Code: 352	Technical Support (Brussels, Belgium)	02 481 92 88
	Home/Small Business Sales (Brussels, Belgium)	toll-free: 080016884
	Corporate Sales (Brussels, Belgium)	02 481 91 00
	Customer Care (Brussels, Belgium)	02 481 91 19
	Fax (Brussels, Belgium)	02 481 92 99
	Switchboard (Brussels, Belgium)	02 481 91 00
	Website: support.euro.dell.com E-mail: tech_be@dell.com	
Macau Country Code: 853	Technical Support	toll-free: 0800 582
	Customer Service (Penang, Malaysia)	604 633 4949
	Transaction Sales	toll-free: 0800 581
Malaysia (Penang) International Access Code: 00 Country Code: 60 City Code: 4	Technical Support	toll-free: 1 800 888 298
	Customer Service	04 633 4949
	Transaction Sales	toll-free: 1 800 888 202
	Corporate Sales	toll-free: 1 800 888 213

Country (City) International Access Code Country Code City Code	Department Name or Service Area, Website and E-Mail Address	Area Codes, Local Numbers, and Toll-Free Numbers
Mexico International Access Code: 00 Country Code: 52	Customer Technical Support Sales Customer Service Main	001-877-384-8979 or 001-877-269-3383 50-81-8800 or 01-800-888-3355 001-877-384-8979 or 001-877-269-3383 50-81-8800 or 01-800-888-3355
Netherlands Antilles	General Support	001-800-882-1519
Netherlands (Amsterdam) International Access Code: 00 Country Code: 31 City Code: 20	Technical Support Customer Care Home/Small Business Sales Home/Small Business Sales Fax Corporate Sales Corporate Sales Fax Fax Switchboard Website: support.euro.dell.com E-mail: tech_nl@dell.com	020 581 8838 020 581 8740 toll-free: 0800-0663 020 682 7171 020 581 8818 020 686 8003 020 686 8003 020 581 8818
New Zealand International Access Code: 00 Country Code: 64	Home and Small Business Government and Business Sales Fax	0800 446 255 0800 444 617 0800 441 567 0800 441 566
Nicaragua	General Support	001-800-220-1006

Country (City) International Access Code Country Code City Code	Department Name or Service Area, Website and E-Mail Address	Area Codes, Local Numbers, and Toll-Free Numbers
Norway (Lysaker)	Technical Support	671 16882
International Access Code: 00	Relational Customer Care	671 17514
Country Code: 47	Home/Small Business Customer Care	23162298
	Switchboard	671 16800
	Fax Switchboard	671 16865
	Website: support.euro.dell.com	
	E-mail Support (Portable Computers): nor_nbk_support@dell.com	
	E-mail Support (Desktop Computers): nor_support@dell.com	
	E-mail Support (Servers): Nordic_server_support@dell.com	
Panama	General Support	001-800-507-0962
Peru	General Support	0800-50-669
Poland (Warsaw)	Customer Service Phone	57 95 700
International Access Code: 011	Customer Care	57 95 999
Country Code: 48	Sales	57 95 999
City Code: 22	Customer Service Fax	57 95 806
	Reception Desk Fax	57 95 998
	Switchboard	57 95 999
	Website: support.euro.dell.com	
	E-mail: pl_support@dell.com	
Portugal	Technical Support	800 834 077
International Access Code: 00	Customer Care	800 300 415 or 800 834 075
Country Code: 35	Sales	800 300 410 or 800 300 411 or 800 300 412 or 121 422 07 10
	Fax	121 424 01 12
	E-mail: support.euro.dell.com/es/es/emaildell/	
Puerto Rico	General Support	1-800-805-7545

Country (City) International Access Code Country Code City Code	Department Name or Service Area, Website and E-Mail Address	Area Codes, Local Numbers, and Toll-Free Numbers
St. Lucia	General Support	1-800-882-1521
Singapore (Singapore)	Technical Support	toll-free: 800 6011 051
International Access Code: 005	Customer Service (Penang, Malaysia)	604 633 4949
Country Code: 65	Transaction Sales	toll-free: 800 6011 054
	Corporate Sales	toll-free: 800 6011 053
South Africa (Johannesburg)	Technical Support	011 709 7710
International Access Code: 09/091	Customer Care	011 709 7707
	Sales	011 709 7700
Country Code: 27	Fax	011 706 0495
City Code: 11	Switchboard	011 709 7700
	Website: support.euro.dell.com	
	E-mail: dell_za_support@dell.com	
Southeast Asian and Pacific Countries	Customer Technical Support, Customer Service, and Sales (Penang, Malaysia)	604 633 4810
Spain (Madrid)	Home and Small Business	
International Access Code: 00	Technical Support	902 100 130
Country Code: 34	Customer Care	902 118 540
City Code: 91	Sales	902 118 541
	Switchboard	902 118 541
	Fax	902 118 539
	Website: support.euro.dell.com	
	E-mail: support.euro.dell.com/es/es/emaildell/	
	Corporate	
	Technical Support	902 100 130
	Customer Care	902 118 546
	Switchboard	91 722 92 00
	Fax	91 722 95 83
	Website: support.euro.dell.com	
	E-mail: support.euro.dell.com/es/es/emaildell/	

Country (City) International Access Code Country Code City Code	Department Name or Service Area, Website and E-Mail Address	Area Codes, Local Numbers, and Toll-Free Numbers
Sweden (Upplands Vasby)	Technical Support	08 590 05 199
International Access Code: 00	Relational Customer Care	08 590 05 642
Country Code: 46	Home/Small Business Customer Care	08 587 70 527
City Code: 8	Fax Technical Support	08 590 05 594
	Sales	08 590 05 185
	Website: support.euro.dell.com	
	E-mail: swe_support@dell.com	
	E-mail Support for Latitude and Inspiron: Swe-nbk_kats@dell.com	
	E-mail Support for OptiPlex: Swe_kats@dell.com	
	E-mail Support for Servers: Nordic_server_support@dell.com	
Switzerland (Geneva)	Technical Support (Home and Small Business)	0844 811 411
International Access Code: 00	Technical Support (Corporate)	0844 822 844
Country Code: 41	Customer Care (Home and Small Business)	0848 802 202
City Code: 22	Customer Care (Corporate)	0848 821 721
	Fax	022 799 01 90
	Switchboard	022 799 01 01
	Website: support.euro.dell.com	
	E-mail: swisstech@dell.com	
	E-mail for French Speaking HSB and Corporate Customers: support.euro.dell.com/ch/fr/emaildell/	
Taiwan	Technical Support	toll-free: 0080 60 1255
International Access Code: 002	Technical Support (Servers)	toll-free: 0080 60 1256
Country Code: 886	Transaction Sales	toll-free: 0080 651 228 or 0800 33 556
	Corporate Sales	toll-free: 0080 651 227 or 0800 33 555
Thailand	Technical Support	toll-free: 0880 060 07
International Access Code: 001	Customer Service (Penang, Malaysia)	604 633 4949
Country Code: 66	Sales	toll-free: 0880 060 09

Country (City) International Access Code Country Code City Code	Department Name or Service Area, Website and E-Mail Address	Area Codes, Local Numbers, and Toll-Free Numbers
Trinidad/Tobago	General Support	1-800-805-8035
U.K. (Bracknell) International Access Code: 00 Country Code: 44 City Code: 1344	Technical Support (Corporate/Preferred Accounts/PAD [1000+ employees]) Technical Support (Direct/PAD and general) Global Accounts Customer Care Home and Small Business Customer Care Corporate Customer Care Preferred Accounts (500–5000 employees) Customer Care Central Government Customer Care Local Government & Education Customer Care Health Customer Care Home and Small Business Sales Corporate/Public Sector Sales Website: support.euro.dell.com Customer Care Website: dell.co.uk/lca/customerservices E-mail: dell_direct_support@dell.com	0870 908 0500 0870 908 0800 01344 373 185 or 01344 373 186 0870 906 0010 0870 908 0500 01344 373 196 01344 373 193 01344 373 199 01344 373 194 0870 907 4000 01344 860 456

Country (City) International Access Code Country Code City Code	Department Name or Service Area, Website and E-Mail Address	Area Codes, Local Numbers, and Toll-Free Numbers
U.S.A. (Austin, Texas)	Automated Order-Status System	toll-free: 1-800-433-9014
International Access Code: 011	AutoTech (For portable and desktop computers)	toll-free: 1-800-247-9362
Country Code: 1	Dell Home and Small Business Group (For portable and desktop computers):	
	Customer Technical Support (Return Material Authorization Numbers)	toll-free: 1-800-624-9896
	Customer Technical Support (Home sales purchased via www.dell.com)	toll-free: 1-877-576-3355
	Customer Service (Credit Return Authorization Numbers)	toll-free: 1-800-624-9897
	National Accounts (Computers purchased by established Dell national accounts [have your account number handy] or value-added resellers [VARs]):	
	Customer Service and Technical Support (Return Material Authorization Numbers)	toll-free: 1-800-822-8965
	Public Americas (Computers purchased by governmental agencies [local, state, or federal], medical institutions, or educational institutions):	
	Customer Service and Technical Support (Return Material Authorization Numbers)	toll-free: 1-800-234-1490
	Dell Sales	toll-free: 1-800-289-3355 or toll-free: 1-800-879-3355
	Spare Parts Sales	toll-free: 1-800-357-3355
	Desktop and Portable Fee-Based Technical Support	toll-free: 1-800-433-9005
	Sales (Catalogs)	toll-free: 1-800-426-5150
	Fax	toll-free: 1-800-727-8320
	TechFax	toll-free: 1-800-950-1329
	Dell Services for the Deaf, Hard-of-Hearing, or Speech-Impaired	toll-free: 1-877-DELLTY (1-877-335-5889)
	Switchboard	512 338-4400
	DellNet™ Technical Support	toll-free: 1-877-Dellnet (1-877-335-5638)
US Virgin Islands	General Support	1-877-673-3355
Venezuela	General Support	8001-3605

Regulatory Notices

Electromagnetic Interference (EMI) is any signal or emission, radiated in free space or conducted along power or signal leads, that endangers the functioning of a radio navigation or other safety service or seriously degrades, obstructs, or repeatedly interrupts a licensed radio communications service. Radio communications services include but are not limited to AM/FM commercial broadcast, television, cellular services, radar, air-traffic control, pager, and Personal Communication Services (PCS). These licensed services, along with unintentional radiators such as digital devices, including computers, contribute to the electromagnetic environment.

Electromagnetic Compatibility (EMC) is the ability of items of electronic equipment to function properly together in the electronic environment. While this computer has been designed and determined to be compliant with regulatory agency limits for EMI, there is no guarantee that interference will not occur in a particular installation. If this equipment does cause interference with radio communications services, which can be determined by turning the equipment off and on, you are encouraged to try to correct the interference by one or more of the following measures:

- Reorient the receiving antenna.
- Relocate the computer with respect to the receiver.
- Move the computer away from the receiver.
- Plug the computer into a different outlet so that the computer and the receiver are on different branch circuits.

If necessary, consult a Dell Technical Support representative or an experienced radio/television technician for additional suggestions.

Dell computers are designed, tested, and classified for their intended electromagnetic environment. These electromagnetic environment classifications generally refer to the following harmonized definitions:

- Class A is typically for business or industrial environments.
- Class B is typically for residential environments.

Information Technology Equipment (ITE), including devices, expansion cards, printers, input/output (I/O) devices, monitors, and so on, that are integrated into or connected to the computer should match the electromagnetic environment classification of the computer.

A Notice About Shielded Signal Cables: Use only shielded cables for connecting devices to any Dell device to reduce the possibility of interference with radio communications services. Using shielded cables ensures that you maintain the appropriate EMC classification for the intended environment. For parallel printers, a cable is available from Dell. If you prefer, you can order a cable from Dell on the World Wide Web at accessories.us.dell.com/sna/category.asp?category_id=4117.

Most Dell computers are classified for Class B environments. However, the inclusion of certain options can change the rating of some configurations to Class A. To determine the electromagnetic classification for your computer or device, refer to the following sections specific for each regulatory agency. Each section provides country-specific EMC/EMI or product safety information.

CE Notice (European Union)

Marking by the symbol **CE** indicates compliance of this Dell computer to the EMC Directive and the Low Voltage Directive of the European Union. Such marking is indicative that this Dell system meets the following technical standards:

- EN 55022 — “Information Technology Equipment — Radio Disturbance Characteristics — Limits and Methods of Measurement.”
- EN 55024 — “Information technology equipment - Immunity characteristics - Limits and Methods of Measurement.”
- EN 61000-3-2 — “Electromagnetic compatibility (EMC) - Part 3: Limits - Section 2: Limits for harmonic current emissions (Equipment input current up to and including 16 A per phase).”
- EN 61000-3-3 — “Electromagnetic compatibility (EMC) - Part 3: Limits - Section 3: Limitation of voltage fluctuations and flicker in low-voltage supply systems for equipment with rated current up to and including 16 A.”
- EN 60950 — “Safety of Information Technology Equipment.”

NOTE: EN 55022 emissions requirements provide for two classifications:

- Class A is for typical commercial areas.
- Class B is for typical domestic areas.

This Dell device is classified for use in a typical Class B domestic environment.

A "Declaration of Conformity" in accordance with the preceding directives and standards has been made and is on file at Dell Computer Corporation Products Europe BV, Limerick, Ireland.

CE Mark Notice

This equipment complies with the essential requirements of the European Union Directive 1999/5/EC.

Cet équipement est conforme aux principales caractéristiques définies dans la Directive européenne RTTE 1999/5/CE.

Die Geräte erfüllen die grundlegenden Anforderungen der RTTE-Richtlinie (1999/5/EG).

Questa apparecchiatura è conforme ai requisiti essenziali della Direttiva Europea R&TTE 1999/5/CE.

Este equipo cumple los requisitos principales de la Directiva 1995/5/CE de la UE, "Equipos de Terminales de Radio y Telecomunicaciones".

Este equipamento cumpre os requisitos essenciais da Directiva 1999/5/CE do Parlamento Europeu e do Conselho (Directiva RTT).

Ο εξοπλισμός αυτός πληροί τις βασικές απαιτήσεις της κοινοτικής οδηγίας EU R&TTE 1999/5/EK.

Deze apparatuur voldoet aan de noodzakelijke vereisten van EU-richtlijn betreffende radioapparatuur en telecommunicatie-eindapparatuur 199/5/EG.

Dette udstyr opfylder de Væsentlige krav i EU's direktiv 1999/5/EC om Radio- og teleterminaludstyr.

Dette utstyret er i overensstemmelse med hovedkravene i R&TTE-direktivet (1999/5/EC) fra EU.

Utrustningen uppfyller kraven för EU-direktivet 1999/5/EC om ansluten teleutrustning och ömsesidigt erkännande av utrustningens överensstämmelse (R&TTE).

Tämä laite vastaa EU:n radio- ja telepäätelaitedirektiivin (EU R&TTE Directive 1999/5/EC) vaatimuksia.

Index

B

BIOS, 67

C

characters
unexpected, 36

computer
crashes, 38
specifications, 62
turning off, 20

conflicts
resolving software and
hardware
incompatibilities, 44

crashes, 38

D

damaged computer
testing, 40

drives
fixing problems, 36

E

electrostatic discharge. See
ESD

e-mail
fixing problems, 39

ESD, 13

F

finding solutions, 24

H

hard drive
preventing damage, 56
replacing, 55

help file
accessing, 26

hibernate file
enable support, 49

I

IRQ conflicts, 44

K

keyboard
fixing problems, 35, 36
unexpected characters, 36

M

memory
adding, 52
removing, 53

modem
adding, 58

P

PC Cards
fixing problems, 34

power
fixing problems, 26
turning off, 20

printer
connecting, 16
reinstalling driver, 18
setting up, 16

programs
crashes, 38
fixing problems, 38
not responding, 38

R

RAM. See memory

reinstalling drivers and
utilities, 41

S

- safety instructions
 - ESD prevention, 13
- settings
 - system setup program, 67
- shutdown, 20
- software
 - fixing problems, 38
- specifications, 62
- System Restore, 45
- system setup program, 67

T

- Tell Me How help file
 - accessing, 26
- troubleshooting
 - about, 24
 - blue screen, 38
 - dropped or damaged computer, 40
 - e-mail problems, 39
 - external keyboard problems, 35
 - PC Card problems, 34
 - power problems, 26
 - program crash, 38
 - program stopped responding, 38
 - scanner problems, 34
 - unexpected characters, 36
 - wet computer, 39
- turning off the computer, 20

W

- wet computer, 39
- Windows XP
 - Device Driver Rollback, 43
 - Help, 26
 - printer, 32
 - reinstalling, 48
 - shutdown, 20

Free Manuals Download Website

<http://myh66.com>

<http://usermanuals.us>

<http://www.somanuals.com>

<http://www.4manuals.cc>

<http://www.manual-lib.com>

<http://www.404manual.com>

<http://www.luxmanual.com>

<http://aubethermostatmanual.com>

Golf course search by state

<http://golfingnear.com>

Email search by domain

<http://emailbydomain.com>

Auto manuals search

<http://auto.somanuals.com>

TV manuals search

<http://tv.somanuals.com>