

Dell PowerEdge FC430 Owner's Manual

Regulatory Model: E01B Series
Regulatory Type: E01B002



Notes, Cautions, and Warnings

 **NOTE:** A NOTE indicates important information that helps you make better use of your computer.

 **CAUTION:** A CAUTION indicates either potential damage to hardware or loss of data and tells you how to avoid the problem.

 **WARNING:** A WARNING indicates a potential for property damage, personal injury, or death.

Copyright © 2015 Dell Inc. All rights reserved. This product is protected by U.S. and international copyright and intellectual property laws. Dell™ and the Dell logo are trademarks of Dell Inc. in the United States and/or other jurisdictions. All other marks and names mentioned herein may be trademarks of their respective companies.

2015 - 04

Rev. A00

Contents

1 About your Dell PowerEdge FC430.....	7
Front panel features and indicators.....	7
SSD activity indicator codes.....	9
iDRAC Direct LED indicator codes.....	10
Documentation matrix.....	12
Quick Resource Locator.....	13
2 Performing initial system configuration.....	14
Setting up your system.....	14
Setting up and configuring the iDRAC IP address.....	14
Logging in to iDRAC.....	15
Installing the operating system.....	15
Managing your system remotely.....	15
Downloading drivers and firmware.....	15
3 Pre-operating system management applications.....	17
Navigation keys.....	17
About System Setup.....	17
About Dell Lifecycle Controller.....	18
Entering System Setup.....	18
Enabling Console Redirection.....	18
System Setup Main Menu.....	18
System BIOS screen.....	18
System Information screen.....	19
System Memory screen.....	20
Processor Settings screen.....	20
SATA Settings screen.....	22
Boot Settings screen.....	22
Network Settings screen.....	23
Integrated Devices screen.....	23
Serial Communication screen.....	24
System Profile Settings screen.....	25
System Security Settings screen.....	26
Miscellaneous Settings screen.....	28
About Boot Manager.....	29
Entering Boot Manager	29
Boot Manager main menu.....	29
Changing the boot order.....	29

Choosing the system boot mode.....	30
Assigning a system or setup password.....	30
Using your system password to secure your system.....	31
Deleting or changing an existing system password or setup password.....	31
Operating with a setup password enabled.....	32
Embedded systems management.....	32
iDRAC Settings utility.....	32
Entering the iDRAC Settings utility.....	33

4 Installing and removing sled components..... 34

Customer and field replaceable units.....	34
Safety instructions.....	34
Before working inside your system.....	35
After working inside your system.....	35
Recommended tools.....	35
Removing and installing a sled.....	35
Removing a sled.....	35
Installing a sled.....	36
Inside the sled.....	37
Cooling shroud.....	37
Removing the cooling shroud.....	37
Installing the cooling shroud.....	39
System memory.....	39
General memory module installation guidelines.....	40
Mode-specific guidelines.....	41
Sample memory configurations.....	43
Removing memory modules.....	44
Installing memory modules.....	46
PCIe mezzanine card.....	47
Removing the PCIe mezzanine card.....	47
Installing the PCIe mezzanine card.....	50
Internal Dual SD Module (IDSDM) card	51
Removing an internal SD card.....	51
Installing an internal SD card.....	52
Removing the IDSDM card.....	53
Installing the IDSDM card.....	55
SD vFlash card.....	56
Replacing the SD vFlash card.....	56
Installing the SD vFlash card.....	57
LAN on Motherboard (LOM) riser card.....	57
Removing the LOM riser card.....	57
Installing the LOM riser card.....	58

Processors.....	59
Removing a heat sink.....	59
Removing a processor.....	61
Installing a processor.....	64
Installing a heat sink.....	65
Processor-and-DIMM blank.....	67
Removing a processor-and-DIMM blank.....	67
Installing a processor-and-DIMM blank.....	68
Solid State Drives (SSD).....	69
SSD installation guidelines.....	69
Shutdown procedure for servicing an SSD.....	69
Removing an SSD from an SSD carrier	69
Installing an SSD into an SSD carrier.....	70
Removing an SSD carrier.....	71
Installing an SSD carrier.....	72
Removing an SSD blank.....	73
Installing an SSD blank.....	74
Removing the SSD cage.....	74
Installing the SSD cage.....	76
Configuring the boot drive.....	76
Solid State Drive (SSD) backplane.....	77
Removing the SSD backplane.....	77
Installing the SSD backplane.....	78
NVRAM backup battery.....	79
Replacing the NVRAM backup battery.....	79
System board.....	80
Removing the system board.....	80
Installing the system board.....	83
Restoring the Service Tag using Easy Restore.....	84
Entering the system Service Tag using System Setup.....	85
Trusted Platform Module.....	85
Installing the Trusted Platform Module	85
Re-enabling the TPM for BitLocker users.....	86
Re-enabling the TPM for TXT users.....	86
5 Troubleshooting your system.....	87
Safety first—for you and your system.....	87
Troubleshooting system memory.....	87
Troubleshooting Solid State Drives.....	88
Troubleshooting USB devices.....	88
Troubleshooting an internal SD card.....	89
Troubleshooting processors.....	89

Troubleshooting the system board.....	90
Troubleshooting the NVRAM backup battery.....	90
6 Using system diagnostics.....	92
Dell Embedded System Diagnostics.....	92
When to use the Embedded System Diagnostics.....	92
Running the Embedded System Diagnostics.....	92
System diagnostics controls.....	93
7 Jumpers and connectors.....	94
System board jumper settings.....	94
System board connectors.....	95
Disabling a forgotten password.....	96
8 Technical specifications.....	97
9 Getting help.....	101
Contacting Dell.....	101
Locating your system Service Tag.....	101
Documentation feedback.....	101
Quick Resource Locator.....	101

About your Dell PowerEdge FC430

The Dell PowerEdge FC430 is a quarter width sled that supports up to two processors based on the Intel Haswell EP product family, up to eight DIMMs, and up to two 1.8" uSATA Solid State Drives (SSD).

The PowerEdge FC430 system is available in the following configurations:

- A single 1.8 inch SSD drive bay.
- A dual 1.8 inch SSD drive bay.

Front panel features and indicators

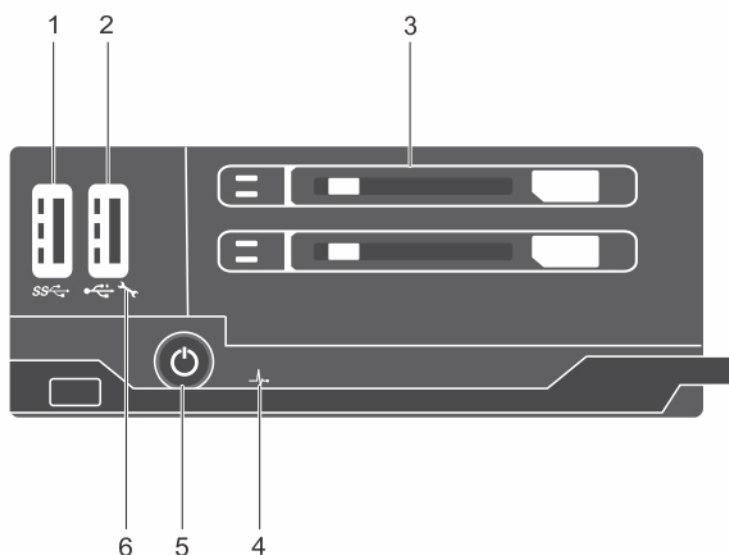







Figure 1. Front panel features and indicators— dual SSD system

Item	Indicator, Button, or Connector	Icon	Description
1	USB connector		Enables you to connect USB devices to the sled. This port is USB 3.0 compliant.
2	USB management		Enables you to connect USB devices to the sled or provides access to the iDRAC Direct features. Refer to the

Item	Indicator, Button, or Connector	Icon	Description
	port / iDRAC Direct port		iDRAC Guide at dell.com/esmmanuals for more information. This port is USB 2.0 compliant.
3	SSD (2)		Up to two 1.8 inch, hot-swappable uSATA SSDs are supported in this chassis.
4	Health status indicator icon		Health status indicator icon LED.
5	Sled power-on indicator, power button		The power-on indicator lights when the sled is powered on. The power button controls the power supply output to the system.
6	iDRAC indicator icon		iDRAC indicator icon LED. The management indicator LED lights when the iDRAC controls the USB port for management functions.

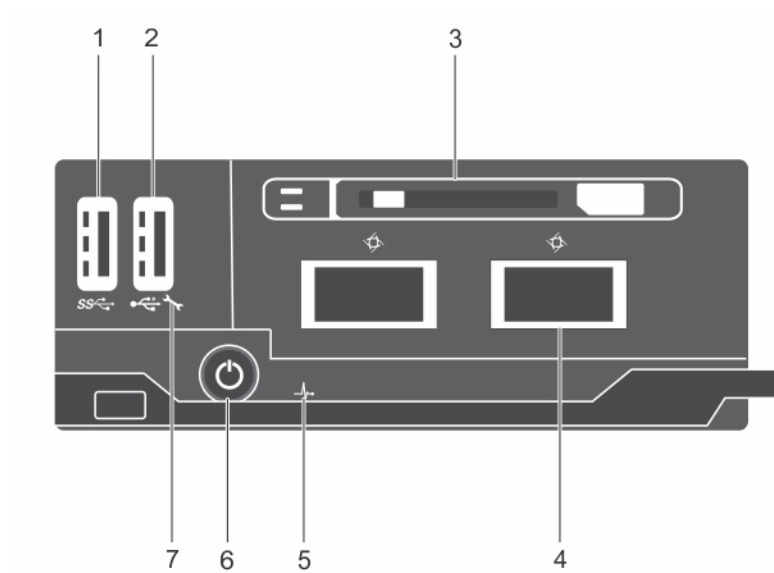









Figure 2. Front panel features and indicators— single SSD system

Item	Indicator, Button, or Connector	Icon	Description
1	USB connector		Enables you to connect USB devices to the sled. This port is USB 3.0 compliant.
2	USB management port/ iDRAC Direct port		Enables you to connect USB devices to the sled or provides access to the iDRAC Direct features. Refer to the iDRAC Guide at dell.com/esmmanuals for more information. This port is USB 2.0 compliant.
3	SSD		A single 1.8 inch, hot-swappable uSATA SSD is supported in this chassis.
4	QSFP+ connector (2)		The QSFP+ connectors can be used for Infiniband or for Ethernet
5	Health status indicator icon		Health status indicator icon LED.
6	Sled power-on indicator, power button		The power-on indicator lights when the sled is powered on. The power button controls the power supply output to the system.
7	iDRAC indicator icon		iDRAC indicator icon LED. The management indicator LED lights when the iDRAC controls the USB port for management functions.

SSD activity indicator codes

The Solid State Drive (SSD) indicators display different patterns as drive events occur in the system.

 **NOTE:** The sled must have an SSD or an SSD blank installed in each drive bay.

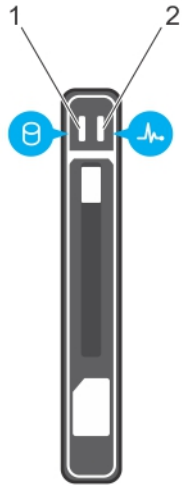

Figure 3. SSD indicators

1. drive activity indicator (green)
2. drive status indicator (green and amber)

NOTE: If the drive is in the Advanced Host Controller Interface (AHCI) mode, the status LED (on the right side) does not function and remains OFF.

Drive-Status Indicator Pattern	Condition
Blinks green two times per second	Identifying the drive or preparing for removal
Off	Drive ready for insertion or removal NOTE: The drive status indicator remains OFF until all drives are initialized after system power is applied. Drives are not ready for insertion or removal during this time.
Blinks green, amber, and then turns off	Drive predicted failure
Blinks amber four times per second	Drive failed
Blinks green slowly	Drive rebuilding
Steady green	Drive online
Blinks green for three seconds, amber for three seconds, and switches off for six seconds	Rebuild aborted

iDRAC Direct LED indicator codes

NOTE: The iDRAC Direct LED indicator does not light up in the USB mode.

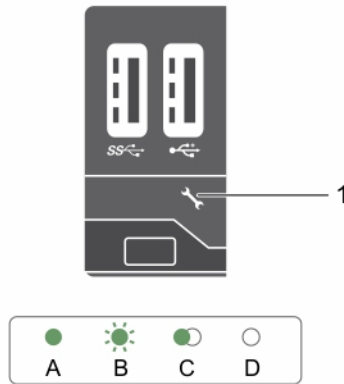

Figure 4. iDRAC Direct LED indicator

1. iDRAC Direct status indicator

The table below displays iDRAC Direct LED indicator activity when configuring iDRAC Direct by using the management port (USB XML Import).

Convention	iDRAC Direct LED indicator pattern	Condition
A	Steady green	Indicates the beginning and end of a file transfer. The indicator lights green for a minimum of 2 seconds during this time
B	Flashing green	Indicates file transfer or any operation tasks.
C	Flashing green and turns off	Indicates that the file transfer is complete.
D	Turns off	Indicates that the USB is ready to be removed or that a task is complete.

The table below displays iDRAC Direct LED indicator activity when configuring iDRAC Direct using your laptop and cable (Laptop Connect).

iDRAC Direct LED indicator pattern	Condition
Steady green for two seconds	Indicates that the system is connected.
Flashing green (on for two seconds and off for two seconds)	Indicates that the connected system is recognized.
Turns off	Indicates that the system is unplugged.

Documentation matrix

The documentation matrix provides information about documents that you can refer to, for setting up and managing your system.

To...	Refer to...
Set up your system and know the system technical specifications	Getting Started With Your System
Install the operating system	Operating system documentation at dell.com/operatingsystemmanuals
Get an overview of the Dell Systems Management offerings	Dell OpenManage Systems Management Overview Guide at dell.com/openmanagemanuals
Configure and log in to iDRAC, set up managed and management system, know the iDRAC features, and troubleshoot using iDRAC	Integrated Dell Remote Access Controller User's Guide at dell.com/esmmanuals
Know about the RACADM subcommands and supported RACADM interfaces	RACADM Command Line Reference Guide for iDRAC and CMC at dell.com/esmmanuals
Start, enable, and disable Lifecycle Controller, know the features, use, and troubleshoot Lifecycle Controller	Dell Lifecycle Controller User's Guide at dell.com/esmmanuals
Use Lifecycle Controller Remote Services	Dell Lifecycle Controller Remote Services Quick Start Guide at dell.com/esmmanuals
Set up, use, and troubleshoot OpenManage Server Administrator	Dell OpenManage Server Administrator User's Guide at dell.com/openmanagemanuals
Install, use and troubleshoot OpenManage Essentials	Dell OpenManage Essentials User's Guide at dell.com/openmanagemanuals
Know the system features, remove and install system components, and troubleshoot components	Owner's Manual at dell.com/poweredgemanuals
Know the enclosure features, remove and install enclosure components, and troubleshoot enclosure components	Enclosure Owner's Manual at dell.com/poweredgemanuals
Know the features of the storage controller cards, deploy the cards, and manage the storage subsystem	Storage controller documentation at dell.com/storagecontrollermanuals
See the event and error messages generated by the system firmware and agents that monitor system components	Dell Event and Error Messages Reference Guide at dell.com/esmmanuals

Quick Resource Locator

Use the Quick Resource Locator (QRL) to get immediate access to system information and how-to videos. This can be done by visiting dell.com/QRL or by using your smartphone and a model specific Quick Resource (QR) code located on your Dell PowerEdge system. To try out the QR code, scan the following image.



Performing initial system configuration

After you receive your PowerEdge system, you must set up your system in the enclosure, install the operating system if it is not pre-installed, and set up and configure the system iDRAC IP address.

Setting up your system

1. Unpack the sled.
2. Remove the I/O connector cover from the sled connectors.

 **CAUTION:** While installing the sled, ensure that it is properly aligned with the slot on the enclosure to prevent damage to the sled connectors.

3. Install the sled in the enclosure.
4. Turn on the enclosure.

 **NOTE:** Wait for the chassis to initialize before you press the power button.

5. Turn on the sled by pressing the power button on the sled.
Alternatively, you can also turn on the sled by using:
 - The sled iDRAC. For more information, see [Logging in to iDRAC](#).
 - The enclosure Chassis Management Controller (CMC), after the sled iDRAC is configured on the CMC. For more information, see the CMC User's Guide at dell.com/esmmanuals.

Setting up and configuring the iDRAC IP address

You can set up the iDRAC IP address using one of the following interfaces:

- iDRAC Settings utility
- Dell Lifecycle Controller
- Dell Deployment Toolkit
- CMC Web interface

You can configure iDRAC using one of the following interfaces:

- iDRAC Web interface
- RACADM
- Remote services
- IPMI tool

For more information on setting up and configuring iDRAC, see the iDRAC User's Guide at dell.com/esmmanuals.

Logging in to iDRAC

You can log in to iDRAC as an iDRAC user, a Microsoft Active Directory user, or a Lightweight Directory Access Protocol (LDAP) user. You can also log in using Single Sign-On or Smart Card. The default user name is `root` and password is `calvin`. For more information on logging in to iDRAC and iDRAC licenses, see the iDRAC User's Guide at dell.com/esmmanuals.

You can also access iDRAC using RACADM. For more information, see the *RACADM Reference Guide for iDRAC and CMC* available at dell.com/esmmanuals.

Installing the operating system

You can install the supported operating system on the sled by using the following methods:

- Dell Systems Management Tools and Documentation media. See the operating system documentation at dell.com/operatingsystemmanuals.
- Dell Lifecycle Controller. See the Lifecycle Controller documentation at dell.com/esmmanuals.
- Dell OpenManage Deployment Toolkit. See the OpenManage documentation at dell.com/openmanagemanuals.

For information on the list of operating systems supported on your system, see the operating system's support matrix at dell.com/ossupport.

Managing your system remotely

To perform out-of-band systems management by using iDRAC, you must configure iDRAC for remote accessibility, set up the management station and managed system, and configure the supported Web browsers. For more information, see the iDRAC User's Guide at dell.com/esmmanuals.

You can also remotely monitor and manage the sleds from a single workstation, using the Dell OpenManage Server Administrator (OMSA) software and OpenManage Essentials (OME) systems management console. For more information, see dell.com/openmanagemanuals.

Downloading drivers and firmware

It is recommended that you download and install the latest BIOS, drivers, and systems management firmware on your system.

Prerequisites

Ensure that you clear the web browser cache.

Steps

1. Go to dell.com/support/drivers.
2. In the **Product Selection** section, enter the Service Tag of your system in the **Service Tag or Express Service Code** field.
 -  **NOTE:** If you do not have the Service Tag, select **Automatically detect my Service Tag for me** to allow the system to automatically detect your Service Tag, or select **Choose from a list of all Dell products** to select your product from the **Product Selection** page.
3. Click **Get drivers and downloads**.

The drivers that are applicable to your selection are displayed.

4. Download the drivers you require to a diskette drive, USB drive, CD, or DVD.

Pre-operating system management applications

The pre-operating system management applications for your PowerEdge system help you manage different settings and features of your system without booting to the operating system.

Your PowerEdge system has the following pre-operating system management applications:

- System Setup
- Boot Manager
- Dell Lifecycle Controller

Navigation keys

The navigation keys can help you quickly access the pre-operating system management applications.

Key	Description
<Page Up>	Moves to the previous screen.
<Page Down>	Moves to the next screen.
Up arrow	Moves to the previous field.
Down arrow	Moves to the next field.
<Enter>	Enables you to type a value in the selected field (if applicable) or follow the link in the field.
Spacebar	Expands or collapses a drop-down list, if applicable.
<Tab>	Moves to the next focus area.
	 NOTE: This feature is applicable for the standard graphic browser only.
<Esc>	Moves to the previous page until you view the main screen. Pressing <Esc> in the main screen exits System BIOS or iDRAC Settings/ Device Settings/Service Tag Settings and proceeds with system boot.
<F1>	Displays the System Setup help.

About System Setup

Using **System Setup**, you can configure the BIOS settings, iDRAC settings, and device settings of your system.

You can access **System Setup** in two ways:

- Standard Graphical Browser — This is enabled by default.
- Text Browser — This is enabled by using Console Redirection.

 **NOTE:** By default, help text for the selected field is displayed in the graphical browser. To view the help text in the text browser, press <F1>.

About Dell Lifecycle Controller

Dell Lifecycle Controller allows you to perform tasks such as configuring BIOS and hardware settings, deploying an operating system, updating drivers, changing RAID settings, and saving hardware profiles. For more information about Dell Lifecycle Controller, see the documentation at dell.com/esmmanuals.

Entering System Setup

1. Turn on or restart your system.
2. Press <F2> immediately after you see the following message:

```
<F2> = System Setup
```

If your operating system begins to load before you press <F2>, wait for the system to finish booting, and then restart your system and try again.

Enabling Console Redirection

To enable **Console Redirection**, in **System Setup**, select **System BIOS** → **Serial Communication** → **On with Console Redirection via COMx** (or **Auto** if a serial terminal is present).

System Setup Main Menu

Option	Description
System BIOS	Enables you to configure BIOS settings.
iDRAC Settings	Enables you to configure iDRAC settings. The iDRAC Settings utility is an interface to set up and configure the iDRAC parameters by using UEFI. You can enable or disable various iDRAC parameters by using the iDRAC Settings utility. For more information about this utility, see the Integrated Dell Remote Access Controller User's Guide at dell.com/esmmanuals .
Device Settings	Enables you to configure device settings.

System BIOS screen

By using the **System BIOS** screen, you can view the BIOS settings as well as edit specific functions such as **Boot Order**, **System Password**, **Setup Password**, setting the RAID mode, and enabling or disabling USB ports.

To view the System BIOS screen click **System BIOS** on the **System Setup Main Menu**.

The **System BIOS** screen details are explained as follows:

Menu Item	Description
System Information	Displays information about the system such as the system model name, BIOS version and Service Tag.
Memory Settings	Displays information and options related to the installed memory.
Processor Settings	Displays information and options related to the processor such as speed, cache size.
SATA Settings	Displays options to enable or disable the integrated SATA controller and ports.
Boot Settings	Displays options to specify the boot mode (BIOS or UEFI). Enables you to modify UEFI and BIOS boot settings.
Network Settings	Displays options to change the network settings.
Integrated Devices	Displays options to enable or disable integrated device controllers and ports and specify related features and options.
Serial Communication	Displays options to enable or disable the serial ports and specify related features and options.
System Profile Settings	Displays options to change the processor power management settings, memory frequency, and so on.
System Security	Displays options to configure the system security settings such as, system password, setup password, TPM security. It also enables or disables support for the power and NMI buttons on the system.
Miscellaneous Settings	Displays options to change the system date, time, and so on.

System Information screen

You can use the **System Information** screen to view system properties such as Service Tag, system model, and the BIOS version.

To view the **System Information** click **System Setup Main Menu** → **System BIOS** → **System Information**.

The **System Information** screen details are explained as follows:

Menu Item	Description
System Model Name	Displays the system model name.
System BIOS Version	Displays the BIOS version installed on the system.
System Management Engine Version	Displays the current revision of the Management Engine firmware.
System Service Tag	Displays the system service tag.
System Manufacturer	Displays the name of the system manufacturer.
System Manufacturer Contact Information	Displays the contact information of the system manufacturer.
System CPLD Version	Displays the current revision of the system CPLD firmware.
UEFI Compliance Version	Displays the system firmware UEFI compliance level.

System Memory screen

The **System Memory** screen allows you to view all the memory settings as well as enable or disable specific memory functions such as system memory testing and node interleaving.

In the **System Setup Main Menu**, click **System BIOS** → **System Memory**.



Menu Item	Description
System Memory Size	Displays the amount of memory installed in the system.
System Memory Type	Displays the type of memory installed in the system.
System Memory Speed	Displays the system memory speed.
System Memory Voltage	Displays the system memory voltage.
Video Memory	Displays the amount of video memory.
System Memory Testing	Specifies whether system memory tests are run during system boot. Options are Enabled and Disabled . By default, the System Memory Testing option is set to Disabled .
Memory Operating Mode	Specifies the memory operating mode. The options available are Optimizer Mode , Advanced ECC Mode , Mirror Mode . By default, the Memory Operating Mode option is set to Optimizer Mode .  NOTE: The Memory Operating Mode can have different defaults and available options based on the memory configuration of your system.
Node Interleaving	If this field is set to Enabled , memory interleaving is supported if a symmetric memory configuration is installed. If this field is set to Disabled , the system supports Non-Uniform Memory architecture (NUMA) (asymmetric) memory configurations. By default, Node Interleaving option is set to Disabled .
Snoop Mode	Snoop Mode options available are Disabled , Home Snoop , Early Snoop , Cluster on Die . By default, the Snoop Mode option is set to Disabled . The field is only available when Node Interleaving is set to Disabled .

Processor Settings screen

You can use the **Processor Settings** screen to view the processor settings and perform specific functions such as enabling virtualization technology, hardware prefetcher, and logical processor idling.

To view the **Processor Settings** screen click the **System Setup Main Menu** → **System BIOS** → **Processor Settings**.

Menu Item	Description
Logical Processor	Enables or disables the logical processors and displays the number of logical processors. If the Logical Processor option is set to Enabled , the BIOS displays all the logical processors. If this option is set to Disabled , the BIOS displays only one logical processor per core. By default, the Logical Processor option is set to Enabled .
Alternate RTID (Requestor Transaction ID) Setting	Enables you to allocate more RTIDs to the remote socket, thereby increasing cache performance between the sockets or easing work in normal mode for NUMA. By default, the Alternate RTID (Requestor Transaction ID) Setting is set to Disabled .

Menu Item	Description
Virtualization Technology	Enables or disables the additional hardware capabilities provided for virtualization. By default, the Virtualization Technology option is set to Enabled .
Address Translation Service (ATS)	Defines the Address Translation Cache (ATC) for devices to cache the DMA transactions. This field provides an interface to a chipset's Address Translation and Protection Table to translate DMA addresses to host addresses. By default, the option is set to Enabled .
Adjacent Cache Line Prefetch	Optimizes the system for applications that require high utilization of sequential memory access. By default, the Adjacent Cache Line Prefetch option is set to Enabled . You can disable this option for applications that require high utilization of random memory access.
Hardware Prefetcher	Enables or disables the hardware prefetcher. By default, the Hardware Prefetcher option is set to Enabled .
DCU Streamer Prefetcher	Allows you to enable or disable the Data Cache Unit (DCU) streamer prefetcher. By default, the DCU Streamer Prefetcher option is set to Enabled .
DCU IP Prefetcher	Enables or disables the Data Cache Unit (DCU) IP prefetcher. By default, the DCU IP Prefetcher option is set to Enabled .
Execute Disable	Enables or disables the execute disable memory protection technology feature. By default, the Execute Disable option is set to Enabled .
Logical Processor Idling	Enables or disables the operating system capability to put logical processors in the idling state in order to reduce power consumption. By default, the option is set to Disabled .
Configurable TDP	Allows reconfiguration of Thermal Design Power (TDP) to lower levels. TDP refers to the maximum amount of power the cooling system is required to dissipate.
X2Apic Mode	Enables or disables the X2Apic mode.
Dell Controlled Turbo	 NOTE: Depending on the number of installed CPUs, there may be up to four processor listings. Controls the turbo engagement. Enable this option only when System Profile is set to Performance .
Number of Cores per Processor	Controls the number of enabled cores in each processor. By default, the Number of Cores per Processor option is set to All .
Processor 64-bit Support	Specifies if the processor(s) support 64-bit extensions.
Processor Core Speed	Displays the maximum core frequency of the processor.
Processor 1	 NOTE: Depending on the number of installed CPUs, there may be up to four processor listings. The following settings are displayed for each processor installed in the system.
Family-Model-Stepping	Displays the family, model and stepping of the processor as defined by Intel.
Brand	Displays the brand name reported by the processor.
Level 2 Cache	Displays the total L2 cache.

Menu Item	Description
Level 3 Cache	Displays the total L3 cache.
Number of Cores	Displays the number of cores per processor.

SATA Settings screen

You can use the **SATA Settings** screen to view the SATA settings of SATA devices and enable RAID on your system.

To view the **SATA Settings** screen, click **System Setup Main Menu** → **System BIOS** → **SATA Settings**.

Menu Item	Description
Embedded SATA	Enables the embedded SATA to be set to Off , ATA , AHCI , or RAID modes. By default, the Embedded SATA option is set to AHCI .
Security Freeze Lock	Sends Security Freeze Lock command to the Embedded SATA drives during POST. This option is applicable only to ATA and AHCI mode.
Write Cache	Enables or disables the command for Embedded SATA drives during POST.
Port A	Sets the drive type of the selected device. For Embedded SATA settings in ATA mode, set this field to Auto to enable BIOS support. Set it to OFF to turn off BIOS support. For AHCI mode or RAID mode, BIOS always enables support.
Model	Displays the drive model of the selected device.
Drive Type	Displays the type of drive attached to the SATA port.
Capacity	Displays the total capacity of the hard drive. The field is undefined for removable media devices such as optical drives.
Port B	Sets the drive type of the selected device. For Embedded SATA settings in ATA mode, set this field to Auto to enable BIOS support. Set it to OFF to turn off BIOS support. For AHCI mode or RAID mode, BIOS always enables support.
Model	Displays the drive model of the selected device.
Drive Type	Displays the type of drive attached to the SATA port.
Capacity	Displays the total capacity of the hard drive. The field is undefined for removable media devices such as optical drives.

Boot Settings screen

You can use the **Boot Settings** screen to set the Boot mode to either **BIOS** or **UEFI**. It also enables you to specify the boot order.

To view the **Boot Settings** screen, click **System Setup Main Menu** → **System BIOS** → **Boot Settings**.

Menu Item	Description
Boot Mode	Enables you to set the boot mode of the system.
	 CAUTION: Switching the boot mode may prevent the system from booting if the operating system is not installed in the same boot mode.

Menu Item	Description
	 NOTE: Setting this field to UEFI disables the BIOS Boot Settings menu. Setting this field to BIOS disables the UEFI Boot Settings menu. If the operating system supports UEFI, you can set this option to UEFI . Setting this field to BIOS allows compatibility with non-UEFI operating systems. By default, the Boot Mode option is set to BIOS .
Boot Sequence Retry	Enables or disables the Boot Sequence Retry feature. If this field is enabled and the system fails to boot, the system reattempts the boot sequence after 30 seconds. By default, the Boot Sequence Retry option is set to Enabled .
Hard-Disk Failover	Specifies which devices in the Hard-Disk Drive Sequence are attempted in the boot sequence. When the option is set to Disabled , only the first hard disk device in the list is attempted to boot. When set to Enabled , all hard disk devices are attempted in the order, as listed in the Hard-Disk Drive Sequence . This option is not enabled for UEFI Boot Mode.
Boot Option Settings	Configures the boot sequence and the boot devices.

Network Settings screen

You can use the **Network Settings** screen to modify PXE device settings. Network Settings are only available in UEFI boot mode. BIOS does not control network settings in the BIOS boot mode. For BIOS boot mode, the network settings are handled by the network controllers option ROM.

To view the **Network Settings** screen, click **System Setup Main Menu** → **System BIOS** → **Network Settings**.

Menu Item	Description
PXE Device n (n = 1 to 4)	Enables or disables the device. When enabled, a UEFI boot option is created for the device.
PXE Device n Settings (n = 1 to 4)	Allows you to control the configuration of the PXE device.

Integrated Devices screen

Integrated Devices screen allows you to view and configure the settings of all integrated devices including the video controller, integrated RAID controller, and the USB ports.

To view the **Integrated Devices** screen, click the **System Setup Main Menu**, → **System BIOS** → **Integrated Devices**.

Menu Item	Description
USB 3.0 Setting	Allows you to enable or disable the USB 3.0 support. Enable this option only if your operating system support USB 3.0. Disabling this allows devices to operate at USB 2.0 speed. USB 3.0 is disabled by default
User Accessible USB Ports	Allows you to enable or disable the USB ports. Selecting All Ports Off disables all USB ports. The USB keyboard and mouse operate during the boot process in certain operating systems. After the boot process is complete, the USB keyboard and mouse do not work if the ports are disabled.

Menu Item	Description
	 NOTE: Selecting All Ports Off will disable the USB management port and also restrict access to iDRAC features.
Integrated RAID Controller	Allows you to enable or disable the integrated RAID controller.
Integrated Network Card	Allows you to enable or disable the Integrated Network Card. If set to Disabled , the Integrated Network Card may still be available for shared network access by the embedded management controller. Configure this feature using the Integrated Network Card management utilities of the embedded management controller.
I/OAT DMA Engine	Allows you to enable or disable the I/OAT option. Enable only if the hardware and software supports the feature.
Embedded Video Controller	Allows you to enable or disable the Embedded Video Controller . By default, the embedded video controller is set to Enabled . Current state of Embedded Video Controller is set to Enabled . Current State of Embedded Video Controller is a read only field, indicating the current state for the Embedded Video Controller. If the Embedded Video Controller is the only display capability in the system (that is, no add-in graphics card is installed), then the Embedded Video Controller is automatically used as the primary display even if the Embedded Video Controller setting is set to Disabled .
SR-IOV Global Enable	Allows you to enable or disable the BIOS configuration of Single Root I/O Virtualization (SR-IOV) devices. By default, the SR-IOV Global Enable option is set to Disabled .
OS Watchdog Timer	If your system stops responding, this watchdog timer aids in the recovery of your operating system. When this field is set to Enabled , the operating system is allowed to initialize the timer. When it is set to Disabled (the default), the timer will have no effect on the system.
Memory Mapped I/O above 4GB	Allows you to enable support for PCIe devices that require large amounts of memory. By default, the option is set to Enabled .
Slot Disablement	Allows you to enable or disable available PCIe slots on your system. The Slot Disablement feature controls the configuration of PCIe cards installed in the specified slot. Slot disablement must be used only when the installed peripheral card prevents booting, or causes delays in system startup. If the slot is disabled, both the Option ROM and UEFI driver are disabled.

Serial Communication screen

You can use the **Serial Communication** screen to view the properties of the serial communication port. To view the **Serial Communication** screen, click **System Setup Main Menu** → **System BIOS** → **Serial Communication**.

Menu Item	Description
Serial Communication	Selects serial communication devices in the BIOS. By default, Serial Communication option is set to Off . The sSerial Communication port can be set to On without Console Redirection , On with Console Redirection , or Off with Console Redirection .
Serial Port Address	Enables you to set the port address for serial devices. By default, the Serial Port Address option is set to COM1



Menu Item	Description
External Serial Connector	You can associate the External Serial Connector to Serial Device 1.
Failsafe Baud Rate	Displays the failsafe baud rate for console redirection. The BIOS attempts to determine the baud rate automatically. This failsafe baud rate is used only if the attempt fails, and the value must not be changed. By default, the Failsafe Baud Rate option is set to 115200 .
Remote Terminal Type	Sets the remote console terminal type. By default, the Remote Terminal Type option is set to VT 100/VT 220 .
Redirection After Boot	Enables or disables the BIOS console redirection when the operating system is loaded. By default, the Redirection After Boot option is set to Enabled .

System Profile Settings screen

You can use the **System Profile Settings** screen to enable specific system performance settings such as power management.

To view the **System Profile Settings** click **System Setup Main Menu** → **System BIOS** → **System Profile Settings**.

Menu Item	Description
System Profile	<p>Sets the system profile. If you set the System Profile option to a mode other than Custom, the BIOS automatically sets the rest of the options. You can only change the rest of the options if the mode is set to Custom. By default, the System Profile option is set to Performance Per Watt Optimized (DAPC). DAPC is Dell Active Power Controller.</p> <p> NOTE: The following parameters are available only when the System Profile is set to Custom.</p>
CPU Power Management	Sets the CPU power management. By default, the CPU Power Management option is set to System DBPM (DAPC) . DBPM is Demand-Based Power Management.
Memory Frequency	Sets the speed of the system memory. You can select Maximum Performance , Maximum Reliability , or a specific speed.
Turbo Boost	Enables or disables the processor to operate in turbo boost mode. By default, the Turbo Boost option is set to Enabled .
Energy Efficient Turbo	Enables or disables the Energy Efficient Turbo . Energy Efficient Turbo (EET) is a mode of operation where a processor's core frequency is adjusted within the turbo range based on workload.
C1E	Enables or disables the processor to switch to a minimum performance state when it is idle. By default, the C1E option is set to Enabled .
C States	Enables or disables the processor to operate in all available power states. By default, the C States option is set to Enabled .
Collaborative CPU Performance Control	Enables or disables the CPU power management. When set to Enabled , the CPU power management is controlled by the OS DBPM and the System DBPM (DAPC). By default, the option is set to Disabled .
Memory Patrol Scrub	Sets the memory patrol scrub frequency. By default, the Memory Patrol Scrub option is set to Standard .

Menu Item	Description
Memory Refresh Rate	Sets the memory refresh rate to either 1x or 2x. By default, the Memory Refresh Rate option is set to 1x .
Uncore Frequency	Selects the Processor Uncore Frequency . Dynamic mode allows the processor to optimize power resources across the cores and uncore during runtime. The optimization of the uncore frequency to either save power or optimize performance is influenced by the setting of the Energy Efficiency Policy .
Energy Efficient Policy	Enables you to select the Energy Efficient Policy . The CPU uses the setting to manipulate the internal behavior of the processor and determines whether to target higher performance or better power savings.
Number of Turbo Boost Enabled Cores for Processor 1	 NOTE: If there are two processors installed in the system, you see an entry for Number of Turbo Boost Enabled Cores for Processor 2 . Controls the number of turbo boost enabled cores for processor 1. By default, the maximum number of cores is enabled.
Monitor/Mwait	Enables the Monitor/Mwait instructions in the processor. By default, the Monitor/Mwait option is set to Enabled for all system profiles, except Custom .  NOTE: This option can be disabled only if the C States option in Custom mode is set to disabled .  NOTE: When C States set to Enabled in Custom mode, changing the Monitor/Mwait setting does not impact system power/performance.

System Security Settings screen

The **System Security** screen allows you to perform specific functions such as setting the system password, setup password, and disabling the power button.

To view the **System Security Settings** in the **System Setup Main Menu** screen, click **System BIOS** → **System Security Settings**.

Menu Item	Description
Intel AES-NI	Improves the speed of applications by performing encryption and decryption using the Advanced Encryption Standard Instruction Set and is set to Enabled by default.
System Password	Allows you to set the system password. This option is set to Enabled by default and is read-only if the password jumper is not installed in the system.
Setup Password	Allows you to set the setup password. This option is read-only if the password jumper is not installed in the system.
Password Status	Allows you to lock the system password. By default, the Password Status option is set to Unlocked .
TPM Security	 NOTE: The TPM menu is available only when the TPM module is installed.

Menu Item	Description
	Allows you to control the reporting mode of the Trusted Platform Module (TPM). By default, the TPM Security option is set to Off . You can only modify the TPM Status, TPM Activation, and Intel TXT fields if the TPM Status field is set to either On with Pre-boot Measurements or On without Pre-boot Measurements .
TPM Information	Allows you to change the operational state of the TPM. By default, the TPM Activation option is set to No Change .
TPM Status	Displays the TPM status.
TPM Command	 CAUTION: Clearing the TPM results in the loss of all keys in the TPM. The loss of TPM keys may affect booting to the operating system.
	Allows you to clear all the contents of the TPM. By default, the TPM Clear option is set to No .
Intel TXT	Allows you to enable or disable Intel Trusted Execution Technology (TXT). To enable Intel TXT , Virtualization Technology must be enabled and TPM Security must be Enabled with Pre-boot measurements. By default, the Intel TXT option is set to Off .
Power Button	Allows you to enable or disable the power button on the front of the system. By default, the Power Button option is set to Enabled .
AC Power Recovery	Allows you to set how the system reacts after AC power is restored to the system. By default, the AC Power Recovery option is set to Last .
UEFI Variable Access	Provides varying degrees of securing UEFI variables. When set to Standard (the default) UEFI variables are accessible in the Operating System per the UEFI specification. When set to Controlled , selected UEFI variables are protected in the environment and new UEFI boot entries are forced to be at the end of the current boot order.
Secure Boot	Allows you to enable Secure Boot, where the BIOS authenticates each pre-boot image using the certificates in the Secure Boot Policy. Secure Boot is disabled by default.
Secure Boot Policy	When Secure Boot policy is Standard , the BIOS uses the system manufacturer's key and certificates to authenticate pre-boot images. When Secure Boot policy is Custom , the BIOS uses the user-defined key and certificates. Secure Boot policy is Standard by default.
Secure Boot Policy Summary	Allows you to view the list of certificates and hashes that secure boot uses to authenticated images.

Secure Boot Custom Policy Settings screen

Secure Boot Custom Policy Settings is displayed only when **Secure Boot Policy** is set to **Custom**. In the **System Setup Main Menu**, click **System BIOS** → **System Security** → **Secure Boot Custom Policy Settings**.



Menu Item	Description
Platform Key	Allows you to import, export, delete, or restore the platform key (PK).
Key Exchange Key Database	Allows you to import, export, delete, or restore entries in the Key Exchange Key (KEK) Database

Menu Item	Description
Authorized Signature Database	Allows you to import, export, delete, or restore entries in the Authorized Signature Database (db).
Forbidden Signature Database	Allows you to import, export, delete, or restore entries in the Forbidden Signature Database (dbx).

Miscellaneous Settings screen

You can use the **Miscellaneous Settings** screen to perform specific functions such as updating the asset tag, and changing the system date and time.

To view the **Miscellaneous Settings** screen, click **System Setup Main Menu** → **System BIOS** → **Miscellaneous Settings**.

Menu Item	Description
System Time	Enables you to set the time on the system.
System Date	Enables you to set the date on the system.
Asset Tag	Displays the asset tag and enables you to modify it for security and tracking purposes.
Keyboard NumLock	Enables you to set whether the system boots with the NumLock enabled or disabled. By default the Keyboard NumLock is set to On .  NOTE: This option does not apply to 84-key keyboards.
F1/F2 Prompt on Error	Enables or disables the F1/F2 prompt on error. By default, F1/F2 Prompt on Error is set to Enabled . The F1/F2 prompt also includes keyboard errors.
Load Legacy Video Option ROM	Enables you to determine whether the system BIOS loads the legacy video (INT 10H) option ROM from the video controller. Selecting Enabled in the operating system does not support UEFI video output standards. This field is only for UEFI boot mode. You cannot set this to Enabled if UEFI Secure Boot mode is enabled.
In-System Characterization	This option enables or disables In-System Characterization . By default, In-System Characterization is set to Disabled . The two other options are Enabled and Enabled - No Reboot .  NOTE: The default setting for In-System Characterization is subject to change in future BIOS releases. When enabled, In-System Characterization (ISC) executes during POST upon detecting relevant change(s) in system configuration. This helps in optimizing the system power and performance. ISC takes about 20 seconds to execute, and system reset is required for ISC results to be applied. The Enabled - No Reboot option executes ISC and continues without applying ISC results until the

Menu Item	Description
	next time system reset occurs. The Enabled option executes ISC and forces an immediate system reset so that ISC results can be applied. It takes the system longer to be ready due to the forced system reset. When disabled, ISC does not execute.

About Boot Manager

Boot Manager enables you to add, delete, and arrange boot options. You can also access System Setup and boot options without restarting the system.

Entering Boot Manager

The **Boot Manager** screen enables you to select boot options and diagnostic utilities.

1. Turn on or restart your system.
2. Press F11 when you see the message `F11 = Boot Manager`.
If your operating system begins to load before you press F11, allow the system to finish booting, and then restart your system and try again.

Boot Manager main menu

Menu Item	Description
Continue Normal Boot	The system attempts to boot to devices starting with the first item in the boot order. If the boot attempt fails, the system continues with the next item in the boot order until the boot is successful or no more boot options are found.
One Shot Boot Menu	Takes you to the boot menu, where you can select a one time boot device to boot from.
Launch System Setup	Enables you to access System Setup.
Launch Lifecycle Controller	Exits the Boot Manager and invokes the Lifecycle Controller program.
System Utilities	Launches System Utilities menu such as System Diagnostics and UEFI shell.

Changing the boot order

You may have to change the boot order if you want to boot from a USB key or an optical drive. The instructions given below may vary if you have selected **BIOS** for **Boot Mode**.

1. In the **System Setup Main Menu**, click **System BIOS** → **Boot Settings**.
2. Click **Boot Option Settings** → **Boot Sequence**.
3. Use the arrow keys to select a boot device, and use the <+> and <-> keys to move the device down or up in the order.
4. Click **Exit**, click **Yes** to save the settings on exit.

Choosing the system boot mode

System Setup enables you to specify the boot mode for installing your operating system:

- BIOS boot mode (the default) is the standard BIOS-level boot interface.
- Unified Extensible Firmware Interface (UEFI) boot mode is an enhanced 64-bit boot interface. If you have configured your system to boot to UEFI mode, it overlays the system BIOS.

To select the system **Boot Mode**:

1. In **System Setup** click **Boot Settings** and select **Boot Mode**.
2. Select the boot mode you want the system to boot into.

 **NOTE:** After the system boots in the specified boot mode, proceed to install your operating system from that mode.

 **CAUTION:** Trying to boot the operating system from the other boot mode will cause the system to halt at startup.

 **NOTE:** Operating systems must be UEFI-compatible to be installed from the UEFI boot mode. DOS and 32-bit operating systems do not support UEFI and can only be installed from the BIOS boot mode.

 **NOTE:** For the latest information on supported operating systems, go to dell.com/ossupport.

Assigning a system or setup password

Prerequisites

 **NOTE:** The password jumper enables or disables the System Password and Setup Password features. For more information on the password jumper settings, see "System board jumper settings".

You can assign a new **System Password** or **Setup Password** or change an existing **System Password** or **Setup Password** only when the password jumper setting is enabled and **Password Status** is set to **Unlocked**. If the Password Status is set to **Locked**, you cannot change the System Password or Setup Password.

If the password jumper setting is disabled, the existing System Password and Setup Password is deleted and you need not provide the system password to boot the system.

Steps

1. To enter **System Setup**, press F2 immediately after a power-on or reboot.
2. In the **System Setup Main Menu**, select **System BIOS** and press Enter.
The **System BIOS** screen is displayed.
3. In the **System BIOS** screen, select **System Security** and press Enter.
The **System Security** screen is displayed.
4. In the **System Security** screen, verify that **Password Status** is **Unlocked**.
5. Select **System Password**, enter your system password, and press Enter or Tab.
Use the following guidelines to assign the system password:
 - A password can have up to 32 characters.

- The password can contain the numbers 0 through 9.
- Only the following special characters are allowed: space, ("), (+), (.), (-), (.), (/), (:), (I), (\), (l), (').

A message prompts you to re-enter the system password.

6. Re-enter the system password and click **OK**.
7. Select **Setup Password**, enter your system password and press Enter or Tab.
A message prompts you to re-enter the setup password.
8. Re-enter the setup password click **OK**.
9. Press Esc to return to the System BIOS screen. Press Esc again, and a message prompts you to save the changes.

 **NOTE:** Password protection does not take effect until the system reboots.

Using your system password to secure your system

Prerequisites

 **NOTE:** If you have assigned a setup password, the system accepts your setup password as an alternate system password.

Steps

1. Turn on or reboot your system.
2. Type your password and press Enter.

Next steps

When **Password Status** is **Locked**, type the password and press Enter when prompted at reboot.

If an incorrect system password is entered, the system displays a message and prompts you to re-enter your password. You have three attempts to enter the correct password. After the third unsuccessful attempt, the system displays an error message that the system has halted and must be powered down.

Even after you shut down and restart the system, the error message is displayed until the correct password is entered.

 **NOTE:** You can use the **Password Status** option in conjunction with the **System Password** and **Setup Password** options to protect your system from unauthorized changes.

Deleting or changing an existing system password or setup password

Prerequisites

Ensure that the Password jumper is set to **enabled** and the **Password Status** is set to **Unlocked** before attempting to delete or change the existing System password or Setup password. You cannot delete or change an existing System password or Setup password if the **Password Status** is set to **Locked**.

Steps

1. To enter System Setup, press **F2** immediately after a power-on or restart.
2. In **System Setup Main Menu**, select **System BIOS** and press **Enter**.
The **System BIOS** screen is displayed.
3. In the **System BIOS** screen, select **System Security** and press **Enter**.
The **System Security** screen is displayed.

4. In the **System Security** screen, verify that **Password Status** is set to **Unlocked**.
5. Select **System Password**, change or delete the existing system password and press **Enter** or **Tab**.
6. Select **Setup Password**, change or delete the existing setup password and press **Enter** or **Tab**.
 -  **NOTE:** If you change the System password or Setup password, a message prompts you to re-enter the new password. If you delete the System password or Setup password, a message prompts you to confirm the deletion.
7. Press **Esc** to return to the System BIOS screen. Press **Esc** again, and a message prompts you to save the changes and exit.

Operating with a setup password enabled

If **Setup Password** is set to **Enabled**, enter the correct setup password before modifying most of the System Setup options.

If you do not enter the correct password in three attempts, the system displays the message

```
Incorrect Password! Number of unsuccessful password attempts: <x> System  
Halted! Must power down.
```

Even after you shut down and restart the system, the error message is displayed until the correct password is entered. The following options are exceptions:

- If **System Password** is not set to **Enabled** and is not locked through the **Password Status** option, you can assign a system password.
- You cannot disable or change an existing system password.

 **NOTE:** You can use the **Password Status** option in conjunction with the **Setup Password** option to protect the system password from unauthorized changes.

Embedded systems management

The Dell Lifecycle Controller provides advanced embedded systems management throughout the server's lifecycle. The Lifecycle Controller can be started during the boot sequence and can function independently of the operating system.

 **NOTE:** Certain platform configurations may not support the full set of features provided by the Lifecycle Controller.

For more information about setting up the Lifecycle Controller, configuring hardware and firmware, and deploying the operating system, see the Lifecycle Controller documentation at dell.com/support/home.

iDRAC Settings utility

The iDRAC Settings utility is an interface to set up and configure the iDRAC parameters using UEFI. You can enable or disable various iDRAC parameters using the iDRAC Settings utility, for example:

- Configure, enable, or disable the iDRAC local area network through the dedicated iDRAC Enterprise card port or the embedded NIC
- Enable or disable IPMI over LAN
- Enable a LAN Platform Event Trap (PET) destination
- Attach or detach the Virtual Media devices

For more information on using iDRAC, see the iDRAC User's Guide, at dell.com/esmmanuals.

Entering the iDRAC Settings utility

1. Turn on or restart the managed system.
2. Press <F2> during Power-on Self-test (POST).
3. In the **System Setup Main Menu** page, click **iDRAC Settings**.

The iDRAC Settings page is displayed.

Installing and removing sled components

This section provides information on installing and removing the sled components. For information on installing and removing the enclosure components, see the enclosure Owner's Manual at dell.com/poweredgemanuals.

Customer and field replaceable units

The following components are Customer Replaceable Units (CRUs):

- Cooling shroud
- PCIe mezzanine card
- Internal SD card
- SD vFlash card
- LAN on Motherboard riser card (LOM)
- System Memory
- Solid State Drive (SSD)
- SSD carrier
- SSD blank
- SSD backplane
- NVRAM backup battery
- Processor-and-DIMM blank
- Internal Dual SD Module card

The following components are Field Replaceable Units (FRUs). Removal and installation procedures should be performed only by Dell certified service technicians.

- Heatsink
- Processors
- System board

Safety instructions

 **CAUTION:** Many repairs may only be done by a certified service technician. You should only perform troubleshooting and simple repairs as authorized in your product documentation, or as directed by the online or telephone service and support team. Damage due to servicing that is not authorized by Dell is not covered by your warranty. Read and follow the safety instructions that came with the product.

 **NOTE:** It is recommended that you always use a static mat and static strap while working on components inside the system.



NOTE: To ensure proper operation and cooling, all bays in the system must be populated at all times with either a system component or with a blank.

Before working inside your system

1. Turn off the sled using the CMC.
2. Remove the sled from the enclosure.
3. Install the I/O connector cover.

After working inside your system

1. Install the sled in the enclosure.
2. Turn on the sled.

Recommended tools

You need the following items to perform the procedures in this section:

- #1 and #2 Phillips screwdrivers
- 4 mm and 5 mm Hex nut drivers
- Wrist grounding strap

Removing and installing a sled



CAUTION: Many repairs may only be done by a certified service technician. You should only perform troubleshooting and simple repairs as authorized in your product documentation, or as directed by the online or telephone service and support team. Damage due to servicing that is not authorized by Dell is not covered by your warranty. Read and follow the safety instructions that came with the product.

Removing a sled

Prerequisites

1. Ensure that you read the [Safety instructions](#).
2. Follow the procedure listed in [Before working inside your system](#).

Steps

1. Turn off the sled.



NOTE: When a sled is turned off, the front-panel power indicator is OFF.

2. Press the release button on the sled handle and rotate the sled handle away from the sled to disengage the sled from the interposer connectors.
3. Slide the sled out of the enclosure.



CAUTION: If you are permanently removing the sled, install a sled blank. Operating the system for extended periods of time without a sled blank installed can cause the enclosure to overheat.

 **NOTE:** For more information on the interposer connections, refer to the *Dell PowerEdge FX2 and FX2s Enclosure Owner's Manual* at dell.com/poweredgemanuals.

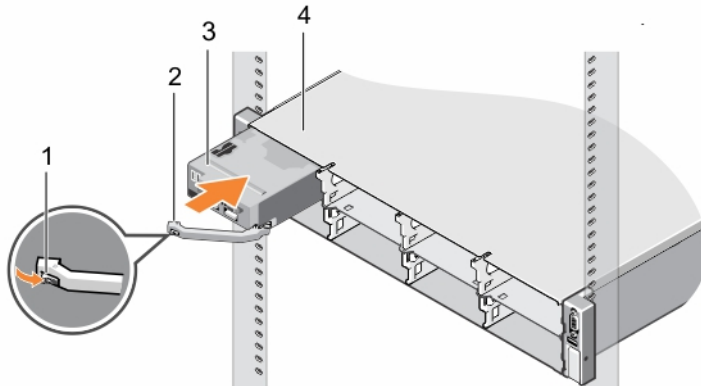

Figure 5. Removing and installing a sled

- | | |
|-------------------|--------------------------|
| 1. release button | 2. sled handle |
| 3. sled | 4. FX2 or FX2s enclosure |

Next steps

1. Follow the procedure listed in [After working inside your system](#).

Installing a sled

1. Press the release button on the sled handle to the open position.
2. Align the sled with the bay on the enclosure.
3. Slide the sled into the enclosure until the sled connectors are firmly engaged with the interposer connectors.
The sled handle rotates toward the enclosure as the sled slides into the enclosure.
4. Press the sled handle to closed position until the release button clicks into place.
5. Turn on the sled.

Inside the sled

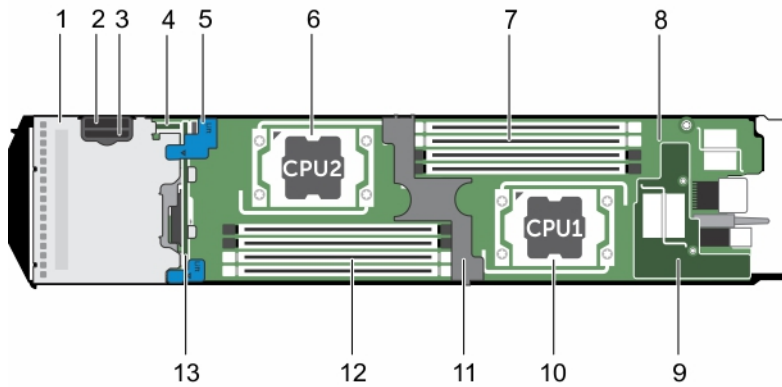

Figure 6. Inside the sled

- | | |
|---------------------------------|--------------------------------------|
| 1. SSD cage | 2. vFlash/SD card multifunction slot |
| 3. SD card slot | 4. IDSDM card |
| 5. SSD backplane touch points | 6. processor 2 |
| 7. memory modules (processor 1) | 8. system board |
| 9. LAN on Motherboard riser | 10. processor 1 |
| 11. cooling shroud | 12. memory modules (processor 2) |
| 13. SSD backplane | |

Cooling shroud

Your system includes a cooling shroud that ensures optimum airflow over the memory modules and processor(s). You can remove and install the cooling shroud.

Removing the cooling shroud

Prerequisites

CAUTION: Many repairs may only be done by a certified service technician. You should only perform troubleshooting and simple repairs as authorized in your product documentation, or as directed by the online or telephone service and support team. Damage due to servicing that is not authorized by Dell is not covered by your warranty. Read and follow the safety instructions that came with the product.

CAUTION: Never operate your system with the cooling shroud removed. The system may get overheated quickly, resulting in shutdown and loss of data.

1. Ensure that you read the [Safety instructions](#).
2. Follow the procedure listed in [Before working inside your system](#).

Steps

Hold both the finger hold points on the cooling shroud and lift the shroud away from the system.

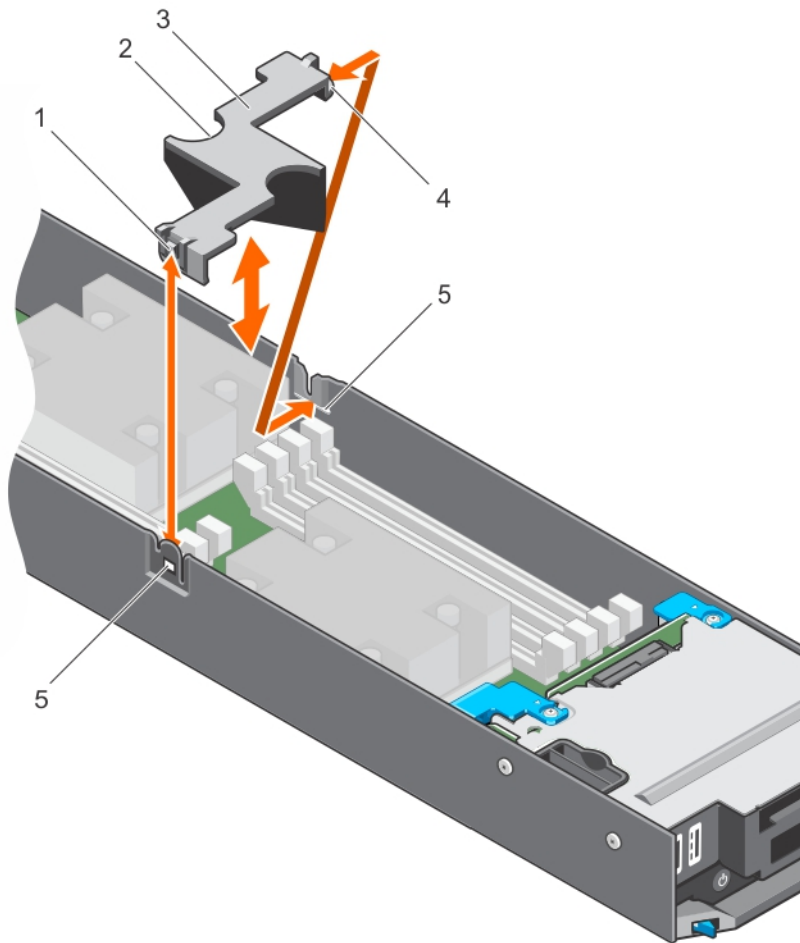

Figure 7. Removing and installing a cooling shroud

- | | |
|---|-------------------------|
| 1. cooling shroud latch | 2. finger hold points |
| 3. cooling shroud | 4. cooling shroud guide |
| 5. cooling shroud guide slot on chassis | |

Next steps

1. Install the cooling shroud.
2. Follow the procedure listed in [After working inside your system.](#)

Related Links

[Installing the cooling shroud](#)

Installing the cooling shroud

Prerequisites

 **CAUTION:** Many repairs may only be done by a certified service technician. You should only perform troubleshooting and simple repairs as authorized in your product documentation, or as directed by the online or telephone service and support team. Damage due to servicing that is not authorized by Dell is not covered by your warranty. Read and follow the safety instructions that came with the product.

 **NOTE:** You must remove the cooling shroud to service other components inside the system.

1. Ensure that you read the [Safety instructions](#).
2. Follow the procedure listed in [Before working inside your system](#).

Steps

1. Align the cooling shroud guide with the guide slot on the chassis.
2. Press the cooling shroud into the system until the release latch engages with the slot on the chassis and clicks into place.

Next steps

Follow the procedure listed in [After working inside your system](#).

System memory

Your system supports DDR4 registered DIMMs (RDIMMs), load reduced DIMMs (LRDIMMs) and DDR4 voltage specifications.

 **NOTE:** MT/s indicates DIMM speed in MegaTransfers per second.

Memory bus operating frequency can be 2133 MT/s, 1866 MT/s, 1600 MT/s, or 1333 MT/s depending on:

- System profile selected (for example, Performance Optimized, Custom, or Dense Configuration Optimized)
- Maximum supported DIMM frequency of the processors

The system contains eight memory sockets split into two sets of four sockets, one set per processor. DIMMs in sockets A1 to A4 are assigned to processor 1 and DIMMs in sockets B1 to B4 are assigned to processor 2. The server supports one DIMM per channel. In each four socket set, the release levers of the first-to-populate socket are marked white and those of the second socket are marked black. The DIMM sockets A3, A4, B3 and B4 need to have the memory module inserted 180 ° reverse with regard to the DIMMS in the A1, A2 and B1, B2 sockets.

The following table shows the memory populations and operating frequencies for the supported configurations.

Table 1. Memory population – operating frequency for supported configuration

DIMM Type	DIMMs Populated Per Channel	Operating Frequency (in MT/s) For 1.2 V	Maximum DIMM Rank Per Channel
RDIMM	1	2133, 1866, 1600, 1333	Single rank
			Dual rank

DIMM Type	DIMMs Populated Per Channel	Operating Frequency (in MT/s) For 1.2 V	Maximum DIMM Rank Per Channel
		2133, 1866, 1600, 1333	
LRDIMM	1	2133, 1866, 1600, 1333	Quad rank

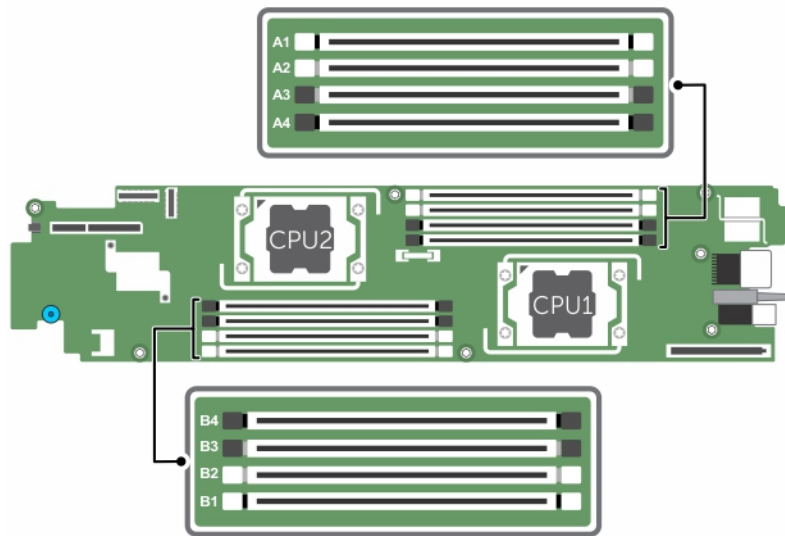

Figure 8. Memory socket locations

Memory channels are organized as follows:

Processor 1	channel 0: slot A2
	channel 1: slot A1
	channel 2: slot A3
	channel 3: slot A4
Processor 2	channel 0: slot B2
	channel 1: slot B1
	channel 2: slot B3
	channel 3: slot B4

General memory module installation guidelines

Your system supports Flexible Memory Configuration, enabling you to configure and run the system any valid chipset architectural configuration. The following are the recommended guidelines for best performance:

- LRDIMMs and RDIMMs must not be mixed.
- x4 and x8 DRAM based DIMMs can be mixed. For more information, see [Mode-specific guidelines](#).
- Single or dual-rank RDIMMs can be populated per channel.

- Populate DIMM sockets only if a processor is installed. For single-processor systems, sockets A1 to A4 are available. For dual-processor systems, sockets A1 to A4 and sockets B1 to B4 are available.
- Populate all sockets with white release tabs first and then populate the sockets with black release tabs.
- Populate the sockets by highest capacity DIMM in the following order - first-in-sockets with white release tabs and then black. For example, if you want to mix 16 GB and 8 GB DIMMs, populate 16 GB DIMMs in the sockets with white release tabs and 8 GB DIMMs in the sockets with black release tabs.
- In a dual-processor configuration, the memory configuration for each processor must be identical. For example, if you populate socket A1 for processor 1, then populate socket B1 for processor 2.
- DIMMs of different sizes can be mixed provided other memory population rules are followed (for example, 4 GB and 8 GB memory modules can be mixed).
- The memory module for DIMM sockets A3, A4, B3, and B4 need to be inserted 180 ° reverse with regard to the DIMMs in the sockets A1, A2, B1, and B2.
- Follow the mode-specific guidelines to maximize performance. For more information, see [Mode-specific guidelines](#).

Table 2. Heat sink — processor configurations

Processor configuration	Processor type (in Watts)	Heat sink width	Number of DIMMs	
			Maximum system capacity	Reliability, Availability, and Serviceability (RAS) features
Single processor	120 W or 140 W	68 mm	4	4
Dual processor	120 W	68 mm	8	8

Mode-specific guidelines

Four memory channels are allocated to each processor. The allowable configurations depend on the memory mode selected.

 **NOTE:** x4 and x8 DRAM based DIMMs can be mixed providing support for RAS features. However, all guidelines for specific RAS features must be followed. x4 DRAM based DIMMs retain Single Device Data Correction (SDDC) in memory optimized (independent channel) mode. x8 DRAM based DIMMs require Advanced ECC mode to gain SDDC.

The following sections provide additional slot population guidelines for each mode.

Advanced ECC (Lockstep)

Advanced ECC mode extends SDDC from x4 DRAM based DIMMs to both x4 and x8 DRAMs. This protects against single DRAM chip failures during normal operation.

Memory installation guidelines:

- Memory modules must be identical in size, speed, and technology.
- DIMMs installed in memory sockets with white release tabs must be identical and similar rule applies for sockets with black release tabs. This ensures that identical DIMMs are installed in matched pairs - for example, A1 with A2, A3 with A4 and so on.



Processor	Configuration	Memory population rules	Memory population information
Single CPU	Advanced ECC (Lockstep)	{1,2},{3,4}	Numbers inside the brackets indicate the slots that must be

Processor	Configuration	Memory population rules	Memory population information
Dual CPU	Advanced ECC (Lockstep)	C1{1,2}, C2{1,2}, C1{3,4}, C2{3,4} ...	populated in pairs, odd amount of pairs allowed. Numbers inside the brackets indicate the slots that must be populated in pairs, odd amount of pairs allowed.
 NOTE:	Populate round robin starting with CPU1		

Memory optimized (independent channel) mode

This mode supports Single Device Data Correction (SDDC) only for memory modules that use x4 device width. It does not impose any specific slot population requirements.

Memory installation guidelines:

Processor	Configuration	Memory population rules	Memory population information
Single CPU	Optimized (independent channel)	1, 2, 3, 4	Populate in this order, odd amount of DIMMs per CPU allowed.
 NOTE:	Optimized mode permits unbalanced configurations, eg, 1:1:1:0 DIMM per channel (DPC) combinations.		
Dual CPU	Optimized (independent channel)	C1{1}, C2{1}, C1{2}, C2{2}, C1{3}, C2{3}...	Populate in this order, odd amount of DIMMs per CPU allowed.
 NOTE:	Populate round robin starting with CPU1:		
 NOTE:	Optimized mode permits unbalanced configurations, eg, 2:1:1:1 DPC combinations.		

Memory mirroring

Memory Mirroring offers the strongest DIMM reliability mode compared to all other modes, providing improved uncorrectable multi-bit failure protection. In a mirrored configuration, the total available system memory is one half of the total installed physical memory. Half of the installed memory is used to mirror the active DIMMs. In the event of an uncorrectable error, the system switches over to the mirrored copy. This ensures SDDC and multi-bit protection.

Memory installation guidelines:

- Memory modules must be identical in size, speed, and technology.
- DIMMs installed in memory sockets with white release tabs must be identical and similar rule applies for sockets with black release tabs. This ensures that identical DIMMs are installed in matched pairs - for example, A1 with A2, A3 with A4.

 **NOTE:** Mirroring and Advanced ECC modes require minimum of two DIMMs per CPU and must be populated in pairs of either two or four DIMMs per CPU.

Processor	Configuration	Memory population rules	Memory population information
Single CPU	Mirroring population order.	{1,2},{3,4}	See Mirroring note.

Sample memory configurations

The following tables show sample memory configurations that follow the appropriate memory guidelines stated in this section.

 **NOTE:** 1R, 2R, and 4R in the following tables indicate single-, dual-, and quad-rank DIMMs respectively.

Table 3. Memory configurations – single processor



System Capacity (in GB)	DIMM Size (in GB)	Number of DIMMs	Organization and Speed	DIMM Slot Population
4	4	1	1R x8, 2133 MT/s	A1
8	4	2	1R x8, 2133 MT/s	A1, A2
8	8	1	2R x4, 2133 MT/s	A1
16	4	4	1R x8, 2133 MT/s	A1, A2, A3, A4
16	8	2	2R x8 2133 MT/s	A1, A2
16	16	1	2R x4, 2133 MT/s	A1
32	8	4	2R x8 2133 MT/s	A1, A2, A3, A4
32	16	2	2R x4, 2133 MT/s	A1, A2
32	32	1	2R x4, 2133 MT/s	A1
32	32	1	4R x4, 2133 MT/s	A1
64	16	4	2R x4, 2133 MT/s	A1, A2, A3, A4
64	32	2	2R x4, 2133 MT/s	A1, A2
64	32	2	4R x4, 2133 MT/s	A1, A2
128	32	4	2R x4, 2133 MT/s	A1, A2, A3, A4
128	32	4	4R x4, 2133 MT/s	A1, A2, A3, A4

Table 4. Memory configurations – dual processor

System Capacity (in GB)	DIMM Size (in GB)	Number of DIMMs	Organization and Speed	DIMM Slot Population
8	4	2	1R x8, 2133 MT/s	A1, B1
16	4	4	1R x8, 2133 MT/s	A1, A2, B1, B2
16	8	2	2R x4, 2133 MT/s	A1, B1
32	4	8	1R x8, 2133 MT/s	A1, A2, A3, A4, B1, B2, B3, B4
32	8	4	2R x4, 2133 MT/s	A1, A2, B1, B2
32	16	2	2R x8 2133 MT/s	A1, B1
64	8	8	2R x4, 2133 MT/s	A1, A2, A3, A4, B1, B2, B3, B4
64	16	4	2R x8 2133 MT/s	A1, A2, B1, B2
64	32	2	2R x4, 2133 MT/s	A1, B1
64	32	2	4R x4, 2133 MT/s	A1, B1
128	16	8	2R x8 2133 MT/s	A1, A2, A3, A4, B1, B2, B3, B4
128	32	4	2R x4, 2133 MT/s	A1, A2, B1, B2
128	32	4	4R x4, 2133 MT/s	A1, A2, B1, B2
256	32	8	2R x4, 2133 MT/s	A1, A2, A3, A4, B1, B2, B3, B4
256	32	8	4R x4, 2133 MT/s	A1, A2, A3, A4, B1, B2, B3, B4

Removing memory modules

Prerequisites

-  **WARNING:** The memory modules are hot to touch for some time after the system has been powered down. Allow time for the memory modules to cool before handling them. Handle the memory modules by the card edges and avoid touching the components or metallic contacts on the memory module.
-  **CAUTION:** Many repairs may only be done by a certified service technician. You should only perform troubleshooting and simple repairs as authorized in your product documentation, or as directed by the online or telephone service and support team. Damage due to servicing that is not authorized by Dell is not covered by your warranty. Read and follow the safety instructions that came with the product.
-  **CAUTION:** To ensure proper system cooling, memory-module blanks must be installed in any memory socket that is not occupied. Remove memory-module blanks only if you intend to install memory modules in those sockets.

1. Ensure that you read the [Safety instructions](#).

2. Follow the procedure listed in [Before working inside your system](#).
3. Remove the cooling shroud.

Steps

1. Locate the appropriate memory module socket(s).
2. To release the memory module from the socket, simultaneously press the ejectors on both ends of the memory module socket.

⚠ CAUTION: Handle each memory module only by the card edges, making sure not to touch the middle of the memory module or metallic contacts.

3. Remove the memory module from the socket.

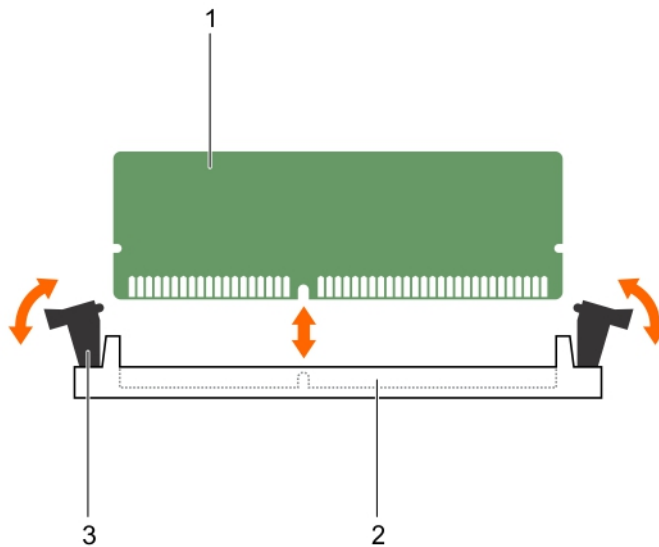

Figure 9. Removing the memory module

- | | |
|------------------------------|-------------------------|
| 1. memory module | 2. memory module socket |
| 3. memory module ejector (2) | |

Next steps

1. If you are removing the memory module permanently, install a memory-module blank.
2. Install the memory module.
3. Install the cooling shroud.
4. Follow the procedure listed in [After working inside your system](#).

Related Links

[Removing the cooling shroud](#)

[Installing memory modules](#)

[Installing the cooling shroud](#)

Installing memory modules

Prerequisites

 **WARNING:** The memory modules are hot to touch for some time after the system has been powered down. Allow time for the memory modules to cool before handling them. Handle the memory modules by the card edges and avoid touching the components or metallic contacts on the memory module.

 **CAUTION:** Many repairs may only be done by a certified service technician. You should only perform troubleshooting and simple repairs as authorized in your product documentation, or as directed by the online or telephone service and support team. Damage due to servicing that is not authorized by Dell is not covered by your warranty. Read and follow the safety instructions that came with the product.

 **NOTE:** You must remove a memory module to upgrade a memory module or replace a faulty memory module.

1. Ensure that you read the [Safety instructions](#).
2. Follow the procedure listed in [Before working inside your system](#).
3. Remove the cooling shroud.
4. If installed, remove the memory module or the memory module blank.

Steps

1. Locate the appropriate memory module socket.
2. Press the ejectors on the memory module socket outward to allow the memory module to be inserted into the socket.

 **CAUTION:** Handle each memory module only on either card edge, making sure not to touch the middle of the memory module.

3. Align the the memory module with the key on the socket and insert the memory module in the socket.

 **NOTE:** The memory module socket has an alignment key that allows you to install the memory module in the socket in only one direction.

 **CAUTION:** To prevent damage to the memory module socket during installation, apply pressure at both ends of the memory module evenly. Do not apply pressure to the center of the memory module.

4. Press the memory module with your thumbs to lock the memory module into the socket.

 **NOTE:** When the memory module is properly seated in the socket, the ejectors on the memory module socket align with the ejectors on the other sockets that have memory modules installed.

5. Repeat step 1 through step 4 of this procedure to install the remaining memory modules.

Next steps

1. Install the cooling shroud.
2. Follow the procedure listed in [After working inside your system](#).
3. (Optional) Press <F2> to enter System Setup, and check the **System Memory** setting.

The **System Memory Size** should reflect the installed memory

 **NOTE:** If the **System Memory Size** is incorrect, one or more of the memory modules may not be installed properly. Ensure that the memory modules are firmly seated in their sockets.

4. Run the system memory test in the system diagnostics.

Related Links

[Removing the cooling shroud](#)

[Installing the cooling shroud](#)

PCIe mezzanine card

The sled supports one x8 PCIe Gen3 mezzanine card. The PCIe card provides an interface between the sled and external storage devices.

 **NOTE:** Ensure that the PCIe mezzanine card is set to **Enabled** in System Setup.

 **NOTE:** The PCIe mezzanine card slot is available for use only when CPU2 is installed.

Removing the PCIe mezzanine card

Prerequisites

 **CAUTION:** Many repairs may only be done by a certified service technician. You should only perform troubleshooting and simple repairs as authorized in your product documentation, or as directed by the online or telephone service and support team. Damage due to servicing that is not authorized by Dell is not covered by your warranty. Read and follow the safety instructions that came with the product.

1. Ensure that you read the [Safety instructions](#).
2. Follow the procedure listed in [Before working inside your system](#).
3. If connected, disconnect all external storage devices.
4. If connected, disconnect all USB devices.
5. Remove the SSD cage.
6. Keep the Phillips #2 screwdriver ready.

Steps

1. To remove the SSD cage base cover:
 - a. Place the SSD cage upside down with the USB ports to your right.
 - b. Remove the screws securing the SSD cage base cover to the SSD cage.
 - c. Slide the SSD cage base cover back and lift the cover away from the SSD cage.

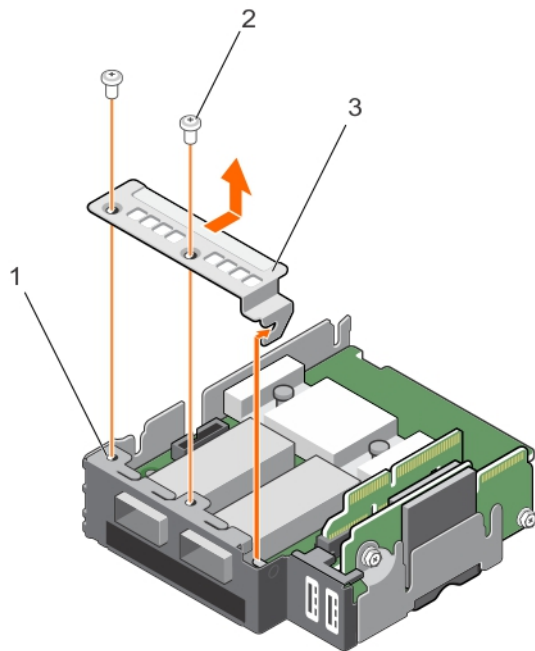

Figure 10. Removal of the SSD cage base cover

1. SSD cage
 2. screw (2)
 3. SSD cage base cover
2. To remove the PCIe mezzanine card:
- a. Remove the screws securing the PCIe mezzanine card to the SSD cage.
 - b. Slide the mezzanine card back and lift the card away from the SSD cage.
 - c. Remove the PCIe mezzanine card bridge and keep it aside for future use.

⚠ CAUTION: To prevent damage to the PCIe mezzanine card, you must hold the card only by its edges.

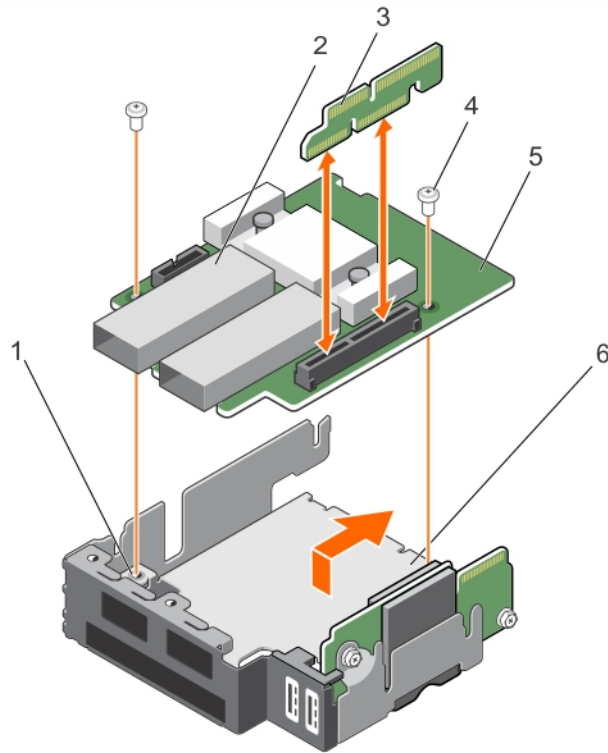

Figure 11. Removing and installing a PCIe mezzanine card

- | | |
|-------------------------------|-----------------------------------|
| 1. screw hole on SSD cage (2) | 2. external storage connector (2) |
| 3. PCIe mezzanine bridge card | 4. Screw (2) |
| 5. PCIe mezzanine card | 6. SSD cage |

Next steps

1. Install the PCIe mezzanine card.
2. Install the SSD cage.
3. If applicable, reconnect the disconnected storage devices.
4. If applicable, reconnect the disconnected USB devices.
5. Follow the procedure listed in [After working inside your system](#).

Related Links

- [Removing the SSD cage](#)
- [Installing the PCIe mezzanine card](#)
- [Installing the SSD cage](#)

Installing the PCIe mezzanine card

Prerequisites

 **CAUTION:** Many repairs may only be done by a certified service technician. You should only perform troubleshooting and simple repairs as authorized in your product documentation, or as directed by the online or telephone service and support team. Damage due to servicing that is not authorized by Dell is not covered by your warranty. Read and follow the safety instructions that came with the product.

 **NOTE:** You must remove the PCIe mezzanine card to replace a faulty PCIe mezzanine card.

1. Ensure that you read the [Safety instructions](#).
2. Follow the procedure listed in [Before working inside your system](#).
3. If connected, disconnect all external storage devices.
4. If connected, disconnect all USB devices.
5. Remove the SSD cage.
6. Remove the PCIe mezzanine card.
7. Keep the Phillips #2 screwdriver ready.

Steps

1. To install the PCIe mezzanine card:
 - a. Place the SSD cage upside down with the USB ports to your right.
 - b. Slide the PCIe mezzanine card on to the SSD cage.
 - c. Secure the card in place with the screws.
 - d. Install the PCIe mezzanine card bridge.

 **CAUTION:** To prevent damage to the PCIe mezzanine card, you must hold the card only by its edges.

2. To install the SSD cage base cover :
 - a. Slide the SSD cage base cover into place.
 - b. Secure the SSD cage base cover to the SSD cage.
3. Align the guide slots on the SSD cage with the guide pins on the chassis.
4. Press down the SSD cage till the connectors on the SSD cage completely engage with the corresponding connectors on the system board.

Next steps

1. Install the SSD cage.
2. If applicable, reconnect the disconnected storage devices.
3. If applicable, reconnect the disconnected USB devices.
4. Follow the procedure listed in [After working inside your system](#).

Related Links

[Removing the SSD cage](#)

[Removing the PCIe mezzanine card](#)

[Installing the SSD cage](#)

Internal Dual SD Module (IDSDM) card

The IDSDM card provides one SD card slot, one vFlash card slot and a shared USB interface for the embedded hypervisor. This card offers the following features:

- Single card operation — single card operation is supported, but without redundancy.
- Dual card operation — dual card operation is supported and can be configured with redundancy.

 **NOTE:** When the Redundancy option is set to Mirror Mode in the Integrated Devices screen of the System Setup, the information is replicated from one SD card to another.

Removing an internal SD card

Prerequisites

 **CAUTION:** Many repairs may only be done by a certified service technician. You should only perform troubleshooting and simple repairs as authorized in your product documentation, or as directed by the online or telephone service and support team. Damage due to servicing that is not authorized by Dell is not covered by your warranty. Read and follow the safety instructions that came with the product.

1. Ensure that you read the [Safety instructions](#).
2. Follow the procedure listed in [Before working inside your system](#).
3. Enter System Setup and ensure that the **Internal SD Card Port** is enabled.

 **NOTE:** When an SD card failure occurs, on the next reboot, the system displays a message indicating the failure.

Steps

1. Locate the SD card slot on the internal dual SD module (IDSDM) card.
2. Press the card to release it from the slot and remove the card.

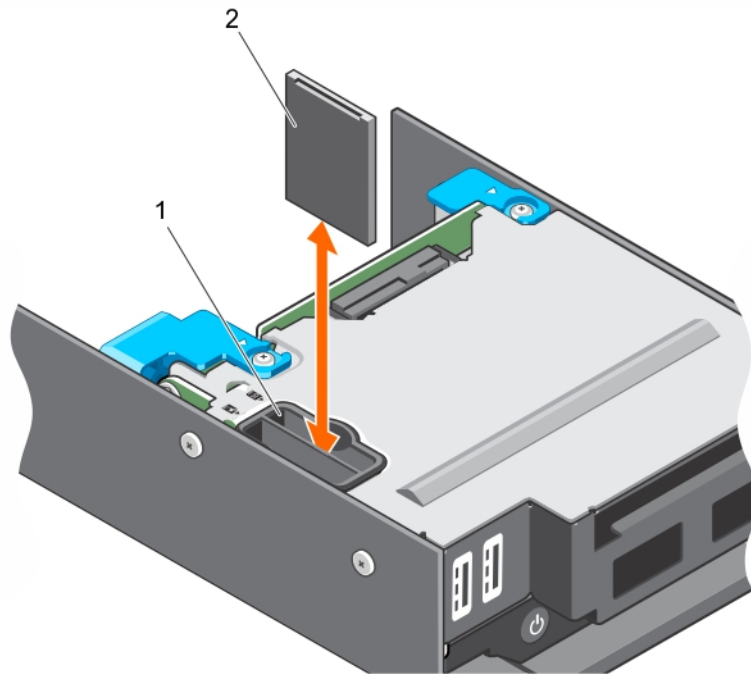

Figure 12. Replacing an internal SD card

1. SD card slot
2. SD card

Next steps

1. Follow the procedure listed in [After working inside your system](#).
2. Enter System Setup and ensure that the **Internal SD Card Port** is enabled.
3. Check if the new SD card is functioning properly. If the problem persists, see [Troubleshooting an internal SD card](#).

Installing an internal SD card

Prerequisites

1. Ensure that you read the [Safety instructions](#).
2. Follow the procedure listed in [Before working inside your system](#).
3. If applicable, remove the SD card.

CAUTION: Many repairs may only be done by a certified service technician. You should only perform troubleshooting and simple repairs as authorized in your product documentation, or as directed by the online or telephone service and support team. Damage due to servicing that is not authorized by Dell is not covered by your warranty. Read and follow the safety instructions that came with the product.

NOTE: To use an SD card with your system, ensure that the **Internal SD Card Port** is enabled in System Setup.

Steps

1. Locate the SD card connector on the internal dual SD module. Align the keyed end of the SD card into the slot and insert the card into the slot

 **NOTE:** The slot is keyed to ensure correct insertion of the card.

2. Press the card into the card slot to lock it into place.

Next steps

1. Follow the procedure listed in [After working inside your system](#).
2. Enter System Setup and ensure that the **Internal SD Card Port** is enabled.
3. Check if the new SD card is functioning properly. If the problem persists, see [Troubleshooting an internal SD card](#).

Related Links

[Removing an internal SD card](#)

Removing the IDSDM card

Prerequisites

 **CAUTION:** Many repairs may only be done by a certified service technician. You should only perform troubleshooting and simple repairs as authorized in your product documentation, or as directed by the online or telephone service and support team. Damage due to servicing that is not authorized by Dell is not covered by your warranty. Read and follow the safety instructions that came with the product.

1. Ensure that you read the [Safety instructions](#).
2. Follow the procedure listed in [Before working inside your system](#).
3. If connected, disconnect all USB devices.
4. If installed, remove the SD card(s).
5. Remove the SSD cage.
6. Keep the Phillips #2 screwdriver ready.

Steps

1. Remove the screws securing the IDSDM card to the SSD cage.
2. Lift the IDSDM card till it disengages from the standoff and slide the IDSDM card away out of the SSD cage.

 **CAUTION:** To prevent damage to the IDSDM card, you must hold the card only by its edges.

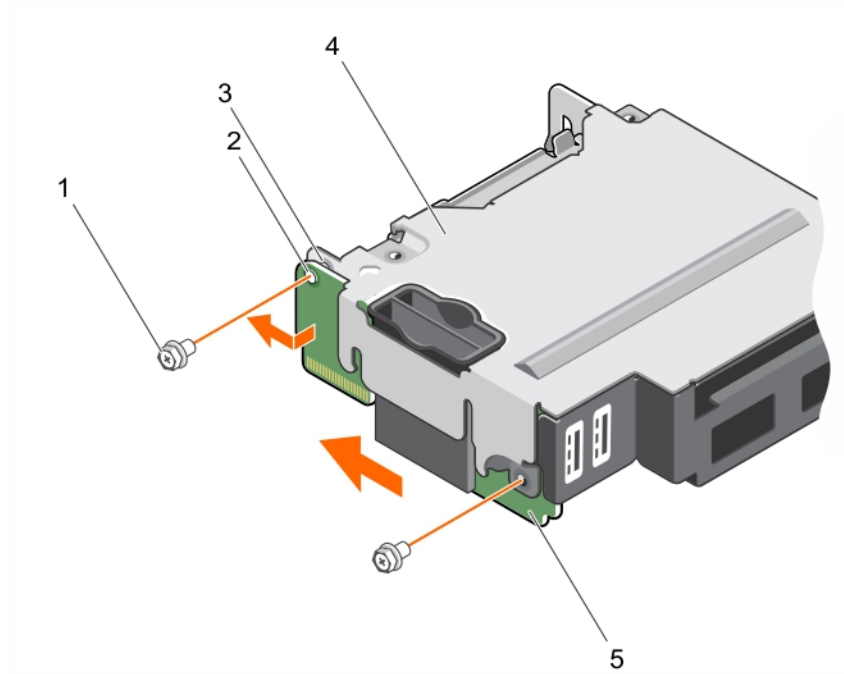

Figure 13. Removing and installing the IDSDM card

- | | |
|-----------------|-------------------|
| 1. screw (2) | 2. screw hole (2) |
| 3. standoff (1) | 4. SSD cage |
| 5. IDSDM card | |

Next steps

1. Install the SSD cage.
2. Install the IDSDM card.
3. If applicable, install the SD cards.
4. Reconnect any disconnected USB devices.
5. Follow the procedure listed in [After working inside your system.](#)

Related Links

- [Removing an internal SD card](#)
- [Removing the SSD cage](#)
- [Installing the SSD cage](#)
- [Installing the IDSDM card](#)
- [Installing an internal SD card](#)

Installing the IDSDM card

Prerequisites

 **CAUTION:** Many repairs may only be done by a certified service technician. You should only perform troubleshooting and simple repairs as authorized in your product documentation, or as directed by the online or telephone service and support team. Damage due to servicing that is not authorized by Dell is not covered by your warranty. Read and follow the safety instructions that came with the product.

 **NOTE:** You must remove the IDSDM card to replace a faulty IDSDM card.

1. Ensure that you read the [Safety instructions](#).
2. Follow the procedure listed in [Before working inside your system](#).
3. Remove the SD card.
4. Disconnect any connected USB devices.
5. Remove the SSD cage.
6. Remove the IDSDM card.
7. Keep the Phillips #2 screwdriver ready.

 **CAUTION:** To prevent damage to the IDSDM card, you must hold the card only by its edges.

Steps

1. Slide the IDSDM card into the slot on the SSD cage.
2. Align the IDSDM card with the standoff on the SSD cage and the USB port slots on the front panel.
3. Secure the IDSDM card to the SSD cage with the screws.

Next steps

1. Install the SSD cage.
2. If applicable, install the SD card(s).
3. If applicable, reconnect any disconnected USB devices.
4. Follow the procedure listed in [After working inside your system](#).

Related Links

[Removing an internal SD card](#)

[Removing the SSD cage](#)

[Removing the IDSDM card](#)

[Installing the SSD cage](#)

[Installing an internal SD card](#)

SD vFlash card

You can use an SD vFlash card with your system. The card slot is located on the IDSDM card. You can remove and install the SD vFlash card

Replacing the SD vFlash card

Prerequisites

⚠ CAUTION: Many repairs may only be done by a certified service technician. You should only perform troubleshooting and simple repairs as authorized in your product documentation, or as directed by the online or telephone service and support team. Damage due to servicing that is not authorized by Dell is not covered by your warranty. Read and follow the safety instructions that came with the product.

1. Ensure that you read the [Safety instructions](#).
2. Follow the procedure listed in [Before working inside your system](#).
3. If installed, remove the SD vFlash card from the card slot.

Steps

1. Insert the contact-pin end of the SD card into the card slot on the IDSDM card.

🔑 NOTE: The slot is keyed to ensure correct insertion of the card.

2. Press the card into the card slot to lock it into place.

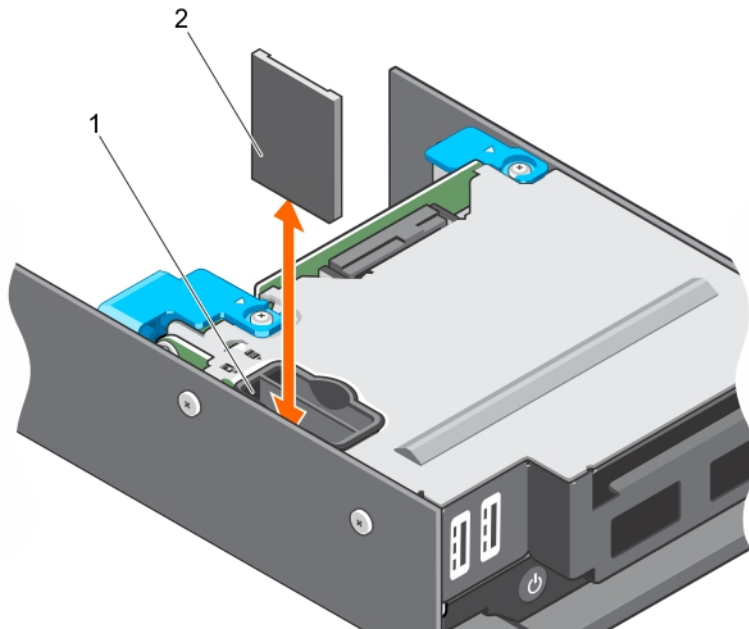

Figure 14. Replacing the SD vFlash card

1. SD vFlash slot

2. SD vFlash card

Next steps

Follow the procedure listed in [After working inside your system](#).

Installing the SD vFlash card

Prerequisites

1. Ensure that you read the [Safety instructions](#).
2. Follow the procedure listed in [Before working inside your system](#).

 **CAUTION:** Many repairs may only be done by a certified service technician. You should only perform troubleshooting and simple repairs as authorized in your product documentation, or as directed by the online or telephone service and support team. Damage due to servicing that is not authorized by Dell is not covered by your warranty. Read and follow the safety instructions that came with the product.

 **NOTE:** To use an SD card with your system, ensure that the **Internal SD Card Port** is enabled in System Setup.

Steps

1. Locate the SD card connector on the internal dual SD module. Align the SD card appropriately and insert the contact-pin end of the card into the slot.

 **NOTE:** The slot is keyed to ensure correct insertion of the card.

2. Press the card into the card slot to lock it into place.

Next steps

1. Follow the procedure listed in [After working inside your system](#).

LAN on Motherboard (LOM) riser card

The LOM riser card installed in your system is an integrated network interface controller. You can remove and install the LOM riser card.

Removing the LOM riser card

Prerequisites

 **CAUTION:** Many repairs may only be done by a certified service technician. You should only perform troubleshooting and simple repairs as authorized in your product documentation, or as directed by the online or telephone service and support team. Damage due to servicing that is not authorized by Dell is not covered by your warranty. Read and follow the safety instructions that came with the product.

1. Ensure that you read the [Safety instructions](#).
2. Follow the procedure listed in [Before working inside your system](#).
3. Keep the Phillips #2 screwdriver ready.

Steps

1. Remove the two screws that secure the LOM riser card to the system board.
2. Lift the card from the system board.

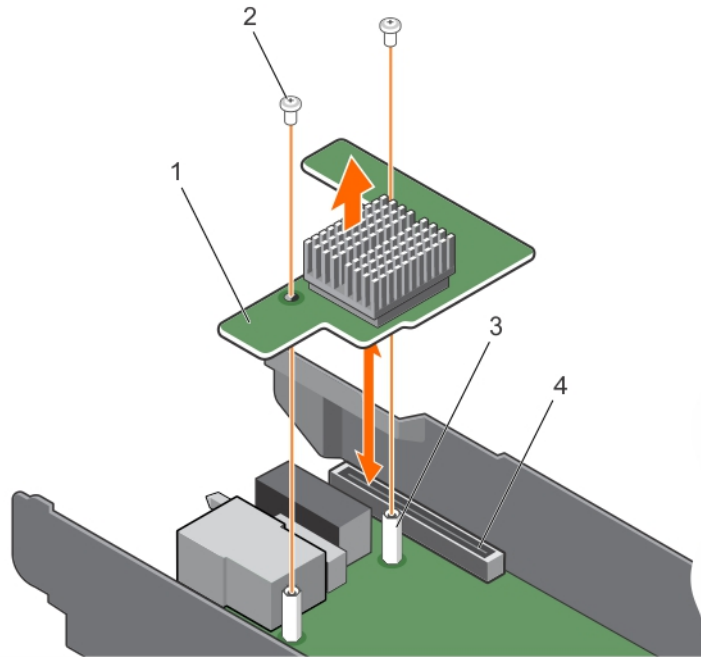

Figure 15. Removing and installing the LOM riser card

- | | |
|-------------------|----------------------------------|
| 1. LOM riser card | 2. screw (2) |
| 3. standoff (2) | 4. connector on the system board |

Next steps

1. Install the LOM riser card.
2. Follow the procedure listed in [After working inside your system](#).

Related Links

[Installing the LOM riser card](#)

Installing the LOM riser card

Prerequisites

⚠ CAUTION: Many repairs may only be done by a certified service technician. You should only perform troubleshooting and simple repairs as authorized in your product documentation, or as directed by the online or telephone service and support team. Damage due to servicing that is not authorized by Dell is not covered by your warranty. Read and follow the safety instructions that came with the product.

✍ NOTE: You must remove the LOM riser card to replace a faulty LOM riser card or service other components inside the system.

1. Ensure that you read the [Safety instructions](#).
2. Follow the procedure listed in [Before working inside your system](#).
3. Keep the Phillips #2 screwdriver ready.

Steps

1. Align the screw holes on the card with the standoffs on the system board.

 **CAUTION:** To prevent damage to the LOM riser card, you must hold the card only by its edges.

2. Press the card into place until the card connector fits into the corresponding connector on the system board.
3. Secure the card with the two screws.

Next steps

Follow the procedure listed in [After working inside your system](#).

Processors

Your system supports up to two Intel Haswell EP product family processors.

 **NOTE:** The sled supports processors with the wattages listed below:

- Up to two 120 W processors are supported.
- A single 140 W processor is supported.

 **NOTE:** Mixing processors of different wattages is not supported.

Use the following procedure when:

- Installing an additional processor.
- Replacing a processor.

Removing a heat sink

Prerequisites

 **CAUTION:** Many repairs may only be done by a certified service technician. You should only perform troubleshooting and simple repairs as authorized in your product documentation, or as directed by the online or telephone service and support team. Damage due to servicing that is not authorized by Dell is not covered by your warranty. Read and follow the safety instructions that came with the product.

 **NOTE:** This is a Field Replaceable Unit (FRU). Removal and installation procedures should be performed only by Dell certified service technicians.

 **CAUTION:** Never remove the heat sink from a processor unless you intend to remove the processor. The heat sink is necessary to maintain proper thermal conditions.

 **NOTE:** To ensure proper system cooling, you must install a processor blank in any empty processor socket.

1. Ensure that you read the [Safety instructions](#).
2. Follow the procedure listed in [Before working inside your system](#).
3. Remove the cooling shroud.
4. Keep the Phillips #2 screwdriver ready.

 **WARNING:** The heat sink will be hot to touch for some time after the system has been powered down. Allow the heat sink to cool before removing it.

Steps

1. To remove a 120 W heat sink, perform the following steps.
 - a. Loosen one of the screws that secure the heat sink to the system board.
Wait 30 seconds for the heat sink to loosen from the processor.
 - b. Remove the screw diagonally opposite the screw you first removed.
 - c. Repeat the procedure for the remaining two screws.

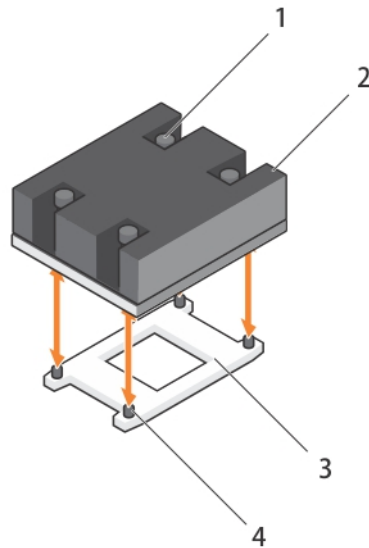

Figure 16. Removing and installing the 120 W heat sink

- | | |
|----------------------|-------------------|
| 1. captive screw (4) | 2. heat sink |
| 3. processor socket | 4. screw hole (4) |
2. To remove a 140 W heat sink, perform the following steps.
 - a. Loosen one of the screws that secure the heat sink over CPU 1 to the system board.
Wait 30 seconds for the heat sink to loosen from the processor.
 - b. Remove the screw diagonally opposite the screw you first removed.
 - c. Repeat the procedure for the remaining four screws.

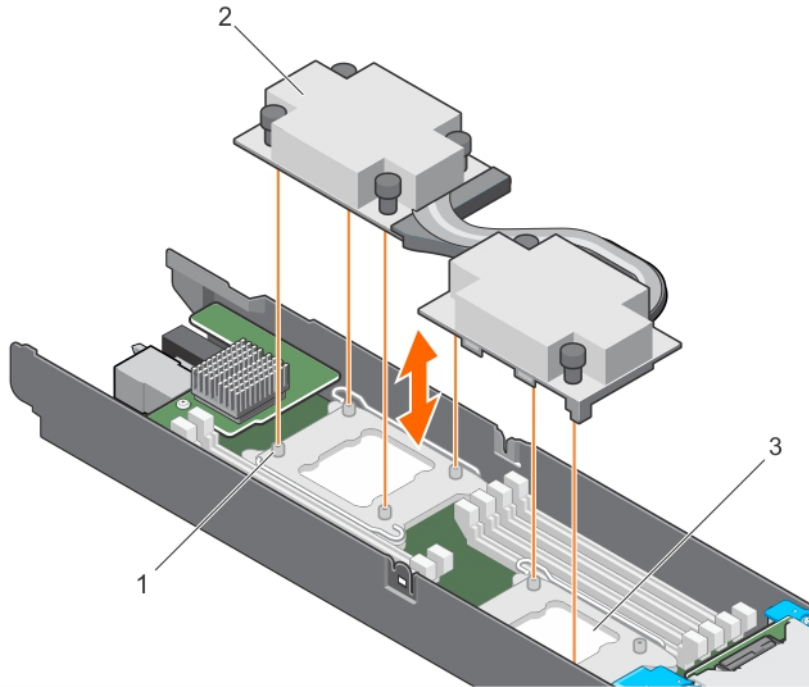

Figure 17. Removing and installing the 140 W heat sink

- | | |
|-------------------------|--------------|
| 1. screw hole (6) | 2. heat sink |
| 3. processor socket (2) | |

Next steps

1. Remove the processor.

Related Links

- [Removing the cooling shroud](#)
- [Removing a processor](#)

Removing a processor

Prerequisites

- ⚠ **CAUTION:** Many repairs may only be done by a certified service technician. You should only perform troubleshooting and simple repairs as authorized in your product documentation, or as directed by the online or telephone service and support team. Damage due to servicing that is not authorized by Dell is not covered by your warranty. Read and follow the safety instructions that came with the product.
- 🔧 **NOTE:** This is a Field Replaceable Unit (FRU). Removal and installation procedures should be performed only by Dell certified service technicians.
- ⚠ **WARNING:** The processor will be hot to touch for some time after the system has been powered down. Allow the processor to cool before removing it.
- ⚠ **CAUTION:** The processor is held in its socket under strong pressure. Be aware that the release lever can spring up suddenly if not firmly grasped.

 **NOTE:** To ensure proper system cooling, you must install a processor blank in any empty processor socket.

1. Ensure that you read the [Safety instructions](#).
2. Follow the procedure listed in [Before working inside your system](#).
3. If you are upgrading your system (from a single processor system to a dual processor system or a processor with a higher processor bin), download the latest system BIOS version from dell.com/support and follow the instructions included in the compressed download file to install the update on your system.

 **NOTE:** You can update the system BIOS by using Lifecycle Controller.

4. Remove the cooling shroud.
5. Remove the heat sink.
6. Keep the Phillips #2 screwdriver ready.

Steps

1. Using a clean, lint-free cloth remove any thermal grease from the surface of the processor shield.

 **CAUTION:** The processor is held in its socket under strong pressure. Be aware that the release lever can spring up suddenly if not firmly grasped.

2. Position your thumb firmly over the socket-release lever 1 and lever 2 of the processor and release both the levers simultaneously from the locked position by pushing down and out from under the tab.

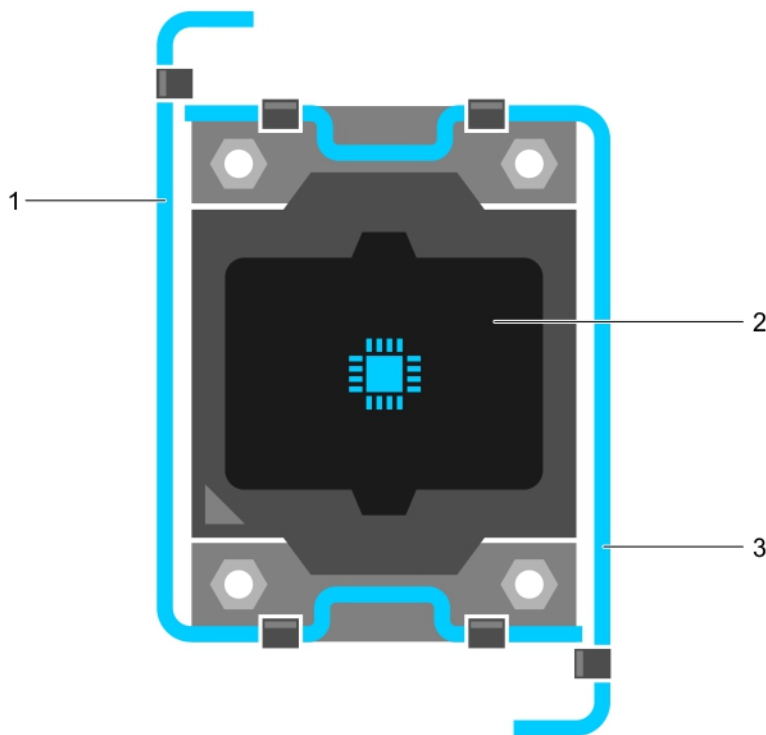

Figure 18. Processor shield opening and closing lever sequence

1. socket-release lever 1
2. processor

3. socket-release lever 2
3. Hold the tab on the processor shield and rotate the shield upward and out of the way.
4. Lift the processor out of the socket and leave the release lever up so that the socket is ready for the new processor.

△ CAUTION: If you are permanently removing a processor, you must install a socket protective cap and a processor blank in the vacant socket to ensure proper system cooling. The processor blank covers the vacant sockets for the DIMMs and the processor.

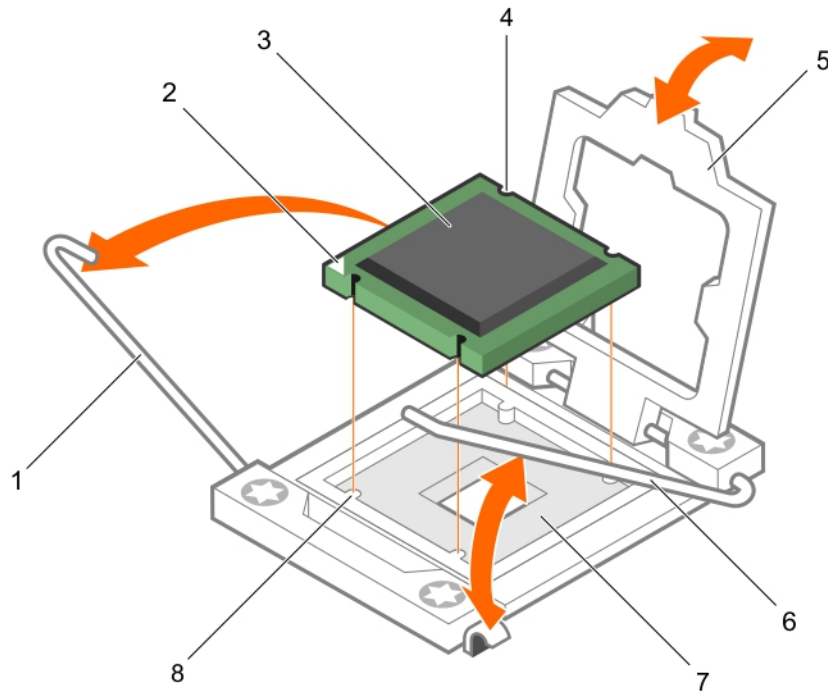

Figure 19. Installing and removing a processor

- | | |
|---------------------------|----------------------------------|
| 1. socket-release lever 1 | 2. pin-1 corner of the processor |
| 3. processor | 4. slot (4) |
| 5. processor shield | 6. socket-release lever 2 |
| 7. processor socket | 8. tab (4) |

Next steps

1. If you are removing the processor permanently, install the processor-and-DIMM blank.
2. Install a new processor.
3. Install the heat sink.
4. Follow the procedure listed in [After working inside your system](#).

Related Links

- [Removing the cooling shroud](#)
- [Removing a heat sink](#)
- [Installing a processor-and-DIMM blank](#)
- [Installing a processor](#)
- [Installing a heat sink](#)

Installing a processor

Prerequisites

 **CAUTION:** Many repairs may only be done by a certified service technician. You should only perform troubleshooting and simple repairs as authorized in your product documentation, or as directed by the online or telephone service and support team. Damage due to servicing that is not authorized by Dell is not covered by your warranty. Read and follow the safety instructions that came with the product.

 **NOTE:** This is a Field Replaceable Unit (FRU). Removal and installation procedures should be performed only by Dell certified service technicians.

1. Ensure that you read the [Safety instructions](#).
2. Follow the procedure listed in [Before working inside your system](#).
3. If you are upgrading your system (from a single processor system to a dual processor system or a processor with a higher processor bin) download the latest system BIOS version from [dell.com/support](#) and follow the instructions included in the compressed download file to install the update on your system.

 **NOTE:** You can update the system BIOS by using Lifecycle Controller.

4. Remove the processor blank.
5. Keep the Phillips #2 screwdriver ready.

 **NOTE:** If you are installing a single processor, it must be installed in socket CPU 1.

Steps

1. Unpack the new processor.
2. Locate the processor socket.
3. If installed, remove the socket protective cap.
4. Unlatch and rotate the socket-release levers 90 degrees upward and ensure that the socket-release lever is fully open.
5. Hold the tab on the processor shield and lift the shield and move it out of the way.

 **NOTE:** It is recommended that you install/remove the socket protective cap from the processor shield with the processor shield in the open position.

6. If installed, remove the socket protective cap from the processor shield. To remove the socket protective cap, push the cap from the inside of the processor shield and move it away from the socket pins.

 **CAUTION:** Positioning the processor incorrectly can permanently damage the system board or the processor. Be careful not to damage the pins in the socket.

 **CAUTION:** Do not use force to seat the processor. When the processor is positioned correctly, it engages easily into the socket.

7. Install the processor in the socket:

- a. Identify the pin-1 corner of the processor by locating the tiny gold triangle on one corner of the processor. Place this corner in the same corner of the ZIF socket identified by a corresponding triangle on the system board.
- b. Align the pin-1 corner of the processor with the pin-1 corner of the system board.
- c. Place the processor on the socket such that the slots on the processor align with the socket keys.

 **CAUTION: Do not use force to seat the processor. When the processor is positioned correctly, it engages easily into the socket.**

- The sled uses a ZIF processor socket. Do not use force while installing the processor in the socket
- d. Close the processor shield.
 - e. Rotate the socket-release lever 1 and lever 2 simultaneously until they are locked into position.

Next steps

 **NOTE:** Ensure that you install the heat sink after you install the processor. The heat sink is necessary to maintain proper thermal conditions.

1. Install the heat sink.
2. Follow the procedure listed in [After working inside your system](#).

Related Links

[Removing a processor-and-DIMM blank](#)
[Installing a heat sink](#)

Installing a heat sink

Prerequisites

 **CAUTION: Many repairs may only be done by a certified service technician. You should only perform troubleshooting and simple repairs as authorized in your product documentation, or as directed by the online or telephone service and support team. Damage due to servicing that is not authorized by Dell is not covered by your warranty. Read and follow the safety instructions that came with the product.**

 **NOTE:** This is a Field Replaceable Unit (FRU). Removal and installation procedures should be performed only by Dell certified service technicians.

1. Ensure that you read the [Safety instructions](#).
2. Follow the procedure listed in [Before working inside your system](#).
3. Install the processor.
4. Keep the Phillips #2 screwdriver ready.

 **NOTE:** If you are installing a single processor, it must be installed in socket CPU 1.

Steps

1. If you are using an existing heat sink, remove the thermal grease from the heat sink by using a clean lint-free cloth.
2. Using the thermal grease syringe included with your processor kit, apply the grease in a thin spiral on the top of the processor as shown in the figure.

 **CAUTION: Applying too much thermal grease can result in excess grease coming in contact with and contaminating the processor socket.**

 **NOTE:** The thermal grease syringe is intended for one-time use only. Dispose of the syringe after you use it.

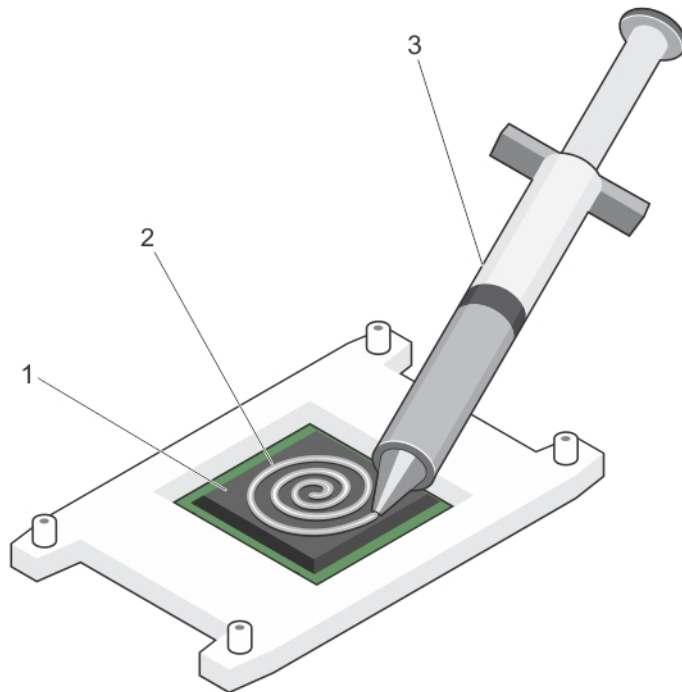



Figure 20. Applying thermal grease on the top of the processor

1. processor
 2. thermal grease
 3. thermal grease syringe
3. Place the heat sink on the processor.
 4. Tighten one of the four screws to secure the heat sink to the system board.
 5. Tighten the screw diagonally opposite to the first screw you tightened.
-  **NOTE:** Do not over-tighten the heat sink retention screws when installing the heat sink. To prevent over-tightening, tighten the retention screw until resistance is felt. The screw tension should be no more than 6 in-lb (6.9 cm-kg).
6. Repeat the procedure for the remaining screws.

Next steps

1. Install the cooling shroud.
2. Follow the procedure listed in [After working inside your system](#).
3. While booting, press <F2> to enter System Setup and check that the processor information matches the new system configuration.
4. Run system diagnostics to verify that the new processor operates correctly.

Related Links

[Installing the cooling shroud](#)

Processor-and-DIMM blank

The processor-and-DIMM blank supplied with your system aids in directing airflow over the unused processor sockets and DIMM slots.

△ CAUTION: If you are permanently removing a processor, you must install a socket protective cap and a processor-and-DIMM blank in the vacant socket to ensure proper system cooling. The processor-and-DIMM blank covers the vacant sockets for the DIMMs and the processor.

Removing a processor-and-DIMM blank

Prerequisites

△ CAUTION: Many repairs may only be done by a certified service technician. You should only perform troubleshooting and simple repairs as authorized in your product documentation, or as directed by the online or telephone service and support team. Damage due to servicing that is not authorized by Dell is not covered by your warranty. Read and follow the safety instructions that came with the product.

1. Ensure that you read the [Safety instructions](#).
2. Follow the procedure listed in [Before working inside your system](#).
3. Remove the cooling shroud.

Steps

1. Press the DIMM latches to unlock the processor-and-DIMM blank.
2. Hold the processor-and-DIMM blank by its edges and lift it away from the system.

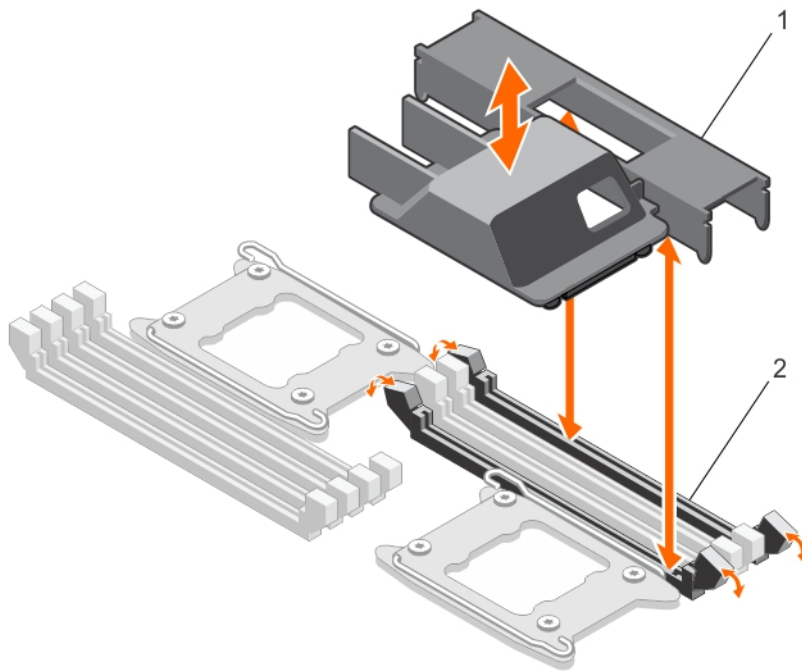

Figure 21. Removing and installing a processor-and-DIMM blank

1. processor-and-DIMM blank
2. memory module socket (2)

Next steps

1. Install the processor.
2. Install the heat sink.
3. Install the cooling shroud.
4. If you are removing a processor permanently, install the processor-and-DIMM blank.
5. Follow the procedure listed in [After working inside your system](#).

Related Links

- [Removing the cooling shroud](#)
- [Installing a processor](#)
- [Installing a heat sink](#)
- [Installing a processor-and-DIMM blank](#)
- [Installing the cooling shroud](#)

Installing a processor-and-DIMM blank

Prerequisites

- ⚠ CAUTION:** Many repairs may only be done by a certified service technician. You should only perform troubleshooting and simple repairs as authorized in your product documentation, or as directed by the online or telephone service and support team. Damage due to servicing that is not authorized by Dell is not covered by your warranty. Read and follow the safety instructions that came with the product.

 **NOTE:** You must remove the processor-and-DIMM blank when using a dual processor configuration or to service other components inside the system.

1. Ensure that you read the [Safety instructions](#).
2. Follow the procedure listed in [Before working inside your system](#).
3. Remove the cooling shroud.

Steps

1. Align the standoffs on the processor-and-DIMM blank with the heat sink retention screws on the system board.
2. Press the processor-and-DIMM blank onto the system until it engages with the DIMM sockets on the system board.

Next steps

1. Ensure that you install a processor-and-DIMM blank when you have removed a processor permanently.
2. Install the cooling shroud.
3. Follow the procedure listed in [After working inside your system](#).

Related Links

[Removing the cooling shroud](#)

[Installing the cooling shroud](#)

Solid State Drives (SSD)

The PowerEdge FC430 supports one or two 1.8 inch uSATA SSDs. The SSDs are supplied in special hot swap drive carriers that fit in the drive bays and these drives connect to the system board through the SSD backplane board.

SSD installation guidelines

In a dual SSD bay sled that has a single SSD installed, an SSD blank must be installed in the vacant drive bay to maintain proper airflow.

Shutdown procedure for servicing an SSD

 **NOTE:** This section applies only to situations where the sled must be powered down to service an SSD.

If you need to service an SSD, turn off the sled and before removing the SSD wait for 30 seconds after the sled's indicator turns off. Otherwise, the SSD may not be recognized after it is reinstalled and the sled is powered on again.

Removing an SSD from an SSD carrier

Prerequisites

 **CAUTION:** Many repairs may only be done by a certified service technician. You should only perform troubleshooting and simple repairs as authorized in your product documentation, or as directed by the online or telephone service and support team. Damage due to servicing that is not authorized by Dell is not covered by your warranty. Read and follow the safety instructions that came with the product.

1. Remove the SSD carrier out of the sled.
2. Ensure that you read the [Safety instructions](#).

Steps

Pull the rails on the side of the carrier and lift the SSD out of the carrier.

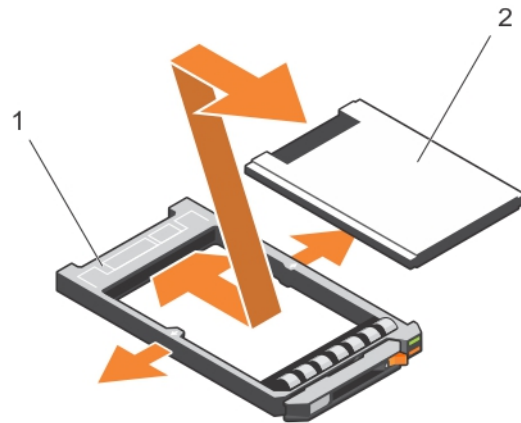

Figure 22. Removing and installing an SSD in an SSD carrier

1. SSD carrier
2. SSD

Next steps

1. Install an SSD in the SSD carrier.
2. Install the SSD carrier into the sled.

Related Links

[Removing an SSD carrier](#)

[Installing an SSD into an SSD carrier](#)

Installing an SSD into an SSD carrier

Prerequisites

CAUTION: Many repairs may only be done by a certified service technician. You should only perform troubleshooting and simple repairs as authorized in your product documentation, or as directed by the online or telephone service and support team. Damage due to servicing that is not authorized by Dell is not covered by your warranty. Read and follow the safety instructions that came with the product.

NOTE: You must remove the SSD from an SSD carrier to replace a faulty SSD from an SSD carrier.

1. Ensure that you read the [Safety instructions](#).
2. Remove the SSD carrier out of the sled.
3. Remove the SSD from the SSD carrier.

Steps

Insert the SSD into the SSD carrier with the connector end of the SSD toward the back of the carrier. When aligned correctly, the back of the SSD is flush with the back of the SSD carrier.

Next steps

Install the SSD carrier into the sled.

Related Links

[Removing an SSD carrier](#)

[Removing an SSD from an SSD carrier](#)

[Installing an SSD carrier](#)

Removing an SSD carrier

Prerequisites



CAUTION: Many repairs may only be done by a certified service technician. You should only perform troubleshooting and simple repairs as authorized in your product documentation, or as directed by the online or telephone service and support team. Damage due to servicing that is not authorized by Dell is not covered by your warranty. Read and follow the safety instructions that came with the product.

1. Ensure that you read the [Safety instructions](#).
2. Take the SSD offline and wait until the SSD indicator LEDs on the carrier are off.



NOTE: When all indicators are off, the drive is ready for removal. See your operating system documentation for more information on taking the SSD offline.



NOTE: All operating systems do not support hot-swappable drive installation. See the documentation supplied with your operating system.

Steps

1. Press the release button to open the SSD carrier handle.
2. Slide the SSD carrier out until it is free of the SSD slot.

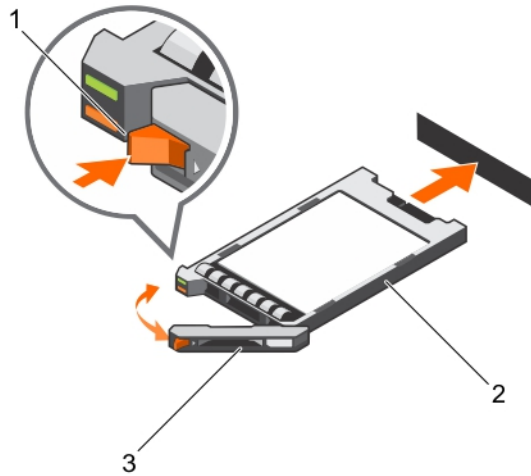

Figure 23. Removing and installing an SSD

1. release button
2. SSD in the carrier
3. SSD carrier handle

Next steps

1. If you are removing an SSD permanently, install the SSD blank. If you are installing a new SSD, see [Installing an SSD carrier](#).
2. Follow the procedure listed in [After working inside your system](#).

Related Links

[Installing an SSD carrier](#)

Installing an SSD carrier

Prerequisites

CAUTION: When a replacement hot swappable SSD is installed and the sled is powered on, the SSD automatically begins to rebuild. Make absolutely sure that the replacement SSD is blank or contains data that you wish to have over-written. Any data on the replacement SSD is immediately lost after the SSD is installed.

NOTE: You must remove an SSD to upgrade an SSD or replace a faulty SSD.

1. Ensure that you read the [Safety instructions](#).
2. Remove the SSD blank.
3. Install the SSD in the SSD carrier.

NOTE: All operating systems do not support hot swappable drive installation. See the documentation supplied with your operating system.

Steps

1. Press the release button to open the SSD carrier handle.
2. Slide the SSD carrier into the drive bay and push it until the handle makes contact with the sled.
3. Rotate the carrier handle to the closed position while pushing the carrier into the slot until it locks into place.

The status LED indicator displays a steady green light if the drive is installed correctly. The drive carrier LED green indicator flashes as the drive rebuilds.

Next steps

Follow the procedure listed in [After working inside your system](#).

Related Links

[Removing an SSD blank](#)

[Installing an SSD into an SSD carrier](#)

Removing an SSD blank

Prerequisites

 **CAUTION:** Many repairs may only be done by a certified service technician. You should only perform troubleshooting and simple repairs as authorized in your product documentation, or as directed by the online or telephone service and support team. Damage due to servicing that is not authorized by Dell is not covered by your warranty. Read and follow the safety instructions that came with the product.

 **CAUTION:** To maintain proper system cooling, all empty SSD slots must have a SSD blank installed.

Ensure that you read the [Safety instructions](#).

Steps

Press the release latch and slide the SSD blank out of the SSD slot.

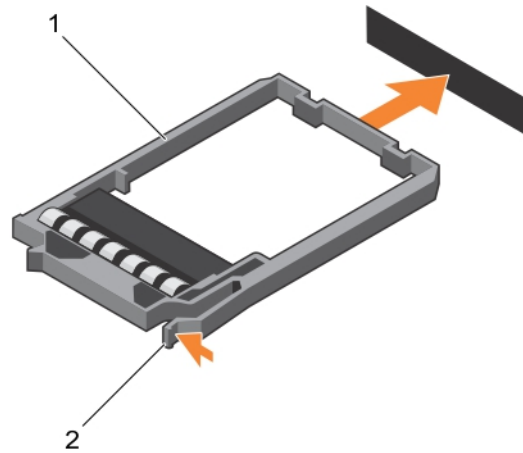

Figure 24. Removing and installing an SSD blank

1. SSD blank
2. release latch

Next steps

Install the SSD

Related Links

[Installing an SSD carrier](#)

Installing an SSD blank

Prerequisites

1. Ensure that you read the [Safety instructions](#).
2. Remove an SSD.

Steps

Insert the SSD blank into the SSD slot until the release latch clicks into place.

Related Links

[Removing an SSD carrier](#)

Removing the SSD cage

Prerequisites

⚠ CAUTION: Many repairs may only be done by a certified service technician. You should only perform troubleshooting and simple repairs as authorized in your product documentation, or as directed by the online or telephone service and support team. Damage due to servicing that is not authorized by Dell is not covered by your warranty. Read and follow the safety instructions that came with the product.

1. Ensure that you read the [Safety instructions](#).

2. Follow the procedure listed in [Before working inside your system](#).
3. Remove the SSD(s).
4. Disconnect all connected USB devices.
5. Keep the Phillips #1 screwdriver ready.

Steps

1. Remove the four screws securing the SSD cage to the chassis.
2. Holding the SSD cage by its edges, lift it away from the sled.

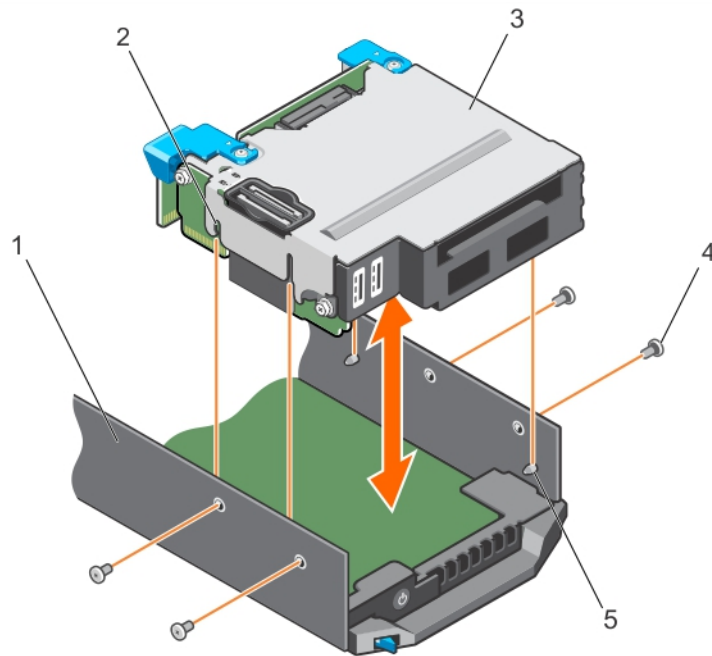

Figure 25. Removing and installing an SSD cage

- | | |
|------------------|-----------------------|
| 1. chassis | 2. guide pin slot (4) |
| 3. SSD cage | 4. screw (4) |
| 5. guide pin (4) | |

Next steps

1. Install the SSD cage.
2. Install the SSD(s).
3. Reconnect the USB devices.
4. Follow the procedure listed in [After working inside your system](#).

Related Links

[Removing an SSD carrier](#)

[Installing the SSD cage](#)

Installing the SSD cage

Prerequisites

 **CAUTION:** Many repairs may only be done by a certified service technician. You should only perform troubleshooting and simple repairs as authorized in your product documentation, or as directed by the online or telephone service and support team. Damage due to servicing that is not authorized by Dell is not covered by your warranty. Read and follow the safety instructions that came with the product.

 **NOTE:** You must remove the SSD cage to replace a faulty SSD cage or service other components inside the system.

1. Ensure that you read the [Safety instructions](#).
2. Follow the procedure listed in [Before working inside your system](#).
3. Keep the Phillips #1 screwdriver ready.

Steps

1. Align the slots on the sides of the SSD cage with the guide pins on the chassis.
2. Push the SSD cage into the chassis until the screw holes on the chassis are aligned with the holes on the SSD cage..
3. Slide the SSD cage into the chassis till the IDSDM card connector engages completely with the connector on the system board.
4. Secure the SSD cage to the chassis with the screws.

Next steps

1. Install the SSD backplane.
2. Install the SSDs.
3. Follow the procedure listed in [After working inside your system](#).

Related Links

[Installing the SSD backplane](#)

[Installing an SSD carrier](#)

Configuring the boot drive

The drive or device from which the system boots is determined by the boot order specified in the System Setup.

Solid State Drive (SSD) backplane

The SSD backplane of your system allows you to use hot-swappable SSDs. You can remove and install the SSD backplane.

Removing the SSD backplane

Prerequisites

 **CAUTION:** Many repairs may only be done by a certified service technician. You should only perform troubleshooting and simple repairs as authorized in your product documentation, or as directed by the online or telephone service and support team. Damage due to servicing that is not authorized by Dell is not covered by your warranty. Read and follow the safety instructions that came with the product.

 **CAUTION:** To prevent damage to the SSDs and the SSD backplane, you must remove the SSD carriers from the sled before removing the SSD backplane.

 **CAUTION:** You must note the bay number of each SSD and temporarily label them before removal so that you can reinstall them into their original bays.

1. Ensure that you read the [Safety instructions](#).
2. Follow the procedure listed in [Before working inside your system](#).
3. Remove the SSD carrier(s).
4. Keep the Phillips #2 screwdriver ready.

Steps

1. Loosen the two captive screws on the backplane touch points that secure the SSD backplane to the SSD cage.
2. Holding the backplane at the touch points, lift the SSD backplane till it disengages from the connector on the system board.
3. Lift the backplane away from the SSD cage.

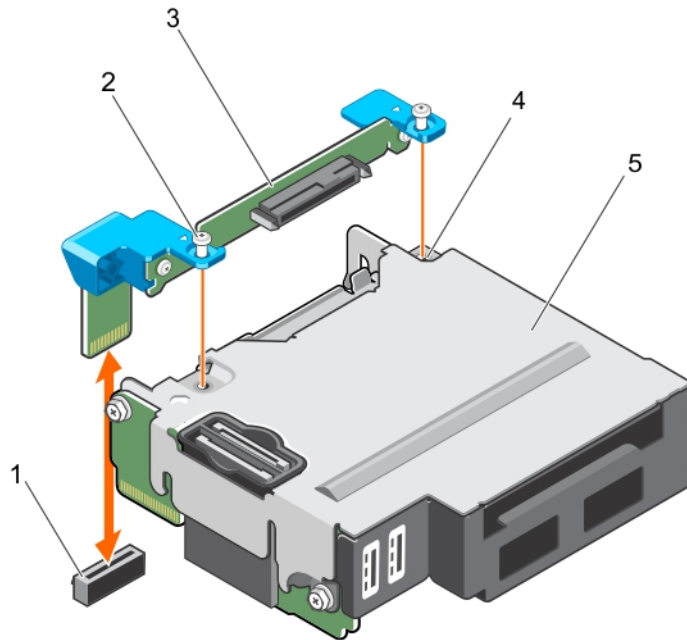

Figure 26. Removing and installing the SSD backplane

- | | |
|--|-----------------------------------|
| 1. SSD backplane connector on system board | 2. captive screw (2) |
| 3. SSD backplane | 4. screw hole on the SSD cage (2) |
| 5. SSD cage | |

Next steps

1. Install the SSD backplane.
2. Install the SSD carrier(s).
3. Follow the procedure listed in [After working inside your system](#).

Related Links

- [Removing an SSD carrier](#)
- [Installing the SSD backplane](#)
- [Installing an SSD carrier](#)

Installing the SSD backplane

Prerequisites

CAUTION: Many repairs may only be done by a certified service technician. You should only perform troubleshooting and simple repairs as authorized in your product documentation, or as directed by the online or telephone service and support team. Damage due to servicing that is not authorized by Dell is not covered by your warranty. Read and follow the safety instructions that came with the product.

NOTE: You must remove the SSD backplane to replace a faulty SSD backplane.

1. Ensure that you read the [Safety instructions](#).
2. Follow the procedure listed in [Before working inside your system](#).
3. Remove the SSD backplane.
4. Keep the Phillips #2 screwdriver ready.

Steps

1. Align the screws on the SSD backplane with the screw holes on the SSD cage.
2. Press the SSD backplane into place until the retention screws on the SSD backplane engage with the screw holes on the SSD cage.
3. Ensure that the backplane connector is seated firmly in the socket on the system board and tighten the two captive screws to secure the backplane to the SSD cage.

Next steps

1. Install the SSD carriers into their original bays.
2. Follow the procedure listed in [After working inside your system](#).

Related Links

[Removing the SSD backplane](#)



[Installing an SSD carrier](#)

NVRAM backup battery

The NVRAM backup battery installed in your system helps to retain the BIOS settings and configurations even if the power is switched off.

Replacing the NVRAM backup battery

Prerequisites

-  **WARNING:** There is a danger of a new battery exploding if it is incorrectly installed. Replace the battery only with the same or equivalent type recommended by the manufacturer. Discard used batteries according to the manufacturer's instructions. See the safety instructions that came with your system for additional information.
-  **CAUTION:** Many repairs may only be done by a certified service technician. You should only perform troubleshooting and simple repairs as authorized in your product documentation, or as directed by the online or telephone service and support team. Damage due to servicing that is not authorized by Dell is not covered by your warranty. Read and follow the safety instructions that came with the product.

1. Ensure that you read the [Safety instructions](#).
2. Follow the procedure listed in [Before working inside your system](#).
3. Remove the cooling shroud.

Steps

1. Locate the system battery.
2. Hold the battery and pull it toward the positive side of the battery till the battery disengages from the connector.
3. Lift the battery up and away from the system.
4. To install a new system battery, hold the battery with the "+" sign facing the positive side of the battery connector.

5. Place the battery straight down into the connector and push the positive side of the battery till the battery snaps into place.

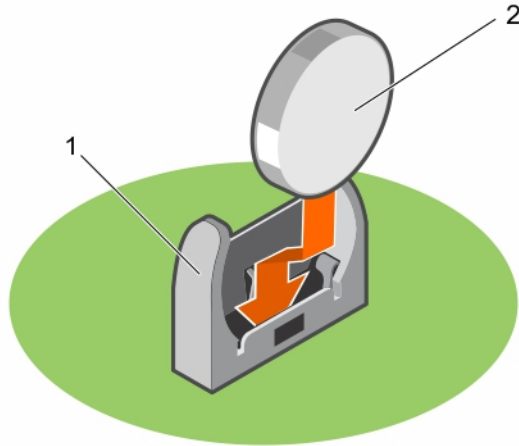

Figure 27. Replacing the NVRAM backup battery

1. negative side of battery connector
2. positive side of battery

Next steps

1. Install the cooling shroud.
2. Follow the procedure listed in [After working inside your system](#).
3. Enter System Setup to confirm that the battery is operating properly.
4. Enter the correct time and date in the System Setup's **Time** and **Date** fields.
5. Exit System Setup.
6. To test the freshly installed battery, leave the sled disconnected for at least an hour.
7. Reconnect the sled after an hour has passed.
8. Enter System Setup and if the time and date are still incorrect, see [Getting help](#).

Related Links

[Installing the cooling shroud](#)

System board

Removing the system board

Prerequisites

CAUTION: Many repairs may only be done by a certified service technician. You should only perform troubleshooting and simple repairs as authorized in your product documentation, or as directed by the online or telephone service and support team. Damage due to servicing that is not authorized by Dell is not covered by your warranty. Read and follow the safety instructions that came with the product.

NOTE: This is a Field Replaceable Unit (FRU). Removal and installation procedures should be performed only by Dell certified service technicians.

 **CAUTION:** If you are using Trusted Program Module (TPM) with an encryption key, you may be prompted to create a recovery key during program or System Setup. Be sure to create and safely store this recovery key. If you replace this system board, you must supply the recovery key when you restart your system or program before you can access the encrypted data on your hard drives.

 **CAUTION:** Do not attempt to remove the TPM plug-in module from the motherboard. Once the TPM plug-in module is installed, it is cryptographically bound to that specific motherboard. Any attempt to remove an installed TPM plug-in module breaks the cryptographic binding, and it cannot be re-installed or installed on another motherboard.

1. Ensure that you read the [Safety instructions](#).
2. Follow the procedure listed in [Before working inside your system](#).
3. Remove the following components:
 - Processor(s) and heat sink(s)
 - Memory modules
 - Cooling shroud
 - SSD carriers
 - SSD backplane
 - SSD cage
 - PCIe mezzanine card
 - LOM riser card
4. Keep the Phillips #2 screwdriver, along with the 4 mm and 5 mm Hex nut drivers ready.

 **CAUTION:** Do not lift the system board by holding a memory module, processor, or other components.

 **CAUTION:** You must temporarily label the SSD before removal so that you can replace them in their original bays.

 **WARNING:** The processor and heat sink can become extremely hot. Be sure the processor has had sufficient time to cool before handling.

 **WARNING:** The memory modules are hot to touch for some time after the system has been powered down. Allow the memory modules to cool before handling them. Handle the memory modules by the card edges and avoid touching the components.

Steps

1. Remove the screws on the system board that secure the system board to the chassis.
2. By holding the system board handle, lift the system board away from the chassis.

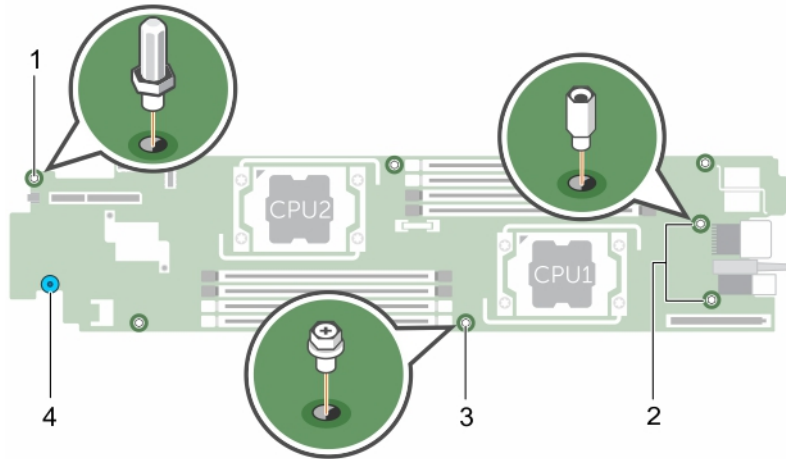

Figure 28. Screw location on the system board

- | | |
|-----------------------|---------------------------|
| 1. Hex nut screw 4 mm | 2. Hex nut screw 5 mm (2) |
| 3. screw (4) | 4. system board holder |

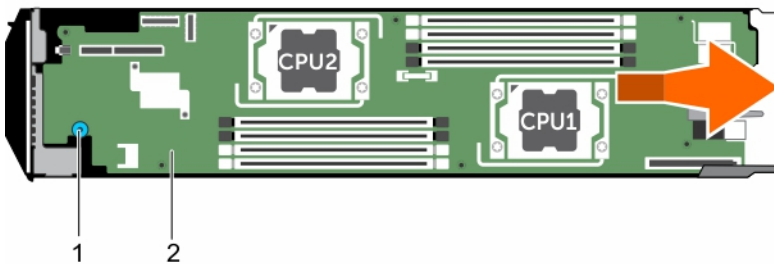

Figure 29. Removing and installing the system board

- | | |
|------------------------|-----------------|
| 1. system board holder | 2. system board |
|------------------------|-----------------|

Next steps

1. Install the system board.
2. Follow the procedure listed in [After working inside your system.](#)

Related Links

- [Removing a processor](#)
- [Removing memory modules](#)
- [Removing the cooling shroud](#)
- [Removing an SSD carrier](#)
- [Removing the SSD backplane](#)
- [Removing the SSD cage](#)
- [Removing the PCIe mezzanine card](#)
- [Removing the LOM riser card](#)
- [Installing the system board](#)

Installing the system board

Prerequisites

 **CAUTION:** Many repairs may only be done by a certified service technician. You should only perform troubleshooting and simple repairs as authorized in your product documentation, or as directed by the online or telephone service and support team. Damage due to servicing that is not authorized by Dell is not covered by your warranty. Read and follow the safety instructions that came with the product.

 **NOTE:** This is a Field Replaceable Unit (FRU). Removal and installation procedures should be performed only by Dell certified service technicians.

 **NOTE:** You must remove the system board to replace a faulty system board.

1. Ensure that you read the [Safety instructions](#).
2. Follow the procedure listed in [Before working inside your system](#).
3. Remove the system board.
4. Unpack the new system board assembly.
5. Keep the Phillips #2 screwdriver, the 4 mm and 5 mm Hex nut drivers ready.

 **CAUTION:** Do not lift the system board by holding a memory module, processor, or other components.

 **CAUTION:** Take care not to damage the system identification button while placing the system board into the chassis.

Steps

1. Align the system board with the standoffs on the chassis.
2. Secure the system board to the chassis with the screws.

Next steps

1. Install the Trusted Platform Module (TPM). For information on how to install TPM, see [Installing the Trusted Platform Module](#). For information on TPM, see [Trusted Platform Module](#).
2. Install the following components:

- LOM riser card
- PCIe mezzanine card
- SSD cage
- SSD backplane
- SSD carriers

 **NOTE:** Ensure that you reinstall the SSD carriers into their original bays.

- Cooling shroud
- Memory modules
- Processor(s) and heat sink(s)

3. Follow the procedure listed in [After working inside your system](#).

 **NOTE:** If you are not installing the sled in the enclosure, install the I/O connector cover.

4. Import your new or existing iDRAC Enterprise license. See the *iDRAC8 User's Guide* at dell.com/esmanuals.
5. Ensure that you:
 - a. Use the Easy Restore feature to restore the Service Tag. For more information, see [Restoring the Service Tag using Easy Restore](#).
 - b. If the Service Tag is not backed up in the backup flash device, enter the system Service Tag manually. For more information, see [Entering the system Service Tag using System Setup](#).
 - c. Update the BIOS and iDRAC versions.
 - d. Re-enable the Trusted Platform Module (TPM). For more information, see [Re-enabling the TPM for BitLocker users](#) or [Re-enabling the TPM for TXT users](#).

Related Links

- [Removing the system board](#)
- [Installing the LOM riser card](#)
- [Installing the PCIe mezzanine card](#)
- [Installing the SSD cage](#)
- [Installing the SSD backplane](#)
- [Installing an SSD carrier](#)
- [Installing the cooling shroud](#)
- [Installing a processor](#)
- [Installing a heat sink](#)

Restoring the Service Tag using Easy Restore

Use the Easy Restore feature if you do not know the Service Tag of your system. The Easy Restore feature allows you to restore your system's Service Tag, license, UEFI configuration, and the system configuration data after replacing the system board. All data is backed up in an rSPI card automatically. If BIOS detects a new system board and the Service Tag in the rSPI card, BIOS prompts the user to restore the backup information.

1. Turn on the system.

If BIOS detects a new system board, and if the Service Tag is present in the rSPI card, BIOS displays the Service Tag, the status of the license, and the **UEFI Diagnostics** version.
2. Do one of the following:
 - Press **Y** to restore the Service Tag, license, and diagnostics information.
 - Press **N** to navigate to the Lifecycle Controller based restore options.
 - Press <F10> to restore data from a previously created **Hardware Server Profile**.

After the restore process is complete, BIOS prompts to restore the system configuration data.

3. Do one of the following:
 - Press **Y** to restore the system configuration data.
 - Press **N** to use the default configuration settings.

After the restore process is complete, the system reboots.

Entering the system Service Tag using System Setup

If you know the system Service Tag, use System Setup menu to enter the Service Tag.

1. Turn on the system.
2. Press <F2> to enter System Setup.
3. Click **Service Tag Settings**.
4. Enter the Service Tag.



NOTE: You can enter the Service Tag only when the **Service Tag** field is empty. Ensure that you enter the correct Service Tag. Once the Service Tag is entered, it cannot be updated or changed.

5. Click **Ok**.
6. Import your new or existing iDRAC Enterprise license.
For more information, see Integrated Dell Remote Access Controller User's Guide, at dell.com/esmanuals.

Trusted Platform Module

The Trusted Platform Module (TPM) is used to generate or store keys, protect or authenticate passwords, and create or store digital certificates. TPM can also be used to enable the BitLocker hard drive encryption feature in Windows Server.



CAUTION: Do not attempt to remove the Trusted Platform Module (TPM) from the system board. Once the TPM is installed, it is cryptographically bound to that specific system board. Any attempt to remove an installed TPM breaks the cryptographic binding, and it cannot be re-installed or installed on another system board.

Installing the Trusted Platform Module

Prerequisites



CAUTION: Many repairs may only be done by a certified service technician. You should only perform troubleshooting and simple repairs as authorized in your product documentation, or as directed by the online or telephone service and support team. Damage due to servicing that is not authorized by Dell is not covered by your warranty. Read and follow the safety instructions that came with the product.

Ensure that you read the [Safety instructions](#).

Steps

1. Align the edge connectors on the TPM with the slot on the TPM connector.
2. Insert the TPM into the TPM connector such that the plastic bolt aligns with the slot on the system board.
3. Press the plastic bolt until the bolt snaps into place.

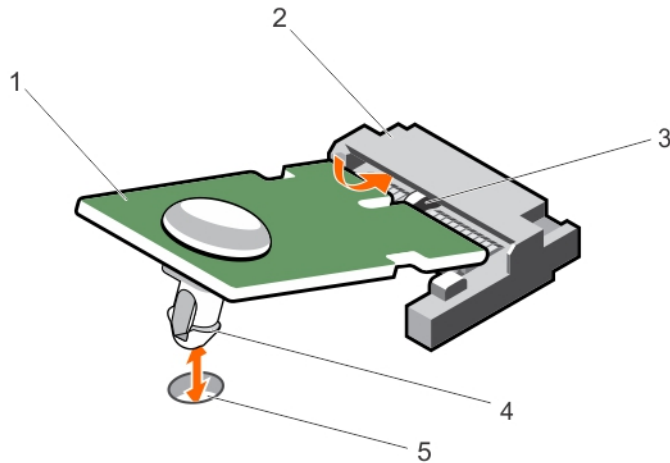

Figure 30. Installing the TPM

- | | |
|-----------------------------------|------------------|
| 1. TPM | 2. TPM connector |
| 3. guide pin on the TPM connector | 4. plastic bolt |
| 5. slot on the system board | |

Re-enabling the TPM for BitLocker users

Initialize the TPM.

For more information on initializing the TPM, see <http://technet.microsoft.com/en-us/library/cc753140.aspx>.

The **TPM Status** changes to **Enabled, Activated**.

Re-enabling the TPM for TXT users

1. While booting your system, press <F2> to enter System Setup.
2. In the **System Setup Main Menu**, click **System BIOS** → **System Security Settings**.
3. In the **TPM Security** option, select **On with Pre-boot Measurements**.
4. In the **TPM Command** option, select **Activate**.
5. Save the settings.
6. Restart your system.
7. Enter System Setup again.
8. In the **System Setup Main Menu**, click **System BIOS** → **System Security Settings**.
9. In the **Intel TXT** option, select **On**.

Troubleshooting your system

Safety first—for you and your system

 **CAUTION:** Many repairs may only be done by a certified service technician. You should only perform troubleshooting and simple repairs as authorized in your product documentation, or as directed by the online or telephone service and support team. Damage due to servicing that is not authorized by Dell is not covered by your warranty. Read and follow the safety instructions that came with the product.

 **NOTE:** For troubleshooting information on the FX2 and FX2s enclosure components, see the *Dell PowerEdge FX2 and FX2s Enclosure Owner's Manual* at dell.com/poweredgemanuals.

Troubleshooting system memory

Prerequisites

 **CAUTION:** Many repairs may only be done by a certified service technician. You should only perform troubleshooting and simple repairs as authorized in your product documentation, or as directed by the online or telephone service and support team. Damage due to servicing that is not authorized by Dell is not covered by your warranty. Read and follow the safety instructions that came with the product.

 **NOTE:** Before performing the following procedure, ensure that you have installed the memory modules according to the memory installation guidelines for the sled.

Steps

1. Restart the sled:
 - a. Press the power button once to turn off the sled.
 - b. Press the power button again to power on the sled.
If no error messages appear, go to step 7.
2. Enter System Setup and check the system memory setting.
If the amount of memory installed matches the system memory setting, go to step 7.
3. Turn off the sled using the operating system commands or the CMC.
4. Remove the sled from the enclosure.



 **CAUTION:** The memory modules are hot to touch for some time after the sled has been powered down. Allow time for the memory modules to cool before handling them. Handle the memory modules by the card edges and avoid touching the components.

5. Reseat the memory modules in their sockets.
6. Install the sled in the enclosure.
7. Turn on the sled.
8. Run the appropriate diagnostic test. For more information, see [Using system diagnostics](#).

If the test fails, see [Getting help](#).

Troubleshooting Solid State Drives

Prerequisites

-  **CAUTION:** Many repairs may only be done by a certified service technician. You should only perform troubleshooting and simple repairs as authorized in your product documentation, or as directed by the online or telephone service and support team. Damage due to servicing that is not authorized by Dell is not covered by your warranty. Read and follow the safety instructions that came with the product.
-  **CAUTION:** This troubleshooting procedure can destroy data stored on the SSD. Before you proceed, back up all the files on the SSD, if possible.
-  **NOTE:** In a dual SSD sled, note the drive locations with respect to the bays. Always reinstall the drives into their original locations.

Steps

1. Run the appropriate tests in system diagnostics.
If the tests fail, go to step 3.
2. Take the SSD offline and wait until the indicator codes on the SSD carrier signal that the SSD may be removed safely, then remove and reseat the SSD carrier in the sled.
3. Restart the sled, enter System Setup and confirm that the drive controller is enabled.
4. Ensure that any required device drivers are installed and configured correctly.
5. Remove the SSD.
6. Reinstall the SSD in the slot.
If the SSD functions properly in the slot, the SSD carrier could have intermittent problems. Replace the SSD carrier.
 - a. If the sled has a secondary drive bay, install the SSD in the secondary drive slot and test the drive.
 - b. If the SSD functions properly in the slot, the SSD backplane could have intermittent problems. Replace the SSD backplane.
7. If the SSD is the boot drive, ensure that the SSD is configured and connected properly.
8. Partition and logically format the SSD.
9. If possible, restore the files to the SSD.
If the problem persists, see [Getting help](#).

Troubleshooting USB devices

Prerequisites

-  **CAUTION:** Many repairs may only be done by a certified service technician. You should only perform troubleshooting and simple repairs as authorized in your product documentation, or as directed by the online or telephone service and support team. Damage due to servicing that is not authorized by Dell is not covered by your warranty. Read and follow the safety instructions that came with the product.

Steps

1. Ensure that the sled is turned on.
2. Check the USB device connection to the sled.
3. Swap the USB device with a working USB device.

4. Connect the USB devices to the sled using a powered USB hub.
5. If another sled is installed, connect the USB device to that sled. If the USB device works with a different sled, the first sled's USB ports may be faulty. See [Getting help](#).

Troubleshooting an internal SD card

Prerequisites

 **CAUTION:** Many repairs may only be done by a certified service technician. You should only perform troubleshooting and simple repairs as authorized in your product documentation, or as directed by the online or telephone service and support team. Damage due to servicing that is not authorized by Dell is not covered by your warranty. Read and follow the safety instructions that came with the product.

 **NOTE:** SD card slot 2 referred in this procedure is the vFlash SD card slot. You can install an SD card in SD card slot 2 to enable the **Internal SD Card Redundancy** option in the **Integrated Devices** screen of the System Setup.

Steps

1. Enter System Setup and ensure that the **Internal SD Card Port** is enabled.
2. Note the **Internal SD Card Redundancy** option enabled in the **Integrated Devices** screen of the System Setup (Mirror or Disabled).
 -  **NOTE:** If you retain the original settings of the SD card in the System Setup, the replaced SD card is enabled when you reinstall the sled in the enclosure.
3. Remove the sled from the enclosure.
4. If the **Internal SD Card Redundancy** option in the **Integrated Devices** screen of the System Setup is set to Mirror mode and SD card 1 has failed:
 - a. Remove the SD card from SD card slot 1.
 - b. Remove the SD card present in SD card slot 2 and insert it into SD card slot 1.
 - c. Install a new SD card in slot 2.
5. If the **Internal SD Card Redundancy** option in the **Integrated Devices** screen of the System Setup is set to Mirror mode and SD card 2 has failed, insert the new SD card into SD card slot 2.
6. If the **Internal SD Card Redundancy** option in **Integrated Devices** screen of the System Setup is set to Disabled, replace the failed SD card with a new SD card.
7. Install the sled in the enclosure.
8. Enter System Setup and ensure that the **Internal SD Card Port** option is enabled and **Internal SD Card Redundancy** option is set to Mirror mode.
9. Check if the SD card is functioning properly.
If the problem persists, see [Getting help](#).

Troubleshooting processors

1. Turn off the sled using the operating system commands or the CMC.
2. Remove the sled from the enclosure.
3. Ensure that the processor(s) and heat sink(s) are properly installed.
4. If your system has only one processor installed, ensure that it is installed in the primary processor socket (CPU1).
5. Install the sled in the enclosure.
6. Turn on the sled.

7. Run the appropriate diagnostic test. For more information, see [Using system diagnostics](#).
If the problem persists, see [Getting help](#).

Troubleshooting the system board

Prerequisites

 **CAUTION: Many repairs may only be done by a certified service technician. You should only perform troubleshooting and simple repairs as authorized in your product documentation, or as directed by the online or telephone service and support team. Damage due to servicing that is not authorized by Dell is not covered by your warranty. Read and follow the safety instructions that came with the product.**

Steps

1. Turn off the sled using the operating system commands or the CMC.
2. Remove the sled from the enclosure.
3. Clear the sled NVRAM.
4. If the problem persists, remove and reinstall the sled in the enclosure.
5. Turn on the sled.
6. Run the appropriate diagnostic test. For more information, see [Using system diagnostics](#).
If the tests fail, see [Getting help](#).

Troubleshooting the NVRAM backup battery

Prerequisites



 **CAUTION: Many repairs may only be done by a certified service technician. You should only perform troubleshooting and simple repairs as authorized in your product documentation, or as directed by the online or telephone service and support team. Damage due to servicing that is not authorized by Dell is not covered by your warranty. Read and follow the safety instructions that came with the product.**

The battery maintains the sled configuration, date, and time information in the NVRAM when the sled is turned off. You may need to replace the battery if an incorrect time or date is displayed during the boot routine.

You can operate the sled without a battery; however, the sled configuration information maintained by the battery in NVRAM is erased each time you remove power from the sled. Therefore, you must re-enter the system configuration information and reset the options each time the sled boots until you replace the battery.

Steps

1. Re-enter the time and date through the System Setup.
2. Turn off the sled using the operating system commands or the CMC.
3. Remove the sled from the enclosure for at least one hour.
4. Install the sled in the enclosure.
5. Enter System Setup.
If the date and time are not correct in System Setup, replace the battery. If the problem is not resolved by replacing the battery, see [Getting help](#).

-  **NOTE:** If the sled is turned off for long periods of time (for weeks or months), the NVRAM may lose its system configuration information. This situation is caused by a defective battery.
-  **NOTE:** Some software may cause the sled's time to speed up or slow down. If the sled operates normally except for the time maintained by the System Setup, the problem may be caused by a software rather than by a defective battery.

Using system diagnostics

If you experience a problem with your system, run the system diagnostics before contacting Dell for technical assistance. The purpose of running system diagnostics is to test your system hardware without requiring additional equipment or risking data loss. If you are unable to fix the problem yourself, service and support personnel can use the diagnostics results to help you solve the problem.

Dell Embedded System Diagnostics

 **NOTE:** The Dell Embedded System Diagnostics is also known as Enhanced Pre-boot System Assessment (ePSA) diagnostics.

The embedded system diagnostics provides a set of options for particular device groups or devices allowing you to:

- Run tests automatically or in an interactive mode
- Repeat tests
- Display or save test results
- Run thorough tests to introduce additional test options to provide extra information about the failed device(s)
- View status messages that inform you if tests are completed successfully
- View error messages that inform you of problems encountered during testing

When to use the Embedded System Diagnostics

If a major component or device in the system does not operate properly, running the embedded system diagnostics may indicate component failure.

Running the Embedded System Diagnostics

The embedded system diagnostics program is run from the Dell Lifecycle Controller.

Prerequisites

 **CAUTION:** Use the embedded system diagnostics to test only your system. Using this program with other systems may cause invalid results or error messages.

Steps

1. As the system boots, press <F11>.
2. Use the up and down arrow keys to select **System Utilities** → **Launch Dell Diagnostics**.
The **ePSA Pre-boot System Assessment** window is displayed, listing all devices detected in the system. The diagnostics starts executing the tests on all the detected devices.

System diagnostics controls

Menu	Description
Configuration	Displays the configuration and status information of all detected devices.
Results	Displays the results of all tests that are executed.
System Health	Provides the current overview of the system performance.
Event Log	Displays a time-stamped log of the results of all tests run on the system. This is displayed if at least one event description is recorded.

For information about embedded system diagnostics, see the *Dell Enhanced Pre-boot System Assessment User Guide* at dell.com/support/home.





Jumpers and connectors

System board jumper settings

CAUTION: Many repairs may only be done by a certified service technician. You should only perform troubleshooting and simple repairs as authorized in your product documentation, or as directed by the online or telephone service and support team. Damage due to servicing that is not authorized by Dell is not covered by your warranty. Read and follow the safety instructions that came with the product.

For information on resetting the password jumper to disable a password, see [Disabling a forgotten password](#).

Table 5. System board jumper settings

Jumper	Setting	Description
PWRD_EN	 (default)	The password feature is enabled.
		The password feature is disabled.
NVRAM_CLR	 (default)	The configuration settings are retained at system boot.
		The configuration settings are cleared at the next system boot.

System board connectors

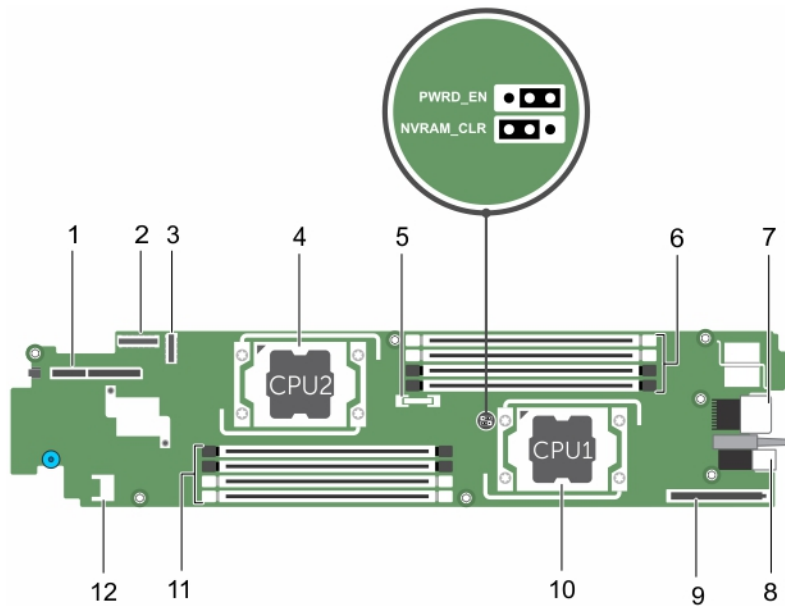

Figure 31. System board connectors

Table 6. System board connectors

Item	Connector	Description
1	DCS IB MEZZ	PCIe mezzanine card connector
2	J_IDSDM	IDSDM/vFlash and USB connector
3	J_SSDBP	SSD backplane connector
4	CPU2	Processor socket 2
5	BAT1	System battery
6	A4, A3, A2, A1	Memory module sockets (processor 1)
7	J_MIDPLANE1	Sled connector to the interposer card
8	PWR_CONN	Power connector
9	LOM RISER	LOM riser card connector
10	CPU1	Processor socket 1
11	B4, B3, B2, B1	Memory module sockets (processor 2)
12	TPM	TPM connector

Disabling a forgotten password

The software security features of sled include a system password and a setup password. The password jumper enables these password features or disables them, and clears any password(s) currently in use.

Prerequisites

 **CAUTION:** Many repairs may only be done by a certified service technician. You should only perform troubleshooting and simple repairs as authorized in your product documentation, or as directed by the online or telephone service and support team. Damage due to servicing that is not authorized by Dell is not covered by your warranty. Read and follow the safety instructions that came with the product.

Steps

1. Turn off the sled using the operating system commands or the CMC.
2. Remove the sled from the enclosure.
3. Relocate the jumper plug to disable the password feature.
4. Install the sled in the enclosure.
5. Turn on the sled.

When the sled is on, the power-on indicator is solid green. Allow the sled to finish booting.

The existing passwords are not disabled (erased) until the system boots with the password jumper removed. However, before you assign a new system and/or setup password, you must reinstall the password jumper.

 **NOTE:** If you assign a new system and/or setup password with the jumper removed, the system disables the new password(s) the next time it boots.

6. Turn off the sled.
7. Remove the sled from the enclosure.
8. Remove the system board to gain access to the jumpers.
9. Relocate the jumper plug to enable the password feature.
10. Reinstall the system board.
11. Install the sled in the enclosure.
12. Turn on the sled.
13. Assign a new system and/or setup password.

Technical specifications

Processor	
Processor type	One or two Intel Haswell EP product family processors or a single Intel Xeon E5-1600v3 product family processor.
Memory	
Architecture	2133 MT/s, 1866 MT/s, 1600 MT/s, and 1333 MT/s DDR4 registered, load-reduced Error Correcting Code (ECC) DIMMs.
Memory module sockets	Support for eight, 288-pin DIMM slots.
Memory module capacities	
RDIMMs	4 GB, 8 GB, 16 GB, and 32 GB
LR DIMM	32 GB and 64 GB
Minimum RAM	4 GB (RDIMM) and 32 GB (LR DIMM)
Maximum RAM	256 GB (RDIMM) and 512 GB (LR DIMM)
Raid Controller	
Controller type	PERC S130
Drives	
SSD	One or two 1.8-inch, uSATA SSD (s) .
Connectors	
Front	
USB	Two USB ports, one USB 3.0 – compliant port and one USB 2.0 – compliant port.
Internal	
SD card	One internal SD card dedicated for the hypervisor and one for vFlash support or redundant hypervisor.
PCIe Mezzanine Card	
PCIe Mezzanine slot	One PCIe x8 mezzanine slot supporting a single or dual port InfiniBand mezzanine card.

Video

Video type	Matrox G200 integrated with iDRAC.
Video memory	8 MB shared with iDRAC application memory.

Battery

NVRAM backup battery	CR 2032 3.0 V Lithium coin cell.
----------------------	----------------------------------

Environmental

 **NOTE:** For additional information about environmental measurements for specific system configurations, see dell.com/environmental_datasheets.

Storage temperature	-40°C to 65°C (-40°F to 149°F) with a maximum temperature gradation of 20°C per hour.
Standard operating temperature	Continuous operation: 10°C to 35°C at 10% to 80% relative humidity (RH), with 26°C max dew point. De-rate maximum allowable dry bulb temperature at 1°C per 300 m above 900 m (1°F per 550 ft).

Environmental

 **NOTE:** For additional information about environmental measurements for specific system configurations, see dell.com/environmental_datasheets.

Temperature

Maximum Temperature Gradient (Operating and Storage)	20°C/h (36°F/h)
Storage Temperature Limits	-40°C to 65°C (-40°F to 149°F)

Temperature (Continuous Operation)

Temperature Ranges (for altitude less than 950 m or 3117 ft)	10°C to 35°C (50°F to 95°F) with no direct sunlight on the equipment.
Humidity Percentage Range	10% to 80% Relative Humidity with 26°C (78.8°F) maximum dew point.

Relative Humidity

Storage	5% to 95% RH with 33°C (91°F) maximum dew point. Atmosphere must be non-condensing at all times.
---------	--

Maximum Vibration

Operating	0.26 G _{rms} at 5 Hz to 350 Hz (all operation orientations).
Storage	1.87 G _{rms} at 10 Hz to 500 Hz for 15 min (all six sides tested).

Maximum Shock

Environmental

Operating	One shock pulse in the positive z axis of 31 G for 2.6 ms in all operational orientations.
Storage	Six consecutively executed shock pulses in the positive and negative x, y, and z axes (one pulse on each side of the system) of 71 G for up to 2 ms.

Maximum Altitude

Operating	3048 m (10,000 ft).
Storage	12,000 m (39,370 ft).

Operating Altitude De-rating

Up to 35 °C (95 °F)	Maximum temperature is reduced by 1°C/300 m (1°F/547 ft) above 950 m (3,117 ft).
---------------------	--

Particulate Contamination

 **NOTE:** This section defines the limits to help avoid IT equipment damage and/or failure from particulates and gaseous contamination. If it is determined that levels of particulates or gaseous pollution are beyond the limits specified below and are the reason for the damage and/or failures to your equipment, it may be necessary for you to re-mediate the environmental conditions that are causing the damage and/or failures. Re-mediation of environmental conditions will be the responsibility of the customer.

Air Filtration Data center air filtration as defined by ISO Class 8 per ISO 14644-1 with a 95% upper confidence limit.

 **NOTE:** Applies to data center environments only. Air filtration requirements do not apply to IT equipment designed to be used outside a data center, in environments such as an office or factory floor.

 **NOTE:** Air entering the data center must have MERV11 or MERV13 filtration.

Conductive Dust Air must be free of conductive dust, zinc whiskers, or other conductive particles.

 **NOTE:** Applies to data center and non-data center environments.

Corrosive Dust

 **NOTE:** Applies to data center and non-data center environments.

- Air must be free of corrosive dust.
- Residual dust present in the air must have a deliquescent point less than 60% relative humidity.

Gaseous Contamination

Environmental



NOTE: Maximum corrosive contaminant levels measured at $\leq 50\%$ relative humidity.

Copper Coupon Corrosion Rate <math><300 \text{ \AA}/\text{month}</math> per Class G1 as defined by ANSI/ISA71.04-1985.

Silver Coupon Corrosion Rate <math><200 \text{ \AA}/\text{month}</math> as defined by AHSRAE TC9.9.

Getting help

Contacting Dell

Dell provides several online and telephone-based support and service options. If you do not have an active Internet connection, you can find contact information on your purchase invoice, packing slip, bill, or Dell product catalog. Availability varies by country and product, and some services may not be available in your area. To contact Dell for sales, technical support, or customer-service issues:

1. Go to **dell.com/support**.
2. Select your country from the drop-down menu on the bottom right corner of the page.
3. For customized support:
 - a. Enter your system Service Tag in the **Enter your Service Tag** field.
 - b. Click **Submit**.The support page that lists the various support categories is displayed.
4. For general support:
 - a. Select your product category.
 - b. Select your product segment.
 - c. Select your product.The support page that lists the various support categories is displayed.

Locating your system Service Tag

Your system is identified by a unique Express Service Code and Service Tag number. The Express Service Code and Service Tag are found on the front of the system by pulling out the information tag. Alternatively, the information may be on a sticker on the chassis of the system. This information is used by Dell to route support calls to the appropriate personnel.

Documentation feedback

If you have feedback for this document, write to **documentation_feedback@dell.com**. Alternatively, you can click on the **Feedback** link in any of the Dell documentation pages, fill out the form, and click **Submit** to send your feedback.

Quick Resource Locator

Use the Quick Resource Locator (QRL) to get immediate access to system information and how-to videos. This can be done by visiting **dell.com/QRL** or by using your smartphone and a model specific Quick Resource (QR) code located on your Dell PowerEdge system. To try out the QR code, scan the following image.



Free Manuals Download Website

<http://myh66.com>

<http://usermanuals.us>

<http://www.somanuals.com>

<http://www.4manuals.cc>

<http://www.manual-lib.com>

<http://www.404manual.com>

<http://www.luxmanual.com>

<http://aubethermostatmanual.com>

Golf course search by state

<http://golfingnear.com>

Email search by domain

<http://emailbydomain.com>

Auto manuals search

<http://auto.somanuals.com>

TV manuals search

<http://tv.somanuals.com>