

DELL™ Mini 3T1

User's Guide

Statement

Copyright © Dell 2010. All Rights Reserved.

Without the written permission of this company, no company or individual may make excerpts or copies of the content of this document in whole or in part, nor may it be distributed in any form.

Trademark Statement

Dell is a trademark of Dell Inc.









All other trademarks or registered trademarks in this document are held by their respective owners.





Notes

To ensure accuracy during product version upgrades or for other reasons, the contents of this document may be updated on occasion. Unless otherwise agreed, this document is provided to offer directions of use only. No descriptions, information, or suggestions in this document constitute any kind of express or implied warranty.

Safety Notice

Before using this cell phone, please read this section carefully. Please also ensure that any children understand this section's contents to ensure the correct and safe usage of this cell phone. For more detailed information, please refer to the information under the "Safety Warnings and Notes" section of this document.

	Switch off your cell phone in areas where the use of cell phone is prohibited or could cause interference/danger.			Do not place your cell phone or its accessories in appliances that have strong electromagnetic fields.
	Do not place your cell phone or its accessories in appliances that have strong electromagnetic fields.			Keep your cell phone away from magnetic equipment, as the phone's emissions may erase data stored in the equipment.
	Adhere to the relevant rules and regulations for use of cell phone in hospitals. Do not use your cell phone when you are near or around medical equipment.			Do not use your cell phone near areas of high temperature, or near areas containing flammable gas (such as petrol stations).
	Switch off your cell phone when boarding an airplane to prevent the wireless signal from interfering with the airplane control signal.			Keep your cell phone and its accessories out of the reach of children. Do not allow children to use the cell phone without supervision.

	<p>Switch off your cell phone near areas where high-precision electronic equipment is used. Otherwise, the cell phone may damage the equipment.</p>			<p>Use the batteries and battery chargers specified for this cell phone. Use of unapproved battery chargers may cause explosion.</p>
	<p>Do not disassemble your cell phone or its accessories. Only authorized service personnel should repair this phone.</p>			<p>Obey all local laws and regulations for using a cell phone. Respect the privacy and legal rights of other individuals.</p>

Contents

1 Understanding Your Cell Phone.....	6
Introduction.....	6
About Your Mini 3T1 Cell Phone	7
2 Getting Started with Phone Use	13
Installing and Removing Batteries	13
Installing and Removing the SIM Card.....	19
Installing a microSD Card.....	21
Removing a MicroSD card.....	21
Turning the Phone On or Off.....	22
Making a Voice Call.....	23
Making a Video Call	25
Answering a Voice or Video Call	25
During a Voice Call	25
Emergency Call.....	28
During a Video Call.....	28
3 Menu Operations.....	29
Main Menu Structure	29
Main Menu Selections.....	29
4 Settings	31
Phone setup	31
Display setup.....	32
Date and Time	32
Call setup	33
Network Settings.....	36

Connection Profile	37
Security Management.....	37
Reset Settings.....	40
5 Profiles.....	41
Activating Profiles	41
Personalization Setup	41
6 Call History	43
Outgoing Calls	43
Answered Calls	43
Missed Calls.....	44
7 China Mobile Service	45
Mobile Music	45
Games	45
Fetion	45
Mobile Video.....	46
Mobile Map.....	46
Mobile Stock	46
CM Reader	46
139 Mail.....	47
DCD.....	47
SIM Card Applications.....	47
8 Customer Service.....	48
Service Guide.....	48
Business Hall.....	48
Customer Manager	48
My Monternet	49
Software Update Service	49
Settings.....	49

9 Monternet.....	51
Off Line Browser Menu	51
On Line Browser Menu.....	53
10 My Favorites	54
Magic Box.....	54
Preset.....	54
Phone	55
Storage Card.....	55
MMS Cards	56
MSG search.....	56
Storage Status.....	56
Format.....	56
11 Messages	57
Setup	59
New and Sent Messages.....	61
Inbox	63
Outbox	64
Sent	64
Draft.....	64
My Favorites	64
Junk Mailbox.....	64
Voice Mail Box	65
Local Broadcasts	65
12 Phonebook.....	66
Phonebook.....	66
Group	69
13 Multimedia.....	70

Camera	70
DV	73
Music Player	73
Video Player	76
Recorder	77
14 Tools	78
Memo	78
Time	78
Calculator	78
Exchange Rate	78
Unit Conversion	79
Incoming Call Location	79
15 Connections	80
Bluetooth	80
USB Mode	80
PC Tools	80
GPRS Wizard	81
16 Other Applications	82
English Chinese Dictionary	82
Calendar	82
Electronic books	83
Games	83
17 Safety Warnings and Notes	84
Electronic Equipment	84
Medical Care Centers	84
Combustible and Explosive Areas	85
Traffic Safety	85
Storage Environment	86

Child Health	87
Operation Environment	87
Cleaning and Maintenance	88
Emergency Call	89
Using the Battery	89
Using the Charger	90
Using the USB Data Cable	91
Protecting the Environment	92
Electronic Message Products Toxins and Harmful Substance Declaration	92
18 SAR Description	94

1 Understanding Your Cell Phone

Introduction

Upon opening the phone gift box, check to ensure that all the items listed below are included. If any of the items are missing, or if you you have problems with documentation such as missing pages, contact your local retailer.

The following items are included in the gift box:

- One Mini 3T1 cell phone
- One travel charger
- One regional plug
- One USB data/charging cable
- One battery
- One stylus
- One microSD with the User's Guide and PC Sync Tool

About Your Mini 3T1 Cell Phone

Dell Mini 3T1 Cell Phone Features

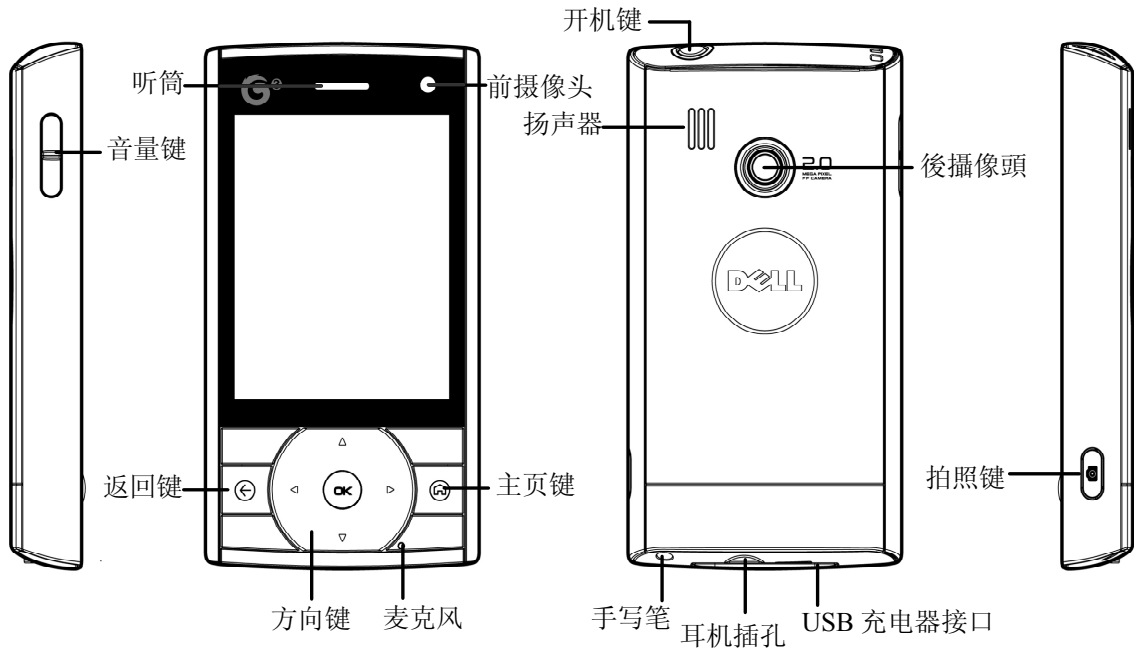

Key Assignments

Key	Functions
Volume Button	<p>During a call: Press up to increase the speaker volume. Press down to decrease the speaker volume.</p> <p>Ringer mute: a short press when receiving a call mutes the ringer.</p> <p>Ringer volume: in the Idle screen, a short press opens the ringer volume window.</p> <p>Menu navigation: in the Main menu screen, press the up/down keys to highlight the next icon in the vertical direction.</p>
OK Button	<p>Use to select an item on the screen and to activate an application. Press to go to the Main Menu screen.</p>
Home Button	<p>While in any application, press the Home key to end the application and go back to the Main Menu screen. While in the Main Menu screen, press again to go to the Idle screen.</p>
Navigation Disc	<p>Press the disc in the appropriate direction to navigate through menus.</p>
Back Button	<p>Press to go back to the previous screen.</p>
Power Button	<p>Press and hold to turn on or off the phone. Press once to lock/unlock the screen when the phone is active.</p>
Touch Screen Display	<p>Swipe left or right to navigate between menu panels.</p>

Connectors and Memory Card Slot

Ports	Functions
Headset Connector	Located at the bottom of the phone. Used to connect stereo headsets
MiniUSB Connector	Located at the bottom of the phone. Used to charge the phone and for connecting to a computer
microSD card slot	Located under the battery beside the SIM card holder

Cell Phone Screen





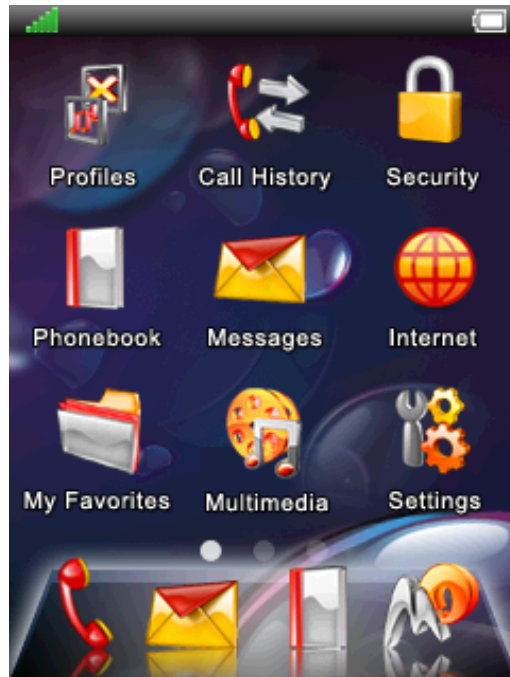



















Idle Screen



Main Menu Screen

Screen Icons

Displayed icon	Description
	Network signal strength indicator
	EDGE network availability indicator
	TD-SCDMA network availability indicator
	HSPDA network availability indicator
	Indicates that the SIM card and phone message inbox are full
	Indicates that the SIM card call record is full
	Indicates that the WAP push message mailbox is full
	Indicates that the multimedia message

	mailbox is full
	The current profile is set to "meeting"
	The current profile is set to "car"
	The current profile is set to "outdoor"
	The current profile is set to "private"
	The current profile is set to "silent"
	Indicates that call transfer is active
	Indicates that the memory card is inserted
	Indicates that UDisk is active
	Indicates that the alarm clock is set
	New message indicator
	Unread WAP push message indicator
	Battery life indicator
	Missed call indicator
	Unread message indicator
10:23	Shows the current time (this can be in either 24 or 12 hour format)
2010	Shows the current year
08-10 [Wed]	Shows the current date and day of week
China Mobile	Shows the current network provider

Accessing the Dial Pad

You can access the dial pad in one of the following ways:

- + In the Idle screen, tap the display.
- + In the Main screen, tap the handset icon that appears at the bottom of the screen.

Setting the Data and Time

You can set the date and time in one of the following ways:

- + In the Idle screen, tap the clock to open the **Data and Time** settings menu.
- + In the Main Menu screen, tap **Settings** to access the **Data an Time** settings menu.

2 Getting Started with Phone Use

Installing and Removing Batteries

Your Dell Mini 3T1 cell phone is powered by rechargeable lithium battery. Ensure that you install the battery properly before using the phone.

NOTE: The battery may have been slightly discharged prior to purchase, but should have enough power to turn on the phone.

Installing the Battery

To install the battery:

1. Press and slide the back cover towards the top of the cell phone, and then lift the back cover up.

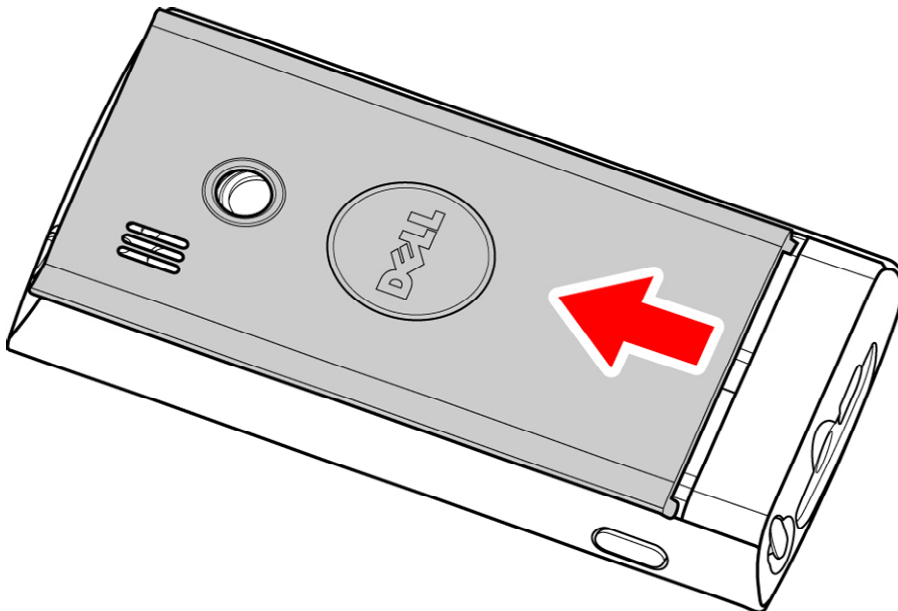

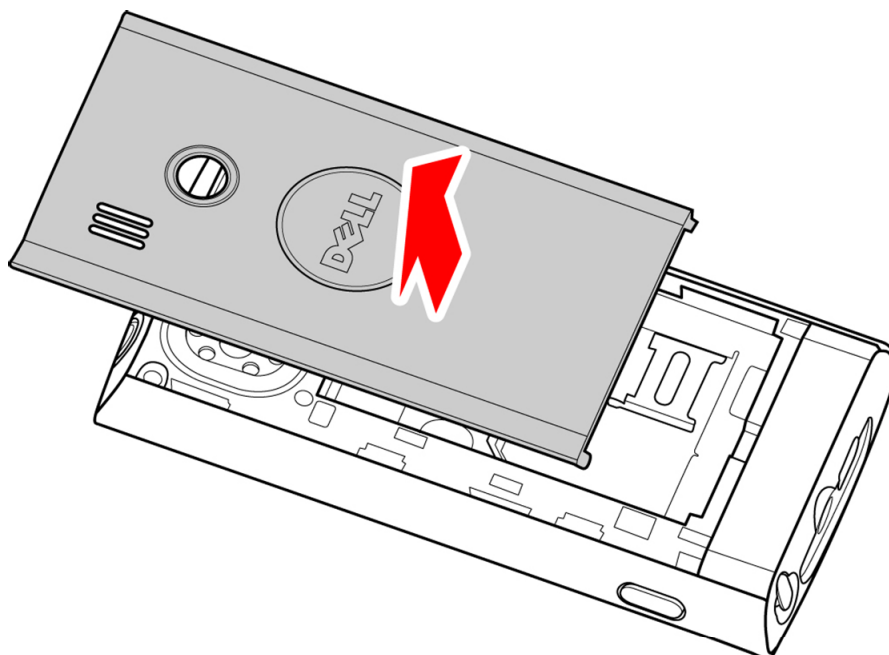

2. With the metal connectors of the battery facing down, align the bottom of the battery with the corner grooves for proper alignment and slide the battery into the battery compartment.

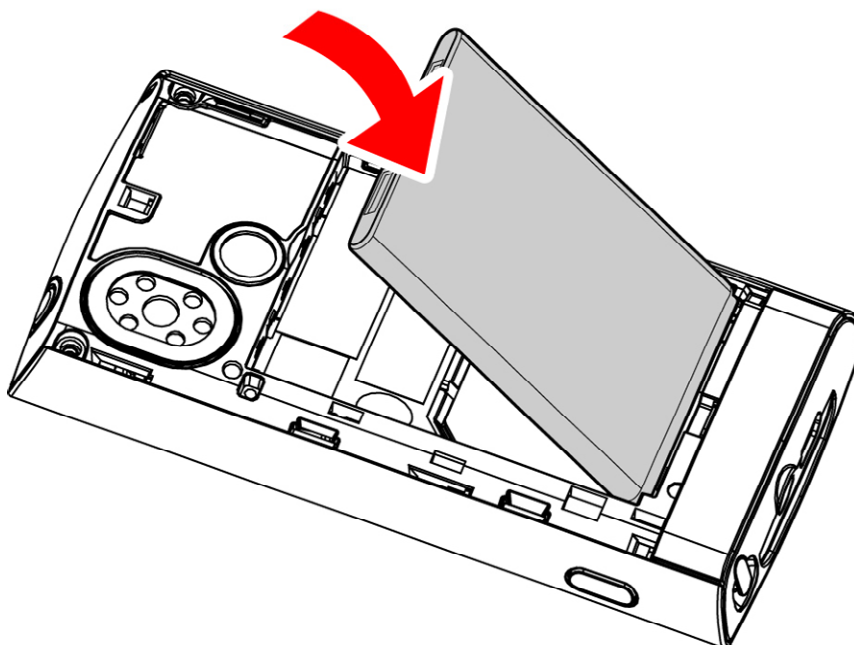

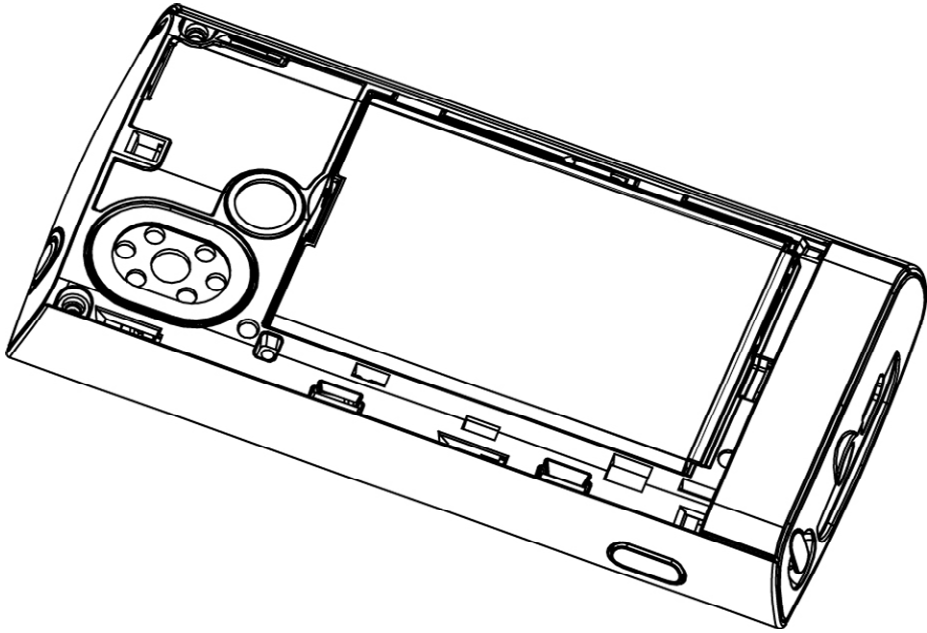

3. Align the back cover with the tabs on the back of the phone, and press while sliding the back cover into place.

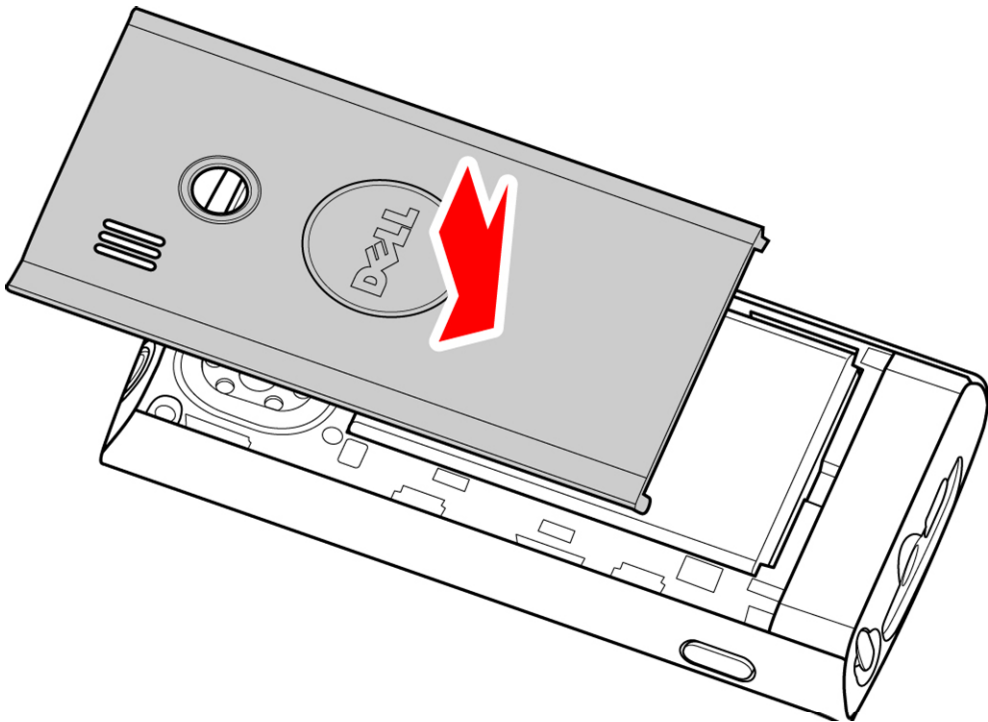

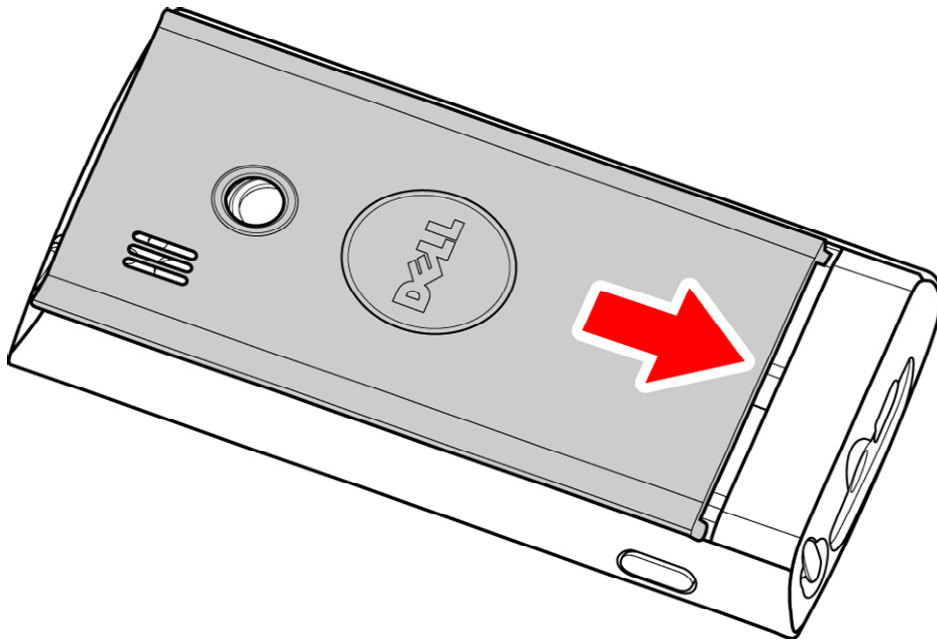



Removing the Battery

To remove the battery:

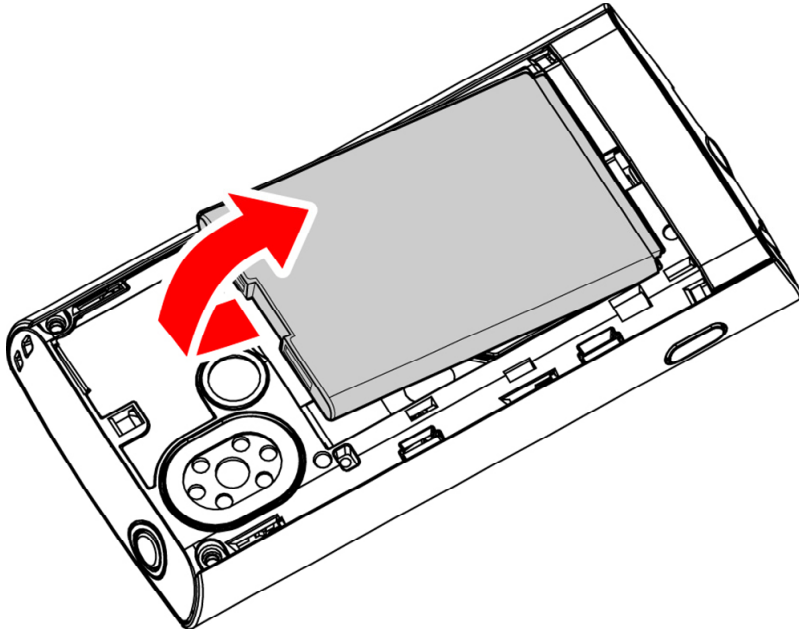
1. Turn off the phone.
2. With the back of the phone facing up, remove the back cover.
3. Lift the battery from the compartment along the tab on the top end of the battery as shown below, and pull out to remove the battery.



Battery Charge Status

The battery charge status icon  is displayed on the top-right corner of the phone's status bar. When battery charge is low, the battery charge status icon flashes and an audible warning alarm is produced. When the battery charge level becomes very low, the phone automatically turns off to protect the phone and allow some operation at a later time.

Important Information About Battery Use

- Charge the battery for at least 3 hours before first-time use.
- If the battery is not used for a prolonged duration, it will discharge automatically.
- The battery can be charged repeatedly. However, the battery will degrade with repeated use and will eventually have to be replaced.
- Do not damage, disassemble, or throw the battery in the trash. Doing so could cause a battery leak that can lead to excessive heat, an explosion or fire.

Charging the Battery

The Mini 3T1 comes with a travel charger. This phone should only be used with authentic Dell batteries and battery chargers.

Before using the travel charger, ensure that the battery is correctly installed.

To charge the battery:

1. Plug the charger power plug into an electrical outlet.
2. Connect the other end of the charger to the mini-USB connector on your phone.

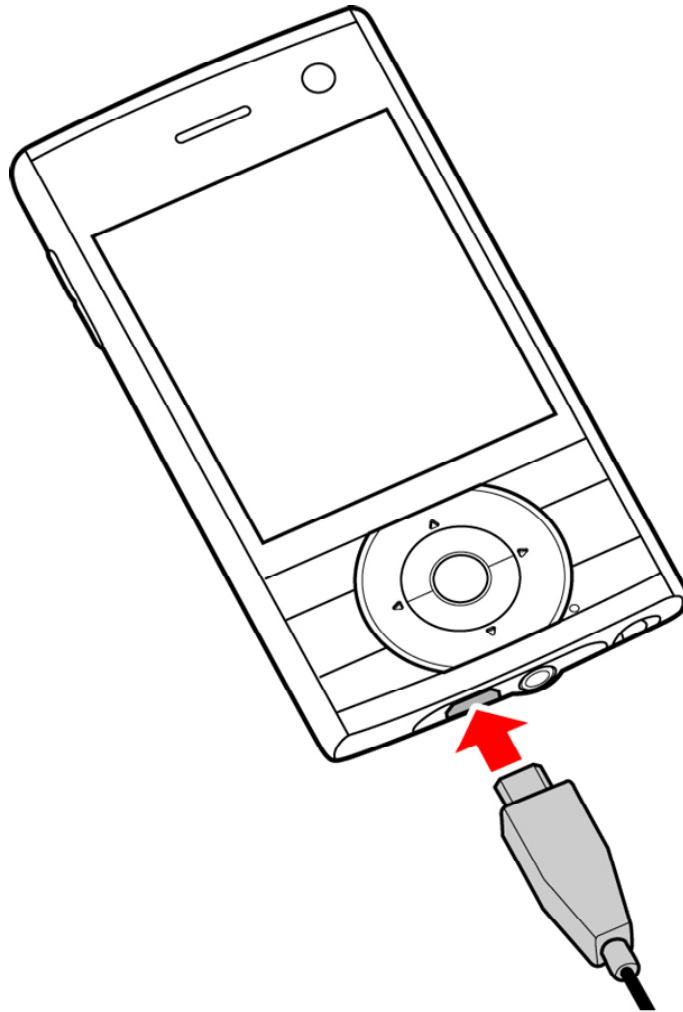

When the battery is charging, the battery charge status icon  animates until the battery is fully charged.

3. After the battery is fully charged, disconnect the charger from the phone and the electrical outlet.

Installing and Removing the SIM Card

The SIM card must be installed before you begin using your phone.

NOTE: Keep the SIM card out of reach of children.

CAUTION: The SIM card and its electrical circuits may be easily damaged by rubbing or bending. Ensure that you handle the SIM card carefully when installing and removing it.

Installing the SIM Card

To install the SIM card:

1. Press and hold the power button to turn off the phone.
2. Remove the battery (see "Removing the battery" on page 16).
3. Slide the SIM card into the SIM card slot. Ensure that the SIM card's metal contacts are facing down and the bevelled corner on the SIM card is facing the top of the phone.

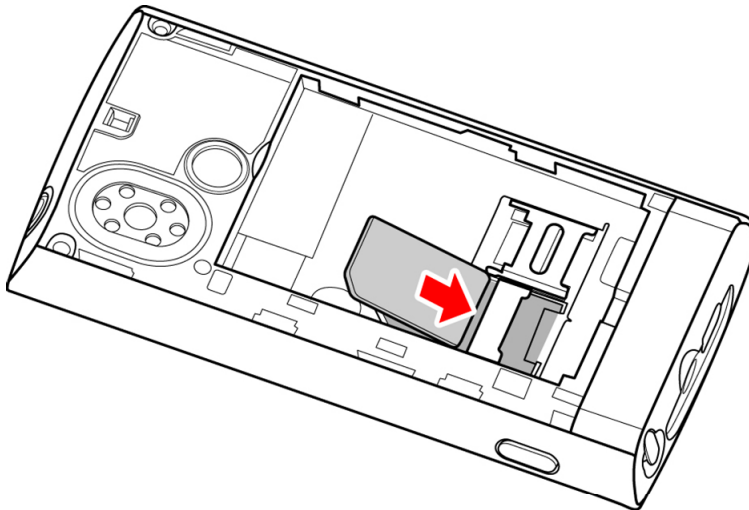

4. Replace the battery
5. Close the back cover

Removing the SIM Card

To remove the SIM card, follow the instructions in Installing the SIM card in the reverse order.

Installing a microSD Card

This phone supports microSD cards with a maximum capacity of 32GB.

To install the memory card:

1. Turn off the phone.
2. Remove the battery (see "Removing the battery" on page 16).
3. Lift the microSD card retainer upwards to unlock it. Slide the microSD card into the microSD card slot and press the microSD card retainer down until it locks into place.

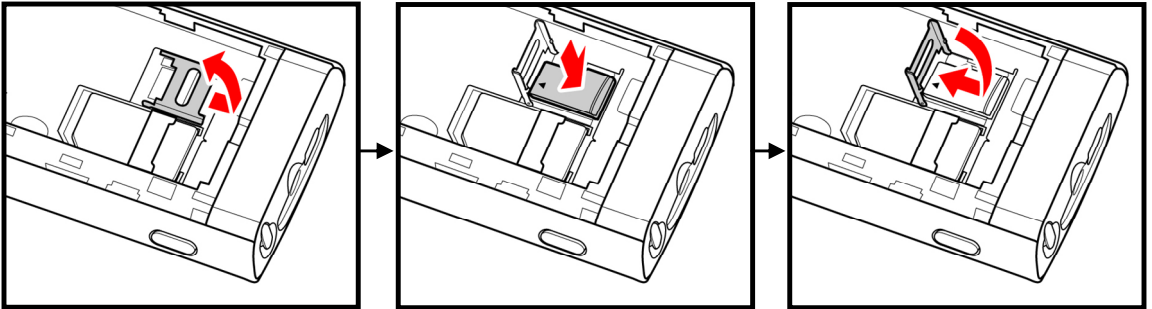

4. Replace the battery.
5. Replace the back cover.

Removing a MicroSD card

To remove the microSD card, follow the instructions in installing the microSD card in reverse order.

Turning the Phone On or Off

Turning the Phone On

Ensure that the USIM/SIM card is installed in the phone, and that the battery is charged. When the phone is off, press and hold the **On/Off Switch** to turn on the phone.

Turning the Phone Off

When the phone is on, press and hold the **Power Key** to switch off the phone.

Password Locking

If you have setup the phone password or PIN number locking function, the password will need to be entered to unlock the phone each time it is turned on. For more information about the setup and editing functions for the phone lock password, see the "Security Management" on page 37.

Phone Password

The phone password feature allows you to secure your phone from unauthorized use. The predefined password for your Dell Mini3T1 phone is set to 1234.

PIN1 Code

The PIN1 (Personal Identification Number) on your SIM card helps to prevent other users from accessing information on your SIM card. The PIN1 code is usually supplied with the SIM card. If you were not provided with a PIN1 code when you purchased the SIM card or if you have lost the PIN1 code, contact your service provider.

PIN2 Code

The PIN1 code is usually supplied with the SIM card. If you were

not provided with a PIN1 code when you purchased the SIM card or if you have lost the PIN1 code, contact your service provider. If you were not provided with a PIN2 code when you purchased the SIM card or if you have lost the PIN2 code, contact your service provider.

PUK Key

If the SIM card on your phone is locked, you must enter a PUK (PIN Unlocking Key). The PUK is usually provided with the SIM card. If you were not provided with a PUK key when you purchased the SIM card or if you have lost the PUK key, contact your service provider.

PUK2 Key

Some SIM cards have a PUK2 key that is required for unlocking a locked PIN2 key. If you were not provided with a PUK2 key when you purchased the SIM card or if you have lost the PUK2 key, contact your service provider.

Making a Voice Call

You can make a voice call using one of the following methods:

Direct dial: Tap the screen when the phone displays the Idle Screen to open the on-screen dialpad and select Voice Call to dial the number.

Directory dialing: From the Main Menu enter the phonebook. Select a contact and press Voice call.

Quick dial: Tap the screen when the phone displays the Idle Screen to open the on-screen dial pad. Tap and hold one of the digits from 2 to 9 to quickly dial an pre-assigned number.

NOTE: You can assign quick dial numbers in from Settings> Call Setup. For more information, see "Quick

Dial" on page 33.

SIM card location dialing: On the on-screen dial pad interface, tap the number pad and then the # key. The number stored in the corresponding location on the SIM card will then appear and can be dialed.

Calling National Numbers

To call a national number:

1. Enter the number to call using the on-screen dial pad.
2. Tap the dial key, or press the Voice Call icon to make a voice call.

To end the call, tap **Hang up**.

Dial an Extension

You can dial a telephone extension directly without having to enter it after connecting to a primary number.

To dial an extension:

1. Enter the primary telephone number using the on-screen dial pad.
2. Tap and hold the # key until a "P" key appears on the screen.
3. Enter the extension number using the on-screen dial pad.
4. Tap the dial key, or press the Voice Call icon to make a voice call.

NOTE: You can also enter multiple "P" keys.

Calling International Numbers

To call an international number:

1. On the on-screen dial pad, tap and hold the 0 key until the "+" symbol appears on the screen.
2. Enter the international calling code for the country you want to call.
3. Enter the phone number you want to call.
4. Tap the dial key, or press the Voice Call icon to make a voice call.

Making a Video Call

To make a video call:

1. Enter the number to call using the on-screen dial pad.
2. Tap the Video Call icon to make a video call.

Note: You can make video calls only when T or H networks are displayed on the screen.

Answering a Voice or Video Call

Tap **Answer to** answer a call.

To end the call, tap **Hang up**.

During a Voice Call

During a voice call, tapping the quick icon on the screen,

or tapping **more**, allows you to do the following:

Mute: Temporarily mutes the call. When the phone is mute, you will be able to hear the other person, but they will not be able to hear you.

Soft keyboard: Enters the dialing keypad interface.

Hands-free: Switches to hands-free mode. When using the hands-free mode, the audio is routed to the headset or speakers.

New Call: Allows you to dial a second number while you are on a call. After entering the number, tap the **Dial key** to make the second call.

Hold: Holds the current call, at this time neither user will be able to hear each other.

Record: Records the conversation. At this time, the menu will show the stop recording screen.

Message Record: Enters the message record window.

New Message: Enters the message editing window.

Adjust Volume

During calls, tapping the **Volume key** will change the volume level. Press up to increase or down to decrease the volume.

New Message

During a call, when there is a new message a tone alert will be heard.

Answer New Call

If call waiting is activated and a new call comes in during another call, the phone will display the incoming call menu. You can press the **Answer key** to receive the new call. The first call will automatically be placed on hold. If you do not wish to answer the new call, you can press the **Reject key** to hang up.

Answering Two Calls Simultaneously

When you are on two calls simultaneously, tapping the quick button on the screen or tapping **more** will perform the following:

Switch: Activates/holds the current call, when the call is held neither user will be able to hear the other.

Hang up: Hangs up one of the calls.

Record: Records the conversation.

Mute: Temporarily mutes the current call.

Phone Meeting: Allows multiple people to start a shared conversation, and can also allow individual conversations with specific attendees.

Phonebook: Enters the phonebook window.

New Message: Enters the message editing window.

Phone Meeting

During a phone meeting, tapping the quick button on the screen or tapping **more** will perform the following:

Hold conversation: Holds the current phone meeting. at this time no meeting attendee will be able to hear any other party:

Record: Records the conversation.

Mute: Temporarily mutes the current call.

New Call: Allows the user to make a new call or call a new extension.

Meeting Attendees List: Allows the user to see a list of the meeting attendees.

Phonebook: Enter the phonebook window.

New Message: Enters the message editing window.

Emergency Call

In countries which use the digital GSM network or TD-SCDMA networks, if you are located in an area covered by the network, you should be able to call the emergency services. Even if a SIM or USIM card is not installed, you should still be able to make emergency calls. Sometimes, due to the network, the environment, or interference issues, emergency calls cannot be made.

During a Video Call

During a video call, tapping the quick button on the screen or tapping **more** will allow you to perform the following:

Record: Records the conversation.

Rear or Front camera: Switches between the two built in cameras.

Mute: Temporarily mutes the call.

New Message: Enters the message editing window.

Turn off the camera: Turns off the camera.

Zoom: Adjusts the focal distance of your camera.

Brightness: Adjusts the brightness of your camera.

Screen Mode: Sets the screen mode.

3 Menu Operations

This section provides information about the functions and options available on your phone's Menu.

Main Menu Structure

The phone's function menu consists of **Profiles, Call History, Security, Phonebook, Messages, Internet, My Favorites, Multimedia, Settings, China Mobile Services (139 Mail, DCD, Mobile Stock, Online Music, Fetion, Monternet, Mobile Map, Mobile Video, CM Reader, MyPIM , STK and Customer Services), English to Chinese dictionary, Tools, Calendar , Games, Connections and Timers**

Main Menu Selections

To switch between the menu panels, swipe your finger across the screen from left to right. To open a menu tap the menu item.



Panel 1



Panel 2



Panel 3

4 Settings

The following are the options available in the Settings menu: **phone setup, display setup, date and time setup, call/video sharing setup, network setup, connection setup, security setup and reset to factory settings.**

Phone setup

The phone setup allows you to change the following settings: **language, font size, calibration, auto power on, auto power off.**

Language

Allows you to select a language - **Simplified Chinese or English.**

Font Size

Allows you to set the font size for the display; there are three options - large, medium, and small.

Calibration

Allows you to calibrate the touch screen. Using the styus, touch the mid point of the X that appears on the screen three times. A message is displayed on the screen when the calibration is complete.

Auto Power On or Off

Allows you to enable or disable the phone auto power on or off feature. To activate this feature, set the time and duration for the phone to turn on or off. The available settings are: **once, every day, weekdays, weekends.**

Display setup

The display setup allows you to change the following settings: **wallpaper, backlight time, keypad backlight and brightness.**

Wallpaper

Allows you to set a background picture for the phone's standby mode. In the picture browser window, tapping the **return** icon above the picture will return to the normal browser interface. Click the **setup** icon to set the current picture as the wallpaper.

Backlight Time

Allows you to set the wait time until the backlight turns off. The available options are: **10 seconds, 15 seconds, 30 seconds or 60 seconds.**

Keypad Backlight

Allows you to set the keypad light to **On** or **Off**.

Brightness

Allows you to set the backlight brightness. The available options are: **bright, standard, and power saver.**

Date and Time

Time: Open the time setup screen and allows you to set the time.

24 hours: Sets the time display format to be 24 hour.

Date: Opens the date setup screen and allows you to set the date.

Date format: Opens the date format screen and allows you to select the date display format.

Time zone: Opens the world clock screen and allows you to select a time zone.

Call setup

The call setup allows you to change the following settings: **call waiting, bar calls, call diversion, video call setup, fixed dial, headset automatic response, IP number, automatic redial, quick dial, minute display and connection alert tone.**

Call Waiting

Activates the call waiting feature. If this feature is activated, an engaged tone is heard by a third caller when the phone is busy.

NOTE: Call waiting services can only be used by requesting the service provider.

Bar Calls

Bar Calls feature allows you to restrict the incoming or outgoing calls. Your internet service provider can provide a password to help you activate call restriction.

Incoming calls: Allows you to set call barring for **all incoming calls** or only for incoming calls while in **roaming** mode.

Outgoing Calls: Allows you to restrict outgoing calls to **international long distance, only local numbers** or **all dialed numbers**.

Cancel all restrictions: Allows you to cancel voice call restrictions. You must enter a password to cancel call restrictions. The standard factory password is **0000**.

Modify Password: Allows you to modify the network provided password for your restrictions.

Call Diversion

Call diversion feature forwards all incoming calls to a specified

phone number based on your preference.

Voice call: Allows you to set voice call diversion based on the following options: **unconditional transfer, transfer when busy, transfer on no reply, and transfer when unreachable.**

Video calls: The options available in video call diversions are the same as those for voice calls.

Cancel all transfers: Allows you to cancel all call transfers.

Status check: Allows you to verify the current call diversion status.

Note:

The ability to successfully set up call transfer is related to the network and SIM card. The system will give appropriate prompts.

When setting up your incoming call transfers, you need to enter a correct telephone number. The incoming call can be transferred to the assigned telephone number.

If call diversion does not work as expected, verify the phone number you have assigned for the transfer.

Video Call Settings

The options available in the video call settings are: **send picture** and **switch to voice call**. The **send picture** option allows you to set a picture as a substitute for camera image during video calls.

Fixed dial

Users with the fixed number setup can only call certain telephone numbers. Telephone numbers not set cannot be dialed. Enter into the fixed number menu, select **activate**, the phone will require you to input the PIN2 number (provided by your internet service provider), then you will be able to activate the fixed call functionality.

(If it is currently activated, select **terminate** and you can stop the fixed number function). In the **fixed number list** the fixed number contacts are listed. In the fixed number list, by tapping the **select item** key you can **create, delete, delete all** and see the **internal memory status**.

Note:

The number of telephone numbers which can be stored in the fixed dial depends on the service provider.

Earphone Auto Answer

Allows you to set your phone to automatically answer incoming calls when connected to a headset. When this feature is activated and the headset is connected, the phone automatically answers a call if no activity happens for 10 seconds.

IP Code

Allows you to set a IP number for your phone.

Auto Redial

Allows you to activate the automatic redial feature. After activating this function, when a dialled number is unanswered, the phone automatically redials the number again.

Quick Dial

Allows you to set the quick dial feature. The 2 to 9 keys can be assigned quick dial numbers. If these digits already have numbers assigned, on the keypad tapping and holding a key will call the corresponding number. If these digits do not have numbers assigned, a prompt "number is empty" will appear.

Minute tone

Turn the minute prompt on or off. If this function is activated, during

a call, on the 50th second of every minute an audio prompt will be played.

Connection tone

Allows you to activate the audio prompt when calls are connected. If the connection prompts are active, when calls are connected, an audio prompt is heard.

Network Settings

Automatic selection: Your phone will first search for the original network, then it will search through the network table on the stored SIM card. If all of these fail, any network that has roaming agreement with your original network can be connected.

Manual select: The system will automatically search the network, and then provide a list of networks to which you can be connected. You can select the network you want. When performing operations on the network, the phone will provide the related prompts such as success or failure messages.

Preferred network: When searching for a network, the system chooses the connection network based on your setup network information.

Network modes: Select the system connection network mode. The following are the available options: only 3G networks, only 2G networks, and 3G networks having priority. If you select the 3G networks having priority option, the phone searches initially for a 3G network. If no 3G network is detected, it then searches for 2G networks.

Connection Profile

The Connection Profile menu allows you to setup the connection method for accessing the network. There are preinstalled profiles (CMWAP, CMNET, DCD and DCD Test) set according to China Mobile Network connection setup requirements. If you would like to create a new connection setup, you can do so in the custom list.

Touch **Select** to perform the following operations:

Save as: Allows you to save another network connection setup the system setup cannot be replaced.

Application: Allows you to select the connection method for accessing the network. Possible selections are WAP connection, Java connection, Streaming media connection, MMS connection.

View Setup: Allows you to view information about the current connection such as the name, homepage, multimedia message centre and bearer type.

Gateway: Allows you to set the gateway as open or closed.

Security Management

The Security Management menu allows you to change the following settings: **phone lock**, **PIN**, **guard wall** and **password**.

Phone Lock

This function locks the phone, and prevents others from using your phone without permission. To unlock, you need to enter a password (factory set password is 0000).

At Once: When this function is activated, entering the correct password will immediately lock the phone and return to the standby interface.

Automatic lock: With this function activated, when the correct lock password has been entered, if the user does not carry out any actions on the phone for a specified period of time, it will lock.

Off: The phone has no lock function. If you have already set phone locks, you need to enter the correct lock password to be able to unlock it.

PIN

PIN1

Activate: select active or turn off PIN1. Use the SIM card PIN number. the PIN number is required to turn on the phone (factory set password is 1234), otherwise you can only make emergency calls such as to 112. after turning off the PIN1 number, you do not need to enter the PIN number when turning on the phone.

Change PIN: Allows you to change the PIN based on your preference.

PIN2

Change PIN2: Allows you to change the PIN2 number based on your preference.

NOTE: Ensure that you note down your changed PIN, as you will not be able to see important personal information without entering the PIN. If assistance is required, contact the service center.

Guard wall

Incoming call guard:

Do not answer list: Allows you to add or delete telephone numbers

to the do not answer list

Only answer list: Allows you to add or delete telephone numbers to the only answer list

Setup: Allows you to setup the incoming calls firewall protection

Privacy information

This function is used to protect your personal documents. It will password protects all protected content. To unlock, you must enter a password (factory set password is 0000).

On/Off: Allows you to setup your private firewall. this requires password entry verification.

Protected items: Allows you to set up and specify the specific phone content areas to secure with the guard wall.

After activating the privacy guard wall, to access the protected content, you must enter the private guard wall password.

SMS guard

Rubbish numbers: Create or delete junk numbers. When messages are received from junk numbers, the messages are automatically placed in the junk mail.

Prompt mode:

Trash SMS prompt: When you receive junk messages, a prompt window will appear on the Idle screen; No audio alert will be heard.

Normal SMS prompts: When you receive junk messages, the prompt will be the same as when you receive regular messages.

Settings:

Junk number refusal: When you receive messages from the junk numbers, they will be automatically put in the junk messages box.

Only cell phone messages: When you receive messages not sent from cell phones, they will be automatically put in the junk messages box.

Turn off: Allows you to turn off the short messages firewall function.

Change the Password

Allows you to change the lock password (factory setting is 0000). When changing the password you need to enter the old password first, and then you need to enter the new password twice before it becomes effective.

Reset Settings

Before resetting the phone to restore it to its factory settings, you must enter the protection password. After confirmation you can enter the restore to factory settings menu selection window.

Restore Factory Settings

This option can restore the settings to its original factory values. Using this option does not delete your saved information such as phone book entries or messages. It only repairs the phone's working settings. Settings that are reverted include features such as ringtone and profile.

Restore Settings and Data

This option restores the settings to its original factory values. Using this option deletes personal information such as the phone book and messages (not including information stored on the SIM card). After restoring the settings, the phone turns off automatically. Turn on the phone to make calls or perform other functions.

5 Profiles

Profiles are a group of preset special definitions which you can activate quickly. The phone provides a group of default profiles including: **standard profile, meeting profile, car profile, outdoors profile, silence profile** and **flight mode profile**. Each profile has default factory settings. The users can modify and store the profiles to meet their personal preferences (apart from silence and flight profiles).

Activating Profiles

To start using a profile, tap the appropriate profile in the Profiles menu.

Personalization Setup

Touch **Option** → **Edit** to enter the personalization setup window. You can personalize any of the variables of the phone profiles. Personalization setup includes the following:

Voice call: Allows you to select the incoming voice call ringtone. To set, open the ringtone select window and touch to play the currently selected ringtone. Touch the screen again to stop playing the ringtone. Touch set up to set the selected ringtone as the ringtone for voice calls.

Video call: Allows you to setup the incoming video call alert tone.

Ring volume: To adjust the ring volume, increase the ring volume control window. Press the volume up button on the side of the

phone to increase the ring volume. Press the volume down button on the side of the phone to reduce the ring volume. Touch **hang up** or wait for 3 seconds to confirm the settings. A message appears on the screen to indicate that the volume has been adjusted.

Ring type: Allows you to set the ringtone type. The available options are: **continuous** or **incremental**.

Message tone: Allows you to set a tone to indicate if a message is received.

Email tone: Allows you to set a tone to indicate if an E-mail or multimedia message is received.

Key tone: Allows you to set a tone to indicate touch or tap on the keys.

Alarm volume: Allows you to set the tone for the alarm and calendar reminders.

Phone on/off tone: Allows you to set a tone that is heard when the phone is either turned on or off.

Vibrator: Allows you to enable or disable the phone vibrate mode.

Receiver volume: Allows you to set the speaker volume.

6 Call History

The Call History menu stores the recently dialed numbers, received calls, missed calls, and the call time. To view the recent call record, tap a key on the standby screen when the phone is not locked.

Outgoing Calls

In the call record window, select **dialed numbers** to enter the dialed number window. Press **option** to perform the following operations:

Store: You can store the numbers you want to store in your phone book.

Voice Call: You can enter into a voice call with the stored number.

Video Call: You can enter into a video call with the stored number.

IP call: In front of the phone number an **IP** number is automatically added, and then the number is called.

Send message: You can send a message or multimedia message to this number.

Send data: You can send this number as the content of either a message or multimedia message.

Edit: You can go to the keypad and edit this phone number, and then call it.

Delete: You can remove unwanted records.

Answered Calls

Operations on received numbers are the same as those on dialed numbers.

Missed Calls

Operations on missed calls are the same as those on received numbers.

7 China Mobile Service

The China Mobile Services are value added mobile services from China Mobile. It provides users with convenience and up to date information services. The user can subscribe to receive mobile information services such as wireless music, Games, Neww, Weather, Fetion IM, Cell Phone Videos, Phone Book Management, Information, Online Finance, New Service Recommendations and Monternet.

Mobile Music

Mobile Music is a mobile entertainment data service from China Mobile. Using your cell phone's wireless internet you can listen to music and as well as other music services such as music downloads, music sharing, music playing, and music exchange.

Games

Games is a mobile entertainment data service from China Mobile that allows you to enjoy all kinds of multimedia games preloaded on the device or via wireless data network.

Fetion

Fetion is a instant messaging service from China Mobile that

provides communication entertainment as well as a business utility . Using Fetion you can chat, exchange documents, or make voice calls in real-time with other subscribed users.

Mobile Video

Mobile Video is a brand new additional mobile data service by China Mobile. Using your phone's wireless network you can watch all kinds of brilliant video content.

Mobile Map

A mobile data service from China Mobile, that helps you find numerous points of interest on a map around your current location.

Mobile Stock

A mobile data service from China Mobile that can help you receive financial information, check the stock market and perform online trades.

CM Reader

CM Reader is an electronic reader service from China Mobile. Using your phone's wireless network you can download from a library of literary selections for you to read on your mobile device.

139 Mail

China Mobile's email service that can be access on the web or any enabled mobile devices.

DCD

DCD is a China Mobile subscription service that provides you with customizable up to date news and weather on your mobile device.

SIM Card Applications

SIM card applications include content such as newspapers, Feition, airline enquiries and SIM card zone introductions.

8 Customer Service

Service Guide

The Mini 3T1 after sales service telephone number is:

Business Hall

10086 hotline

Click on the menu to directly dial 10086

SMS Hall

Press the menu to directly send a message containing the contents "10086" to 10086

About e100

e100 is a one stop electronic self-help service provided by China Mobile for its customers. it mainly includes an online business platform, 10086 hotline, message business platform, palmtop business platform and self-service terminal service channel.

Customer Manager

Setup a customer manager contact telephone. as soon as the setup is complete, you can directly call the setup number.

My Monternet

This Monternet service provides the opportunity to check, and return purchased goods.

Monternet

Open the browser, open the China Mobile Monternet main page wap connection.

Monternet Messages

1. Check or return purchased SP message services, please send 0000 to the service provider number.
2. Return all purchased SP short message services, please send 00000 to the service provider number.

Monternet Multimedia Messages

Check or return purchased SP message services, please send CX0000 to the SP service provider number.

Software Update Service

Provides information of the phone's current software version, and any new available version from CMCC's service department.

Settings

Select customer service settings and you can perform the following operations:

Service hotline: The preset number is set to 10086, and it can not be set as blank. after entering this menu unless you do not change

any parameters, you will have to setup and store a number.

Customer manager number: You can setup the customer manager name and number.

9 Monternet

This phone has wireless internet functionality meaning you can constantly keep close contact with the whole world. It provides even more convenience for visiting the internet.

If you wish to use WAP to visit web pages, you must:

1. Please enquire whether your internet service provider and the service provider who offer the necessary service can provide this type of service, along with information about the prices. The internet service provider will also provide you with information on using their services.
2. You can perform the correct browser setup from your telephone.
3. Use the WAP browser to visit the internet and perform the related tasks.

Note:

Use GPRS/EDGE or TD-SCDMA to connect to web pages. and confirm whether the ISP offers this function, and whether they can provide it for you.

Off Line Browser Menu

Homepage

The homepage allows you to simply and directly connect to the China Mobile Monternet homepage.

Bookmarks

You can store network addresses in your browser.

In the bookmarks listing window touch the **select or OK** key to

carry out page operations such as **Go To URL, Read, Edit, and Refresh.**

Quick Save Web page

In your browser you can store the web pages you need in the quick save list. After storing them you can read the web pages while off line. In the quick save web page interface, press **option** to carry out **browse and delete.**

History

To see the addresses of web pages you have visited, touch the **select or OK** key and perform either **browse and delete** operations.

Go To URL

Go into the input web page address window, after confirmation you can directly connect.

Go To Last Page

After selecting this item, you can directly connect to the last browser page.

Browser Setup

Go into the browser setup window, you can perform tasks such as **connection setup, delete Cache, picture download, background music and download location.**

On Line Browser Menu

When browsing a web page, by tapping the select or OK key, you can add to bookmarks, go to home page, bookmark, go to URL, refresh, select, quick save web page, record history, and perform browser and application setup.



Browser Screen

10 My Favorites

Magic Box

Wireless Java is an application that you can carry with you in your cell phone. Here, at the time and place of your choosing you can find all kinds of Java software. After downloading it you can conveniently enjoy many internet services.

Applications

Store Java internet downloads here.

Download

10 bookmarks can be stored, and URL records are remembered to facilitate your internet browsing.

Storage Status

You can see the system memory and save user content on your phone.

Profile

Set the connection method for accessing the network. Connection setup operations can be seen on the **setup** menu's **connection setup**.

Preset

Shortcut to all preloaded audio files and preloaded images that can be used as a ringstone and wallpapers for your phone.

Phone

You can access all storage folders you have in the phone memory or in the memory card. All the preset folders such as: My recorder, My movies, My photos, ebook and Java; are accessible from here.

Storage Card

With this cell phone, you can connect the memory card with a PC via a digital cable, just like a U-card. Its operation is the same as a standard U card. The capacity of the memory card depends on the capacity of the purchased card.

Recordings, videos, or files like MP3s downloaded from the internet can be saved on the memory card. you can also save pictures (including photographs), electronic books, and downloaded ring tones.

When disconnecting the U card, please first remove from the PC: select the  icon, click the right mouse button, and select "remove or eject hardware". When you see the following prompt, select "stop". When the system displays "USB device can be safely removed", click confirm to confirm the removal. Now you can remove the USB connection cable.

When it has not been disconnected, removing the USB connection cable could cause abnormalities and data loss in the memory card. Please remember to back up your documents to prevent data loss. If there are abnormalities with your memory card, please format the card.

It is forbidden when it is not disconnected to remove the USB data connection cable.

When not in standby, removing the USB connection cable will cause the phone to return to the standby screen.

MMS Cards

Enter the multimedia celebration cards list window. it includes birthday cards, anniversary cards, romantic cards, scenic paintings, and humorous cards. select the card you wish to browse. in the window you can add the card to the multimedia message and send it.

MSG search

Search for any information stored in the phone by entering a key word to search for in any messages, files, phonebook or call history.

Storage Status

Check the internal memory of the phone system, as well as the user memory and the usable and remaining space of the memory card.

Format

Format the phone and memory card. After formatting, all the files on your memory card and phone will be lost.

Phone User Storage: Format the phone user storage.

Memory Card: Format the memory card. You can use the PC port to format the memory card. When using the PC port to format the card, you can only choose FAT16 format. If other format memory cards are used it could cause abnormalities.

Note:

When there is no FTA16 format PC port, please do not use the PC to format the memory.

11 Messages

The Mini 3T1 supports the sending of short messages of at most 1530 English letters or 670 Chinese characters.

Multimedia messages include text, picture and sound content. Using the multimedia message service, not only can you send and receive images and text, you can also receive the sound files attached to messages, allowing you to fully enjoy the content. Multimedia messages use the color screen to bring you a fresh and realistic audiovisual experience.

Note:

The Multimedia message service requires the support your network operator or service provider.

The maximum size of a multimedia message this phone can receive is 300KB. If the size of a multimedia message exceeds this, the phone cannot receive it. The phone allows the sending of at most 300KB multimedia messages.

Note:

You may need to pay a charge to your network operator or internet service provider for each multimedia message you send.

The multimedia message service supports the following formats:

- Pictures: JPEG, GIF, WBMP, PNG, BMP.
- Sounds: MID, AMR, MP3, AAC and WAV.
- Video: MPEG4, 3GP.

If you receive a message containing content in an unsupported format, this content will not display or be played.

Note:

There are many reasons which may lead to a multimedia message sending failure, so please try not to use multimedia messaging to send essential content.

In the message application, you can write, send, receive, read, and edit messages. When receiving a new message, the phone will:

1. Display the unread message icon and number of unread messages on the main interface. The title bar will display the unread message icon.
2. Display the unread message icon continually on the screen until the user has read all unread messages.
3. When the mailboxes of both the SIM card and phone are full, every time a new message is received a prompt will appear, until the user has deleted some messages. The phone can hold 1200 short messages, from which 200 can be long short messages. The number of multimedia messages that can be stored depends on the phone storage space. The SIM card storage will be different for different SIM cards.

Setup

From the main Messages screen, press **Option** to see the following selections:

SMS settings

Setup the parameters for short message operations as follows:

SMS Center: The SMS services centre number is provided by your network operator. **Message Sent.**

Auto sign: If this function is activated, every sent short message will automatically have a signature added to it.

Edit Sign: Compose or edit your auto signature information.

Arrive report: This is used to confirm that a short message you have sent has been received.

Store in SIM: Setup the storage location for messages.

Valid period: Setup the period of time for which a sent short message is stored in the message center.

Save sent: Decide whether or not to automatically keep sent messages.

MMS settings

Setup the parameters for multimedia message operations as follows:

Connection profile: Setup the multimedia message connection network.

Sending settings: Set the parameters relating to the multimedia message sending operations, including **Validity period, Priority, Read report, Delivery report and Save sent.**

Receiving settings: Setup the parameters for multimedia message receiving operations, as shown below:

Receive now: Setup multimedia message receiving: automatic or manual receiving.

Reply: When someone sends a multimedia message, requesting that the user sends a confirmation after reading it, the user can decide whether or not to permit the system to automatically send the response.

Auto Signature: If this function is activated, every sent short message will automatically have a signature added to it.

Filter: The user can setup a filter list and store the addresses of senders from whom they do not wish to receive messages. The filter list can hold at most 20 addresses. When there are more than 20 the system will provide a prompt.

Delete all mms

Deletes all sent and received MMS messages.

Reset Settings

Return the message settings to the defaults. follow the prompts provided by the system.

T-Backup

Backup/Restore short messages on the phone to the microSD card.

Quick text

View, delete, and modify templates.

Storage status

See the current message storage status on the phone and SIM card including SMS, MMS, and WapPush.

New and Sent Messages

New and Sent Short Messages

From the main menu click the **message** icon to enter the message window. Select **New Message** to enter the new message window:

1. You can select the right hand side "**to**" edit box. You will then enter the number entry screen, directly enter the recipient number on the on-screen keypad, press **option** to perform the following operations:

Send (When the recipient is not blank this item will appear): send this short message.

Message record: Can enter the message record menu.

Newest Contacts: Enter the newest contact list window.

Group: Enter the group select window.

Note:

If there are more than 20 recipients, the phone will automatically warn that there are an excess number of recipients.

2. You can enter contact people or common expressions into your short message. In the message edit window, click **option** to perform the following operations:

Insert Contact: Enter the telephone book and select the contact you wish to insert into the message.

Insert a Template: Enter the commonly used phrase list and selected the required phrase.

Save as a Template: Take the currently edited short message and save it as a template.

Save as Draft: Take the currently edited message and store in drafts.

3. When the recipient is not blank, tapping the **send** key will send the short message.

Notes:

This phone supports long short messages.

When messages are sent via the message network service, the phone will send a message successful message. This means the phone has sent the message to the message center. However, this does not mean the message has already been sent to the required address. If the message was sent successfully, the message will be saved in the sent message mailbox. If the sending failed, the message will be saved in the outbox.

New and Sent Multimedia Messages

From the main menu press the "message" icon to enter the message window. select **New Multimedia Message**, to enter the new multimedia message window:

1. Edit recipient: Click the edit box "to" on the right hand side, enter the recipient edit interface. Enter the recipient's contact details, and press **option** to perform the following operations:
 - Message record:** Enter the message record menu and select the recipient.
 - Group:** Enter the group select window.
 - Preview Message:** Preview the multimedia message content.
 - Message Details:** View detailed information about the multimedia message.
 - Save as Draft:** Take the currently edited multimedia message and store in drafts. This item will only appear if the recipient, title, or information content has been edited.

Note:

If there are more than 20 recipient numbers, the phone will automatically warn that there are an excess number

of recipients.

2. Edit title: Click "title" to enter the document edit screen. Enter the title of the multimedia message. Press **option** to perform the following operations:

Preview Message: Preview the multimedia message content.

Message Details: View detailed information about the multimedia message.

Save as Draft: Take the currently edited multimedia message and store in drafts. This item will only appear if the recipient, title, or information content has been edited.

3. Edit message content: click "message content" to enter the content edit screen. When editing, press **option** to active the items.

Edit Text: Edit the multimedia message text content.

Insert: Insert the required multimedia message content.

Preview Message: preview the edited multimedia message content.

Arrange: Set the location of the picture and text.

Delete: Here you can delete the pictures, video, sounds, and text on the page.

New Page: Create blank page.

Clear Page: Clear all the content from this page.

Delete Page: Delete the page.

Inbox

Select "inbox" to enter the message list window. Press **option** to **reply, forward, save sender number, move to My Favorites folder, move to junk mail, delete or sort** the message.

While reading, press option to perform the following operations,

such as **reply, forward, extract information, delete and copy.**

Outbox

Messages which have not been successfully sent are saved in the outbox. Press **option** to perform the following operations, such as **resend, delete, sort, resend, edit and delete.**

Sent

In the sent list window, click this **option** to perform the following operations, such as **forward, delete, move to My Favorites and sort.**

Draft

In the draft message list interface, press **option** to perform the following operations, such as **edit, delete and sort.**

My Favorites

My Favorites folder is used to store your messages from the inbox and sent message boxes. In the message list interface, press **option** to perform the following operations: **forward, extract information, delete and sort.**

In the message read interface, press **option** to perform the following operations: **edit, forward, extract information and delete.**

Junk Mailbox

When the short message firewall is activated, the numbers listed in the short message firewall will be directly saved in the junk mail box. In the message list interface, press **option** to perform the following operations: **forward, delete, move to inbox, set as**

regular number, arrange.

In the message read interface, press **option** to perform the following operations: **forward, extract information and delete.**

Voice Mail Box

The voice mail box is a network service. You can apply to activate this service. Before using this service, save the voice message number provided by the service provider. Enter the voice mail box window and the following items will be displayed:

Answer: Enter the number dial window, dial the voice mail number, and listen to the message.

Edit: Setup the voice mail box number (please see your service provider to apply for this number).

Local Broadcasts

Local broadcasts are an internet service. They allow you to receive things like weather forecasts and traffic update messages from your service provider. Before using this service, setup the channel number provided by your service provider. Enter the local broadcasts window and the following items will be displayed:

Receive: Enter the receive message window. you can select message receiving to be on or off.

Channel: The assigned channel for receiving the local broadcasts. Enter the channel list window, this activates the **select** option, you can **add, edit, or delete** the selected channel.

12 Phonebook

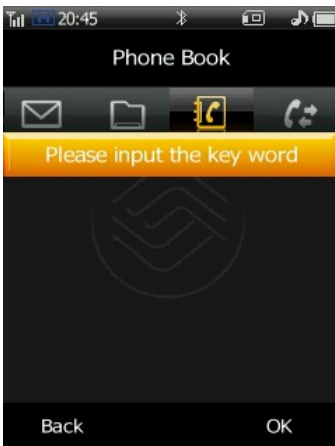

This section gives detailed descriptions of the phonebook function. On the main menu, click the phonebook icon to enter the phonebook.



Phonebook

Search

After entering the phone book, clicking **select** will select the **search** menu. Here you can search your phone book record based on **name, number, and storage location**.

The system provides a quick search function where you enter the first letter of a name. In the phonebook window, clicking the  on the top right of the list, will cause the quick search window to appear. Entering the first letter of the name will allow the user to search the telephone record. Clicking  again will hide the quick search window.

Add New

After entering the phonebook, press **option**, and then select **add new** item on the menu. Firstly choose the save location type: SIM card or phone.

If you set the save location type as "phone", in the add new record window you can enter the group name, mobile phone 1, mobile phone 2, landline, office phone, company, department, occupation, fax, address, birthday, electronic mail, notes, ring tone and portrait.

If you set the save location type as SIM card, you can save the name and number.

Call

In the contacts list, hover the cursor over the contact you wish to call, press **option**, select **call** and you can enter into a voice call, video call or IP call.

Send

In the contact list, hover the cursor over the contact you wish to send the message to, click "select". Click "send", and you can choose "send a message", "send a multimedia message", or "send a name card" to send this contact as a name card.

Multiple Copy

Multiple copy allows you to copy phonebook records between the SIM card and phone. Company, department, occupation, fax, address, birthday, electronic mail, notes, ring tone and portrait cannot be copied.

Select the direction. possible directions are **from the phone** and **from the SIM card**.

From the phone: Copy the phone records to the SIM card.

From the SIM card: Copy records from the SIM card to the phone.

If there is not enough space during the copy process, the system will point this out.

Multiple Move

The multiple record move function allows you to move records

between the SIM card and phonebook. Company, department, occupation, fax, address, birthday, electronic mail, notes, ring tone and portrait cannot be moved.

Select the direction of movement, you can choose **from the phone** and **from the SIM card**.

From the phone: Move many records to the SIM card.

From the SIMcard: Move many records from the SIM card to the phone.

If there is not enough space during the move process, the system will point this out.

Multiple Delete

Selectively delete multiple records. Select **Multiple Delete**.

When "all contacts" is chosen, all contacts can be deleted.

When "phone contacts" is chosen, all contacts on the phone can be deleted.

When "SIM card contacts" is chosen, all contacts on the SIM card can be deleted.

Save Location

Choose the save type: the following options appear on the menu:

Manual Selection: When adding new contacts, you need to choose whether to save to the phone or the SIM card.

Phone: When adding a new contact, confirms that it a new contact for the phone.

SIM Card: When adding a new contact, confirms that it is a new contact for the SIM card.

Memory Card Backup

Send to T card: Backup the selected contact to the T card.

Send to the phone: Add a backup contact on the T card to the phone.

Own Number

View and edit your own number.

Internal Memory

View the memory used by the saved contacts and total memory on the phone and SMS card.

Group

Select the fourth icon on your selected card, you will enter the group list. Hover the cursor over the group you wish to setup click **setup** and the setup menu will appear.

For the Confirmation Group you can only setup the group icon.

For other groups, you will see the following menu options: change the group name, group icon, set up the group incoming ring tone, add contact to the group or delete a group member. If you delete a contact from a group they will return to the Confirmation Group.

Group Name: Change the name of the group.

Group Icon: Change the icon of a group. after changing it, the contacts of the group members will show this icon in the contacts table.

Ring Tone: Set the incoming ring tone for contacts in this group.

Add Contact: Add a new contact to this group.

Remove From Group: Remove contact from the group. the removed contact will return to the confirmation group.

Select the specified group. The contacts in this group will appear in the list window. if it has not been setup this will display as blank. Press **option** to activate the menu, from there it is possible to **search, call, IP call, video call, send a message, or send a multimedia message** to the contact.

13 Multimedia

Camera

Using the "camera" application, you can take photos of people and events around you anytime and anywhere. The photos are saved in the "My Photos" application. The camera takes photos in JPEG format. Using the digital video recorder (DV), the file format is 3gp. If the memory space in the phone is not sufficient to save new photos, you have to delete some old photos to create some new space. In the memory lookup, you can view the memory status.

Note:

In areas where there is insufficient light, the image quality of previews and photos could decrease. If this happens, check that the camera is a single shot mode.

From the camera photography window, the picture you want to take will appear on the phone screen, click the **take photo** key to take the photograph.

On the screen, there are 6 icons. These are the photography mode, photography environment, photo size, zoom, and return, and settings.

Select  **Photography Mode:** To setup the photography mode, possible choices are the single shot mode, continuous shot mode, and recording mode.

Select  **Camera Environment:** To setup the camera environment, the three possible environments are regular, indoor, outdoor.

Select  **Photo Size:** To setup the photo size, possible sizes are 64×64, 320×240, 400×240, 640×480, 1280×960 (only for the rear camera), 1600×1200 (only for the rear camera). photo size can only be selected for single shot mode.

Select  **Zoom:** To decide the photo zoom, possible choices are x1, ×2, ×3, ×4.

Select  **return:** Leave the camera, and return to the previous interface.

Select  **Setup:** Enter the camera setup interface. the items which can be set are: change camera, photo mode, photo size (only appears for single shot mode), number of continuous photos (only appears for continuous mode), photo environment, photo effects, photo quality, brightness, zoom (does not appear for continuous mode), self time, camera tone, save location. The information about these is as follows:

Change Camera: Switch between the front and rear camera.

Photo Mode: Setup the camera mode. Possible selections are single shot, continuous shot and recording mode.

Photo Size: Setup the photo size. Possible sizes are 64×64, 320×240, 400×240, 640×480, 1280×960 (only for the rear camera), 1600×1200 (only for the rear camera). photo size can only be selected for single shot mode.

Number of Continuous Shots: Setup the number of shots to be taken in continuous mode. possible selections are 9, or 18 photos. the number of continuous shots can only be changed in continuous mode.

Camera Environment: Setup the camera environment, the three possible environments are regular, indoor, and outdoor.

Photo Effects: Setup the photo effects. The three possible effects are normal, retro, or black and white.

Photo Quality: Possible choices are very detailed, detailed, and regular.

Brightness: Setup the photo brightness. Possible choices are -2, -1, 0, +1, +2.

Zoom: Setup the photo zoom. Possible choices are $\times 1$, $\times 2$, $\times 3$, and $\times 4$. In continuous mode the zoom cannot be adjusted.

Self Time: Setup the photo self time. Possible choices are 5 seconds, 10 seconds, 15 seconds, 20 seconds or close.

Camera Tone: There are three possible camera tones to select. Click OK to confirm the choice.

Save Location: Setup the save location. Possible choices are the phone or the memory card.

While taking photos, clicking the upper or lower side keys, the zoom can be changed. By changing the zoom, it is possible to view part of the photo in more detail.

If the photo mode is single shot, after taking the photo, click the **take photo key** or **save** to save the photo. click **return** and a prompt will confirm if you wish to abandon the photo, click **confirm** to return to the photo interface without saving. press **option** to perform the following operations:

Save: Save the photograph.

Send as Multimedia Message: The picture is first saved, and then entered into the new multimedia message interface. the photo can be sent in the form of a multimedia message.

Set as Wallpaper: The photo is first saved, and then set as the wallpaper.

If the photo mode is set to continuous, after taking the photo, click **take photo** to switch from one photo mode to thumbnails. click **return** the system will confirm you wish to abandon the photo, then click **confirm** to return to the photo interface without saving. click the **select or OK** key to perform the following operations:



Save: Save the photo in the browser.

Save All: Save all the photos in the camera.

Automatic Browsing: Automatically browse through all the captured photos.

Single sheet: Enter a single photo browser window.

Thumbnails: Enter the thumbnail browser interface.

Set the photo mode to recording. while filming the camera will also records sounds. During the photography, clicking the  key will abandon the photos. click the  key to stop photography. After taking the photos, click **take photo** to save the recording. press the **right function key** you will be asked to confirm if you wish to abandon changes, click **confirm** to return to the photo interface without saving the photo. click the **select or OK** key to perform the following functions:

Play: Play the captured recording.

Save: Save the captured recording.

DV

This is the digital video recorder option of the camera feature.

Music Player

After entering the media player, the phone will search for all the MP3 files on the phone, and these will be analyzed. In the media player window, there are the following 5 selections:

Song List: Shows all the MP3 files on the phone

Record Collection: Shows all MP3 files sorted by genre

Artist Listing: Shows all the MP3 files on the phone by artist

Update Playlist: When the MP3 files in the phone's memory are changed, this option will update the playlist

Player Mode: You can select play modes such as one song play, one song repeat, and play in order, continuous play, and quick play

Record collection display interface:



Shown in the figure are the pictures of the MP3 collection. you can drag to the left and right so different collections are shown.



key: press this key to play the MP3 file. At the same time, the icon will change into a , clicking again will pause the playback of the MP3.



key: press this key to exit the record collection, and return to the previous interface. If there is an MP3 playing at the time, it will continue to play in background mode.

Clicking the picture in the middle of the screen, it will change to show the MP3 files in the collection as below:

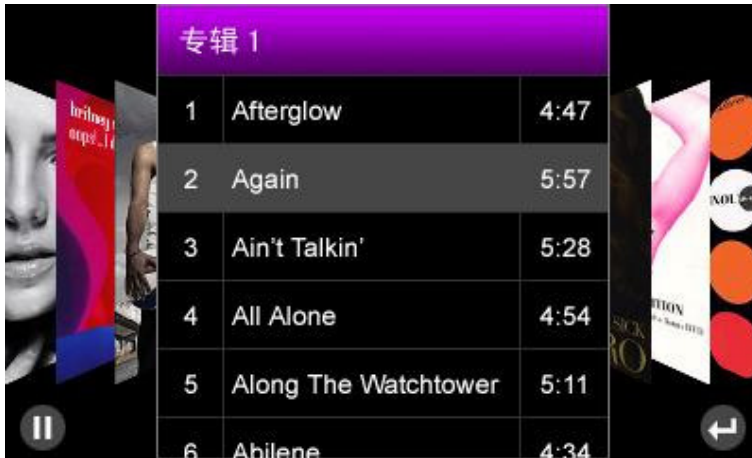

You can drag through the documents in the browser. Clicking outside the collection or anything other than the two buttons, the list will change and pictures of the MP3 collection will show.



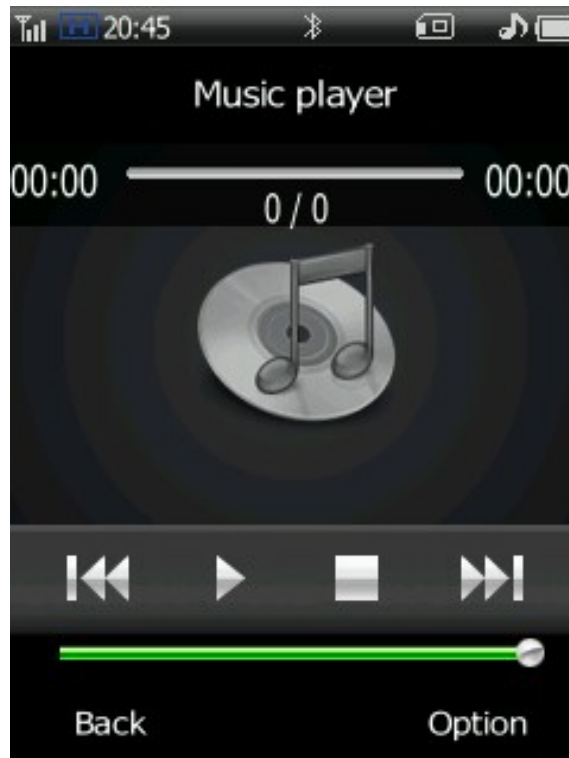

In the song list, record collection, and artist list, clicking a specific MP3 file will enter the music player interface, as shown:



The picture in the middle shows the currently selected MP3 collection



: Shows the total MP3 duration and playback time. A single click on the progress bar can speed up or slow down the playback.

				
Previous song	Next song	Pause	Play	Current playback volume

Note:

The audiovisual player supports the MP3 format.





Video Player

In the video player window, clicking the upper side key will increase the volume. clicking the lower side key will reduce the volume.

The touch keyboard appears as follows:



: Shows the total MP3 and playback time. A single click on the progress bar can speed up or slow down the playback.

				
Previous video	Next video	Pause	Play	Current playback volume

Clicking in the playback area will switch to full screen or non full screen mode.

Click **option** to perform the following operations:

Video Collection: Enter the video collection. displays the audiovisual files on the phone and memory card.

Mode: Can choose playback formats: no repeat, repeat current, repeat list, quick play.

Go to URL: Directly input and play an internet address.

Web Page List: Shows multimedia playback web pages.



Note:

The video player can support 3gp and mp4 format.

Recorder

When using the recorder function, you can record the content of your conversations, and can also record your environment. The record file are saved in amr format. you can set the recording file as your ring tone.

Enter the recorder window. Directly press the  button to start recording. at this time the right side of the screen will display the currently recording time. Click the **select or OK** key to execute the following functions:

Record: Start recording. At this time tapping the  button will stop the recording. Tapping the  key again will continue the recording. clicking the **save** key will save the recorded file. clicking the **return** key will return to the menu. You can, in **My Collection-Sound-Recordings**, listen to your saved recordings.

Recording List: Enter the recording list window, you can play the recordings.

Save Location: Select the location for saving your recordings. Possible selections are your phone or memory card.

14 Tools

Memo

The Memo can be used to record any simple notes. You can enter 1024 symbols (512 Chinese characters) into the memo table. Click **memo** to edit. this will activate the **Option Key**. you can then **send messages, edit items, and clear**.

Time

Time provides additional time related functions such as: **world clock, countdown, stopwatch and alarm**.

Calculator

The calculator can be used for performing addition, subtraction, multiplication and division calculations. After entering the calculator interface, the user can directly enter numbers and begin calculations. The numbers and symbols you enter will appear in the edit window.

Exchange Rate

You can use this function to find out how much a sum of money would be worth in another country's money.

Unit Conversion

Unit convert mainly helps you convert units. Enter the unit conversion window, roll the selection bar to select the content you wish to set. Press the select or OK key or touch the screen to select, you will enter the edit window. the system will automatically give the results.

Incoming Call Location

Check a phone number's location. This supports the checking of the location of fixed phones as well as cell phones.

Note:

The number location check could be inaccurate. the incoming call locations results are provided only for reference.

15 Connections

Bluetooth

Activating the Bluetooth feature will allow your phone to be discovered, connect and or bond with other Bluetooth devices.

USB Mode

Udisk mode: If using USB mode, the phone can serve as a U disk. After U disk mode is activated, data synchronization and modulator-demodulator functionality does not work.

Modem mode: Activate modem mode, the system can be used for data synchronization, modem.

Note:

Using the Modem Mode requires the installation of drivers. If the drivers are not installed to the PC. You can only use the USB mode functions and the modem cannot work.

PC Tools

This phone can connect with a PC via a USB digital cable, providing the customer with a method for transmitting the phonebook and short messages. Before using the document transmission function, you have to install synchronization software on the PC. the software is on the memory card that comes with the phone. This phone supports the Windows XP and Windows 2000 operating systems.

When using PC tools, you should set the USB mode to Modem Mode. Select PC tools, insert the data cable and connect with the

PC. After successfully connecting, you can work on the phonebook and short messages. For the detailed operating system usage, please consult the PC tools help file.

GPRS Wizard

Using GPRS technology, the user can use their cell phone to send and receive data via the mobile network. GPRS is a way to transmit data. It allows the user to connect wirelessly to the internet data network. The applications of the data transmission include WAP services, multimedia message service, short message service, JAVA application downloads and GPRS dialing programs (such as the internet and electronic mail).

Before using GPRS technology you must note the following points

1. Please enquire whether your network and service provider offer GPRS service and how to start the service.
2. Please save the necessary GPRS settings for every application with GPRS as its means of data transmission.

16 Other Applications

English Chinese Dictionary

The dictionary that comes with this phone can support translation between Chinese and English. You can translate English input into Chinese, as well as translating Chinese into English.

Calendar

Function Introduction

In the calendar, there are mainly four functions: **schedule**, **solar calendar inquiries**, **solar period inquiries**, and **anniversary inquiries**. In the calendar, you can see the current month and schedule messages. Those dates with arrangements will have orange undertone reminders. Clicking on the date allows you to check that days scheduled messages. You can edit or send schedule messages as multimedia messages.

Calendar

Entering the calendar, it will show the current monthly calendar, on the screen the currently displayed calendar year and month of the calendar will be indicated. Under the screen solar calendar information will be shown. If a schedule item has been created, the date will be have an orange undertone.

Schedule

In the calendar interface, click **option**, select the **Schedule**, menu content includes: enter date, add, schedule and content lookup.

Enter date: You can use this function to enter any day (in the effective period), click the **confirm** key, the focus will move directly to the selected date.

Add: When adding a schedule item, it is necessary to enter information relating to the event. then setup the reminder date and reminder time. Click **Save** to save the setup.

Schedule list: View all items in the schedule. Click the **option** key to active the menu, you can then perform operations: **add** and **delete**.

Content lookup: View the number of schedule items and the available number. The most schedule record that can be saved is 60. After clicking return you can return to the calendar table window.

Solar Calendar Search

Search the assigned date's solar calendar information.

Solar period search

See the 24 solar period's of China.

Solar period search

See information about Chinese festivals like the new year, and spring festival.

Electronic books

With this function, you can view txt document files stored on the phone's user memory or on the memory card.

Games

Three JAVA games come preinstalled. These are Landlord, Jewel Princess, and Sudoku King.

17 Safety Warnings and Notes

Electronic Equipment

Please switch off your phone near areas where high-precision electronic equipment is used. Otherwise, the phone may damage the equipment.

Equipment which may be affected by the phone includes: hearing aids, pacemakers, fire alarms, automatic doors, and other automatic control equipment. Users who also use mechanical medical aids should contact the manufacturer's service center for these devices and enquire whether they are influenced by wireless electric waves.

Medical Care Centers

In medical care centers please observe the following notes:

- ⊕ Please do not take your mobile into operating rooms, Intensive Care Units (ICU), or Coronary Care Units (CCU).
- ⊕ In areas near medical equipment, please turn off your phone.
- ⊕ In areas where cells phones are not permitted, please abide by the warnings and regulations in the area.
- ⊕ Please pay attention to the ring tone, volume, and vibrate settings of your phone, in order to avoid affecting patients such as heart disease sufferers.

Combustible and Explosive Areas

In areas containing combustibles or explosives, please switch the phone off. To avoid causing fire or explosions, in these areas, please do not remove or install batteries, charge batteries, or use the cell phone. The following are combustible and explosive areas:

- ⊕ Gas stations.
- ⊕ Areas containing fuels (for example, in the hull under the deck of a ship).
- ⊕ Fuel or chemical products transportation and storage facilities.
- ⊕ Areas where the air contains chemical substances or particles (for example: grain, dust, metal powder).
- ⊕ Areas signed as containing the danger of explosions.
- ⊕ Areas signed "switch off wireless two directional electronic equipment".
- ⊕ It is usually suggested that you switch the phone off in areas containing car motors.

Traffic Safety

- ⊕ When driving, please abide by the relevant regulations of the area or country. In order to avoid the impairment of your driving causing a traffic accident, please do not use the phone when driving. When driving please place the phone in its holder, do not put it on a seat or other place where it may move during a collision or under sudden braking. After the car has stopped safely, you can use the phone.
- ⊕ Please do not place the phone in areas in front of emergency airbags or in places the airbag may reach. Otherwise, when the airbag inflates or deploys, the phone may be subject to strong forces, which could cause serious harm to the driver.

⊕ When flying in airplanes, please abide by the related rules and regulations of the airline. When on or near an airplane, please turn off the phone and remove its batteries. In areas of an airport where the use of phones is prohibited, please turn off the phone. This will prevent the phone's wireless signal interfering with the airplane control signals.

Storage Environment

- ⊕ Please keep your phone away from magnetic equipment such as magnetic cards or soft disks, as the phone's emissions may delete the data stored on it.
- ⊕ Please do not place the phone, batteries, or charger in areas containing machines which have strong electromagnetic fields such as induction cooker pans or microwaves, otherwise the fields could cause damage to the electric circuits, and cause fire or explosions.
- ⊕ Please do not store the phone, battery, or charger in areas with high temperature, or very low temperatures. Otherwise the phone, battery, or charger could be damaged, causing fire or an explosion.
- ⊕ Please do not let the phone, battery, or charger receive strong strikes or vibration. This is to avoid battery fluid leaking, the phone being broken, overheating, fire or explosions.
- ⊕ Please do not store sharp metal products such as nails near the headset of the phone, as the magnetic earpiece could attract these materials, and they could cause harm when using the phone.
- ⊕ Please do not place the phone in the back pocket of pants or skirts. This is to avoid causing damage by sitting on the phone.

Child Health

- ⊕ Please keep the phone, batteries, or charger in an area where children cannot reach it. please do not allow children to use the phone, battery or charger without supervision.
- ⊕ Please do not allow children to put the phone battery in their mouth, as battery fluid could cause poisoning.
- ⊕ Please do not let children come into contact with the small phone parts, otherwise they may swallow them leading to problems such as suffocation or choking.

Operation Environment

- ⊕ Your phone, batteries, and charger are not water proof, when using them please keep them dry. In order to prevent the equipment from short circuiting, corrosion damage, or electrification of users, please do not allow the phone, batteries, or charger to come into contact with water or vapor, or operate the phone with wet hands.
- ⊕ To avoid damage to the phone's electric circuits, please do not use it in dusty, damp, or dirty areas or areas close to magnetic fields.
- ⊕ To avoid affecting people's health, when the headphones are attached, please do not switch the phone on or off.
- ⊕ In order to conform to RF leakage regulations, when carrying or using the phone's data functions, please keep a distance of at least 1 inch (2.5 cm) from the antenna.
- ⊕ If you play games on the phone for a long time and this causes discomfort (such as epilepsy, or dizziness), please immediately seek a doctor for assistance.
- ⊕ When you are using your phone's hands free function, please do not put the phone close to your ear. This is to avoid the loud sounds damaging your hearing.

- ⊕ If your phone has an infrared connection, please do not use optical amplifiers to view the connection.
- ⊕ If your phone has photography functionality, please do not use the flash too close to your or other people's eyes.
- ⊕ If your phone comes with a touch screen pen, please use it carefully to avoid scratching the surface or screen of the phone.
- ⊕ During lightning storms, please do not use the phone while it is charging, also do not use the phone outdoors. This is to avoid being struck by lightning and harmed.
- ⊕ During calls please do not touch the antenna, as tapping the antenna will affect the quality of the call and cause the phone power to exceed the normally required power. This will shorten the call and standby time.
- ⊕ Your phone's signal interference may influence nearby televisions, radios or computers.
- ⊕ Please respect the international emission regulations, and use accessories designated by this company.

Cleaning and Maintenance

- ⊕ Before cleaning and maintaining your phone, please switch it off. If it is being charged, it is necessary to unplug the charger from the power source while also disconnecting the charger from the phone. This is to avoid electric shocks, battery or charger short circuits.
- ⊕ Please do not use chemical substances (such as alcohol, or benzene), or chemical reagents, or granular cleaning agents to wipe the phone or charger, otherwise components could be damaged and this could cause a fire. You can use a damp, static proof soft cloth to wipe the phone.
- ⊕ Please do not scrape or alter the casing of the phone. Otherwise, traces of the material could cause an allergic reaction. If allergic reactions occur, you must stop using the phone immediately and seek medical assistance.

- ⊕ To avoid fire, clean the dust from the electric source plug, and keep it dry.
- ⊕ If the phone and its components and accessories do not work correctly. Please contact your local authorized service organization, service center personal will provide assistance.

Emergency Call

In emergency situations, if the phone is switched on, and in a service area it can be used to make an emergency call. However, because we cannot guarantee that the network will connect under all circumstances, the phone should not be the only contact method.

Using the Battery

- ⊕ Only batteries recognized by the phone manufacturer can be used, please do not use batteries designed for different models. Otherwise, it could lead to fires.
- ⊕ Please do not put batteries into fire. Otherwise, the batteries could ignite or explode.
- ⊕ Please do not put conductors such as metal objects, keys, or jewelry across the two poles of the battery, or in contact with the battery poles. This is to avoid causing a battery short circuit and overheating causing bodily harm (such as burns).
- ⊕ Please do not take apart the batteries or weld the batteries two poles together, this is to avoid battery leakage, overheating, fire and bursting.
- ⊕ If the battery fluid leaks, smokes, or emits an odor, immediately stop use and move the phone away from fire or people, to avoid fire or bursts causing harm. To ensure safety, give the phone to a qualified repair point to handle.

- ⊕ If the battery liquid touches skin or agricultural products, please immediately wash with clean water to avoid damage to the skin.
- ⊕ If battery liquid squirts into the eyes, do not rub the eyes, otherwise it could cause damage to the eyesight, instead immediately wash in clean water, and go to a hospital for medical treatment.
- ⊕ If during charging the batteries change shape, color, or get unusually hot, immediately remove the battery and do not continue use, otherwise it could cause battery fluid to leak, overheating, bursting or catching fire.
- ⊕ When the battery cannot be installed normally into the phone, please do not try to push the battery in forcefully. This is to avoid the battery leaking or bursting.
- ⊕ Please do not remove the battery when the phone is switched on.
- ⊕ If the battery is not used for a long time, after charging, please store at room temperature.

Using the Charger

- ⊕ Only chargers recognized by the phone manufacturer can be used, please do not use chargers designed for different models otherwise it could lead to fires.
- ⊕ Please do not short circuit the charger to avoid equipment malfunctions, smoking or fire.
- ⊕ To avoid electric shocks, charger short circuits, or fires, if the power cable is broken (for example: the wire shows through the insulator or it is cracked) or the connection is loose, please do not continue to use it.
- ⊕ Please do not installed water or other liquid containers next to the charger. liquids such as water entering the charger can cause electrical leaks or other breakages.
- ⊕ Please do not charge in a dusty or moist environment, also the power cable should not be kept close to heaters.

- ⌚ Before charging, please confirm that the electrical plug is correctly plugged into the power socket. If the electrical socket is not correctly plugged in, it could lead to electric shocks, or fire or explosions of the phone or battery. When charging is complete and power is turned off, pull out the plug rather than pulling out the cable.
- ⌚ The charger must use the standard required current and voltage, if other voltages are used it could lead to fire or breakages.
- ⌚ The power cable of the charger should not have heavy objects placed on it. It should not be damaged, modified, or pulled, otherwise it could cause electric shocks or fires.
- ⌚ Please do not touch the plug, cable, charger with wet hands when it the phone is charging. Otherwise it could lead to an electric shock.
- ⌚ To avoid overheating, fire or other breakages, if objects like water get into the charger, please immediately remove the charger cable plug from power socket.

Using the USB Data Cable

When using the USB data cable, please operate strictly following the instructions as below. Otherwise, it could damage or phone or personal computer:

- ⌚ When using the USB data cable to connect the phone with the personal computer, please first connect the phone end, and then connect the personal computer end.
- ⌚ When the phone and computer are communicating, it is strictly forbidden to disconnect the USB cable. Otherwise, it could cause the phone and computer equipment to be damaged.
- ⌚ When disconnecting the phone and computer's USB connection, please first disconnect the computer end, and then disconnect the phone end connection.

Protecting the Environment

Please abide by the related local laws regarding phone packaging, expired batteries, and old phone processing, also try to recycle where possible. Please do not throw phones or chargers into the garbage or a source of fire, to avoid explosions.

Electronic Message Products Toxins and Harmful Substance Declaration

Product name	Mini 3T1 TD-SCDMA/GSM Dual Mode Digital Cell Phone
Model number	Mini 3T1
Manufacturer	Dell
Manufacturing address	

Component name	Toxic or harmful substances or elements					
	Lead (Pb)	Mercury (Hg)	Cadmium (Cd)	Hexavalent chromium (Cr ⁶⁺)	Firemaster BP-6 (PBB)	polybrominated diphenyl ethers (PBDE)
Casing	<input type="radio"/>	<input type="radio"/>	<input type="radio"/>	<input type="radio"/>	<input type="radio"/>	<input type="radio"/>
PCB	<input type="radio"/>	<input type="radio"/>	<input type="radio"/>	<input type="radio"/>	<input type="radio"/>	<input type="radio"/>
Batteries	<input type="radio"/>	<input type="radio"/>	<input type="radio"/>	<input type="radio"/>	<input type="radio"/>	<input type="radio"/>
Data cable	<input type="radio"/>	<input type="radio"/>	<input type="radio"/>	<input type="radio"/>	<input type="radio"/>	<input type="radio"/>
Headphones	<input type="radio"/>	<input type="radio"/>	<input type="radio"/>	<input type="radio"/>	<input type="radio"/>	<input type="radio"/>
Charger	<input type="radio"/>	<input type="radio"/>	<input type="radio"/>	<input type="radio"/>	<input type="radio"/>	<input type="radio"/>

Component name	Toxic or harmful substances or elements					
	Lead (Pb)	Mercury (Hg)	Cadmium (Cd)	Hexavalent chromium (Cr ⁶⁺)	Firemaster BP-6 (PBB)	polybrominated diphenyl ethers (PBDE)
Antenna	○	○	○	○	○	○
Display screen	○	○	○	○	○	○
Keys	○	○	○	○	○	○
Key connector	○	○	○	○	○	○
LCM protective film and all labels	○	○	○	○	○	○
Camera module/camera module	○	○	○	○	○	○
band components/shielding gasket	○	○	○	○	○	○
Plating	○	○	○	○	○	○
Anti-dust net	○	○	○	○	○	○
Vibration motor	○	○	○	○	○	○
Screws and nails	○	○	○	○	○	○
handwriting pen	○	○	○	○	○	○

○: Indicates that this toxic or hazardous substance contained in all homogeneous materials of this part is below the limit requirement in SJ/T 11363-2006.

✕: Indicates that this toxic or hazardous substance contained in one of the homogeneous materials of this part is above the limit requirement in SJ/T 11363- 2006.

18 SAR Description

Specific Absorption Rate (SAR)

This cell phone conforms to International SAR standards.

Your cell phone is a low power wireless receiver and transmitter. It is designed and manufactured not to exceed the recommended upper SAR International standard values. These upper values are within the scope of the national standard. This standard stipulates the permitted SAR values for the general public. The standard was formulated after careful research by international independent scientific organizations. These organizations also carry out regular reviews of the standards to ensure their effectiveness. The standards include a large number of safety parameters to ensure the personal health and safety of users of any age.

The phone's emissions are measured and evaluated according to their SAR (Specific Absorption Rate). Based on the standard, the upper recommended SAR value for this cell phone is 2.0W/kg per 10g*. The testing of the SAR values of this cell phone is carried out using a standardized testing program. This tests the highest power output for all frequency bands during regular usage.

Although the SAR is tested at maximum power, in reality the SAR values are considerably lower than the maximum values during regular use. This is because the cell phone is designed with a number of output powers. During regular operation, the power rating required need only be enough to allow the phone to connect to the network. Usually the closer the phone is to the base station, the lower the output power needs to be.

When held to the ear, the SAR value of the phone does not exceed 2.0W/kg per 10g. Although different phones have different SAR values at different locations, they always meet the requirements of this standard.

Please note: If this phone has design modifications, the SAR values may change. However, under all conditions the phone is designed to conform to the requirements of the standard.

* The International Commission on Non-Ionizing Radiation Protection recommends that for phones for the general public, the SAR standard upper value for each 10g of body tissue should not exceed 2.0W/kg. This standard includes an extremely large safety factor to further improve public safety. It also takes differences caused by testing errors into account. Under different testing requirements and frequency bands, the SAR values will be different.

Free Manuals Download Website

<http://myh66.com>

<http://usermanuals.us>

<http://www.somanuals.com>

<http://www.4manuals.cc>

<http://www.manual-lib.com>

<http://www.404manual.com>

<http://www.luxmanual.com>

<http://aubethermostatmanual.com>

Golf course search by state

<http://golfingnear.com>

Email search by domain

<http://emailbydomain.com>

Auto manuals search

<http://auto.somanuals.com>

TV manuals search

<http://tv.somanuals.com>