

Dell™ Laser Multi-Function Printer 1600n User's Guide

Click the links to the left for information on the features, options, and operation of your multi-function printer. For information on other documentation included with your multi-function printer, see "[Finding Information](#)" on page 11.

To order replacement toner cartridges or supplies from Dell:

1. Double-click the Dell Toner Reorder Program icon on your desktop.





OR

2. Visit Dell's website, or order Dell printer supplies by phone.

www.dell.com/supplies

Notes, Notices, and Cautions

-  **NOTE:** A NOTE indicates important information that helps you make better use of your multi-function printer.
-  **NOTICE:** A NOTICE indicates either potential damage to hardware or loss of data and tells you how to avoid the problem.
-  **CAUTION:** A CAUTION indicates a potential for property damage, personal injury, or death.

Information in this document is subject to change without notice.
© 2004 Dell Inc. All rights reserved.





Reproduction in any manner whatsoever without the written permission of Dell Inc. is strictly forbidden.

Trademarks used in this text: *Dell*, *DELL* logo, *Dell ScanCenter* and *Dell Toner Management System* are trademarks of Dell Inc.; *Microsoft* and *Windows* are registered trademarks of Microsoft Corporation.

PaperPort® is a registered trademark of ScanSoft, Inc.

Adobe and PhotoShop are registered trademarks of Adobe Systems Incorporated.

Other trademarks and trade names may be used in this document to refer to either the entities claiming the marks and names of their products. Dell Inc. disclaims any proprietary interest in trademarks and trade names other than its own.

What Are You Looking For?	Find It Here
<ul style="list-style-type: none"> • Drivers for my printer • My User's Guide 	<p><i>Drivers and Utilities</i> CD</p>  <p>You can use the <i>Drivers and Utilities</i> CD to install/uninstall/reinstall drivers and utilities or access your <i>User's Guide</i>. For details, see "Software Overview" on page 35.</p> <p>Readme files may be included on your <i>Drivers and Utilities</i> CD to provide last-minute updates about technical changes to your multi-function printer or advanced technical reference material for experienced users or technicians.</p>
<ul style="list-style-type: none"> • Safety information • How to use my multi-function printer • Warranty information 	<p>Owner's Manual</p>  <p> CAUTION: Read and follow all safety instructions in your Owner's Manual prior to setting up and operating your multi-function printer.</p>
<p>How to set up my multi-function printer</p>	<p>Setup Diagram</p> 
<p>Express Service Code</p>	<p>Express Service Code</p>  <p>Identify your multi-function printer when you use support.dell.com or contact technical support.</p>

Enter the Express Service Code to direct your call when contacting technical support. The Express Service Code is not available in all countries.

- Latest drivers for my multi-function printer
- Answers to technical service and support questions
- Documentation for my multi-function printer

Dell Support Website

The Dell Support Website provides several online tools, including:

- Solutions - Troubleshooting hints and tips, articles from technicians, and online courses
- Upgrades - Upgrade information for components, such as memory
- Customer Care - Contact information, order status, warranty, and repair information
- Downloads - Drivers
- Reference - Printer documentation and product specifications

You can access Dell Support at support.dell.com. Select your region on the WELCOME TO DELL SUPPORT page, and fill in the requested details to access help tools and information.

Dell Printer Configuration Web Tool

The Dell Printer Configuration Web Tool, also known as the Printer Embedded Web Server, lets you monitor the status of your network printer without leaving your desk. View and/or change the printer configuration settings, monitor toner level, and when it is time to order replacement toner cartridges, just click the Dell supplies link right from your Web browser.

 **NOTE:** The Dell Printer Configuration Web Tool is only available when the multi-function printer is connected to a (or the) network. See page [page 43](#).

To launch the Dell Printer Configuration Web Tool, just type your network printer's IP address in your Web browser. You can also launch the Dell Printer Configuration Web Tool from the Network Status Monitor Center. For details, see [page 43](#).

If you do not know what your printer's IP address is, print a network configuration page, which lists the IP address:

1. Press <Menu> until you see "Network Setup" on the bottom line of the display.
2. Press the scroll button (◀ or ▶) until "Print Sys. Data" displays on the bottom line.
3. Press <Select>. The first menu item, "Yes" displays on the bottom line.
4. Press <Select> to print a network configuration page.

If an IP address has not been assigned, assign one for your multi-function printer. See "[Configuring TCP/IP](#)" on [page 147](#).

Printer Status

Get immediate feedback on printer supply status. When toner is running low, click the toner supplies link on the first screen to order additional toner cartridges.

Printer Settings

Change printer settings, view the operator panel remotely, and update the print server firmware.

Copy Printer Settings

Quickly clone the printer's settings to another printer or printers on the network just by typing each printer's IP address.

 **NOTE:** You must be a network administrator to use this feature.

Printing Statistics

Keep track of printing trends, such as paper usage and types of jobs being printed.

Printer Information

Get the information you need for service calls, inventory reports, or the status of current memory and engine code levels.

Email Alert Setup

Receive an email when the printer needs supplies or intervention.

To set up email alerts:

1. Launch the Dell Printer Configuration Web Tool.
2. Click Email Alert Setup.
3. Type your name or the key operator's name in the email list box to be notified.
4. Click Submit.

Set Password

Lock the operator panel with a password so that other users don't inadvertently change the printer settings you have selected.



NOTE: You must be a network administrator to use this feature.

Online Help

Click Help to visit the Dell website for printer troubleshooting.



NOTE: For more information about the All-In-One Main page, View Saved Images page, or the Maintain/Troubleshoot page, click the Help link located in the upper right corner of the screen.

- Unpacking Your Multi-Function Printer
 - Fonts
 - Loading Paper
 - Powering On the Multi-Function Printer
 - Toner Save Mode
 - Charge-Coupled Device (CCD) Power Save Mode
 - About Your Multi-Function Printer
 - Installing the Toner Cartridge
 - Making Connections
 - Changing the Display Language
 - Power Save Mode
-

Unpacking Your Multi-Function Printer

1. Select a location for your multi-function printer.











CAUTION: The multi-function printer requires at least two people to lift it safely.

- Leave enough room to open the printer tray, covers, doors, and options. It is also important to allow enough space around the multi-function printer for proper ventilation.
- Provide the proper environment:
 - A firm, level surface
 - Away from the direct airflow of air conditioners, heaters, or ventilators
 - Away from sunlight, extreme humidity, or high fluctuations in temperature
 - A clean, dry, and dust free location





NOTE: Leave the multi-function printer in the box until you are ready to install it.

2. In addition to the Dell™ Laser Multi-Function Printer 1600n , ensure that you have the following items in the box. *If there is a missing item*, contact Dell:

 <p>Toner Cartridge</p>	 <p>AC Power Cord^a</p>	 <p><i>Drivers and Utilities CD</i>^b</p>
 <p>Owner's Manual</p>	 <p>Telephone Line Cord^a</p>	 <p>Setup Diagram</p>
 <p>Operator Panel Cover^c</p>	 <p>Terminator^c</p>	

- a. The appearance of the power cord and the telephone line cord may vary by country's specifications.
- b. The Drivers and Utilities CD contains Dell printer drivers, Scan Dell™ Toner Management System, Dell ScanCenter™, Paper Port.
- c. These items are only provided in some countries.

 **NOTE:** Use the telephone line cord supplied with your multi-function printer. If you choose to use a different cord, use an AWG #26 or lower gauge cord that is a maximum 250 cm in length.

 **NOTE:** The power cord must be plugged into a grounded power socket.

3. Save the carton and packing material in case the multi-function printer needs to be repacked.
4. Remove the packing tape from the front, back and sides of the multi-function printer.



5. Remove the label completely from the scanner module by gently pulling it. The scan unlock switch automatically moves FORWARD to the unlock position.

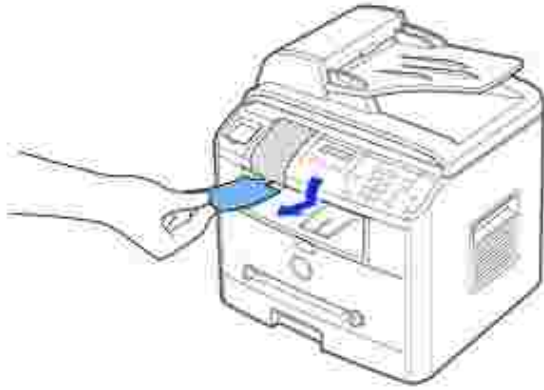

-  **NOTE:** When you are moving the multi-function printer or do not intend to use it for a long period of time, move the switch **BACKWARD** to the lock position, as shown. To scan or copy a document, the switch must be unlocked.

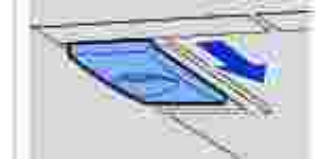

6. If your language is not already displayed on the operator panel, remove the attached English operator panel cover from the multi-function printer, by holding the bottom of it and gently pulling it upwards, as shown.



7. Place the supplied operator panel cover, according to your country, gently on the operator panel.

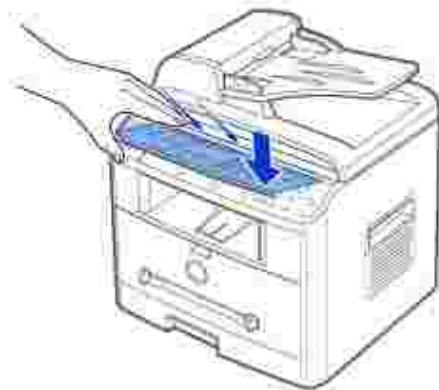

About Your Multi-Function Printer

These are the main components of your multi-function printer. The following illustrations show the standard Dell Laser MFP 1600n and an optional Tray 2 attached:

Front View

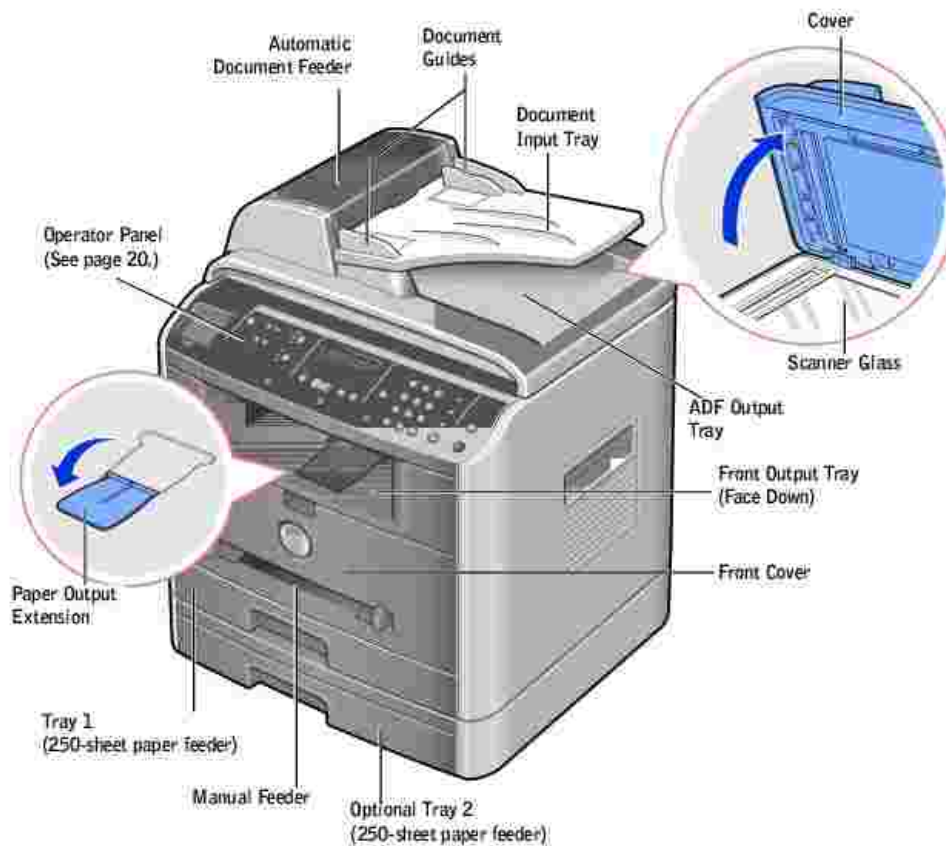

Rear View

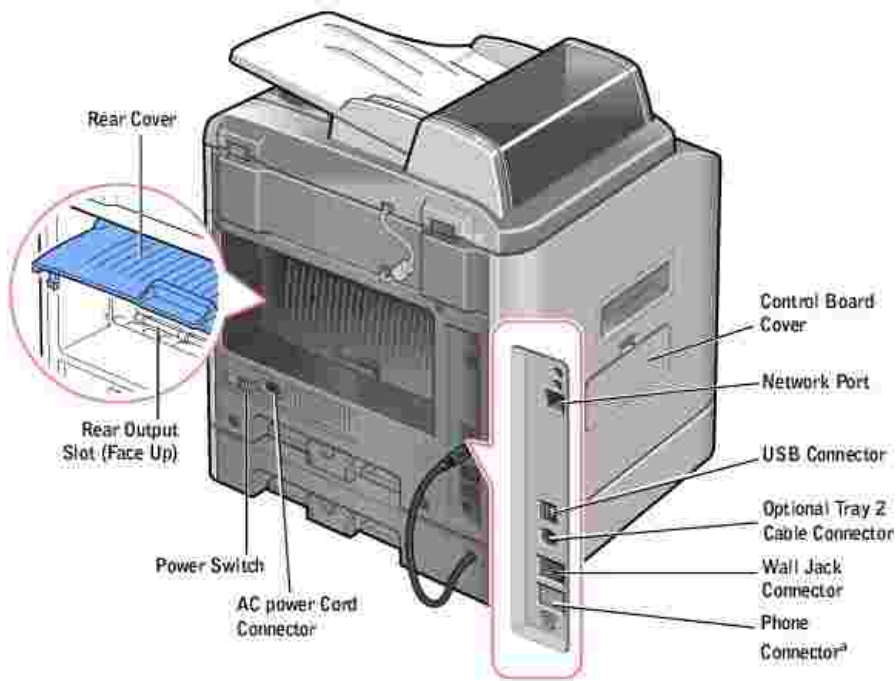

^a If the phone communication is serial in your country (such as Germany, Sweden, Denmark, Austria, Belgium, Italy, France and Switzerland), you must remove the plug from the Phone connector and insert the supplied terminator.

Operator Panel B utton Functions

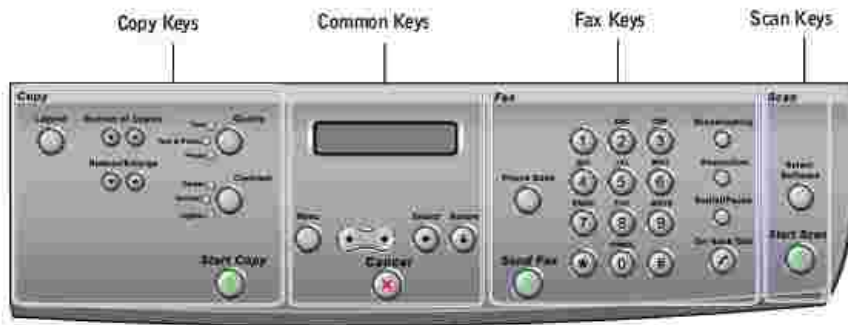

Copy Keys

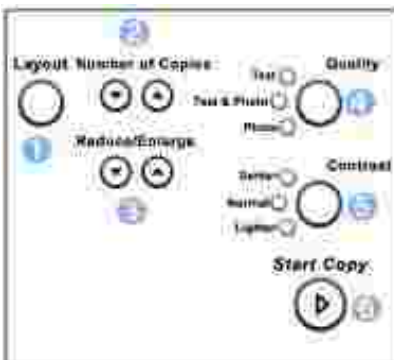

Press:	To:
	Use copy layout features, such as Auto Fit, Clone, Collation, 2-sided, 2/4 Up (multiple pages on a sheet), and Poster copying.
	Enter the number of copies.
	Reduce or enlarge a copy.
	Optimize the copy quality for documents containing photos, text, or mixed photos and text.
	Adjust the contrast of the output copy for the current copy job.
	Start a copy.



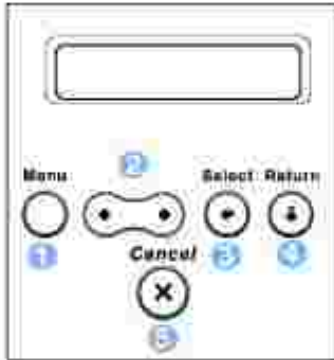



Common Keys



Press:	To:
1	Enter Menu mode and scroll through the available menus.
2	Scroll through the options available for the selected menu item.
3	Confirm the selection on the display.
4	Exit the menu and return to Standby mode.
5	Stop an operation at any time, or return to the default settings.



Fax Keys



Press:	To:
	Store, edit and search frequently-dialed fax numbers for automatic speed dialing. It also allows you to print a Phonebook list.
	Send a fax.
	Dial a number or enter alphanumeric characters.
	Send a fax to multiple destinations.
	Adjust the resolution of the scanned document for the current fax job.
	Redial the last number in Standby mode or insert a pause into a fax number in edit mode.
	Engage the telephone line.

Scan Keys



Press:	To:
	Access a list of your PC software programs that an image can be scanned to. You must create the scan list using the Dell software (Printer Settings Utility) provided with your multi-function printer.
	Start a scan.

Fonts

The Dell Laser Multi-Function Printers supports the following fonts:

PCL Fonts

■ BitStream Speedo font (intellifont compatible)

Alberius	marigold
Albertus ExtraBold	CG Omega
Antique Olive	CG Omega <i>Italic</i>
<i>Antique Olive Italic</i>	CG Omega Bold
Antique Olive Bold	CG Omega Bold Italic
Carerdon Condensed	CG Times
Coronet	CG Times <i>Italic</i>
Courier	CG Times Bold
<i>Courier Italic</i>	CG Times Bold Italic
Courier Bold	Univers Medium
<i>Courier Bold Italic</i>	Univers Medium <i>Italic</i>
Garamond Antique	Univers Bold
<i>Garamond Italic</i>	Univers Bold Italic
Garamond Halfset	Univers Medium Condensed
<i>Garamond Kursiv Halfset</i>	Univers Medium Condensed <i>Italic</i>
Letter Gothic	Univers Bold Condensed
<i>Letter Gothic Italic</i>	Univers Bold Condensed Italic
Letter Gothic Bold	

■ Inia type fonts

Arial	Times New Roman
<i>Arial Italic</i>	Times New Roman <i>Italic</i>
Arial Bold	Times New Roman Bold
<i>Arial Bold Italic</i>	Times New Roman Bold Italic
Symbol	Wingdings

■ Bit Map fonts

Line Printer (16.67 pitch, 3.5 point, bit map font)

Installing the Toner Cartridge

1. Open the front cover.

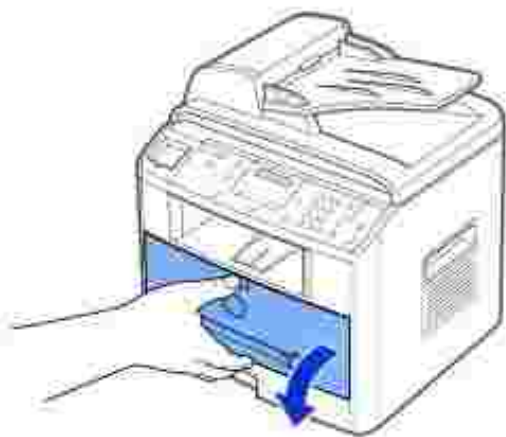

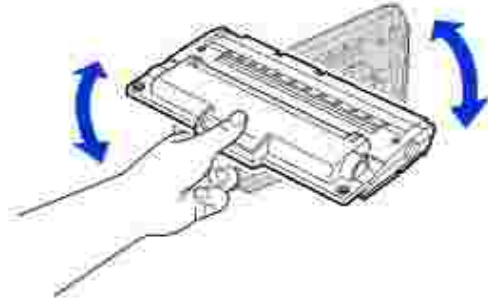

2. Remove the toner cartridge from its bag. Hold the toner cartridge by the handle and gently shake it from side-to-side to distribute the toner.



Thoroughly rolling the cartridge will assure the maximum copies per cartridge.

 **NOTE:** *If toner comes into contact with your clothing, wipe the toner off with a dry cloth and wash your clothing in cold water. Hot water sets toner into fabric.*

 **CAUTION:** To prevent damage, do not expose the toner cartridge to light for more than a few minutes.

 **CAUTION:** Do not touch the green underside of the toner cartridge. Use the handle on the cartridge to avoid touching this area.

3. Align the toner cartridge with the labeled arrows, then slide it into the multifunction printer until it locks firmly into place.

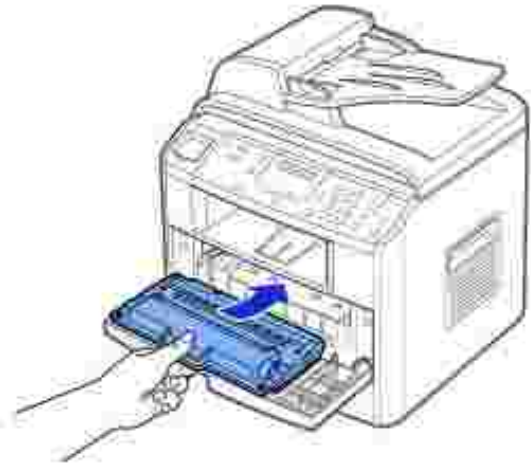

4. Close the front cover.



Loading Paper

Load up to 250 sheets of plain paper in the paper tray.

 **NOTE:** Set the paper type and size after loading paper into the paper tray. See page 66 -67 for the paper used in copying and faxing, or page 75 for PC-printing.

To load paper:

1. Pull open the paper tray and remove it from the multi-function printer.



2. Push down on the pressure plate until it locks into place.

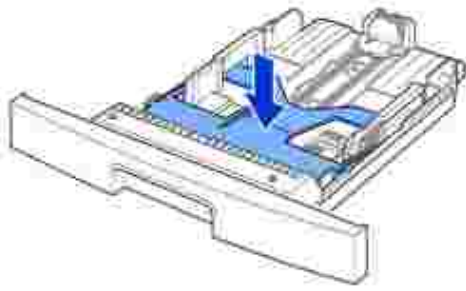

3. If you load longer than a standard (Letter or A4) size, such as Legal paper, press and unlatch the guide lock, and then slide the paper length guide out completely to extend the paper tray to its full length.

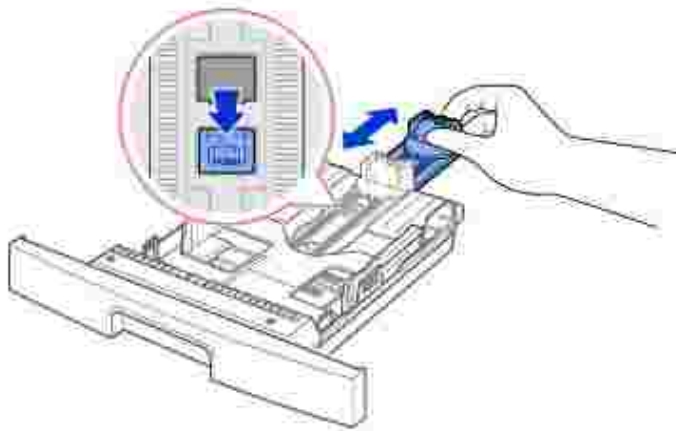

4. Flex the sheets back and forth to loosen them, and then fan them out. Do not fold or crease the print media. Align the edges on a level surface.

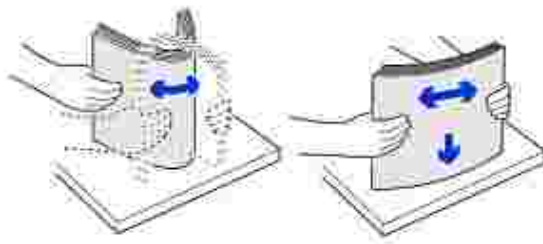

5. Insert the paper stack into the paper tray with the side to be printed on facing down.

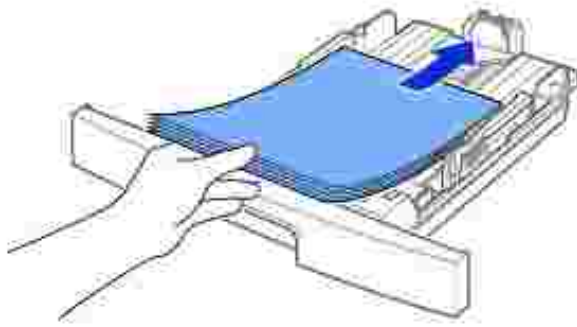

6. Do not exceed the maximum stack height indicated by the paper limit marks on the both inside walls of the tray. Overloading the paper tray may cause paper jams.

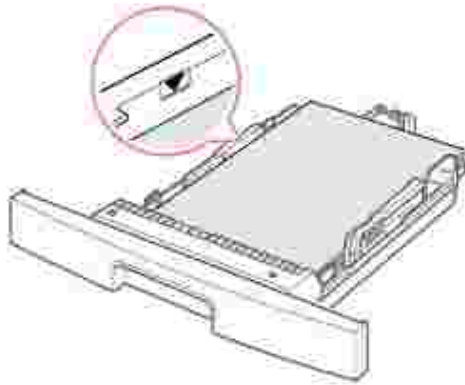

7. Slide in the length guide until it lightly touches the end of the paper stack.

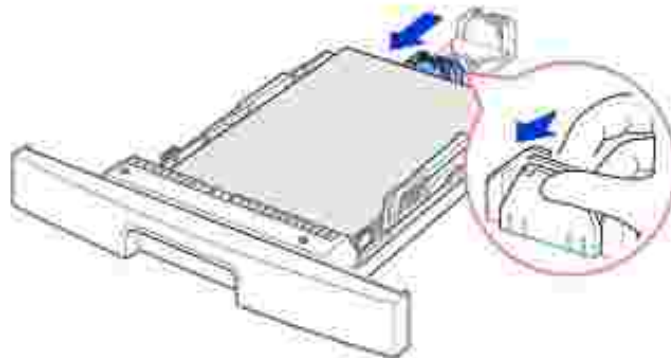

For paper smaller than Letter size, adjust the inner paper length guide so that it lightly touches the paper stack.

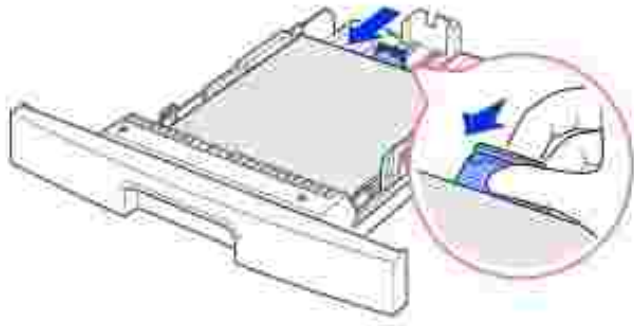

8. Pinch the paper width guide, as shown, and move it towards the stack of paper until it lightly touches the side of the stack.

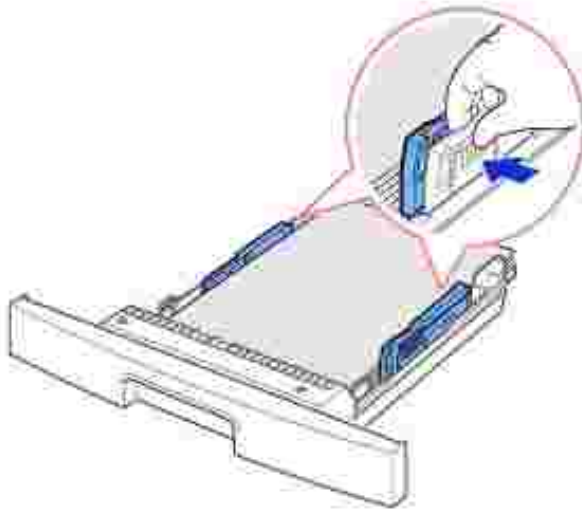

 **NOTE:** Improper adjustment of paper guides can result in paper jams.



9. Insert and slide the paper tray back into the multi-function printer.



10. Set the paper type and size. See page 66 ~67 .

Making Connections

Connecting the Telephone Line

1. Plug one end of a telephone line cord into the Wall Jack connector and the other end into an active wall jack.

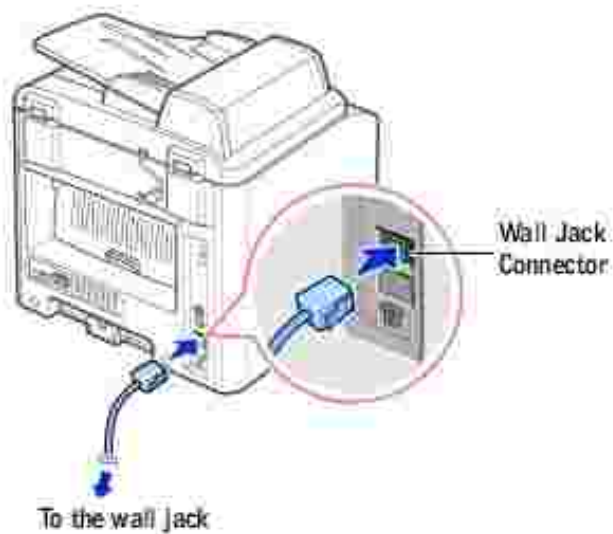

To connect a telephone and/or answering machine to your multi-function printer, remove the plug from the Phone connector (☎) and plug the telephone or answering machine into the Phone connector .

If your multi-function printer is not blocked with the plug, directly plug the telephone or answering machine into the Phone connector (☎).

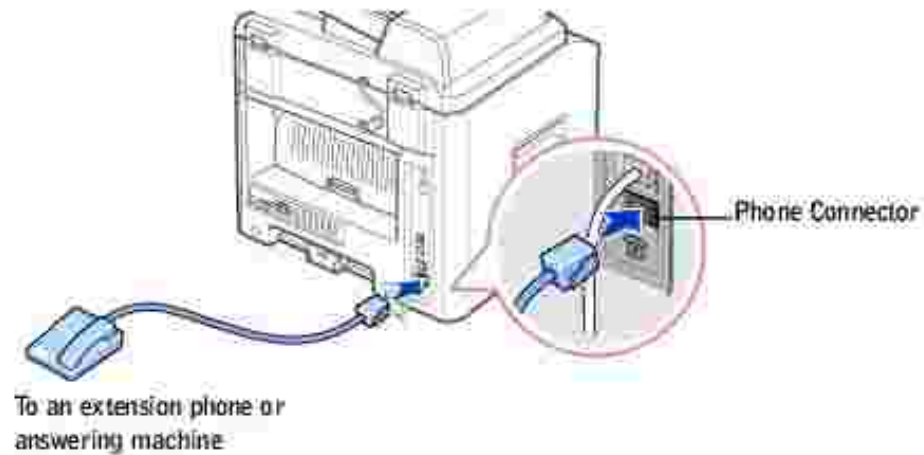

If the phone communication is serial in your country (such as Germany, Sweden, Denmark, Austria, Belgium, Italy, France and Switzerland), remove the plug from the Phone connector (☎) and insert the supplied terminator.

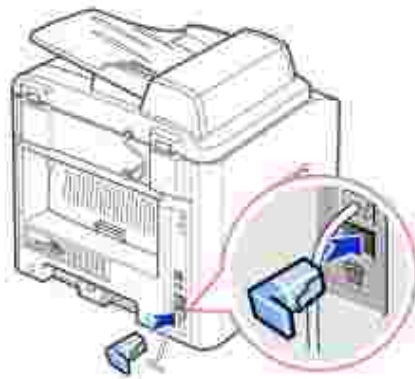

Connecting the Printer Cable

Connecting the Multi-Function Printer Locally

A local printer is a printer connected to your computer using a USB cable. *If your multi-function printer is attached to a network instead of your computer, skip this step and go on to "Connecting the Multi-Function Printer to the Network" on page 31.*

USB cables are sold separately. Contact Dell to purchase a USB cable.

NOTE: Connecting the multi-function printer to the USB port of the computer requires a certified USB cable. You will need to buy a USB 2.0 compliant cable that is about 3 m in length.

To connect the multi-function printer to a computer:

1. Make sure the multi-function printer, computer, and any other attached devices are powered off and unplugged.
2. Connect a USB cable to the USB connector on your multi-function printer.

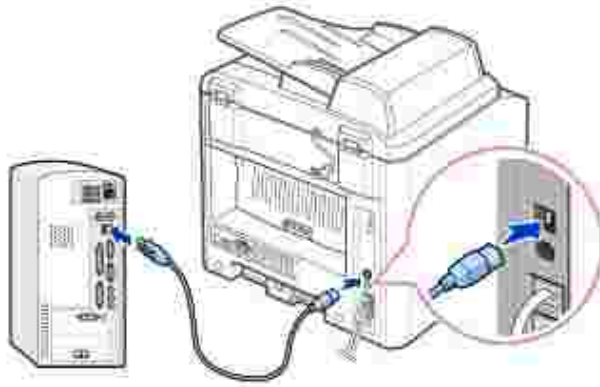

3. Connect the other end of the cable into an available USB port on the computer, not the USB keyboard.

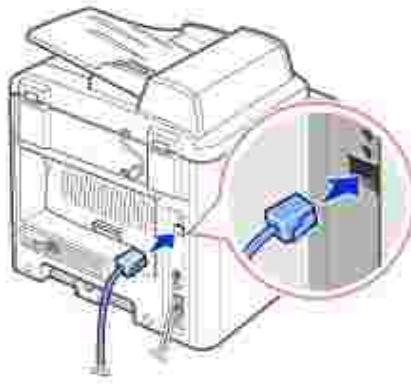

Connecting the Multi-Function Printer to the Network

1. Make sure the multi-function printer, computer, and any other attached devices are powered off and unplugged.
2. Connect one end of a standard category 5 Unshielded Twisted Pair (UTP) network cable into a LAN drop or hub, and the other end into the Ethernet network port on the back of the multi-function printer. The multi-function printer automatically adjusts for the network speed.



 **NOTE:** After connecting the multi-function printer, you need to configure the network parameters on the operator panel. See page 147 .

Powering On the Multi-Function Printer

-  **CAUTION:** The fusing area at the rear part of the inside of your multi-function printer becomes hot once the multi-function printer is powered on.
-  **CAUTION:** Be careful not to be burned when you access this area.
-  **CAUTION:** Do not disassemble the multi-function printer when it is powered on. If you do, it may give you an electric shock.

To power on the multi-function printer:

1. Plug one end of the power cord into the socket at the back of the multi-function printer and the other end into a properly grounded outlet.
2. Press the power switch to power on the multi-function printer. "Warming Up Please Wait " appears on the display indicating that the multi-function printer is now on.

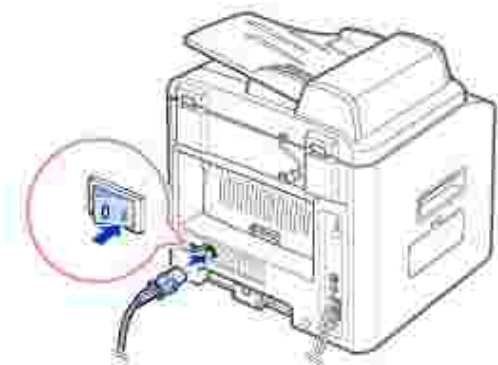

To view your display text in another language, see page 33 .

Changing the Display Language

To change the displayed language that the operator panel displays, follow these steps:

1. Press <Menu> until "Printer Setup" appears on the top line of the display.
2. Press the scroll button (◀ or ▶) until "Language" appears on the bottom line of the display.
3. Press <Select>. The current setting appears on the bottom line of the display.
4. Press the scroll button (◀ or ▶) until the language you want appears on the display.

The available languages are English, French, German, Italian, and Spanish.

5. Press <Select> to save the selection.

6. To return to Standby mode, press <Return>.
-

Toner Save Mode

The Toner Save mode allows your multi-function printer to use less toner on each page. Activating this mode extends the life of the toner cartridge longer than the normal mode, but it reduces the print quality.

 **NOTE:** For PC-printing, you can also turn on or off the Toner Save mode in the multi-function printer properties. See page 77 .

To turn the Toner Save mode on:

1. Press <Menu> until "Printer Setup" appears on the top line of the display.
2. Press the scroll button (◀ or ▶) until "Toner Save" appears on the bottom line. Press <Select>.
3. Press the scroll button (◀ or ▶) to display "On" on the bottom line and press <Select>.

Selecting "Off" means that the Toner Save mode is turned off.

4. To return to Standby mode, press <Return>.
-

Power Save Mode

The Power Save mode allows your multi-function printer to reduce power consumption when it is not in actual use. You can turn this mode on by selecting the length of time for which the multi-function printer waits after a job is printed before it switches to a reduced power state.

1. Press <Menu> until "Printer Setup" appears on the top line of the display.
2. Press the scroll button (◀ or ▶) until "Power Save" appears on the bottom line. Press <Select>.
3. Press the scroll button (◀ or ▶) to display "On" on the bottom line and press <Select>.

Selecting "Off" means that the Power Save mode is turned off.

4. Press the scroll button (◀ or ▶) until the time settings you want appears.

The available options are 5, 10, 15, 30 and 45 (minutes).

5. Press <Select> to save the selection.
 6. To return to Standby mode, press <Return>.
-

Charge-Coupled Device (CCD) Power Save Mode

The scan lamp under the scanner glass automatically turns off when it is not in actual use during a preset period to reduce power consumption and extend the lamp life. The lamp automatically turns on and the warm-up cycle begins whenever any key is pressed or the document cover is opened or a document is detected in the ADF.

You can set the length of time for which the scan lamp waits after a scan job is completed before it switches to the Power Save mode.

1. Press <Menu> until "Printer Setup" appears on top line of the display.
2. Press the scroll button (◀ or ▶) until "CCD Power Save" appears on the bottom line. Press <Select>.
3. Press the scroll button (◀ or ▶) until the time setting you want appears on the bottom line.

The available time options are 0.5, 1, 4, 8, and 12 (hours).

4. Press <Select> to save the selection.
5. To return to Standby mode, press <Return>.

- [Software Overview](#)
 - [Installing Software](#)
 - [Uninstalling Software](#)
 - [Using the Dell™ Toner Management System](#)
 - [Printer Settings Utility](#)
-

Software Overview

After setting up your multi-function printer and connecting it your computer, you must install the drivers and utilities from the *Drivers and Utilities* CD included with your multi-function printer. If you purchased a Dell™ computer and your multi-function printer at the same time, the drivers and utilities are automatically installed. You don't need to install them. The *Drivers and Utilities* CD contains the following:

- Dell Printer Drivers- allows your computer to communicate with your multi-function printer. To use your multi-function printer as a printer in Windows, you must install the printer driver(s). For information about installing the printer drivers in Windows, see [page 36](#).
 - Printer Settings Utility- allows you to set up fax phonebook and the machine's other options from your PC desktop. It also allows you to update the firmware of your machine. You can also configure the scan destination application which is automatically launched when you press the <Select Software> button on the operator panel.
 - Dell Toner Management System™- displays the status of the printer and the name of the job when you send a job to print. The Dell Toner Management System™ window also displays the level of toner remaining and allows you to order replacement toner cartridges.
 - PaperPort® - allows you to scan documents, create PDFs, and turn your scanned images into editable Microsoft® Word, Excel, or text files. PaperPort® provides improved scanning features and supports annotations on all image types. PaperPort's enhanced search feature allows you to find items by specific item properties.
 - Dell ScanCenter™- This is the front-end that enables you to quickly scan documents into a variety of applications, such as e-mail, photo editors, and text editors.
 - Scan Driver- TWAIN or Windows Image Acquisition (WIA) drivers are available for scanning documents on your multi-function printer.
 - User's Guide- HTML documentation provides detailed information about using your multi-function printer.
-

Installing Software

Before you begin, ensure that your system meets the minimum requirements.

 **NOTE:** For Windows NT 4.0/2000/XP/Server 2003, the system administrator should install Dell software.

Supported Operating Systems

- Windows 98/98 SE/Me/NT 4 Workstation or Server with Service Pack 3
- Windows 2000 Professional or Advanced Server
- Windows XP Home edition or Professional/Server 2003.

Minimum Requirements

- Disk space: 120 MB for installation
- Memory: 64 MB
- CPU: Pentium II 233 or higher
- Required software: Internet Explorer 4.01

Recommended

- Disk space: 220 MB for installation
- Memory: 128 MB
- CPU: Pentium II 400 or higher
- Required software: Internet Explorer 5.5

Installing Dell Software for Local Printing

A local printer is a printer attached to your computer using a USB cable. *If your printer is attached to a network instead of your computer*, skip this step and go on to ["Installing Dell Software for Network Printing" on page 39](#).

A printer driver is software that lets your computer communicate with your printer. The procedure to install drivers depends on the operating system you are using.

 **NOTE:** If you attach a USB printer cable while your printer and computer are powered on, the Windows hardware wizard launches immediately. Cancel the screen and use the *Drivers and Utilities* CD to install the Dell software.

1. Make sure that the printer is connected to your computer and powered on. Close all unnecessary programs.

 **NOTE:** If the multi-function printer is not connected to your computer when you install the CD-ROM, the No Printer Found screen appears. Follow the instructions to install the software.

2. Insert the *Drivers and Utilities* CD.



3. If necessary, select a language by pressing the Language button on the main screen.

4. Select Personal Installation.

5. Select Typical Installation to install the *User's Guide*, the printer drivers, scanner driver and PaperPort as the default settings.



To install selected software including the printer Postscript driver, select Custom Installation. You can also change the destination folder.

6. When the installation has been completed, you may print a test page. Click Finish to complete the installation and close the wizard. You are now ready to print.

Assigning an IP Address

Before using the printer on the network, you must set an IP address, subnet mask, and gateway for the multi-function printer. If you want DHCP or BOOTP to automatically set the IP address, a DHCP or BOOTP server must exist on the network.

To configure the IP address manually, you can use the supplied *Drivers and Utilities* CD. Print the Configuration page of the multi-function printer to see the current network configuration and MAC address. You will need this information to configure the multi-function printer for the network.

1. Make sure that the multi-function printer is connected to your network and powered on. Close all unnecessary programs.
2. Insert the *Drivers and Utilities* CD.



3. If necessary, select a language by pressing the Language button on the main screen.
4. Select Set IP Address Utility. The list of printers available on the network displays.

Print Name	IP Address	Subnet Mask	Gateway	Default Queue
HP-1111-1111	192.168.1.111	255.255.255.0	192.168.1.1	HP-1111-1111
HP-1111-1112	192.168.1.112	255.255.255.0	192.168.1.1	HP-1111-1112
HP-1111-1113	192.168.1.113	255.255.255.0	192.168.1.1	HP-1111-1113
HP-1111-1114	192.168.1.114	255.255.255.0	192.168.1.1	HP-1111-1114
HP-1111-1115	192.168.1.115	255.255.255.0	192.168.1.1	HP-1111-1115
HP-1111-1116	192.168.1.116	255.255.255.0	192.168.1.1	HP-1111-1116
HP-1111-1117	192.168.1.117	255.255.255.0	192.168.1.1	HP-1111-1117
HP-1111-1118	192.168.1.118	255.255.255.0	192.168.1.1	HP-1111-1118
HP-1111-1119	192.168.1.119	255.255.255.0	192.168.1.1	HP-1111-1119
HP-1111-1120	192.168.1.120	255.255.255.0	192.168.1.1	HP-1111-1120
HP-1111-1121	192.168.1.121	255.255.255.0	192.168.1.1	HP-1111-1121
HP-1111-1122	192.168.1.122	255.255.255.0	192.168.1.1	HP-1111-1122
HP-1111-1123	192.168.1.123	255.255.255.0	192.168.1.1	HP-1111-1123
HP-1111-1124	192.168.1.124	255.255.255.0	192.168.1.1	HP-1111-1124
HP-1111-1125	192.168.1.125	255.255.255.0	192.168.1.1	HP-1111-1125
HP-1111-1126	192.168.1.126	255.255.255.0	192.168.1.1	HP-1111-1126
HP-1111-1127	192.168.1.127	255.255.255.0	192.168.1.1	HP-1111-1127
HP-1111-1128	192.168.1.128	255.255.255.0	192.168.1.1	HP-1111-1128
HP-1111-1129	192.168.1.129	255.255.255.0	192.168.1.1	HP-1111-1129
HP-1111-1130	192.168.1.130	255.255.255.0	192.168.1.1	HP-1111-1130
HP-1111-1131	192.168.1.131	255.255.255.0	192.168.1.1	HP-1111-1131
HP-1111-1132	192.168.1.132	255.255.255.0	192.168.1.1	HP-1111-1132
HP-1111-1133	192.168.1.133	255.255.255.0	192.168.1.1	HP-1111-1133
HP-1111-1134	192.168.1.134	255.255.255.0	192.168.1.1	HP-1111-1134
HP-1111-1135	192.168.1.135	255.255.255.0	192.168.1.1	HP-1111-1135
HP-1111-1136	192.168.1.136	255.255.255.0	192.168.1.1	HP-1111-1136
HP-1111-1137	192.168.1.137	255.255.255.0	192.168.1.1	HP-1111-1137
HP-1111-1138	192.168.1.138	255.255.255.0	192.168.1.1	HP-1111-1138
HP-1111-1139	192.168.1.139	255.255.255.0	192.168.1.1	HP-1111-1139
HP-1111-1140	192.168.1.140	255.255.255.0	192.168.1.1	HP-1111-1140
HP-1111-1141	192.168.1.141	255.255.255.0	192.168.1.1	HP-1111-1141
HP-1111-1142	192.168.1.142	255.255.255.0	192.168.1.1	HP-1111-1142
HP-1111-1143	192.168.1.143	255.255.255.0	192.168.1.1	HP-1111-1143
HP-1111-1144	192.168.1.144	255.255.255.0	192.168.1.1	HP-1111-1144
HP-1111-1145	192.168.1.145	255.255.255.0	192.168.1.1	HP-1111-1145
HP-1111-1146	192.168.1.146	255.255.255.0	192.168.1.1	HP-1111-1146
HP-1111-1147	192.168.1.147	255.255.255.0	192.168.1.1	HP-1111-1147
HP-1111-1148	192.168.1.148	255.255.255.0	192.168.1.1	HP-1111-1148
HP-1111-1149	192.168.1.149	255.255.255.0	192.168.1.1	HP-1111-1149
HP-1111-1150	192.168.1.150	255.255.255.0	192.168.1.1	HP-1111-1150
HP-1111-1151	192.168.1.151	255.255.255.0	192.168.1.1	HP-1111-1151
HP-1111-1152	192.168.1.152	255.255.255.0	192.168.1.1	HP-1111-1152
HP-1111-1153	192.168.1.153	255.255.255.0	192.168.1.1	HP-1111-1153
HP-1111-1154	192.168.1.154	255.255.255.0	192.168.1.1	HP-1111-1154
HP-1111-1155	192.168.1.155	255.255.255.0	192.168.1.1	HP-1111-1155
HP-1111-1156	192.168.1.156	255.255.255.0	192.168.1.1	HP-1111-1156
HP-1111-1157	192.168.1.157	255.255.255.0	192.168.1.1	HP-1111-1157
HP-1111-1158	192.168.1.158	255.255.255.0	192.168.1.1	HP-1111-1158
HP-1111-1159	192.168.1.159	255.255.255.0	192.168.1.1	HP-1111-1159
HP-1111-1160	192.168.1.160	255.255.255.0	192.168.1.1	HP-1111-1160
HP-1111-1161	192.168.1.161	255.255.255.0	192.168.1.1	HP-1111-1161
HP-1111-1162	192.168.1.162	255.255.255.0	192.168.1.1	HP-1111-1162
HP-1111-1163	192.168.1.163	255.255.255.0	192.168.1.1	HP-1111-1163
HP-1111-1164	192.168.1.164	255.255.255.0	192.168.1.1	HP-1111-1164
HP-1111-1165	192.168.1.165	255.255.255.0	192.168.1.1	HP-1111-1165
HP-1111-1166	192.168.1.166	255.255.255.0	192.168.1.1	HP-1111-1166
HP-1111-1167	192.168.1.167	255.255.255.0	192.168.1.1	HP-1111-1167
HP-1111-1168	192.168.1.168	255.255.255.0	192.168.1.1	HP-1111-1168
HP-1111-1169	192.168.1.169	255.255.255.0	192.168.1.1	HP-1111-1169
HP-1111-1170	192.168.1.170	255.255.255.0	192.168.1.1	HP-1111-1170
HP-1111-1171	192.168.1.171	255.255.255.0	192.168.1.1	HP-1111-1171
HP-1111-1172	192.168.1.172	255.255.255.0	192.168.1.1	HP-1111-1172
HP-1111-1173	192.168.1.173	255.255.255.0	192.168.1.1	HP-1111-1173
HP-1111-1174	192.168.1.174	255.255.255.0	192.168.1.1	HP-1111-1174
HP-1111-1175	192.168.1.175	255.255.255.0	192.168.1.1	HP-1111-1175
HP-1111-1176	192.168.1.176	255.255.255.0	192.168.1.1	HP-1111-1176
HP-1111-1177	192.168.1.177	255.255.255.0	192.168.1.1	HP-1111-1177
HP-1111-1178	192.168.1.178	255.255.255.0	192.168.1.1	HP-1111-1178
HP-1111-1179	192.168.1.179	255.255.255.0	192.168.1.1	HP-1111-1179
HP-1111-1180	192.168.1.180	255.255.255.0	192.168.1.1	HP-1111-1180
HP-1111-1181	192.168.1.181	255.255.255.0	192.168.1.1	HP-1111-1181
HP-1111-1182	192.168.1.182	255.255.255.0	192.168.1.1	HP-1111-1182
HP-1111-1183	192.168.1.183	255.255.255.0	192.168.1.1	HP-1111-1183
HP-1111-1184	192.168.1.184	255.255.255.0	192.168.1.1	HP-1111-1184
HP-1111-1185	192.168.1.185	255.255.255.0	192.168.1.1	HP-1111-1185
HP-1111-1186	192.168.1.186	255.255.255.0	192.168.1.1	HP-1111-1186
HP-1111-1187	192.168.1.187	255.255.255.0	192.168.1.1	HP-1111-1187
HP-1111-1188	192.168.1.188	255.255.255.0	192.168.1.1	HP-1111-1188
HP-1111-1189	192.168.1.189	255.255.255.0	192.168.1.1	HP-1111-1189
HP-1111-1190	192.168.1.190	255.255.255.0	192.168.1.1	HP-1111-1190
HP-1111-1191	192.168.1.191	255.255.255.0	192.168.1.1	HP-1111-1191
HP-1111-1192	192.168.1.192	255.255.255.0	192.168.1.1	HP-1111-1192
HP-1111-1193	192.168.1.193	255.255.255.0	192.168.1.1	HP-1111-1193
HP-1111-1194	192.168.1.194	255.255.255.0	192.168.1.1	HP-1111-1194
HP-1111-1195	192.168.1.195	255.255.255.0	192.168.1.1	HP-1111-1195
HP-1111-1196	192.168.1.196	255.255.255.0	192.168.1.1	HP-1111-1196
HP-1111-1197	192.168.1.197	255.255.255.0	192.168.1.1	HP-1111-1197
HP-1111-1198	192.168.1.198	255.255.255.0	192.168.1.1	HP-1111-1198
HP-1111-1199	192.168.1.199	255.255.255.0	192.168.1.1	HP-1111-1199
HP-1111-1200	192.168.1.200	255.255.255.0	192.168.1.1	HP-1111-1200

5. Select the printer you want to assign an IP to. The printer's default IP address can be found on the Configuration page for the printer.
6. When you finish setting the IP address for the printer, exit the program.

Installing Dell Software for Network Printing

When you connect your multi-function printer to the network, you must first configure the TCP/IP settings for the multi-function printer. After you have assigned and verified the TCP/IP settings, you are ready to install the Dell software on each network computer.

You can install the Dell software on the network computers locally or remotely.

 **NOTE:** You need administrative access to install printer drivers on the network computers.

1. Make sure that the multi-function printer is connected to your network and powered on. Close all unnecessary programs. For details about connecting on the network, see [page 31](#).
2. Insert the *Drivers and Utilities* CD.



3. If necessary, select a language by pressing the Language button on the main screen.
4. Select Network Installation.
5. If you want to install the drivers on this computer for network operation, select Local Installation, and click Next.

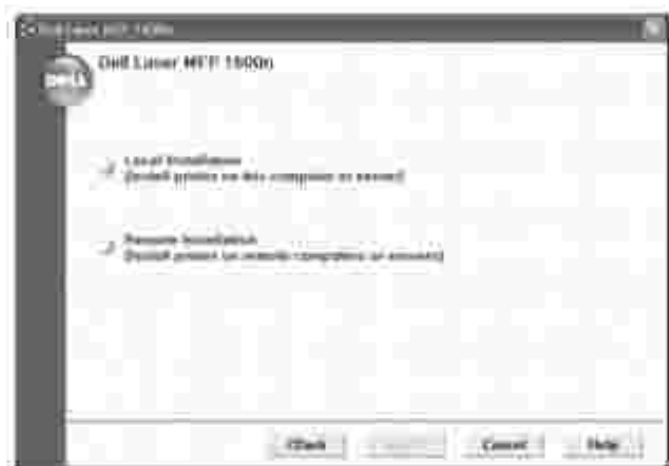

If you want to install the Dell software on remote computers or network servers on the same network, select Remote Installation. The domain administrator's ID and password are required. Select the client computer(s) in the same domain on a network and click Next.

NOTE: Both server computer and client computer should be one of the following OS: Windows XP, Windows Server 2003, Windows 2000, Windows NT4.0.

NOTE: The server computer should be able to resolve the client computer name into an IP address.

6. The list of printers available on the network appears. Select the printer you want to install from the list and then click Next.



If you do not see your multi-function printer in the list, click Update to refresh the list or click Add Printer to add your multi-function printer to the network. To add the printer to the network, enter the port name and an existing IP address for the printer.

If you want to install it on a server, select the I am setting up this printer on a server check box.

7. A list of printer drivers and utilities that will be installed displays. Click Next.



8. The next screen shows the printer drivers installed on your computer.

You can also change the printer name, set the printer to be shared on the network, and set the printer as the default printer. Click Next.



9. When the installation has been completed, you may print a test page. Click Finish.

Uninstalling Software

You should remove the printer drivers if you are upgrading the software or if your driver installation fails. You can remove the software using the *Drivers and Utilities* CD or the Windows uninstall.

 **NOTE:** Close all programs before uninstalling software, and then restart your computer after uninstalling software.

1. From the Start menu, select Programs ⇒ Dell ⇒ Dell Printers ⇒ Dell Laser MFP 1600n ⇒ Dell MFP Software Uninstall.



2. Select the software you want to remove.
3. When your computer prompts you to confirm your selection, click Yes. The selected driver and all of its components are removed from your computer.
4. Click OK.
5. Restart your computer.

Using the Dell™ Toner Management System

The Local Status Monitor displays the status of the multi-function printer (Printer Ready, Printer Offline, and Error-Check Printer), the name of the job currently being printed and the toner level for your multi-function printer.

If you are a network user, you can access the Network Status Monitor Center which shows the status of all the printers available in the network.

Local Printer Status Monitor

The Local Status Monitor launches when you send a print job to the multi-function printer. This only appears on the computer screen.

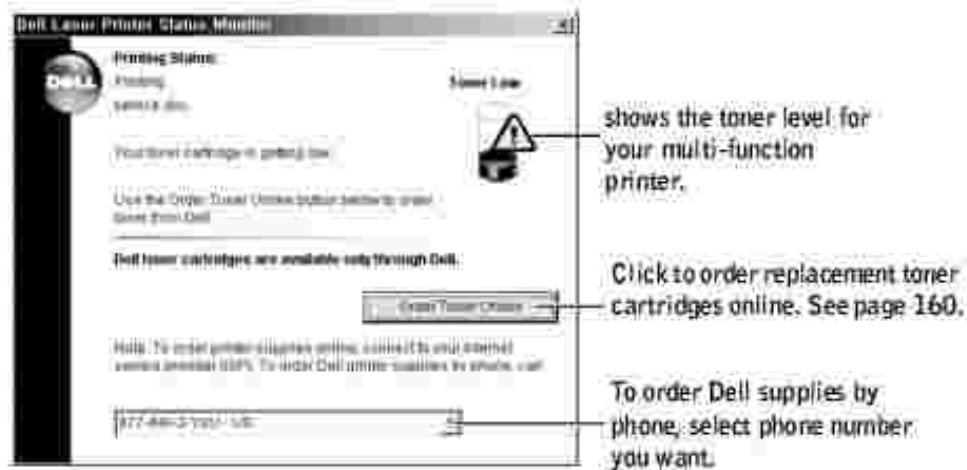

Network Status Monitor Center

If your multi-function printer is connected to a network, you can use the Network Status Monitor Center. Using the Network Status Monitor Center, you can launch the Dell Printer Configuration Web Tool and manage the status of multiple printers on the network.

 **NOTE:** This application is only available when the multi-function printer is connected to a network.

1. Click Start ⇒ Programs ⇒ Dell ⇒ Dell Printers ⇒ Dell Laser MFP 1600n ⇒ Network Status Monitor Center.
2. Double-click a printer name to open its Status Monitor, or select Run to open a Status Monitor for a particular printer.
3. Select Update to change the appearance of the list of printers.

Printer Settings Utility

Using the Printer Settings Utility window, you can set up fax system data options, and create and edit Phonebook entries from your computer. You can also configure the destination launches when you use the <Select Software> button on the operator panel, and update the firmware of the multi-function printer.

When you install the Dell software, the Printer Settings Utility is automatically installed.

For information about installing the software, see [page 36](#).

To open the Printer Settings Utility:

1. Click Start ⇒ Programs ⇒ Dell ⇒ Dell Printers ⇒ Dell Laser MFP 1600n ⇒ Printer Settings Utility.

The Printer Settings Utility window opens.



2. The Printer Settings Utility window provides four tabs; Phonebook, Scan Settings, Fax Cover Sheet, and Firmware Update.

To exit, click the Exit button at the bottom of each tab.

For further details, click the Help button at the bottom of each tab.

The Phonebook Tab

Click the Phonebook tab to create and edit Phonebook entries.

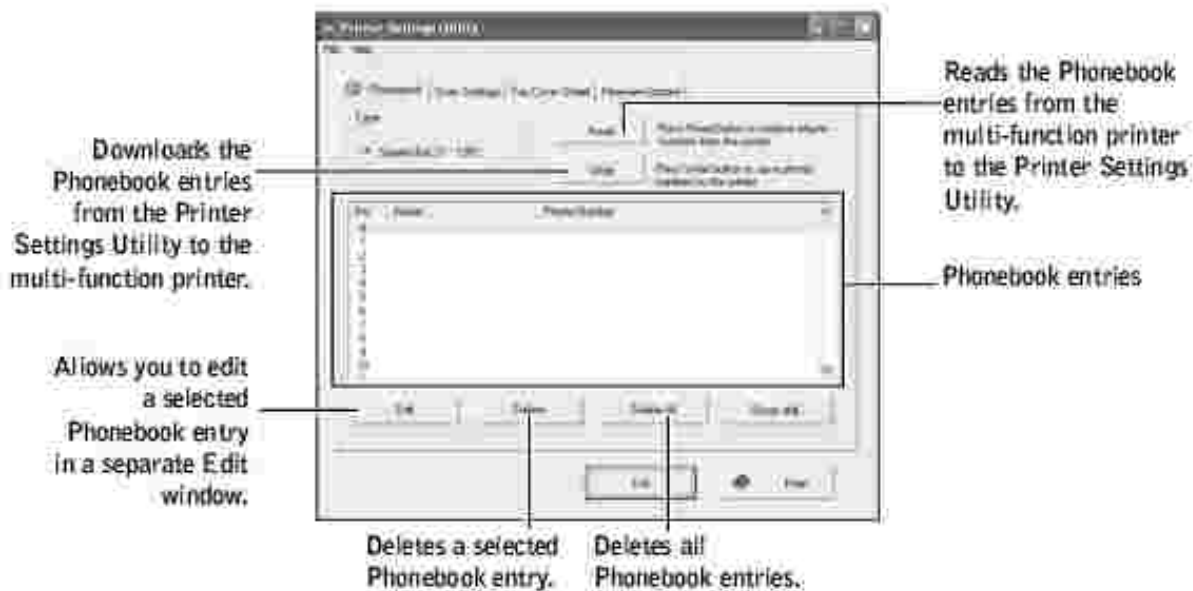

The Scan Settings Tab

Click the Scan Settings tab to configure the scan destination list that appears on the operator panel display when you press <Select Software> on the operator panel. Using the destination list, you can select a software program that an image can be scanned to.

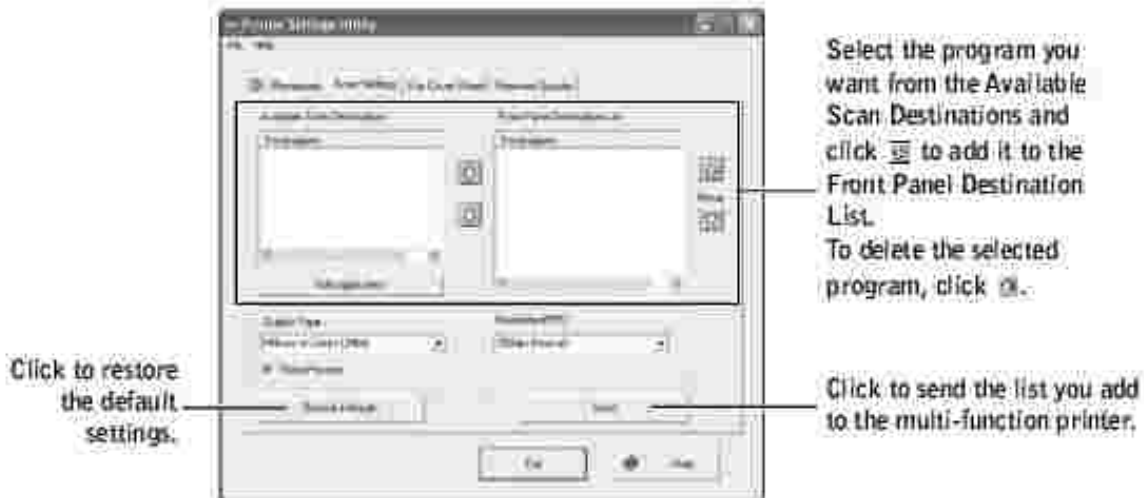

The Fax Cover Sheet Tab

Click the Fax Cover Sheet tab to create a fax cover page. For details, see [page 141](#). The fax cover page contains the date, the sender's fax number and machine ID, the recipient's fax number and machine ID stored in the sender's Phonebook and the total number of pages you sent.

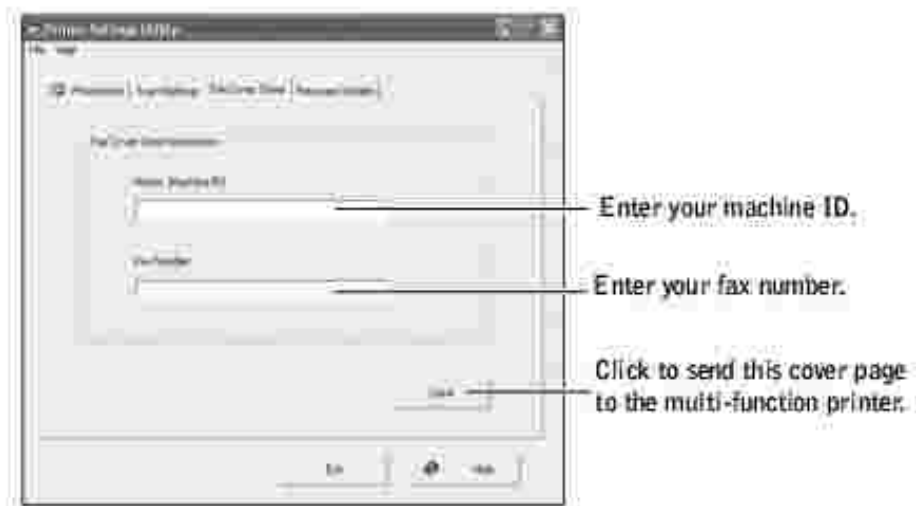

The Firmware Update Tab

Click the Firmware Update tab to update the firmware of your multi-function printer. This feature should only be used by an authorized technician.



Paper Handling

- [Print Media Guidelines](#)
 - [Storing Print Media](#)
 - [Identifying Print Media Sources and Specifications](#)
 - [Selecting an Output Location](#)
 - [Loading Print Media in the Paper Tray](#)
 - [Using the Manual Feeder](#)
 - [Setting the Paper Type](#)
 - [Setting the Paper Size](#)
-

Print Media Guidelines

Print media is paper, card stock, transparencies, labels, and envelopes. Your printer provides high quality printing on a variety of print media. Selecting the appropriate print media for your multi-function printer helps you avoid printing problems. This chapter provides information on how to help you make print media selections, how to care for the print media, and how to load it in the standard Tray1, optional Tray2 or manual feeder.

Paper

For the best print quality, use 75 g/m² (20 lb) xerographic, long grain paper. Try a sample of any paper you are considering using with the multi-function printer before buying large quantities.

When loading paper, note the recommended print side on the paper package, and load paper accordingly. See "[Loading Print Media in the Paper Tray](#)" on page 63 and "[Using the Manual Feeder](#)" on page 64 for detailed loading instructions.

Paper Characteristics

The following paper characteristics affect print quality and reliability. We recommend that you follow these guidelines when evaluating new paper stock.

Weight

The multi-function printer can automatically feed paper weights from 60 to 105 g/m² (16 to 28 lb bond) grain long in the ADF and from 60 to 90 g/m² (16 to 24 lb bond) grain long in the paper tray. Paper lighter than 60 g/m² (16 lb) may not be stiff enough to feed properly, causing jams. For best performance, use 75

g/m² (20 lb bond) long grain paper.

Curl

Curl is the tendency of print media to curve at its edges. Excessive curl can cause paper feeding problems. Curl usually occurs after the paper passes through the multi-function printer, where it is exposed to high temperatures. Storing paper unwrapped in humid conditions, even in the paper tray, can contribute to paper curling prior to printing and can cause feeding problems.

Smoothness

The degree of smoothness of paper directly affects print quality. If the paper is too rough, the toner does not fuse to the paper properly, resulting in poor print quality. If the paper is too smooth, it can cause paper feeding problems. Smoothness should be between 100 and 300 Sheffield points; however, smoothness between 150 and 250 Sheffield points produces the best print quality.

Moisture Content

The amount of moisture in the paper affects both print quality and the ability of the multi-function printer to feed the paper properly. Leave the paper in its original wrapper until you are ready to use it. This limits the exposure of the paper to moisture changes that can degrade its performance.

Grain Direction

Grain refers to the alignment of the paper fibers in a sheet of paper. Grain is either long grain, running the length of the paper, or short grain, running the width of the paper.

For 60 to 90 g/m² (16 to 24 lb bond) paper, grain long fibers are recommended. For papers heavier than 90 g/m² (24 lb bond), grain short is preferred. For the multipurpose feeder, 60 to 90 g/m² (16 to 24 lb bond) paper, grain long fibers are recommended.

Fiber Content

Most high-quality xerographic paper is made from 100% chemically pulped wood. This content provides the paper with a high degree of stability resulting in fewer paper feeding problems and better print quality. Paper containing fibers such as cotton possess characteristics that can result in degraded paper handling.

Recommended Paper

To ensure the best print quality and feed reliability, use 75 g/m² (20 lb) xerographic paper. Business papers designed for general business use may also provide acceptable print quality.

Always print several samples before buying large quantities of any type of print media. When choosing any print media, consider the weight, fiber content, and color.

Use only paper able to withstand these temperatures without discoloring, bleeding, or releasing hazardous emissions. Check with the paper manufacturer or vendor to determine whether the paper you have chosen is acceptable for laser printers.

Unacceptable Paper

The following papers are not recommended for use with the multi-function printer:

- Chemically treated papers used to make copies without carbon paper, also known as carbonless papers, carbonless copy paper (CCP), or no carbon required (NCR) paper
- Preprinted papers with chemicals that may contaminate the multi-function printer
- Preprinted papers that can be affected by the temperature in the printer fuser
- Preprinted papers that require a registration (the precise print location on the page) greater than ± 0.09 in., such as optical character recognition (OCR) forms
- Coated papers (erasable bond), synthetic papers, thermal papers
- Rough-edged, rough or heavily textured surface papers or curled papers
- Recycled papers containing more than 25% post-consumer waste that do not meet DIN 19 309
- Recycled paper having a weight less than 60 g/m^2 (16 lb)
- Multiple-part forms or documents

Selecting Paper

Proper paper loading helps prevent jams and ensures trouble-free printing.

To help avoid jams or poor print quality:

- Always use new, undamaged paper.
- Before loading paper, know the recommended print side of the paper you are using. This information is usually indicated on the paper package.
- Do not use paper that you have cut or trimmed yourself.
- Do not mix print media sizes, weights, or types in the same source; mixing results in jams.
- Do not use coated papers.
- Remember to change the paper size setting when you use a source that does not support auto size sensing.
- Do not remove trays while a job is printing or Busy is displayed on the operator panel.
- Make sure the paper is properly loaded in the source.
- Flex paper back and forth. Do not fold or crease the paper. Straighten the edges on a level surface.

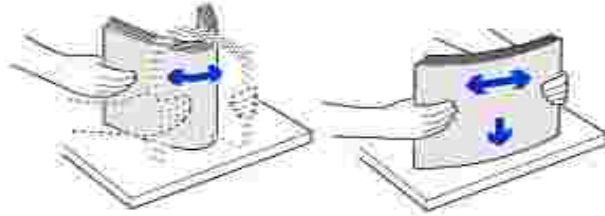

Selecting Preprinted Forms and Letterhead

Use the following guidelines when selecting preprinted forms and letterhead paper for the multi-function printer:

- Use long grain papers for best results.
- Use only forms and letterhead printed using an offset lithographic or engraved printing process.
- Choose papers that absorb ink, but do not bleed.
- Avoid papers with rough or heavily textured surfaces.



Use papers printed with heat-resistant inks designed for use in xerographic copiers. The ink must withstand temperatures of 225° C (437° F) without melting or releasing hazardous emissions. Use inks that are not affected by the resin in toner or the silicone in the fuser. Inks that are oxidation-set or oil-based should meet these requirements; latex inks might not. *If you are in doubt*, contact your paper supplier.

Preprinted papers such as letterhead must be able to withstand temperatures up to 225° C (437° F) without melting or releasing hazardous emissions.

Printing on Letterhead

Check with the manufacturer or vendor to determine whether the preprinted letterhead you have chosen is acceptable for laser printers.

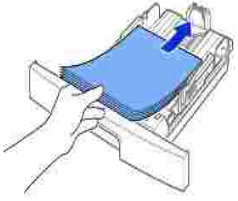
Page orientation is important when printing on letterhead. Use the following table for help when loading letterhead in the print media sources.

Print Media Source	Top of Page		
	Print Side	Portrait	Landscape
Tray 1 (standard tray) Optional Tray 2	Face down 	Front of tray	Left side of tray
Manual feeder	Face up 	Logo enters the printer first	Left side of tray

Selecting Prepunched Paper

Prepunched paper brands can differ in the number and placement of holes and in manufacturing techniques.

Use the following guidelines to select and use prepunched paper:

- Test paper from several manufacturers before ordering and using large quantities of pre-punched paper.
- Paper should be punched at the paper manufacturer and not drilled into paper already packaged in a ream. Drilled paper can cause jams when multiple sheets feed through the multi-function printer.
- Prepunched paper can include more paper dust than standard paper. Your multi-function printer may require more frequent cleaning and feed reliability may not be as good as that of standard paper.

Transparencies

Try a sample of any transparencies you are considering using with the multi-function printer before buying large quantities:

- Use transparencies designed specifically for laser printers. Transparencies must be able to withstand temperatures of 205° C (401° F) without melting, discoloring, offsetting or releasing hazardous emissions.

- Avoid getting fingerprints on the transparencies, which can cause poor print quality.
- Before loading transparencies, fan the stack to prevent sheets from sticking together.
- Load one transparency in the manual feeder.

Selecting Transparencies

The multi-function printer can print directly on transparencies designed for use in laser printers. Print quality and durability depend on the transparency used. Always print samples on the transparencies you are considering before buying large quantities.

Check with the manufacturer or vendor to determine whether your transparencies are compatible with laser printers that heat transparencies to 205° C (401° F). Use only transparencies that are able to withstand these temperatures without melting, discoloring, offsetting, or releasing hazardous emissions.

Envelopes

You can load one envelope at a time in the manual feeder. Try a sample of any envelopes you are considering using with the multi-function printer before buying large quantities. See [page 64](#) for instructions on loading an envelope.

When printing on envelopes:

- To achieve the best possible print quality, use only high-quality envelopes that are designed for use in laser printers.
- For best performance, use envelopes made from 75 g/m² (20 lb bond) paper. You can use up to 90 g/m² (24 lb bond) weight for the manual feeder as long as the cotton content is 25 percent or less.
- Use only new, undamaged envelopes.
- For best performance and to minimize jams, do not use envelopes that:
 - Have excessive curl or twist
 - Are stuck together or damaged in any way
 - Contain windows, holes, perforations, cutouts or embossing
 - Use metal clasps, string ties, or metal folding bars
 - Have an interlocking design
 - Have postage stamps attached
 - Have any exposed adhesive when the flap is in the sealed or closed position
 - Have nicked edges or bent corners
 - Have rough, cockle, or laid finishes

- Use envelopes that can withstand temperatures of 205° C (401° F) without sealing, excessive curling, wrinkling, or releasing hazardous emissions. *If you have any doubts about the envelopes you are considering using, check with the envelope supplier.*
- Adjust the width guide to fit the width of the envelopes.
- Load an envelope with the flap side down and with the stamp area on the top left side. The end of the envelope with the stamp area enters the manual feeder first.

See ["Using the Manual Feeder" on page 64](#) for instructions on loading an envelope.

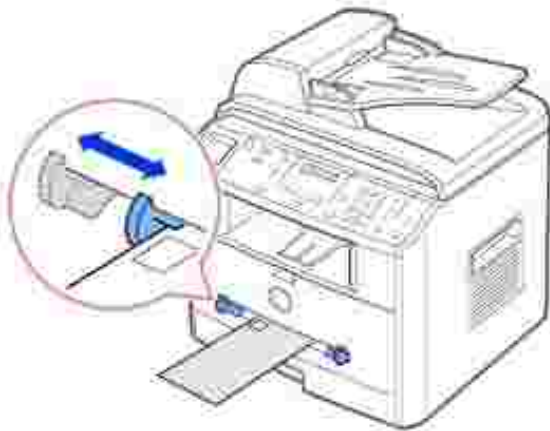

- A combination of high humidity (over 60%) and the high printing temperatures may seal the envelopes.

Labels

Your multi-function printer can print on many labels designed for use with laser printers. These labels are supplied in letter size, A4 size, and legal size sheets. Label adhesives, face sheet (printable stock), and topcoats must be able to withstand temperatures of 205° C (401° F) and pressure of 25 pounds per square inch (psi). You can load one label sheet at a time in the manual feeder.

Try a sample of any label you are considering using with the multi-function printer before purchasing a large quantity:

- Use full label sheets. Partial sheets may cause labels to peel off during printing, resulting in a jam. Partial sheets also contaminate your multi-function printer and your cartridge with adhesive, and could void your multi-function printer and cartridge warranties.
- Use labels that can withstand temperatures of 205° C (401° F) without sealing, excessive curling, wrinkling, or releasing hazardous emissions.
- Do not print within 0.04 in. (1 mm) of the edge of the label, of the perforations, or between die-cuts of the label.
- Do not use label sheets that have adhesive to the edge of the sheet. We recommend zone coating of

the adhesive at least 0.04 in. (1 mm) away from edges. Adhesive material contaminates your multi-function printer and could void your warranty.

- If zone coating of the adhesive is not possible, a 0.125 in. (3 mm) strip should be removed on the leading and driver edge, and a non-oozing adhesive should be used.
- Remove a 0.125 in. (3 mm) strip from the leading edge to prevent labels from peeling inside the multi-function printer.
- Portrait orientation is preferred, especially when printing bar codes.
- Do not use labels that have exposed adhesive.

Card Stock

Card stock is single ply, and has a large array of properties, such as the moisture content, thickness, and texture, that can significantly affect print quality. See "[Identifying Print Media Sources and Specifications](#)" on [page 57](#) for information on the preferred weight for the grain direction of print media.

Try a sample of any card stock you are considering using with the multi-function printer before purchasing a large quantity:

- Be aware that preprinting, perforation, and creasing can significantly affect the print quality and cause print media handling or jamming problems.
- Avoid using card stock that may release hazardous emissions when heated.
- Do not use preprinted card stock manufactured with chemicals that may contaminate the multi-function printer. Preprinting introduces semi-liquid and volatile components into the multi-function printer.
- We recommend the use of grain long card stock.

Storing Print Media

Use the following guidelines for proper print media storage. These help avoid print media feeding problems and uneven print quality:

- For best results, store print media in an environment where the temperature is approximately 21° C (70° F) and the relative humidity is 40%.
- Store cartons of print media on a pallet or shelf, rather than directly on the floor.
- *If you store individual packages of print media out of the original carton*, make sure they rest on a flat surface so the edges do not buckle or curl.
- Do not place anything on top of the print media packages.

Identifying Print Media Sources and Specifications

The following tables provide information on standard and optional sources, including the print media sizes you can select from the paper size menu and supported weights.

 **NOTE:** *If you use a print media size not listed, select the next larger size.*

Print Media Sizes and Support

Legend	Dimensions	Paper Tray	Manual Feeder
Y- indicates Support Print Media Size		(Standard Tray 1 and Optional Tray 2)	
A4	8.27 x 11.7 in. (210 x 297 mm)	Y	Y
A5	5.83 x 8.27 in. (148 x 210 mm)	Y	Y
A6 card	4.13 x 5.85 in. (105 x 148.5 mm)	-	Y
JIS B5	7.17 x 10.1 in. (182 x 257 mm)	Y	Y
ISO B5	6.93 x 9.84 in. (176 x 250 mm)	Y	Y
Letter	8.5 x 11 in. (215.9 x 279.4 mm)	Y	Y
Legal	8.5 x 14 in. (215.9 x 355.6 mm)	Y	Y
Executive	7.25 x 10.5 in. (184.2 x 266.7 mm)	Y	Y
Folio	8.5 x 13 in. (216 x 330 mm)	Y	Y
Envelope 7-3/4 (Monarch)	3.875 x 7.5 in. (98.4 x 190.5 mm)	-	Y

Envelope COM-10	4.12 x 9.5 in. (105 x 241 mm)	-	Y
Envelope DL	4.33 x 8.66 in. (110 x 220 mm)	-	Y
EnvelopeC5	6.38 x 9.01 in. (162 x 229 mm)	-	Y
Custom	3 x 5 in. to 8.5 x 14 in. (76 x 127 mm to 216 x 356 mm)	-	Y

Print Media Supported

Print Media	Paper Tray	Manual Feeder	Standard Output bin
Paper	Y	Y	Y
Card Stock	-	Y	Y
Transparencies	-	Y	-
Labels	-	Y	Y
Dual-web and Integrated Labels	-	Y	Y
Envelopes	-	Y	Y

Print Media Types and Weights

Print Media	Type	Print Media Weight	
		Standard Tray 1 and Optional Tray 2	Manual Feeder

Paper	Xerographic or business paper	60-90 g/m ² grain long (16-24 lb bond)	60-135 g/m ² grain long (16 to 36 lb bond)
Card stock-maximum (grain long) ^a	Index Bristol	163 g/m ² (43 lb)	120 g/m ² (31 lb)
	Tag	163 g/m ² (43 lb)	120 g/m ² (31 lb)
	Cover	163 g/m ² (43 lb)	135 g/m ² (35 lb)
Card stock-maximum (grain short) ^a	Index Bristol	163 g/m ² (43 lb)	163 g/m ² (43 lb)
	Tag	163 g/m ² (43 lb)	163 g/m ² (43 lb)
	Cover	163 g/m ² (43 lb)	163 g/m ² (43 lb)
Transparencies	Laser printer	138-146 g/m ² (37-39 lb bond)	138-146 g/m ² (37-39 lb bond)
Labels-maximum	Paper	163 g/m ² (43 lb bond)	163 g/m ² (43 lb bond)
	Dual-web paper	163 g/m ² (43 lb bond)	163 g/m ² (43 lb bond)
	Polyester	163 g/m ² (43 lb bond)	163 g/m ² (43 lb bond)
	Vinyl	163 g/m ² (43 lb liner)	163 g/m ² (43 lb liner)
Integrated Forms	Pressure- sensitive area (must enter the printer first)	135-140 g/m ² (36-40 lb bond)	135-140 g/m ² (36-40 lb bond)
	Paper base (grain long)	75-135 g/m ² (20-36 lb bond)	75-135 g/m ² (20-36 lb bond)
Envelopes 100% Cotton Content Maximum Weight- 24 lb	Sulfite, wood-free or up to 100% cotton bonds	75-90 g/m ² (20-24 lb)	75-90 g/m ² (20-24 lb)

a. Grain short is preferred for papers over 135g/m².

Selecting an Output Location

The multi-function printer has two output locations; the front output tray (face down) and the rear output slot (face up).

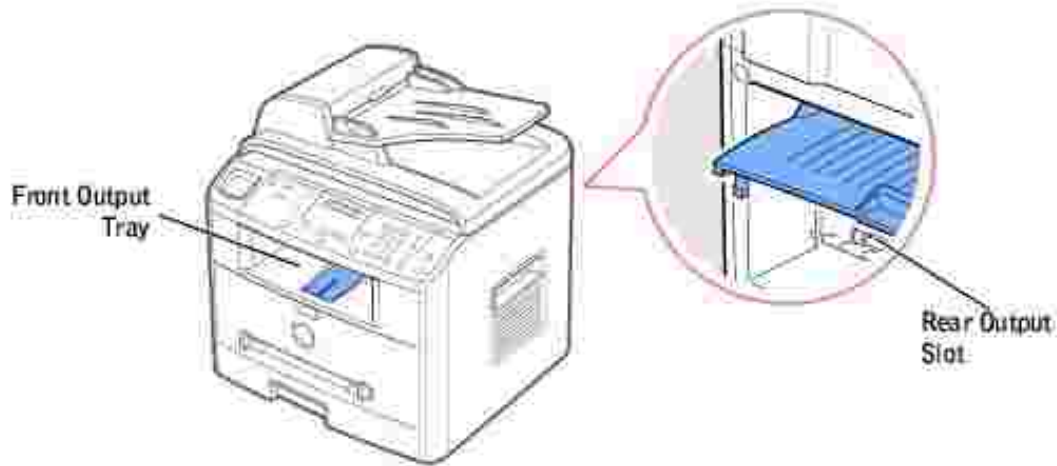

To use the front output tray, make sure that the rear cover is closed. To use the rear output slot, open the cover.

 **NOTE:** *If paper coming out of the front output tray has problems, such as excessive curl, try printing to the rear output slot.*

 **NOTE:** To avoid paper jams, do not open or close the rear cover while the multi-function printer is printing.

Printing to the Front Output Tray (*Face down*)

The front output tray collects printed paper face-down, in correct order. The tray should be used for most print jobs.



If necessary, expand the paper support extension to keep print media from falling off the front output tray.



Printing to the Rear Output Slot (*Face up*)

Using the rear output slot, paper comes out of the multi-function printer face up.



Printing from the manual feeder to the rear output slot provides a straight paper path. Using the rear output slot might improve the output quality with the following:

- Envelopes
- Labels
- Small Custom-sized Paper
- Card Stock
- Transparencies

To use the rear output slot:

 **CAUTION:** The fusing area at the rear part of the inside of your multi-function printer is hot when powered. Be careful not to get burned when you access this area.

1. Open the rear cover by pulling it upward.

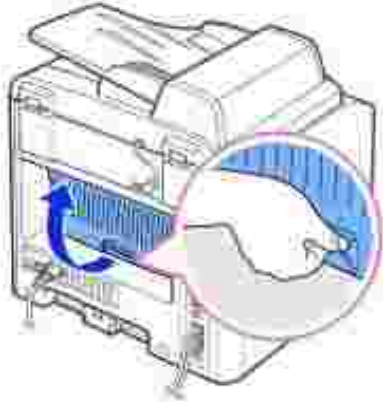

2. *If you do not want to stack the printed pages on the rear output slot, close the rear cover. The pages stack on the front output tray.*



Loading Print Media in the Paper Tray

You can load approximately 250 sheets of plain paper in the standard Tray1 or the optional Tray2. If you purchased the optional Tray2, see [page 191](#) for installing instructions. For faxing, you can use A4, letter or legal paper only. For copying or PC printing, you can use many different types and sizes of paper; see [page 57](#).

Follow these instructions to load print media into the standard Tray1 or optional Tray2. These trays are

loaded the same way.

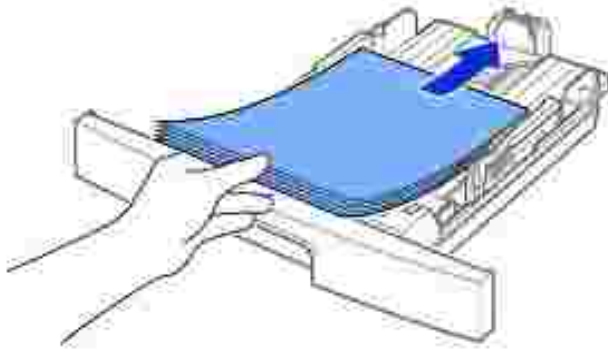

1. Pull open the paper tray and load paper with the print side face down.

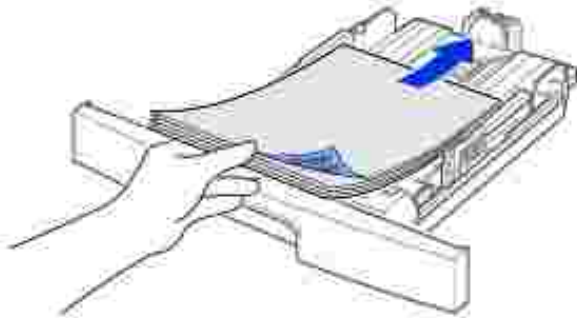

You can load letterhead paper with the design side face down. The top edge of the sheet with the logo should be placed at the front side of the tray.



For details about loading paper in the paper tray, see [page 25](#).

-  **NOTE:** *If you experience problems with paper feed,* place the paper in the manual feeder.
-  **NOTE:** You can load up to 100 sheets of previously printed paper. The printed side should be facing up with an uncurled edge at the top side. *If you experience problems with paper feed,* turn the paper around. Note that the print quality is not guaranteed.

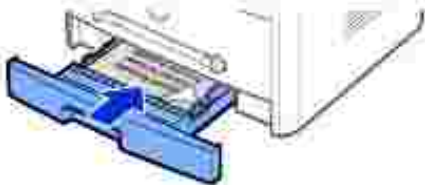



Using the Manual Feeder

Use the manual feeder to print transparencies, labels, envelopes or postcards in addition to making quick runs of paper types or sizes that are not currently loaded in the paper tray.

Postcards, 3.5 by 5.83 in. (index) cards and other custom-sized materials can be printed with this multi-function printer. The minimum size is 3.0 by 5.0 in. (76 by 127 mm) and the maximum size is 8.5 by 14 in. (216 by 356 mm).

Acceptable print materials are plain paper with sizes ranging from 3.9 by 5.8 in. (100 by 148 mm) to Legal, 8.5 by 14 in. (216 by 356 mm), the largest size acceptable, and weighing between 16 lb and 32 lb.

 **NOTE:** Always load only the print materials specified in the Specifications on [page 200](#) to avoid paper jams and print quality problems.

 **NOTE:** Flatten any curl on postcards, envelopes and labels before loading them into the manual feeder.

To use the manual feeder:

1. Set the paper type and size referring to [page 66~67](#).
2. Load a sheet of the print material with the print side face up into the center of the tray.

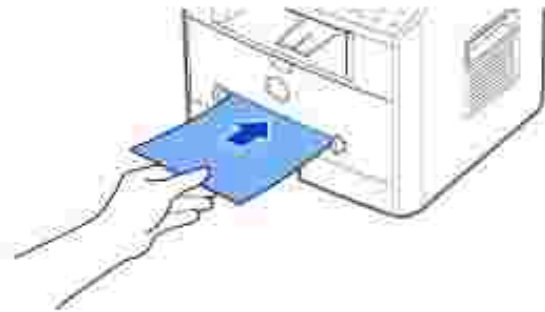

 **CAUTION:** Open the rear output slot when printing on transparencies or 3 by 5 in. media to prevent the damage or jam.

For envelopes, load a sheet with the flap side face down and with the stamp area on the top left side. The end of the envelope with the stamp area enters the tray first.

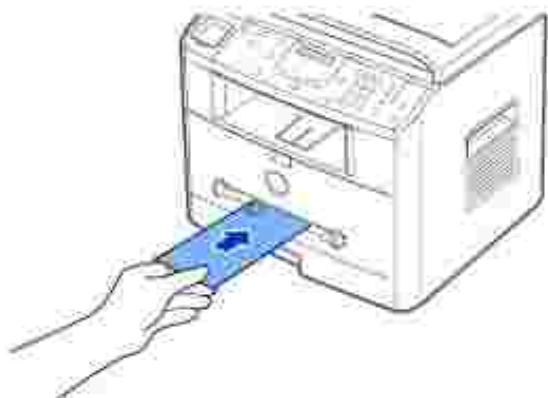

NOTICE: Never load envelopes with stamps, clasps, snaps, windows, coated linings, or self-stick adhesives. These envelopes may severely damage the multi-function printer. The stamp is shown in the illustration only for placement.

3. Adjust the paper guide to the width of the print material.

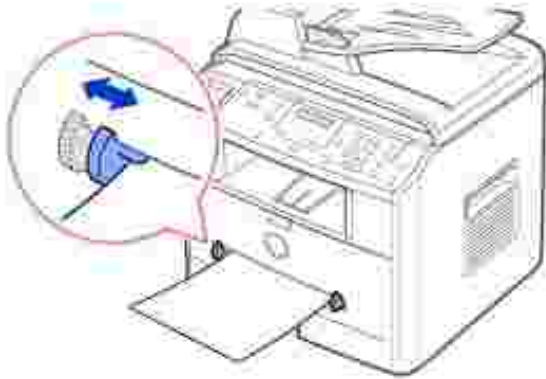

The multi-function printer picks up the material from the tray and begins printing.

 **NOTE:** When printing on previously printed paper from the manual feeder, the printed side should be facing down with an uncurled edge to the multi-function printer. *If you experience problems with paper feed, turn the paper around.*

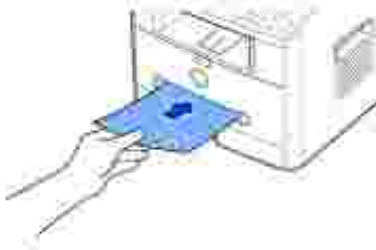

4. Open the rear cover to use the rear output slot.

5. After printing, close the rear cover.

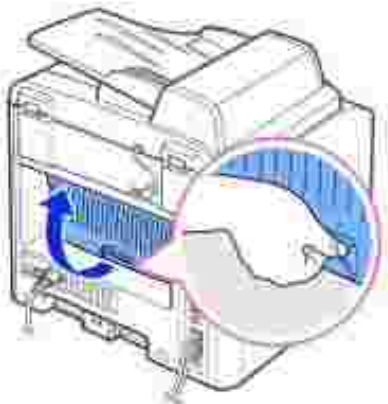

Setting the Paper Type

After loading paper in the paper tray or the manual feeder, you need to set the paper type using the operator panel buttons. This setting will apply to Fax and Copy modes. For faxing, you can only set the paper type to the Plain Paper. For PC-printing, you need to select the paper type in the application program you use.

1. Press <Menu>.

The display shows "Paper Setting" on the top line and the first menu item, "Paper Type" on the bottom line.

2. Press <Select> to access the menu item.
3. Use the scroll button (◀ or ▶) to find the paper type you are using and press <Select> to save.
4. To return to Standby mode, press <Return>.

Setting the Paper Size

After loading paper in the paper tray, you need to set the paper size using the operator panel buttons. This setting will apply to Fax and Copy modes. If you load paper in the manual feeder and set the paper size, this setting will apply to Copy mode. For PC-printing, you need to select the paper type in the application program you use.

1. Press <Menu>.
2. Press the scroll button (◀ or ▶) until "Paper Size" displays on the bottom line.
3. Press <Select>.

The first item, "Tray Paper" displays on the bottom line.

If the optional Tray 2 is installed, "Tray1 Paper" displays on the bottom line.

4. Use the scroll button (◀ or ▶) to select the paper tray you want to use and press <Select>.
5. Use the scroll button (◀ or ▶) to find the paper size you are using and press <Select>.
6. To return to Standby mode, press <Return>.

Printing

- [Printing a Document](#)
 - [Printing Multiple Pages on One Sheet of the Paper](#)
 - [Fitting Your Document to a Selected Paper Size](#)
 - [Printing Booklets](#)
 - [Using Overlays](#)
 - [Printer Settings](#)
 - [Printing a Reduced or Enlarged Document](#)
 - [Printing Posters](#)
 - [Using Watermarks](#)
-

Printing a Document

Your multi-function printer prints documents using the Graphic Device Interface (GDI), Printer Control Language (PCL) or Postscript (PS) printer driver. When you install the Dell software, your multi-function printer automatically installs the GDI and PCL printer drivers. Installing the PS printer driver is optional. See [page 37](#).

The drivers provided with your multi-function printer allow a wide variety of options. Use the chart below to determine which print driver is best suited for the job.

The features provided by each printer driver are as follows:

Feature	Printer Driver		
	GDI	PS	PCL
Toner Save	Y	Y	Y
Print quality option	Y	Y	Y
Poster	Y	N	Y
Reduce/Enlarge	Y	Y	Y
Booklet Printing	Y	N	Y
Multiple Pages per Side	Y	Y	Y
Fit to Page	Y	N	Y
Watermark	Y	N	Y
Overlay	Y	N	Y

The following procedure describes the general steps required for printing from various Windows applications. The exact steps for printing a document may vary depending on the application program you are using. Refer to your software application's *User's Guide* for the exact printing procedure.

1. Open the document you want to print.
2. Select Print from the File menu.

The Print window displays. It may look slightly different depending on your application.

The basic print settings are selected within the Print window. These settings include the number of copies and print range.

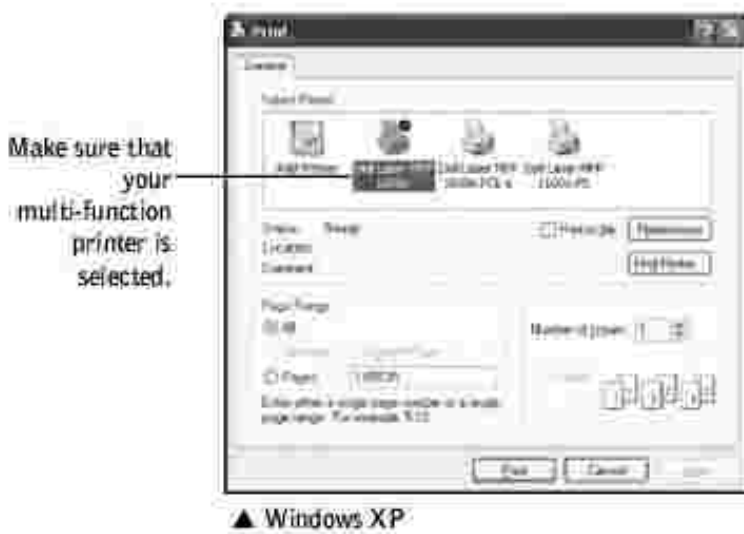

3. Select the printer driver you want to use from the Print window.
4. To take advantage of the printer features provided by your multi-function printer, click Preferences or Properties, depending on the program or operating system in the above window and go to step 5.

If you see Setup, Printer or Options, click that button instead. Then click Properties on the next screen.

5. Click OK to close the printer properties window.
6. To start the print job, click Print or OK, depending on the program or operating system in the Print window.

Canceling a Print Job

There are two ways to cancel a print job:

To stop a print job from the operator panel:

Press the <Cancel> button.



Your multi-function printer finishes printing the page that is moving through the multi-function printer and deletes the rest of the print job. Pressing the button cancels only the current job. *If more than one print job is in the printer's memory*, you need to press the button once for each job.

To stop a print job from the Printers folder:

 **NOTE:** You can access this window simply by double-clicking the printer icon at the bottom right corner of the Windows desktop.

1. From the Windows Start button, click Settings.
2. Point to Printers (Windows 98/Me/NT 4.0/2000) or Printers and Faxes (Windows XP/Server 2003) to open the Printers window and double-click the Dell Laser MFP 1600n icon.
3. From the Document menu, click Cancel (Windows NT 4.0/2000/XP/Server 2003) or Cancel Printing (Windows 98/Me).





▲ Windows XP

Printer Settings

You can use the printer properties window, which allows you to access all of the printer options you may need when using your multi-function printer. When the printer properties are displayed, you can review and change any settings needed for your print job.

The printer properties window may differ, depending on the printer driver you select and your operating system. For details about selecting a printer driver, see [page 70](#). The *User's Guide* shows the Printing Preferences window of the GDI printer driver on Windows XP.

 **NOTE:** Most Windows applications override settings you specified in the printer driver. Change all of the print settings available in the software application first, and change any remaining settings using the printer driver.

 **NOTE:** The settings you change remain in effect only while you are using the current program. To make your changes permanent, make them in the Printers folder. Follow these steps:

- a. Click the Windows Start button.
- b. For Windows 98/Me/NT 4.0/2000, click Settings and point to Printers.



For Windows XP/Server 2003, click Printers and Faxes.
- c. Point to the Dell Laser MFP 1600n printer.
- d. Right-click on the printer icon and:
 - o For Window 98/Me, click Properties.
 - o For Windows 2000/XP/Server 2003, click Print Setup or click Properties and point to Printing Preferences.
 - o For Windows NT 4.0, click Document Default.
- e. Change the settings on each tab and click OK.

Layout Tab

The Layout tab provides options for you to adjust how the document appears on the printed page. The Layout Options section includes advanced printing options, such as Multiple Pages per Side and Poster. See [page 71](#) for more information on accessing printer properties.



The preview image shows the sample page with the settings you currently specified.

Property	Description
<p>1 Orientation</p>	<p>Orientation allows you to select the direction in which information is printed on a page.</p> <ul style="list-style-type: none"> • Portrait prints across the width of the page, letter style. • Landscape prints across the length of the page, spreadsheet style. <p><i>If you want to rotate the page 180-degrees, select 180 from the Rotate drop-down list.</i></p> <div style="display: flex; justify-content: space-around; align-items: center;"> <div style="text-align: center;">  <p>▲ Portrait</p> </div> <div style="text-align: center;">  <p>▲ Landscape</p> </div> </div>
<p>2 Layout Options</p>	<p>Layout Options allows you to select advanced printing options. For details, see page 81 ~ page 85.</p>

Paper Tab

Use the following options to set the paper handling needs when you access the printer properties. See [page 71](#) for more information about accessing printer properties. Click the Paper tab to access the paper properties.

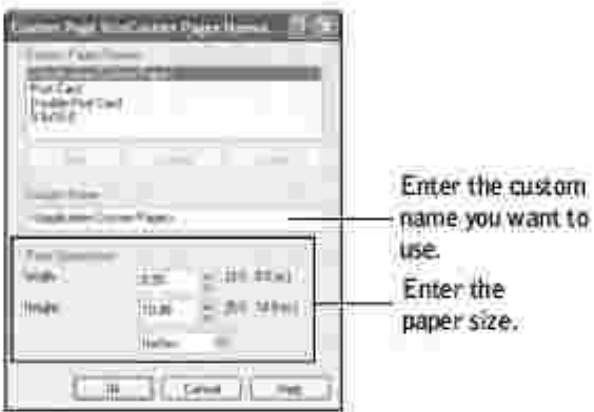

Property	Description
1 Copies	Copies allows you to choose the number of copies to be printed. You can enter up to 999.
2 Size	<p>The Size option allows you to choose the size of paper loaded in the paper tray.</p> <p><i>If the required size is not listed in the Size box, click Add Custom. When the Custom Page Size Custom Pages Names... window appears, set the paper size and click Ok. The setting appears on the list so that you can select it.</i></p> 
3 Source	<p>Make sure that Source is set to the corresponding paper tray.</p> <p>The Manual Feed source is used when printing to special materials. You need to load one sheet at a time into the manual feeder. See page 64.</p> <p>If the paper source is set to Auto Select, the multi-function printer automatically picks up print materials from the manual feeder first and then the paper tray.</p>
4 Type	<p>Make sure that Type is set to Printer Default. <i>If you load a different type of print material, select the corresponding paper type. For more information about print materials, refer to "Paper Handling" on page 47.</i></p> <p><i>If you are using cotton paper, set the paper type to Thick for the best results.</i></p> <p><i>If you are using recycled paper or color paper, select Color Paper.</i></p>
5 First Page	<p>This setting allows the first page of a print job to be taken from a different paper source.</p>

Graphics Tab

Use the following graphic options to adjust the print quality for your specific printing needs. See [page 71](#) for more information about accessing printer properties. Click the Graphics tab to display the properties shown below.



Property	Description
1 Resolution	You can select the printing resolution by choosing from 1200 Image Quality (Best), 600 dpi (Normal) or 300 dpi (Draft). The higher the setting, the sharper the clarity of printed characters and graphics. Higher settings may increase the time it takes to print a document.
2 Toner Save	Selecting this option extends the life of your toner cartridge and reduces your cost per page without a significant reduction in the print quality. <ul style="list-style-type: none"> • On: Select this option to allow the multi-function printer to use less toner on each page. • Off: When you do not need to save toner to print a document, select this option.
3 Image Mode	Selecting this option improves the print quality of your text and image, and makes the characters and images appear smoother. <ul style="list-style-type: none"> • Normal: Select to print images in the normal mode. • Text Enhance: Select to refine the print quality of characters by smoothing out jagged edges that can occur on the angles and curves of each character. • Image Enhance: Select to refine the print quality of photo images.
4 Advanced Options	You can set advanced settings by clicking the Advanced Options button. <div style="text-align: center;">  </div> <p>Darkness</p>

Use this option to lighten or darken the image appearance in your print.

- Normal: This setting is for normal documents.
- Lighter: This setting is for bolder line widths or darker gray scale images.
- Darker: This setting is for finer line width, higher definition in graphics and lighter gray scale images.

When the Darken Text option is checked, all text in your document is allowed to print darker than a normal document.

True Type Options

This option determines what the driver tells the multi-function printer about how to image the text in your document. Select the appropriate setting according to the status of your document.

- Download as Bit Image: When this option is selected, the driver downloads the font data as bitmap images. Documents with complicated fonts, such as Korean or Chinese, print faster in this setting.
- Print as Graphics: When this option is selected, the driver downloads any fonts as graphics. When printing documents with high graphic content and relatively few TrueType fonts, printing performance (speed) may be enhanced in this setting.

Print All Text Black

When the Print All Text Black option is checked, all text in your document is allowed to print solid black, regardless of the color it appears on the screen. When it is not checked, colored text is allowed to print in shades of gray.

Extras Tab

See [page 71](#) for more information about accessing printer properties. Click the Extras tab to access the following features:



Property	Description
1 Watermark	You can create a background image of text to print on each page of your document. See "Using Watermarks" on page 86 . This feature is not available when using the Postscript (PS) driver.
2 Overlay	Overlays are often used to take the place of preprinted forms and letterhead paper. See "Using Overlays" on page 89 .
3 Output Options	Print Order: You can set the sequence for the pages to print. Select the print order from the drop-down list. <ul style="list-style-type: none"> • Normal: Your multi-function printer prints all pages from the first page to the last page. • Reverse All Pages: Your multi-function printer prints all pages from the last page to the first page. • Print Odd Pages: Your multi-function printer prints only the odd pages of the document. • Print Even Pages: Your multi-function printer prints only the even pages of the document.

About Tab

Use the About tab to display the copyright notice and the version number of the driver. If you have an Internet browser, you can connect to the Internet by clicking the website icon. See [page 71](#) for more information about accessing the printer properties.

Using a Favorite Setting

The Favorites option, which is visible on each properties tab, allows you to save the current properties settings for future use.

To save a Favorites item:

1. Change the settings on each tab, as needed.
2. Enter a name for the item in the Favorites input box.

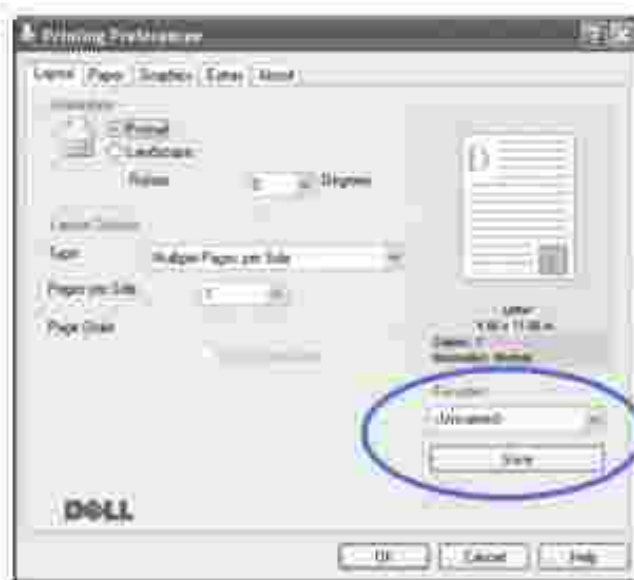

3. Click Save.

To use a saved setting, select it from the Favorites drop-down list.

To delete a favorite setting item, select it from the list and click Delete.

You can also restore the printer driver's default settings by selecting <Printer Default> from the list.

Using Help

Your multi-function printer has a help screen that can be activated by the Help button in the printer's properties window. These help screens give detailed information about the printer features provided by the printer driver.

You can also click  from the upper right hand corner, and then click on any setting.

Printing Multiple Pages on One Sheet of the Paper



You can select the number of pages to print on a single sheet of paper. To print more than one page per sheet, the pages will appear decreased in size and arranged on the sheet. You can print up to 16 pages on one sheet.

1. When you change the print settings from your software application, access the printer properties. See [page 71](#).
2. From the Layout tab, choose Multiple Pages per Side on the Type drop-down list.
3. Select the number of pages you want to print per sheet (1, 2, 4, 9, or 16) on the Pages per Side drop-down list.



4. *If necessary*, select the page order on the Page Order drop-down list.



Check Print Page Border to print a border around each page on the sheet. Print Page Border is enabled only if the Pages per Side setting is set to a number greater than one.

5. Click the Paper tab and select the paper source, size and type.
6. Click OK and print the document.

Printing a Reduced or Enlarged Document

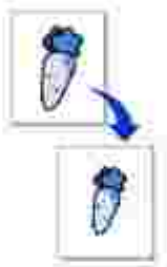

You can scale your print job on a page.

1. When you change the print settings from your software application, access the printer properties. See [page 71](#).
2. From the Layout tab, select Reduce/Enlarge on the Type drop-down list.
3. Enter the scaling rate in the Percentage input box.

You can also click the ▲ or ▼ button.

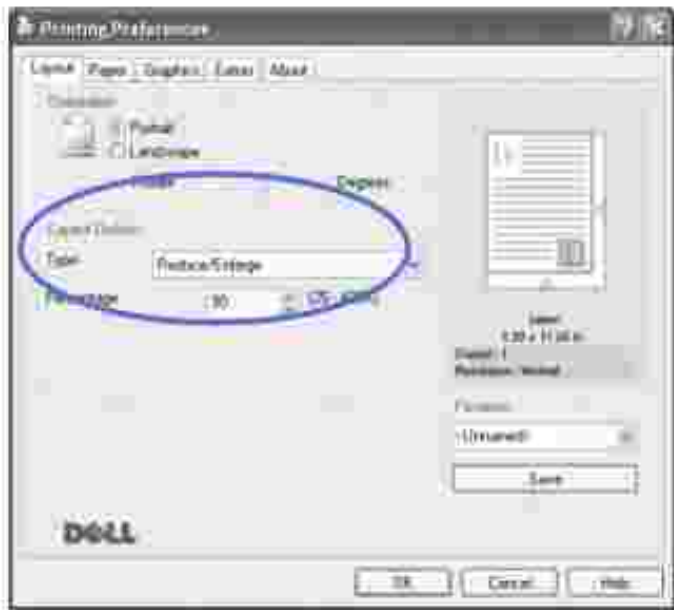

4. Click the Paper tab and select the paper source, size and type.
5. Click OK and print the document.

Fitting Your Document to a Selected Paper Size



You can scale your print job to any selected paper size regardless of the digital document size. This can be useful when you want to check fine details on a small document.

1. When you change the print settings from your software application, access the printer properties. See [page 71](#).
2. From the Layout tab, select Fit to Page on the Type drop-down list.
3. Select the correct size from the Target Page drop-down list.

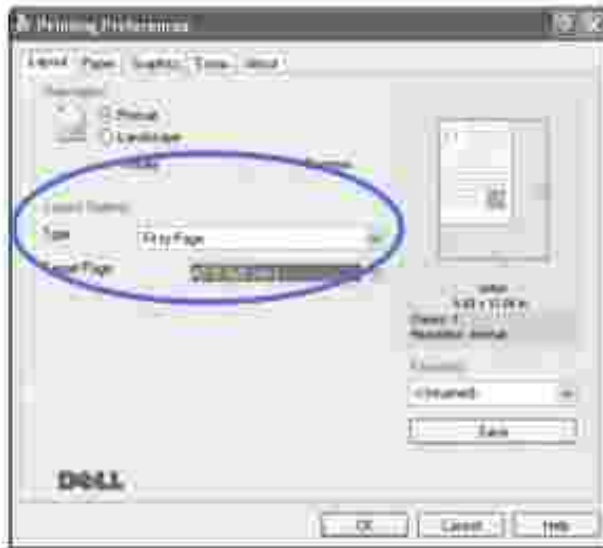

4. Click the Paper tab and select the paper source, size and type.
 5. Click OK and print the document.
-

Printing Posters



You can print a single-page document onto 4, 9, or 16 sheets of paper, for the purpose of pasting the sheets together to form one poster-size document.

1. When you change the print settings from your software application, access the printer properties. See [page 71](#).
2. From the Layout tab, select Poster on the Type drop-down list.

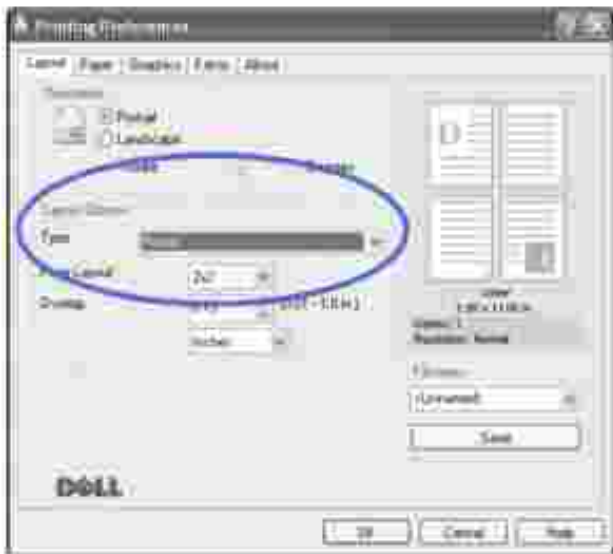

3. Configure the poster option:

You can select the page layout from 2x2, 3x3, or 4x4. If you select 2x2, the output will be automatically stretched to cover 4 physical pages.



Specify an overlap in millimeters or inches to make it easier to reconstruct the resulting poster.

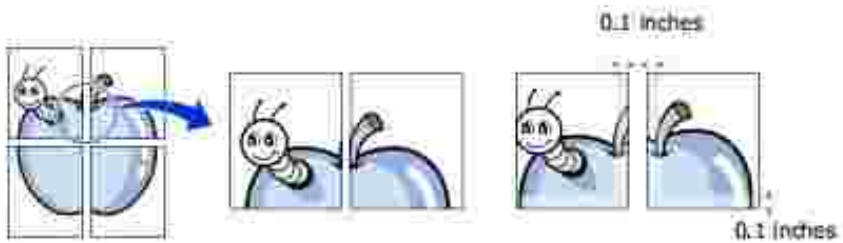

4. Click the Paper tab and select the paper source, size and type.
5. Click OK and print the document. You can complete the poster by reconstructing the results.

Printing Booklets

The Booklet printing feature allows you to print your document on both sides of the paper and arranges the pages so that the paper can be folded in half after printing to produce a booklet.

 **NOTE:** The booklet printing option is available when A4, Letter, Legal or Folio size is selected in the Size option on the Paper tab.

1. When you change the print settings from your software application, access the printer properties. See [page 71](#).
2. From the Layout tab, choose Booklet Printing from the Type drop-down list.

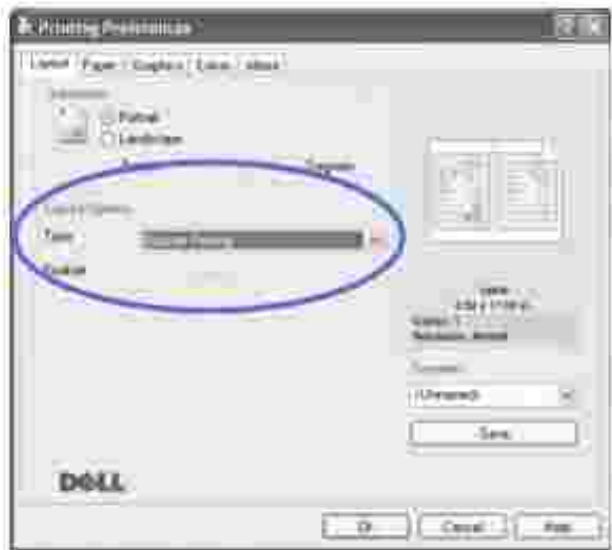

3. Click the Paper tab, and select the paper source, size and type.
4. Click OK and print the document.
5. After printing, fold and staple the pages.



Using Watermarks



3. Enter the text message you want to print in the Watermark Message box.

The message displays in the preview image window. The preview image is provided so that you can see how the watermark will appear on the printed page.

When the First Page Only box is checked, the watermark is printed on the first page only.

4. Select the watermark options.

You can select the font name, style and size and gray scale level from the Font Attributes section and set the angle of the watermark from the Message Angle section.

5. Click Add to add a new watermark to the list.
6. When you finish creating, click Ok and start printing.

To stop printing the watermark, select <No Watermark> on the Watermark drop-down list.

Editing a Watermark

1. When you change the print settings from your software application, access the printer properties. See [page 71](#).
2. Click the Extras tab and click Edit in the Watermark section. The Edit Watermarks window appears.
3. Select the watermark you want to edit on the Current Watermarks list, and change the watermark message and the options.
4. Click Update to save the changes.
5. Click Ok.

Deleting a Watermark

1. When you change the print settings from your software application, access the printer properties. See [page 71](#).
 2. From the Extras tab, click Edit in the Watermark section. The Edit Watermarks window appears.
 3. Select the watermark you want to delete on the Current Watermarks list and click Delete.
 4. When a confirming message window appears, click Yes.
 5. Click Ok.
-

Using Overlays



What is an Overlay?

An overlay is text and/or images stored in the computer hard disk drive (HDD) as a special file format that can be printed on any document. Overlays are often used to take the place of preprinted forms and letterhead paper. Rather than using preprinted letterhead, you can create an overlay containing the exact same information that is currently on your letterhead. To print a letter with your company's letterhead, you do not need to load preprinted letterhead paper in the multi-function printer. You need only tell the multi-function printer to print the letterhead overlay on your document.



Creating a New Page Overlay

To use a page overlay, you must create a new page overlay containing your logo or image.

 **NOTE:** The overlay document size must be the same as documents you will print with the overlay. Do not create an overlay with a watermark.

1. Create or open a document containing text or an image for use in a new page overlay. Position the items exactly as you wish them to appear when printed as an overlay. *If needed*, save the file for later use.
2. When you change the print settings from your software application, access the printer properties. See [page 71](#).
3. Click the Extras tab and click Edit in the Overlay section.



4. In the Edit Overlays window, click Create Overlay.

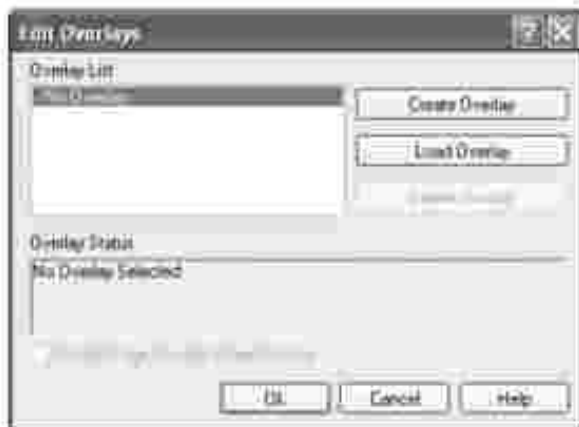

5. In the Create Overlay window, type a name of up to eight characters in the File name box. Select the destination path, if necessary. (The default is C:\Formover).

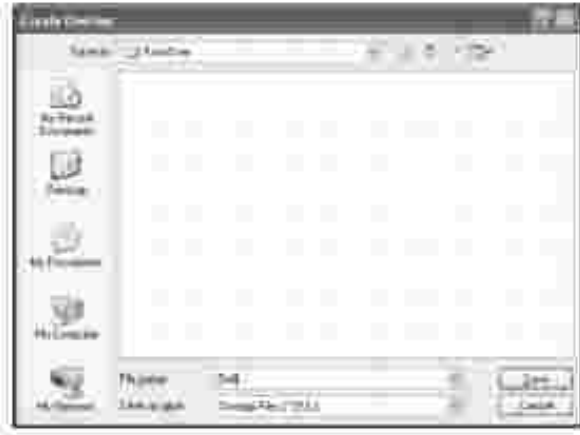

6. Click Save. You can see the name in the Overlay List.
7. Click OK or Yes until you complete creating.

The file is not printed out; it is stored in your computer.

Using a Page Overlay

After an overlay has been created, it is ready to be printed with your document. To print an overlay with a document:

 **NOTE:** The resolution of the overlay must be the same as the resolution of the document that will print with the overlay.

1. Create or open the document you want to print.
2. When you change the print settings from your software application, access the printer properties. See [page 71](#).
3. Click the Extras tab.
4. Select the overlay you want to print from the Overlay drop-down list box.
5. If the overlay file doesn't appear on the Overlay List, click Edit and then Load Overlay, and select the overlay file.



If you have stored the overlay file you want to use on an external source, such as a CD or floppy disk, you can also load the file when you access this Load Overlay window.

After you select the file, click Open. The file is now shown in the Overlay List box and is available for printing. Select the overlay from the Overlay List box.

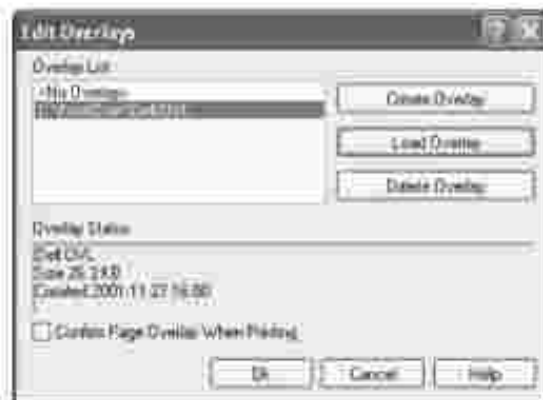

6. If necessary, click Confirm Page Overlay When Printing. When this box is checked, a message window appears each time you submit a document for printing, asking you to confirm that you want to print an overlay on your document.

Answering Yes to the window means that the selected overlay will be printed with your document. Answering No to the window cancels the use of the overlay page.

If this box is empty and an overlay has been selected, the overlay will be automatically printed with your document.

7. Click OK or Yes until the printing starts.

The overlay is downloaded with your print job and printed on your document.

Deleting a Page Overlay

You can delete page overlays that are no longer used.

1. In the printer properties window, click the Extras tab.
2. Click Edit in the Overlay section.
3. Select the overlay you want to delete from the Overlay List box.
4. Click Delete Overlay.
5. When a confirming message window appears, click Yes.
6. Click OK until you exit the Print window.

Copying

- [Loading Paper for Copying](#)
 - [Preparing a Document](#)
 - [Making Copies From the ADF](#)
 - [Using Special Copy Features](#)
 - [Setting the Time Out Option](#)
 - [Selecting Paper Tray](#)
 - [Making Copies From the Scanner Glass](#)
 - [Setting Copy Options](#)
 - [Changing the Default Settings](#)
-

Loading Paper for Copying

The instructions for loading print materials are the same whether you are printing, faxing, or copying. For further details, see [page 25](#) for loading paper in the paper tray and [page 64](#) for loading paper in the manual feeder.

Selecting Paper Tray

After loading the print media for copy output, you have to select the paper tray you will use for the copy job.

1. Press <Menu> on the operator panel until "Copy Setup" appears on the top line of the display.
2. Press the scroll button (◀ or ▶) to display "Select Tray" on the bottom line.
3. Press <Select> to access the menu item.
4. Press the scroll button (◀ or ▶) until the paper tray you want appears on the display.

You can select from Tray1, Tray2(option) and Manual Feeder. If you do not install the optional Tray 2, the Tray2(option) menu item will not appear on the display.

5. Press <Select> to save the selection.
 6. To return to Standby mode, press <Return>.
-

Preparing a Document

You can use the scanner glass or the Automatic Document Feeder (ADF) to load an original document for copying, scanning and sending a fax. Using the ADF, you can load up to 50 sheets of 75 g/m² (20 lb)

documents for one job. Using the scanner glass, you can load one sheet at a time.

 **NOTE:** To get the best scan quality, especially for color or gray scale images, use the scanner glass instead of the ADF.

When you use the ADF:

- Do not load documents smaller than 5.59 by 5.83 in. (142 by 148 mm) or larger than 8.5 by 14 in. (216 by 356 mm).
- Do not attempt to feed the following types of documents:
 - Carbon-paper or carbon-backed paper
 - Coated paper
 - Onion skin or thin paper
 - Wrinkled or creased paper
 - Curled or rolled paper
 - Torn paper
- Remove all staples and paper clips before loading documents.
- Make sure any glue, ink or correction fluid on the paper is completely dry before loading documents.
- Do not load documents containing different sizes or weights of paper.
- Do not load booklets, pamphlets, transparencies or documents having other unusual characteristics.

Making Copies From the Scanner Glass

 **NOTE:** A computer connection is not required for copying.

 **NOTE:** Remove any documents from the ADF before copying from the scanner glass.

 **NOTE:** Contaminants on the scanner glass may cause black spots on the printout. For best results, clean the scanner glass before use. See [page 154](#).

To make a copy from the scanner glass:

1. Lift and open the document cover.



2. Place the document face down on the scanner glass and align it with the registration guide on the top left corner of the glass.



3. Close the document cover.



NOTE: Leaving the cover open while copying may affect the copy quality and toner consumption.



NOTE: *If you are copying a page from a book or magazine, lift the cover until its hinges are caught by the stopper and then close the cover. If the book or magazine is thicker than 30 mm, start copying with the cover open.*

4. Customize the copy settings including the number of copies, copy size, the contrast, and the image quality by using the operator panel buttons. See ["Setting Copy Options" on page 98](#).

To clear the settings, use the <Cancel> button.

5. *If necessary*, you can use special copy features, such as Auto Fit, Clone, Poster, and Two Sided copying referring to [page 100](#).
6. Press <Start Copy> to begin copying. The display shows the copy processing.

NOTE: You can cancel the copy job at any time. Press <Cancel>, and the copying will stop.

Making Copies From the ADF

 **NOTICE:** Do not load more than 50 sheets into the ADF or allow more than 50 sheets to be fed to the ADF output tray. The ADF output tray should be emptied before it exceeds 50 sheets or your original documents may be damaged.

 **NOTE:** A computer connection is not required for copying.

1. Load up to 50 pages of 75 g/m² (20 lb) documents face up on the ADF with top edge of the documents in first. Then adjust the document guides to the correct document size.

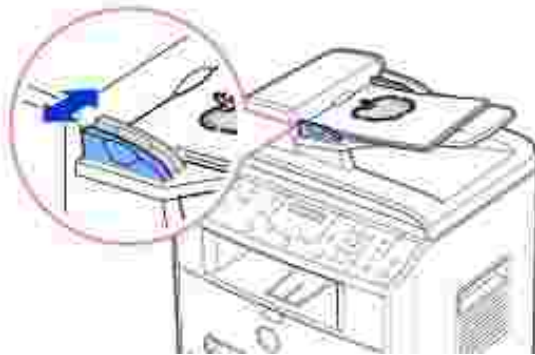

2. Make sure that the bottom of the document stack matches the document size marked on the document input tray.

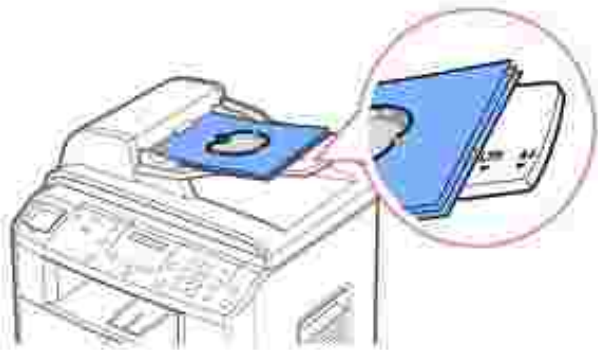

3. Customize the copy settings including the number of copies, copy size, contrast, and image quality by using the operator panel buttons. See ["Setting Copy Options" on page 98](#).

To clear the settings, use the <Cancel> button.

4. *If necessary*, you can use special copy features, such as Collation and 2 Up, or 4 Up copying referring to [page 100](#).
 5. Press <Start Copy> to begin copying. The display shows the copy processing.
-

Setting Copy Options

The buttons on the operator panel let you customize all the basic copy options; contrast, image quality, copy size and number of copies. Set the following options for the current copy job before pressing <Start Copy> to make copies.

 **NOTE:** If you press <Cancel> while you set the copy options, all of the options you have set for the current copy job will be canceled and return to their default status. Or, they automatically return to their default status after copying.

Contrast

Adjust the contrast to make the copy lighter or darker than the original.

To adjust the contrast, press <Contrast>.

Each time you press the button, the LED labeled with the selected mode turns on.

You can choose from the following contrast modes:

- Darker: works well with light print or faint pencil markings.
- Normal: works well with standard typed or printed documents.
- Lighter: works well with dark print.

Quality

The Quality setting is used to improve the image quality by selecting the document type for the current copy job.

To select the image quality, press <Quality>.

Each time you press the button, the LED labeled with the selected mode turns on.

You can choose from the following the image quality modes:

- Text: Use for documents with fine details, such as fine text.
- Text & Photo: Use for documents with both text and photo/gray tones.
- Photo: Use for documents with photo or gray tones.

Reduced/Enlarged Copy

Using the <Reduce/Enlarge> (▲ or ▼) button, you can reduce or enlarge the size of a copied image, from 25 percent to 400 percent when you copy original documents from the scanner glass or from 25 percent to 100 percent from the ADF. Note that the zoom rate available is different depending on the document loading method.

 **NOTE:** When you make a reduced copy, black lines may appear at the bottom of your copy.

To select from the predefined copy sizes:

1. Press <Reduce/Enlarge> (▲ or ▼).

The default setting appears on the bottom line of the display.

2. Press <Reduce/Enlarge> (▲ or ▼) to find the size setting you want.
3. Press <Select> to save the selection.

To fine-tune the size of copies:

1. Press <Reduce/Enlarge> (▲ or ▼).
2. Press <Reduce/Enlarge> (▲ or ▼) until "Custom:25-100% (from the ADF)," or "Custom:25-400%" (from the scanner glass) displays on the bottom line. Press <Select>.
3. Press <Reduce/Enlarge> (▲ or ▼) until the copy size you want appears on the display.

Pressing and holding the button allows you to quickly scroll to the number you want.

You can also enter the value using the number keypad.

4. Press <Select> to save the selection.

Number of Copies

Using the <Number of Copies> (▲ or ▼) button, you can select the number of copies from 1 to 99.

1. Press <Number of Copies> (▲ or ▼).

2. Press <Number of Copies> (▲ or ▼) until the number you want appears on the display.

Pressing and holding the button allows you to quickly scroll to the number you want.

You can also enter the value using the number keypad.

3. Press <Select> to save the selection.

Using Special Copy Features

 **NOTE:** Some features may not be available depending on where you loaded the document, on the scanner glass or in the Automatic Document Feeder.

You can use the following copy features using the <Layout> button on the operator panel:

- Auto Fit: Automatically reduces or enlarges the original image to fit on the paper currently loaded in the multi-function printer. See [page 100](#).
- Clone: Prints multiple image copies from the original document on a single page. The number of images is automatically determined by the original image and paper size. See [page 101](#).
- Collation: Sorts the copy job. For example, if you make 2 copies of 3 page documents, one complete 3 page document will print followed by the second complete document. See [page 101](#).
- 2 Sided: Prints a 2-sided original document onto one sheet of paper. See [page 102](#).
- 2 Up: Prints 2 original images to fit onto one sheet of paper. See [page 103](#).
- 4 Up: Prints 4 original images to fit onto one sheet of paper. See [page 103](#).
- Poster: Prints an image onto 9 sheets of paper (3 by 3). You can paste the printed pages together to make one poster-size document. See [page 103](#).
- Off: Prints in normal mode.

Auto Fit Copying



This special copy mode can be applied when you load a document using only the scanner glass. If a

document is detected in the ADF, the Auto Fit does not work.

 **NOTE:** You cannot adjust the copy size using the <Reduce/Enlarge> (▼ or ▲) button while the Auto Fit copying is enabled.

To make the Auto Fit copying:

1. Load the document to be copied on the scanner glass, and close the document cover.
2. Press <Layout>.
3. Press <Layout> or the scroll button (◀ or ▶) until "Auto Fit" displays on the bottom line.
4. Press <Select> to save the selection.
5. *If necessary*, customize the copy settings including the number of copies, contrast, and image quality by using the operator panel buttons. See ["Setting Copy Options" on page 98](#).
6. Press <Start Copy> to begin copying.

Clone Copying

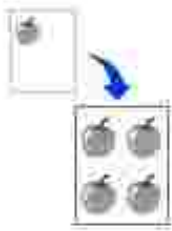

This special copy mode can be applied when you load a document using only the scanner glass. If a document is detected on the ADF, the Clone copying feature does not work.

 **NOTE:** You cannot adjust the copy size using the <Reduce/Enlarge> (▼ or ▲) button while making a clone copy.

To make the Clone copying:

1. Load the document to be copied on the scanner glass, and close the cover.
2. Press <Layout>.
3. Press <Layout> or the scroll button (◀ or ▶) until "Clone" displays on the bottom line.
4. Press <Select> to save the selection.
5. *If necessary*, customize the copy settings including number of copies, contrast, and image quality by using the operator panel buttons. See ["Setting Copy Options" on page 98](#).
6. Press <Start Copy> to begin copying.

Collation Copying

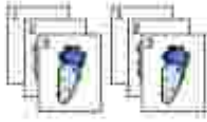

The Collation copying feature is available only when you load documents in the ADF.

1. Load the documents to be copied in the ADF.
2. Press <Layout>.
3. Press <Layout> or the scroll button (◀ or ▶) until "Collation" displays on the bottom line.
4. Press <Select> to save the selection.
5. *If necessary*, customize the copy settings including the number of copies, copy size, contrast, and image quality by using the operator panel buttons. See ["Setting Copy Options" on page 98](#).
6. Press <Start Copy> to begin copying.

Two-Side Copying



When you copy using this feature, the multi-function printer prints one side on the upper half of the paper and the other side on the lower half without reducing the original. This feature is helpful for copying a small-sized document, such as a name card.

If the original document is larger than the printable area, some portions may not be printed.

This special copy mode can be applied when you load a document using only the scanner glass. If a document is detected in the ADF, the Two Sided copying feature does not work.

 **NOTE:** You cannot adjust the copy size using the <Reduce/Enlarge> (▼ or ▲) button for Two Sided copying.

To make the Two Sided copying:

1. Load the document to be copied on the scanner glass, and close the cover.
2. Press <Layout>.
3. Press <Layout> or the scroll button (◀ or ▶) until "2 Sided" displays on the bottom line.
4. Press <Select> to save the selection.
5. *If necessary*, customize the copy settings including the number of copies, copy size, contrast, and image quality by using the operator panel buttons. See ["Setting Copy Options" on page 98](#).
6. Press <Start Copy> to begin copying.

Your multi-function printer begins scanning the front side.

7. When "Set Backside" displays on the bottom line, open the document cover and flip the document over with the second side facing down. Close the document cover.



NOTE: If you press the <Cancel> button or if no buttons are pressed for about 30 seconds, the multi-function printer cancels the copy job and returns to Standby mode.

8. Press <Start Copy> again.

2-up or 4-up Copying



The 2 or 4-up copying feature is available only when you load documents in the ADF.

 **NOTE:** You cannot adjust the copy size using the <Reduce/Enlarge> (▼ or ▲) button for making a 2 or 4-up copy.

 **NOTE:** 2-up copy reduces your original document by 50 percent. 4-up copy reduces the document by the following rates depending on the paper loaded: 76 percent for Letter, 81 percent for A4 and 95 percent for Legal.

To make the 2 or 4-up copying:

1. Load the documents to be copied in the ADF.
2. Press <Layout>.
3. Press <Layout> or the scroll button (◀ or ▶) until "2 Up" or "4 Up" displays on the bottom line.
4. Press <Select> to save the selection.
5. *If necessary*, customize the copy settings including the number of copies, contrast, and image quality by using the operator panel buttons. See ["Setting Copy Options" on page 98](#).
6. Press <Start Copy> to begin copying.

Poster Copying



This special copy mode can be applied when you load a document using only the scanner glass. If a document is detected in the ADF, the Poster copying feature does not work.

 **NOTE:** You cannot adjust the copy size using the <Reduce/Enlarge> button for making a poster.

To make the Poster copying:

1. Load the documents to be copied on the scanner glass and close the cover.
2. Press <Layout>.
3. Press <Layout> or the scroll button (◀ or ▶) until "Poster" displays on the bottom line.
4. Press <Select> to save the selection.
5. *If necessary*, customize the copy settings including the number of copies, contrast, and image quality by using the operator panel buttons. See ["Setting Copy Options" on page 98](#).

6. Press <Start Copy> to begin copying.

Your original document is divided into 9 portions. Each portion is scanned and printed one by one in the following order:

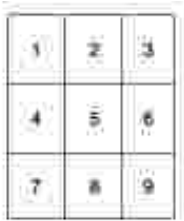

Changing the Default Settings

The copy options, including contrast, image quality, copy size, and the number of copies, can be set to the most frequently used modes. When you copy a document, the default settings are used unless they are changed by using the corresponding buttons on the operator panel.

 **NOTE:** While you set copy options, pressing <Cancel> cancels the changed settings and returns to the default status.

To create your own default settings:

1. Press <Menu> on the operator panel until "Copy Setup" appears on the top line of the display.

The first menu item, "Default-Change", appears on the bottom line.

2. Press <Select> to access the menu item. The first setup option, "Contrast" appears on the bottom line.
3. Press the scroll button (◀ or ▶) to scroll through the setup options.
4. When the option you want to set appears, press <Select> to access the option.
5. Change the setting using the scroll button (◀ or ▶) or enter the value using the number keypad.
6. Press <Select> to save the selection.
7. Repeat steps 3 through 6, as needed.
8. To return to Standby mode, press <Return>.

Setting the Time Out Option

You can set the time the multi-function printer waits before it restores the default copy settings, if you do not start copying after changing them on the operator panel.

1. Press <Menu> on the operator panel until "Copy Setup" appears on the top line of the display.
2. Press the scroll button (◀ or ▶) to display "Timeout" on the bottom line.
3. Press <Select> to access the menu item.
4. Press the scroll button (◀ or ▶) until the timeout value you want appears on the display.

You can select from 15, 30, 60 and 180 (seconds). Selecting "Off" means that the multi-function printer does not restore the default settings until you press <Start Copy> to begin copying, or <Cancel> to cancel.

5. Press <Select> to save the selection.
6. To return to Standby mode, press <Return>.

Scanning

- [Scanning Overview](#)
- [Scanning From Operator Panel](#)
- [Scanning Using the Windows Image Acquisition \(WIA\) Driver](#)

Scanning Overview

Use your Dell Laser Multi-Function Printer 1600n to turn pictures and text into editable images on your computer. After you install the software from the *Drivers and Utilities* CD, you can start scanning images using either the operator panel or applications such as Dell ScanCenter™, PaperPort® and Adobe® PhotoShop®.

PaperPort is the scanning program provided with your multi-function printer. If you prefer to use another application, such as Adobe PhotoShop, you must assign the application to the multi-function printer by selecting it from the list of available applications via the <Select Software> button each time you start scanning. If you do not assign an application to the <Select Software> button, PaperPort is automatically selected when you start scanning. Please refer to ["Printer Settings Utility" on page 44](#).

Dell ScanCenter is a PaperPort application that enables you to scan items and send them directly to PaperPort or other programs on your computer without first running PaperPort. Dell ScanCenter runs as a separate application from the Windows Start Menu and displays the Dell ScanCenter bar. For more information about using Dell ScanCenter, refer to PaperPort's Help menu.



Icons on the Dell ScanCenter bar represent the programs that are limited to PaperPort and to Dell ScanCenter. To scan and send an item to a program, click the program icon and then scan the item. Dell ScanCenter automatically starts the selected program when the scan is complete.

Scanning From Operator Panel

1. Load the document(s) face up with top edge in first into the ADF.

OR

Place a single document face down on the scanner glass.

For details about loading a document, see [page 120](#).

2. If necessary, press <Select Software> and select an application to which you want to send the scanned image.
3. Press <Start Scan>. The selected application window opens. Adjust the scan settings and start scan. For details, please refer to the user's guide of the application.

Scanning Using the Windows Image Acquisition (WIA) Driver

Your multi-function printer also supports the WIA driver for scanning images. WIA is one of the standard components provided by Microsoft® Windows® XP and works with digital cameras and scanners. Unlike the TWAIN driver, the WIA driver allows you to scan an image and easily manipulate those images without using additional software.



NOTE: The WIA driver works only on Windows XP.

1. Load the document(s) face up with top edge in first into the ADF.

OR

Place a single document face down on the scanner glass.

For details about loading a document, see [page 120](#).

2. Click Start ⇒ Control Panel ⇒ Printers and Other Hardware ⇒ Scanners and Cameras.
3. Double click the printer icon. The Scanners and Camera Wizard launches.
4. Choose your scanning preferences and click Preview to see how your preferences affect the picture.

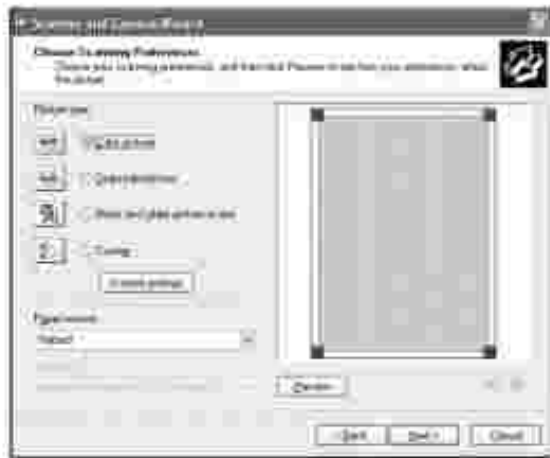

5. Enter a picture name, and select a file format and destination to save the picture.
6. Follow the on-screen instructions to edit the picture after it is copied to your computer.

Faxing

- [Setting the Machine ID](#)
 - [Using the Number Keypad to Enter Characters](#)
 - [Setting the Time and Date](#)
 - [Changing the Clock Mode](#)
 - [Setting Sounds](#)
 - [Toll Save Mode](#)
 - [Setting up the Fax System](#)
 - [Sending a Fax](#)
 - [Receiving a Fax](#)
 - [Automatic Dialing](#)
 - [Other Ways to Fax](#)
 - [Additional Features](#)
-

Setting the Machine I D

In most countries, you are required by law to indicate your fax number on any fax you send. The Machine ID, containing your telephone number and name or company name, will be printed at the top of each page sent from your multi-function printer.

1. Press <Menu> until "Printer Setup" appears on the top line of the display. The first available menu item, "Machine ID" displays on the bottom line.
2. Press <Select>. The display asks you to enter the fax number.
3. If there is a number already set, the number appears.
4. Enter your fax number using the number keypad.



NOTE: *If you make a mistake while entering numbers,* press the left scroll (◀) button to delete the last digit.

5. Press <Select> when the number on the display is correct. The display asks you to enter the ID.
6. Enter your name or company name using the number keypad.
7. You can enter alphanumeric characters using the number keypad, including special symbols by pressing the 0 button.

For details on how to use the number keypad to enter alphanumeric characters, see [page 113](#).

8. Press <Select> when the name on the display is correct.
 9. Press <Return> to return to Standby mode.
-

Using the Number Keypad to Enter Characters

As you perform various tasks, you may need to enter names and numbers. For example, when you set up your multi-function printer, you enter your name or your company's name and telephone number. When you store one, two or three digit speed dial or group dial numbers, you may also need to enter the corresponding names.



- When prompted to enter a letter, press the appropriate button until the correct letter appears on the display.

For example, to enter the letter O, press 6.

- Each time you press 6, the display shows a different letter, M, N, O and finally 6.
- To enter additional letters, repeat the first step.
- Press 1 to enter a space, or press 0 to enter special characters.
- Press <Select> when you are finished.

Keypad Letters and Numbers

Key	Assigned numbers, letters or characters
1	1 Space
2	A B C 2
3	D E F 3
4	G H I 4
5	J K L 5
6	M N O 6
7	P Q R S 7
8	T U V 8
9	W X Y Z 9
0	+ - , . ` / * # & 0

Changing Numbers or Names

If you make a mistake while entering a number or name, press the left (◀) button to delete the last digit or character. Then enter the correct number or character.

Inserting a Pause

For some telephone systems, it is necessary to dial an access code and listen for a second dial tone. A pause must be entered in order for the access code to function. For example, enter the access code 9 and then press <Redial/Pause> before entering the telephone number. A "-" appears on the display to indicate when a pause is entered.

Setting the Time and Date

The time and date are printed on all faxes.

 **NOTE:** It may be necessary to reset the correct time and date *if loss of power to the multi-function printer occurs.*

To set the time and date:

1. Press <Menu> until "Printer Setup" appears on the top line of the display.
2. Press the scroll button (◀ or ▶) to display "Date & Time" on the bottom line and press <Select>.
3. Enter the correct time and date using the number keypad.

Day = 01 ~ 31

Month = 01 ~ 12

Year = 1990 ~ 2089

Hour = 01 ~ 12 (12-hour mode)

00 ~ 23 (24-hour mode)

Minute = 00 ~ 59

You can also use the scroll button (◀ or ▶) to move the cursor under the digit you want to correct and enter a new number.

4. To select "AM" or "PM" for 12-hour format, press the * or the # button.

When the cursor is not under the AM or PM indicator, pressing the * or the # button immediately moves the cursor to the indicator.

You can change the clock mode to 24-hour format (e.g. 01:00 PM as 13:00). For details, see [page 115](#).

5. Press <Select> when the time and date on the display is correct.

 **NOTE:** The multi-function printer beeps and does not allow you to proceed to the next step if a wrong number is entered.

Changing the Clock Mode

You can set your multi-function printer to display the current time using either the 12-hour or the 24-hour format.

1. Press <Menu> until "Printer Setup" appears on the top line of the display.
2. Press the scroll button (◀ or ▶) until you see "Clock Mode" on the bottom line and press <Select>.

The multi-function printer displays the Clock mode that is currently set.

3. Press the scroll button (◀ or ▶) to select the other mode and then press <Select> to save the selection.
 4. To return to Standby mode, press <Return>.
-

Setting Sounds

Speaker, Ringer, Key Sounds and Alarm Sounds

1. Press <Menu> until "Sound/Volume" appears on the top line of the display.
2. Press the scroll button (◀ or ▶) to scroll through the options. Press <Select> when you see the sound option you want.
3. Press the scroll button (◀ or ▶) to display the status or loudness you want for the option you have selected.

For the ringer volume, you can select from "Off", "Low", "Med" and "High". Setting "Off" means that the ringer turns off. The multi-function printer works normally even if the ringer is turned off.

4. Press <Select> to save the selection.
5. *If necessary*, repeat steps 2 through 4.
6. To return to Standby mode, press <Return>.

Speaker Volume



NOTE: You can adjust the speaker volume only when the telephone line is connected.

1. Press <On Hook Dial>. A dial tone sounds from the speaker.
 2. Press the scroll button (◀ or ▶) until you hear the loudness you want. The display shows the current volume level.
 3. Press <On Hook Dial> to save the change and return to Standby mode.
-

Toll Save Mode

The Toll Save mode can be used to save scanned documents for transmission at a specified time in order to take advantage of lower long distance rates.

To turn the Toll Save mode on:

1. Press <Menu> until "Advanced Fax" appears on the top line of the display.
2. Press the scroll button (◀ or ▶) until you see "Toll Save" on the bottom line and press <Select>.
3. Press the scroll button (◀ or ▶) until "On" displays on the bottom line and press <Select>.
4. Press <Select> when "Start Time" displays on the bottom line.
5. Enter the time and date when your multi-function printer starts sending toll save faxes, using the number keypad.

To select "AM" or "PM" for 12-hour format, press the * or the # button.

6. Press <Select> when the starting time on the display is correct.
7. Press the scroll button (◀ or ▶) to display "End Time" and press <Select>.
8. Enter the time and date when the toll save transmission ends, using the number keypad.
9. Press <Select> to save the setting.
10. To return to Standby mode, press <Return>.

Once Toll Save mode is activated, your multi-function printer stores all of the documents to be faxed into its memory and sends them at the programmed time.

To turn Toll Save mode off, follow steps 1 and 2 above and then press the scroll button (◀ or ▶) until "Off" displays at the bottom line and press <Select>.

Setting up the Fax System

Changing the Fax Setup Options

1. Press <Menu> until "Fax Setup" appears on the top line of the display.

The first available menu item, "Receive Mode" displays on the bottom line.

2. Press the scroll button (◀ or ▶) until you see the desired menu item on the bottom line and press <Select>.
3. Use the scroll button (◀ or ▶) to find the status or use the number keypad to enter the value for the option you have selected.
4. Press <Select> to save the selection.
5. *If necessary*, repeat steps 2 through 4.
6. To return to Standby mode, press <Return>.

Available Fax Setup Options

You can use the following setup options for configuring the fax system:

Option	Description
Receive Mode	<p>You can select the default fax receiving mode.</p> <ul style="list-style-type: none">• Fax mode (automatic receive mode): The multi-function printer answers an incoming call and automatically goes into receive mode. The number of rings before the multi-function printer answers can be set in the Ring To Answer option. See page 118 for instructions. If the user memory is full, the multi-function printer is changed to Tel mode.• Tel mode (manual receive mode): Automatic fax reception is turned off. You can receive a fax by picking up the handset of the extension phone and then pressing the remote receive code (see page 119), or by pressing <On Hook Dial> (you can hear voice or fax tones from the remote machine) and then <Send Fax> on the operator panel.• Ans/Fax mode: The multi-function printer can share one telephone line with an answering machine. In this mode, the multifunction printer will monitor the fax signal and pick up the line if there are fax tones. If the phone communication in your country is serial, this mode is not available.• DRPD mode: Before using the Distinctive Ring Pattern Detection (DRPD) option, distinctive ring service must be installed on your telephone line by the telephone company. After the telephone company has provided a separate number for faxing with a distinctive ring pattern, configure the fax setup to monitor for that specific ring pattern .
Ring To Answer	<p>You can specify the number of times the multi-function printer rings, 1-7, before answering an incoming call.</p>

Contrast	<p>You can select the default contrast mode to fax your documents lighter or darker.</p> <ul style="list-style-type: none"> • Lighter works well with dark print. • Normal works well with standard typed or printed documents. • Darker works well with light print or faint pencil markings.
Redial Term	Your multi-function printer can automatically redial a remote fax machine if it was busy. Intervals from 1-15 minutes can be entered.
Redials	You can specify the number of redial attempts, 0-13. If you enter 0, the multi-function printer will not redial.
MSG Confirm	You can set your multi-function printer to print a report showing whether the transmission was successful, how many pages were sent, and more. The available options are On, Off and On-Error, which prints only when a transmission is not successful.
Auto Report	A report with detailed information about the previous 50 communications operations, including time and dates. The available options are On or Off.
Auto Reduction	<p>When receiving a document as long as or longer than the paper loaded in the paper tray, the multi-function printer can reduce the size of the document to fit the size of paper loaded in the multi-function printer. Select On if you want to automatically reduce the incoming document.</p> <p>With this feature set to Off, the multi-function printer cannot reduce the document to fit onto one page. The document is divided and printed in actual size on two or more pages.</p>
Discard Size	<p>When receiving a document as long as or longer than the paper installed in your multi-function printer, you can set the multi-function printer to discard any excess at the bottom of the page. If the received page is outside the margin you set, it will print on two sheets of paper at the actual size.</p> <p>When the document is within the margin and the Auto Reduction feature is turned on, the multi-function printer reduces the document to fit it onto the appropriate sized paper and discard does not occur. If the Auto Reduction feature is turned off or fails, the data within the margin will be discarded. Settings range from 0-30 mm.</p>
Receive Code	The Receive Code allows you to initiate fax reception from an extension phone plugged into the Phone connector (☎) on the back of the multi-function printer. <i>If you pick up the extension phone and hear fax tones</i> , enter the Receive Code. The Receive Code is preset to *9* at the factory. Settings range from 0-9. See page 126 for more information about using the code.
DRPD Mode	You can receive a call using the Distinctive Ring Pattern Detection (DRPD) feature which enables a user to use a single telephone line to answer several different telephone numbers. In this menu, you can set the multi-function printer to recognize the ring patterns to answer. For details about this feature, see page 127 .

Sending a Fax

Loading an Original Document

You can use the Automatic Document Feeder (ADF) or the scanner glass to load an original document for

faxing. Using the ADF, you can load up to 50 sheets of 75 g/m² (20 lb) paper at a time. Using the scanner glass, you can load one sheet at a time.

 **NOTE:** Make sure that no document is in the ADF. If any document is detected in the ADF, it has priority over the document on the scanner glass.

 **NOTE:** To get the best scan quality, especially for color or gray scale images, use the scanner glass instead of the ADF.

To fax a document using the Automatic Document Feeder (ADF):

1. Place the document(s) face up on the ADF with the top edge of the documents in first. Then adjust the document guides to the correct document size.



2. Make sure that the bottom of the document stack matches the paper size marked on the document input tray.

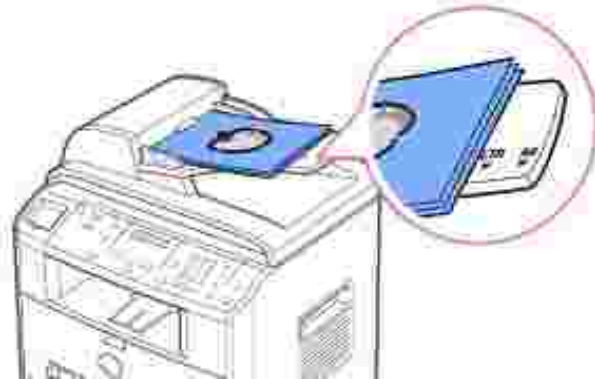

For detailed guidelines for preparing an original document, see [page 94](#).

3. Adjust the document resolution, referring to [page 122](#).

To fax a document from the scanner glass:

1. Open the document cover.



2. Place the document *face down* on the scanner glass and align it with the registration guide on the top left corner of the glass.



For detailed guidelines for preparing an original document, see [page 94](#).

3. Adjust the document resolution, referring to [page 122](#).
4. Close the document cover.



NOTE: *If you are copying a page from a book or magazine, lift the cover until its hinges are caught by the stopper and then close the cover. If the book or magazine is thicker than 30 mm, start copying with the cover open.*

Adjusting the Document Resolution

Use the Document Resolution setting to improve the output quality of the original or if scanning photographic materials.

1. Press <Resolution>.
2. By pressing <Resolution> or the scroll button (◀ or ▶), you can choose from Standard, Fine, Super Fine, Photo and Color.
3. When the mode you want to use displays, press <Select> to save the selection.

The document types recommended for the resolution settings are described in the table below.

Mode	Recommended for:
Standard	Documents with normal sized characters.
Fine	Documents containing small characters or thin lines or documents printed using a dot-matrix printer.
Super Fine	Documents containing extremely fine detail. The super fine mode is enabled only if the remote printer also supports the Super Fine resolution. See the notes below.
Photo	Documents containing shades of gray or photographs.
Color	Documents with colors. Sending a color fax is enabled only if the remote printer supports color fax reception and you send the fax manually. In this mode, the memory transmission is not available. When you select "Color", and then "USE ON HOOK DIAL FOR COLOR FAX" displays for 5 seconds, press <On Hook Dial>.

 **NOTE:** Faxes scanned in Super Fine resolution will transmit at the highest resolution supported by the receiving device.

Sending a Fax Automatically

1. Load the document(s) face up with top edge in first into the ADF.

OR

Place a single document face down on the scanner glass.

For details about loading a document, see [page 120](#).

2. Adjust the document resolution to suit your fax needs (see [page 122](#)).

If you need to change the contrast, see [page 118](#).

3. Enter the remote fax phone number using the number keypad.

You can use one, two or three-digit speed or group dial numbers. For details, see ["Automatic Dialing" on page 128](#).

4. Press <Send Fax>.
5. When the document is loaded from the scanner glass, the display shows "Another Page?" on the top line after the document is scanned into the memory. *If you have additional pages*, remove the scanned page and load the next page from the glass and select "1:Yes". Repeat as necessary.

After all of the pages are scanned, select "2:No" when the display shows "Another Page?"

6. The number is dialed and then the multi-function printer begins sending the fax when the remote fax machine is ready.



NOTE: Press <Cancel> to cancel the fax job at any time while sending the fax.

Sending a Fax Manually

1. Load the document(s) face up with top edge in first into the ADF.

OR

Place a single document face down on the scanner glass.

For details about loading a document, see [page 120](#).

2. Adjust the document resolution to suit your fax needs (see [page 122](#)).

If you need to change the contrast, see [page 118](#).

3. Press <On Hook Dial>. You hear a dial tone.
4. Enter the remote fax machine's fax number using the number keypad.
5. When you hear a high-pitched fax tones from the remote fax machine, press <Send Fax>.



NOTE: Press <Cancel> to cancel the fax job at any time while sending the fax.

Confirming Transmissions

When the last page of your document has been sent successfully, the multi-function printer beeps and returns to Standby mode.

If something goes wrong while sending your fax, an error message appears on the display. For a listing of error messages and their meanings, see [page 171](#).

If you receive an error message, press <Cancel> to clear the message and try to send the document again.

You can set your multi-function printer to print a confirmation report automatically after each fax transmission. For further details, see the MSG Confirm item in ["Available Fax Setup Options" on page 118](#).

Automatic Redialing

If the number you have dialed is busy or there is no answer when you send a fax, the multi-function printer will automatically redial the number every three minutes up to seven times by the factory default settings.

When the display shows "Retry Redial?" press <Select> to redial the number without waiting. To cancel the automatic redialing, press <Cancel>.

To change the time interval between redials and the number of redial attempts, see [page 118](#).

Receiving a Fax

 **NOTE:** The Dell Laser Multi-Function Printer 1600n cannot receive color faxes.

About Receiving Modes

 **NOTE:** To use the Ans/Fax mode, attach an answering machine to the Phone connector (☎) on the back of your multi-function printer.

When the memory is full, the receiving mode automatically switches to Tel.

Loading Paper for Receiving Faxes

The instructions for loading paper in the paper tray are the same whether you are printing, faxing, or copying, except that faxes can only be printed on Letter-, A4-, or Legal-sized paper. For details about loading paper, see [page 25](#). For details about setting the paper type and size in the tray, see [page 66-67](#).

Receiving Automatically in the Fax Mode

Your multi-function printer is preset to the fax mode at the factory.

When you receive a fax, the multi-function printer answers the call on a specified number of rings and automatically receives the fax.

To change the number of rings, see ["Available Fax Setup Options" on page 118](#).

If you want to adjust the ringer volume, see ["Setting Sounds" on page 115](#).

Receiving Manually in the Tel Mode

You can receive a fax by picking up the handset of the extension phone and then pressing the remote receive code (see [page 119](#)), or by pressing <On Hook Dial> (you can hear voice or fax tones from the remote machine) and then <Send Fax> on the operator panel.

The multi-function printer begins receiving a fax and returns to Standby mode when the reception is completed.

Receiving Automatically in the Ans/Fax Mode

For this mode, if an answering machine is used, you must attach an answering machine to the Phone connector (📞) on the back of your multi-function printer.

If the caller leaves a message, the answering machine stores the message as it would normally. If your multi-function printer hears a fax tone on the line, it automatically starts to receive fax.

 **NOTE:** If you have set your multi-function printer to Ans/Fax mode and your answering machine is switched off, or no answering machine is connected to your multi-function printer, your multi-function printer will automatically go into Fax mode after a predefined number of rings.

Receiving Manually Using an Extension Telephone

This feature works best when you are using an extension telephone connected to the Phone connector (📞) on back of your multi-function printer. You can receive a fax from someone you are talking to on the extension telephone without having to go to the fax machine.

When you receive a call on the extension phone and hear fax tones, press the keys **"*9*"** (star nine star) on the extension telephone.

The multi-function printer receives the document.

Press the buttons slowly in sequence. *If you still hear the fax tone from the remote machine*, try pressing **"*9*"** once again.

"*9*" is the remote receive code preset at the factory. The first and the last asterisks are fixed, but you can change the middle number to whatever you choose. For details on changing the code, see [page 118](#).

Receiving Faxes Using the DRPD Mode

"Distinctive Ring" is a telephone company service which enables a user to use a single telephone line to answer several different telephone numbers. The particular number someone uses to call you on is identified by different ringing patterns, which consist of various combinations of long and short ringing sounds.

Using the Distinctive Ring Pattern Detection feature, your fax machine can "learn" the ring pattern you designate to be answered by the FAX machine. This ringing pattern will be recognized and answered as a FAX call, and all other ringing patterns will be forwarded to the extension telephone or answering machine plugged into the Phone connector (☎) on back of your multi-function printer. You can easily suspend or change Distinctive Ring Pattern Detection at any time.

Before using the Distinctive Ring Pattern Detection option, Distinctive Ring service must be installed on your telephone line by the telephone company. To set up Distinctive Ring Pattern Detection, you will need another telephone line at your location, or someone available to dial your FAX number from outside.

To set up the DRPD mode:

1. Press <Menu> until "Fax Setup" appears on the top line of the display.

The first available menu item, "Receive Mode" displays on the bottom line.

2. Press the scroll button (◀ or ▶) until you see "DRPD Mode" on the bottom line and press <Select>.
3. When "Set" displays on the bottom line, press <Select>.

The LCD displays "Waiting Ring"

4. Call your fax number from another telephone. It is not necessary to place the call from a fax machine.
5. When your multi-function printer begins to ring, do not answer the call. The multi-function printer requires several rings to learn the pattern.
6. When the multi-function printer completes learning, the LCD displays "End DRPD Setup".

If the DRPD setup fails, "DRPD Ring Error" appears. Press <Select> when "DRPD Mode" displays and retry from step 3.

7. To return to Standby mode, press <Cancel>.

When the DRPD feature is set up, the DRPD option is available in the Receive Mode menu. To receive faxes in the DRPD mode, you need to set the menu to DRPD; see [page 118](#).

 **NOTE:** DRPD must be set up again if you re-assign your fax number, or connect the multi-function printer to another telephone line.

 **NOTE:** After DRPD has been set up, call your fax number again to verify that the multi-function printer answers with a fax tone. Then have a call placed to a different number assigned to that same line to be sure the call is forwarded to the extension telephone or answering machine plugged into the Phone connector (☎) on the back of the multi-function printer.

Receiving Faxes in the Memory

Since your multi-function printer is a multi-tasking device, it can receive faxes while you are making copies or printing. If you receive a fax while you are copying, printing, or run out of paper or toner, your multi-function printer stores incoming faxes in the memory. Then, as soon as you finish copying, printing, or resupply the consumables, the multi-function printer automatically prints the fax.

Automatic Dialing

Speed Dialing

You can store up to 200 frequently dialed numbers in one, two or three-digit speed dial locations (0-199).

Storing a Number for Speed Dialing

1. Press <Phone Book> on the operator panel.
2. Press <Phone Book> or the scroll button (◀ or ▶) to display "Store&Edit" on the bottom line of the display. Press <Select>.
3. Press <Select> when "Speed Dials" appears on the display.
4. Enter a one, two or three-digit speed dial number between 0 and 199, using the number keypad and press <Select>.

Or select the location by pressing the scroll button (◀ or ▶) and then press <Select>.

If a number is already stored in the location you chose, the display shows the number to allow you to change it. To start over with another speed-dial number, press <Return>.

5. Enter the number you want to store using the number keypad and press <Select>.

To insert a pause between numbers, press <Redial/Pause> and a "-" appears on the display.

6. To assign a name to the number, enter the name. For details about how to enter names, see ["Using the Number Keypad to Enter Characters" on page 113](#).

OR

If you do not want to assign a name, skip this step.

7. Press <Select> when the name appears correctly or without entering a name.
8. To store more fax numbers, repeat steps 4 through 7.

OR

To return to Standby mode, press <Return> or <Cancel>.

Sending a Fax using a Speed Number

1. Load the document(s) face up with top edge in first into the ADF.

OR

Place a single document face down on the scanner glass.

For details about loading a document, see [page 120](#).

2. Adjust the document resolution to suit your fax needs (see [page 122](#)).

If you need to change the contrast, see [page 118](#).

3. Enter the speed dial number.
 - o For a one-digit speed dial number, press and hold the appropriate digit button.
 - o For a two-digit speed dial number, press the first digit button and hold the last digit button.
 - o For a three-digit speed dial number, press the first and second digit buttons and hold the last digit button.

The corresponding entry's name briefly displays.

4. The document scans into the memory.

When the document is loaded on the scanner glass, the LCD display asks if you want to send another page. Select "1:Yes" to add more documents or "2:No" to begin sending the fax immediately.

5. The fax number stored in the speed dial location is automatically dialed. The document is sent when the remote fax machine answers.

Group Dialing

If you frequently send the same document to several destinations, you can create a group of these destinations and set them under a one, two or three-digit group dial location. This enables you to use a group dial number setting to send the same document to all the destinations in the group.



NOTE: You cannot include one group dial number within another group dial number.

Setting Group Dial

1. Press <Phone Book> on the operator panel.
2. Press <Phone Book> or the scroll button (◀ or ▶) to display "Store&Edit" on the bottom line of the

display. Press <Select>.

3. Press the scroll button (◀ or ▶) to display "Group Dials" on the bottom line and press <Select>.
4. Press <Select> when "New" displays on the bottom line.
5. Enter a group number between 0 and 199 and press <Select>.

Or select the location you want by pressing the scroll button (◀ or ▶) and then press <Select>.

If a number is already stored in the location you chose, the display shows the number to allow you to change it. To start over with another speed-dial number, press <Return>.

6. Enter a one, two or three-digit speed number you want to assign to the group and press <Select>.

Or select the location by pressing the scroll button (◀ or ▶) and then press <Select>. If a number is already stored in the location you chose, the display shows the number to allow you to change it. To start over with another group-dial number, press <Return>.

7. Repeat step 6 to enter other speed dial numbers into the group.
8. Press <Return> when you have entered all of the desired numbers. The display prompts you to enter a group name (ID:).
9. To assign a name to the group, enter the name.

OR

If you do not want to assign a name, skip this step.

10. Press <Select> when the name appears correctly or without entering a name.
11. *If you want to assign another group, repeat from step 4.*

OR

To return to Standby mode, press <Cancel>.

Editing Group Dial Numbers

You can delete a specific speed dial number from a selected group or add a new number to the selected group.

1. Press <Phone Book> on the operator panel.
2. Press <Phone Book> or the scroll button (◀ or ▶) to display "Store&Edit" on the bottom line of the display. Press <Select>.
3. Press the scroll button (◀ or ▶) to display "Group Dials" on the bottom line and press <Select>.
4. Press the scroll button (◀ or ▶) to display "Edit" on the bottom line and press <Select>.
5. Enter the group number you want to edit or select the group number by pressing the scroll button (◀

or ►).

6. Press <Select>.

The display prompts you to enter a speed dial number.

7. Enter a speed dial number to be added or deleted.

8. When you enter the specific number from the group, the display shows "Delete?"

When you enter a new number, the display shows "Add?"

 **NOTE:** When you delete the last speed dial in a group, the group itself is deleted.

9. Press <Select>.

10. *If you want to edit another group*, repeat from step 4.

OR

To return to Standby mode, press <Return>.

Sending a Fax Using Group Dialing (Multi-address Transmission)

You can use group dialing for Broadcasting or Delayed transmissions.

Follow the procedure of the desired operation (Broadcasting transmission; see [page 133](#), Delayed transmission; see [page 134](#)). When you come to a step in which the display asks you to enter the remote fax number:

- For a one-digit group number, press and hold the appropriate digit button.
- For a two-digit group number, press the first digit button and hold the last digit button.
- For a three-digit speed dial number, press the first and second digit buttons and hold the last digit button.

You can use only one group number for one operation. Then continue the procedure to complete the desired operation.

Your multi-function printer automatically scans the document loaded in the Automatic Document Feeder or on the scanner glass into the memory. The multi-function printer dials each of the numbers included in the group.

Searching for a Number in the Memory

There are two ways to search for a number in the memory. You can either scan from A to Z sequentially, or

you can search using the first letter of the name associated with the number.

Searching Sequentially through the Memory

1. Press <Phone Book>.
2. Press <Select> when "Search&Dial" appears on the display.
3. Press the scroll button (◀ or ▶) to scroll through the memory until the name and number you want to dial displays. You can search upwards or downwards through the entire memory in alphabetical order, from A to Z.

While searching through the printer's memory, you can see that each entry is preceded by one of two letters; "s" for speed dial or "g" for group dial number. These letters tell you how the number is stored.

4. When the name and/or the number you want displays, press <Send Fax> or <Select> to dial.

Searching with a Particular First Letter

1. Press <Phone Book>.
2. Press <Select> when "Search&Dial" appears on the bottom of the display.
3. Press the button labeled with the letter you want to search for. A name beginning with the letter displays.

For example, if you want to find the name "MOBILE", press the 6 button, which is labeled with "MNO".

4. Press the scroll button (◀ or ▶) to display the next name.
5. When the name and/or the number you want displays, press <Send Fax> or <Select> to dial.

Printing a Phonebook List

You can check your automatic dial setting by printing a Phonebook list.

1. Press <Phone Book>.
2. Press <Phone Book> or the scroll button (◀ or ▶) until "Print" appears on the bottom line and press <Select>.

A list showing your speed dial and group dial entries prints out.

Other Ways to Fax

Redialing

To redial the number you last called:

Press <Redial/Pause>.

When a document is loaded in the ADF (Automatic Document Feeder; see [page 120](#)), the multi-function printer automatically begins to send.

For the document loaded on the scanner glass, the display asks if you want to load another page. Select "1:Yes" to add. Otherwise, select "2:No"

Sending Broadcasting Faxes

Using the <Broadcasting> button on the operator panel, you can use the broadcasting fax feature, which allows you to send a document to multiple locations. Documents are automatically stored in the memory and sent to a remote station. After transmission, the documents are automatically erased from the memory.

1. Load the document(s) face up with top edge in first into the ADF.

OR

Place a single document face down on the scanner glass.

For details about loading a document, see [page 120](#).

2. Adjust the document resolution to suit your fax needs (see [page 122](#)).

If you need to change the contrast, see [page 118](#).

3. Press <Broadcasting> on the operator panel.
4. Enter the number of the remote machine using the number keypad.

You can also use one, two, or three-digit speed dial or group dial numbers. For details, see "[Automatic Dialing](#)" on [page 128](#).

5. Press <Select> to confirm the number. The display asks you to enter another fax number to send the document to.



NOTE: Your multi-function printer can send one broadcasting fax to multiple destinations. The "Enter Number" prompt does not appear if a broadcast is set up and not completed. You must wait until the current broadcast is completed.

6. *If you want to enter more fax numbers, repeat steps 4 and 5. You can add up to 10 destinations.*

Note that you cannot use more than one group dial number per broadcast operation.

7. When you finish entering fax numbers, press <Send Fax>.

The document is scanned into the memory before transmission. The display shows the memory capacity and the number of pages being stored in the memory.

For documents loaded on the scanner glass, the display asks if you want to load another page. Select "1:Yes" to add. Otherwise, select "2:No"

8. The multi-function printer begins sending the document in the order of the numbers you entered.

Sending a Delayed Fax

You can set your multi-function printer to send a fax at a later time when you will not be present.

1. Load the document(s) face up with top edge in first into the ADF.

OR

Place a single document face down on the scanner glass.

For details about loading a document, see [page 120](#).

2. Adjust the document resolution to suit your fax needs (see [page 122](#)).

If you need to change the contrast, see [page 118](#).

3. Press <Menu> until "Fax Feature" appears on the top line of the display. The first available menu item, "Delay Fax," displays on the bottom line.

4. Press <Select>.

5. Enter the number of the remote machine using the number keypad.

To enter the number, you can use one, two, or three-digit speed dial or group dial numbers. For details, see ["Automatic Dialing" on page 128](#).

6. Press <Select> to confirm the number on the display. The display asks you to enter a name.

7. *If you want to assign a name to the transmission, enter the name. If not, skip this step.*

For details on how to enter the name using the number keypad, see ["Using the Number Keypad to Enter Characters" on page 113](#).

8. Press <Select>. The display shows the current time and asks you to enter the start time when the fax is to be sent.

9. Enter the time using the number keypad.

To select "AM" or "PM" for 12-hour format, press the * or the # button.

When the cursor is not under the AM or PM indicator, pressing the * or the # button immediately moves the cursor to the indicator.

If you set a time earlier than the current time, the document will be sent at that time the following day.

10. Press <Select> when the start time displays correctly.
11. The document is scanned into the memory before transmission. The display shows the memory capacity and the number of pages being stored in memory.

For the document loaded on the scanner glass, the display asks if you want to load another page. Select "1:Yes" to add. Otherwise, select "2:No"

12. The multi-function printer returns to Standby mode. The display reminds you that you are in Standby mode and that a delayed fax is set.

 **NOTE:** *If you want to cancel the delayed transmission, see ["Canceling a Scheduled Fax" on page 137.](#)*

Sending a Priority Fax

Using the Priority Fax feature, a high priority document can be sent ahead of reserved operations. The document is scanned into the memory and transmitted when the current operation is finished. In addition, the priority transmission interrupts a broadcast operation between stations (i.e., when the transmission to station A ends, before transmission to station B begins) or between redial attempts.

1. Load the document(s) face up with top edge in first into the ADF.

OR

Place a single document face down on the scanner glass.

For details about loading a document, see [page 120](#).

2. Adjust the document resolution to suit your fax needs (see [page 122](#)).

If you need to change the contrast, see [page 118](#).

3. Press <Menu> until "Fax Feature" appears on the top line of the display.
4. Press the scroll button (◀ or ▶) to display "Priority Fax" on the bottom line and press <Select>.
5. Enter the number of the remote machine using the number keypad.

To enter the number, you can use one, two, or three-digit speed dial or group dial numbers. For details, see ["Automatic Dialing" on page 128](#).

6. Press <Select> to confirm the number. The display asks you to enter a name.
7. *If you want to assign a name to the transmission, enter the name. If not, skip this step.*

For details on how to enter a name using the number keypad, see ["Using the Number Keypad to Enter Characters" on page 113](#).

8. Press <Select>.

The document is scanned into the memory before transmission. The display shows the memory capacity and the number of pages being stored in the memory.

For the document loaded on the scanner glass, the display asks if you want to load another page. Select "1:Yes" to add. Otherwise, select "2:No"

9. The multi-function printer shows the number being dialed and begins sending the document.

Adding Documents to a Scheduled Fax

You can add documents to the delayed transmission previously reserved in your printer's memory.

1. Load the document(s) face up with top edge in first into the ADF.

OR

Place a single document face down on the scanner glass.

For details about loading a document, see [page 120](#).

2. Adjust the document resolution to suit your fax needs (see [page 122](#)).

If you need to change the contrast, see [page 118](#).

3. Press <Menu> until "Fax Feature" appears on the top line of the display.
4. Press the scroll button (◀ or ▶) to display "Add Page" on the bottom line and press <Select>.

The display shows the last job reserved in memory.

5. Press the scroll button (◀ or ▶) until you see the fax job to which you want to add documents to and press <Select>.

The multi-function printer automatically stores the documents in the memory, and the display shows the memory capacity and the number of pages.

For the document loaded on the scanner glass, the display asks if you want to load another page. Select "1:Yes" to add. Otherwise, select "2:No"

6. After storing, the multi-function printer displays the numbers of total pages and added pages and then returns to Standby mode.

Canceling a Scheduled Fax

1. Press <Menu> until "Fax Feature" appears on the top line of the display.
2. Press the scroll button (◀ or ▶) to display "Cancel Job" on the bottom line and press <Select>.

The display shows the last job reserved in memory.

3. Press the scroll button (◀ or ▶) until you see the fax job you want to cancel, and press <Select>.
4. When the confirming message displays, select "1:Yes" to cancel the job.

The selected job is canceled and the multi-function printer returns to Standby mode.

Additional Features

Using the Secure Receiving Mode

You may need to prevent your received faxes from being accessed by unauthorized people. You can turn on the secure fax mode using the Secure Receive option to restrict printing out all of the received faxes when the multi-function printer is unattended. In the secure fax mode, all incoming faxes will go in memory. When the mode turns off, any faxes stored will be printed.

To turn the secure receiving mode on:

1. Press <Menu> until "Advanced Fax" appears on the top line of the display.
2. Press the scroll button (◀ or ▶) until "Secure Receive" appears on the bottom line and press <Select>.
3. Press <Select> when "On" displays at the bottom line.
4. Enter a four-digit passcode you want to use, using the number keypad and press <Select>.
5. Re-enter the passcode again and then press <Select>.



NOTE: You can use the secure receiving mode without setting a passcode, but cannot protect your faxes.

6. To return to Standby mode, press <Return>.

When a fax is received in the secure receiving mode, your multi-function printer stores it into memory and displays "Secure Receive" to let you know that there is a fax stored.

To print received documents:

1. Access the Secure Receive menu by following steps 1 and 2 above.

2. Press the scroll button (◀ or ▶) to display "Print" on the bottom line and press <Select>.
3. Enter the four-digit passcode and press <Select>.

The faxes stored in memory are printed.

To turn the secure receiving mode off:

1. Access the Secure Receive menu by following steps 1 and 2 in "[To turn the secure receiving mode on:](#)" on page 138.
2. Press the scroll button (◀ or ▶) to display "Off" on the bottom line and press <Select>.
3. Enter the four-digit passcode and press <Select>.

The mode is deactivated and the multi-function printer prints all of the faxes stored in memory.

4. To return to Standby mode, press <Return>.

Printing Reports

The following reports are available:

Phonebook List

This list shows all of the numbers currently stored in the printer's memory as speed dial and group dial numbers.

You can print this Phonebook list using the <Phone Book> button on the operator panel; see [page 133](#).

Sent Fax Report

This report shows information about the faxes you recently sent.

Received Fax Report

This report shows information about the faxes you recently received.

System Data List

This list shows the status of the user-selectable options. You may print this list to confirm your changes after

changing any settings.

Scheduled Job Information

This list shows the documents currently stored for Delayed faxes or Toll Save faxes. The list shows the starting time and type of operation.

Message Confirmation

This report shows the fax number, the number of pages, the elapsed time of the job, the communication mode, and the communication results.

You can set up your multi-function printer to automatically print the message confirmation report after each fax job. See [page 118](#).

Junk Fax Number List

This list shows up to 10 fax numbers specified as junk fax numbers by using the Junk Fax Setup menu; see [page 141](#). When the Junk Fax Barrier feature is turned on, incoming faxes from those numbers will be blocked.

This feature recognizes the last 6 digits of the fax number set as a remote fax machine's ID.

Multi-communication Report

This report is printed automatically after sending documents to more than one location.

Power Failure Report

This report is printed out automatically when power is restored after a power failure if there is any data loss due to the power failure.

Printing a Report

1. Press <Menu> until "Reports" appears on the top line of the display. The first available menu item, "Phone Book" displays on the bottom line.
2. Press the scroll button (◀ or ▶) to display the report or list you want to print on the bottom line.
 - o Phone Book: Phonebook list
 - o Sent Report: Sent fax report
 - o RCV Report: Received fax report

- o System Data: System data list
- o Scheduled Jobs: Scheduled job information
- o MSG Confirm: Message confirmation
- o Junk Fax List: Junk fax number list

3. Press <Select>.

The selected information prints out.

Using Advanced Fax Settings

Your multi-function printer has various user-selectable setting options for sending or receiving faxes. These options are preset at the factory, but you may need to change them. To find out how the options are currently set, print the System Data list. For details about printing the list, see ["Printing Reports" on page 139](#).

Changing Setting Options

1. Press <Menu> until "Advanced Fax" appears on the top line of the display. The first available menu item, "Send Forward," displays on the bottom line.
2. Press the scroll button (◀ or ▶) until you see the desired menu item on the bottom line and press <Select>.
3. When the option you want appears on the display, choose the desired status by pressing the scroll button (◀ or ▶) or enter the desired value using the number keypad.
4. Press <Select> to save the selection.
5. You can exit from the setup mode at any time by pressing <Return>.

Advanced Fax Setting Options

Option	Description
Send Forward	<p>You can set the multi-function printer to always forward all of the outgoing faxes to the specified destination besides the fax numbers you entered.</p> <p>Select Off to turn this feature off.</p> <p>Select On to turn this feature on. You can set the number of the remote fax machine to which faxes are forwarded.</p>
RCV Forward	<p>You can set your multi-function printer to forward incoming faxes to another fax number during a specified time period. When a fax arrives at your multi-function printer, it is stored in the memory. Then, the multi-function printer dials the fax number that you have specified and sends the fax.</p> <p>Select Off to turn this feature off.</p>

	<p>Select On to turn this feature on. You can set the fax number to which faxes are forwarded. Then, you can enter the start time and/or the end time. The Print Local Copy option allows you to set the multi-function printer to print the fax, if fax forwarding is completed with no error.</p>
Toll Save	<p>You can set your multi-function printer to store your faxes in memory and to send them at the specified toll-saving time. For details about sending toll save faxes, see page 116.</p> <p>Select Off to turn this feature off.</p> <p>Select On to turn this feature on. You can set the start time and date; and the end time and date for toll save mode.</p>
Junk Fax Setup	<p>Using the Junk Fax Barrier feature, the system will not accept faxes sent from remote stations. Their numbers are stored in memory as junk fax numbers. This feature is useful for blocking any unwanted faxes.</p> <p>Select Off to turn the feature off. Anybody can send you a fax.</p> <p>Select On to turn the feature on. You can set up to 10 fax numbers as junk fax numbers. After storing the numbers, you do not receive any faxes from the registered stations.</p>
Secure Receive	<p>You can keep your received faxes from being accessed by unauthorized people.</p> <p>For further details about setting this mode, see page 138.</p>
Prefix Dial	<p>You can set a prefix dial number of up to five digits. This number dials before any auto dial number is started. It is useful for accessing the PABX exchange.</p>
Stamp RCV Name	<p>This option allows the multi-function printer to automatically print the page number, and the date and time of the reception at the bottom of each page of a received document.</p> <p>Select Off to turn this feature off.</p> <p>Select On to turn this feature on.</p>
Cover Page	<p>Create cover pages for your faxes using the Printer Settings Utility. For details, see page 46.</p> <p>Select Off to turn this feature off.</p> <p>Select On to turn this feature on.</p>
ECM Mode	<p>The Error Correction Mode helps with poor line quality and makes sure that any faxes sent are sent smoothly to any other ECM-equipped fax machine. If the line quality is poor, it takes more time to send a fax when you are using the ECM mode.</p> <p>Select Off to turn this feature off.</p> <p>Select On to turn this feature on.</p>

Networking

- [About Sharing the Printer on a Network](#)
 - [Setting Up the Locally Shared Printer](#)
 - [Setting Up a Network-connected Printer](#)
-

About Sharing the Printer on a Network

Locally-shared Printer

You can connect the multi-function printer directly to a selected computer, which is called the "host computer" on the network. The multi-function printer can then be shared by other users on the network through a Windows 98, Me, 2000, XP, Server 2003, or NT 4.0 network printer connection.

Wired Network-connected Printer

Your multi-function printer has a built-in network interface. For details, see [page 31](#).

Printing Across a Network

Whether the multi-function printer is locally connected or network-connected, you need to install the Dell Laser MFP 1600n software on each computer that prints documents using the multi-function printer.

Setting Up the Locally Shared Printer

You can connect the multi-function printer directly to a selected computer, which is called the "host computer," on the network. Your multi-function printer can be shared by other users on the network through a Windows 98, Me, 2000, XP, Server 2003, or NT 4.0 network printer connection.

In Windows 98/Me

Setting Up the Host Computer

1. Start Windows.
2. Click the Start button and point to Control Panel and double-click the Network icon.

3. Click the File and Print Sharing box, check the box next to I want to be able to allow others to print to my printer and click OK.
4. Click Start and point to Printers from Settings. Double-click your printer name.
5. Click Properties in the Printer menu.
6. Click the Sharing tab and check the Shared As box. Fill in the Share Name field and then click OK.

Setting Up the Client Computer

1. Right-click the Start button and point to Explore.
2. Open your network folder in the left column.
3. Right-click the shared name and click Capture Printer Port.
4. Select the port you want, check the Reconnect at log on box and then click OK.
5. Click the Start button and point to Settings and then Printers.
6. Double-click your printer icon.
7. Click the Printer menu and point to Properties.
8. Click the Details tab and point to the printer port and then click OK.

In Windows NT 4.0/2000/XP/Server 2003

Setting Up the Host Computer

1. Start Windows.
2. For Windows NT 4.0/2000, click the Start button ⇒ Settings ⇒ Printers.

For Windows XP/Server 2003, click the Start button and point to Printers and Faxes.

3. Double-click your printer icon.
4. Click the Printer menu and point to Sharing.
5. For Windows NT 4.0, check the Shared box.

For Windows 2000, check the Shared As box.

For Windows XP/Server 2003, check the Share this printer box.

6. Fill in the Share Name field and click OK.

Setting Up the Client Computer

1. Right-click the Start button and point to Explore.
2. Open your network folder in the left column.
3. Click the shared name.
4. For Windows NT 4.0/2000, from the Start button, Click Settings and point to Printers.

For Windows XP/Server 2003, from the Start button, click and point to Printers and Faxes.

5. Double-click your printer icon.
6. Click the Printer menu and point to Properties.
7. Click the Ports tab and point to Add Port.
8. Click Local Port and point to New Port.
9. Fill in the Enter a port name field and enter the shared name.
10. Click OK and point to Close.
11. For Windows NT 4.0, click OK.

For Windows 2000/XP/Server 2003, click Apply and point to OK.

Setting Up a Network-connected Printer

You must set up the network protocols on the multi-function printer to use it as your network printer. Setting protocols can be accomplished by using the supplied network program.

You can configure the basic network parameters through the multi-function printer's operator panel. Use the printer operator panel to do the following:

- Print a Network Configuration Page
- Configure TCP/IP

Configuring Network Parameters on the Operator Panel

Item	Requirements
Network Interface	10/100 Base-TX
Network Operating System	Windows 98/Me, NT 4.0/2000/XP/Server 2003
Network Protocols	<ul style="list-style-type: none"> • TCP/IP on Windows • Port9100 on Windows 2000//XP/Server 2003
Dynamic Addressing Server	<ul style="list-style-type: none"> • DHCP, BOOTP

Printing a Network Configuration Page

The Network Configuration page shows how the network interface card on your multi-function printer is configured. The default settings are suitable for most applications.

1. Press <Menu> until you see "Network Setup" on the bottom line of the display.
2. Press the scroll button (◀ or ▶) until "Print Sys. Data" displays on the bottom line.
3. Press <Select>.

The first available menu item, "Yes" displays on the bottom line.

4. Press <Select> to print a network configuration page.

The Network Configuration page prints out.

Setting Network Protocols

When you first install the multi-function printer, all supported network protocols are enabled when you power the multi-function printer on. If a network protocol is enabled, the multi-function printer may actively transmit on the network even when the protocol is not in use. This may slightly increase network traffic. To eliminate unnecessary traffic, you can disable unused protocols.

1. Press <Menu> until you see "Network Setup" on the bottom line of the display.
2. Press the scroll button (◀ or ▶) until "Configuration" displays on the bottom line. Press <Select>.
3. Press the scroll button (◀ or ▶) until you see the desired protocol on the bottom line.
4. Press <Select>.
5. If you selected Ethernet, select a network speed.

If you selected TCP/IP, assign a TCP/IP address. For details, see below.

If you selected Ether Talk, press the scroll button (◀ or ▶) to change the setting to "On" (enable) or "Off" (disable).

6. Press <Select> to save the selection.

Configuring TCP/IP

- Static Addressing: TCP/IP address is assigned manually by the system administrator.
- Dynamic Addressing BOOTP/DHCP(default): TCP/IP address is assigned automatically by a DHCP or BOOTP server on your network.

Static Addressing

To enter the TCP/IP address from your multi-function printer's operator panel, take the following steps:

1. Press <Menu> until you see "Network Setup" on the bottom line of the display.
2. Press the scroll button (◀ or ▶) until "Configuration" displays on the bottom line. Press <Select>.
3. Press the scroll button (◀ or ▶) to display "TCP/IP" and press <Select>.

The first available menu item, "Manual", appears on the bottom line and press <Select>.

4. The first available menu item, "IP Address" displays on the bottom line.
5. Press <Select> to access the IP Address menu.

An IP address consists of 4 bytes.

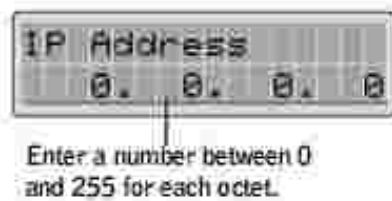

6. Enter the numbers from the keypad and use the scroll button (◀ or ▶) to move between octets and press <Select>.
7. Repeat Step 5 to complete the address from the 1st byte to the 4th byte.
8. To select other parameters, such as the Subnet Mask, Gateway or Primary DNS, press <Return>, then use the scroll button (◀ or ▶). Press <Select>.
9. Repeat steps 5 through 8 to configure the other TCP/IP parameters.

Dynamic Addressing (BOOTP/DHCP)

To assign the TCP/IP address automatically using a DHCP or BOOTP server on your network, take the following steps:

1. Press <Menu> until you see "Network Setup" on the bottom line of the display.
2. Press the scroll button (◀ or ▶) until "Configuration" displays on the bottom line. Press <Select>.
3. Press the scroll button (◀ or ▶) to display "TCP/IP" and press <Select>.
4. Press the scroll button (◀ or ▶) to display "DHCP" on the bottom line and press <Select>.
5. To assign the address from the BOOTP server, press <Select> when "BOOTP" displays on the bottom line.

Restoring the Network Configuration

You can return the network configuration to its default settings.

1. Press <Menu> until you see "Network Setup" on the bottom line of the display.
2. Press the scroll button (◀ or ▶) until "Clear Setting" displays on the bottom line.
3. Press <Select>.

The first available menu item, "Yes" displays on the bottom line.

4. Press <Select> to restore the network configuration.
5. Power the multi-function printer off and back on or reset the network interface card.

Resetting the Network Interface Card

You can reset the network interface card when a network problems occurs.

1. Press <Menu> until you see "Network Setup" on the bottom line of the display.

The first available item, "Reset NIC", displays on the bottom line.

2. Press <Select>.

The first available menu item, "Yes" displays on the bottom line.

3. Press <Select> to reset the network interface card.

Maintenance

- [Clearing the Memory](#)
 - [Cleaning Your Multi-Function Printer](#)
 - [Maintaining the Toner Cartridge](#)
 - [Ordering Supplies](#)
-

Clearing the Memory

You can selectively clear information stored in your multi-function printer's memory.

1. Press <Menu> on the operator panel until "Maintenance" appears on the top line of the display.
2. Press the scroll button (◀ or ▶) until you see "Clear Setting" on the bottom line and press <Select>.

The first available menu item, "Paper Setting" displays on the bottom line.

3. Press the scroll button (◀ or ▶) until you see the item you want to clear.
 - Paper Setting: Restores all of the Paper Setting options to the factory default.
 - Copy Setup: Restores all of the Copy Setup options to the factory default.
 - Fax Setup: Restores all of the Fax Setup options to the factory default.
 - Fax Feature: Cancels all of the scheduled fax jobs in the printer's memory.
 - Advanced Fax: Restores all of the Advanced Fax setting options to the factory default.
 - All Settings: Clears all of the data stored in the memory and resets all of your settings to the factory default.
 - Sent Report: Clears all records of your sent faxes.
 - RCV Report: Clears all records of your received faxes.
 - Phone Book: Clears the speed dial or group dial numbers stored in the memory.
4. Press <Select>. The selected memory is cleared and the display asks you to continue clearing the next item.
5. Repeat steps 2 and 3 to clear another item.

OR

To return to Standby mode, press <Return>.

Cleaning Your Multi-Function Printer

To maintain the print quality, follow the cleaning procedures below, each time the toner cartridge is replaced or if print quality problems occur.

 **NOTE:** Do not touch the transfer roller located under the toner cartridge when cleaning inside the multi-function printer. Oil from your fingers may cause print quality problems.

 **CAUTION:** Cleaning solvents that contain alcohol or other strong substances may discolor or crack the multi-function printer cabinet.

Cleaning the Exterior

Clean the multi-function printer cabinet with a soft, damp, lint-free cloth. Do not let water drip onto the multi-function printer or inside the multi-function printer.

Cleaning the Interior

Paper, toner, and dust particles can accumulate inside the multi-function printer and cause print quality problems, such as smearing or toner specks. Clean inside the multi-function printer to prevent these problems.

1. Power the multi-function printer off and unplug the power cord. Specify the length of time it takes for the printer to cool down.
2. Open the front cover and lightly pull the toner cartridge straight out. Set it on a clean flat surface.

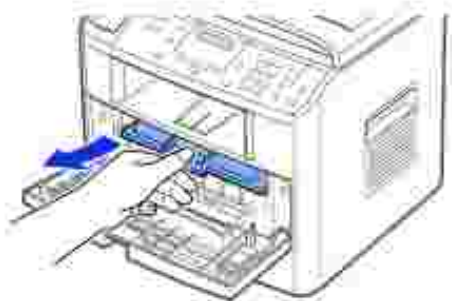

 **CAUTION:** To prevent damage, do not expose the toner cartridge to light for more than a few minutes.

 **CAUTION:** Do not touch the green underside of the toner cartridge. Use the handle on the cartridge to avoid touching this area.

3. With a dry and lint-free cloth, wipe away any dust and spilled toner from the toner cartridge area and the toner cartridge cavity.



 **CAUTION:** Do not touch the transfer roller inside the multi-function printer. Oil from your fingers may cause print quality problems.

4. Reinsert the toner cartridge and close the front cover.
5. Plug in the power cord and power the multi-function printer on.

Cleaning the scanner

Keeping the scanner clean helps ensure the best possible copies. Dell recommends cleaning the scanner at the start of each day and during the day, as needed.

1. Slightly dampen a soft lint-free cloth or paper towel with water.
2. Open the document cover.



3. Wipe the surface of the scanner glass and ADF glass until it is clean and dry.

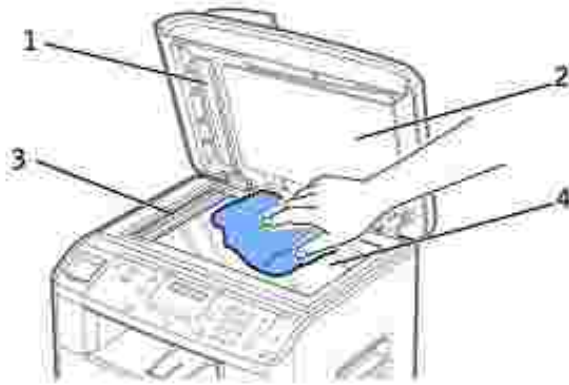

1	White Sheet
2	Document Cover
3	ADF Glass
4	Scanner Glass

4. Wipe the underside of the white document cover and white sheet until it is clean and dry.

5. Close the document cover.

Maintaining the Toner Cartridge

Storing the Toner Cartridge

Store the toner cartridge in the original packaging until you are ready to install it.

Do not store the toner cartridge in:

- Temperatures greater than 40° C (104° F)
- An environment with extreme changes in humidity or temperature
- Direct sunlight
- Dusty places
- A car for a long period of time
- An environment where corrosive gases are present
- An environment with salty air

Redistributing Toner

When the toner cartridge is near the end of its life, white streaks or light print occurs. The LCD displays the warning message, "Toner Low". Gently shake the toner cartridge from side-to-side to distribute the toner evenly and temporarily improve print quality.

1. Open the front cover.

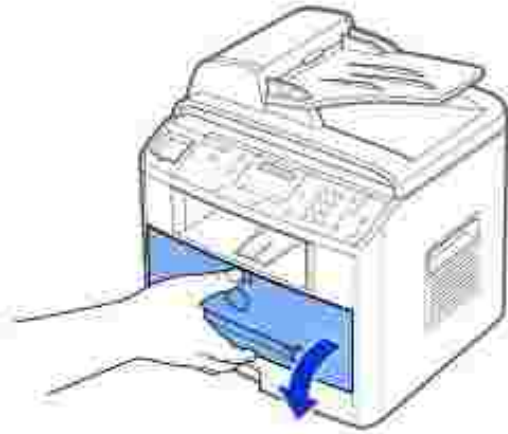

2. Pull the toner cartridge out and gently shake the cartridge to distribute the toner evenly inside the cartridge.

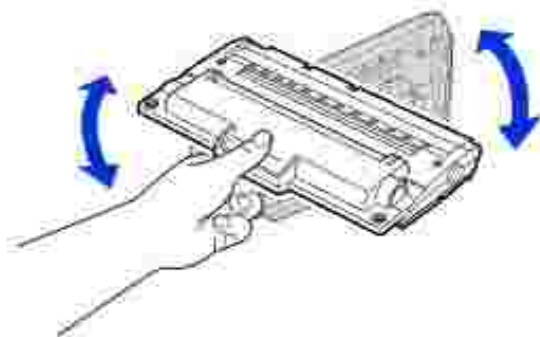

NOTE: If toner comes into contact with your clothing, wipe the toner off with a dry cloth and wash your clothing in cold water. Hot water sets toner into fabric.



CAUTION: Do not touch the green underside of the toner cartridge. Use the handle on the cartridge to avoid touching this area.

3. Reinstall the cartridge and close the front cover.

Replacing the Toner Cartridge

When the toner eventually runs out, only blank pages print when a print job or copy job are sent. In that case the incoming faxes are only saved in the memory and not printed. At this stage, the toner cartridge needs to be replaced.

 **NOTE:** The Dell Laser Multi-Function Printer 1600n can print received faxes when the toner is empty. For more information, see [page 159](#).

Order an extra toner cartridge so you will have it on hand when the current cartridge no longer prints satisfactorily. See [page 160](#) to order toner cartridges.

 **CAUTION:** For best results, use Dell toner cartridges. Print quality and printer reliability are not guaranteed if you do not use Dell supplies.

To replace the toner cartridge:

1. Open the front cover.

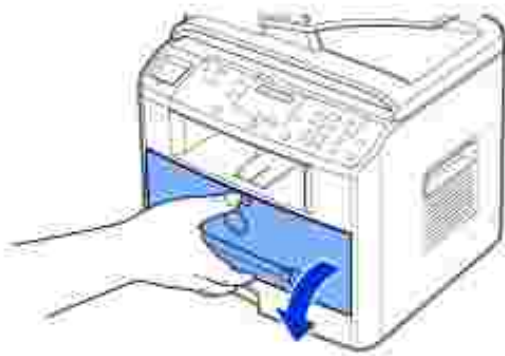

2. Lightly pull the used cartridge straight out.

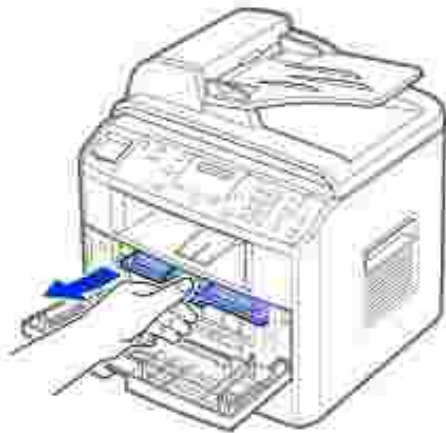

3. Unpack the new toner cartridge and hold the toner cartridge by the handle and gently shake it from side-to-side to distribute the toner.

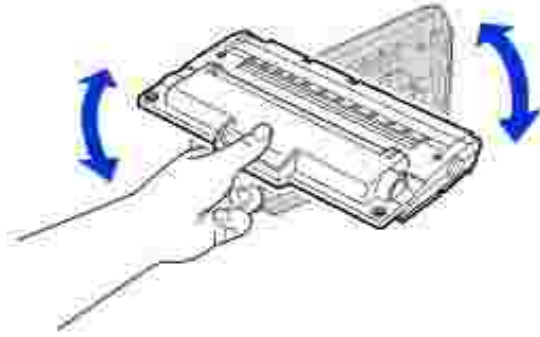

Save the box and the cover for shipping.

 **NOTE:** If toner comes into contact with your clothing, wipe the toner off with a dry cloth and wash your clothing in cold water. Hot water sets toner into fabric.

 **CAUTION:** Do not touch the green underside of the toner cartridge. Use the handle on the cartridge to avoid touching this area.

4. Align the toner cartridge with the labeled arrows, then slide it into the multifunction printer until it locks firmly into place.

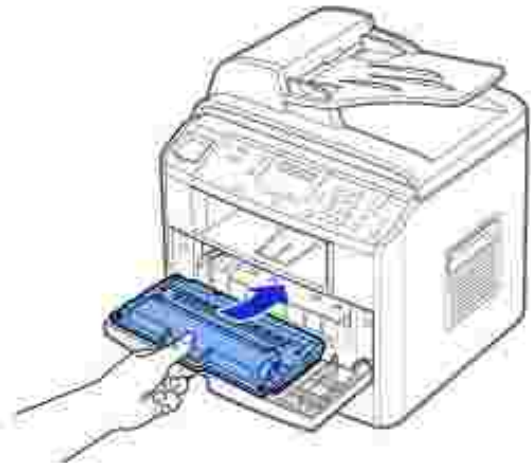

5. Close the front cover.

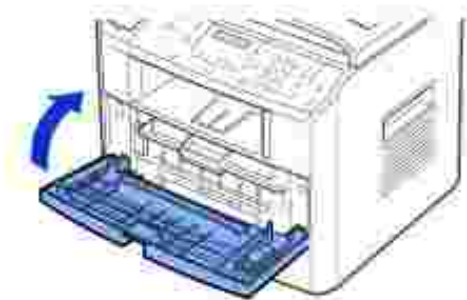

Cleaning the Drum

If there are streaks or spots on your print, the Organic Photo Conductor (OPC) drum of the toner cartridge may require cleaning.

1. Before setting the cleaning procedure, make sure that paper is loaded in the paper tray.
2. Press <Menu> on the operator panel until "Maintenance" appears on the top line of the display.

The first available menu item, "Clean Drum", displays on the bottom line.

3. Press <Select> twice.

The display confirms your selection.

The multi-function printer prints out a cleaning page. Toner particles on the drum surface are affixed to the paper.

4. *If the problem remains*, repeat steps 1 through 3 until toner particles are not affixed to the paper.

Printing When Toner is Low

When the toner cartridge is nearly empty, the multi-function printer saves the incoming faxes in the memory without printing them. If you want to print the fax when toner is low, you can set the multi-function printer to continue printing even though the print quality is not as good.

1. Press <Menu> until "Fax Feature" appears on the display.
2. Press the scroll button (◀ or ▶) until "Ignore Toner" appears on the bottom line and press <Select>.
3. Press the Scroll button (◀ or ▶) to select "On" or "Off".

Select "On" to continue printing the incoming faxes in the toner low status.

Select "Off" to stop printing when the toner cartridge is nearly empty. This is the default setting.

4. Press <Select> to save the selection.

Ordering Supplies

You can order supplies using the Dell™ Toner Management System or the Dell Printer Configuration Web Tool.

If your multi-function printer is connected to a network, type your printer's IP address in your Web browser or open the Network Status Monitor Center (see [page 43](#)) to launch the Dell Printer Configuration Web Tool and click the toner supplies link.

1. Double-click the Dell Toner Reorder Program icon on your desktop.



OR

2. From the Start menu, click Programs → Dell → Dell Printers → Dell Laser MFP 1600n → Dell Toner Reorder Program.

The Order Toner Cartridges window appears.

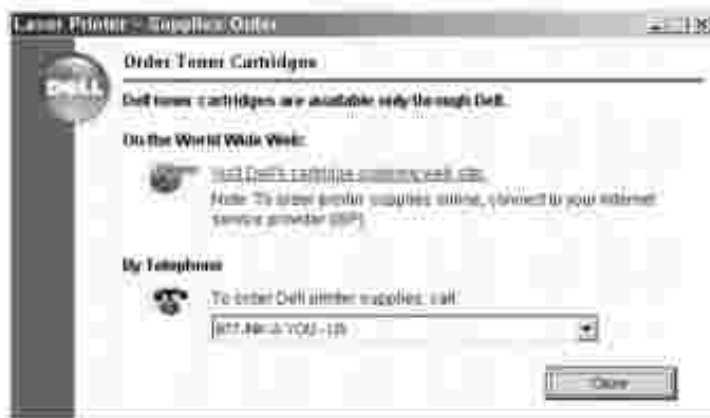

Go to www.dell.com/supplies to order supplies online.

If ordering by phone, call the number that appears under the By Telephone heading.

OR

3. If your multi-function printer is connected to a network, type the printer's IP address in your Web browser to launch the Dell Printer Configuration Web Tool, and click the supplies link.

Troubleshooting

- [Clearing Jams in the ADF](#)
 - [Clearing Jams in the Paper Tray](#)
 - [Clearing LCD Error Messages](#)
 - [Solving Problems](#)
-

Clearing Jams in the ADF

When a document jams while it passes through the Automatic Document Feeder (ADF), "Document Jam" appears on the display.

 **NOTE:** To prevent document jams, use the scanner glass for thick, thin or mixed documents.

1. Remove the remaining documents from the ADF.

If the document is jammed in the paper feed area:

- a. Open the ADF cover.



- b. Remove the document by gently pulling it straight up.



- c. Close the ADF cover. Then reload the document into the ADF.

If the document is jammed in the paper exit area:

- a. Open the document cover and turn the release knob to remove the misfed documents from the ADF output tray.



- b. Close the document cover. Then load the documents back into the ADF.

2. If you cannot see the paper or the paper does not move when you pulled, open the document cover.
3. Turn the release knob so that you can easily seize the misfed document, and remove the document from the roller or the feed area by carefully pulling it gently to the right.



4. Close the document cover. Then load the documents back into the ADF.

Clearing Jams in the Paper Tray

When a paper jam occurs, "Paper Jam" appears on the display. Refer to the table below to locate and clear the paper jam.

Operator Panel Message	Location of Jam	Go to
[Paper Jam 0] Open/Close Door	Paper Feed Jam (Tray 1) Paper Feed Jam (optional Tray 2)	Image below. page 169.
[Paper Jam 1] Open/Close Door	Paper Exit Jam	page 166.
[Paper Jam 2] Check Inside	Fuser Area Jam	page 167.
[Manual F. Jam]	Manual Feeder Jam	page 169.

To avoid tearing the paper, pull the jammed paper out gently and slowly. Follow the steps below to clear the jam.

Paper Feed Jam (Tray 1)

1. Open and close the front cover. The jammed paper automatically exits the multi-function printer.

If the paper does not exit, continue to step 2.

2. Pull the paper tray open.



3. Remove the paper by gently pulling it straight out.

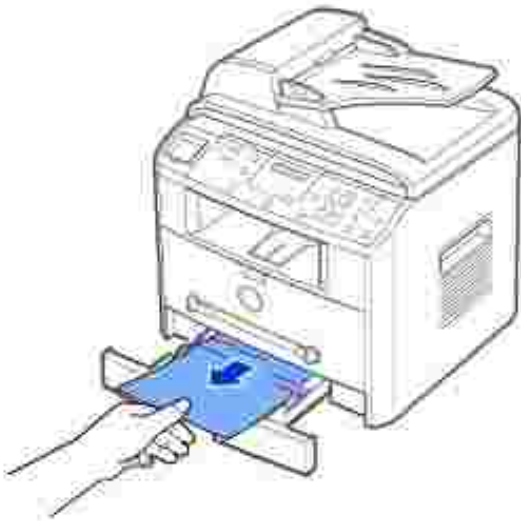

If you cannot see the paper or the paper does not move when pulled, check the fuser area. For more information, see [page 167](#).

4. Insert the paper tray into the multi-function printer until it snaps into place.



5. Open and close the front cover to resume printing.

Paper Exit Jam

1. Open and close the front cover. The jammed paper automatically exits the multi-function printer.

If the paper does not exit, continue to step 2.

2. Gently pull the paper out of the front output tray. Skip to step 6.



3. *If you cannot see the paper in the front output tray or the paper does not move when pulled, open the rear cover.*

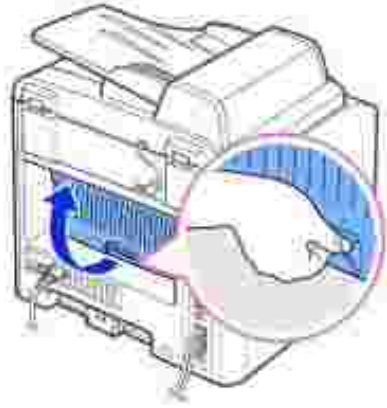

4. Remove the paper by gently pulling it straight out.

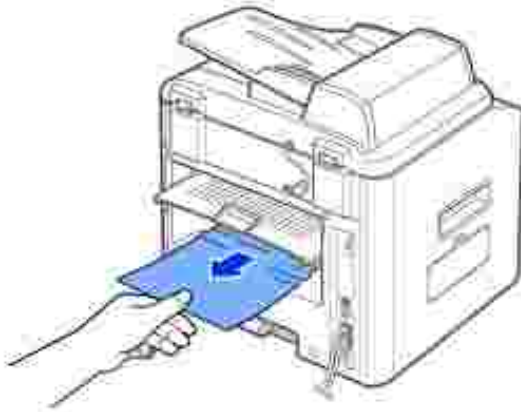

5. Close the rear cover.
6. Open and close the front cover to resume printing.

Fuser Area Jam

 **NOTICE:** The fuser area is hot. Take care when removing paper from the multi-function printer.

1. Open the front cover and lightly pull the toner cartridge straight out.

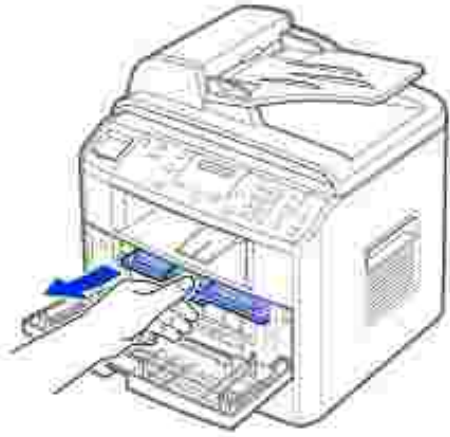

2. Remove the paper by gently pulling it straight out.

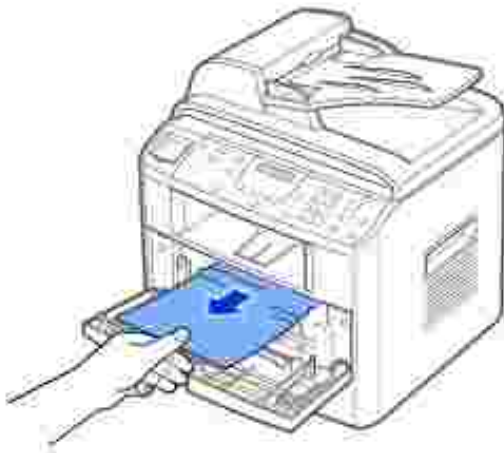

3. Replace the toner cartridge and close the front cover. Printing automatically resumes.



Manual Feeder Jam

"Manual F. Jam" appears on the display when you try to print using the manual feeder and the multi-function printer does not detect paper, due to improper paper loading.

1. Locate the jammed paper in the manual feeder.
2. Gently pull the paper straight out of the multi-function printer.

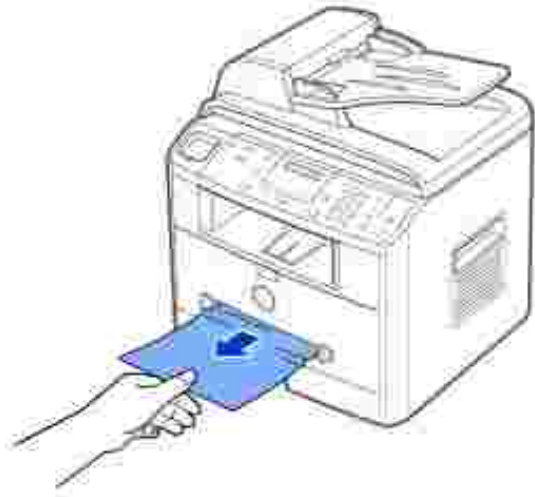

Paper Feed Jam (Optional Tray 2)

1. Pull the optional Tray 2 open.
2. Remove the jammed paper from the multi-function printer.

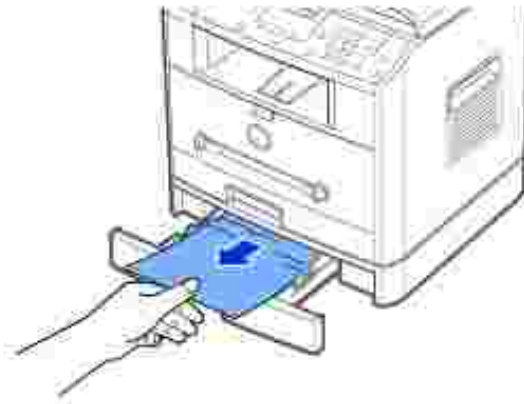

If you cannot see the paper in this area or the paper does not move when pulled, go to step 3.

3. Pull the standard Tray 1 open.

4. Pull the paper straight up and out.



5. Insert Tray 1 into the multi-function printer until it snaps into place.
6. Open and close the front cover to resume printing.

Tips for Avoiding Paper Jams

By selecting the correct paper types, most paper jams can be avoided. When a paper jam occurs, follow the steps outlined in ["Clearing Jams in the Paper Tray" on page 164~170](#).

- Follow the procedures in ["Loading Print Media in the Paper Tray" on page 63](#). Ensure that the adjustable guides are correctly positioned.
- Do not overload the paper tray. Ensure that the paper is below the paper capacity mark on the inside wall of the paper tray.
- Do not remove the paper from the tray while your multi-function printer is printing.
- Flex, fan and straighten the paper before loading.
- Do not use creased, damp or curled paper.
- Do not mix paper types in the paper tray.
- Use only recommended print materials. See ["Paper Specifications" on page 200](#).
- Ensure that the recommended print side of print materials is facing down in the paper tray and facing up in the manual feeder.

Clearing LCD Error Messages

Display	Meaning	Suggested solutions
[Manual F. Jam]	A paper jam has occurred in the manual feeder or the multi-function printer detects improper feeding from the manual feeder.	Clear the paper jam. See page 164 . Load paper in the manual feeder correctly. See page 25 .
Cancel ? 1:Yes 2:No	Your printer's memory is full and cannot store the document to send a fax into its memory.	To cancel the fax job, press the 1 button to accept "Yes." <i>If you want to send the pages that were stored, press the 2 button to accept "No." You should send the remaining pages later when memory is available.</i>
[COMM. Error]	The multi-function printer has a communication problem.	Ask the sender to try again.
CRU Fuse Error	There is a problem in the fuser unit.	Unplug the power cord and plug it back in. <i>If the problem persists, please call for service.</i>
[Low Heat Error]		
Heating Error		
Open Heat Error		
[Over Heat]		
Delayed Function Full	The delayed fax jobs are full.	Cancel the unnecessary delayed fax job. For details, see page 137 .
Document Jam	The loaded document has jammed in the Automatic Document Feeder (ADF).	Clear the document jam. See page 162 .
[Door Open]	The front or rear cover is not securely latched.	Close the cover until it locks into place.
Enter Again	You entered an unavailable item.	Enter the correct item again.
Function Not Available	You have tried to use a combination of printer functions that can not be used at the same time.	Reduce the number of selected functions or use only one function at a time.
Group No. is assigned	The group dial location you tried to select has speed dial numbers assigned to it.	Press <Return> to start over with another group dial location.
Group Not Available	You have tried to select a group location number where only a single location number can be used, such as when adding locations for a broadcasting operation.	Use a speed dial number or dial the number manually using the number keypad.

[Hsync Error]	A problem has occurred in the Laser Scanning Unit (LSU).	Unplug the power cord and plug it back in. <i>If the problem persists</i> , please call for service.
[LSU Error]		
[Jam 1] [No Cartridge]	The toner cartridge is not installed.	Install the toner cartridge. See page 23 .
[Line Error]	Your multi-function printer cannot connect with a remote machine or has lost contact because of a problem with the phone line.	Try again. If the problem persists, please wait for an hour or try a different phone line if possible and then try to connect again. Or, turn the ECM mode on. See page 142 .
Memory Full	The memory is full.	Delete unnecessary documents, retransmit after more memory becomes available or split the transmission into more than one operation.
[No Answer]	The remote fax machine has not answered after several redial attempts.	Try again. Verify the number to make sure a fax can be received.
No. Not Assigned	The speed dial location you tried to use has no number assigned to it.	Dial the number manually using the number keypad or assign the number. See page 128 .
No. Not Available	You have tried to delete the number for the delayed fax job.	Verify the number to be deleted and try again. OR Delete the number after the delayed fax job is sent.
[No Paper] Add Paper	The paper in the paper tray has run out.	Load paper in the paper tray. See page 25 .
No Job Found	You are performing an Add/Cancel operation, but there are no jobs waiting.	Check the display to see if there are any scheduled jobs. The display should indicate if any scheduled jobs are in Standby mode, for example, Delay Fax.
[Paper Jam 0] Open/Close Door	Paper has jammed in the feeding area of the paper tray.	Clear the jam. See page 164 .
[Paper Jam 1] Open/Close Door	Paper has jammed in the paper exit area.	Clear the jam. See page 166 .

[Paper Jam 2] Check Inside	Paper has jammed in the fuser area.	Clear the jam. See page 167 .
Power Failure	The power has been turned off and then on and the printer's memory has not been saved.	The printer's memory was not saved due to a power failure. The job will need to be started over.
Registered	The group dial location is already registered with another speed dial number.	Select another group dial location.
Retry Redial?	The multi-function printer is waiting for a specified time interval to redial a previously busy station.	You can press <Select> to immediately redial, or <Cancel> to cancel the redial operation.
[Toner Low]	The toner is almost empty.	Take out the toner cartridge and gently shake it. By doing this, you can temporarily reestablish printing operations. OR Replace the toner cartridge with a new one for the best print quality. See page 157 .
[Toner Empty] Replace Toner	The toner cartridge is empty.	Replace the toner cartridge with a new one.

Solving Problems

The following chart lists some conditions that may occur and the recommended solutions. Follow the suggested solutions until the problem is corrected. *If the problem persists*, contact Dell.

Paper Feeding Problems

Condition	Suggested solutions
Paper is jammed during printing.	Clear the paper jam. See page 164 .
Paper sticks together.	<ul style="list-style-type: none"> • Ensure that there is not too much paper in the paper tray. The paper tray can hold up to 250 sheets of paper, depending on the thickness of your paper. • Make sure that you are using the correct type of paper. See "Paper Specifications" on page 200. • Remove paper from the paper tray and flex or fan the paper. • Humid conditions may cause some paper to stick together.
Multiple sheets of paper do not feed.	<ul style="list-style-type: none"> • Different types of paper may be stacked in the paper tray. Load paper of only one type, size and weight. • <i>If multiple sheets have caused a paper jam</i>, clear the paper jam. See page 164.
Paper does not feed into the multi-function printer.	<ul style="list-style-type: none"> • Remove any obstructions from inside the printer. See page 164. • Paper has not been loaded correctly. Remove paper from the tray and reload it correctly. • There is too much paper in the paper tray. Remove excess paper from the tray. • The paper is too thick. Use only paper that meets the specifications required by the multi-function printer. See "Paper Specifications" on page 200.
The paper keeps jamming.	<ul style="list-style-type: none"> • Make sure that the correct Paper size is selected. See page 66. • An incorrect type of paper is being used. Use only paper that meets the specifications required by the multi-function printer. See "Paper Specifications" on page 200. • There may be debris inside the multi-function printer. Open the front cover and remove the debris.
Transparencies stick together in the paper exit.	Use only the transparencies specifically designed for a laser printer. Remove each transparency as it exits from the multi-function printer.
Envelopes skew or fail to feed correctly.	Ensure that the paper guides are against both sides of the envelopes.

Printing Problems



Condition	Possible cause	Suggested solutions
The multi-function printer does not print.	The multi-function printer is not receiving power.	Check the power cord connections. Check the power switch and the power source.
	The multi-function printer is not selected as the default printer.	Select Dell Laser MFP 1600n as your default printer in your Windows.
	Check the multi-function printer for the following:	<ul style="list-style-type: none"> • The front or rear cover is not closed. • Paper is jammed. • No paper is loaded.

		<ul style="list-style-type: none"> The toner cartridge is not installed. <p><i>If a printer system error occurs, contact your service representative.</i></p>
	The connection cable between the computer and the multi-function printer is not connected properly.	Disconnect the printer cable and reconnect it.
	The connection cable between the computer and the multi-function printer is defective.	<i>If possible, attach the cable to another computer that is working properly and print a job. You can also try using a different printer cable.</i>
	The multi-function printer may be configured incorrectly.	Check the printer properties to ensure that all of the print settings are correct.
	The printer driver may be incorrectly installed.	Remove the printer driver and then reinstall it; see page 42 and page 36 respectively.
	The multi-function printer is malfunctioning.	Check the display message on the operator panel to see if the machine is indicating a system error.
The multi-function printer selects print materials from the wrong paper source.	The paper source selection in the printer properties may be incorrect.	For many software applications, the paper source selection is found under the Paper tab within the printer properties. Select the correct paper source. See page 75 .
A print job is extremely slow.	The job may be very complex.	Reduce the complexity of the page or try adjusting the print quality settings. The maximum print speed of your multi-function printer is 17 PPM for Letter-sized paper.
	If you are using Windows 98/Me, the Spooling Setting may be set incorrectly.	Click the Start button → Settings → Printers. Right-click the Dell Laser MFP 1600n printer icon, click Properties → Details → Spool Settings. Select the desired spool setting.
Half the page is blank.	The page orientation setting may be incorrect.	Change the page orientation in your application. See page 74 .
	The paper size and the paper size settings do not match.	Ensure that the paper size in the printer driver settings matches the paper in the tray.
The multi-function printer prints, but the text is wrong, garbled, or incomplete.	The printer cable is loose or defective.	Disconnect the printer cable and reconnect. Try a print job that you have already printed successfully. <i>If possible, attach the cable and the printer to another computer and try a print job that you know works. Finally, try a new printer cable.</i>
	The wrong printer driver was selected.	Check the application's printer selection menu to ensure that your printer is selected.
	The software application is malfunctioning.	Try printing a job from another application.

	The operating system is malfunctioning.	Exit Windows and reboot the computer. Power the multi-function printer off and then back on again.
Pages print, but are blank.	The toner cartridge is defective or out of toner.	Gently shake the toner. if necessary. See page 156 . <i>If necessary</i> , replace the toner cartridge.
	The file may have blank pages.	Check the file to ensure that it does not contain blank pages.
	Some parts, such as the controller or the board, may be defective.	Contact a service representative.
The illustrations print incorrectly in Adobe Illustrator.	The setting in the software application is wrong.	Print the document by selecting Download as Bit Image in the Advanced Options window of the Graphic properties.



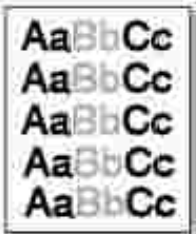

Printing Quality Problems

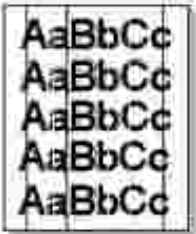
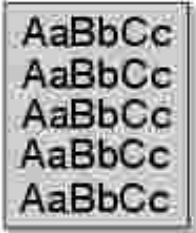
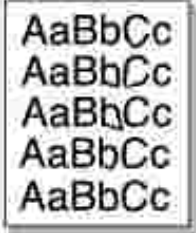
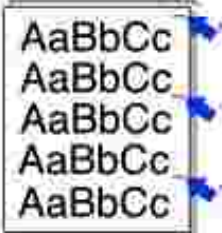
The inside of the multi-function printer may be dirty or improper paper loading may reduce the print quality. See the table below to clear the problem.

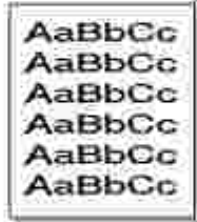
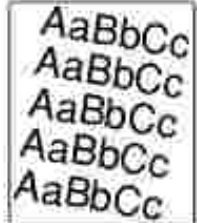
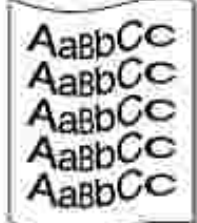
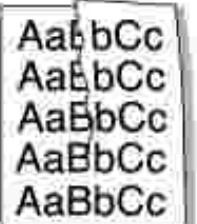
Condition	Suggested solutions
Light or faded print 	If a vertical white streak or faded area appears on the page: <ul style="list-style-type: none"> • The toner supply is low. You may be able to temporarily extend the toner cartridge life. See page 156. <i>If this does not improve the print quality</i>, install a new toner cartridge. • The paper may not meet paper specifications; for example, the paper is too moist or too rough. See "Paper Specifications" on page 200. • If the entire page is light, the print resolution setting is too low or the toner save mode is on. Adjust the print resolution and turn the toner save mode off. See page 77. • A combination of faded or smeared defects may indicate that the toner cartridge needs cleaning. See "Paper Specifications" on page 200.
Toner specks 	<ul style="list-style-type: none"> • The paper may not meet specifications; for example, the paper is too moist or too rough. See "Paper Specifications" on page 200. • The transfer roller may be dirty. Clean the inside of your multi-function printer. See page 153. • The paper path may need cleaning. See "Cleaning the Drum" on page 159.
Dropouts	If faded areas, generally rounded, occur randomly on the page:

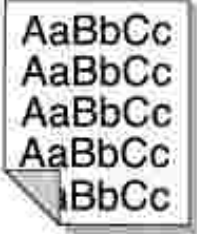
	<ul style="list-style-type: none"> • A single sheet of paper may be defective. Try reprinting the job. • The moisture content of the paper is uneven or the paper has moist spots on its surface. Try a different brand of paper. See "Paper Specifications" on page 200. • The paper lot is bad. The manufacturing process can cause some areas to reject toner. Try a different kind or brand of paper. • The toner cartridge may be defective. Vertical repetitive defects on the next page. • <i>If these steps do not correct the problems</i>, contact a service representative.
<p>Vertical lines</p> 	<p>If black vertical streaks appear on the page, the drum inside the toner cartridge has probably been scratched. Install a new toner cartridge. See "Installing the Toner Cartridge" on page 23.</p>
<p>Gray background</p> 	<p>If the amount of background shading becomes unacceptable:</p> <ul style="list-style-type: none"> • Change to lighter weight pages. See "Paper Specifications" on page 200. • Check the printer's environment; very dry (low humidity) or high humidity (higher than 80% RH) conditions can increase the amount of background shading. • Remove the old toner cartridge and install a new one. See "Installing the Toner Cartridge" on page 23.
<p>Toner smear</p> 	<ul style="list-style-type: none"> • Clean the inside of the multi-function printer. See page 153. • Check the paper type and quality. See "Paper Specifications" on page 200. • Remove the toner cartridge and install a new one. See "Installing the Toner Cartridge" on page 23.
<p>Vertical repetitive defects</p> 	<p>If marks repeatedly appear on the printed side of the page at even intervals:</p> <ul style="list-style-type: none"> • The toner cartridge may be damaged. <i>If a repetitive mark occurs on the page</i>, print a cleaning sheet several times to clean the cartridge; see "Cleaning the Drum" on page 159. After the printout, if you still have the same problems, install a new toner cartridge. See "Installing the Toner Cartridge" on page 23. • Parts of the multi-function printer may have toner on them. If the defects occur on the back of the page, the problem will likely correct itself after a few more pages. • The fusing assembly may be damaged. Contact a service representative.
<p>Background scatter</p>	<p>Background scatter results from bits of toner distributed on the printed</p>

	<p>page.</p> <ul style="list-style-type: none"> • The paper may be too damp. Try printing with a different batch of paper. Do not open packages of paper until necessary so that the paper does not absorb too much moisture. • <i>If background scatter occurs on an envelope</i>, change the printing layout to avoid printing over areas that have overlapping seams on the reverse side. Printing on seams can cause problems. • <i>If background scatter covers the entire surface area of a printed page</i>, adjust the print resolution through your software application or the printer properties.
<p>Misformed characters</p> 	<ul style="list-style-type: none"> • If characters are improperly formed and produce hollow images, the paper stock may be too slick. Try a different paper. See "Paper Specifications" on page 200. • If characters are improperly formed and produce a wavy effect, the scanner unit may need service. For service, contact a service representative.
<p>Page skew</p> 	<ul style="list-style-type: none"> • Ensure that the paper is loaded properly. • Check the paper type and quality. See "Paper Specifications" on page 200. • Ensure that the paper or other material is loaded correctly and the guides are not too tight or too loose against the paper stack.
<p>Curl or wave</p> 	<ul style="list-style-type: none"> • Ensure that the paper is loaded properly. • Check the paper type and quality. Both high temperatures and humidity can cause paper curl. See "Paper Specifications" on page 200. • Turn over the stack of paper in the paper tray. Also try rotating the paper 180° in the paper tray.
<p>Wrinkles or creases</p> 	<ul style="list-style-type: none"> • Ensure that the paper is loaded properly. • Check the paper type and quality. See "Paper Specifications" on page 200. • Turn over the stack of paper in the paper tray. Also try rotating the paper 180° in the paper tray.
<p>Back of printouts are</p>	<p>Check for leaks in the toner. Clean the inside of the multi-function</p>

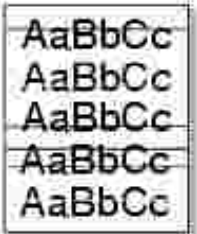
<p>dirty</p> 	<p>printer. See page 153.</p>
<p>Black pages</p> 	<ul style="list-style-type: none"> • The toner cartridge may not be installed properly. Remove the cartridge and reinsert. • The toner cartridge may be defective and need replacing. Install a new toner cartridge. See "Installing the Toner Cartridge" on page 23. • The multi-function printer may require repair. Contact a service representative.
<p>Loose toner</p> 	<ul style="list-style-type: none"> • Clean the inside of the multi-function printer. See page 153. • Check the paper type and quality. See "Paper Specifications" on page 200. • Install a new toner cartridge. See "Installing the Toner Cartridge" on page 23. • If the problem persists, the multi-function printer may require repair. Contact a service representative.
<p>Character Voids</p> 	<p>Character voids have white areas where they should be solid black:</p> <ul style="list-style-type: none"> • <i>If you are using transparencies</i>, try another type of transparency. Because of the composition of the transparency, some character voids are normal. • You may be printing on the wrong surface of the paper. Turn over the stack of paper in the paper tray. • The paper may not meet paper specifications. See "Paper Specifications" on page 200.
<p>Horizontal stripes</p> 	<p>If horizontally aligned black streaks or smears appear:</p> <ul style="list-style-type: none"> • The toner cartridge may be installed improperly. Remove the toner cartridge and reinsert. • The toner cartridge may be defective. Install a new toner cartridge. See "Installing the Toner Cartridge" on page 23. • If the problem persists, the multi-function printer may require repair. Contact a service representative.

Curl

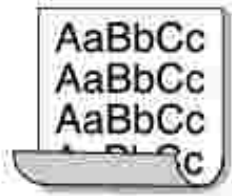

If the printed paper is curled or the paper does not feed into the multi-function printer, turn over the stack of paper in the paper tray. Also try rotating the paper 180° in the paper tray.

Fax Problems

Condition	Suggested solutions
The multi-function printer is not working, there is no display and the buttons are not working.	<ul style="list-style-type: none">• Unplug the power cord and plug it in again.• Ensure that there is power to the electrical receptacle.
No dial tone sounds.	<ul style="list-style-type: none">• Check that the phone line is connected properly. See page 29.• Check that the phone socket in the wall is working by plugging in another phone.
The numbers stored in the memory do not dial correctly.	Make sure that the numbers are stored in the memory correctly. Print a Phonebook list, referring to page 133 .
The document does not feed into the multi-function printer.	<ul style="list-style-type: none">• Make sure that the document is not wrinkled and you are putting it in correctly. Check that the document is the right size, not too thick or thin.• Make sure that the Automatic Document Feeder (ADF) cover is firmly closed.
Faxes are not received automatically.	<ul style="list-style-type: none">• The FAX mode should be selected.• Make sure that there is paper in the paper tray.• Check to see if the display shows "Memory Full".
The multi-function printer does not send.	<ul style="list-style-type: none">• Make sure that the document is loaded in the ADF or on the scanner glass.• "Sending" should show up on the display.• Check the other fax machine you are sending to, to see if it can receive your fax.
The incoming fax has blank spaces or is received in poor-quality.	<ul style="list-style-type: none">• The fax machine sending you the fax may be faulty.• A noisy phone line can cause line errors.• Check your multi-function printer by making a copy.• The toner cartridge may be empty. Replace the toner cartridge, referring to page 157.
Some of the words on an incoming fax are stretched.	The fax machine sending you the fax had a temporary document jam.
There are lines on the documents you send.	Check your scan glass for marks and clean it. See page 154 .

The multi-function printer dials a number, but the connection with another fax machine fails.	The other fax machine may be turned off, out of paper, or cannot answer incoming calls. Speak with the other machine operator and ask her/him to sort out the problem.
Documents are not stored in the memory.	There may not be enough memory to store the document. <i>If the display shows a "Memory Full" message</i> , delete any documents you no longer need from the memory and then restore the document.
Blank areas appear at the bottom of each page or on other pages, with a small strip of text at the top.	You may have chosen the wrong paper settings in the user option setting. See page 66 and page 67 .

Copying Problems

Condition	Suggested solutions
Copies are too light or too dark.	Use the <Contrast> button to darken or lighten the background of the copies.
Smears, lines, marks or spots appear on copies.	<ul style="list-style-type: none"> • <i>If defects are on the original</i>, press the <Contrast> button to lighten the background of your copies. • <i>If no defects are on the original</i>, clean the scanner glass and underside of the document cover. See page 154.
Copy image is skewed.	<ul style="list-style-type: none"> • Ensure that the original is positioned correctly on scanner glass. • Check that the copy paper is loaded correctly.
Blank copies print out.	Ensure that the original is face down on the scanner glass or face up in the Automatic Document Feeder.
Image rubs off the copy easily.	<ul style="list-style-type: none"> • Replace the paper in the paper tray with paper from a new package. • In high humidity areas, do not leave paper in the multi-function printer for the extended periods of time.
Frequent copy paper jams occurs.	<ul style="list-style-type: none"> • Fan the stack of paper, then turn it over in the paper tray. Replace the paper in the tray with a fresh supply. <i>If necessary</i>, check/adjust the paper guides. • Ensure that the paper is the proper paper weight. 75 g/m² (20 lb) bond paper is recommended. • Check for copy paper or pieces of copy paper remaining in the multi-function printer after a paper jam has been cleared.
Fewer copies from the toner cartridge than expected prints out.	<ul style="list-style-type: none"> • Your originals may contain pictures, solids or heavy lines. For example, your originals may be forms, newsletters, books or other documents that use more toner. • The multi-function printer may frequently be powered on and off. • The document cover may be left open while copies are being made.

Scanning Problems

Condition	Suggested solutions
The scanner does not work.	<ul style="list-style-type: none"> • Make sure that you place the document to be scanned face down from the scanner glass, or face up in the Automatic Document Feeder. • There may not be enough available memory to hold the document you want to scan. Try the Prescan function to see if that works. Try lowering the scan resolution rate. • Check that the USB cable is connected properly. • Make sure that the USB cable is not defective. Switch the cable with a known good cable. <i>If necessary</i>, replace the cable. • Check that the scanner is configured correctly. Check the application you want to use to make certain that the scanner job is being sent to the correct port.
The unit scans very slowly.	<ul style="list-style-type: none"> • Check if the multi-function printer is printing received data. Scan the document after the current job is completed. • Graphics are scanned more slowly than text. • Communication speed becomes slow in scan mode because of the large amount of memory required to analyze and reproduce the scanned image.
<p>Message appears on your computer screen:</p> <ul style="list-style-type: none"> • "Device can't be set to the H/W mode you want." • "Port is being used by another program." • "Port is Disabled." • "Scanner is busy receiving or printing data. When the current job is completed, try again." • "Invalid handle." • "Scanning has failed." 	<ul style="list-style-type: none"> • There may be a copying or printing job in progress. When the current job is complete, try the job again. • The Selected port is currently being used. Restart your computer and try again. • The printer cable may be improperly connected or the power may be off. • The scanner driver is not installed or an operating environment is not set up properly. • Ensure that the port is properly connected and the power is turned on. Then restart your computer. • Check that the USB cable is properly connected.

Troubleshooting Postscript (PS) Errors

The following situations are PS language specific and may occur when several printer languages are being used.



NOTE: To receive a printed or screen displayed message when PS errors occur, open the Print Options window and click the desired selection next to the PostScript errors section.

Problem	Possible Cause	Solution
PostScript file can not be printed.	The PostScript option may not be installed.	Print a configuration page and verify that the PS version is available for printing.
"This job contains binary data..." message appears.	The pure binary data option is not supported by the PostScript driver.	Open the Properties of the PostScript driver, click on PostScript, and click on Advanced. The pure binary data option is not supported. Choose another.
A PS error page prints.	Print job may not be PS.	Make sure that the print job is a PS job. Check to see whether the software application expected a setup or PS header file to be sent to the multi-function printer.
The optional Tray 2 is not selected in the driver.	The printer driver has not been configured to recognize the optional Tray 2.	Open the PostScript driver properties and set the Option Tray item of the Device option to Installed.

Installing Options

- [Precautions When Installing Printer Options](#)
 - [Installing Printer Memory](#)
 - [Installing an Optional Tray 2](#)
-

Precautions When Installing Printer Options

Never remove the control board while the printer is plugged in.

To avoid the possibility of an electrical shock, always disconnect the power cord when installing or removing ANY internal or external printer option.

The control board and internal printer memory are sensitive to static electricity. Before installing or removing an internal printer memory, discharge static electricity from your body by touching something metal on any device plugged into a grounded power source. *If you walk around before finishing installation*, discharge any static electricity once again.

Installing Printer Memory

Additional printer memory is provided on a Dual In-line Memory Module (DIMM).

 **NOTE:** Your multifunction printer supports only Dell DIMMs. Order Dell DIMMs online at www.dell.com.

1. Power the multi-function printer off and unplug all cables from the multi-function printer.
2. To remove the control board cover, pull out gently, as shown.

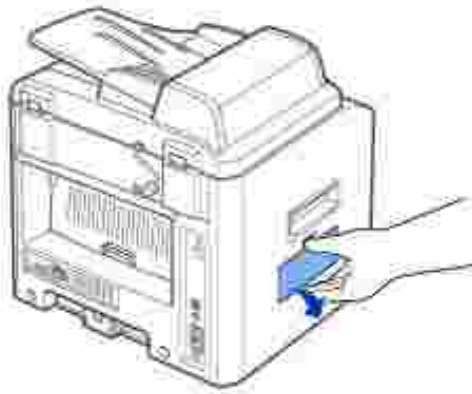

3. Open the lever on each side of the DIMM slots completely.

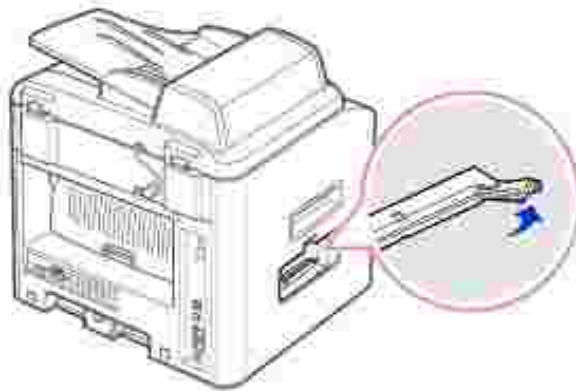

4. Remove the memory DIMM from the antistatic package. Locate the alignment notches on the bottom edge of the DIMM.

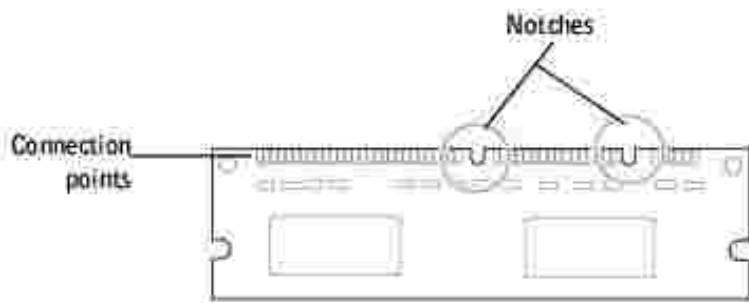

 **NOTE:** Avoid touching the connection points along the edge of the memory.

5. Hold the memory DIMM. Align the notches on the DIMM with the notches at the top of the DIMM slot.

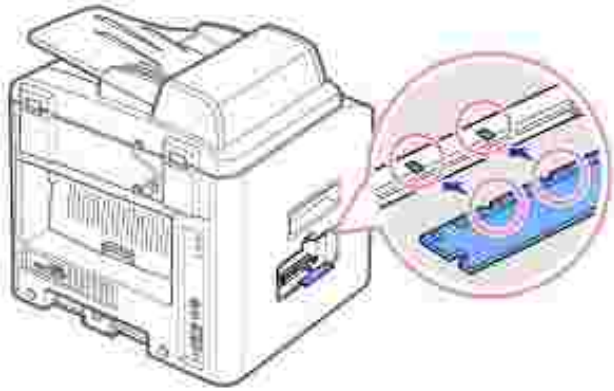

6. Insert the ends of the memory DIMM into the slot on the levers.

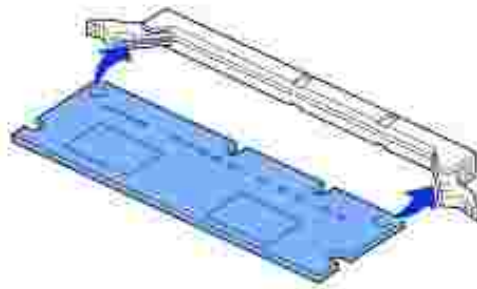

7. Push the memory DIMM firmly in to make sure you fully insert it into the slot.

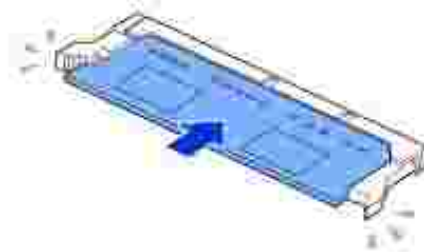

8. Replace the control board cover, as shown.

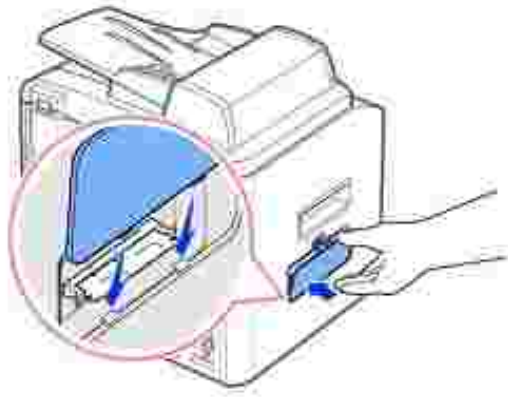

9. Reconnect the power cord and printer cable, and power the multi-function printer on.

Removing the Memory

1. Follow steps 1 and 2 on [page 188](#) to access the control board.
2. Push the levers at both ends of the DIMM slot away from the DIMM.

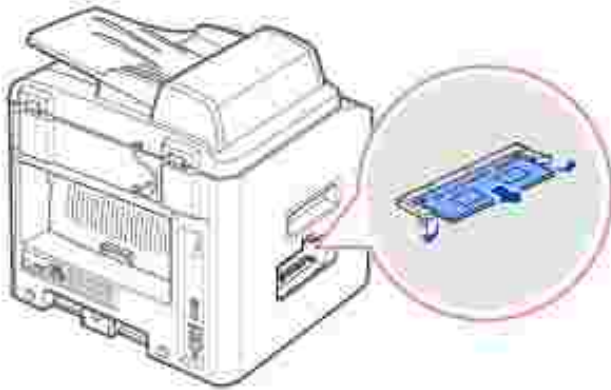

3. Place the DIMM in its original packaging or wrap it with paper and store it in a box.
4. Follow from step 8 on [page 190](#).

Installing an Optional Tray 2

You can increase the paper handling capacity of your multi-function printer by installing an optional Tray 2. This tray holds 250 sheets of paper.

1. Power the multi-function printer off and unplug all cables from the multi-function printer.
2. Remove the packing tape and the tape fastening the interface cable from the bottom of the optional Tray2.



3. Find the location of the connector and the optional tray positioners.

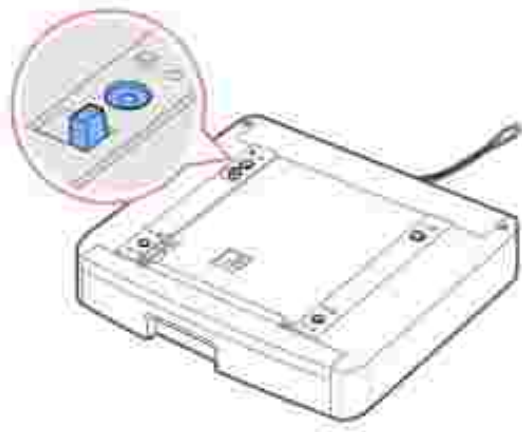

4. Place the multi-function printer over the tray, aligning the feet on the multi-function printer with the positioners in the optional Tray2.

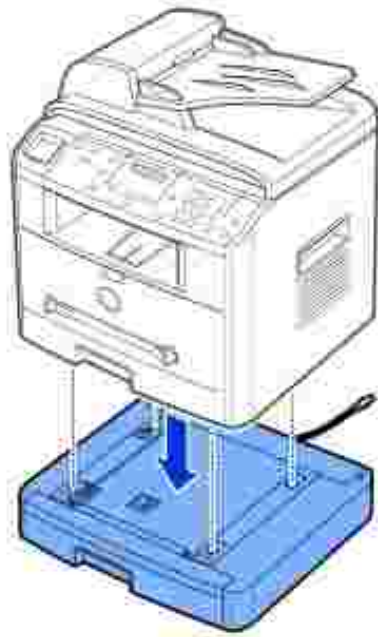

5. Connect the cable into the connector on the back of the multi-function printer.

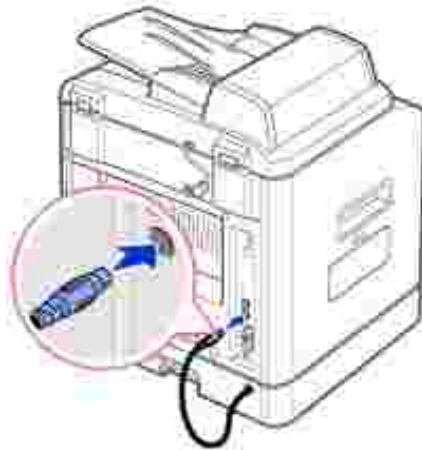

6. Load paper in the optional Tray 2. For information about loading paper in this tray, see [page 25](#).
7. Reconnect the power cord and cables and then power the multi-function printer on.

When you print a document on paper loaded in the optional Tray 2, you must configure the properties of the printer driver.

To access the properties of the printer driver:

1. Click the Windows Start button.

2. For Windows 98/Me/NT 4.0/2000, click Settings and point to Printers.

For Windows XP/Server 2003, click Printers and Faxes.

3. Click the Dell Laser MFP 1600n printer.

4. Right-click the printer icon and:

In Windows 98/Me, click Properties.

In Windows 2000/XP/Server 2003, click Print Setup or click Properties and then point to Printing Preferences.

In Windows NT 4.0, click Document Default.

5. Click the Printer tab, and select Tray 2 from the Optional Tray drop-down list.



6. Click OK and print the document.

Specifications

- [General Specifications](#)
 - [Multi-Function Printer Specifications](#)
 - [Facsimile Specifications](#)
 - [Paper Specifications](#)
-

General Specifications

Item	Description
Automatic document feeder	Up to 50 sheets (20 lb, 75 g/m ²)
ADF Document size	Width: 5.6-8.5 in. (142-216 mm) Length: 5.8-14 in. (148-356 mm)
Paper input capacity	Paper tray: 250 sheets (weight: 16-24 lb) Manual feeder: 1 sheet (weight: 16-43 lb)
Paper output capacity	Front output tray: 150 sheets (face down) Rear output slot: 1 sheet (face up)
Paper type	Paper tray: Plain paper (60-90 g/m ² , 16- 24 lb) Manual feeder: Plain paper, Transparencies, Labels, Card, Post card (60-163 g/m ²) Envelopes (60-120 g/m ² , 16-32 lb)
Consumables	1-piece toner cartridge system
Power requirements	110-127 VAC, 50/60 Hz, 5.0A 220-240 VAC, 50/60 Hz, 2.6A
Power consumption	30 W
Noise	Copy: 55 dBA Standby mode: 33 dBA Printing: 54 dBA
Warm-up Time	Less than 42 seconds
Operating conditions	Temperature: 50°F-89°F (10°C-32°C) Humidity: 20%-80% RH

LCD	16 characters x 2 lines
Toner cartridge life	5,000 or 3,000 pages @ ISO 5% coverage
Multi-function printer dimension (W x D x H)	17.7 x 16.7 x 18 in. (450 x 423 x 456 mm)
Random Access Memory (RAM)	Standard 32 MB Expandable to 160 MB: SDRAM
Weight	Net: 15.6 Kg (including toner cartridge), 14.8 Kg (except toner cartridge) Gross: 20.4 Kg (including consumables, accessories and package)
Package Weight	Paper: 2.7 Kg Plastic: 0.7 Kg

Multi-Function Printer Specifications

Item	Description
Printing method	Laser Beam Printing
Printing speed	Letter: 22 ppm (pages per minute) A4: 20 pages per minute
Paper size	Paper tray: Letter, A4, Legal, Folio, A5, A6 Manual feeder: Letter, Legal, A4, Folio, Executive, A5, A6, A6 card, Post Card 4x6, HagaKi, Envelope 7-3/4, Envelope 9, Envelope 10, Envelope COM-10, Envelope DL, Envelope C5, Envelope C6, Envelope B5, JIS B5, ISO B5 * Min.: 3 x 5 in. (76 x 127 mm) Max.: 8.5 x 14 in. (216 x 356 mm)
Print resolution	600 x 600 dpi (1200 x 1200 dpi)
Emulation	GDI, PC6, PCL5e, PostScript Level3
PC Interface	USB 2.0
Network Interface	10/100 Base TX
Compatibility	Windows 98/2000/NT 4.0/Me/XP/Server 2003
First printing time	Standby mode: 10 seconds Power save mode: 50 seconds

Facsimile Specifications

Item	Description
Compatibility	ITU-T Group 3
Applicable line	Public Switched Telephone Network (PSTN) or behind PABX
Data coding	MH/MR/MMR (ECM Mode) and JPEG for color fax transmission
Modem speed	33.6 Kbps
Transmission speed	Approx. 3 seconds/page * Transmission time applies to memory transmission of text data with ECM compression using only ITU-T No.1 Chart.
Scanning speed	Document glass: approx. 3 seconds/A4 (at standard fax resolution mode) ADF: approx. 5 seconds/Letter (at standard fax resolution mode), 7.5 seconds/Letter (at fine fax resolution mode)
Maximum document length	Document glass: 297 mm ADF: 356 mm
Paper size	Letter, A4, Legal
Resolution	Standard: 203 x 98 dpi Fine: 203 x 196 dpi Super Fine: 300 x 300 dpi
User Memory	4 MB (320 pages)
Halftone	256 levels

Paper Specifications

Overview

Your multi-function printer accepts a variety of print materials, such as cut-sheet paper (including up to 100 percent recycled fiber content paper), envelopes, labels, transparencies and custom-size paper. Properties, such as weight, composition, grain and moisture content, are important factors affecting the multi-function printer's performance and the output quality. Paper that does not meet the guidelines outlined in this *User's Guide* can cause the following problems:

- Poor print quality
- Increased paper jams

- Premature wear on the multi-function printer

 **NOTE:** Some paper may meet all of the guidelines in this guide and still not produce satisfactory results. This may be the result of improper handling, unacceptable temperature and humidity levels, or other variables over which Dell has no control.

 **NOTE:** Before purchasing large quantities of paper, insure the paper meets the requirements specified in this *User's Guide*.

 **CAUTION:** Using paper that does not meet these specifications may cause problems, requiring repairs. These repairs are not covered by the Dell warranty or service agreements.

Supported Sizes of Paper

Paper	Dimensions ^a	Weight	Capacity ^b
Letter	8.5 X 11 in. (216 X 279 mm)	<ul style="list-style-type: none"> • 60-90 g/m² bond (16-24 lb) for the paper tray • 60-163 g/m² bond (16-43 lb) for the manual feeder 	<ul style="list-style-type: none"> • 250 sheets of 75 g/m² bond (20 lb) paper for the paper tray • 1 sheet of paper for the manual feeder
A4	8.3 X 11.7 in. (210 X 297 mm)		
Executive	7.25 X 10.5 in. (191 X 267 mm)		
Legal	8.5 X 14 in. (216 X 356 mm)		
Folio	8.5 X 13 in. (216 X 330 mm)		
Minimum size (custom)	3 x 5 in. (76 x 127 mm)	60-120 g/m ² bond (16-32 lb)	1 sheet of paper for the manual feeder
Maximum size (Legal)	8.5 x 14 in. (216 x 356 mm)		
Transparency	Same minimum and maximum paper sizes as listed above.	138-146 g/m ²	
Labels		120-150 g/m ²	
Cards		90-163 g/m ²	
Envelopes		75-90 g/m ²	

- The multi-function printer supports a wide range of media sizes.
- Capacity may vary depending on print materials' weight and thickness, and environmental conditions.

 **NOTE:** You may experience jams when using print materials with a length of less than 127 mm (5 inches). For optimum performance, ensure that you are storing and handling the paper correctly. Please refer to [page 203](#).

Guidelines for Using Paper

For the best result, use conventional 75 g/m² (20 lb) paper. Ensure that the paper is of good quality, and free of cuts, nicks, tears, spots, loose particles, dust, wrinkles, voids, and curled or bent edges.

If you are unsure of what type of paper you are loading, such as bond or recycled paper, check the label on the package.

The following problems may cause print quality deviations, jamming or even damage to the multi-function printer:

Symptom	Problem with paper	Solution
Poor print quality or toner adhesion, problems with feeding	Too moist, too rough, too smooth or embossed; faulty paper lot	Try another kind of paper, between 100-400 Sheffield, 4%-5% moisture content.
Dropout, jamming, curl	Stored improperly	Store paper flat in its moisture-proof wrapping.
Increased gray background shading/printer wear	Too heavy	Use lighter paper, use the rear output slot.
Excessive curl problems with feeding	Too moist, wrong grain direction or short-grain construction	<ul style="list-style-type: none">• Use the rear output slot.• Use long-grain paper.
Jamming, damage to multi-function printer	Cutouts or perforations	Do not use paper with cutouts or perforations.
Problems with feeding	Ragged edges	Use good quality paper.

 **NOTE:** Do not use letterhead paper printed with low-temperature inks, such as those used in some types of thermography.

 **NOTE:** Do not use raised or embossed letterhead.

 **NOTE:** The multi-function printer uses heat and pressure to fuse toner to the paper. Insure that any colored paper or preprinted forms use inks that are compatible with this fusing temperature (200° C or 392° F for 0.1 second).

Paper Specifications

Category	Specifications
Acid Content	5.5 pH or lower
Caliper	0.094-0.18 mm (3.0-7.0 mils)
Curl in Ream	Flat within 0.02 in. (5 mm)
Cut Edge Conditions	Cut with sharp blades with no visible fray.
Fusing Compatibility	Must not scorch, melt, offset or release hazardous emissions when heated to 200°C (392°F) for 0.1 second.
Grain	Long Grain
Moisture Content	4%-6% by weight
Smoothness	100-400 Sheffield

Paper Output Capacity

Output Location	Capacity
Front Output Tray (Face Down)	150 sheets of 75 g/m ² bond (20 lb) paper
Rear Output Slot (Face Up)	1 sheet of 75 g/m ² bond (20 lb) paper

Printer and Paper Storage Environment

Paper storage environmental conditions directly affect the feed operation.

Ideally, the printer and paper storage environment should be at or near room temperature, and not too dry or humid. Remember that paper is hygroscopic; it absorbs and loses moisture rapidly.

Heat works with humidity to damage paper. Heat causes the moisture in paper to evaporate, while cold causes it to condense on the sheets. Heating systems and air conditioners remove most of the humidity from a room. As paper is opened and used, it loses moisture, causing streaks and smudging. Humid weather or water coolers can cause the humidity to increase in a room. As paper is opened and used it absorbs any excess moisture, causing light print and dropouts. Also, as paper loses and gains moisture it can become distorted. This can cause paper jams.

Care should be taken not to purchase more paper than can be used in a short time (about 3 months). Paper stored for long periods may experience heat and moisture extremes, which can cause damage. Planning is important to prevent damage to large supplies of paper.

Unopened paper in sealed reams can remain stable for several months before use. Opened packages of paper have more potential for environment damage, especially if they are not wrapped with a moisture-proof barrier.

The paper storage environment should be properly maintained to ensure optimum performance. The required condition is 20° C to 24° C (68° F to 75° F), with a relative humidity of 4 percent to 55percent. The following guidelines should be considered when evaluating the paper's storage environment:

- Paper should be stored at or near room temperature.
- The air should not be too dry or too humid.
- The best way to store an opened ream of paper is to rewrap it tightly in its moisture-proof wrapping. If the printer environment is subject to extremes, unwrap only the amount of paper to be used during the day's operation to prevent unwanted moisture changes.

Regulatory Notices

Electromagnetic Interference (EMI) is any signal or emission, radiated in free space or conducted along power or signal leads, that endangers the functioning of a radio navigation or other safety service or seriously degrades, obstructs, or repeatedly interrupts a licensed radio communications service. Radio communications services include but are not limited to AM/FM commercial broadcast, television, cellular services, radar, air-traffic control, pager, and Personal Communication Services (PCS). These licensed services, along with unintentional radiators such as digital devices, including computers, contribute to the electromagnetic environment.

Electromagnetic Compatibility (EMC) is the ability of items of electronic equipment to function properly together in the electronic environment. While this computer has been designed and determined to be compliant with regulatory agency limits for EMI, there is no guarantee that interference will not occur in a particular installation. If this equipment does cause interference with radio communications services, which can be determined by turning the equipment off and on, you are encouraged to try to correct the interference by one or more of the following measures:

- Reorient the receiving antenna.
- Relocate the computer with respect to the receiver.
- Move the computer away from the receiver.
- Plug the computer into a different outlet so that the computer and the receiver are on different branch circuits.

If necessary, consult a Dell Technical Support representative or an experienced radio/television technician for additional suggestions.

Dell™ computers are designed, tested, and classified for their intended electromagnetic environment. These electromagnetic environment classifications generally refer to the following harmonized definitions:

- Class A is typically for business or industrial environments.
- Class B is typically for residential environments.

Information Technology Equipment (ITE), including devices, expansion cards, printers, input/output (I/O) devices, monitors, and so on, that are integrated into or connected to the computer should match the electromagnetic environment classification of the computer.

A Notice About Shielded Signal Cables: Use only shielded cables for connecting devices to any Dell device to reduce the possibility of interference with radio communications services. Using shielded cables ensures that you maintain the appropriate EMC classification for the intended environment. For parallel printers, a cable is available from Dell. If you prefer, you can order a cable from Dell on the World Wide Web at accessories.us.dell.com/sna/category.asp?category_id=4117.

Most Dell computers are classified for Class B environments. However, the inclusion of certain options can change the rating of some configurations to Class A. To determine the electromagnetic classification for your computer or device, see the following sections specific for each regulatory agency. Each section provides country-specific EMC/EMI or product safety information.

FCC Notices (U.S. Only)

Most Dell computers are classified by the Federal Communications Commission (FCC) as Class B digital devices. To determine which classification applies to your computer, examine all FCC registration labels located on the bottom, side, or back panel of your computer, on card-mounting brackets, and on the cards themselves. If any one of the labels carries a Class A rating, your entire computer is considered to be a Class A digital device. If *all* labels carry an FCC Class B rating as distinguished by either an FCC ID number or the FCC logo, (), your computer is considered to be a Class B digital device.

Once you have determined your computer's FCC classification, read the appropriate FCC notice. Note that FCC regulations provide that changes or modifications not expressly approved by Dell could void your authority to operate this equipment.

This device complies with Part 15 of the FCC Rules. Operation is subject to the following two conditions:

- This device may not cause harmful interference.
- This device must accept any interference received, including interference that may cause undesired operation.

Class A

This equipment has been tested and found to comply with the limits for a Class A digital device pursuant to Part 15 of the FCC Rules. These limits are designed to provide reasonable protection against harmful interference when the equipment is operated in a commercial environment. This equipment generates, uses, and can radiate radio frequency energy and, if not installed and used in accordance with the manufacturer's instruction manual, may cause harmful interference with radio communications. Operation of this equipment in a residential area is likely to cause harmful interference, in which case you will be required to correct the interference at your own expense.

Class B

This equipment has been tested and found to comply with the limits for a Class B digital device pursuant to Part 15 of the FCC Rules. These limits are designed to provide reasonable protection against harmful interference in a residential installation. This equipment generates, uses, and can radiate radio frequency energy and, if not installed and used in accordance with the manufacturer's instruction manual, may cause interference with radio communications. However, there is no guarantee that interference will not occur in a particular installation. If this equipment does cause harmful interference to radio or television reception, which can be determined by turning the equipment off and on, you are encouraged to try to correct the interference by one or more of the following measures:

- Reorient or relocate the receiving antenna.

- Increase the separation between the equipment and the receiver.
- Connect the equipment into an outlet on a circuit different from that to which the receiver is connected.
- Consult the dealer or an experienced radio/television technician for help.

FCC Identification Information

The following information is provided on the device or devices covered in this document in compliance with FCC regulations:

- Model number: Dell Laser Multi-Function Printer 1600n
- Company name:

Dell Inc.
One Dell Way
Round Rock, Texas 78682 USA
512-338-4400

Modem Regulatory Information

This equipment complies with Part 68 of the FCC Rules. On the bottom of your computer is a label that contains, among other information, the FCC registration number and ringer equivalence number (REN) for your equipment. If requested, you must provide this information to the telephone company.

The REN is used to determine the quantity of devices that may be connected to the telephone line. Excessive RENs on the telephone line may result in the devices not ringing in response to an incoming call. In most areas, the sum of all the RENs on your telephone line should be less than five to ensure proper service from the telephone company. To be certain of the number of devices that you may connect to a line, as determined by the total RENs, contact your local telephone company.

The registration jack Universal Service Order Code (USOC) used by this equipment is RJ-11C. An FCC compliant telephone cord and modular plug is provided with this equipment. This equipment is designed to be connected to the telephone network or premises wiring using a compatible modular jack that is Part 68 compliant.

This equipment cannot be used on public coin-phone service provided by the telephone company. Connection to party line service is subject to state tariffs.

There are no user serviceable parts on the modem contained in your computer.

If your telephone equipment causes harm to the telephone network, the telephone company will notify you in advance that service may be temporarily discontinued. If advance notice is not practical, the telephone company will notify you as soon as possible. Also, you will be advised of your right to file a complaint with the FCC if you believe it is necessary.

The telephone company may make changes in its facilities, equipment, operations, or procedures that could affect the operation of this equipment. If this happens, the telephone company will provide advance notice in order for you to make necessary modifications to maintain uninterrupted service.

If you experience trouble with this telephone equipment, see the section titled "Contacting Dell" in your *Owner's Manual* to find the appropriate telephone number for obtaining customer assistance. If the equipment is causing harm to the telephone network, the telephone company may request that you disconnect the equipment until the problem is resolved.

Fax Branding

The Telephone Consumer Protection Act of 1991 makes it unlawful for any person to use a computer or other electronic device, including fax machines, to send any message unless such message clearly contains in a margin at the top or bottom of each transmitted page or on the first page of the transmission, the date and time it is sent, identification of the business, other entity, or individual sending the message, and the telephone number of the sending machine or such business, other entity, or individual. The telephone number provided may not be a 900 number or any other number for which charges exceed local or long-distance transmission charges.

IC Notice (Canada Only)

Most Dell computers (and other Dell digital apparatus) are classified by the Industry Canada (IC) Interference-Causing Equipment Standard #3 (ICES-003) as Class B digital devices. To determine which classification (Class A or B) applies to your computer (or other Dell digital apparatus), examine all registration labels located on the bottom, side, or the back panel of your computer (or other digital apparatus). A statement in the form of "IC Class A ICES-003" or "IC Class B ICES-003" will be located on one of these labels. Note that Industry Canada regulations provide that changes or modifications not expressly approved by Dell could void your authority to operate this equipment.

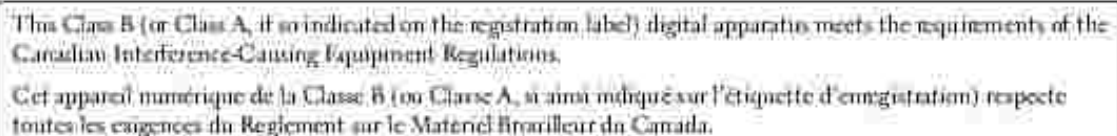

This Class B (or Class A, if so indicated on the registration label) digital apparatus meets the requirements of the Canadian Interference-Causing Equipment Regulations.
Cet appareil numérique de la Classe B (ou Classe A, si ainsi indiqué sur l'étiquette d'enregistrement) respecte toutes les exigences du Règlement sur le Matériel Brouilleur du Canada.

Modem Regulatory Information

The IC label identifies certified equipment. This certification means that the equipment meets telecommunications network protective, operational, and safety requirements as prescribed in the appropriate Terminal Equipment Technical Requirements document(s). The IC label does not guarantee that the equipment will operate to the user's satisfaction.

Before installing this equipment, users should ensure that it is permissible to be connected to the facilities of the local telecommunications company. The equipment must also be installed using an acceptable method of connection. The customer should be aware that compliance with the above conditions may not prevent degradation of service in some situations.

Repairs to certified equipment should be coordinated by a representative designated by the supplier. Any repairs or alteration made by a user to this equipment, or equipment malfunctions, may give the telephone communications company cause to request the user to disconnect the equipment.

Users should ensure for their own protection, that the electrical ground connections of the power utility, telephone lines, and internal metallic water-pipe system, if present, are connected together. This precaution may be particularly important in rural areas.

 **NOTICE:** Users should not attempt to make such connections themselves. Contact the appropriate electric inspection authority, or electrician, as appropriate.

 **NOTE:** The REN assigned to each terminal device provides an indication of the maximum number of terminals allowed to be connected to a telephone interface. The termination on an interface may consist of any combination of devices subject only to the requirement that the sum of the RENs of all the devices does not exceed the number five.

The REN for the internal modem as stated on the IC regulatory label located on the bottom of the computer is 0.6 B.

The following information is provided in compliance with IC regulations:

Dell Inc.
One Dell Way
Round Rock, TX 78682 USA
512-338-4400

CE Notice (European Union)

Marking by the symbol  indicates compliance of this Dell computer to the EMC Directive and the Low Voltage Directive of the European Union. Such marking is indicative that this Dell system meets the following technical standards:

- EN 55022 - "Information Technology Equipment - Radio Disturbance Characteristics - Limits and Methods of Measurement."
- EN 55024 - "Information Technology Equipment - Immunity Characteristics - Limits and Methods of Measurement."
- EN 61000-3-2 - "Electromagnetic Compatibility (EMC) - Part 3: Limits - Section 2: Limits for Harmonic Current Emissions (Equipment Input Current Up to and Including 16 A Per Phase)."
- EN 61000-3-3 - "Electromagnetic Compatibility (EMC) - Part 3: Limits - Section 3: Limitation of Voltage Fluctuations and Flicker in Low-Voltage Supply Systems for Equipment With Rated Current Up to and Including 16 A."
- EN 60950 - "Safety of Information Technology Equipment."

 **NOTE:** EN 55022 emissions requirements provide for two classifications:

- Class A is for typical commercial areas.
- Class B is for typical domestic areas.

RF INTERFERENCE WARNING: This is a Class A product. In a domestic environment this product may cause radio frequency (RF) interference, in which case the user may be required to take adequate measures.

This Dell device is classified for use in a typical Class B domestic environment.

A "Declaration of Conformity" in accordance with the preceding directives and standards has been made and is on file at Dell Inc. Products Europe BV, Limerick, Ireland.

CE Mark Notice

This equipment complies with the essential requirements of the European Union Directive 1999/5/EC.

Cet équipement est conforme aux principales caractéristiques définies dans la Directive européenne RTTE 1999/5/CE.

Die Geräte erfüllen die grundlegenden Anforderungen der RTTE-Richtlinie (1999/5/EG).

Questa apparecchiatura è conforme ai requisiti essenziali della Direttiva Europea R&TTE 1999/5/CE.

Este equipo cumple los requisitos principales de la Directiva 1999/5/CE de la UE, "Equipos de Terminales de Radio y Telecomunicaciones".

Este equipamento cumpre os requisitos essenciais da Directiva 1999/5/CE do Parlamento Europeu e do Conselho (Directiva RTT).

Ο εξοπλισμός αυτός πληροί τις βασικές απαιτήσεις της κοινοτικής οδηγίας EU R&TTE 1999/5/ΕΚ.

Deze apparatuur voldoet aan de noodzakelijke vereisten van EU-richtlijn betreffende radioapparatuur en telecommunicatie-eindapparatuur 1999/5/EG.

Dette udstyr opfylder de væsentlige krav i EU's direktiv 1999/5/EC om Radio- og teleterminaludstyr.

Dette udstyr er i overensstemmelse med hovedkravene i R&TTE-direktivet (1999/5/EC) fra EU.

Utrustningen uppfyller kraven för EU-direktivet 1999/5/EC om ansluten teleutrustning och ömsesidigt erkännande av utrustningens överensstämmelse (R&TTE).

Tämä laite vastaa EU:n radio- ja telepäätelaitteedirektiivin (EU R&TTE Directive 1999/5/EC) vaatimuksia.

New Zealand Telecom Warnings

General

"The grant of a Telepermit for any item of terminal equipment indicates only that Telecom has accepted that

the item complies with minimum conditions for connection to its network. It indicates no endorsement of the product by Telecom, nor does it provide any sort of warranty. Above all, it provides no assurance that any item will work correctly in all respects with another item of Telepermitted equipment of a different make or model, nor does it imply that any product is compatible with all of Telecom's network services."

"This equipment does not fully meet Telecom impedance requirements. Performance limitations may occur when used in conjunction with some parts of the network. Telecom will accept no responsibility should difficulties arise in such circumstances."

"This equipment shall not be set up to make automatic calls to the Telecom `111' Emergency Service."

"If a charge for local calls is unacceptable, the `Dial' button should NOT be used for local calls. Only the 7-digits of the local number should be dialed from your telephone. DO NOT dial the area code digit or the `0' prefix."

"This equipment may not provide for the effective hand-over of a call to another device connected to the same line."

Important Notice

"Under power failure conditions, this telephone may not operate. Please ensure that a separate telephone, not dependent on local power, is available for emergency use."

"Some parameters required for compliance with Telecom's Telepermit requirements are dependent on the equipment (PC) associated with this device. The associated equipment shall be set to operate within the following limits for compliance with Telecom's Specification:

1. There shall be no more than 10 call attempts to the same number within any 30-minute period for any single manual call initiation, and the equipment shall go on-hook for a period of not less than 30 seconds between the end of one attempt and the beginning of the next attempt.
2. Where automatic calls are made to different numbers, the equipment shall go on-line for a period of not less than 5 seconds between the end of one attempt and the beginning of the next attempt.
3. The equipment shall be set to ensure that calls are answered between 3 and 30 seconds of receipt of ringing."

"All persons using this device for recording telephone conversations shall comply with New Zealand law. This requires that at least one party to the conversation is to be aware that it is being recorded. In addition, the Principles enumerated in the Privacy Act of 1993 shall be complied with in respect to the nature of the personal information collected, the purpose for its collection, how it is used and what is disclosed to any other party."

Simplified Chinese Class A Warning Notice (China Only)

On Class A systems, the following warning will appear near the regulatory label:

Warning: This is a Class A product. In a domestic environment this product may cause radio interference, in which case the user may be required to take adequate measures.

声明

此为A级产品，在生活环境中，该产品可能会造成无线电干扰。在这种情况下，可能需要用户对其干扰采取切实可行的措施。

EN 55022 Compliance (Czech Republic Only)

This device belongs to Class B devices as described in EN 55022, unless it is specifically stated that it is a Class A device on the specification label. The following applies to devices in Class A of EN 55022 (radius of protection up to 30 meters). The user of the device is obliged to take all steps necessary to remove sources of interference to telecommunication or other devices.

Pokud není na typovém štítku počítače uvedeno, že spadá do třídy A podle EN 55022, spadá automaticky do třídy B podle EN 55022. Pro zařízení zařazená do třídy A (ochranné pásmo 30m) podle EN 55022 platí následující: Dojde-li k rušení telekomunikačních nebo jiných zařízení, je uživatel povinen provést taková opatření, aby rušení odstranil.

VCCI Notice (Japan Only)

Most Dell computers are classified by the Voluntary Control Council for Interference (VCCI) as Class B information technology equipment (ITE). However, the inclusion of certain options can change the rating of some configurations to Class A. ITE, including devices, expansion cards, printers, input/output (I/O) devices, monitors, and so on, integrated into or connected to the computer should match the electromagnetic environment classification (Class A or B) of the computer.

To determine which classification applies to your computer, examine the regulatory labels/markings located on the bottom, side, or back panel of your computer. Once you have determined your computer's VCCI classification, read the appropriate VCCI notice (see "VCCI Class A ITE Regulatory Mark" or "VCCI Class B ITE Regulatory Mark").

Class A ITE

この装置は、情報処理装置等電波障害自主規制協議会 (VCCI) の基準に基づくクラス A 情報技術装置です。この装置を家庭環境で使用すると電波妨害を引き起こすことがあります。この場合には使用者が適切な対策を講ずるよう要求されることがあります。

This is a Class A product based on the standard of the Voluntary Control Council for Interference (VCCI) for information technology equipment. If this equipment is used in a domestic environment, radio disturbance may arise. When such trouble occurs, the user may be required to take corrective actions.

VCCI Class A ITE Regulatory Mark

If the regulatory label includes the following marking, your computer is a Class A product: 

Class B ITE

この装置は、情報処理装置等電波障害自主規制協議会(VCCI)の基準に基づくクラス B 情報技術装置です。この装置は家庭環境で使用することを目的としていますが、ラジオやテレビジョン受信機に近接して使用されると、受信障害を引き起こすことがあります。取扱説明書に従って正しい取り扱いをしてください。

This is a Class B product based on the standard of the Voluntary Control Council for Interference (VCCI) for information technology equipment. If this equipment is used near a radio or television receiver in a domestic environment, it may cause radio interference. Install and use the equipment according to the instruction manual.

VCCI Class B ITE Regulatory Mark

If the regulatory label includes the following marking, your computer is a Class B product:



MIC notice (Republic of Korea Only)

To determine which classification (Class A or B) applies to your computer (or other Dell digital device), examine the Republic of Korean Ministry of Information and Communications (MIC) registration labels located on your computer (or other Dell digital device). The MIC label may be located separately from the other regulatory marking applied to your product. Line two of the label identifies the emissions class for the product-"(A)" for Class A products or "(B)" for Class B products.

NOTE: MIC emissions requirements provide for two classifications:

- Class A devices are for business purposes.
- Class B devices are for nonbusiness purposes.

Class A Device

기종명	사용자안내문
A급 기기 (업무용 정보통신기기)	이 기기는 업무용으로 전자파적합등록을 한 기기이오니, 판매자 또는 사용자는 이 점을 주의하시기 위하여 만약 잘못 판매 또는 구입하였을 때에는 가절용으로 교환하시기 바랍니다.

Please note that this device has been approved for business purposes with regard to electromagnetic interference. If you find that this device is not suitable for your use, you may exchange it for a nonbusiness-purpose device.

MIC Class A Regulatory Label

If the regulatory label includes the following marking, your computer is a Class A product:



Class B Device

기종명	사용자안내문
B급 기기 (가정용 정보통신기기)	이 기기는 가정용으로 전자파적합등록을 한 기기로서 주거지역에서는 물론 모든 지역에서 사용할 수 있습니다.

Please note that this device has been approved for nonbusiness purposes and may be used in any environment, including residential areas.

MIC Class B Regulatory Label

If the regulatory label includes the following marking, your computer is a Class B product:



Polish Center For Testing And Certification Notice

The equipment should draw power from a socket with an attached protection circuit (a 3-prong socket). All equipment that works together (computer, monitor, printer, and so on) should have the same power supply source.

The phasing conductor of the room's electrical installation should have a reserve short-circuit protection device in the form of a fuse with a nominal value no larger than 16 amperes (A).

To completely switch off the equipment, the power supply cable must be removed from the power supply socket, which should be located near the equipment and easily accessible.

A protection mark "B" confirms that the equipment is in compliance with the protection usage requirements of standard PN-EN 55022.

Wymagania Polskiego Centrum Badań i Certyfikacji

Urządzenie powinno być zasilane z gniazda z przyłączonym obwodem ochronnym (gniazdo z kółkiem).
Współpracujące ze sobą urządzenia (komputer, monitor, drukarka) powinny być zasilane z tego samego źródła.

Instalacja elektryczna pomieszczenia powinna zawierać w przewodzie fazowym rezerwowy ochronny przed zwarciem, w postaci bezpiecznika o wartości znamionowej nie większej niż 16A (amperów).

W celu całkowitego wyłączenia urządzenia z sieci zasilania, należy wyjąć wtyczkę kabli zasilającego z gniazda, które powinno znajdować się w pobliżu urządzenia i być łatwo dostępne. Znak bezpieczeństwa "B" potwierdza zgodność urządzenia z wymaganiami bezpieczeństwa użytkownika zawartymi w PN-EN 60950:2000 i PN-EN 55022:2000.

Jeżeli na tabliczce znamionowej umieszczono informację, że urządzenie jest klasy A, to oznacza, że urządzenie w środowisku mieszkalnym może powodować zakłócenia radioelektryczne. W takich przypadkach można zadać od jego użytkownika zastosowania odpowiednich środków zaradczych.

Pozostałe instrukcje bezpieczeństwa

- Nie należy używać wtyczek adapterowych lub usuwać kółka obwodu ochronnego z wtyczki. Jeżeli konieczne jest użycie przedłużacza to należy użyć przedłużacza 3-żyłowego z prawidłowo połączonym przewodem ochronnym.
- System komputerowy należy zabezpieczyć przed nagłymi, chwilowymi wzrostami lub spadkami napięcia, używając eliminatora przepięć, urządzenia dopasowującego lub bezzakłóconego źródła zasilania.
- Należy upewnić się, aby nie leżało na kablach systemu komputerowego, oraz aby kable nie były umieszczone w miejscu, gdzie można byłoby na nie nadeptywać lub potykać się o nie.
- Nie należy rozlewać napojów ani innych płynów na system komputerowy.
- Nie należy wpychać żadnych przedmiotów do otworów systemu komputerowego, gdyż może to spowodować pożar lub porażenie prądem, poprzez zwarcie elementów wewnętrznych.
- System komputerowy powinien znajdować się z dala od grzejników i źródeł ciepła. Ponadto, nie należy blokować otworów wentylacyjnych. Należy unikać kładzenia luźnych papierów pod komputer oraz umieszczania komputera w ciasnym miejscu bez możliwości cyrkulacji powietrza wokół niego.

BSMI Notice (Taiwan Only)

If you find a  or  mark on the regulatory label on the bottom, side, or back panel of your computer, the following section is applicable:

BSMI 通告 (僅限於台灣)

大多數的 Dell 電腦系統被 BSMI (經濟部標準檢驗局) 劃分為乙類數位裝置。但是，使用某些選件會使有些組態的等級變成甲類。若要確定您的電腦系統適用等級，請檢查所有位於電腦底部或背面板、擴充卡安裝托架，以及擴充卡上的 BSMI 註冊標籤。如果其中有一甲類標籤，即表示您的系統為甲類數位裝置。如果只有 BSMI 的檢驗號碼標籤，則表示您的系統為乙類數位裝置。

一旦確定了系統的 BSMI 等級，請閱讀相關的 BSMI 通告。請注意，BSMI 通告規定凡是未經 Dell Inc. 明確批准的擅自變更或修改，將導致您失去此設備的使用權。

此裝置符合 BSMI (經濟部標準檢驗局) 的規定，使用時須符合以下兩項條件：

- 此裝置不會產生有害干擾。
- 此裝置必須能接受所接收到的干擾，包括可能導致無法正常作業的干擾。

甲類

此設備經測試證明符合 BSMI (經濟部標準檢驗局) 之甲類數位裝置的限制規定。這些限制的目的為為了在商業環境中使用此設備時，能提供合理的保護以防止有害的干擾。此設備會產生、使用並散發射頻能量；如果未遵照製造廠商的指導手冊來安裝和使用，可能會干擾無線電通訊。請勿在住宅區使用此設備。

警告使用者：
這是甲類的資訊產品，在居住的環境中使用時，可能會造成射頻干擾。
在這種情況下，使用者會被要求採取某些適當的對策。

乙類

此設備經測試證明符合 BSMI (經濟部標準檢驗局) 之乙類數位裝置的限制規定。這些限制的目的為為了在住宅區安裝時，能防止有害的干擾，提供合理的保護。此設備會產生、使用並散發射頻能量；如果未遵照製造廠商的指導手冊來安裝和使用，可能會干擾無線電通訊。但是，這並不保證在個別的安装中不會產生干擾。您可以透過關閉和開啓此設備來判斷它是否會對廣播和電視接收造成干擾；如果確實如此，我們建議您嘗試以下列一種或多種方法來排除干擾：

- 重新調整天線的接收方向或重新調整接收天線。
- 增加設備與接收器的距離。
- 將設備連接至不同的插座，使設備與接收器連接在不同的電路上。
- 請向服務商或有經驗的無線電 / 電視技術人員查詢，以獲得幫助。

NOM Information (Mexico Only)

The following information is provided on the device(s) described in this document in compliance with the requirements of the official Mexican standards (NOM):

Exporter:	Dell Inc. One Dell Way Round Rock, TX 78682
Importer:	Dell Computer de México, S.A. de C.V. Paseo de la Reforma 2620 - 11° Piso Col. Lomas Altas 11950 México, D.F.
Ship to:	Dell Computer de México, S.A. de C.V. al Cuidado de Kuehne & Nagel de México S. de R.L. Avenida Soles No. 55 Col. Peñon de los Baños 15520 México, D.F.
Model number:	
Supply voltage:	100/240 VAC
Frequency:	50/60 Hz
Current Consumption:	1.5 A
Output voltage:	20 VDC
Output current:	3.5 A

ENERGY STAR® Compliance

Certain configurations of Dell computers comply with the requirements set forth by the Environmental Protection Agency (EPA) for energy-efficient computers. If the front panel of your computer bears the ENERGY STAR® Emblem, your original configuration complies with these requirements and all ENERGY STAR® power management features of the computer are enabled.

NOTE: Any Dell computer bearing the ENERGY STAR® Emblem is certified to comply with EPA ENERGY STAR® requirements as configured when shipped by Dell. Any changes you make to this configuration (such as installing additional expansion cards or drives) may increase the computer's power consumption beyond the limits set by the EPA's ENERGY STAR® Computers program.

ENERGY STAR® Emblem



The EPA's ENERGY STAR® Computers program is a joint effort between the EPA and computer manufacturers to reduce air pollution by promoting energy-efficient computer products. The EPA estimates that use of ENERGY STAR® computer products can save computer users up to two billion dollars annually in electricity costs. In turn, this reduction in electricity usage can reduce emissions of carbon dioxide, the gas primarily responsible for the greenhouse effect, and sulfur dioxide and nitrogen oxides, the primary causes of acid rain.

You can also help reduce electricity usage and its side effects by turning off your computer when it is not in

use for extended periods of time, particularly at night and on weekends.

Free Manuals Download Website

<http://myh66.com>

<http://usermanuals.us>

<http://www.somanuals.com>

<http://www.4manuals.cc>

<http://www.manual-lib.com>

<http://www.404manual.com>

<http://www.luxmanual.com>

<http://aubethermostatmanual.com>

Golf course search by state

<http://golfingnear.com>

Email search by domain

<http://emailbydomain.com>

Auto manuals search

<http://auto.somanuals.com>

TV manuals search

<http://tv.somanuals.com>