

***D-Link* DCS-2100+** **Enhanced 2.4 GHz Wireless** **Internet Camera**



Manual

Version 2.0

D-Link[®]

Building Networks for People

Contents

Contents of Package	3
Introduction	4
Features and Benefits	4
Connections	6
Hardware Installation	8
Software Installation	9
Installing IP Surveillance Software	13
Testing the DCS-2100+	17
Security	18
Using and Configuring the DCS-2100+ with a NAT Router	19
Using the DCS-2100+ with the Internet Browser	25
Using IP Surveillance Software	50
Monitor Program	50
Playback Program	70
Firmware Upgrades	85
Appendix	88
Frequently Asked Questions	88
How to PING Your IP Address	91
Reset and Restore	92
I/O Connector	93
Adjusting the Camera Focus	94
Replacing the Lens	95
Technical Specifications	96
Contacting Technical Support	98
Time Zone Table	99
Warranty and Registration	101

Package Contents



- D-Link **DCS-2100+** Internet Camera
- Power Adapter
- Installation software and manual on CD
- Quick Installation Guide
- Camera Stand
- Category 5 Ethernet Cable
- 2 Antennas

If any of the above items are missing, please contact your reseller.

*Note: Using a power supply with a different voltage than the one included with the **DCS-2100+** will cause damage and void the warranty for this product.*

Minimum System Requirements:

- Internet Explorer 5.x or higher Internet Web Browser
- CPU: Pentium III, 500 MHz or above
- Memory Size: 64 MB
- VGA card resolution: 800 x 600 or above

Introduction

The D-Link **DCS-2100+** Wireless Internet Camera is a powerful surveillance system that connects wirelessly to an your 802.11b network. The **DCS-2100+** features enhanced 802.11b and connects wirelessly at up to 22 Mbps (Megabits per second). The **DCS-2100+** differs from a conventional PC Camera because the Internet Camera is a standalone system with a built-in CPU and Web server, providing a low-cost solution capable of solving demanding security and home/office monitoring needs. The Internet Camera can be accessed remotely, and controlled, from any PC or notebook computer over the Internet from anywhere in the world. Simple installation procedures, along with the built-in Web-based interface offers easy integration to your network environments.

Features and Benefits

The **DCS-2100+** Wireless Internet Camera is a standalone system requiring no additional hardware or software. All that is required is a computer with the Internet Explorer Web browser (version 5.x or above). Just plug-in the camera and view the picture from your Internet Camera with a valid IP Address.

Broad Range of Applications

With today's high-speed Internet, the Internet Camera provides the ideal solution for live video images over the Intranet and Internet for remote monitoring. The **DCS-2100+** allows remote access from an Internet Explorer Web browser for live image viewing and allows the administrator to manage and control the Internet Camera anywhere and any time. Apply the Internet Camera to monitor various objects and places such as homes, offices, banks, hospitals, child-care centers, amusement parks and other varieties of industrial and public monitoring. The Internet Camera can also be used for intruder detection with its motion-detection mode, capture still images and video images for archiving and many more applications. The wireless capability means you can place the camera where it is inconvenient to install network cables.

Supports a Variety of Platforms

Supporting TCP/IP networking, SMTP e-mail, HTTP and other Internet related protocols, the **DCS-2100+** Internet Camera can be integrated easily into other Internet/Intranet applications because of its standards-based features.

Features & Benefits (continued)

Web Configuration

Using the Internet Explorer Web browser, administrators can configure and manage the Internet Camera directly from its own Web page via the Intranet or the Internet. Up to 20 user names and passwords are permitted, with privilege settings controlled by the administrator.

Powerful Surveillance and Remote Monitoring Utility

The powerful **IP Surveillance** software application assigns an administrator with a pre-defined user ID and password who can modify the Internet Camera settings from a remote site via an Intranet or the Internet. Users are allowed to monitor the image, record the image to a hard drive, and take snapshots.

Connection to External Devices

Supporting auxiliary Input/Output connectors, you can connect the Internet Camera to a variety of external devices such as IR-sensors, switches and alarm relays. Combined with programmable alarming facilities, you can develop a variety of security applications that are triggered on alarm-based events. The Internet Camera provides an industry standard in/out external connector for connectivity.

Connections

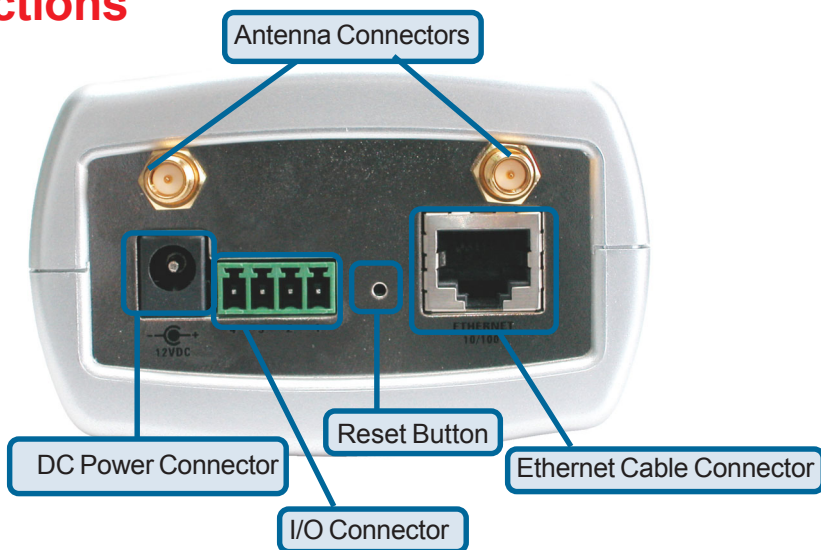

Antenna

Two antennas are included with the **DCS-2100+**. These are screwed onto the antenna connectors on the back panel to provide a connection with a wireless network.

Ethernet Cable Connector

The Internet Camera's back panel features an **RJ-45** connector for connections to 10Base-T Ethernet cabling or 100Base-TX Fast Ethernet cabling. This network port supports the **NWay protocol**, allowing the Internet Camera to automatically detect or negotiate the transmission speed of the network.

The Ethernet cable included with the **DCS-2100+** Internet Camera is a Category 5 "straight through" cable. This is the recommended cable type when the camera is physically connected to a 100 Mbps Fast Ethernet network hub or switch.

Reset Button

Reset will be initiated when the reset button is pressed once and held until the Power LED flashes through its cycle twice.

A Factory reset is initiated when the reset button is pressed continuously for 5 seconds or when the Power LED changes from **green** to **red** for 2 cycles. (For example you will see the LED turn to **red** twice, release the reset button when the LED turns **red** the second time). The Power LED will begin to flash indicating that the Internet Camera's settings are reverting back to the factory settings, then turn back to **green**.

Connections (continued)

DC Power Connector

The DC power input connector is located on the **DCS-2100+** Internet Camera's back panel and is labeled **12VDC** with a single socket to supply power to the Internet Camera.

I/O Connector

The **DCS-2100+** provides a terminal block with two pairs of connectors situated on the back panel. One pair is for input and the other is for output. The I/O connectors provide the physical interface to send and receive digital signals to a variety of external alarm devices. **Please refer to the Appendix (Page 93) in this manual for detailed information.**

Bottom Panel



Attachment socket for the Camera Stand

Located on the bottom panel of the Internet Camera, the socket is used to connect the camera stand to the Internet Camera by attaching the screw head on the camera stand to the Internet Camera.

Power LED

LED stands for **L**ight-**E**mitting **D**iode.

The Power LED is positioned to the right of the Internet Camera lens. As soon as the power adapter is connected to the Internet camera the power LED will flash **red** and **green** several times, the **DCS-2100+** is conducting a self-test. Upon passing the self-test the LED will turn **green** to indicate a good connection to an Ethernet port or **red** to indicate no connection has been made.

Hardware Installation

1 Connect to an Ethernet Network

If you are connecting the **DCS-2100+** to a **wired** Ethernet network, connect an Ethernet cable to the network cable connector located on the Internet Camera's back panel and attach it to the network.



If you are connecting the **DCS-2100+** to a **802.11b wireless** Ethernet network, attach the two wireless antennas to the antenna connectors on the back panel of the **DCS-2100+**.



2 Attach the external power supply

Attach the external power supply to the DC power input connector located on the Internet Camera's back panel (labeled **12VDC**) and connect it to your wall outlet.



When you have a proper connection, the LED will turn from **red** to **green**. The light may cycle on and off and your computer may show an intermittent loss of connectivity, this is normal until you have configured your Internet Camera.

Attaching the Internet Camera to the Camera Stand

The Internet Camera comes with a camera stand with a swivel ball screw head that can be attached to the Internet Camera bottom socket cavity. Attach the camera stand to the Internet Camera and station it for your application. There are holes located in the base of the camera stand allowing the Internet Camera to be mounted to the ceiling, or any wall securely.



Software Installation

After you have successfully completed the hardware installation of the **DCS-2100+** Internet Camera, it is necessary to install software to configure and operate the camera. The first step is to run the **IP Installer** program on the CD. **IP Installer** allows you to use the Internet Camera with your Internet browser. With the **IP Installer** program you can enter settings that permit the camera to access the Internet directly or through your Ethernet network.

After the **IP Installer** software program is completed, you will have an operating and controllable Internet Camera. From your Internet Explorer Web browser you will be able to access the video and sound from the Internet camera. The camera has a built-in Web server. This Web server will allow the camera to access the Internet without being attached to a computer and permits users to view the video and audio remotely.

However, it is necessary to install the **IP Surveillance** software from the enclosed CD to create a truly powerful monitoring and surveillance system. The following section will detail the installation of the **IP Installer** and the **IP Surveillance** software.

Installing the IP Installer program

Insert the CD that is included with the **DCS-2100+** Internet Camera. The **DCS-2100+** installation menu will start up automatically from the CD. If the CD does not startup automatically (the Windows operating system can turn this function off, for example), simply access the CD from Windows and click on the autorun.exe program to access the installation menu shown below:



Software Installation (continued)

The opening **IP Installer** screen will appear and show a MAC address of the **DCS-2100+** and an IP Address (which may or may not be correct depending on what you have your **DCS-2100+** connected to.) If you have a DHCP* server on your network, there will be a valid IP Address displayed here.

*A DHCP server is a device that supplies IP Addresses to its clients that are on the same network.



IMPORTANT:

A hardware reset of the Internet Camera is now required to allow the **IP Installer** program to configure the camera correctly. To accomplish this reset, lightly insert a paper clip (or a similar sized tool) into the reset hole on the back of the camera (see page 6 for the location of the reset button.) The LED on the front of the camera will begin blinking red and green. When it stops the blinking cycle continue to hold in the reset button until a second cycle of blinking red and green lights indicates a second reset cycle has completed. This will take approximately 5-7 seconds.

The **IP Installer** will now show a MAC address for the **DCS-2100+** and an IP address. This IP address may not be correct at this step in the installation.

Highlight the MAC address and then click on the **Wizard** button to activate the installation Wizard.

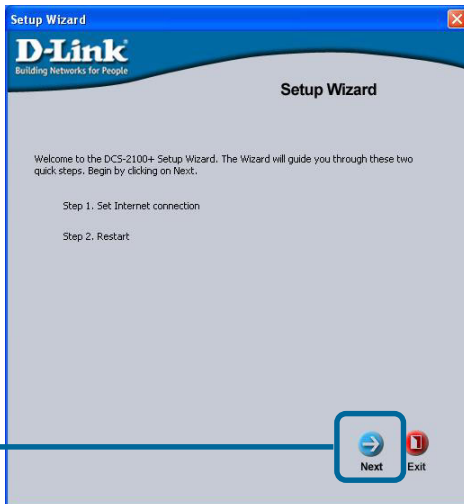

Software Installation (continued)

If you have a DHCP server on your network, you will already have a valid IP Address in these fields.

If you do not have a DHCP server on your network fill out your **IP Address**, **Subnet mask**, **Gateway** and at least one DNS IP Address.

If you do not know what to put in these fields, please contact your System Administrator or your Internet Service Provider.

Click **Next**

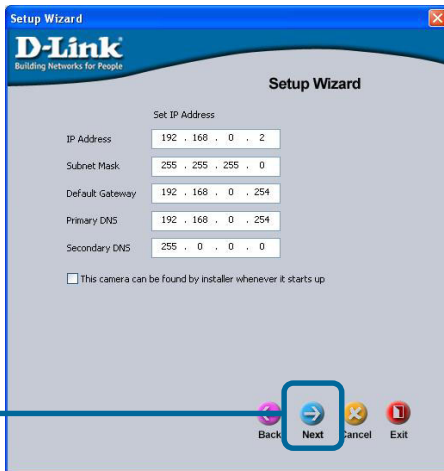

Leave the box titled **This camera can be found by installer whenever it starts up** unchecked to avoid running this install application each time you boot up the **DCS-2100+**. Check this box if you need to change IP address the next time the **DCS-2100+** boots up.

Type in your **SSID** and **Connection type** consistent with your network. (If you are unsure, please contact your network administrator).

Choose the **Channel** that is the same as your other wireless devices that you would like to connect to.

You can choose a different **transmission rate** if you need to restrict the camera's bandwidth.

Select **Long** or **Short Preamble**. **Long Preamble** is the default setting. See page 31 for a description of Preamble.

You can enable **Encryption** here (up to 256-bit).



Click **Next**

Software Installation (continued)

If you need to make any changes, click **Back** to modify your camera settings. To accept the settings, click **Restart**.

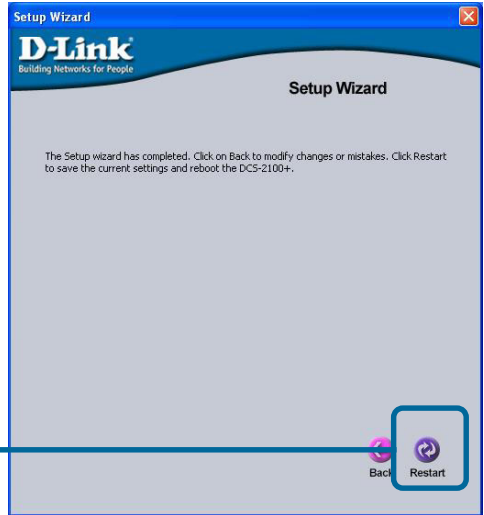

Click **Restart**

Click **OK** and the **DCS-2100+** Internet Camera will reboot to accept the settings.

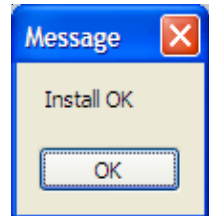

If the **IP Installer** has not made any modifications to the settings, it will warn you that the settings were accepted but no changes were made.

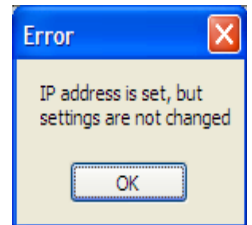

You should now see the opening **IP Installer** screen with an IP address assigned to the MAC address of the **DCS-2100+**.

Click on **Exit** to close **IP Installer**.

You have now completed the Setup Wizard and are ready to use your camera! You can also continue to the next section to install the IP Surveillance software before you begin to use the DCS-2100+.

Installing IP Surveillance Software

The **IP Surveillance** software on the CD included with the **DCS-2100+** Internet Camera converts the **DCS-2100+** into a powerful, yet flexible, surveillance system for home or business, with these features:

- Real-time Monitoring
- Video Recording to hard disk
- High quality video
- High video compression ratio
- Maximum of 16 cameras with different display layouts
- Smart playback
- Triggered event browsing
- Fast database searching
- Configurable automated alarms
- Account password protection
- Scheduled recording for each camera
- Email / FTP video snapshots
- AVI file export
- Motion detection for each camera

To install **IP Surveillance**, click on the **Install IP Surveillance Software** on the CD included with the Internet Camera. The **Welcome** screen appears:

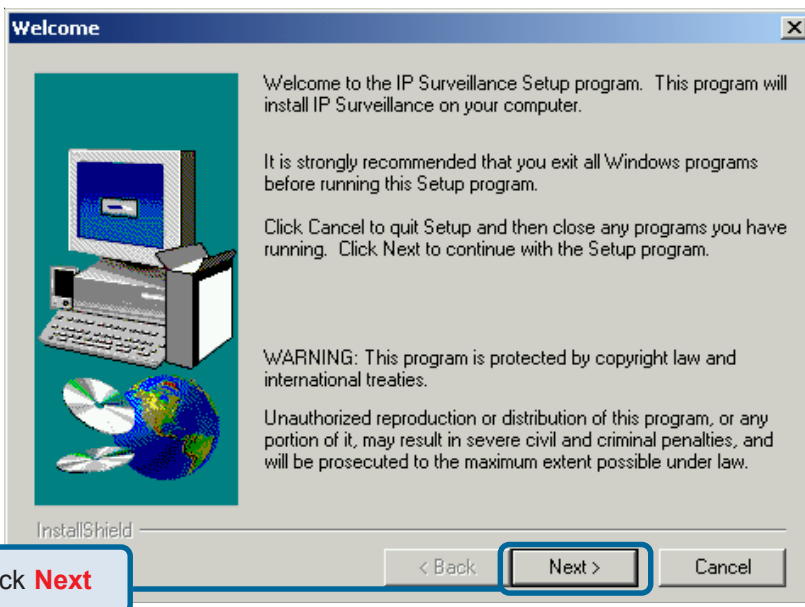

Installing IP Surveillance Software (continued)

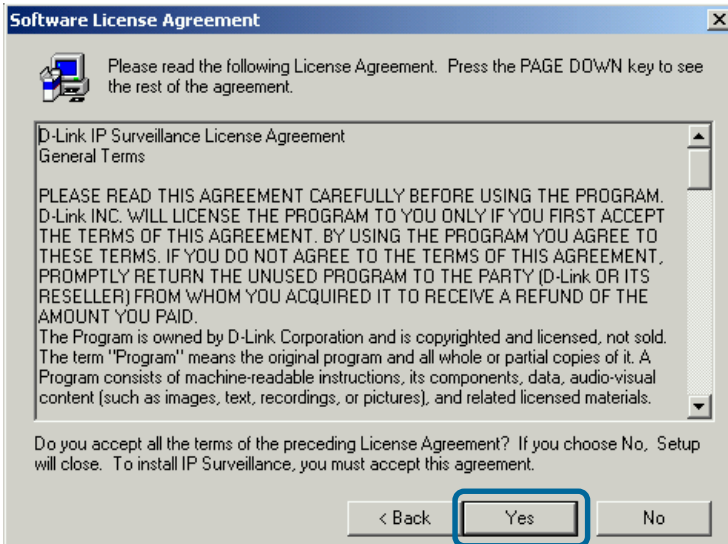

Click **Yes**

Please read the Software Licensing Agreement and click **Yes** if you agree with the agreement. Click **No** to exit the installation.



Click **Next**

Enter your name and company information and click **Next**.

Installing IP Surveillance Software (continued)

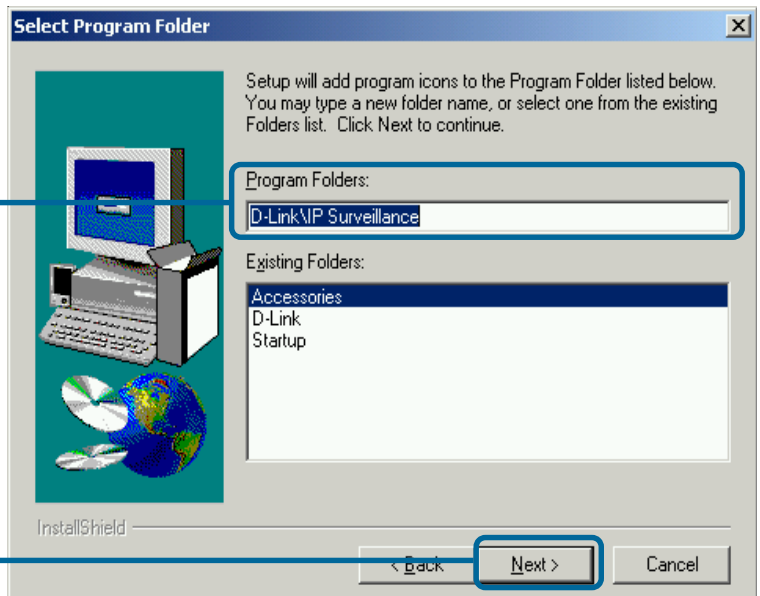
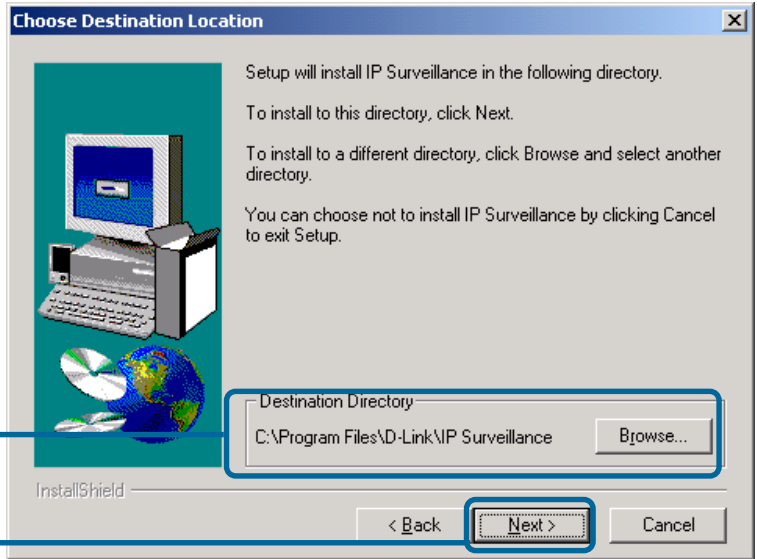

Installing IP Surveillance Software (continued)

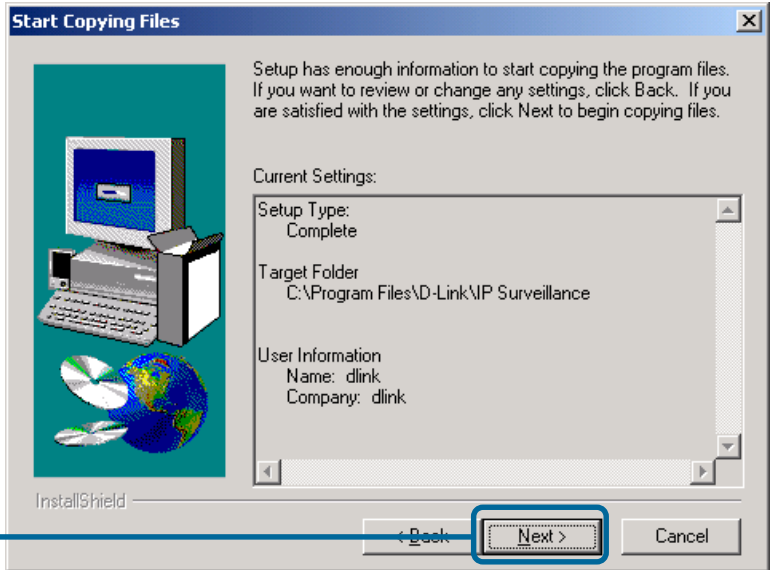

The installation is complete.

Testing the DCS-2100+ Internet Camera

Open your Internet browser and type in the IP address of the **DCS-2100+**. In this example the address is: **http://192.168.0.146** (your **DCS-2100+** may have a different IP address based on what you used in the **IP Installer** program.)

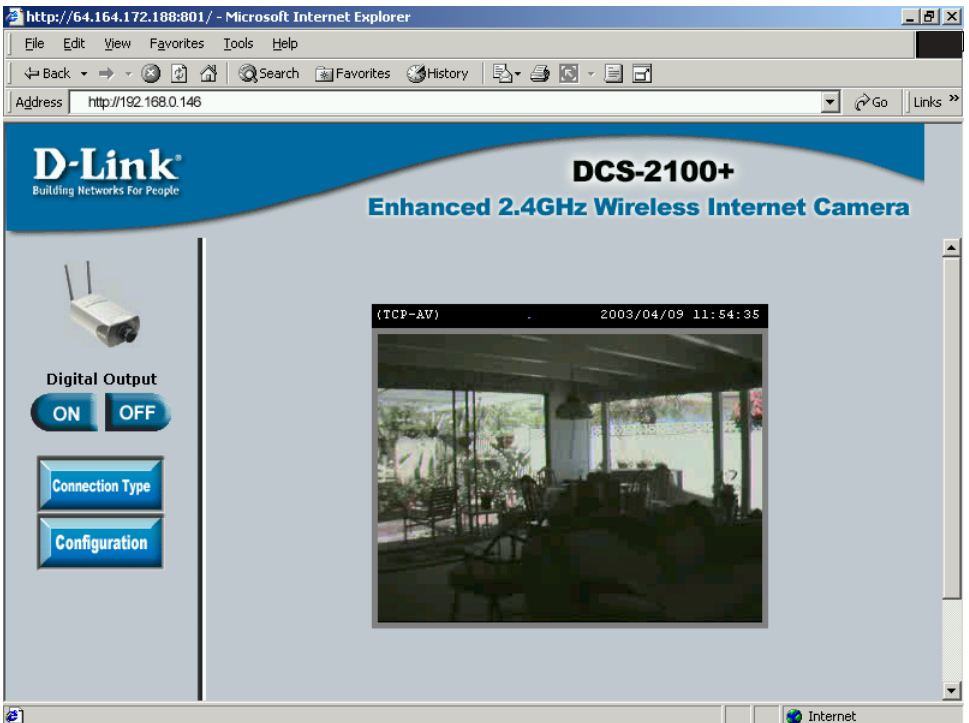
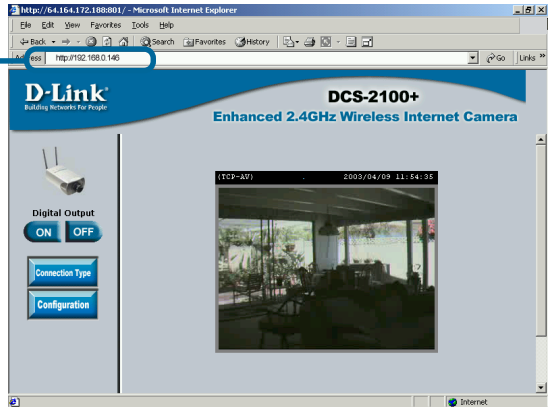

The window in the center of your browser is the camera image window. You should now see a video image and hear the audio over your computer speakers from the **DCS-2100+**. If you are having problems please consult the **FAQ** section of this manual.

Security

At this point it is highly recommended that you click on the **Configuration** button on the Home screen, and then the **Tools** tab to bring you to the **Admin** screen. Enter a **password** for security purposes.

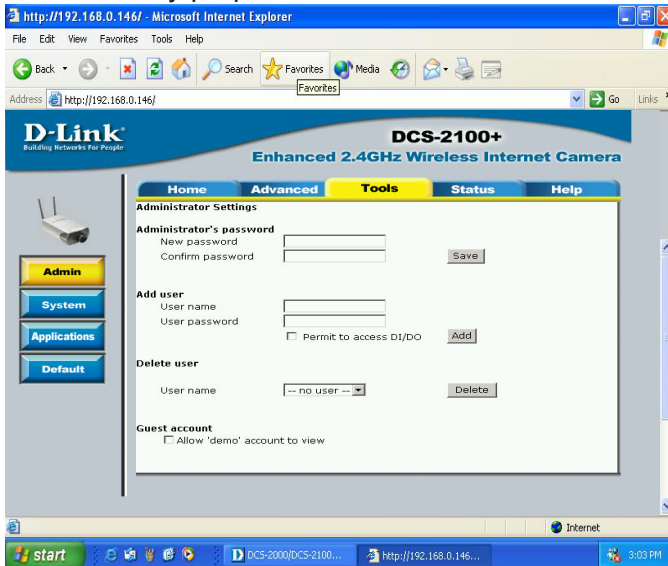

To ensure the highest security and prevent unauthorized use of the Internet Camera, the *Administrator* has the exclusive privilege to access the **System Administration** settings to allow users entry and authorize privileges for all users. The Internet Camera supports multi-level password protection/access to the Internet Camera that can be restricted to defined users who have a **User Name** and **User Password**, which is assigned by the Administrator.

The Administrator can release a public user name and password so that when remote users access the Internet Camera they will have the right to view the image transmitted by the Internet Camera.

When the Internet Camera is used for the first time, it is highly recommended that the Administrator set the **Administrator Password** to constrain user access to the Internet Camera since the Default settings are Null String (no password). Once the Password is defined, only the Administrator has access to the management of the Internet Camera. This procedure should be done as soon as possible since the security features of the Internet Camera will not be enabled until the **Administrator Password** is defined.

Using & Configuring the DCS-2100+ with a NAT Router

D-Link's **DCS-2100+** is a versatile and cost effective Internet Camera offering both video and audio monitoring. It can also serve as a powerful surveillance system in security applications. The **DCS-2100+** can be used with any wired or 802.11b wireless router. This section explains how to view the camera from either the Internet or from inside your internal network.

Materials Needed:

- 1 **DCS-2100+** Internet Camera
- 1 Ethernet Cable
- A Wired or Wireless router such as the D-Link DI-614+ Wireless Router
- Ethernet based PC for system configuration

SETTING UP THE DCS-2100+ FOR USE BEHIND A ROUTER

Installing a **DCS-2100+** Internet Camera on your network is an easy 4–step procedure:

- ① Assign a local IP Address to your Internet Camera
- ② View the Internet Camera Using Your Internet Explorer Web browser
- ③ Access the Router on Your Web browser
- ④ Open Virtual Server Ports for Your Router (Enable Remote Viewing)

This section is designed to walk you through the setup process for installing your camera behind a router and enable remote video viewing. For the basic setup of the **DCS-2100+**, follow the steps outlined in the **Quick Installation Guide**.

After you have completed the setup of the **DCS-2100+** outlined in the **Quick Installation Guide** you will have an operating camera that has an assigned IP Address. Because you are using a router to share the Internet with one or more PCs, the IP Address assigned to the Internet Camera will be a local IP Address. This allows viewing within your Local Area Network (LAN) until the router is configured to allow remote viewing of the camera over the Internet.

① Assign a Local IP Address for Your Camera

Run the **IP Installer** program from the CD included with the **DCS-2100+**. Follow the steps in the **Quick Installation Guide** to configure the **DCS-2100+**. The camera will be assigned a local IP Address that allows it to be recognized by the router. Write down this IP Address for future reference.

Using & Configuring the DCS-2100+ with a NAT Router (continued)

This is the IP Address assigned to your camera. Write it down for later use. 192.168.0.146 is only an example. You will probably have a different IP Address.



Assign a Local IP Address with IP Installer

② View the Internet Camera using your Internet Explorer Web browser

Run your Internet Explorer Web browser. In the address bar, type in the IP Address that was assigned to the Internet Camera by the **IP Installer** program. The **DCS-2100+** Home Page appears with a window displaying live video from the camera. You are able to view this screen from any PC running Internet Explorer on your LAN.

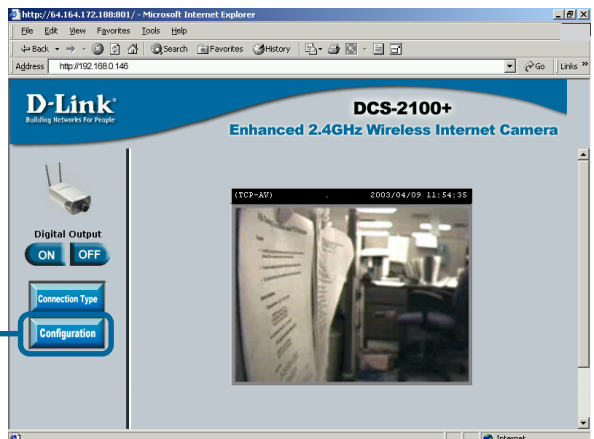

Click on the **Configuration** button.

Viewing the Video on the browser to test the connection

Click on the **Configuration** button on the left side of the display. Scroll to the bottom of the Network Configuration page to display the ports used by HTTP and Streaming audio and video.

Using & Configuring the DCS-2100+ with a NAT Router (continued)

These are the port settings for your camera. They can be changed if needed.

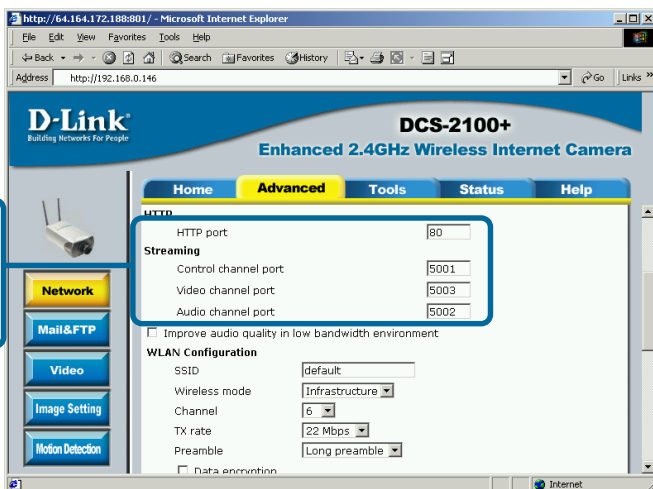

Ports that are used by the DCS-2100+

Router Set-Up and Installation

The following steps generally apply to any router that you have on your network. The D-Link DI-614+ is used as an example to clarify the configuration process. Configure the initial settings of the DI-614+ by following the steps outlined in the **DI-614+ Quick Installation Guide**.

③ Access Your Router on Your Web Browser

If you have cable or DSL Internet service, you will most likely have a dynamically assigned WAN IP Address. 'Dynamic' means that your router's IP address can change from time to time depending on your ISP. A dynamic WAN IP Address identifies your router on the public network and allows it to access the Internet. To find out what your router's WAN IP Address is, go to the **Status** menu on your router and locate the WAN information for your router (as shown on the next page). The WAN IP Address will be listed. This will be the address that you will need to type in your web browser to view your camera over the Internet.

Using & Configuring the DCS-2100+ with a NAT Router (continued)

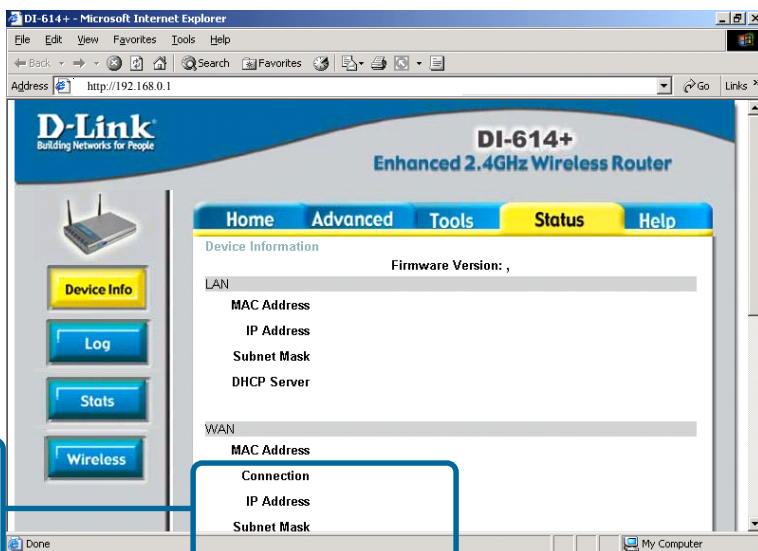

Determine Your Router's IP Address (WAN)

Note: Because a dynamic WAN IP can change from time to time depending on your ISP, you may want to obtain a Static IP address from your ISP. A Static IP address is a fixed IP address that will not change over time and will be more convenient for you to use to access your camera from a remote location. The Static IP Address will also allow you to access your camera attached to your router over the Internet

④ Open Virtual Server Ports to Enable Remote Image Viewing

The firewall security features built into the DI-614+ router prevent users from accessing the video from the **DCS-2100+** over the Internet. The router connects to the Internet over a series of numbered ports. The ports normally used by the **DCS-2100+** are blocked from access over the Internet. Therefore, these ports need to be made accessible over the Internet. This is accomplished using the **Virtual Server** function on the DI-614+ router. The Virtual Server ports used by the camera must be opened through the router for remote access to your camera. Virtual Server is accessed by clicking on the **Advanced** tab of the router screen.

Using & Configuring the DCS-2100+ with a NAT Router (continued)

Follow these steps to configure your router's Virtual Server settings:

- Click **Enabled**.
- Select **Both** under **Protocol Type (TCP and UDP)**
- Enter your camera's local IP Address (e.g., **192.168.0.146** in the example in step ② above) in the **Private IP** field.
- If you are using the default camera port settings, enter **80** in to the **Public** and **Private Port** section, click **Apply**.
- **Scheduling** should be set to **Always** so that the camera images can be accessed at any time.

Repeat the above steps adding ports **5001**, **5002** and **5003** to both the **Public** and **Private Port** sections. A check mark appearing before the camera name will indicate that the ports are enabled.

Important: Some ISPs block access to port 80 and other commonly used Internet ports to conserve bandwidth. Check with your ISP so that you can open the appropriate ports accordingly. If your ISP does not pass traffic on port 80, you will need to change the port the camera uses from 80 to something else, such as 800. Not all routers are the same, so refer to your user manual for specific instructions on how to open ports.

Enter valid ports in the **Virtual Servers** section of your router

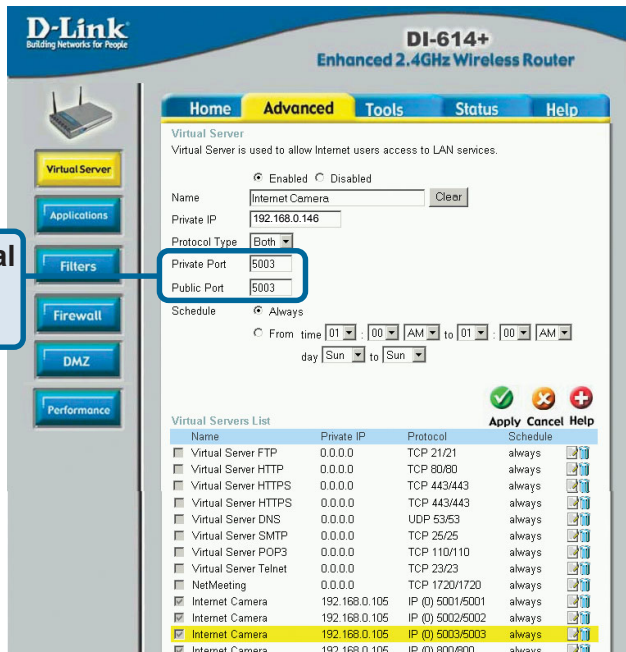

Viewing Your Camera

After all the router settings have been entered correctly, a PC user inside or outside your network will have access to the camera through the Internet Explorer Web browser. To access the camera from the Internet, type the IP Address of the router given to you by your ISP, followed by a colon, and the port number that you gave your camera (e.g., **http://205.163.122.96:83**). It is not necessary to enter the colon and port number if you are using the default Web server port 80. To access from a computer on your local (home) network, simply enter the local IP Address of the Camera. (e.g., **192.168.0.146**).

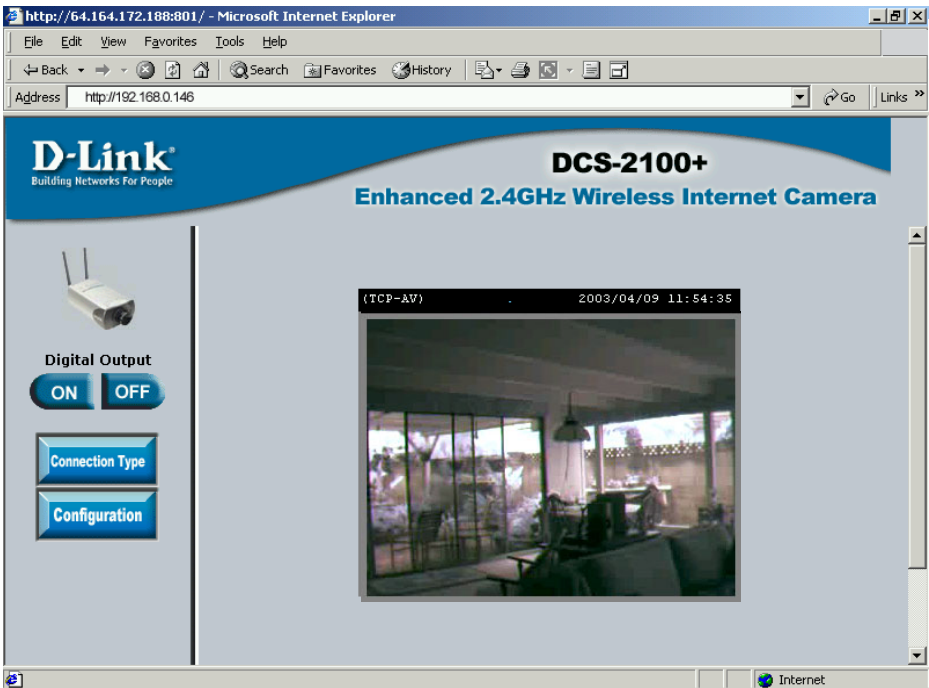

Viewing the DCS-2100+ Remotely

Using the DCS-2100+ with an Internet browser

If you are following this manual in the order it is presented, you should now have an operating **DCS-2100+** Internet Camera configured with the Installer program. You also have installed the **IP Surveillance** software from the CD. This section of the manual will deal with using the Internet Camera in two parts:

- Using the **DCS-2100+** with an Internet browser and accessing the screens to control and monitor the camera.
- Using **IP Surveillance** software with the **DCS-2100+**.

Open your Internet Explorer Web browser and enter the IP address for your Internet Camera.

In the example, this address is 192.168.0.146. Your address may differ.



If a window appears asking to install a Verisign certificate for authentication Click **Yes**.

Using the DCS-2100+ with an Internet browser (continued)

Home Page Screen

The image from the **DCS-2100+** should be visible from the Home page on your computer monitor.

There are two buttons on the left side of the **Home** page:
Connection Type
and
Configuration.

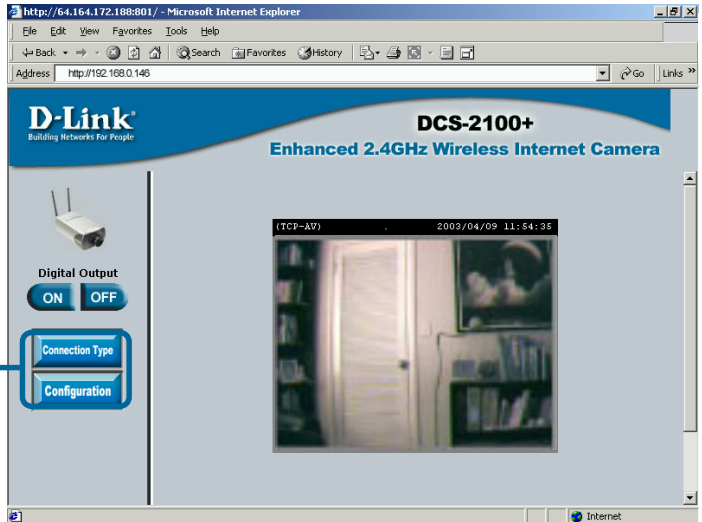

Click on the **Connection Type** button to change settings related to the connection.

Click **Connection Type**

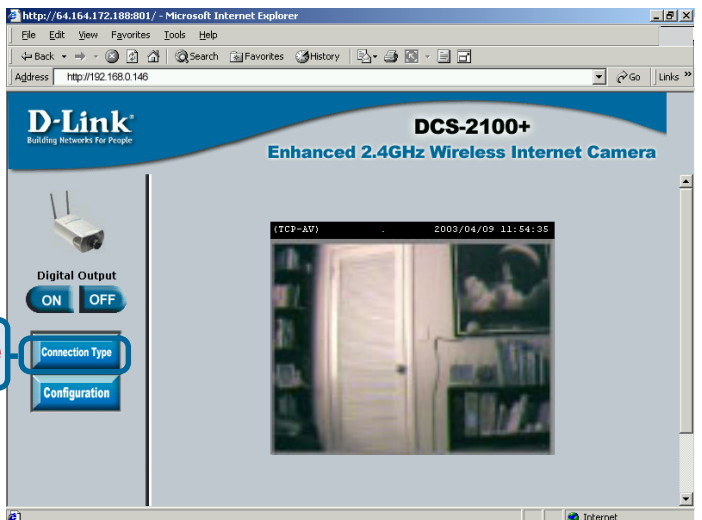

Using the DCS-2100+ with an Internet browser (continued)

Home > Connection Type Screen

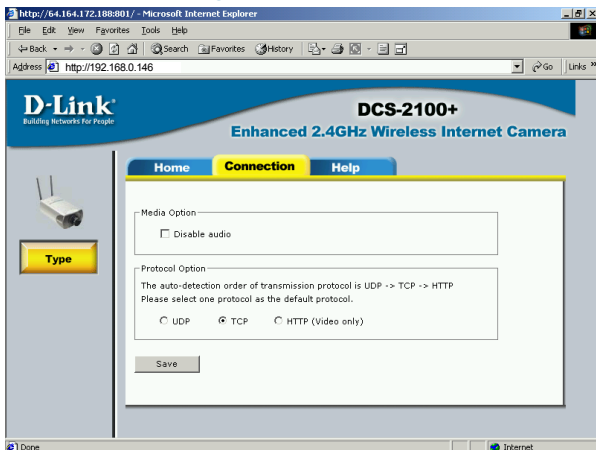

The following options are available from the Connection Type screen:

Media Option:

Allows a user to disable audio when viewing video.

Protocol Option

The UDP Protocol should be chosen for the most users. Generally, the client computer will automatically try these protocols in the following order, UDP -> TCP -> HTTP.

After the client connects to the **DCS-2100+** successfully, the working protocol will be displayed in **Protocol Option**. The chosen protocol will be recorded in the user's PC and used for the next connection. If the network environment is changed or users want to let the Web browser automatically detect the protocol, select UDP manually and click **Save** to change the setting and return **Home** to reconnect with the new setting.

Options:

UDP Protocol - Offers the highest image and video quality.

However, packet losses will diminish image quality when bandwidth becomes restricted.

TCP Protocol - Packet loss is less likely to occur compared to UDP when bandwidth is restricted.

HTTP Protocol - If the network is protected by a firewall and it opens HTTP port (80) only, HTTP protocol must be selected. In this mode, audio is disabled and only video can be viewed.

Click the **Home** tab to return to the **DCS-2100+** Home page.

Using the DCS-2100+ with an Internet browser (continued)

Home > Configuration

Click **Configuration**

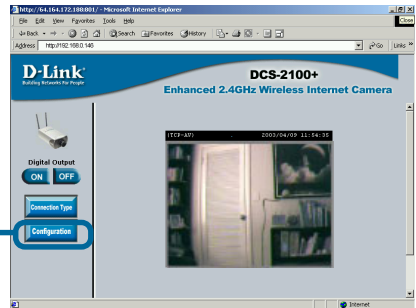

There are 5 tabs across the top of the **Configuration** screen. From each tab, different elements of the **DCS-2100+** can be configured. The **Advanced** tab is the default screen in **Configuration** and **Network** is the default screen under **Advanced**.

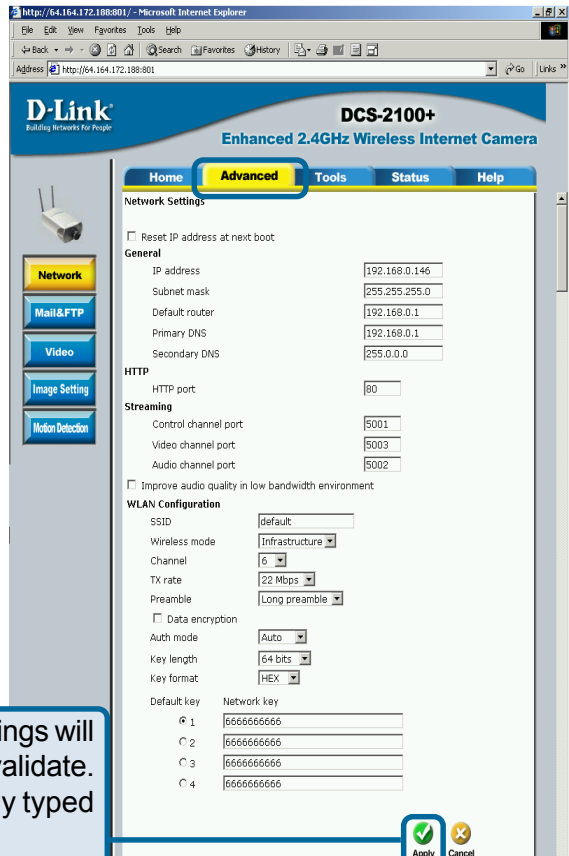

Any changes made to these settings will require the system to restart to validate. Make sure every field is correctly typed before clicking on **Apply**.

Using the DCS-2100+ with an Internet browser (continued)

Configuration > Advanced > Network

Reset IP Address at next boot

Once the **DCS-2100+** is configured, this box should be unchecked at all times. If the box has been checked and the connection is lost, either run **IP Installer** or PING the IP Address of the camera from a command prompt to regain the connection.

General Settings

- IP address -** Necessary for network identification.
- Subnet mask -** Used to determine if the destination is in the same subnet. The default value is "255.255.255.0."
- Default router -** The router used to forward frames to destinations in a different subnet. Invalid router settings may cause the failure of transmissions to a different subnet.
- Primary DNS -** Primary domain name server that translates names to IP addresses.
- Secondary DNS -** Secondary domain name server to backup the primary one.

HTTP Settings

- HTTP Port-** Can be set to other than the default port 80. When the administrator changes the HTTP port of the **DCS-2100+** (which has an IP address of **192.168.0.100**) from 80 to 8080, users must type **http://192.168.0.100:8080** in the Web browser bar.

Using the DCS-2100+ with an Internet browser (continued)

Configuration > Advanced > Network Settings (continued)

Streaming Settings

Control channel port - It can be set to other than the default port **5001** to correspond with the port opened by the firewall.

Audio channel port - It can be set to other than the default port **5002** to correspond with the port opened by the firewall.

Video channel port - It can be set to other than the default port **5003** to correspond with the port opened by the firewall.

Improve audio quality in low bandwidth environment -

In a low bandwidth network environment you can check this option to improve audio quality by sacrificing some real-time synchronization.

WLAN Configuration Settings

SSID - (Service Set Identifier) is a name that identifies a wireless network. Access Points and wireless clients attempting to connect to a specific WLAN (Wireless Local Area Network) must use the same SSID. The default setting is **default**.

Wireless Mode- Click on the pull-down menu; select from the following options:

Infrastructure - connecting the WLAN using an Access Point such as the DWL-1000AP+. (The **default** setting.)

Ad-Hoc – wireless mode used when connecting directly to a computer equipped with a wireless adapter in a peer-to-peer environment.

Using the DCS-2100+ with an Internet browser (continued)

Configuration > Advanced > Network Settings (continued)

- Channel -** The **default** wireless channel setting is channel 6. Select the channel that is the same as the other wireless devices on your network.
- TX Rate-** Select the transmission rate on the network. 22 Mbps is the **default** setting.
- Preamble-** Select **Long** or **Short Preamble**. The Preamble defines the length of the CRC block (Cyclic Redundancy Check is a common technique for detecting data transmission errors) for communication between the Access Point and the roaming wireless Network adapters. **Long Preamble** is the **default** setting. *Note: High network traffic areas should use the shorter preamble type.*
- Data Encryption -** Enable Encryption by clicking on the box. The **DCS-2100+** has Encryption disabled as the default setting.
- Auth mode -** Choose one of the following authorization modes:
- Open Authentication -** Communicates the key across the network.
 - Shared Authentication -** Allows communication only with other devices with identical WEP settings.
 - Auto -** Will automatically adjust to the Authentication mode of the wireless client.
- Key type -** Select the key length, either 64, 128 or 256 bits.
- Key Format -** Select an ASCII or hexadecimal key format.
- Key Index -** You can create up to 4 different security keys.

Click **Apply** to make changes effective



Apply

Using the DCS-2100+ with an Internet browser (continued)

Configuration > Advanced > Mail & FTP

Click the **Mail&FTP** button from the Configuration screen to access video settings that control sending images via email and FTP.

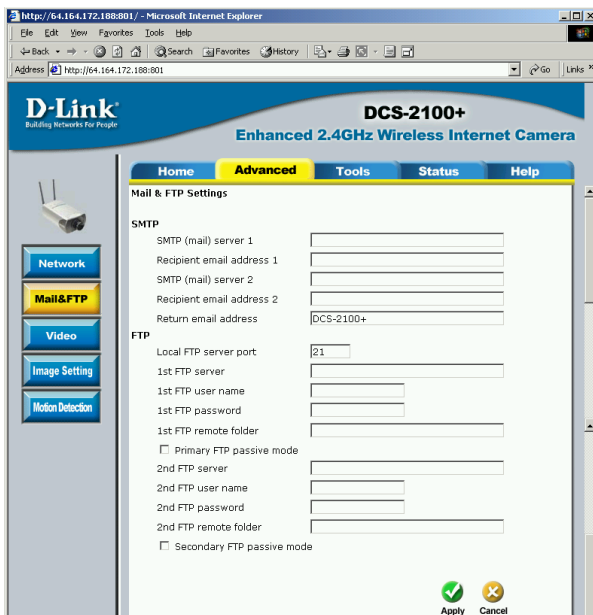

SMTP

SMTP (mail) server 1 - The domain name or IP address of an external mail server.

Recipient email address 1 - The email address of recipients for snapshots or a system log file. Multiple recipients must be separated by a semicolon “;”

SMTP (mail) server 2 - The domain name or IP address of a secondary mail server used if the primary mail server is unreachable.

Recipient email address 2 - The email address of recipients for the secondary server.

Return email address - A return email address to use if the snapshot or system log email fails to send.

Using the DCS-2100+ with an Internet browser (continued)

Configuration > Advanced > Mail & FTP (Continued)

FTP Settings

- Local FTP server port -** It can be other than default port 21. If you find that you want to change the port to a port number other than 21, you will need to specify the port when connecting to the FTP server. For example FTP://68.5.1.81:60 (if you are to use port 60 for your FTP server port)
- 1st FTP server -** The domain name or IP address of the external FTP server. The following user settings must be correctly configured for remote access.
- 1st FTP user name -** Granted user name on the external FTP server.
- 1st FTP password -** Granted password on the external FTP server.
- 1st FTP remote folder -** Granted folder on the external FTP server. The string must conform to the external FTP server. Some FTP servers cannot accept a preceding slash symbol before the path if there is no virtual path mapping. Refer to the instructions of the external FTP server for details. The folder privilege must be open for upload.
- Primary FTP Passive Mode-** If the **DCS-2100+** is located inside a network that is protected by a firewall, a data connection for FTP may be prohibited. Passive mode FTP can bypass this rule and allow the uploading of snapshots. If the passive mode is selected, the **DCS-2100+** can automatically attempt to upload in active mode if the external FTP server does not support passive mode.

Using the DCS-2100+ with an Internet browser (continued)

Configuration > Advanced > Mail & FTP (Continued)

2nd FTP server -	The domain name or IP address of the external FTP server.
2nd FTP user name -	Granted user name on the backup FTP server.
2nd FTP password -	Granted password on the backup FTP server.
2nd FTP remote folder -	Granted folder on the backup FTP server.
Secondary FTP passive Mode -	Passive mode setting for the backup FTP server.

Click **Apply** to make changes effective



Apply

Invalid settings may cause the **DCS-2100+** to not respond. Change the configuration settings only if necessary. Consult with your network administrator or your Internet Service Provider (ISP) if you do not have the necessary information. If you cannot connect to the camera, refer to page 92 for camera **reset** and **restore** factory settings procedures.

Using the DCS-2100+ with an Internet browser (continued)

Configuration > Advanced > Video

Click the **Video** button from the Configuration screen to access video settings that affect how the video image appears.

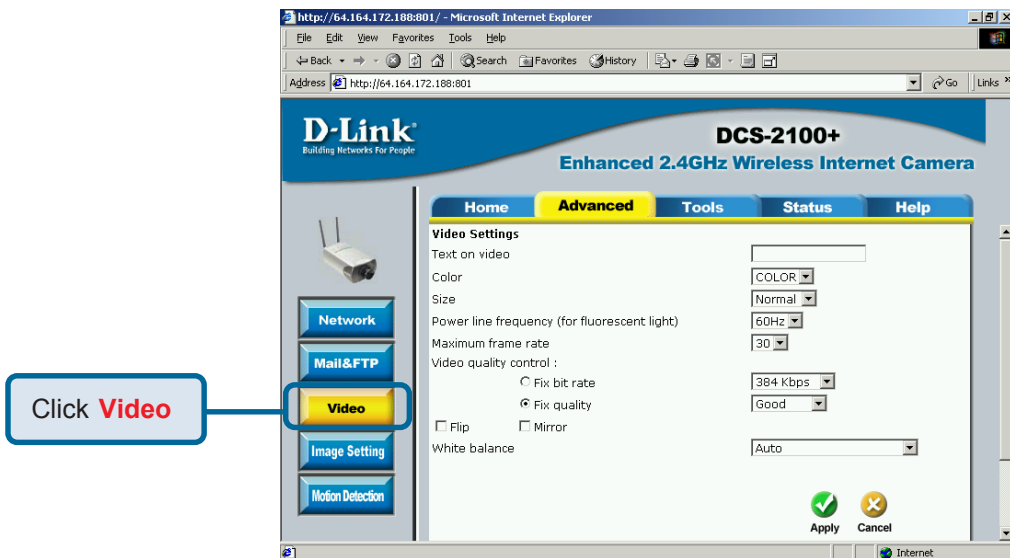

Text on video -

Text will be displayed in the black bar above the video window with the timestamp. The timestamp is captured from the date and time of the **DCS-2100+** and is maintained by a built-in real-time clock.

Color -

Select the option for color or monochrome video display.

Size -

Three options exist for two sizes of video display: **Normal** is the default video display mode. **Half** is a quarter size of **Normal**. **Half x 2** has the same video size as **Normal** but image quality is reduced and it consumes less network bandwidth.

Using the DCS-2100+ with an Internet browser (continued)

Configuration > Advanced > Video (Continued)

Power line frequency (for fluorescent light)

Fluorescent lights may intermittently flash depending on the AC power line frequency. Change the frequency setting to eliminate a flashing image when the light source is fluorescent light.

Maximum frame rate-

Limits the maximum refresh frame rate. The frame rate is used with the **Video quality control** setting (below) to optimize bandwidth utilization and video quality.

Video quality control-

To fix the bandwidth utilization regardless of the video quality, choose **Fix bit rate** and select the desired bandwidth. The video quality may be reduced in order to send maximum frames with limited bandwidth, especially when images change drastically. For higher video detail regardless of the bandwidth selection, select **Fix quality** and select a video quality level. This setting will utilize more bandwidth to send the maximum frames when images change drastically.

Flip -

Vertically rotate the video.

Mirror -

Horizontally rotate the video. Check both **flip** and **mirror** if the **DCS-2100+** is to be installed upside down.

White balance -

Choose the suitable option for the best color temperature.

Click **Apply** to make changes effective



Using the DCS-2100+ with an Internet browser (continued)

Recommendations for setting video for the best performance:

“Best performance” means the image refresh rate should be the fastest possible and the video quality should be the best possible at the lowest network bandwidth possible. Three factors, **Maximum frame rate**, **Fix bit rate**, and **Fix quality** in the **Video Configuration** page, are related to performance.

My priority is real-time motion images

To achieve a real-time visual effect, the network bandwidth should be large enough to transmit 20 image frames per second (fps) or more. If you are on a broadband network over 1 Mbps, you can set **Fix bit Rate** to 1000Kbps or 1200Kbps, or set **Fix quality** to achieve the maximum frames. The maximum frame rate is 25 in 50Hz system and 30 in 60Hz system. If your network bandwidth is more than 384Kbps, you can adjust **Fix bit rate** according to your bandwidth and set the maximum frame rate of 25 to 30.

If the images vary dramatically in your environment, you may slow down the maximum frame rate to 20 to decrease the transmitted data for better video quality. Since the human eye could not easily differentiate between 20 and 25 or 30 frames per second, the slower frame rate will not be noticed. If your network bandwidth is below 384 Kbps, you should adjust the bit rate according to your bandwidth and experiment to allow for the best frame rate that can be achieved. The faster frame rate in a slow network will blur the images. You may also try to choose **Half** in size option for better images or **Half x 2** for larger image size. Because the network has burst constraints and everyone's environment is not the same, any poor connection will impair normal performance.

My priority is clear identification for each image

To have the best video quality, you should set **Fix quality** to **detailed** or **excellent** and tune the **Maximum frame rate** to suit your network bandwidth. If you get some broken pictures in a slow network, you can set **TCP protocol** in **Connection type** for a more accurate transmission but the received images may have a lag. Note that any slow connection with multiple users will impair performance.

Using the DCS-2100+ with an Internet browser (continued)

Recommendations for setting video for the best performance (continued):

I want to compromise between real-time and clear images

If you have a broadband network, set **Fix quality** to **Good** image quality, or higher, instead of setting the **Bit rate**. Otherwise, fix the bit rate according to your actual network speed and set the frame rate to 30. If the image quality is low, select a lower frame rate above 15. If the image quality is still not improved, select a lower bit rate.

Configuration > Advanced > Image Settings

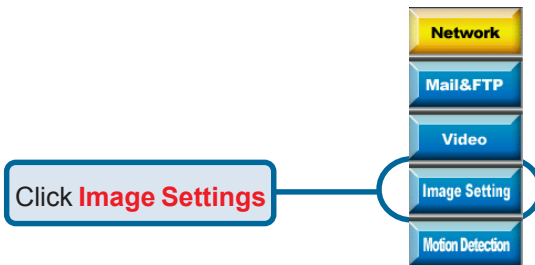

Click the Image Settings button from the Configuration screen to access the settings that affect how the video image appears.

The screenshot shows the Image Settings screen with four adjustable parameters: Brightness (+0), Contrast (+0), Saturation (+3), and Hue (+0). Each parameter has a dropdown menu with a blue arrow. Below the parameters are three buttons: preview, restore, and save.

From this screen you can fine tune the video image.

Image **Brightness**, **Contrast**, **Saturation** and **Hue** are all adjusted in the same manner. For each video compensation you can set from among eleven levels ranged from -5 to +5. The default setting is zero for each adjustment.

You may press **preview** to fine-tune the image and see what affect the setting will have on the image. When the image is acceptable, press **Save** to store the image settings, or **restore** to recall the original settings. If settings are changed without saving, they will be used until the next system start-up.

Using the DCS-2100+ with an Internet browser (continued)

Configuration > Advanced > Motion Detection

Click the **Motion Detection** button from the **Configuration** screen to access settings that affect how the **DCS-2100+** Internet Camera can serve as a security device by recording only when motion is detected.

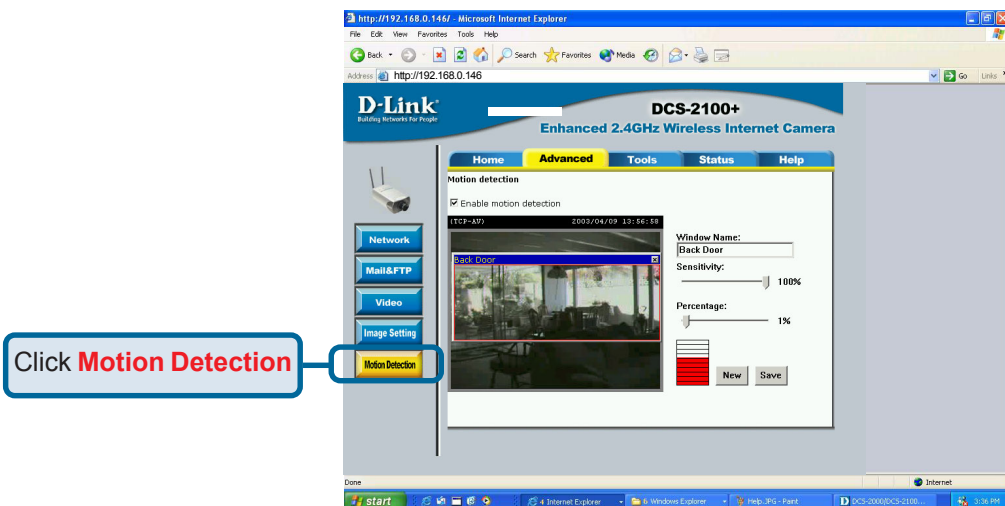

Enable motion detection - Check this option to turn on the motion detection.

Window Name - The text entered here will show at the top of the window.

Sensitivity - Sets the measurable difference between two sequential images that would indicate motion.

Percentage - Sets the amount of motion in the window being monitored that is required to initiate a motion detected alert.

Note: Setting a higher **sensitivity** and a lower **percentage** makes any motion more easily detected.

Using the DCS-2100+ with an Internet browser (continued)

Configuration > Advanced > Motion Detection (continued)

- New -** Click to add a new window. A maximum of three windows can be opened simultaneously. Use your mouse to drag the window frame to resize or the title bar to move. Clicking on the 'x' at the upper right corner of the window will close the window.
- Save -** Saves the related settings of that window.

To display motion detection, a graphic bar will rise or fall depending on the image variation.



A green bar means the image variation is under the monitoring level, and no motion detection alert is triggered. A red bar means the image variation is over the monitoring level and a motion detected alert is triggered. When the bar goes red, the window that the motion is detected in will also be outlined in red (note: remember that you can have up to 3 windows selected for motion detection). You can return to the **DCS-2100+** Home Page and the monitored window will not be visible, but the red frame will show on the home page when motion is detected.

Using the DCS-2100+ with an Internet browser (continued)

Configuration > Tools > Admin

Click on the **Tools** tab to access 4 utility screens for controlling and administering the **DCS-2100+**. The default screen in **Tools** is the **Admin** screen.

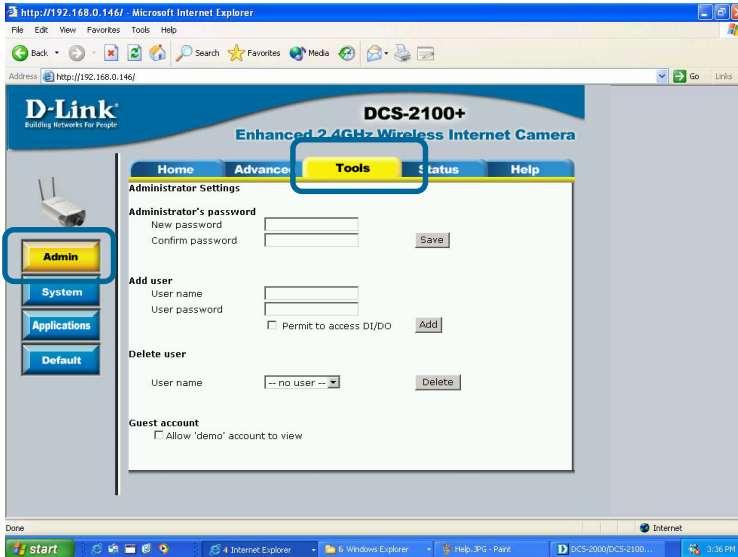

The **DCS-2100+** is manufactured without any passwords by default. This allows the ability to access the **DCS-2100+** (including the Configuration) by anyone as long as the IP address is known. It is recommended that you enter a password if the **DCS-2100+** is intended to be accessed by others.

Type a password in the **New Password** field to enable protection, and then confirm the password in **Confirm Password** field.

This password is used to identify the administrator. You can add accounts with **User name** and **User Password** for other users in the **Add user** section.

You can provide up to twenty accounts for other users / visitors. Each account identifies the access right. This allows multiple visitors to share the same account of different levels. An option to **Permit to access DI/DO** (Digital In/Digital Out) is provided for each account. Some users may need to be prohibited from controlling your attached security devices.

Using the DCS-2100+ with an Internet browser (continued)

Configuration > Tools > Admin (continued)

Guest account: This option allows a user to connect to a camera with view-only privileges. User name is **demo**. No password is required. This is useful for demonstrations and keeps guests separate from users with accounts.

Configuration > Tools > System

Click on the **System** button to access the System settings from the **Tools** menu.

Click **System**

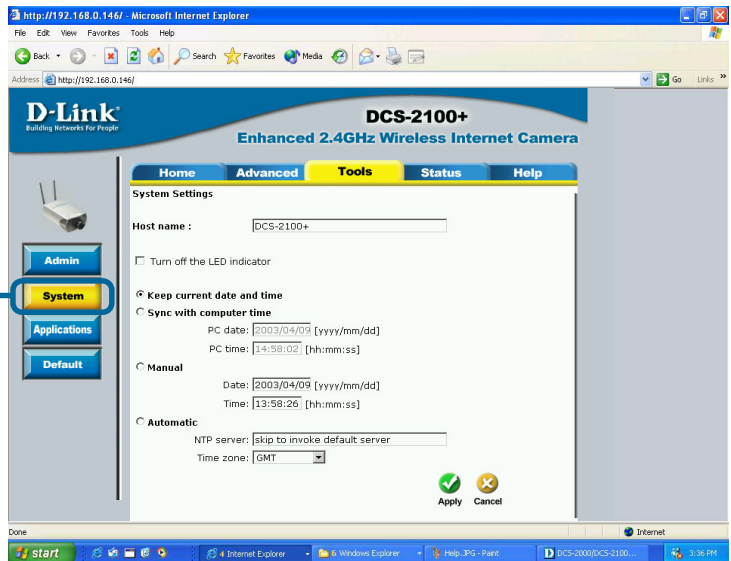

Host name - The text will display as the title at the top of the main page.

Turn off the LED indicator - Check this option to shut off the LED next to the lens. This will prevent anyone from observing the operation of the Internet Camera.

Using the DCS-2100+ with an Internet browser (continued)

Configuration > Tools > System

Keep current date and time -

Click to save the current date and time of **DCS-2100+**. An internal real-time clock maintains the date and time even when the power is off.

Sync with computer time-

Synchronize the date and time of **DCS-2100+** with the local computer. The date and time of the PC is displayed and updated in the **DCS-2100+**.

Manual -

Adjust the date and time according to what is entered by the administrator. Notice the format in the related field while typing.

Automatic -

Synchronize with the NTP server over the Internet whenever the **DCS-2100+** starts up. It will fail if the assigned timeserver cannot be reached.

NTP server -

Assign the IP address or domain name of the timeserver. Leaving the text box blank will let the **DCS-2100+** connect to default timeservers.

Time zone -

Used to adjust the hour of timeservers for local settings.

Click **Apply** to make changes effective



Using the DCS-2100+ with an Internet browser (continued)

Configuration > Tools > Applications

Click on the **Applications** button to access the Applications settings from the **Tools** menu.

The screenshot shows a Microsoft Internet Explorer browser window displaying the D-Link DCS-2100+ web interface. The address bar shows <http://192.168.0.146>. The page title is "DCS-2100+ Enhanced 2.4GHz Wireless Internet Camera". The navigation menu includes Home, Advanced, Tools (selected), Status, and Help. On the left sidebar, there are buttons for Admin, System, Applications (highlighted), and Default. The main content area is titled "Applications Settings" and contains the following configuration options:

- Weekly schedule**
 - Sun Mon Tue Wed Thu Fri Sat
 - snapshots begin at [hh:mm:ss]
 - snapshots stop at [hh:mm:ss]
 - All the time except for the above schedule
- Event operation**
 - General**
 - Delay second(s) before detecting next event
 - Take snapshot at second(s) after event
 - Trigger condition**
 - Input is high Input is low Input is rising Input is falling
 - Detect motion in :
 - Back Door Undefined Undefined
 - Trigger action**
 - Trigger output alarm while input condition matched
 - Trigger output alarm while motion detected
 - Upload snapshots while input condition matched
 - Upload snapshots while motion detected
 - Reset output**
- Sequential operation**
 - Snapshot every second(s)
- Send snapshots by email**
- Send snapshots by FTP**
 - FTP put snapshots with date and time suffix

At the bottom right of the settings area, there are two buttons: "Apply" (with a green checkmark icon) and "Cancel" (with a yellow X icon).

Using the DCS-2100+ with an Internet browser (continued)

Configuration > Tools > Applications (Continued)

Weekly schedule:

Sunday through Saturday - Select the weekdays that should perform the following operations:

Snapshots begin at - Set the time to start operations. Setting the **begin** time the same as the **stop** time will force the operations to run continuously.

Snapshots stop at - Sets the time to stop the operations.

Event operation:

Delay second(s) before detecting next event -

Sets the time delay before restarting to check the trigger condition when the current condition is triggered.

Take snapshots at second(s) after event -

After a snapshot is taken because of a trigger, another snapshot will be taken after the configured time in seconds.

Trigger condition -

There are 4 conditions related to the digital input and three windows for motion detection. There can be multiple selections. Select the appropriate digital input condition according to the characteristics of the external device. **High** or **low** indicate external voltage input for level trigger, while **rising** or **falling** is for edge trigger. There are three windows shown for the name you defined for motion detection. **Undefined** will show instead of the window title if motion detection is not setup yet.

Reset output -

Check and save this option to reset the external device at the digital output back to the original state.

Using the DCS-2100+ with an Internet browser (continued)

Configuration > Tools > Applications (Continued)

Trigger action -

There are four options for two actions regarding either trigger condition. They can have multiple selections. While choosing the trigger output alarm, the digital output will short both pins to connect the circuit of the attached external device; otherwise both pins will be open. While choosing to upload snapshots, the method can be either email or FTP. The snapshot names will be “videopre.jpg”, “videotrg.jpg”, and “videopos.jpg” respectively for the snapshots before event, right upon event, and after event. The date and time suffix may be added according to the option. Confirm the external mail or FTP server settings in network configuration.

Sequential operation

Snapshot every second(s) -

The camera will send snapshots at the specified interval to the external server according to the chosen method. Remember this operation is dependent to the weekly schedule.

Send snapshots by email - Any upload action specified in the options above will use the method chosen here. The captured snapshot named “video.jpg” will be attached in the email with subject “Periodic snapshots.”

Send snapshots by FTP - The captured snapshots will upload to the external FTP server with the file name depending on the next option.

Using the DCS-2100+ with an Internet browser (continued)

Configuration > Tools > Applications (Continued)

FTP put snapshots with date and time suffix -

If the suffix is added, the captured date and time can be easily differentiated from the snapshot file name in either sequential or event operation. For instance, “video@20020102030405.jpg” means the JPEG image was captured at 4 minutes and 5 seconds after 3 o'clock, January 2nd, A.D. 2002. If the suffix is omitted, the file named “video.jpg” on the external FTP server will be refreshed at the specified interval.

Click **Apply** to make changes effective



Configuration > Tools > Default

Click on the **Default** button to access the factory **Default** settings from the **Tools** menu.

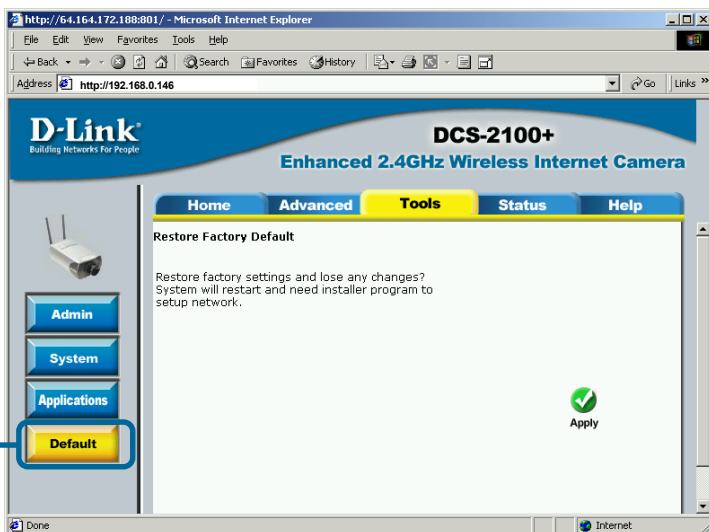

Click **Default**

Click **Apply** on the screen to restore the factory default settings. This means any changes made will be lost and the system will be reset to the initial status when shipped from the factory. After confirmation, the system will restart and require the **IP Installer** software program to setup the **DCS-2100+**.

Using the DCS-2100+ with an Internet browser (continued)

Configuration > Status > Device Info

Click on the **Status** tab to access **Device Info** and a **Log** of **DCS-2100+** system activity. The **Device Info** is the default screen when you click on the **Status** tab.

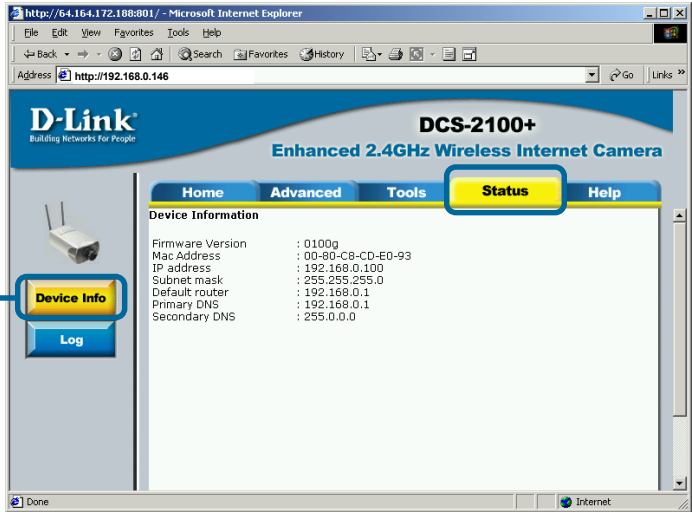

The Device Info screen lists the following important settings that are currently set for the **DCS-2100+**

- Firmware Version number
- Mac Address
- IP Address
- Subnet Mask
- Default router address
- Primary DNS address
- Secondary DNS Address

Using the DCS-2100+ with an Internet browser (continued)

Configuration > Status > Log

Click on the **Log** button to access a system log of system activity from the **Status** menu. The content of the log file reveals useful information about the current configuration and connection logged after the **DCS-2100+** boots up.

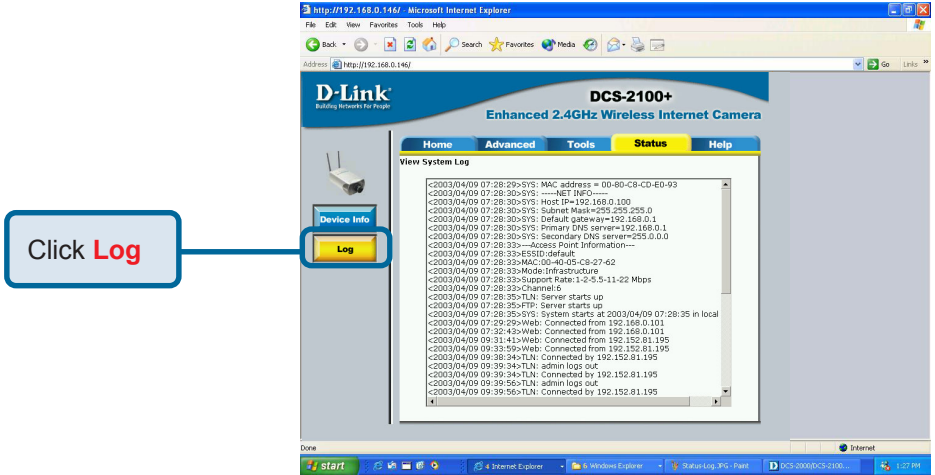

Configuration > Help

Click on the **Help** tab to access descriptions of the particular function you need help with. The help screen is organized in the order of the tabs and then each menu item under that tab.

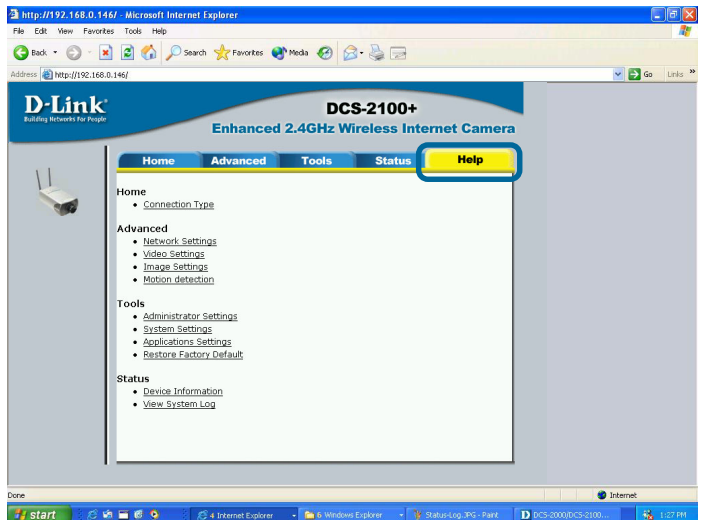

Using IP Surveillance Software

Upon completion of the installation of the **IP Surveillance** software, you can run the **Monitor** program (for monitoring and recording from the **DCS-2100+**) from the Windows folder:

Start\ Program Files\D-Link\IP Surveillance\Monitor

or the directory you specified during the installation.

There is also a **Playback** program (for accessing and playing video captured in the Monitor program.) The Playback program is detailed starting on page 70.

Before using the **IP Surveillance** programs you will be asked to set the admin (administrator) password. The admin password should be at least 6 characters in length.

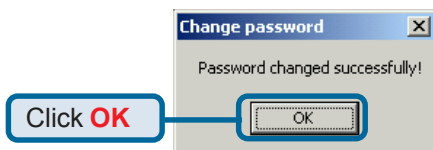

A successful message box will show if you set the admin password successfully.

Monitor Program

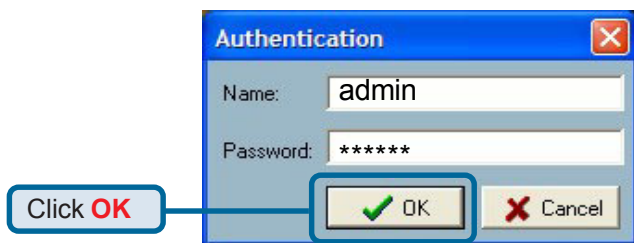

An Authentication dialog box will appear. Enter “**admin**” as the login for the first time and enter a password. You will see the **Monitor** program on your display.

Using IP Surveillance Software (continued)



Control up to 16 **DCS-2100+** Internet cameras from this screen.

Minimum Requirements for Multiple Camera Configurations:

For 1 to 4 channels:

Minimum Requirements

OS: MS Windows2000/XP/ME/98SE

CPU: Intel 500 MHz Pentium III or above

SDRAM: 128 MB SDRAM

Hard Disk: 40GB

For 5 to 9 channels:

Minimum Requirements

OS: MS Windows2000/XP

CPU: Intel 933 MHz Pentium III or above

SDRAM: 128 MB SDRAM

Hard Disk: 40GB

For 10 to 16 channels:

Optimal Requirements

OS: MS Windows2000/XP

CPU: Intel 2.0 GHz MHz Pentium IV or above

SDRAM: 256 MB SDRAM

Hard Disk: 40GB

Display Chip: nVidia, TNT2, GeForce with 32 MB display memory or above

Using IP Surveillance Software (continued)

Monitor Program Main Screen:

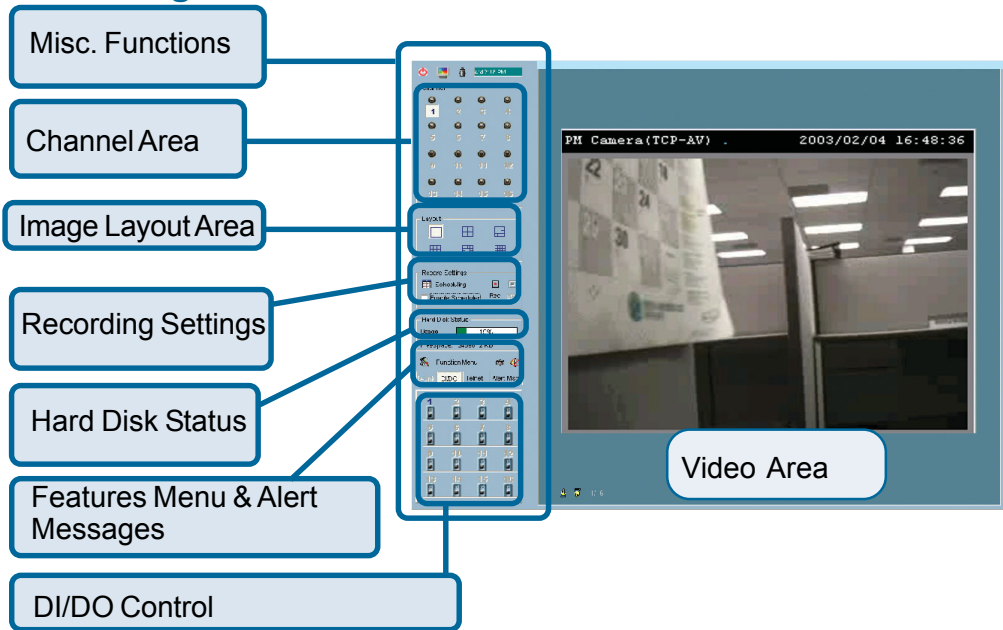

Descriptions of the sections of the **Monitor** program Main screen:

- **Miscellaneous functions:**
Including quitting the application, snapshot, full screen monitoring, and the Function menu for setting Global Settings, Camera Configuration, and Backup of data. Tips are provided when you move the mouse cursor on them.
- **Channel area**
This area displays the status of each video channel (camera) including: connection, recording, camera selected, and alert information.
- **Video area**
In this area, you can see the video of the accessed channel, and some convenient controls.
- **Layout area**
You can change the monitoring layout in this area such as 1 fullscreen image of 1 camera or up to 16 images of different cameras.

Using IP Surveillance Software (continued)

■ Recording settings

You can record video onto your hard disk. The recording schedule is configured in the Scheduler.

■ Hard disk status

In this area, you can get the hard disk status. This informs you of the available disk space remaining.

■ DI/DO control

Receive the digital input signal and send digital output signal.

■ Alert Message

Display the last alert messages.

Logging In

You need to login to use the **IP Surveillance** software system. There are two privileges in the account-password system: the admin (administrator) and the general user.

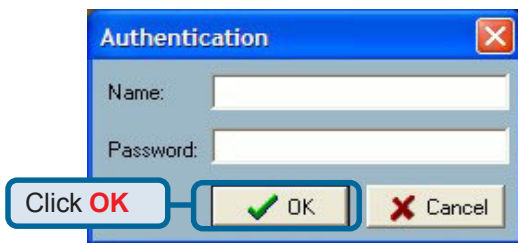

If you have administrator privileges, you have the right to do the following:

- Run the configuration tool
- Change the recording schedule
- Change the local settings

General users can only monitor the surveillance videos and change the layout of the **Monitor** program, but they do not have the right to change any configuration settings including recording schedules and local settings.

Using IP Surveillance Software (continued)

Configuring a DCS-2100+ in IP Surveillance

When you first login, you should configure the **DCS-2100+** from the **Camera Configuration** screen found in the **Function** menu. Once you set up the administrator privilege, you can access the **Camera Configuration** screen.

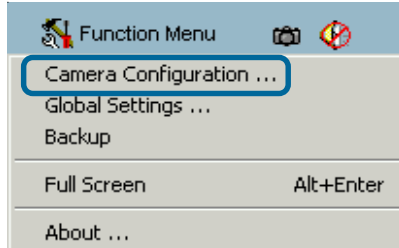

A warning message will appear to warn you that any recording that is occurring will stop when you access **Camera Configuration**.

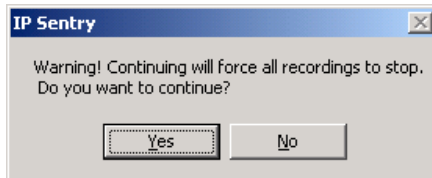

Home > Camera Configuration Screen

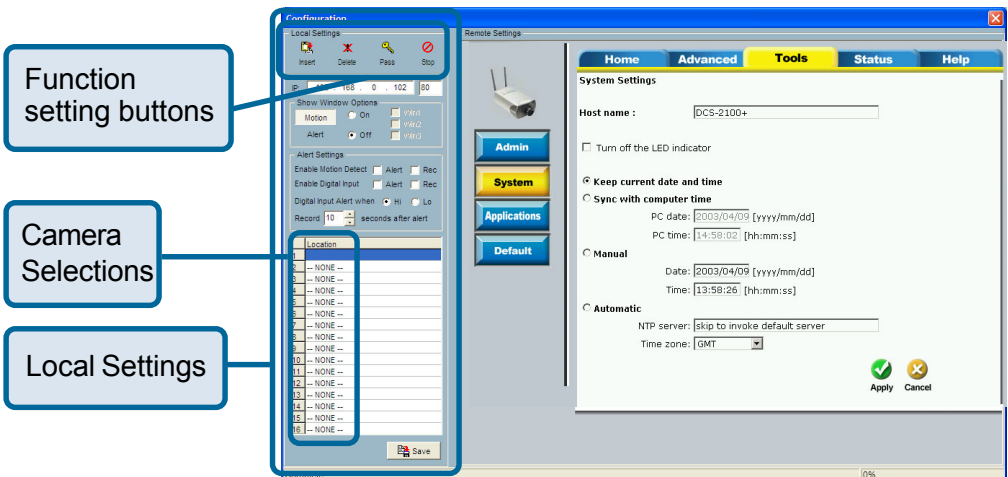

The screenshot shows the 'Configuration' window with several callout boxes:

- Function setting buttons:** Points to the 'Local Settings' tab and the 'Admin', 'System', 'Applications', and 'Default' buttons.
- Camera Selections:** Points to the 'Location' list in the 'Local Settings' panel.
- Local Settings:** Points to the 'Motion' and 'Alert' settings in the 'Local Settings' panel.

The 'Local Settings' panel includes:

- IP: 192.168.0.102
- Show Window Options: Motion (On/Off), Alert (Virt1/Virt2/Virt3/Virt4)
- Alert Settings: Enable Motion Detect, Digital Input, Digital Input Alert when (Hi/Lo), Record (10 seconds after alert)
- Location list: 1-16, NONE

The 'System Settings' panel includes:

- Host name: DCS-2100+
- Turn off the LED indicator (checkbox)
- Keep current date and time (checked)
- Sync with computer time (radio button)
- Manual: Date: 2003/04/09, Time: 13:58:26
- Automatic: NTP server: skip to invoke default server, Time zone: GMT
- Buttons: Apply, Cancel

Using IP Surveillance Software (continued)

Home > Camera Configuration Screen (continued)

In the **Local Settings** there are four main functions:



Insert – To add cameras to the camera list, specify the IP address and port, click the **Insert** button. The program will try to connect to the **DCS-2100+**. If the connection succeeds, the admin password of the remote **DCS-2100+** camera is required. If you provide the correct password, the camera will be inserted in the list.

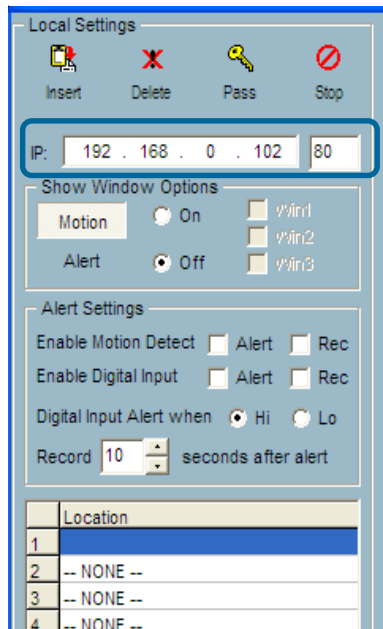

Delete – This will delete the selected camera from the camera list.

Password – Changes the local “admin” password.

Stop – Provides a way to stop the network connection if the connection freezes for a long time.

Using IP Surveillance Software (continued)

Changing the Camera Order in the List

You can drag and drop the gray area (fixed area) of the camera list grid to change the arrangement of cameras. This makes it easy to rearrange the cameras.

Left-click in the gray area.

Move the mouse to the location you want and release the mouse button. Here video 1 will be moved to the 10th row.

Location	Location
1 Video 1	1 -- NONE --
2 -- NONE --	2 -- NONE --
3 -- NONE --	3 -- NONE --
4 -- NONE --	4 -- NONE --
5 -- NONE --	5 -- NONE --
6 -- NONE --	6 -- NONE --
7 -- NONE --	7 -- NONE --
8 -- NONE --	8 -- NONE --
9 -- NONE --	9 -- NONE --
10 -- NONE --	10 Video 1
11 -- NONE --	11 -- NONE --
12 -- NONE --	12 -- NONE --
13 -- NONE --	13 -- NONE --
14 -- NONE --	14 -- NONE --
15 -- NONE --	15 -- NONE --
16 -- NONE --	16 -- NONE --

Motion Window and Alert Settings

Show Window Options

Motion On Win1

Alert Off Win2 Win3

Alert Settings

Enable Motion Detect Alert Rec

Enable Digital Input Alert Rec

Digital Input Alert when Hi Lo

Record 10 seconds after alert

Show Window Options – If **Motion Detection** is enabled for the selected **DCS-2100+** camera, each motion window can be turned on in **Show Window Options**. Once the motion window is turned on, it will be shown as a green rectangle in monitoring screen. If you just want to see the motion window when alerted, you can also turn on the alert window separately. The alert window will be shown in red rectangle when an alert occurs.

Alert Settings – Some special actions can be performed, such as generating an alert sound or starting recording when motion is detected or a digital input is triggered. The digital input can be high-triggered or low-triggered. It depends on your setting. You can also specify the period to record after the alert-trigger.

Using IP Surveillance Software (continued)

Saving the Changes

Once you click the **Save** button, the changes in the configuration will be saved and will validate immediately.

Global Settings

Click on the **Global Settings** item from the **Function Menu**.

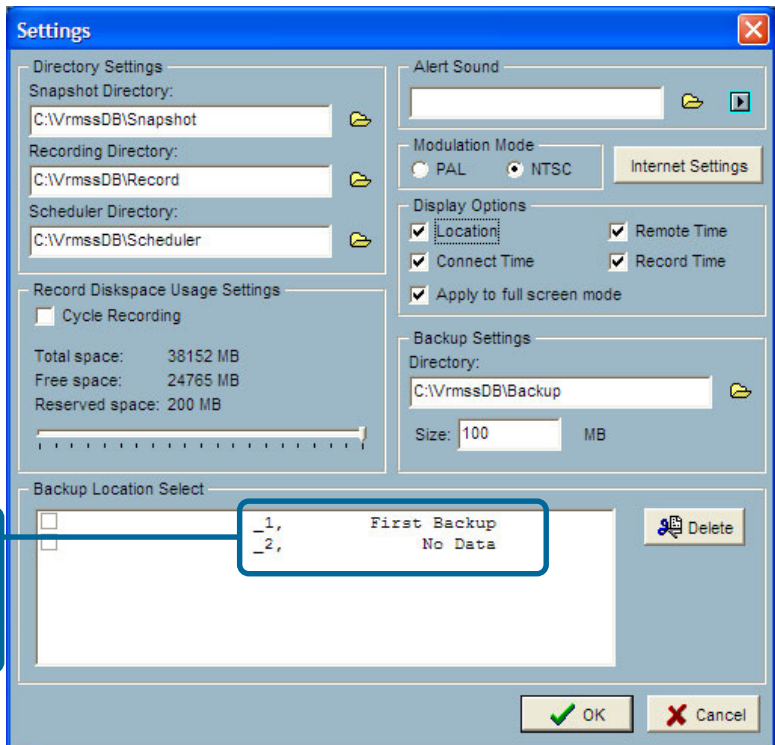
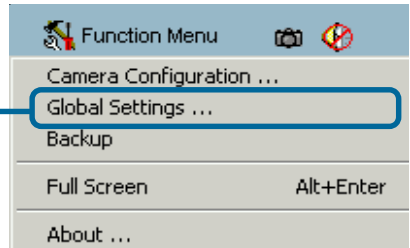

This area indicates backup status and last backup time

- Snapshot Directory** – The directory for storing the snapshot data.
- Recording Directory** – The directory for storing the recorded video data.
- Scheduler Directory** – The directory for storing the schedules used for recording.

Using IP Surveillance Software (continued)

Reserved space – Indicates how many bytes should be reserved on the hard disk. If the recording data exceeds disk capacity, the new video data will replace the oldest data (if **Cycle Recording** box is checked). This space can be adjusted with the sliding bar below it.

Modulation Mode – For selecting the input signal format (NTSC for US use, or PAL that is used mostly in Europe).

Alert Sound – Select the sound file of your choice in Windows to play when there is an alert.

Display options – In each video frame, there are two status bars which contain **Camera location**, **Connect time**, **Remote time** and **Record time**. All of them can be individually enabled here.

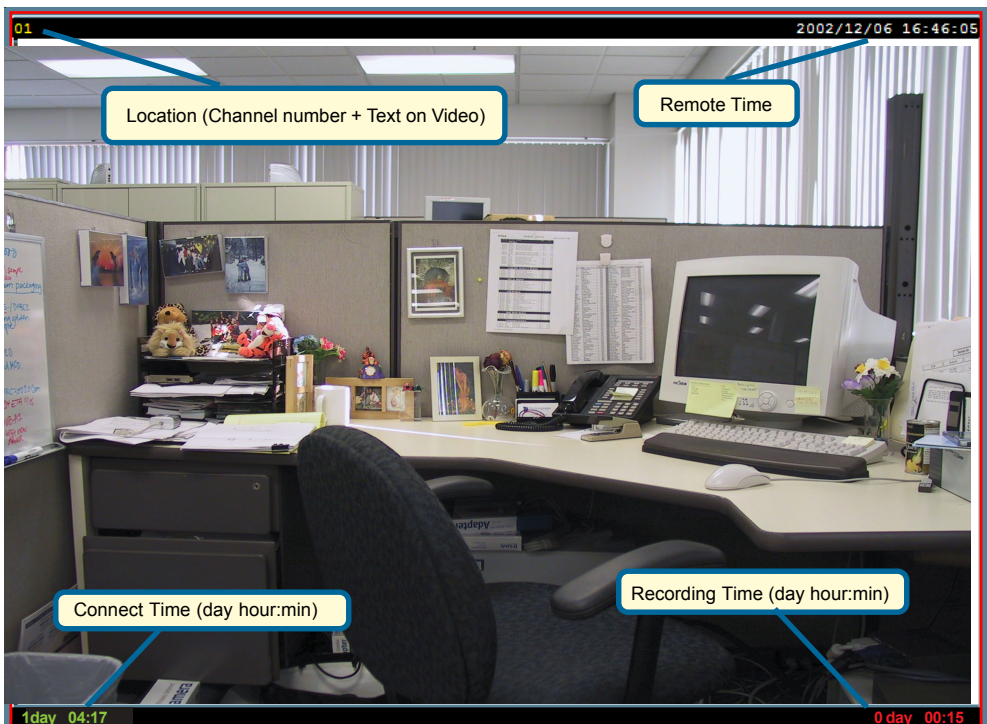

Backup Settings – Select the backup directory, the backup size of your media, and the backup locations. You can also delete backup locations here. The maximum locations cannot exceed 32.

Last Backup Time – Indicates the last time a backup occurred. **All Backup** means all the data in this location has been backed up, and **No Data** means there is no data stored in this location.

Internet Settings – Set the proxy and IP filters.

Using IP Surveillance Software (continued)

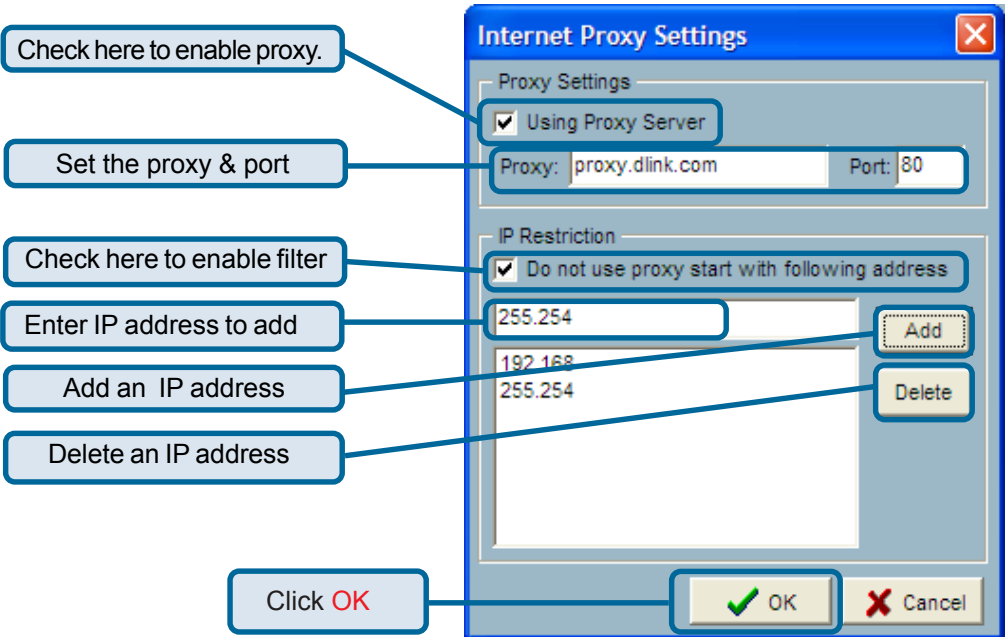

If you enable proxy server and enable IP restriction, the listed IP addresses will not use the proxy.

Connecting to the DCS-2100+

Once you connect to the **DCS-2100+**, you can drag and drop a camera into the **video area** to begin viewing video from the camera.

In the **channel area**, if you do not set up the camera, the color of the **camera number** will be gray. Once you set up the camera, the color of the **camera number** will turn to blue. You can drag and drop the camera into the **video area**, and apply other features if you have the privileges by logging on as an administrator (admin).

There is a unique light signal above each camera's number. This indicates the status of the camera:

- Off** – Camera is not connected.
- Green** – The green light means the camera is connected.
- Red** – The red light indicates the camera is both connected and in recording mode.
- Blink** – If motion detection is enabled, an alert occurs and the light will blink.

Using IP Surveillance Software (continued)

Adding a Channel:

Adding a new camera as a channel can be accomplished with a simple drag and drop procedure. After you have inserted the camera from the **Camera Configuration** screen in the **Function Menu**, the channel number (shown below) will change from grayed out to blue (see page 55 to **Insert** a camera):

1. Click on the number of the camera that was inserted previously:
2. Hold the mouse button down and drag the channel number onto a droppable video area. The video from the new camera will be displayed in this video display and the light above the camera number changes from off to green.

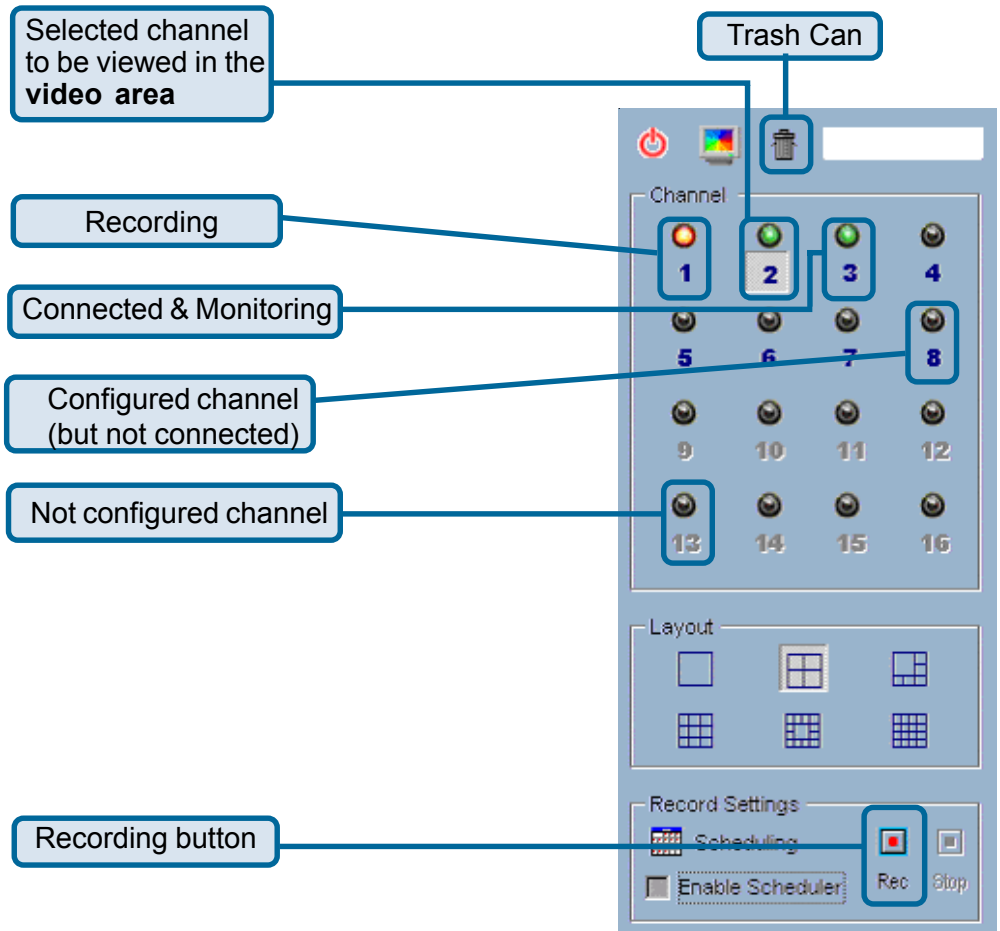

Using IP Surveillance Software (continued)

Stop Monitoring a Channel:

To stop monitoring a video channel, you can drag and drop the video (in the **video area**) to the **trash can**. To delete a channel:

1. Select the video display of the channel to be discarded.
2. Move the mouse cursor to the channel number.
3. Press and hold the left mouse button, the cursor will change if the cursor is located in a droppable area.
4. Drag the cursor to the trash can and release the mouse button to delete the channel.

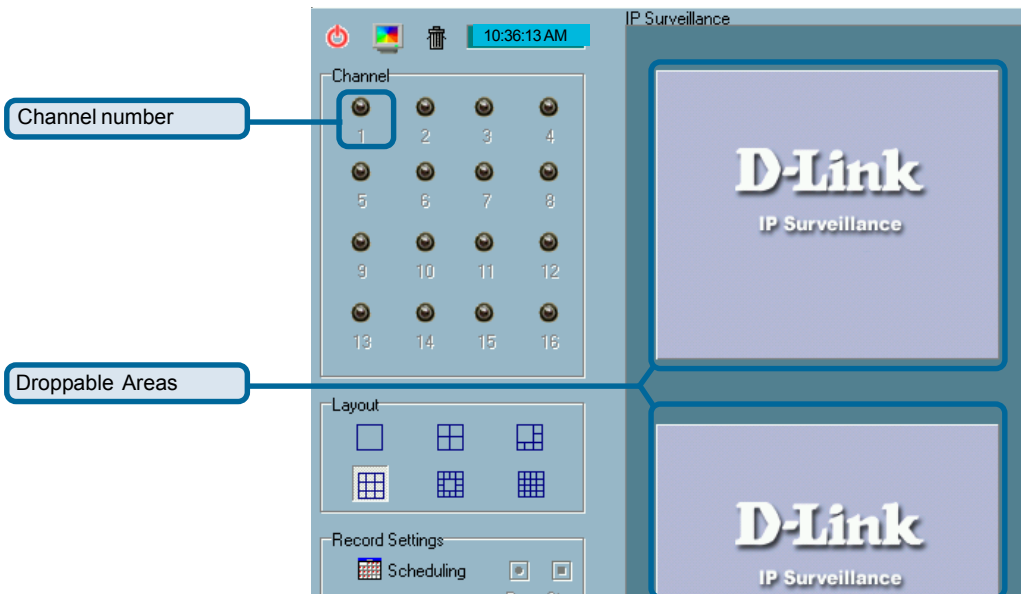

Moving Channels to Another Video Area:

The drag and drop procedure also applies to the moving or exchanging of video channels. In the **video area**, if you want to exchange the videos of different channels, you can drag the video and drop it where you want to locate the video. If the destination **video box** is empty, then the video in the source **video box** will be shown on the destination **video box**, and the source **video box** will be empty. If the destination **video box** contains video of some channel, then the videos in the source and destination **video box** will be exchanged.

Using IP Surveillance Software (continued)

The Layout

There are six layouts in the monitor tool. You can select (by left-clicking on the icon) which videos you want to monitor. In each layout, you can drag and drop the “channel number” to any video box in the video area. If all conditions are okay, then the video will appear in the video box, and the old video is replaced.

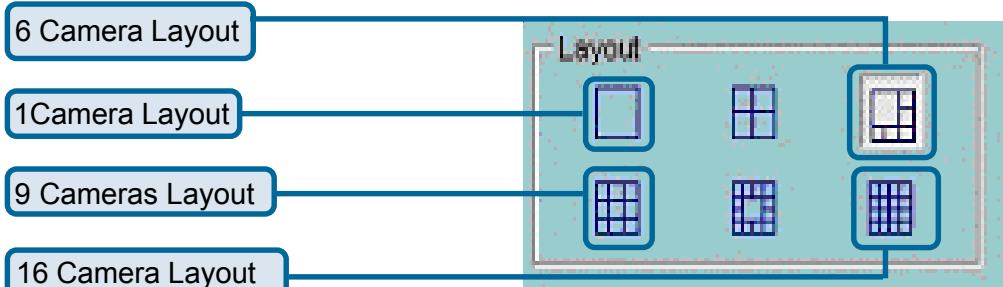

The video positions in each layout are saved for the next time the layout is selected for monitoring.

When you want to view one individual camera, you can double-click on the video in the **video area**. The layout has now changed to the larger, single image display. You can click the **up** or **down** button to view different cameras, and clicking the **Back** button will switch to the previous selected layout.

Back to Previous Layout

Double-click to switch to larger size Video

Switch Between Cameras

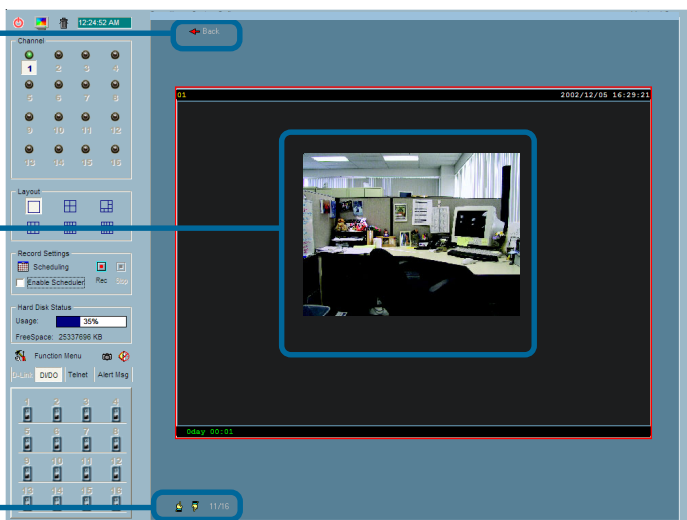

Using IP Surveillance Software (continued)

Record & Schedule



Record – Record the selected channel manually.



Stop – Stop recording the selected channel manually.



Scheduling – Arrange recording schedule

Enable Scheduler – Record according to the scheduler settings.

DI/DO Control

Only one user with the administrator privilege can access the DI/DO control at the same time. Refer to the following figure to control.

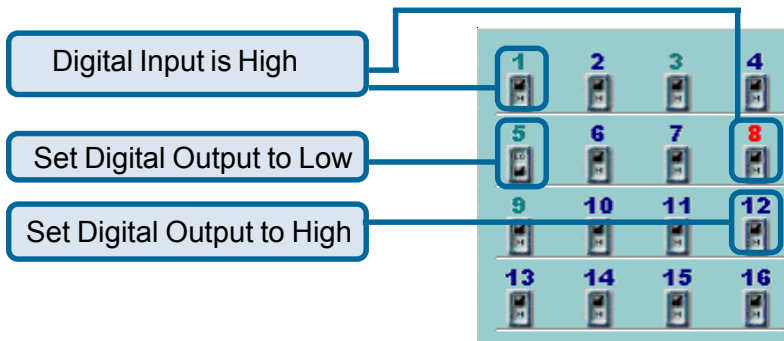

Alert Message

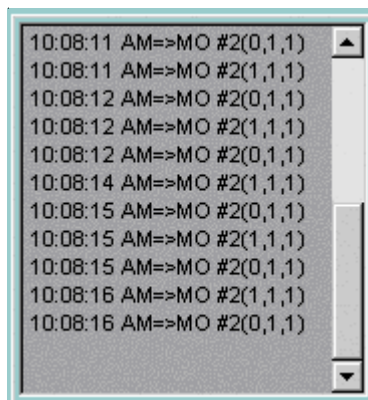

Using IP Surveillance Software (continued)

If you turn on the **Alert** function, and a trigger is set off by motion, an alert message will show in this window. The message format is described as follows:

“time”=>“alert type” #“channel number”(“win1”,“win2”,“win3”)

For example, the message “03:47:25 PM=>MO #5(0,1,1)” means that a motion detection alert occurred at 03:47:25 PM in motion window 2 and in motion window 3.

Backup

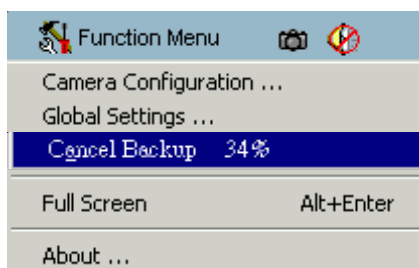
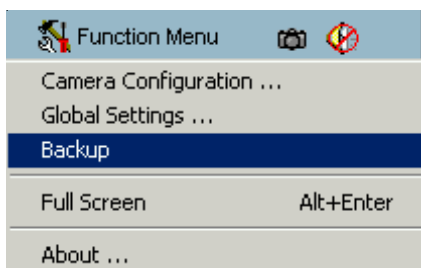

The **Backup** function archives recorded data based on the location and size you previously selected in **Global Settings**. You can duplicate the backup data to a removable device such as CD-ROM, ZIP disk, DVD-RAM or tape manually. After the backup starts, you cannot configure the camera or change any settings. You can cancel the backup process by selecting the **Cancel Backup** option. After the backup completes, a message appears informing you the backup is complete.

Using IP Surveillance Software (continued)

Miscellaneous Functions



Quit – Closes the application and saves last settings.

Full Screen – Switch to full screen video, double click the screen to return to the previous view.

Local Time – Displays the current time.

Snapshot – Takes a snapshot from the selected video and saves it as a bitmap file. You can set the directory in **Global Settings**.

Stop Alert Sound – Whenever an alert occurs, the alert sound will start to play. You can press this button to stop the alert sound and see the alert messages.

Scheduling

The recording scheduler helps you to schedule the recording time of the video from the **DCS-2100+**. You can easily specify the time of recording via both the graphic user interface and time period selection. Features include:

- Easy to use graphical user interface
- One-on-one camera scheduling
- Up to 9 schedule schemes for each camera
- Automatic period recording

To enable scheduling, click the **Enable Scheduler** box in the **Record Settings** from the main screen of the **Monitor** program.

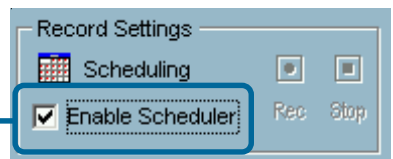

Using IP Surveillance Software (continued)

The layout of the scheduler tool is divided into 9 sections. For ease of use, you may skip to section 7. In section 7, when you input the date, hour and minute, the times you have selected will appear in the Hour, Day, Week and Month time-lines (sections 1,2,3 and 4 illustrated here.)

Section 1 of the scheduler tool is the **Hour time-line**. When you input the hour in section 7 it will be illustrated in **section 1**. Alternately, you can enter the scheduling hour in this timeline although it may be a less efficient method of inputting the information. You can refer to the **Schedule With Time Lines** section in the following pages.

Section 2 is the **Day time-line**. When you schedule the day in section 7, the result is displayed here.

Section 3 is the **Week time-line**.

Section 4 is the **Month time-line**.

Section 5 is the **Current year selector**. Choose the year here that will be displayed in Section 7.

Section 6 is the **camera selection and editing** area it provides the IP addresses and location information for your reference. There is an editing schedule space for saving a temporary schedule. This will be explained in further detail on the following pages.

Section 7 consists of **Begin time selector, End time selector, Period selector, Addition button, and Erase button**. These components help you choose a period of time in which to add or delete records in the schedule.

Section 9 contains the operation buttons. These will be explained in the following pages.

Section 8 is the **Time Period selector**. Select the period of time at which the settings will apply. The **Add** and **Erase** buttons are also in this section. A detailed explanation of these features can be found in the following pages.

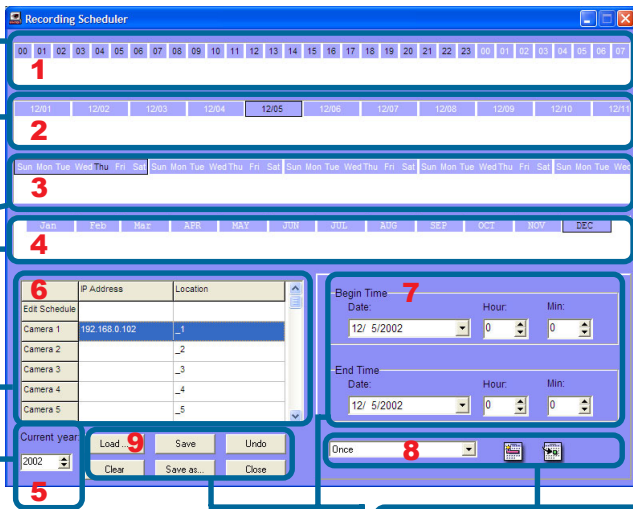

Using IP Surveillance Software (continued)

Current Year Settings And Camera Selector for the Recording function

By default, the scheduler is running with the current date selected on the time-lines and **Date-time picker**. Therefore, the current scheduling year is the year that you run the scheduler tool. To change the year setting:

Use the up (increase) and down (decrease) arrows to adjust the year setting.

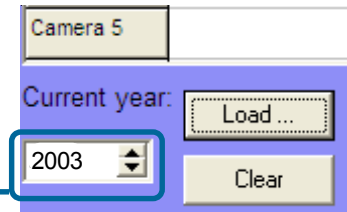

The **Date-time selector** in [Section 7](#) (see above) will change the year concurrently. If you change the year with the **Date-time selector**, the current year setting will also be changed.

The following is the **Camera selector**:

	IP Address	Location
Edit Schedule		
Camera 1	192.168.0.102	_1
Camera 2		_2
Camera 3		_3
Camera 4		_4
Camera 5		_5

Camera

Here you can make two kinds of schedules: a schedule associated with a specific camera, or a general schedule that is not applied to a specific camera.

If you want to make a schedule that does not belong to any camera, select the first row for editing.

If you want to create a schedule for a specific camera, then click on the row of the camera you wish to schedule. Select the **Begin** and **End Times**. Add any other settings you wish to make. Click the **Add** icon to save the changes.

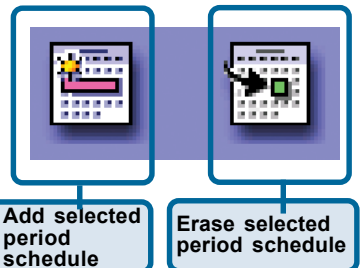

Using IP Surveillance Software (continued)

If users have configured the **IP Surveillance** software and the **DCS-2100+** camera, the IP address and location will show the correct setting. Please note that when users switch between cameras, the changing of the schedule will be saved automatically.

The Schedule-Record-File operations

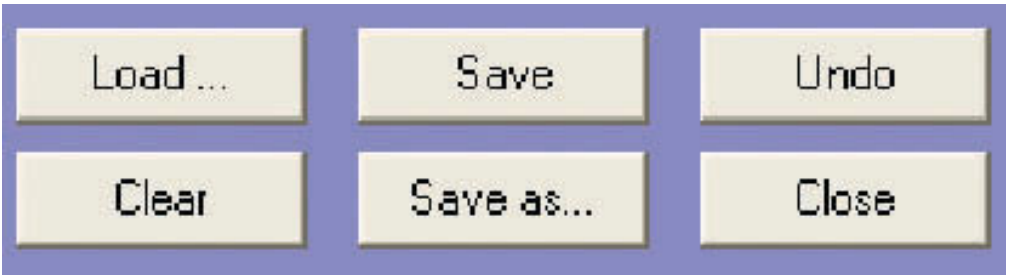

There are six related buttons. These buttons are illustrated on a prior page, as section 9 in the Scheduling window:

- Load:** This operation allows the users to load other schedules from the schedule database for this camera.
- Clear:** This operation will clear all the schedule markers in the current editing area.
- Save:** This button is for applying the changes for the current schedule.
- Save As:** To save the current schedule-record-file to another file name.
- Undo:** Undo the most recent changes.
- Close:** Click **Close** to close this window.

Using IP Surveillance Software (continued)

Schedule with Time Picker

Remember to make the **Begin Time** earlier than the **End Time**. Otherwise the **Add** action will be ignored.

Select period

Once

Every Hour

Every Day

Every Week

After you have made your **Begin Time** and **End Time** selections, select a period. You may want to record only **Once**, or you may want to record **Every hour**, **Every day**, **Every week** or **Every Month**.

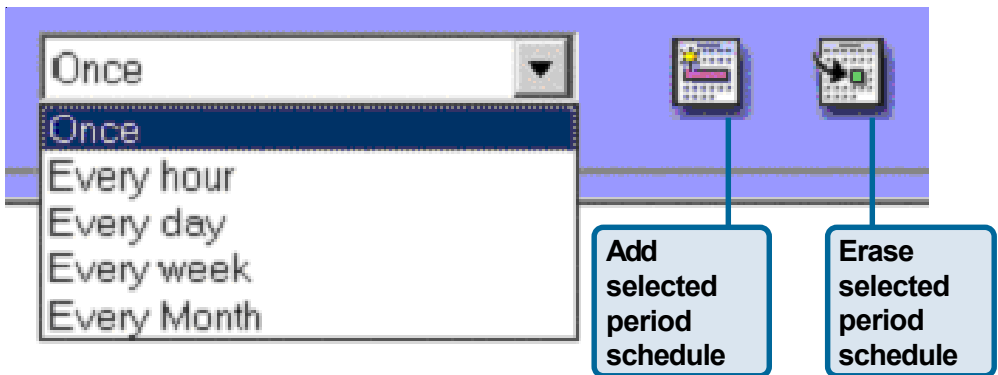

When you choose **Every Hour**, the recording scheduler will be guided only by the minutes setting. **Every hour** recording will occur during the minutes that have been selected. (e.g., if the **Begin Time** was 2:20pm and the **End Time** was 7:40pm then the recording would be in effect from 20 minutes past the hour to 40 minutes past the hour for every hour of the day.)

Similarly, if you choose **Every day** then only the hour and the minute setting will apply. If you choose **Every week** then only the day of the week, the hour and the minute settings are valid. For **Every Month**, only the date (excluding the month and year), the hour and the minute are valid settings.

Using IP Surveillance Software (continued)

Playback Program

The **Playback** program is a powerful tool to assist you in browsing the recorded video database. It has two display modes (Normal display mode, Preview Mode) and three playback methods (Full Range, Time Period, Events Preview). The main tools it provides include:

Powerful play control tool:

- Play
- Stop
- Pause
- Fast play (from x1 to x16)
- Slow play (from /1 to /16)

Convenient display adjustment tool:

- Zoom in
- Zoom out
- Full screen

Flexible searching range adjustment tool:

- User input (from full range to 1 second)
- Zoom in (from full range to 10 seconds)
- Zoom out (up to full range)
- Page searching
- Full range

Various exporting tools:

- AVI file transducer
- BMP file snapshot
- Output to printer directly

Using IP Surveillance Software (continued)

Playback Program (continued)

Installation of the **IP Surveillance** software is detailed in an earlier section of this manual titled **Installation of IP Surveillance Software** under the main section titled **Software Installation**.

Logging-in

Before you start the **Playback** software program, it is necessary to login. For security reasons, only the administrator account can login to **Playback**. To change the password of the admin account refer to the section of this manual titled **Logging-In** located in the main section **Using IP Surveillance** software.

After completing the installation of **IP Surveillance**, you can run the **Playback** program from:

Start\Program Files\D-Link\IP Surveillance\Playback
or the directory you specified during the installation.

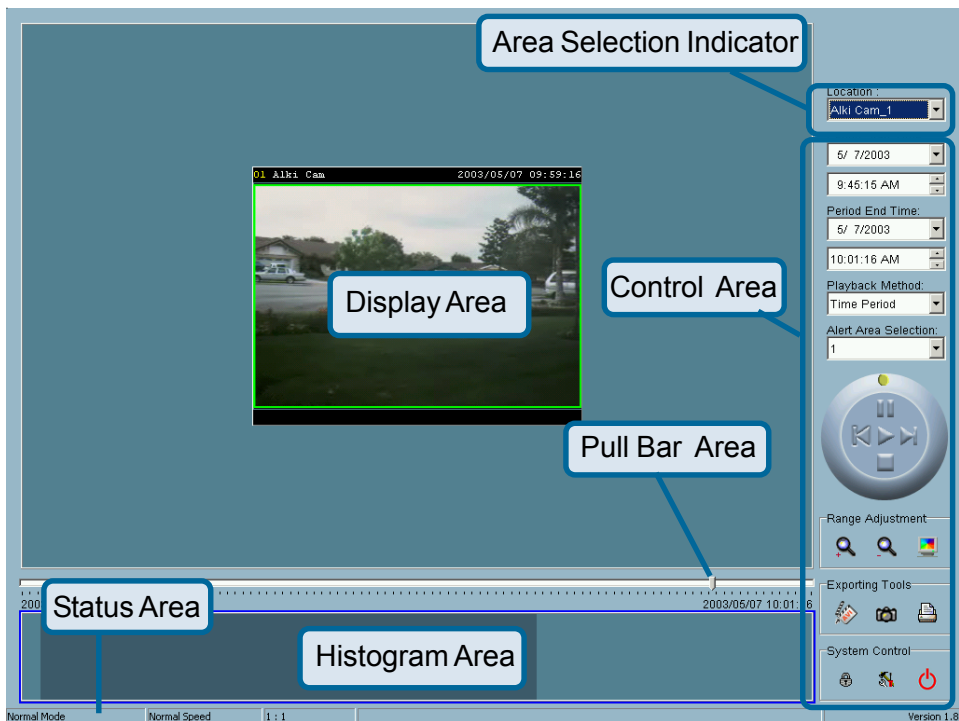

The main window will be shown on the top of the screen and the display resolution will change to 1024x768 automatically. There are four main areas in the window: **Display area**, **Histogram area**, **Control area**, and **Status area**. There are also three controls the **Area selection indicator**, the **Frame selection indicator**, and the **Pull bar**. Explanations of the main Playback screen follow:

Using IP Surveillance Software (continued)

Playback Program (continued)

Display Area

The display area shows the surveillance database of each camera by events triggered by an alert or by time. You can change the video size through the **Display Adjustment Tool**, and the playback method through the **Play Control Tool**. Under the normal display mode you can double click on the frame area to change the frame size to a 1:1 or 2.25:1 ratio. In the Preview mode, double clicking on any frame area can change the display mode to normal and show a 10-second interval including the event you selected.

Histogram Area

The histogram is an interactive control. Not only can you get the event's location in terms of time, but you can select a group of events or period from the event histogram area and show it on the display area.

Control Area

The control area contains almost all the control selectors and toolboxes you need to browse the database (except the page control). The **Page Control Tool** is located on the right-bottom corner of the display area when the program is operating in the preview mode. These control tools include location selector, period selector, playback method selector, jog dial, display adjustment tool, exporting tool, and system control tool.

Status Area

The **Status Area** is located at the bottom of the main window. It tells you about the program status including display mode, display size, display speed, exporting file format, and exporting file name.

Area Selection Indicator

In the main **Playback** screen as shown above the display area has been highlighted with a yellow rectangle. This rectangle is the area selection indicator. This indicator can be set to either **Display Area** or **Histogram Area**, by moving your mouse cursor to the Area you want to select. When you select the **Display Area**, the **Display Adjustment Tool** will appear in the control area, and if you select the **Histogram Area**, the **Display Adjustment Tool** will disappear and the **Searching Range Adjustment Tool** will be shown in the control area.

Using IP Surveillance Software (continued)

Playback Program (continued)

Frame Selection Indicator

The frame selection indicator only appears when you change the display mode to **Preview Mode**. It appears as a red rectangle surrounding one of the nine **Event Preview Frames**. Once you select one of these frames, you can control its play status through the jog dial in the control area.

Pull Bar

The **Pull Bar** is a fast, flexible control for seeking data in the selected time period. It represents the total length of time in that period. You can click or pull the indicator on the pull bar to the point you want to see. And the current displaying video will halt and start to play the video sequence from the point you choose. If the video sequence has been paused, the display area will show the point you select without playing. The **Pull Bar** will only function under the normal display mode.

Settings

After the main window is shown on the screen, you must modify the settings to make it work properly. Click on the **Settings** button in the system control tool, and the dialog box appears on the screen as shown below:

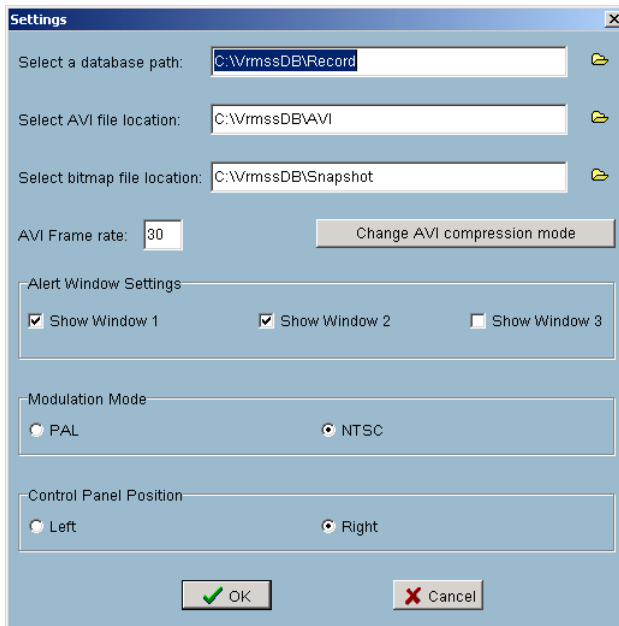

Explanations of the **Settings** screen are on the following pages.

Download from www.Somanuals.com. All Manuals Search And Download.

Using IP Surveillance Software (continued)

Playback Program (continued)

Database path

The most important item in the settings dialog is the database path setting. You must set it to the directory that contains the surveillance database to make the program work properly.

AVI file location

It sets the storing directory when you export AVI files. The exported AVI files will be stored in the sub-directory under the directory you set here with the name of the location you select.

Bitmap file location

It sets the directory to use the for snapshots when exported as bitmap files. These exported bitmap files will be stored in the sub-directory under the directory you set here with the name of the location you select.

AVI Frame rate

This setting sets the amount of frames per second that will be used to convert a saved video into an AVI file.

Change AVI compression mode

During the AVI compression mode selection, you can select one of the compression methods that your computer supports to export the AVI file.

Alert window settings

There are three alert windows you can activate during using the monitor program. In the playback program, you can choose whether these alert windows will be shown or not. If you check one window, then you will see that rectangle in green or red color shown in the displaying video sequence.

Modulation mode

The modulation mode should not be changed without knowledge of the various modes. The quality of the video depends on how you recorded the video sequence in the monitor program. If you select the wrong mode, the video shown in the display area will become deformed. If you choose the wrong modulation mode, you may open the settings dialog again, change to the correct mode, and restart the playback program, It should then display properly.

Using IP Surveillance Software (continued)

Playback Program (continued)

Control panel position

With this setting you can place the Control panel on either the left or the right of the screen.

Once you change the setting of modulation or Control panel position, you have to restart the program to for these changes to take effect. If you set the database path correctly, the video sequence will start displaying in the normal display mode when you click on the **OK** button.

Normal (Single Frame) Mode

You can enter the **Normal Mode** when you:

- Change the database path in the settings dialog
- Change the location selector to another location
- Change the playback method selector to **Full Range**
- Change the playback method selector to **Time Period**
- Double click on one of the nine frames in the display area under the preview mode.

Under the single frame mode, you can use all the tools the playback program provided except the **Page Control**. In this mode, the two labels under the pull bar show the start and end time of the period individually as shown below:

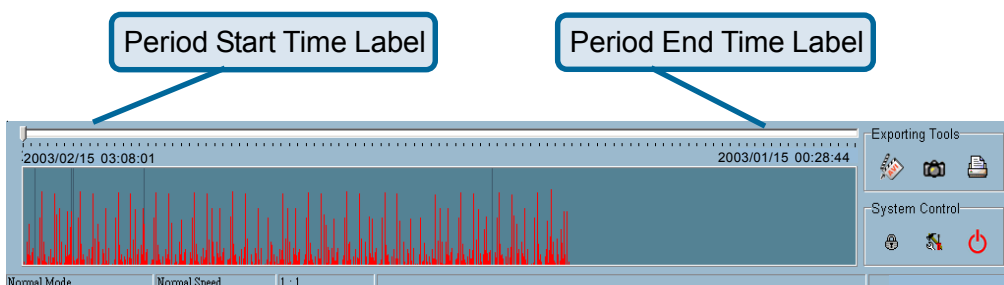

Histogram Area

The **Histogram Area** in the single frame mode only shows the event's occurred time and the percentage of motion detection with red bars. If you want to access the **Histogram Area**, you must change the **Area Selection Indicator** to the **Histogram Area**. You can select a color-inverted region by dragging your mouse with the left button pressed. When you release the left button, the color-inverted region will be enlarged to the whole histogram area.

Using IP Surveillance Software (continued)

Playback Program (continued)

This color-inverted region will be the new time period the program is going to display. If you change your mind and don't want to see that period, you can cancel it by just pressing the right button of your mouse with the left button still pressed. If you click on the left button without dragging it, the action will be the same as clicking on the **Pull Bar** in the same x-axis position. The dark regions mean there is no video data in that interval. If you click on those regions, nothing will happen except a warning message.

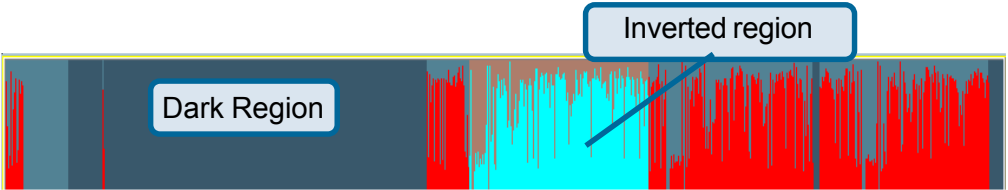

Preview (Multiple Frame) Mode

You can enter the preview mode only when you change the playback method selector to **Events Preview**. Preview Mode helps you to identify the objects triggering the events via not only the time information and the alert percentage, but also the video preview playing. This allows you to easily examine different alert situations. Under the **Preview Mode**, the **Pull Bar**, **Transducer button** in **Exporting Toolbox**, and the **Display Adjustment Toolbox** are all disabled. The two labels under the pull bar show the displayed event number and the total event count individually. There are nine frames in the display area and these are referred to as “one page”. Each frame displays a 10-second interval video sequence that contains different events. You can use the **Page Up** and **Page Down** button in the page control to browse the events in the selected period with nine events per page. And the page status tells you the current page number and total page count as shown below:

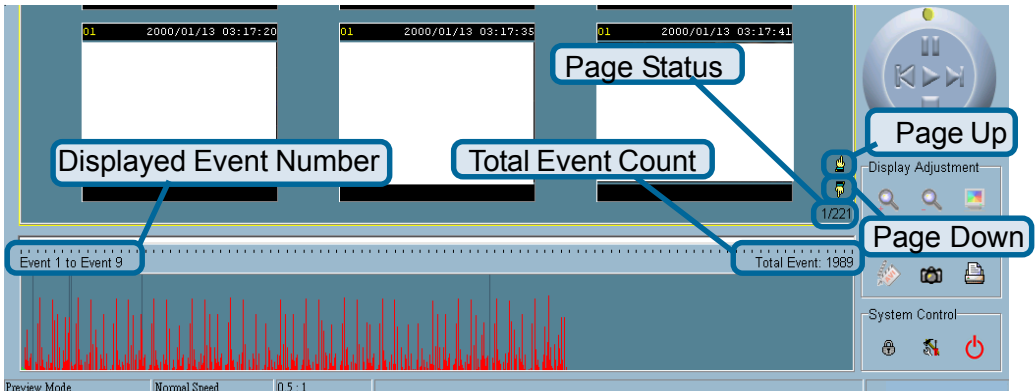

Using IP Surveillance Software (continued)

Playback Program (continued)

Histogram Area

The **Histogram Area** in the **Preview Mode** displays events that occurred previously as red bars, which represent the time and value of the event. Currently displayed events are represented by green bars and the selected event with blue bars. If you want to access the histogram area, you must change the **Area Selection Indicator** to the **Histogram Area**. You can select a color-inverted region by dragging your mouse with the left button pressed.

When you release the left button, the color-inverted region will be enlarged to the whole **Histogram Area**. This color-inverted region will be the new period the program is going to display. If you change your mind and don't want to see that period, you can cancel it by just pressing the right button of your mouse with the left button still pressed. If you click on the left button without dragging it, the display area will show the event page closest to the point you select. The dark region means there is no video sequence in that interval. If you click on these dark regions a warning dialog will appear to inform there is no video sequence available.

Selector tools

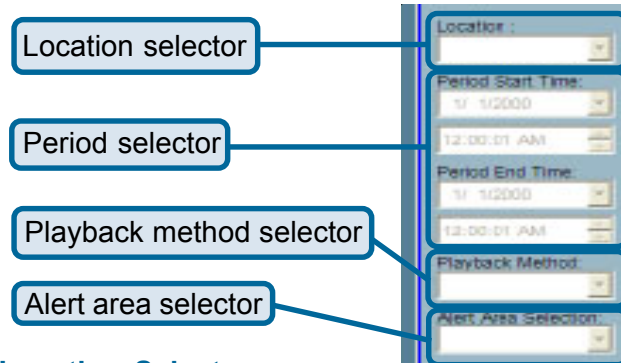

Location Selector

The location selector is a control that lets you select the camera you want to see. The location information is the same as the location specified in the monitor program (see **Global Settings** in the **Monitor** program section). If there is more than one database in the same location, another dialog will appear (see below). You must select an interval in that dialog. The **Playback** program will automatically switch to that camera and start displaying.

Using IP Surveillance Software (continued)

Playback Program (continued)

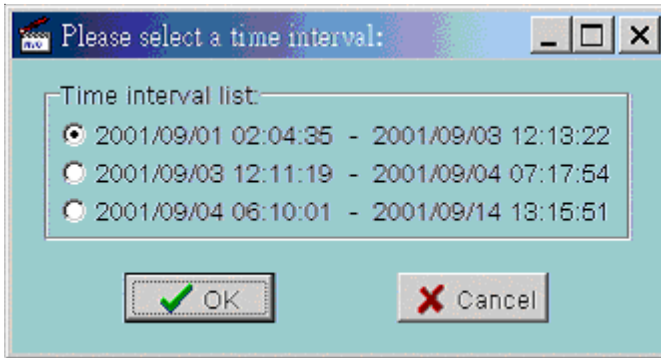

Period Selector

Period selector provides a precise way to choose the start time and the end time of a new period. The end time must be later than the start time. After you give the correct start and end time, clicking on the **Play** button in the jog dial will play the new period in the Display Area. If you change the period start and end time label, the **Pull Bar** and **Histogram Area** will change, too. If the selected period is not present in the database, the data in the **Period Selector** will change to the previous correct start and end time and a warning message will be displayed.

Playback Method Selector

Full Range

If you select this method, the database will be displayed from the beginning to the end of this location. Any change in the period selector will take no effect unless you change this selector to **Time Period**.

Time Period

If you change the playback method to **Time Period**, you can modify the start and end time in the period selector. When you click on the **Play** button in the jog dial, the period you select will be displayed.

Events Preview

This method will change the display mode from the normal display mode to the **Preview Mode**.

Using IP Surveillance Software (continued)

Playback Program (continued)

Since the program will record the previous start and end time in **Time Period** and **Events Preview** mode. Any time you want to change the period selector to see another period, you must change the **Playback Method Selector** to the mode you want to use first. Otherwise, the Period Selector will revert back to the previous data used in **Playback Method Selector**.

Alert Area Selector

In the **Preview Mode**, the **Playback** program only can show the event information of one alert window at a time. If you want to see the events of the other two alert area windows, you must change the alert area selector to other alert window numbers. In the normal display mode, the alert window that the alert area selector indicates will be highlighted with red rectangle if you checked that window in the settings dialog. The alert area selector will be changed to alert window zero, when you change the location selector to another one.

Play Control

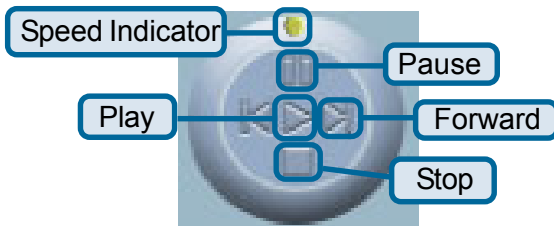

For the play control, a jog dial is used to provide the easiest way to control the displaying video sequence. Except the **Play** button, all other buttons can control the displaying frame in the normal display mode and the selected displaying frame in the **Preview mode**.

Play

The **Play** button is an intelligent play interface. The function of this button will vary depending on differing circumstances. In the normal display mode, clicking on the **Play** button can restart the displaying video sequence. When in the **Preview Mode**, if you don't change the data of **Period Selector**, clicking on this button only restarts the selected displaying frame. If the data of the period selector has been changed, clicking on the **Play** button will restart all frames to display the first nine events in the new period.

Using IP Surveillance Software (continued)

Playback Program (continued)

Stop

When you want to stop the displaying video sequence, you can click on the **Stop** button. Once you have pressed the **Stop** button, the start point will be reset to the start of the present period.

Pause

The **Pause** button provides you a way to pause the displaying video sequence. When the displaying video is paused, clicking on the **Pause** button again will continue the video to display.

Step Forward

This button is only valid when the displaying video sequence is paused. It will display the next frame in that period when you click on the **Step Forward** button one time.

Fast Play and Slow Play

The **DCS-2100+** supports up to 16X fast forward play and slow forward play. If you want to change the playing speed, move the speed indicator. To increase playing speed, move the indicator in the clockwise direction. And to decrease playing speed, move it in the counterclockwise direction. The current speed you set will be shown in the second column of status area.

Display Adjustment Toolbox

Using the **Display Adjustment Toolbox**, you can change the displaying video sequence to the size you want to see in the normal display mode when you move the area selection indicator to the display area. Below is the **Display Adjustment Toolbox** and its own three elements, i.e. **Zoom In**, **Zoom Out**, and **Full Screen**.



Zoom In

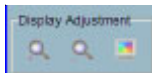

When you click on the **Zoom In** button one time, the image size in the display area will be magnified 12.5 percent to the original size. The maximum zoom-in ratio 2.25:1 for NTSC modulation mode and 1.875:1 for PAL modulation mode. If you want to see the image in more detail, you can use the full screen function in the same toolbox.

Using IP Surveillance Software (continued)

Playback Program (continued)



Zoom Out

When you click on the **Zoom Out** button one time, the image size in the display area will be reduced 12.5 percent to the original size. To show the location and time information completely, the minimum zoom out ratio is limited in 0.5:1.



Full Screen

When you click on the **Full Screen** button, the video sequence will be enlarged to fill the whole screen. You can double click on any place to return to the original state. When you switch to full screen display, you can press the **Alt** and **Space** keys together to pop the jog dial to control the displaying video sequence. Press the same keys again will close the jog dial. You can also press the **Alt** and **Enter** keys together to switch between the normal display and full screen display at any time when the program is under the normal display mode.

Searching Range Adjustment Toolbox

The **Searching Range Adjustment Toolbox** provides you a faster way to change the range of the displayed time period. By using this toolbox, you can browse the database of one location from any 10-second interval over its entire range. Below is the **Searching Range Adjustment Toolbox** with its own three elements: **Zoom In**, **Zoom Out**, and **Full Range**.



Zoom In



Each time you click on the **Zoom In** button in the searching range adjustment toolbox, the displayed time period will be half in the center of the original time period until the period is equal to 10 seconds. You can see the new interval in more details. The scale of pull bar and alert histogram window changes and the period start and end time change, too. The period selector will show the new start and end time. And the display area will restart to display the new period from the new start time.

Using IP Surveillance Software (continued)

Playback Program (continued)



Zoom Out

Each time you click on the **Zoom Out** button in the searching range adjustment toolbox, the displayed time period will be double in the center of the original time period unless the start time or end time exceed the database boundary. The scale of pull bar and alert histogram window changes and the period start and end time change, too. The period selector will show the new start and end time. And the display area will restart to display the new period from the new start time.



Full Range

As you click on the **Full Range** button, you will get the same functionality as if you changed the **Playback Method Selector** to **Full Range**.

Exporting Toolbox

You can check the database through the **Playback** program and also export the database to other media. Using the Exporting Toolbox, you can export the database to other more portable formats, such as AVI file, bitmap file or paper. Then you may use Programs such as *Microsoft® Windows Media Player* or other programs to browse the exporting data. Under the normal display mode, you can use all the exporting tools. And under the **Preview Mode**, only snapshot and print can be used. Shown below are three elements of the **Exporting Toolbox: Transducer, Snapshot and Print**.



Transducer

Using the **Transducer** tool, you can convert the displayed video sequence to an AVI format file. Just click on the **Transducer** button and a dialog box appears (shown below) asking to confirm transforming a database into an AVI file. When you click on the **OK** button, the conversion procedure will be started.

Using IP Surveillance Software (continued)

Playback Program (continued)

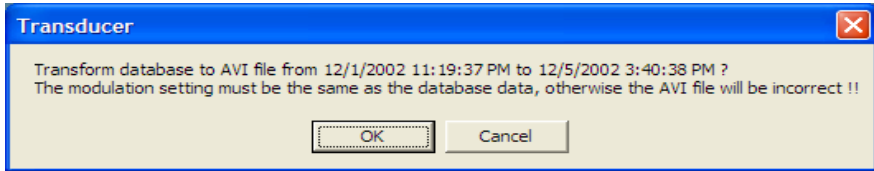

The time required to Export data depends on the speed of the computer and processor that you are using. At any time during the export, you can click on the **Stop** button in the jog dial to stop the procedure. Then you will get an AVI file from the start time to the time you clicked the **Stop** button. The exported AVI filename will be generated automatically and will be listed in the fourth column of the status area. If you want to change the output directory, you can go to the **Settings Window** (See Page 73). To increase the quality of an exported AVI file, it is suggested to set the video format to normal size (please refer to the **Camera Configurations** section on Page 54 and Page 35 for setting the video format).



Snapshot

When you click on the **Snapshot** button one time, the program will export a bitmap. In the normal display mode, the exporting bitmap is the image shown in the display area. And in the **Preview Mode**, it is the image that you selected through the **Frame Selection Indicator**. The size of the bitmap will be the same as that of the image you select. The exported bitmap filename will be generated automatically and listed in the fourth column of the status area. If you want to change the output directory, you can go to the **Settings** window.



Print

When you click on the **Print** button, a dialog box appears. After you make your selection and send to the printer, the images on the Display Area will be printed out.

Using IP Surveillance Software (continued)

Playback Program (continued)

System Control Toolbox

The System Control Toolbox provides basic operations for the playback program. The three elements of the system control toolbox: **Lock Window**, **Settings**, and **Quit**.

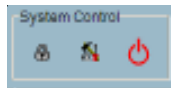

Lock Window

To protect your computer while left unattended you can click on the **Lock Window** button to lock the main window. Once you click this button, the main window will be hidden and the login dialog will appear. To return to the main window, you need to enter the admin password again.



Settings

The settings dialog will pop up when you click the **Settings** button. For more information regarding these settings see Pages 73 and 74.



Quit

The playback program will terminate when you click on the **Quit** button. If the AVI exporting procedure is running, this procedure will be stopped first.

Firmware Upgrades

The **DCS-2100+** Internet Camera supports firmware upgrades (the software that controls the operation in the **DCS-2100+**). D-Link will supply the latest firmware version on the D-Link support Web site at: **support.dlink.com**.

To upgrade the firmware:

Download the latest firmware file from D-Link.

Click on the file **Upgrade Wizard** located on the CD enclosed with the **DCS-2100+**.

Power on the **DCS-2100+** and connect it to the Ethernet port of your computer. The Wizard will ask for the IP Address of your camera and for your administrator password:

D Upgrade Wizard

With power applied to the device, enter the device IP address and Administrator's password, click on "Next" below. Depending on the communication environment, the procedure can take up to 1 minute.

IP address : 192 . 168 . 0 . 3

Administrator's password *****

Click **Next**

Next **Cancel** version : 1.1

The Upgrade Wizard will attempt to find the **DCS-2100+**. If it cannot, an error message indicating this will appear.

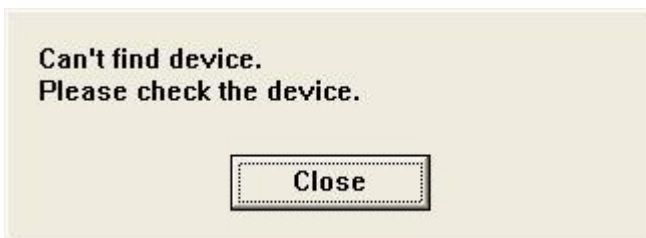

Firmware Upgrades (continued)

If the Upgrade Wizard finds the Internet Camera the following screen asks for the file name or gives you the choice to browse for the file. The file name should be **FLASH.BIN** for the **DCS-2100+** Internet Camera.

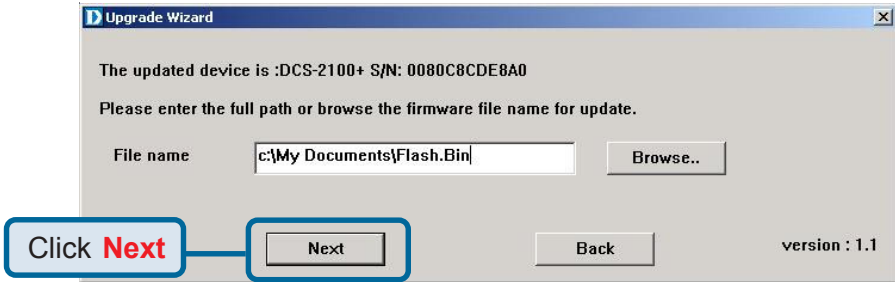

The firmware file is scanned by the Upgrade Wizard and the version is reported to you.

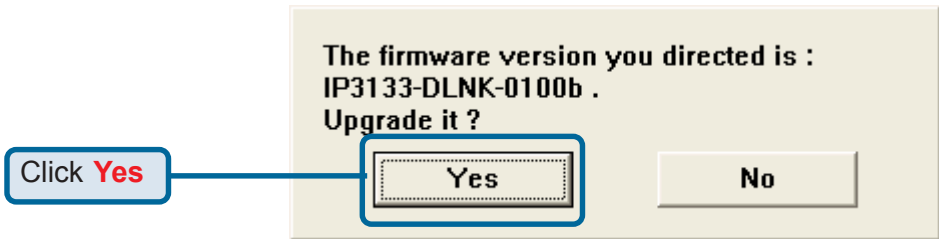

After clicking **Yes** the upgrade begins. The progress of the upgrade is displayed on the this screen:

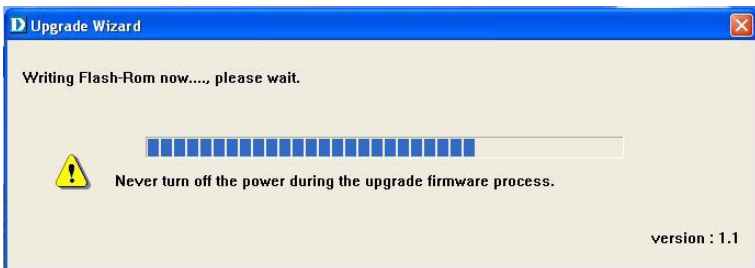

Firmware Upgrades (continued)



Warning



The download firmware procedure cannot be interrupted. If the power or network connections are broken during the download procedure it might possibly cause serious damage to the Internet Camera.

Appendix

Frequently Asked Questions

Internet Camera Features

Q: What is an Internet Camera?

A: The Internet Camera is a standalone system connecting directly to an Ethernet or Fast Ethernet network. It differs from a conventional PC Camera, the Internet Camera is an all-in-one system with built-in CPU and Web-based solutions providing a low cost solution that can transmit high quality video images for monitoring. The Internet Camera can be managed remotely, accessed and controlled from any PC/Notebook over an Intranet or the Internet from a Web browser.

Q: What is the maximum number of users that can be allowed to access DCS-2100+ simultaneously?

A: The maximum number of users that can log onto the Internet Camera at the same time is 10. Please keep in mind the overall performance of the transmission speed will slow down when many users are logged on.

Q: What algorithm is used to compress the digital image?

A: The Internet Camera utilizes H.263+ MPEG-4 Short Header Mode image compression technology providing high quality images. MPEG is a standard for image compression and can be applied to various Web browser and application software without the need to install extra software.

Q: Can I capture still images from the Internet Camera?

A: Yes you are able to capture still images with the snapshot function from the software application CD supplied with the Internet Camera.

Internet Camera Installation

Q: Can the Internet Camera be used outdoors?

A: The Internet Camera is not weatherproof. It needs to be equipped with a weatherproof case to be used outdoors and it is not recommended.

Q: When physically connecting the Internet Camera to a network what network cabling is required?

A: The Internet Camera uses Category 5 UTP cable allowing 10 Base-T and 100 Base-T networking.

Frequently Asked Questions (continued)

Q: Can the Internet Camera be setup as a PC-cam on a computer?

A: No, the **DCS-2100+** Internet Camera is used only on an wireless 802.11b, Ethernet or Fast Ethernet network. The D-Link DSB-C110, DSB-C310 can be used as a PC Camera (Webcam).

Q: Can the DCS-2100+ be connected on the network if it consists of only private IP addresses?

A: The Internet Camera can be connected to a LAN with private IP addresses.

Q: Can the DCS-2100+ be installed and work if a firewall exists on the network?

A: If a firewall exists on the network, port 80 is open for ordinary data communication. The **DCS-2100+** uses port 5001 for control and synchronization, port 5002 for streaming audio and port 5003 for streaming video. These ports (or the ports you specify from the **Advanced** Tab in the Configuration screen if you change the default ports) need to be opened on the firewall.

Q: Why am I unable to access the DCS-2100+ from a Web browser?

A1: If a router or firewall is used on the network, the correct ports for the **DCS-2100+** may not be configured on the router or firewall. To correct the problem, you need to determine if the **DCS-2100+** is behind a router or firewall and if the router or firewall is properly configured for the ports the **DCS-2100+** is using. Refer to Page 19 for help in opening the correct ports on a router or firewall for use with the **DCS-2100+**.

A2: Other possible problems might be due to the network cable. Try replacing your network cable. Test the network interface of the product by connecting a local computer to the unit, utilizing a Ethernet crossover cable. If the problem is not solved the Internet Camera might be faulty.

Q: Why does the Internet Camera work locally but not externally?

A1: This might be caused by network firewall protection. The firewall may need to have some settings changed in order for the Internet Camera to be accessible outside your local LAN. Check with the Network Administrator for your network.

A2: Make sure that the Internet Camera isn't conflicting with any Web server you may have running on your network.

A3: The default router setting might be a possible reason. Check that the configuration of the router settings allow the Internet Camera to be accessed outside your local LAN.

Frequently Asked Questions (continued)

Q: I connected the Internet Camera directly to a computer with a cross-over cable Ethernet cable and received the following Windows error upon running IP Installer:



A1: This Windows error will occur if the Internet Camera is connected to a computer that is not properly configured with a valid IP address. Turn off DHCP from the Network Settings in Windows and configure the computer with a valid IP address or connect the camera to a router with DHCP enabled.

A2: This error can also occur if the **IP Installer** icon is clicked on more than once from the setup wizard.

Q: Why does a series of broad vertical white lines appear throughout the image?

A: It could be that the CMOS sensor has become overloaded when it has been exposed to bright lights such as direct exposure to sunlight or halogen lights. Reposition the Internet Camera into a more shaded area immediately as prolonged exposure to bright lights will damage the CMOS sensor.

Q: The focus on the Internet Camera is bad, how can I correct it?

A1: Adjust the Internet Camera focus manually as described in **Adjusting the Internet Camera Focus** in the Appendix section of this manual.

A2: If you have previously changed the supplied CS-type lens, you may have unintentionally installed a C-type lens without fitting the adaptor first.

Q: Noisy images occur. How can I solve the problem?

A1: The video images might be noisy if the Internet Camera is used in a very low light environment. To solve this issue you need more lighting.

Frequently Asked Questions (continued)

Q: The images appear to be of poor quality, how can I improve the image quality?

A1: Make sure that your computer's display properties are set above 256 colors. Using 16 or 256 colors on your computer will produce dithering artifacts in the image, making the image appear to be of poor quality.

A2: The configuration on the Internet Camera image display is incorrect. Through the **Advanced>Configuration** section of the Web management you need to adjust the image related parameters such as brightness, contrast, hue and power line frequency for fluorescent light . Please refer to the **Advanced>Configuration>Video** section on Page 35 and 36 for detailed information.

How to PING Your IP Address

The PING (Packet Internet Groper) command can determine whether a specific IP address is accessible by sending a packet to the specific address and waiting for a reply. It can also provide a very useful tool to confirm if the IP address conflicts with Internet Camera over the network.

Follow the step-by-step procedure below to utilize the PING command but first you must disconnect Internet Camera from the network.

Start a DOS window.

Type ping x.x.x.x, where x.x.x.x is the IP address of the Internet Camera.

The replies, as illustrated below, will help diagnose any connection problems.

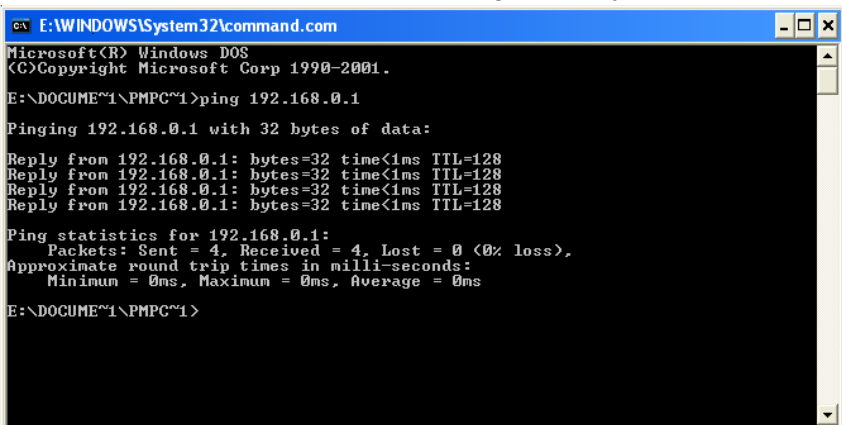

```

C:\E:\WINDOWS\system32\command.com
Microsoft(R) Windows DOS
(C) Copyright Microsoft Corp 1990-2001.

E:\DOCUMENT1\PMPC~1>ping 192.168.0.1

Pinging 192.168.0.1 with 32 bytes of data:

Reply from 192.168.0.1: bytes=32 time<1ms TTL=128
Reply from 192.168.0.1: bytes=32 time<1ms TTL=128
Reply from 192.168.0.1: bytes=32 time<1ms TTL=128
Reply from 192.168.0.1: bytes=32 time<1ms TTL=128

Ping statistics for 192.168.0.1:
    Packets: Sent = 4, Received = 4, Lost = 0 (0% loss),
    Approximate round trip times in milli-seconds:
        Minimum = 0ms, Maximum = 0ms, Average = 0ms

E:\DOCUMENT1\PMPC~1>
```

Reset and Restore

There is a button hidden in the pinhole beside the Ethernet socket. It is used to **reset** the system or **restore** the factory default settings. Sometimes resetting the **DCS-2100+** will return the system back to a normal state. If the system still has problems after reset, restore the factory settings and install again:

- RESET:**
1. Lightly insert a paper clip (or a similar sized tool) into the reset hole on the back of the camera, press lightly and then release the button.
 2. The LED on the front of the camera will begin blinking red and green.
 3. When the LED stops the blinking the reset has completed.

- RESTORE:**
1. Insert the paper clip or other tool and press on the button continuously.
 2. Wait for the LED on the front of the camera to blink red and green and hold the button through two cycles of blinking (about 5-7 seconds.)
 3. Withdraw the tool after the second cycle of the LED blinking and a factory restore has been completed.

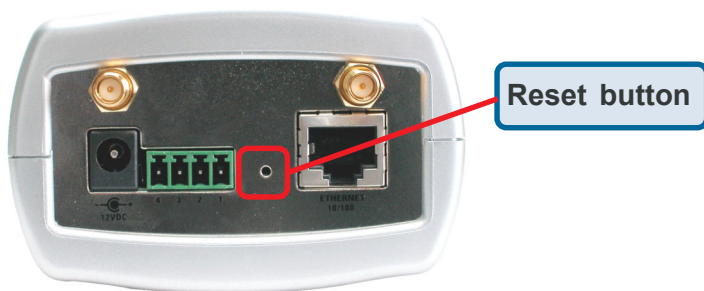

Restoring the factory defaults will result in the loss of any previous settings and will require running the **IP Installer** to return the **DCS-2100+** to a normal state.

I/O Connector

I/O Connector Definition for the Internet Camera

The **DCS-2100+** provides a general I/O terminal block with one digital input and one relay switch for device control. Pin 1 and pin 2 can be connected to an external sensor and the state of voltage will be monitored from the initial state 'LOW'. The relay switch of pin 3 and pin 4 can be used to turn on or off the external device.

The I/O connector provides the physical interface for digital output (DO) and digital input (DI) that is used for connecting a diversity of external alarm devices to the Internet Camera such as IR-Sensors and alarm relays.

The digital input is used for connecting external alarm devices and once triggered images will be taken and e-mailed.

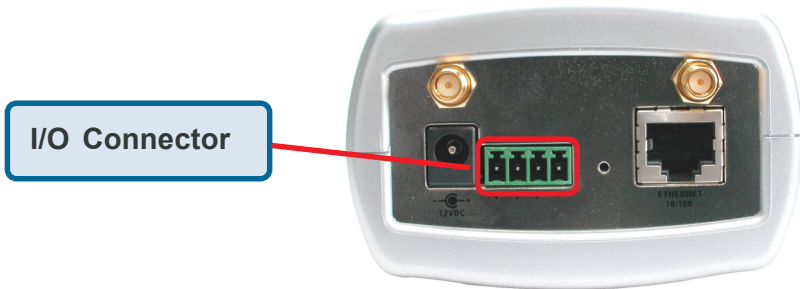

I/O Terminal Block:



1 DI+	INPUT (Max. 50mA, 12VDC)
2 DI-	INPUT (Initial state of DI is low)
3 SW_COMMON	OUTPUT (open from SW_OPEN at initial state) (close with SW_OPEN when set DO to ON)
4 SW_NOPEN	OUTPUT (Max. 1A, 24VDC or 0.5A, 125VAC)

Adjusting the Camera Focus

The **DCS-2100+** Internet Camera features an interchangeable C/CS-type lens that can be used for different applications as necessary. It supports rotational focus control so the lens can be adjusted to focus under normal and stable conditions to maximize the image quality of the Internet Camera.



**Fixed Lens Assembly
Do NOT adjust**

**Camera Lens
Adjust focus by turning
clockwise or counterclockwise**

To adjust the focus of the lens you will need to turn the lens slowly either clockwise or counterclockwise until the desired image appears. **DO NOT** overturn the lens in either direction as it will be out of focus. Unless you want to substitute the lens **DO NOT** unscrew more than 1.0mm apart from the Fixed Lens Assembly.

To help you get the best image quality, keep in mind that while adjusting the camera's focus you can preview the image quality from your Web browser.

Note:

You can further adjust the Internet Camera's image quality through the web configuration under:

Configuration > Advanced > Video

Please refer to **Using the DCS-2100+** section for further details.

Replacing the Lens

Since the **DCS-2100+** Internet Camera is designed with a CS-mount, the lens equipped with the Internet Camera can be replaced with any standard C or CS-mount lens commonly used within the surveillance industry.

Follow the instructions below to replace the supplied lens with any C or CS-mount lens.

1. Unscrew the Internet Camera lens
2. When using a C-mount lens, attach the new lens to a CS to C-mount adapter.
3. Screw the new lens onto the Internet Camera.
4. Refer to **Adjusting the Internet Camera Focus** on the previous page.
5. Refresh the Web browser and monitor the results from the Internet Camera.



Warning!



Direct exposure to sunlight may cause permanent damage to the CMOS sensor. Therefore do not expose the Internet Camera's lens directly to sunlight. When operation is required in glaring light environment, it is recommended to use an iris lens.

The Internet Camera is designed for indoor usage and if your application requires prolonged exposure to sunlight, a sun visor is recommended to protect the Internet Camera.

Technical Specifications

Remote management

Camera configuration and Camera system log can be accessed remotely via Internet Explorer 5.x or above Web browser.

Networking

Protocol

TCP/IP, HTTP, SMTP, FTP, NTP, DNS and DHCP

Ethernet

Enhanced 802.11b wireless or 10BaseT or 100BaseT Fast Ethernet auto-negotiation

WLAN

2.4Ghz 802.11b+ DSSS CSMA/CA Protocol

Bit rate: 22/11/5.5/2/1 Mbps

Security: Up to 256-bit WEP

Antenna

2.4Ghz swivel type, monopole

Frequency

2.4Ghz-2.5Ghz

Impedance

50 Ohms nominal

Gain

2dBi typical

Video

Algorithm supported

H.263+ (MPEG-4 Short header mode)

Features

Three adjustable image sizes and motion detection windows with adjustable bit rate

Audio

24Kbps

8K sampling rate

Video resolution

Up to 30 fps at 160x120

Up to 30 fps at 320x240

General I/O

1 opto-isolated sensor input (max. 12VDC 50mA)

1 relay output (max. 24VDC 1A, 125VAC 0.5A)

Security

Administrator and user group protected

Password authentication

Technical Specifications (continued)

LED indicator

Bi-color status indicator

Camera specification

1/3 inch color CMOS sensor

2.5Lux/F1.4

AGC/AWB

Electronic shutter: 1/60 ~ 1/15000 second

Standard CS mount type lens, 6mm, F1.8

Power

12VDC 1.5A, external power supply

Weight

328 grams

Dimension

160mm(L) x 83.5mm(W) x 54mm(H)

Viewing system requirement

Protocol

Standard TCP/IP Internet Suite

ActiveX

Operating system

Microsoft Windows XP, 2000, ME or 98SE

Browser

Internet Explorer 5.x or above

Environmental

Operating

40° to 113° F

Storage

-4° to 158° F

Humidity

Max 95% RH

Safety

FCC class B

CE

Contacting Technical Support

Technical Support

You can find software updates and user documentation on the D-Link website.

D-Link provides free technical support for customers within the United States and within Canada for the duration of the warranty period on this product.

U.S. and Canadian customers can contact D-Link Technical Support through our website, or by phone.

Tech Support for customers within the United States:

D-Link Technical Support over the Telephone:

(877) 453-5465

24 hours a day, seven days a week.

D-Link Technical Support over the Internet:

<http://support.dlink.com>

email:support@dlink.com

Tech Support for customers within Canada:

D-Link Technical Support over the Telephone:

(800) 361-5265

Monday to Friday 8:30am to 9:00pm EST

D-Link Technical Support over the Internet:

<http://support.dlink.ca>

email:support@dlink.ca

Time Zone Table

GMT stands for Greenwich Mean Time, which is the global time that all time zones are measured from.

(GMT-12:00) International Date Line West
(GMT-11:00) Midway Island, Samoa
(GMT-10:00) Hawaii
(GMT-09:00) Alaska
(GMT-08:00) Pacific Time (US & Canada); Tijuana
(GMT-07:00) Arizona
(GMT-07:00) Chihuahua, La Paz, Mazatlan
(GMT-07:00) Mountain Time (US & Canada)
(GMT-06:00) Central America
(GMT-06:00) Central Time (US & Canada)
(GMT-06:00) Guadalajara, Mexico City, Monterrey
(GMT-06:00) Saskatchewan
(GMT-05:00) Bogota, Lima, Quito
(GMT-05:00) Eastern Time (US & Canada)
(GMT-05:00) Indiana (East)
(GMT-04:00) Atlantic Time (Canada)
(GMT-04:00) Caracas, La Paz
(GMT-04:00) Santiago
(GMT-03:30) Newfoundland
(GMT-03:00) Brasilia
(GMT-03:00) Buenos Aires, Georgetown
(GMT-03:00) Greenland
(GMT-02:00) Mid-Atlantic
(GMT-01:00) Azores
(GMT-01:00) Cape Verde Is.
(GMT) Casablanca, Monrovia
(GMT) Greenwich Mean Time : Dublin, Edinburgh, Lisbon, London
(GMT+01:00) Amsterdam, Berlin, Bern, Rome, Stockholm, Vienna
(GMT+01:00) Belgrade, Bratislava, Budapest, Ljubljana, Prague
(GMT+01:00) Brussels, Copenhagen, Madrid, Paris
(GMT+01:00) Sarajevo, Skopje, Warsaw, Zagreb
(GMT+01:00) West Central Africa
(GMT+02:00) Athens, Istanbul, Minsk
(GMT+02:00) Bucharest
(GMT+02:00) Cairo
(GMT+02:00) Harare, Pretoria
(GMT+02:00) Helsinki, Kyiv, Riga, Sofia, Tallinn, Vilnius
(GMT+02:00) Jerusalem
(GMT+03:00) Baghdad
(GMT+03:00) Kuwait, Riyadh
(GMT+03:00) Moscow, St. Petersburg, Volgograd
(GMT+03:00) Nairobi

Time Zone Table (continued)

(GMT+03:30) Tehran
(GMT+04:00) Abu Dhabi, Muscat
(GMT+04:00) Baku, Tbilisi, Yerevan
(GMT+04:30) Kabul
(GMT+05:00) Ekaterinburg
(GMT+05:00) Islamabad, Karachi, Tashkent
(GMT+05:30) Chennai, Kolkata, Mumbai, New Delhi
(GMT+05:45) Kathmandu
(GMT+06:00) Almaty, Novosibirsk
(GMT+06:00) Astana, Dhaka
(GMT+06:00) Sri Jayawardenepura
(GMT+06:30) Rangoon
(GMT+07:00) Bangkok, Hanoi, Jakarta
(GMT+07:00) Krasnoyarsk
(GMT+08:00) Beijing, Chongqing, Hong Kong, Urumqi
(GMT+08:00) Irkutsk, Ulaan Bataar
(GMT+08:00) Kuala Lumpur, Singapore
(GMT+08:00) Perth
(GMT+08:00) Taipei
(GMT+09:00) Osaka, Sapporo, Tokyo
(GMT+09:00) Seoul
(GMT+09:00) Yakutsk
(GMT+09:30) Adelaide
(GMT+09:30) Darwin
(GMT+10:00) Brisbane
(GMT+10:00) Canberra, Melbourne, Sydney
(GMT+10:00) Guam, Port Moresby
(GMT+10:00) Hobart
(GMT+10:00) Vladivostok
(GMT+11:00) Magadan, Solomon Is., New Caledonia
(GMT+12:00) Auckland, Wellington
(GMT+12:00) Fiji, Kamchatka, Marshall Is.
(GMT+13:00) Nuku'alofa

Warranty and Registration USA only

Subject to the terms and conditions set forth herein, D-Link Systems, Inc. ("D-Link") provides this Limited warranty for its product only to the person or entity that originally purchased the product from:

- D-Link or its authorized reseller or distributor and
- Products purchased and delivered within the fifty states of the United States, the District of Columbia, U.S. Possessions or Protectorates, U.S. Military Installations, addresses with an APO or FPO.

Limited Warranty: D-Link warrants that the hardware portion of the D-Link products described below will be free from material defects in workmanship and materials from the date of original retail purchase of the product, for the period set forth below applicable to the product type ("Warranty Period"), except as otherwise stated herein.

1-Year Limited Warranty for the Product(s) is defined as follows:

- Hardware (excluding power supplies and fans) One (1) Year
- Power Supplies and Fans One (1) Year
- Spare parts and spare kits Ninety (90) days

D-Link's sole obligation shall be to repair or replace the defective Hardware during the Warranty Period at no charge to the original owner or to refund at D-Link's sole discretion. Such repair or replacement will be rendered by D-Link at an Authorized D-Link Service Office. The replacement Hardware need not be new or have an identical make, model or part. D-Link may in its sole discretion replace the defective Hardware (or any part thereof) with any reconditioned product that D-Link reasonably determines is substantially equivalent (or superior) in all material respects to the defective Hardware. Repaired or replacement Hardware will be warranted for the remainder of the original Warranty Period from the date of original retail purchase. If a material defect is incapable of correction, or if D-Link determines in its sole discretion that it is not practical to repair or replace the defective Hardware, the price paid by the original purchaser for the defective Hardware will be refunded by D-Link upon return to D-Link of the defective Hardware. All Hardware (or part thereof) that is replaced by D-Link, or for which the purchase price is refunded, shall become the property of D-Link upon replacement or refund.

Limited Software Warranty: D-Link warrants that the software portion of the product ("Software") will substantially conform to D-Link's then current functional specifications for the Software, as set forth in the applicable documentation, from the date of original retail purchase of the Software for a period of ninety (90) days ("Warranty Period"), provided that the Software is properly installed on approved hardware and operated as contemplated in its documentation. D-Link further warrants that, during the Warranty Period, the magnetic media on which D-Link delivers the Software will be free of physical defects. D-Link's sole obligation shall be to replace the non-conforming Software (or defective media) with software that substantially conforms to D-Link's functional specifications for the Software or to refund at D-Link's sole discretion. Except as otherwise agreed by D-Link in writing, the replacement Software is provided only to the original licensee, and is subject to the terms and conditions of the license granted by D-Link for the Software. Software will be warranted for the remainder of the original Warranty Period from the date of original retail purchase. If a material non-conformance is incapable of correction, or if D-Link determines in its sole discretion that it is not practical to replace the non-conforming Software, the price paid by the original licensee for the non-conforming Software will be refunded by D-Link; provided that the non-conforming Software (and all copies thereof) is first returned to D-Link. The license granted respecting any Software for which a refund is given automatically terminates.

Non-Applicability of Warranty: The Limited Warranty provided hereunder for hardware and software of D-Link's products will not be applied to and does not cover any refurbished product and any product purchased through the inventory clearance or liquidation sale or other sales in which D-Link, the sellers, or the liquidators expressly disclaim their warranty obligation pertaining to the product and in that case, the product is being sold "As-Is" without any warranty whatsoever including, without limitation, the Limited Warranty as described herein, notwithstanding anything stated herein to the contrary.

Submitting A Claim: The customer shall return the product to the original purchase point based on its return policy. In case the return policy period has expired and the product is within warranty, the customer shall submit a claim to D-Link as outlined below:

- The customer must submit with the product as part of the claim a written description of the Hardware defect or Software nonconformance in sufficient detail to allow D-Link to confirm the same.
- The original product owner must obtain a Return Material Authorization ("RMA") number from the Authorized D-Link Service Office and, if requested, provide written proof of purchase of the product (such as a copy of the dated purchase invoice for the product) before the warranty service is provided.

Warranty and Registration USA only (continued)

- After an RMA number is issued, the defective product must be packaged securely in the original or other suitable shipping package to ensure that it will not be damaged in transit, and the RMA number must be prominently marked on the outside of the package. Do not include any manuals or accessories in the shipping package. D-Link will only replace the defective portion of the Product and will not ship back any accessories.
- The customer is responsible for all in-bound shipping charges to D-Link. No Cash on Delivery ("COD") is allowed. Products sent COD will either be rejected by D-Link or become the property of D-Link. Products shall be fully insured by the customer and shipped to **D-Link Systems, Inc., 53 Discovery Drive, Irvine, CA 92618**. D-Link will not be held responsible for any packages that are lost in transit to D-Link. The repaired or replaced packages will be shipped to the customer via UPS Ground or any common carrier selected by D-Link, with shipping charges prepaid. Expedited shipping is available if shipping charges are prepaid by the customer and upon request.

D-Link may reject or return any product that is not packaged and shipped in strict compliance with the foregoing requirements, or for which an RMA number is not visible from the outside of the package. The product owner agrees to pay D-Link's reasonable handling and return shipping charges for any product that is not packaged and shipped in accordance with the foregoing requirements, or that is determined by D-Link not to be defective or non-conforming.

What Is Not Covered: This limited warranty provided by D-Link does not cover: Products, if in D-Link's judgment, have been subjected to abuse, accident, alteration, modification, tampering, negligence, misuse, faulty installation, lack of reasonable care, repair or service in any way that is not contemplated in the documentation for the product, or if the model or serial number has been altered, tampered with, defaced or removed; Initial installation, installation and removal of the product for repair, and shipping costs; Operational adjustments covered in the operating manual for the product, and normal maintenance; Damage that occurs in shipment, due to act of God, failures due to power surge, and cosmetic damage; Any hardware, software, firmware or other products or services provided by anyone other than D-Link; Products that have been purchased from inventory clearance or liquidation sales or other sales in which D-Link, the sellers, or the liquidators expressly disclaim their warranty obligation pertaining to the product. Repair by anyone other than D-Link or an Authorized D-Link Service Office will void this Warranty.

Disclaimer of Other Warranties: EXCEPT FOR THE LIMITED WARRANTY SPECIFIED HEREIN, THE PRODUCT IS PROVIDED "AS-IS" WITHOUT ANY WARRANTY OF ANY KIND WHATSOEVER INCLUDING, WITHOUT LIMITATION, ANY WARRANTY OF MERCHANTABILITY, FITNESS FOR A PARTICULAR PURPOSE AND NON-INFRINGEMENT. IF ANY IMPLIED WARRANTY CANNOT BE DISCLAIMED IN ANY TERRITORY WHERE A PRODUCT IS SOLD, THE DURATION OF SUCH IMPLIED WARRANTY SHALL BE LIMITED TO NINETY (90) DAYS. EXCEPT AS EXPRESSLY COVERED UNDER THE LIMITED WARRANTY PROVIDED HEREIN, THE ENTIRE RISK AS TO THE QUALITY, SELECTION AND PERFORMANCE OF THE PRODUCT IS WITH THE PURCHASER OF THE PRODUCT.

Limitation of Liability: TO THE MAXIMUM EXTENT PERMITTED BY LAW, D-LINK IS NOT LIABLE UNDER ANY CONTRACT, NEGLIGENCE, STRICT LIABILITY OR OTHER LEGAL OR EQUITABLE THEORY FOR ANY LOSS OF USE OF THE PRODUCT, INCONVENIENCE OR DAMAGES OF ANY CHARACTER, WHETHER DIRECT, SPECIAL, INCIDENTAL OR CONSEQUENTIAL (INCLUDING, BUT NOT LIMITED TO, DAMAGES FOR LOSS OF GOODWILL, LOSS OF REVENUE OR PROFIT, WORK STOPPAGE, COMPUTER FAILURE OR MALFUNCTION, FAILURE OF OTHER EQUIPMENT OR COMPUTER PROGRAMS TO WHICH D-LINK'S PRODUCT IS CONNECTED WITH, LOSS OF INFORMATION OR DATA CONTAINED IN, STORED ON, OR INTEGRATED WITH ANY PRODUCT RETURNED TO D-LINK FOR WARRANTY SERVICE) RESULTING FROM THE USE OF THE PRODUCT, RELATING TO WARRANTY SERVICE, OR ARISING OUT OF ANY BREACH OF THIS LIMITED WARRANTY, EVEN IF D-LINK HAS BEEN ADVISED OF THE POSSIBILITY OF SUCH DAMAGES. THE SOLE REMEDY FOR A BREACH OF THE FOREGOING LIMITED WARRANTY IS REPAIR, REPLACEMENT OR REFUND OF THE DEFECTIVE OR NON-CONFORMING PRODUCT. THE MAXIMUM LIABILITY OF D-LINK UNDER THIS WARRANTY IS LIMITED TO THE PURCHASE PRICE OF THE PRODUCT COVERED BY THE WARRANTY. THE FOREGOING EXPRESS WRITTEN WARRANTIES AND REMEDIES ARE EXCLUSIVE AND ARE IN LIEU OF ANY OTHER WARRANTIES OR REMEDIES, EXPRESS, IMPLIED OR STATUTORY

Governing Law: This Limited Warranty shall be governed by the laws of the State of California. Some states do not allow exclusion or limitation of incidental or consequential damages, or limitations on how long an implied warranty lasts, so the foregoing limitations and exclusions may not apply. This limited warranty provides specific legal rights and the product owner may also have other rights which vary from state to state.

Warranty and Registration

USA only (continued)

Trademarks: D-Link is a registered trademark of D-Link Systems, Inc. Other trademarks or registered trademarks are the property of their respective manufacturers or owners.

Copyright Statement: No part of this publication or documentation accompanying this Product may be reproduced in any form or by any means or used to make any derivative such as translation, transformation, or adaptation without permission from D-Link Corporation/D-Link Systems, Inc., as stipulated by the United States Copyright Act of 1976. Contents are subject to change without prior notice. Copyright© 2002 by D-Link Corporation/D-Link Systems, Inc. All rights reserved.

CE Mark Warning: This is a Class B product. In a domestic environment, this product may cause radio interference, in which case the user may be required to take adequate measures.

FCC Statement: This equipment has been tested and found to comply with the limits for a Class B digital device, pursuant to part 15 of the FCC Rules. These limits are designed to provide reasonable protection against harmful interference in a residential installation. This equipment generates, uses, and can radiate radio frequency energy and, if not installed and used in accordance with the instructions, may cause harmful interference to radio communication. However, there is no guarantee that interference will not occur in a particular installation. If this equipment does cause harmful interference to radio or television reception, which can be determined by turning the equipment off and on, the user is encouraged to try to correct the interference by one or more of the following measures:

- Reorient or relocate the receiving antenna.
- Increase the separation between the equipment and receiver.
- Connect the equipment into an outlet on a circuit different from that to which the receiver is connected.
- Consult the dealer or an experienced radio/TV technician for help.

For detailed warranty outside the United States, please contact corresponding local D-Link office.

Register online your D-Link product at <http://support.dlink.com/register/>

Free Manuals Download Website

<http://myh66.com>

<http://usermanuals.us>

<http://www.somanuals.com>

<http://www.4manuals.cc>

<http://www.manual-lib.com>

<http://www.404manual.com>

<http://www.luxmanual.com>

<http://aubethermostatmanual.com>

Golf course search by state

<http://golfingnear.com>

Email search by domain

<http://emailbydomain.com>

Auto manuals search

<http://auto.somanuals.com>

TV manuals search

<http://tv.somanuals.com>