

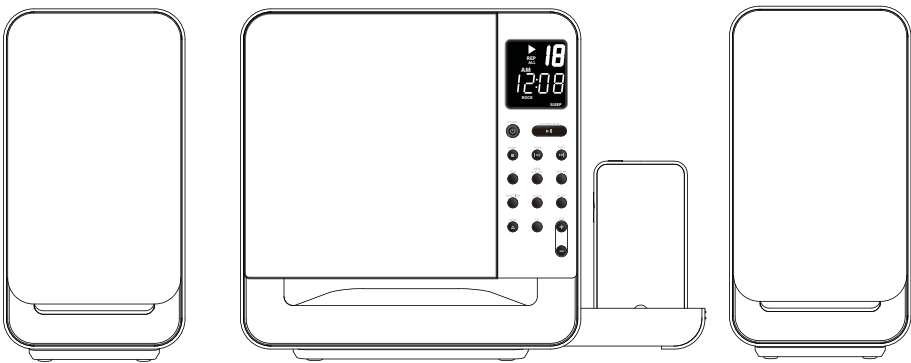

MODEL NO. iP3019UK

CD MICRO SYSTEM DOCKING STATION FOR iPod

INSTRUCTION MANUAL



PLEASE READ BEFORE OPERATING THIS EQUIPMENT



# SAFETY INSTRUCTIONS



## CAUTION

**RISK OF ELECTRIC SHOCK  
DO NOT OPEN**



**CAUTION:** TO REDUCE THE RISK OF ELECTRIC SHOCK, DO NOT REMOVE COVER (OR BACK). NO USER-SERVICEABLE PARTS INSIDE. REFER SERVICING TO QUALIFIED SERVICE PERSONNEL.

**LASER SAFETY:** This unit employs a laser. Only qualified service personnel should attempt to service this device due to possible eye injury.

**CAUTION:** USE OF CONTROLS, ADJUSTMENTS OR PERFORMANCE PROCEDURE HEREIN MAY RESULT IN HAZARDOUS RADIATION EXPOSURE.



### **DANGEROUS VOLTAGE:**

The lightning flash with arrowhead symbol, within an equilateral triangle is intended to alert the user to the presence of uninsulated dangerous voltage within the product's enclosure that may be of sufficient magnitude to constitute a risk of electric shock to persons.



### **ATTENTION:**

The exclamation point within an equilateral triangle is intended to alert the user to the presence of important operating and maintenance (servicing) instructions in the literature accompanying the appliance.

### **SURGE PROTECTORS:**

It is recommended to use a surge protector for AC connection. Lightning and power surges ARE NOT covered under warranty for this product.

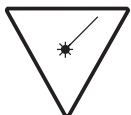

### **DANGER:**

Invisible and hazardous laser radiation when open and interlock failed or defeated. Avoid direct exposure to beam.

# SAFETY INSTRUCTIONS

Before using the unit, be sure to read all operating instructions carefully. Please note that these are general precautions and may not pertain to your unit. For example, this unit may not have the capability to be connected to an outdoor antenna.

## 1. READ INSTRUCTIONS

All the safety and operating instructions should be read before the product is operated.

## 2. RETAIN INSTRUCTIONS

The safety and operating instructions should be retained for future reference.

## 3. HEED WARNINGS

All warnings on the product and in the operating instructions should be adhered to.

## 4. FOLLOW INSTRUCTIONS

All operating and use instructions should be followed.

## 5. CLEANING

Unplug this product from the wall outlet before cleaning. Do not use liquid cleaners or aerosol cleaners. Use a dry cloth for cleaning.

## 6. ATTACHMENTS

Do not use attachments not recommended by the product's manufacturer as they may cause hazards.

## 7. WATER AND MOISTURE

Do not use this product near water—for example: near a bathtub, washbowl, kitchen sink or laundry tub; in a wet basement; or near a swimming pool.

## 8. ACCESSORIES

Do not place this product on an unstable cart, stand, tripod, bracket or table. The product may fall, causing serious injury and serious damage to the product. Use only with a cart, stand, tripod, bracket or table recommended by the manufacturer or sold with the product. Any mounting of the product should follow the manufacturer's instructions, and should use a mounting accessory recommended by the manufacturer.

**8A.** An appliance and cart combination should be moved with care. Quick stops, excessive force and uneven surfaces may cause the appliance and cart combination to overturn.

## 9. VENTILATION

Slots and openings in the cabinet and in the back or bottom are provided for ventilation, to ensure reliable operation of the product and to protect it from overheating. These openings must not be blocked or covered. The openings should never be blocked by placing the product

on a bed, sofa, rug or other similar surface. This product should never be placed near or over a radiator or heat source. This product should not be placed in a built-in installation such as a bookcase or rack unless proper ventilation is provided or the manufacturer's instructions have been adhered to.

## 10. POWER SOURCES

This product should be operated only from the type of power source indicated on the marking label. If you are not sure of the type of power supply to your home, consult your appliance dealer or local power company. For products intended to operate from battery power, or other sources, refer to the operating instructions.

## 11. POWER-CORD PROTECTION

Power-supply cords should be routed so that they are not likely to be walked on or pinched by items placed upon or against them, paying particular attention to cords at plugs, convenience receptacles, and the point where they exit from the appliance.

## 12. LIGHTNING

To protect your product from a lightning storm, or when it is left unattended and unused for long periods of time, unplug it from the wall outlet and disconnect the antenna or cable system.

This will prevent damage to the product due to lightning and power-line surges.

## 13. POWER LINES

An outside antenna system should not be located in the vicinity of overhead power lines or other electric light or power circuits, or where it can fall into such power lines or circuits. When installing an outside antenna system, extreme care should be taken to keep from touching such power lines or circuits as contact with them might be fatal.

## 14. OVERLOADING

Do not overload wall outlets and extension cords as this can result in a risk of fire or electric shock.

## 15. OBJECT AND LIQUID ENTRY

Never push objects of any kind into this product through openings as they may touch dangerous voltage points or short out parts that could result in fire or electric shock. Never spill or spray any type of liquid on the product.

PORTABLE CART WARNING  
(symbol provided by RETAC)



# SAFETY INSTRUCTIONS

## 16. OUTDOOR ANTENNA GROUNDING

If an outside antenna is connected to the product, be sure the antenna system is grounded so as to provide some protection against voltage surges and built-up static charges. Section 810 of the National Electric Code, ANSI/NFPA70, provides information with respect to proper grounding of the mast and supporting structure, grounding of the lead-in wire to an antenna discharge product, size of grounding conductors, location of antenna discharge product, connection to grounding electrodes and requirements for grounding electrodes.

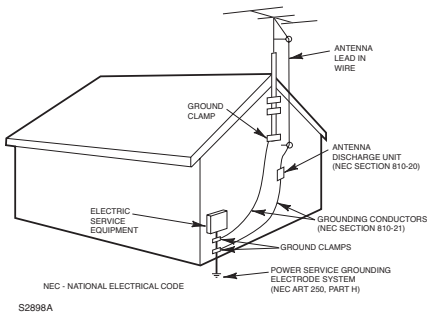

EXAMPLE OF ANTENNA GROUNDING AS PER NATIONAL ELECTRICAL CODE

## 17. SERVICING

Do not attempt to service this product yourself as opening or removing covers may expose you to dangerous voltage or other hazards. Refer all servicing to qualified service personnel.

## 18. REPLACEMENT PARTS

When replacement parts are required, be sure the service technician uses replacement parts specified by the manufacturer or those that have the same characteristics as the original part. Unauthorized substitutions may result in fire, electric shock or other hazards.

## 19. SAFETY CHECK

Upon completion of any service or repairs to this product, ask the service technician to perform safety checks to determine that the product is in proper operating condition.

## 20. WALL OR CEILING MOUNTING

The product should be mounted to a wall or ceiling only as recommended by the manufacturer.

## 21. DAMAGE REQUIRING SERVICE

Unplug the product from the wall outlet and refer servicing to qualified service personnel under the following conditions:

- When the power-supply cord or plug is damaged.
- If liquid has been spilled or objects have fallen into the product.
- If the product has been exposed to rain or water.
- If the product does not operate normally by following the operating instructions. Adjust only those controls that are covered by the operating instructions, as an adjustment of other controls may result in damage and will often require extensive work by a qualified technician to restore the product to its normal operation.
- If the product has been dropped or the cabinet has been damaged.
- When the product exhibits a distinct change in performance this indicates a need for service.

## 22. HEAT

The product should be situated away from heat sources such as radiators, heat registers, stoves or other products (including amplifiers) that produce heat.

## 23. NOTE TO CATV SYSTEM INSTALLER

This reminder is provided to call the CATV system installer's attention to Article 820-40 of the NEC that provides guidelines for proper grounding and, in particular, specifies that the cable ground shall be connected to the grounding system of the building, as close to the point of cable entry as practical.

# PREPARATION FOR USE

## Power Sources

Power the unit by connecting it to a standard AC outlet (230V ~ 50Hz) via the attached AC adaptor.

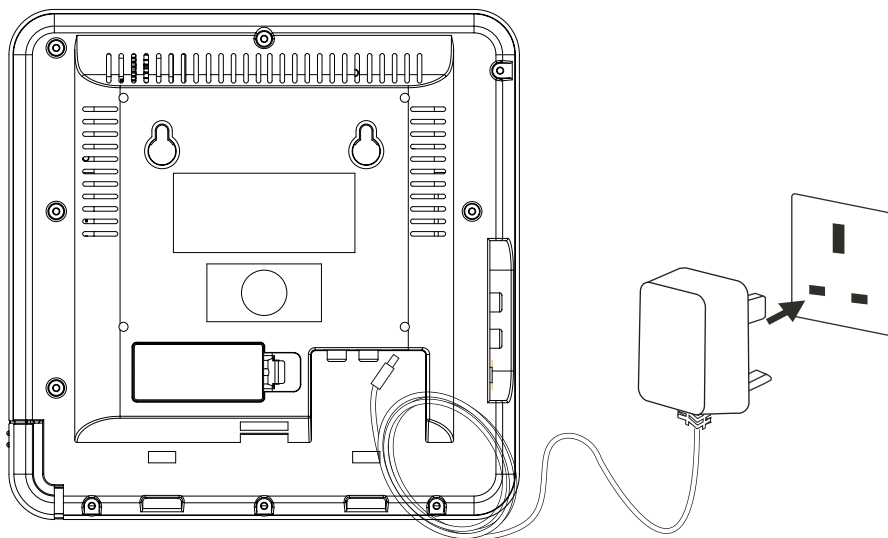

## Changing the Remote Battery

**WARNING:** Danger of explosion if the remote control's batteries are incorrectly installed. Replace only with the same or equivalent battery.

- Push the Release Button and pull out the Battery Compartment to access the battery.
- Replace the old battery with an equivalent new battery (CR 2025).
- The positive side of the battery, as indicated by a plus symbol, must be facing up when inserted into the remote.



# LOCATION OF CONTROLS

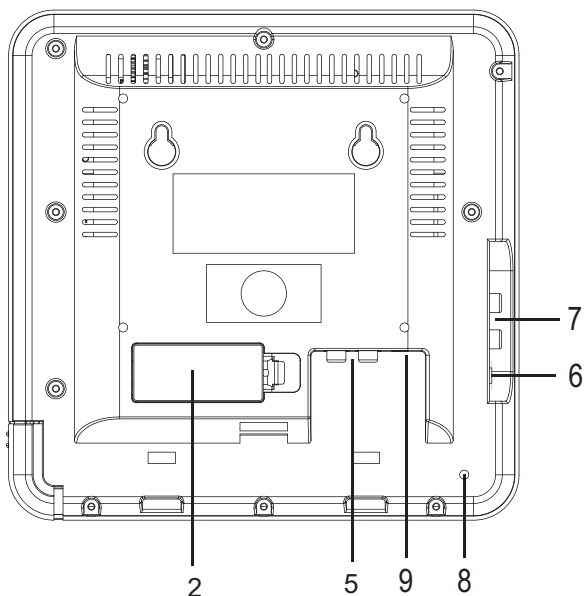
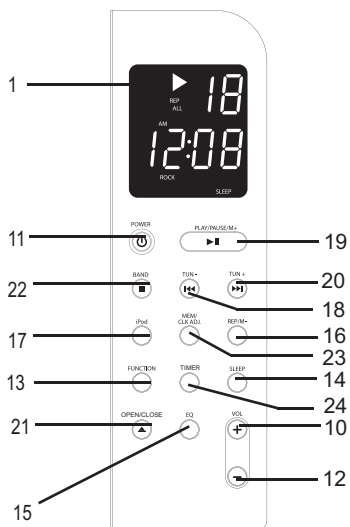
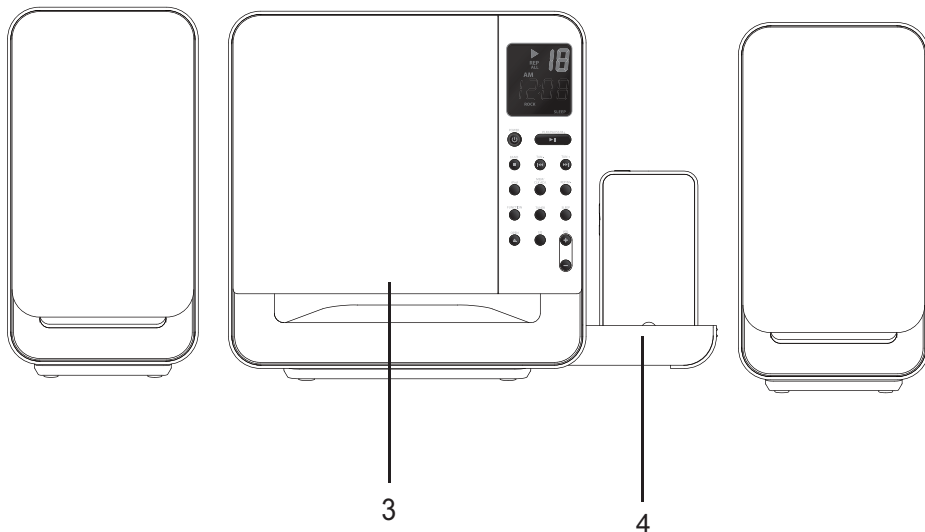

# LOCATION OF CONTROLS

## FEATURE DEFINED

- 
- 1 LCD** – View the Time, iPod Indicator, and Radio Frequency through this Liquid Crystal Display.
- 
- 2 Backup Battery Compartment** – For Clock Backup (1.5V AAA x 2pcs)
- 
- 3 CD DOOR** – Open using the CD OPEN button.
- 
- 4 IPOD DOCKING STATION** - Connect your iPod, iPod mini, iPod nano.
- 
- 5 SPEAKER JACK** – Left and Right speaker jack to connect external speaker.
- 
- 6 PHONE JACK** – Use the phone jack to connect a set of ear buds or headphone to the unit.
- 
- 7 AUX-In JACK** – Use the AUX-In jack to connect a first generation iPod shuffle or other digital audio device to the unit.
- 
- 8 FM Antenna** – The FM Antenna is extendable and adjustable. An AM Antenna is built into the Radio.
- 
- 9 AC Jack** – For AC 10V adaptor
- 
- 10 VOLUME + BUTTON** – Press the VOLUME + button to increase the volume.
- 
- 11 STANDBY BUTTON** – Press the standby button to turn the unit off or on.
- 
- 12 VOLUME - BUTTON** – Press the VOLUME – buttons to decrease the volume.
- 
- 13 FUNCTION BUTTON** – Use button to adjust the mode between radio / CD / aux.
- 
- 14 SLEEP BUTTON** – Press the button to set the sleep timer between 10 ~ 90 minutes.
- 
- 15 EQ BUTTON** – Press the button to switch between the units preset equalizer setting (ROCK / CLASSIC / JAZZ / POP).
- 
- 16 REP/M-DN BUTTON** – Press the Repeat Button once to repeat an individual song on a docked iPod or CD single track. Press the Repeat Button twice to repeat an album / playlist on a docked iPod or entire CD. In radio mode, press the button cycle through saved radio stations in radio mode.
- 
- 17 IPOD BUTTON** – Press the button to switch the unit to ipod mode.
- 
- 18 PEV/TUNE DN BUTTON** – Press the button to skip to the previous track and hold the button to search backwards through a song. When clock setting, using the button to decrease the time..
- 
- 19 PLAY/PAUSE/M-UP BUTTON** – Press the button to play or pause an loaded iPod or CD. In radio mode, press the button to cycle through saved radio stations.
- 
- 20 FWD/TUNE UP BUTTON** – Press the button to skip to the next track and hold the button to search forward through a song. When clock setting, using the button to increase the time.
- 
- 21 DOOR OPEN BUTTON** – Use the CD OPEN button to open / close the CD door.
- 
- 22 STOP/BAND BUTTON** – Press the button to stop a CD or iPod playing. In radio mode, press the button to select the radio band.
- 
- 23 MEM/CLK BUTTON** – Press the button to program a loaded CD. In radio mode, press the button to save a radio station to the units memory. In standby mode, press the button to set the clock.
- 
- 24 TIMER** – Press to set the unit on & off at desire time.
-

# LOCATION OF REMOTE CONTROLS

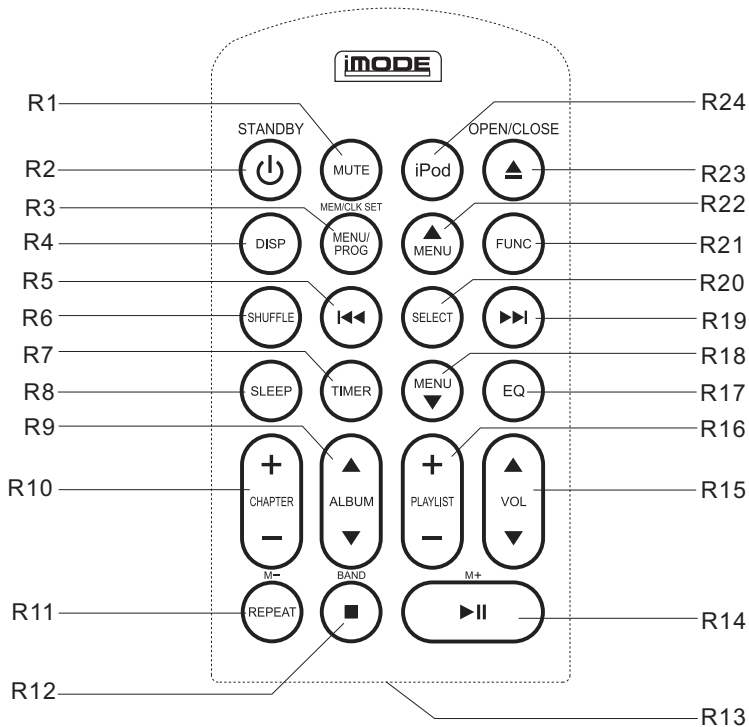

## FEATURE DEFINED

**R1 MUTE** – Use mute the audio sound.

**R2 STANDBY** – Press the standby button to turn the unit off or on.

**R3 MENU/PROG /MEM/CLK SET** – Press the button to program a loaded CD or to move backwards through the menus on a docked iPod. In radio mode, press the button to save a radio station to the units memory. In standby mode, press the button to set the clock.

**R4 DISP** – Press the button to view the current function or the time.

**R5 PEV/TUNE DN BUTTON** – Press the button to skip to the previous track and hold the button to search backwards through a song. When clock setting, using the button to decrease the time.

**R6 SHUFFLE** – Press the SHUFFLE button to randomly play songs.

**R7 TIMER** – Press the button to view and adjust the on and off timer.

**R8 SLEEP** – Press the button to set the sleep timer between 10 ~ 90 minutes.

**R9 ALBUM** – Press up on the ALBUM button to increase the album number, or press down on the ALBUM button to decrease the album number.

**R10 CHAPTER** – Press the button to browse through chapters on an iPod.



# LOCATION OF REMOTE CONTROLS

**R11 REPEAT/M- BUTTON** – Press the Repeat button once to repeat an individual song on a docked iPod or CD single track. Press the Repeat Button twice to repeat an album / play list on a docked iPod or entire CD. In radio mode, press the button cycle through saved radio stations in radio mode.

---

**R12 STOP/BAND BUTTON** – Press the button to stop CD or iPod playing. In radio mode, press the button to select the radio band.

---

**R13 BATTERY DOOR** – BATTERY DOOR for remote control.

---

**R14 PLAY/PAUSE/M+ BUTTON** – Press the button to play or pause an loaded iPod or CD. In radio mode, press the button to cycle through saved radio stations.

---

**R15 VOLUME** – Press the VOLUME +/- buttons to increase / decrease the volume.

---

**R16 PLAYLIST** – Press up on the PLAYLIST buttons to cycle up through the playlists on an iPod, or press down on the PLAYLIST button to cycle down through the playlists on an iPod.

---

**R17 EQ** – Press the button to switch between the units preset equalizer setting (ROCK / CLASSIC / JAZZ / POP).

---

**R18 MENU ▲** – Press the button to scroll down the menu on a docked iPod.

---

**R19 FWD/TUNE UP BUTTON** – Press the button to skip to the next track and hold the button to search forward through a song. When clock setting, using the button to increase the time.

---

**R20 SELECT** – Press the Select Button to make selections in the iPod menu system.

---

**R21 FUNCTION BUTTON** – Use button to adjust the mode between radio / CD / aux.

---

**R22 MENU ▼** – Press the button to scroll up the menu on a docked iPod.













---

**R23 OPEN/CLOSE BUTTON** – Use the button to open / close the CD door.

---

**R24 IPOD BUTTON** – Press the button to switch the unit to ipod mode.

---

iPod Model	Included Bracket
 iPod 4th generation 20GB	<b>6</b>
 iPod 4th generation 40GB	<b>7</b>
 iPod 4th generation (color display) 20GB 30GB	<b>6</b>
 iPod 4th generation (color display) 40GB 60GB	<b>7</b>
 iPod nano 1st generation 1GB 2GB 4GB	<b>8</b>
 iPod 5th generation (video) 30GB	<b>9</b>
 iPod 5th generation (video) 60GB 80GB	<b>10</b>
 iPod nano 2nd generation (aluminum) 2GB 4GB 8GB	<b>8</b>
 iPod classic 80GB	<b>9</b>
 iPod classic 160GB	<b>10</b>
 iPod nano 3rd generation (video) 4GB 8GB	<b>13</b>
 iPod touch 8GB 16GB	<b>14</b>

# OPERATION

## Setting the Clock

1. Press the STANDBY button to turn the unit off, then press and hold the CLK button.
2. Use the FWD/PEV buttons to select 12Hr or 24Hr clock, and press the CLK button to confirm the selection.
3. Press the FWD/PEV buttons to adjust the hour, and press the CLK button to confirm the hour.
4. Press the FWD/PEV buttons to adjust the minute, and press the CLK button to confirm the minute.

## Setting the Timer

1. Press the TIMER button (on the remote) to view the timer, press and hold the TIMER button to adjust the timer setting.
2. Press the FWD/PEV buttons to adjust the hour for the “ Timer On” time. Press the TIMER button to confirm the hour.
3. Press the FWD/PEV buttons to adjust the minute for the “ Timer On” time. Press the Timer Button to confirm the minute.
4. Press the FWD/PEV buttons to adjust the hour for the “ Timer Off” time. Press the TIMER button to confirm the hour.
5. Press the FWD/PEV buttons to adjust the minute for the “ Timer Off” time.
6. Press the TIMER button to confirm the minute.

## Setting the Sleep Timer

1. Press the SLEEP button consecutively to adjust and set the sleep timer.
2. The sleep timer can be set from 10 to 90 minutes in 10 minute increments.

## Playing an iPod

1. Chose the correct adaptor to hold the iPod tightly on the unit.
2. In standby mode, connect an iPod to the Docking Station.
3. Press the STANDBY button to turn the unit on.
4. Press the iPod button to switch the unit to iPod mode.
5. The iPod will start to play automatically and no need to press PLAY button
6. Press the VOLUME buttons to increase or decrease the volume of the unit.
7. Press the FWD/PEV buttons to skip tracks. Press and hold the FWD/PEV buttons to search through individual tracks.
8. Press the CHAPTER, ALBUM, or PLAYLIST buttons on the remote to navigate through the chapters, albums, or playlists on a docked iPod.
9. Press the Directional Buttons and Select Button on the remote to navigate the iPod's menu and make selections.
10. Press the REPEAT button once to repeat an individual song on a docked iPod
11. Press the SHUFFLE button to play songs from an iPod in a random order.

# OPERATION

## Playing a CD

1. Press the STANDBY button to turn the unit on.
2. Press the FUNCTION button and switch the unit to CD mode.
3. Press the OPEN/CLOSE button to open the CD door, insert a CD or CD-R/RW disc into the CD Drive and press the OPEN/CLOSE button to close the CD door.
4. Press the PLAY/PAUSE button to play or pause the loaded CD.
5. Press the FWD/PEV buttons to skip tracks, press and hold the FWD/PEV buttons to search through individual tracks.
6. Press the REPEAT button consecutively to repeat a single track or entire CD.
7. Press the SHUFFLE button to play songs from a CD in a random order.
8. Press the OPEN/CLOSE Button to eject the loaded CD from the unit.

## Programming a CD (Up to 20 tracks can be programmed)

1. After insert a CD, press the STOP button to stop CD playing.
2. Press the MEM button to activate the program function.
3. Press the FWD/PEV buttons to select a CD track, and press the MEM button to confirm the selection.
4. Repeat step 3 until the desired tracks are programmed.
5. After the program setting, press the PLAY/PAUSE button to play or pause the programmed CD tracks.

## Tuning the AM/FM Radio

1. Press the STANDBY button the unit on.
2. Press the FUNCTION button to switch to unit to radio mode.
3. Press the STOP/BAND button to switch between AM and FM radio.
4. Press the FWD/PEV buttons to tune the radio.
5. Press and hold FWD/PEV buttons to autoscans the radio station

*Extend and adjust the telescopic FM antenna to improve FM reception. An AM antenna is built-in to the unit. Adjust the position of the unit to improve AM reception.*

# OPERATION

## Saving and Recall a Radio Station Memory

1. In radio mode, you select the radio station to storage in memory.
2. Press and hold the MEM button to begin saving the current radio station.
3. Press the FWD/PEV buttons to select a memory slot for the current radio station(P01~P10).
4. Press the MEM button to confirm the selected memory slot.
5. Press the PLAY/PAUSE/MEM-UP button and REPEAT/MEM-DN button to cycle through the saved radio stations.

## Using the Auxiliary Input

1. Plug one RCA cable (not included) into the Aux Input (AUX IN) on rear of the unit.
2. Plug the other end of the cable into the audio output / headphone output on an Mp3 Player or Other Audio Source.
3. Press the STANDBY button to turn the unit on.
4. Press the FUNCTION button to switch the unit to AUX mode.
5. Audio played from the Mp3 Player or Other Audio Source will now be heard on the unit.
6. If connecting to the headphone output of an audio source, the source's volume controls may need to be adjusted for optimal sound.

## Using Stereo Headphone Jack

You may connect stereo headphones (not included) to the Headphone jack on the rear of this unit for private listening without disturbing others. When headphones are connected the speakers are automatically shutdown.

### **IMPORTANT:**

*Before you connect your headphones, set the VOLUME of this system to a low level. Then connect your headphones, put them gradually increase the volume to a comfortable listening level.*

*Remember that prolonged listening to loud music at high volume levels headphone or the in-ear type "ear-buds" can result in hearing loss.*

# Care and Maintenance

## Caring for Compact Discs

- Treat the disc carefully. Handle the disc only by its edges. Never allow your fingers to come in contact with the shiny, unprinted side of the disc.
- Do not attach adhesive tape, stickers, etc. to the disc label.
- Clean the discs periodically with a soft, lint-free, dry cloth. Never use detergents or abrasive cleaners to clean the disc. If necessary, use a CD cleaning kit. If a disc skips or gets stuck on a section of the disc, it is probably dirty or damaged (scratched). When cleaning the disc, wipe in straight lines from the center of the disc to the outer edge of the disc. Never wipe in circular motions.

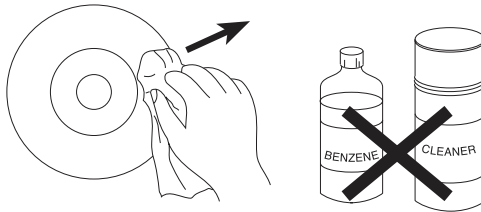
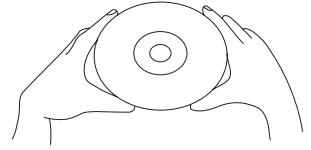

- This unit is designed to play only discs bearing the identification logo as shown here. Other discs may not conform to the CD standard and may not play properly.
- Discs should be stored in their cases after each use to avoid damage.
- Do not expose discs to direct sunlight, high humidity, high temperatures, or dust, etc. Prolonged exposure or extreme temperatures can warp the disc.
- Do not stick or write anything on either side of the disc. Sharp writing instruments or the ink may damage the surface.



## Cleaning the Unit

- To prevent fire or shock hazard, disconnect your unit from the AC power source when cleaning.
- The finish on your unit may be cleaned with a dust cloth and cared for as other furniture. Use caution when cleaning and wiping the plastic parts.
- Mild soap and a damp cloth may be used on the front panel.

## To clean the lens

- If the lens get dirty, your player may skip or may not play a CD
- Open the CD door.
- Use a camera lens blower/brush to blow on the lens once or twice, brush the dust or particles off the lens, then blow again.
- To remove fingerprints, use a dry cotton swab to wipe from the middle to outer edge of the lens.

# Specifications

## Power Requirement

AC ADAPTOR INPUT: 230VAC 50Hz 0.3A

OUTPUT: 10VAC 1500mA

CLOCK BACK UP BATTERIES: DC 3V (2 x AAA SIZE)

## Frequency Range

Radio Receiving: AM 522 - 1620 KHz

FM 87.5 - 108 MHz

Power Consumption      20 Watts

# LIMITED PRODUCT WARRANTY

Audio Product / Telecom Product / TV / DVD Product

This quality product is warranted to be free from manufacturer's defects in material and workman-ship, provided that the unit is used under the normal operating conditions intended by the manufacturer. Should any problems arise with this product, it is highly recommended to visit our website at [www.curtisint.com](http://www.curtisint.com) To better serve our valued customers, additional copies of operating manuals and trouble shooting tips have been posted on our website.

If your query remains unresolved, please feel free to email our support team at: [info@curtisint.com](mailto:info@curtisint.com) or call our UK Customer helpline at: 0 800 032 5264

## TERMS OF WARRANTY

Curtis International LTD warrants this product to be free from defects in materials and workmanship for 1 year on parts and 90 days on labor.

Nothing within this warranty shall imply that Curtis International LTD will be responsible or liable for any damage to any items placed in this product, whether due to any defect of the product, or its use, proper or improper.

This warranty is in addition to, and in no way impacts upon, your statutory rights.

### TO OBTAIN REPLACEMENT / CREDIT / or REPAIRS UNDER THIS WARRANTY

1. The original purchaser must present a copy of the original bill of sale and this service warranty card.
2. Any alterations, abuse, misuse, battery corrosion or accidental damage voids the warranty.
3. The warranty does not cover cabinets and non essential accessories.
4. No warranty or insurance contained or set out shall apply when damage or repair is caused by power failure; damage in transit by the consumer , or when moving the unit; improper power supply; use for commercial or industrial purposes; service calls resulting in customer education, etc.
5. The defective product should be taken to your original supplier
6. Curtis International LTD reserves the right to repair or replace the parts which have become defective.

Please record the appropriate information indicated below on this Warranty Card and retain with your proof of purchase.

Model No..... Serial No.....

Date Purchased..... Supplier / Retailer .....



## Free Manuals Download Website

<http://myh66.com>

<http://usermanuals.us>

<http://www.somanuals.com>

<http://www.4manuals.cc>

<http://www.manual-lib.com>

<http://www.404manual.com>

<http://www.luxmanual.com>

<http://aubethermostatmanual.com>

Golf course search by state

<http://golfingnear.com>

Email search by domain

<http://emailbydomain.com>

Auto manuals search

<http://auto.somanuals.com>

TV manuals search

<http://tv.somanuals.com>