

**INSTALLER: THESE INSTRUCTIONS MUST BE CONVEYED TO AND REMAIN WITH THE HOMEOWNER.**

CERTIFIED UNDER AMERICAN NATIONAL STANDARDS, ANSI Z21.11.2, VOLUME II FOR UNVENTED ROOM HEATERS.



**UNVENTED MILLIVOLT SYSTEM  
INSTALLATION AND OPERATION INSTRUCTIONS FOR  
UNVENTED GAS FIREPLACE**

NATURAL GAS *MODEL CVF36N*  
PROPANE GAS *MODEL CVF36P*

CERTIFIED FOR UNITED STATES USING ANSI METHODS

**WARNING:** If the information in these instructions is not followed exactly, a fire or explosion may result causing property damage, personal injury or death.

**FOR YOUR SAFETY**

Do not store or use gasoline or other flammable vapours and liquids in the vicinity of this or any other appliance.

**WHAT TO DO IF YOU SMELL GAS:**

- Do not try to light any appliance.
  - Do not touch any electrical switch.
  - Do not use any phone in your building.
  - Immediately call your gas supplier from a neighbour's phone. Follow the gas supplier's instructions.
  - If you cannot reach your gas supplier, call the fire department.
- Installation and service must be performed by a qualified installer, service agency or the gas supplier.

**This is an unvented gas-fired heater that uses air (oxygen) from the room in which it is installed. Provisions for adequate combustion and ventilation air must be provided.**



**Wolf Steel Ltd., 24 Napoleon Rd., Barrie, ON L4M 4Y8 Canada • (705)721-1212 • fax(705)722-6031  
www.continentalplaces.com • ask@continentalfire.on.ca**

# TABLE OF CONTENTS

## PG 3-4 INTRODUCTION

Warranty  
 General Instructions  
 General Information  
 Care of Glass Door, Catalytic Tiles &  
 Plated Parts

## 5-7 INSTALLATION

Combustion and Ventilation Air Provisions  
 Determining Confined or Unconfined Space  
 Gas Installation  
 Optional Wall Switch Installation  
 Dimensions  
 Minimum Framing Clearances  
 Nailing Tab Installation  
 Minimum Mantel and Enclosure Clearances

## 8-9 FINISHING

Grate and log installation  
 Charcoal Embers  
 Glowing Embers  
 Hood Installation  
 Logo Placement  
 Louvre Installation

## 9-10 OPTIONAL BLOWER INSTALLATION

GD65 Fan Installation  
 GD36 Thermostatic Sensor Control

## 11-12 OPERATION / MAINTENANCE

Operating Instructions  
 Maintenance  
 Oxygen Depletion Sensor Pilot Cleaning  
 Pilot Flame Appearance  
 Venturi Adjustment

## 13-14 REPLACEMENTS

Ordering Replacement Parts  
 Replacement Parts  
 Accessories

## 15-16 TROUBLE SHOOTING GUIDE

## 17 SERVICE HISTORY

## 18 NOTES

## PLEASE RETAIN THIS MANUAL FOR FUTURE REFERENCE

### WARNING

- Under no circumstances should this heater be modified
- Provide adequate ventilation and combustion air. Provide adequate accessibility clearance for servicing and operating the heater. Never obstruct the front opening of the heater.
- If the heater shuts off, do not re-light until you provide fresh air. If heater keeps shutting off, have it serviced. Keep burner and control compartment clean.
- Do not burn wood or other materials in this heater.
- Adults and especially children should be alerted to the hazards of high surface temperatures and should stay away to avoid burns or clothing ignition. Keep young children and animals away when the fireplace is hot.
- Due to high temperatures, the heater should be located out of traffic and away from furniture and draperies.
- Clothing or other flammable material should not be placed on or near the heater.
- Any safety screen or guard removed for servicing must be replaced prior to operating the heater.
- It is imperative that the control compartments, burners and circulating blower and its passageway in the fireplace and venting system are kept clean. The fireplace and its venting system should be inspected before use and at least annually by a qualified service person. More frequent cleaning may be required due to excessive lint from carpeting, bedding material, etc. The fireplace area must be kept clear and free from combustible materials, gasoline and other flammable vapours and liquids.
- Furniture or other objects must be kept a minimum of 4 feet away from the front of the fireplace.
- Do not use this fireplace if any part has been under water. Immediately call a qualified service technician to inspect the fireplace and to replace any part of the control system and any gas control which has been under water.
- Do not allow fans to blow directly into the fireplace. Avoid any drafts that alter burner flame pattern.
- Do not use a blower insert, heat exchanger insert or other accessory not approved for use with this heater.

**NOTE:** CHANGES, OTHER THAN EDITORIAL, ARE DENOTED BY A VERTICAL LINE IN THE MARGIN.

*CONTINENTAL® gas fireplaces are manufactured under the strict Standard of the world renowned ISO 9001:2000 Quality Assurance Certificate.*

*WOLF STEEL LTD. products are designed with superior components and materials assembled by trained craftsmen who take great pride in their work. The burner valve assembly are leak and tested at a quality test station. The complete fireplace is again thoroughly inspected by a qualified technician before packaging to ensure that you, the customer, receive the quality product that you expect from Wolf Steel Ltd.*

## **CONTINENTAL® GAS FIREPLACE LIMITED WARRANTY**

*The following materials and workmanship in your new Continental® gas fireplace are warranted against defects for a period of five years. This covers combustion chamber, heat exchanger, burner, phazer™ logs and embers, ceramic glass (thermal breakage only), gold plate parts against tarnishing, porcelain enamelled components and aluminum extrusion trims.*

*Electrical (110V and millivolt) components and wearable parts such as catalytic tiles, blowers, gas valve thermal switch, switches, wiring, remote controls, ignitor, gasketing, and pilot assembly are covered at Wolf Steel Ltd. will provide replacement parts free of charge during the first year of the limited warranty.*

*Any labour related to warranty repair is not covered.*

## **CONDITIONS AND LIMITATIONS**

Wolf Steel Ltd. warrants its products against manufacturing defects to the original purchaser only -- i.e., the individual or legal entity (registered customer) whose name appears on the warranty registration card filed with CONTINENTAL® -- provided that the purchase was made through an authorized CONTINENTAL® dealer and is subject to the following conditions and limitations:

This factory warranty is nontransferable and may not be extended whatsoever by any of our representatives.

The gas fireplace must be installed by a licenced, authorized service technician or contractor. Installation must be done in accordance with the installation instructions included with the product and all local and national building and fire codes.

This limited warranty does not cover damages caused by misuse, lack of maintenance, accident, alterations, abuse or neglect and parts installed from other manufacturers will nullify this warranty.

This limited warranty further does not cover any scratches, dents, corrosion or discolouring caused by excessive heat, abrasive and chemical cleaners nor chipping on porcelain enamel parts, mechanical breakage of PHAZER™ logs and embers, nor any venting components used in the installation of the fireplace.

In the first year only, this warranty extends to the repair or replacement of warranted parts which are defective in material or workmanship provided that the product has been operated in accordance with the operation instructions and under normal conditions.

After the first year, with respect to this limited warranty, Wolf Steel Ltd. may, at its discretion, fully discharge all obligations with respect to this warranty by refunding to the original warranted purchaser the wholesale price of any warranted but defective part(s).

Notwithstanding any provisions contained in this limited warranty, Wolf Steel Ltd.'s responsibility under this warranty is defined as above and it shall not in any event extend to any incidental, consequential or indirect damages.

This warranty defines the obligations and liability of Wolf Steel Ltd. with respect to the CONTINENTAL® gas fireplace and any other warranties expressed or implied with respect to this product, its components or accessories are excluded.

Wolf Steel Ltd. neither assumes, nor authorizes any third party to assume, on its behalf, any other liabilities with respect to the sale of this product. Wolf Steel Ltd. will not be responsible for: over-firing, downdrafts, spillage caused by environmental conditions such as rooftops, buildings, nearby trees, hills, mountains, inadequate vents or ventilation, excessive venting configurations, insufficient makeup air, or negative air pressures which may or may not be caused by mechanical systems such as exhaust fans, furnaces, clothes dryers, etc.

Any damages to fireplace, combustion chamber, heat exchanger, brass trim or other component due to water, weather damage, long periods of dampness, condensation, damaging chemicals or cleaners will not be the responsibility of Wolf Steel Ltd.

The bill of sale or copy will be required together with a serial number and a model number when making any warranty claims from your authorized dealer. The warranty registration card must be returned within fourteen days to register the warranty.

Wolf Steel Ltd. reserves the right to have its representative inspect any product or part thereof prior to honouring any warranty claim.

ALL SPECIFICATIONS AND DESIGNS ARE SUBJECT TO CHANGE WITHOUT PRIOR NOTICE DUE TO ON-GOING PRODUCT IMPROVEMENTS. CONTINENTAL® IS A REGISTERED TRADEMARK OF WOLF STEEL LTD. PATENTS U.S. 5.303.693.801 - CAN. 2.073.411, 2.082.915. © WOLF STEEL LTD.

## GENERAL INSTRUCTIONS

*THIS GAS FIREPLACE SHOULD BE INSTALLED AND SERVICED BY A QUALIFIED INSTALLER* to conform with local codes. Installation practices vary from region to region and it is important to know the specifics that apply to your area, for example: in Massachusetts State:

- The appliance off valve must be a "T" handle gas cock.
- The flexible connector must not be longer than 36".
- The appliance is not approved for installation in a bedroom or bathroom unless the unit is a direct vent sealed combustion product.
- A carbon monoxide detector is required in all rooms containing gas fired appliances.
- **WARNING:** This product must be installed by a licensed plumber or gas fitter when installed within the commonwealth of Massachusetts.
- Un-vented room heater shall be installed in accordance with 527 CMR 30.00 and 248 CMR 3.00 through 7.00.
- Sellers of un-vented propane or natural gas-fired space/room heaters shall provide to each purchaser a copy of 527 CMR 30.00 upon the sale of the unit from [http://www.Continentalfireplaces.com/Webshare/installation\\_manuals/mass\\_requirements.pdf](http://www.Continentalfireplaces.com/Webshare/installation_manuals/mass_requirements.pdf)

In absence of local codes, install the **CVF36** to the current National Fuel Gas Code, ANSI Z223.1 Installation Code which can be obtained from:

**American Nation Standards Institute Inc.**  
1430 Broadway  
New York, NY 10018  
or  
**National Fire Protection Association Inc.**  
Batterymarch Park  
Quincy, MA 02269

The fireplace and its individual shutoff valve must be disconnected from the gas supply piping system during any pressure testing of that system at test pressures in excess of 1/2 psig (3.5 kPa). The fireplace must be isolated from the gas supply piping system by closing its individual manual shutoff valve during any pressure testing of the gas supply piping system at test pressures equal to or less than 1/2 psig (3.5 kPa).

When the fireplace is installed directly on carpeting, vinyl tile or other combustible material other than wood flooring, the fireplace shall be installed on a metal or wood panel extending the full width and depth.

If the optional fan or blower is installed, the junction box must be electrically connected and grounded in accordance with local codes. In the absence of local codes, use the current ANSI/NFPA 70 NATIONAL ELECTRICAL CODE in the United States.

## GENERAL INFORMATION

*FOR YOUR SATISFACTION, THIS FIREPLACE HAS BEEN TEST-FIRED TO ASSURE ITS OPERATION AND QUALITY!* Maximum input is 30,000 BTU/hr for natural gas and propane. When the fireplace is installed at elevations above 2,000ft, and in the absence of specific recommendations from the local authority having jurisdiction, the certified high altitude input rating shall be reduced at the rate of 4% for each additional 1,000ft.

Suitable for mobile home installation where the mobile home has been permanently placed on its site. This heater must not be installed in a bedroom or bathroom.

This fireplace may be installed in an aftermarket permanently located, manufactured (mobile) home, where not prohibited by local codes.

This fireplace is only for use with the type of gas indicated on the rating plate. This fireplace is not convertible for use with other gases, unless a certified kit is used.

Minimum inlet gas supply pressure is 4.5" water column for natural gas and 11" water column for propane. Maximum inlet gas pressure is 7" water column for natural gas and 13" water column for propane. Manifold pressure under flow conditions is 3.5" water column for natural gas and 10" water column for propane.

## CARE OF PLATED PARTS

No external electricity (110 volts or 24 volts) is required for the gas system operation.

Expansion / contraction noises during heating up and cooling down cycles are normal and are to be expected.

Do not use abrasive cleaners to clean plated parts. Buff lightly with a clean dry cloth.

**This heater is equipped with a pilot light safety system referred to as an OXYGEN DEPLETION SENSOR and is designed to turn off the heater if not enough fresh air is available.**

**! WARNING**



**HOT GLASS WILL CAUSE BURNS.**

**DO NOT TOUCH GLASS UNTIL COOLED.**

**NEVER ALLOW CHILDREN TO TOUCH GLASS.**

**Use only accessories designed for and listed with your specific fireplace.**

## CARBON MONOXIDE POISONING MAY LEAD TO DEATH

Early signs of carbon monoxide poisoning resemble the flu, with headache, dizziness and/or nausea. If you have these signs, the heater may not be working properly. **Get fresh air at once! Have heater serviced.**

Some people---pregnant women, persons with heart or lung disease, anaemia, those under the influence of alcohol, those at high altitudes--- are more affected by carbon monoxide than others.

Ceiling fans or oscillating type floor fans can cause flame impingement if directing air at the fireplace. Impinging flames will cause soot or carbon that may enter into living area. Try reversing ceiling fan or re-directing floor fans to prevent sooting.

# INSTALLATION

## COMBUSTION & VENTILATION AIR PROVISIONS

This heater shall not be installed in a confined space or unusually tight construction unless provisions are provided for adequate combustion and ventilation air. In order to avoid the possibility of exposed insulation or vapour barrier coming in contact with the fireplace body, it is recommended that the walls of the fireplace enclosure be 'finished', (i.e. drywall/sheetrock) as would any other outside wall of the home. This will ensure that clearance to combustibles is maintained within the cavity.

The *National Fuel Gas Code, ANSI Z223.1* defines a confined space as a space whose volume is **less than 50 cubic feet** per 1,000 Btu per hour (4.8 m<sup>3</sup> per kW) of the aggregate input rating of all appliances installed in that space and an unconfined space as a space whose volume is **not less than 50 cubic feet** per 1,000 Btu per hour (4.8 m<sup>3</sup> per kW) of the aggregate input rating of all appliances installed in that space. Rooms communicating directly with the space in which the appliances are installed, through openings not furnished with doors are considered a part of the unconfined space.

The CVF36 is rated at 30,000BTUs per hour and therefore requires a minimum unconfined space of 1,500 cubic feet.

## DETERMINING CONFINED OR UNCONFINED SPACE

To determine the volume of the room where the heater is to be installed, multiply the width x the length x the ceiling height of that room measured in feet. If any adjoining rooms are connected by grills or openings such as kitchen pass-throughs, etc., the volume of those rooms may be added to the total.

Multiply the room volume by 1000 and divide this amount by 50 to determine the maximum Btu/hr that the space can support with adequate combustion and ventilation air.

Add the Btu/hr of all fuel burning appliances located within the space such as gas furnace, gas water heater, etc. Do not include direct vent gas appliances which draw their input and output air from and to the outdoors.

**WARNING:** If the area in which the heater may be operated is smaller than that defined as an unconfined space or if the building is of unusually tight construction, provide adequate combustion and ventilation air by one of the methods described in the *National Fuel Gas Code ANSI Z223.1, Section 5.3* or the applicable local code.

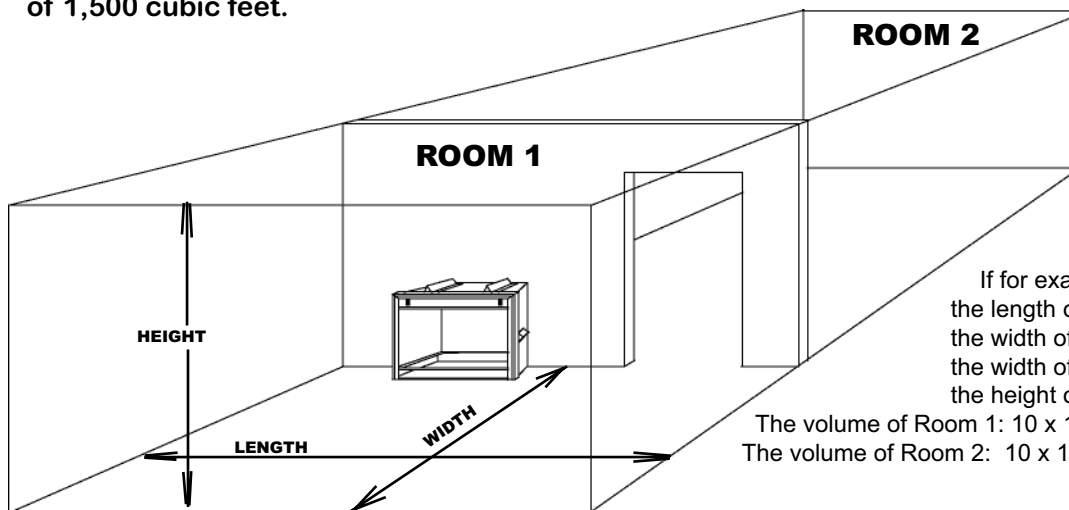

**FIGURE 1**

If for example, the length of the rooms is 10 feet, the width of Room 1 is 10 feet, the width of Room 2 is 15 feet the height of the rooms is 8 feet.

The volume of Room 1: 10 x 10 x 8 = 800 cubic feet.  
The volume of Room 2: 10 x 15 x 8 = 1200 cubic feet.

Room Volume = Length x Width x Height  
Max BTU/hr = Room Volume x 1000 ÷ 50

### EXAMPLE 1

In this example, because there is no door to the adjoining room, the volume of the adjoining room may be added to the volume of the room with the heater to get a total unconfined space.

The total unconfined space: 800 + 1200 = 2000 cubic feet.

Maximum BTU/h:  $\frac{2000 \times 1000}{50} = 40,000$  BTU/h

If there are no more fuel burning appliances within this space then the 30,000 BTU/h input of the fireplace is suitable to be installed. This also assumes that the construction of this space is not unusually tight.

### EXAMPLE 2

If in this example a solid door separates Room 1 from Room 2, the volume of Room 2 could not be used. In this case the maximum BTU/h would be:

Maximum BTU/h:  $\frac{800 \times 1000}{50} = 16,000$  BTU/h

This would be considered a confined space since it can not support the 30,000BTU/h input of the heater and it would be necessary to provide adequate combustion and ventilation air to Room 1.

**Unusually tight construction is defined as construction where:**

- a) Walls and ceilings exposed to the outside atmosphere have a continuous water vapour retarder with a rating of 1 perm ( $6 \times 10^{-11}$  kg per pa-sec- $m^2$ ) or less with openings gasketed or sealed, and
- b) Weather stripping has been added on openable windows and doors, and
- c) Caulking or sealants are applied to areas such as joints around window and door frames, between sole plates and floors, between wall-ceiling joints, between wall panels, at penetrations for plumbing, electrical, and gas lines, and at other openings.

An unvented room heater is recommended for use as a secondary heat source rather than as a primary source. Gas combustion produces water vapour which could occur at the rate of approximately one ounce of water for every 1,000 BTU/hr of gas input. During the cold weather season, indoor humidity levels tend to be low. Consequently, this water vapour can enhance the living space. However if a problem should occur:

- a) ensure sufficient combustion and circulation air
- b) use a dehumidifier
- c) do not use the unvented room heater as a primary heat source

Without sufficient fresh air for proper operation, poor fuel combustion can result. Carbon Monoxide is a result of poor combustion.

**If additional fresh air is required**, use one of the methods described in the National Fuel Gas Code, ANSI Z223.1, Section 5.3 or the applicable local code.

**GAS INSTALLATION**

*Proceed once the vent installation is complete.*

**NOTE:** All gas connections must be contained within the fireplace when complete.

1. Move the fireplace into position and secure to the floor through the 1/4" holes located at either side of the base.
2. The fireplace is designed to accept 3/8" gas supply line. The fireplace is equipped with a 3/8" manual shut-off valve.
3. Connect the gas supply in accordance to local codes. In the absence thereof, install according to the National Installation Code.
4. When flexing any gas line, support the gas valve so that the lines are not bent or kinked.
5. Check for gas leaks by brushing on a soap and water solution.

**DO NOT USE OPEN FLAME.**

**OPTIONAL WALL SWITCH INSTALLATION**

For ease of accessibility, an optional remote wall switch may be installed in a convenient location. A 20' length of millivolt wire is connected to the gas valve for the wall switch. However if a greater length is required route 2-strand (solid core) millivolt wire through the electrical hole located at the bottom left side of the unit. The recommended maximum lead length depends on wire size:

WIRE SIZE	MAX. LENGTH
14 gauge	100 feet
16 gauge	60 feet
18 gauge	40 feet

**FIGURE 2**

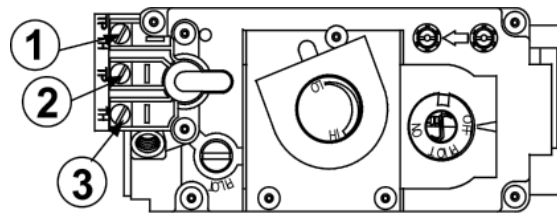

**FIGURE 3**

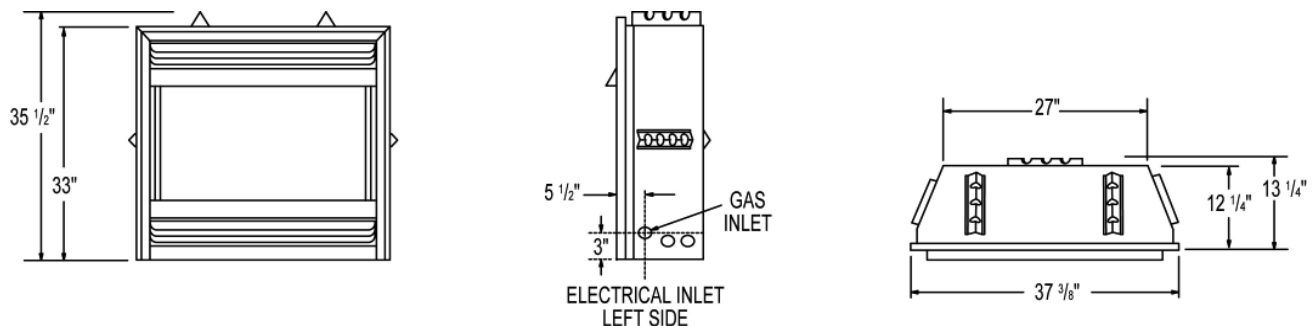

## MINIMUM FRAMING CLEARANCES

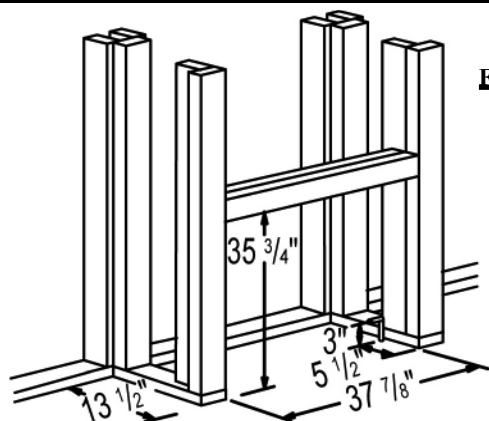

FIGURE 4

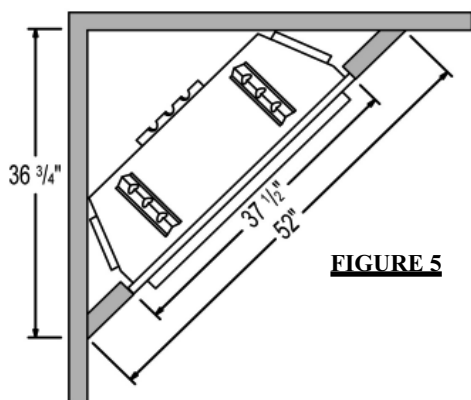

FIGURE 5

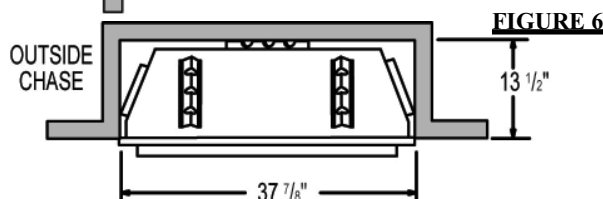

FIGURE 6

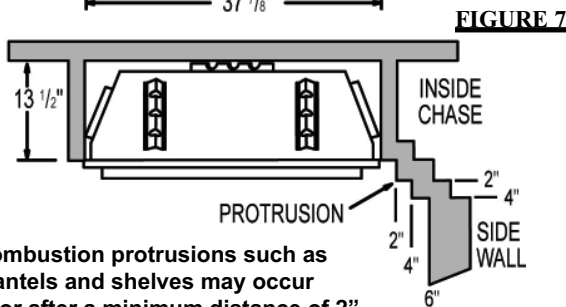

FIGURE 7

Combustion protrusions such as mantels and shelves may occur at or after a minimum distance of 2" away from the side of the fireplace. Thereafter, the depth of any protrusions must be of equal to or less than the distance from the side of the fireplace up to a depth of 6", after which no greater clearance than 6" is required. This can be considered a side wall with no length boundary.

It is best to frame your fireplace after it is positioned. Use 2x4's and frame to local building codes. FIGURE 5-7.

### Minimum clearance to combustible construction from fireplace:

sides, back, bottom and top of the unit	0"
recessed depth	13 1/2"

**Note:** In order to avoid the possibility of exposed insulation or vapour barrier coming in contact with the fireplace body, it is recommended that the walls of the fireplace enclosure be "finished" (ie: drywall/sheetrock), as you would finish any other outside wall of a home. This will ensure that clearance to combustibles is maintained within the cavity.

Combustible materials may be installed flush with the front of the fireplace but must not cover any of the black face-areas of the fireplace. Non-combustible material (brick, stone or ceramic tile) may protrude in these areas.

It is not necessary to install a hearth extension with this fireplace system.

When roughing in the fireplace, raise the fireplace to accommodate for the thickness of the finished floor materials, i.e. tile, carpeting, hard wood, which if not planned for will interfere with the opening of the lower access door and the installation of many decorative flashing accessories.

Objects placed in front of the fireplace should be kept a minimum of 4 feet away from the front face.

## NAILING TAB INSTALLATION

To install the fireplace face flush with the finished wall, position the framework to accommodate the thickness of the finished wall. Bend out the four nailing tabs, attached on either side of the fireplace and secure to the 2x4 framing. The tabs will facilitate the installation of either a 3/4" or a 1" finished wall thickness. *The nailing tabs must not be removed.*



FIGURE 8

## MINIMUM MANTEL AND ENCLOSURE CLEARANCES

Combustible mantel clearance can vary according to the mantel depth. Use the graph to help evaluate the clearance needed.

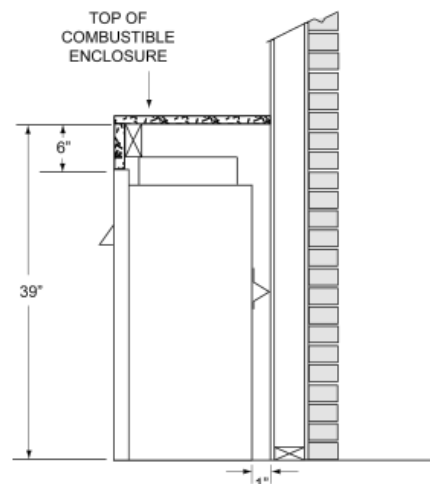
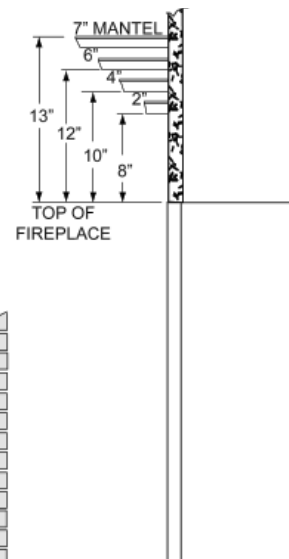
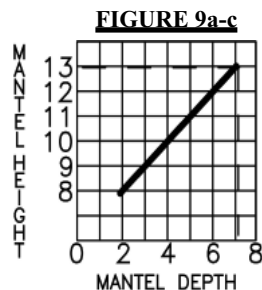

The fireplace requires a minimum enclosure height of 39". For temperature requirements, the enclosure space around and above the fireplace must be left unobstructed.

W415-0298 / K / 12.06.07

## FINISHING

### GRATE AND LOG INSTALLATION

1. Remove curtain mesh and rod assembly
2. Remove log carton
3. Remove grate from the lower control area (stored there when shipped)
4. Unscrew the 3 screws in the firebox, set grate in place and secure using the 3 screws that were just removed.  
**See Figure 11.**
5. Install the one piece logset by aligning the two holes on the bottom of the logs, with the two locating pins in the firebox.

**NOTE:** PHAZER™ logs and glowing embers exclusive to Continental® Fireplaces, provide a unique and realistic glowing effect that is different in every installation. Take the time to carefully position the glowing embers for a maximum glowing effect.

Log colours may vary. During the initial use of the fireplace, the colours will become more uniform as colour pigments burn in during the heat activated curing process.

6. Reinstall rod assembly and mesh curtain

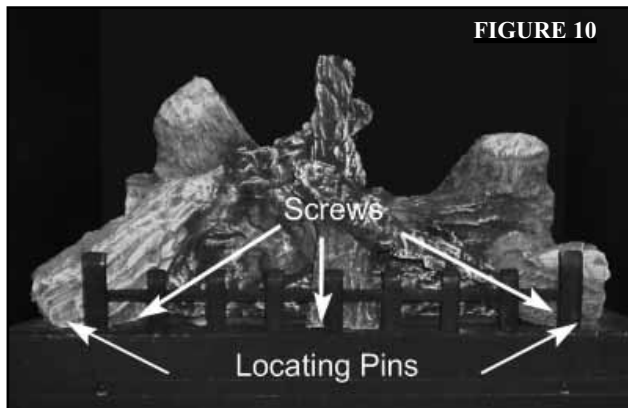

FIGURE 10

### CHARCOAL EMBERS

Randomly place the charcoal embers along the front and sides of the log support tray in a realistic manner. **Fine dust found in the bottom of the bag should not be used.**

### GLOWING EMBERS

Tear the embers into pieces and place along the front row of ports covering all of the burner area in front of the small logs (#2 & #3). Care should be taken to shred the embers into thin, small irregular pieces as only the exposed edges of the fibre hairs will glow. **The ember material will only glow when exposed to direct flame; however, care should be taken to not block the burner ports.**

Blocked burner ports can cause an incorrect flame pattern, carbon deposits and delayed ignition. PHAZER™ logs glow when exposed to direct flame. Use only certified "glowing embers" and PHAZER™ logs available from your Continental® dealer.

### HOOD

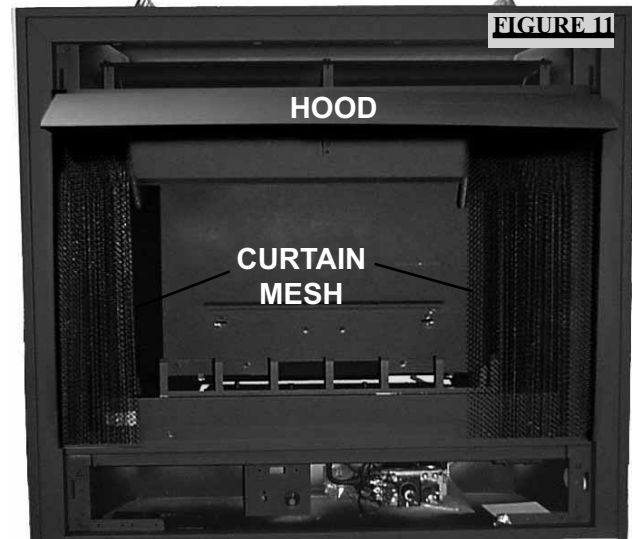

FIGURE 11

The curtain mesh must be kept fully closed during operation to help prevent accidental burns from occurring.



FIGURE 12

**The heater must not be used when the hood is removed.** Hook the hood over the lip of the curtain support plate.

### LOGO PLACEMENT

Remove the backing of the logo supplied and place on the screen cover, as indicated.

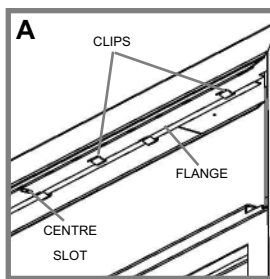
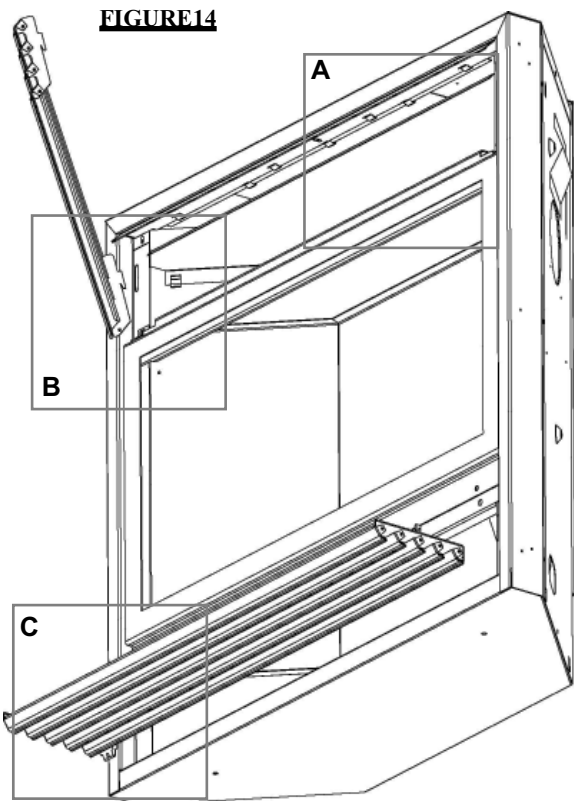

FIGURE 13

LOGO



## L36 LOUVRE INSTALLATION



### HOOD

Attach the hood by pressing the top flange into the clips along the top of the louvre opening. Secure using a screw through the centre slot.

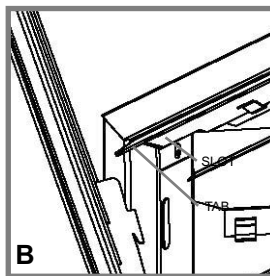

### UPPER LOUVRES

Insert the louvre tabs into the slots located at the top left and right corners of the unit.

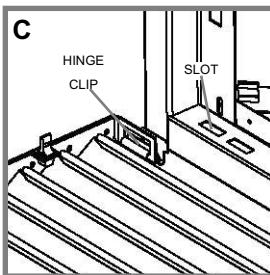

### LOWER LOUVRES

Insert the hinge clips into the slots located at the bottom left and right corners of the unit. To remove the louvres, pull the back tabs of the clips forward, while pushing the louvre assembly back. Lift the clip.

## OPTIONAL BLOWER INSTALLATION

**INSTALLATION TO BE DONE BY A QUALIFIED INSTALLER** and must be electrically connected and grounded in accordance with local codes. In the absence of local codes, use the current ANSI/NFPA 70 NATIONAL ELECTRICAL CODE.

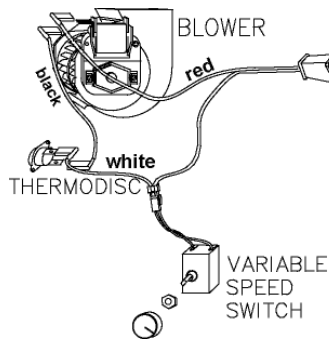

**FIGURE 15**

If the fireplace was not previously equipped with a blower: route a grounded 2-wire, 60hz power cable to the junction box. At this point, it must be strain relieved and insulated.

The three slots on the blower mounting bracket allow ease of adjustment when attaching the blower. For a quiet running blower, do not allow the assembly to sit on the firebox base.

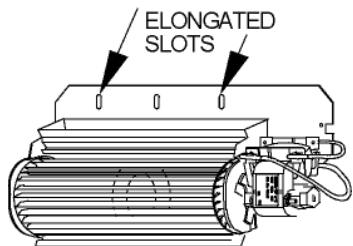

**FIGURE 16**

If optional blower kit is to be installed, remove thermodisc from the bracket supplied in the kit and discard the bracket. Install thermodisc in the bracket supplied with the fireplace. It is recommended to attach the wires to the disc and install

the bracket before installing the blower. Attach the black and white wires to the disc, then secure the bracket to the stud at the bottom left on the unit using the lock washer and wing nut. Ensure that the thermodisc touches the firebox wall.

Slide the vibration reducing pad (A) into the clip (C) and up against the threaded stud (B) at the other end. The blower must be able to be positioned entirely onto the pad.

Tilt the blower onto its side. Slide it past the controls and into the clip (C). Secure to the threaded stud using the lock washer and wing nut provided. Ensure that the blower does not touch the fireplace base or the firebox.

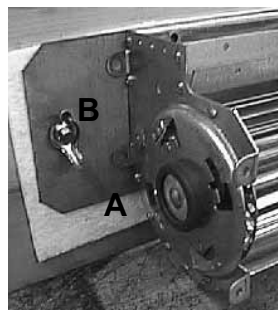

**FIGURE 17**

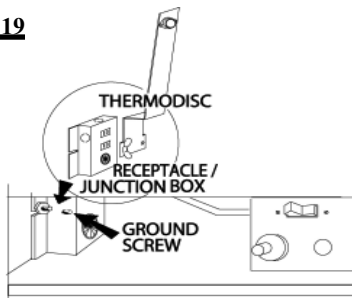
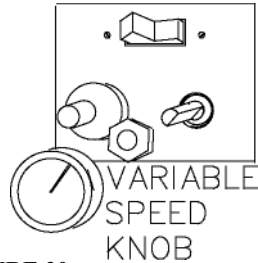

**FIGURE 18**

**FIGURE 19**

Attach the connectors from the black and red wires to the blower.

Attach and secure the variable speed switch using the nut provided. Plug the harness cord into the receptacle.

**FIGURE 20**

The wire harness provided in this kit is a universal harness. When installed, ensure that any excess wire is contained, preventing it from making contact with moving or hot objects.

Because the blower is thermally activated, when turned on, it will automatically start approximately 10 minutes after lighting the fireplace and will run for approximately 30-45 after the fireplace has been turned off. Use of the fan increases the output of heat.

Drywall dust will penetrate into the blower bearings causing irreparable damage. Care must be taken to prevent drywall dust from coming into contact with the blower or its compartment. Any damage resulting from this condition is not covered by the warranty policy.

## GD65 FAN INSTALLATION

*ELECTRICAL INSTALLATION TO BE DONE BY A QUALIFIED INSTALLER* and must be connected and grounded in accordance with local codes. In the absence of local codes, use the current ANSI/NFPA 70 NATIONAL ELECTRICAL CODE.

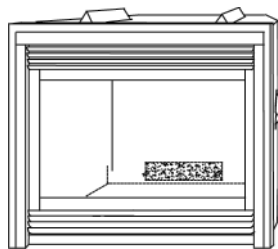
**FIGURE 21**

If the fireplace was not previously equipped with a blower, route a grounded 2-wire, 60hz power cable to the junction box. At this point, it must be strain relieved and insulated.

The wire harness provided in this kit is a universal harness. When installed, ensure that any excess wire is contained, preventing it from making contact with moving or hot objects.

Position the vibration reducing pad into the clip and onto the threaded stud at the other end, piercing a hole into the pad. The fan assembly must be able to be positioned entirely onto the pad.

W415-0298 / K / 12.06.07

**FIGURE 22**

Slide the fan assembly past the controls and into the clip. Secure using the lock washer and nut provided. Plug the harness cord into the re- OPEN ENDED SLOTS

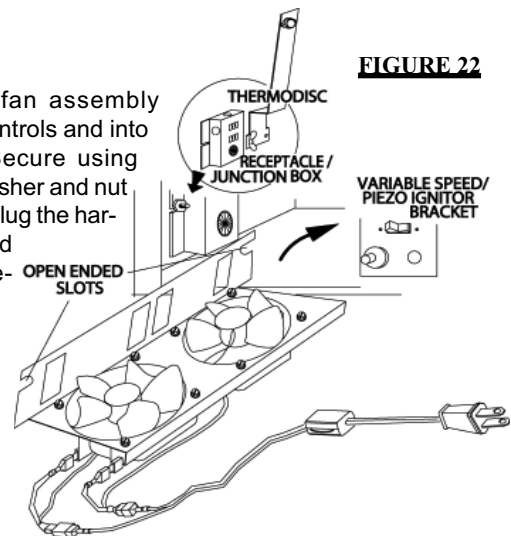

## GD36 THERMOSTATIC SENSOR CONTROL

*This optional kit is meant to be used only in conjunction with the GD65 Fan Kit, which may be ordered from your Wolf Steel /Continental® dealer.*

With the thermostatic sensor option, the fan, when turned on, becomes thermally activated, and will automatically run approximately 10 minutes after the fireplace has been lit and for approximately 30-45 minutes after the fireplace has been turned off.

Use of the fan increases the output of heat.

If optional thermostatic sensor kit is to be installed, remove thermodisc from the bracket supplied in the kit and discard the bracket. Install thermodisc in the bracket supplied with the fireplace. It is recommended to attach the wires to the disc and install the bracket before installing the blower. Attach the black and white wires to the disc, then secure the bracket to the stud at the bottom left on the unit using the lock washer and wing nut. Ensure that the thermodisc touches the firebox wall.

Unplug the power cord from the receptacle. Connect all wires as shown.

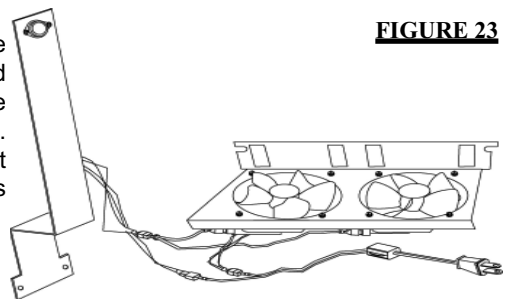
**FIGURE 23**

Plug the power cord back into the receptacle.

When installed, ensure that any excess wire is contained, preventing it from making contact with moving or hot objects.

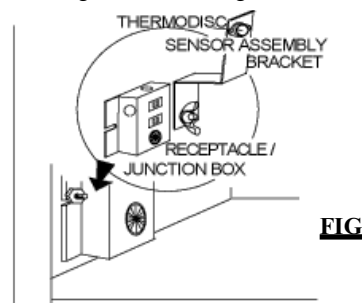
**FIGURE 24**

## OPERATION / MAINTENANCE

If heater shuts off, do not relight until you provide fresh air. If heater keeps shutting off, have it serviced. Keep burner and control compartment clean.

When lit for the first time, the fireplace will emit a slight odour for a few hours. This is a normal temporary condition caused by the curing of the logs and the "burn-in" of

internal paints and lubricants used in the manufacturing process and will not occur again.

After extended periods of non-operation such as following a vacation or a warm weather season, the fireplace may emit a slight odour for a few hours. This is caused by dust particles burning off. In both cases, open a window to sufficiently ventilate the room.

### FOR YOUR SAFETY READ BEFORE LIGHTING:

**WARNING: IF YOU DO NOT FOLLOW THESE INSTRUCTIONS EXACTLY, A FIRE OR EXPLOSION MAY RESULT CAUSING PROPERTY DAMAGE, PERSONAL INJURY OR LOSS OF LIFE.**

- This fireplace is equipped with a pilot which must be lit by hand while following these instructions exactly.
- Before operating smell all around the fireplace area for gas and next to the floor because some gas is heavier than air and will settle on the floor.
- Use only your hand to push in and turn the gas control knob. Never use tools. If the knob will not push in and turn by hand, do not try to repair it. Call a qualified service technician. Force or attempted repair may result in a fire or explosion.
- Do not use this fireplace if any part has been under water. Immediately call a qualified service technician to inspect the fireplace and replace any part of the control system and any gas control which has been under water.

### WHAT TO DO IF YOU SMELL GAS:

- Do not try to light any appliance.
- Do not touch any electric switch; do not use any phone in your building.
- Immediately call your gas supplier from a neighbour's phone. Follow the gas supplier's instructions.
- If you cannot reach your gas supplier, call the fire department.

**FIGURE 25**



**OXYGEN DEPLETION SENSOR**



**FIGURE 26**



**GAS KNOB**

### LIGHTING INSTRUCTIONS

When lighting and re-lighting, the gas knob cannot be turned from pilot to off unless the knob is depressed.

- STOP! Read the above safety information on this label.
- Set the thermostat to lowest setting.
- Turn off all electric power to the fireplace.
- Open the control door. Turn the gas knob clockwise  to off.
- Wait five (5) minutes to clear out any gas. If you smell gas including near the floor, STOP! Follow "B" in the above safety information on this label. If you don't smell gas go to the next step.
- Find pilot located in front of the back log.
- Turn gas knob counter-clockwise  to pilot.

- Depress and hold gas knob while lighting the pilot with the push button igniter. Keep knob fully depressed for one minute, then release. If pilot does not continue to burn repeat steps 3 through 7.
- With pilot lit, turn gas knob counter-clockwise  to on. When the pilot has been turned off, ignition of the main burner may be delayed from 1-2 minutes. When the pilot has been left burning, ignition of the main burner should occur almost immediately.
- If equipped with remote on-off switch, main burner may not come on when you turn the valve to on. Remote switch must be in the on position to ignite burner.
- Turn on all electric power to the fireplace.

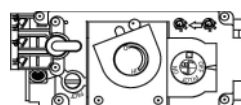

GAS KNOB AT OFF

**FIGURE 27**

### TO TURN OFF GAS

- Turn off all electric power to the fireplace if service is to be performed.

- Push in gas control knob slightly and turn clockwise  to off. Do not force.

**MAINTENANCE**

**TURN OFF THE GAS AND ELECTRICAL POWER BEFORE SERVICING THE FIREPLACE.**

CAUTION: Label all wires prior to disconnection when servicing controls. Wiring errors can cause improper and dangerous operation. Verify proper operation after servicing. This heater should be inspected and serviced before use and at least annually by a qualified service person. The fireplace area must be kept clear and free of combustible materials, gasoline or other flammable vapours and liquids. The flow of combustion and ventilation air must not be obstructed.

1. In order to properly clean the burner and oxygen depletion sensor pilot system, remove the logs to expose both assemblies.
2. Keep the control compartment, logs, burner, air shutter opening and the area surrounding the logs clean by vacuuming or brushing, *at least once a year*.
3. Check to see that all burner ports are burning. Clean out any of the ports which may not be burning or are not burning properly.
4. Check to see that the pilot flame is large enough to engulf the thermocouple and thermopile and promptly ignites the main burner.
5. Replace the cleaned logs.
6. Check to see that the main burner ignites completely on all openings when the gas knob for the burner is turned on. A 5 to 10 second total light-up period is satisfactory. If ignition takes longer, consult your Continental® dealer / distributor.

**OXYGEN DEPLETION SENSOR PILOT CLEANING**

**This procedure must be performed by a qualified service person!**

Inspect the pilot for any visible contamination or debris (usually lint, pet hair, spider webs, carpet fibre, etc.) and remove.

Disconnect the pilot from the pilot tubing line. Using a 7/16" wrench, remove the injector from the pilot housing. Blow out the housing in the same direction as the gas flow.

Re-install the injector and the pilot tube, turn on the gas and check for leaks.

If this does not improve the performance, replace the pilot with **an exact replacement**. The device is tamper resistant with no field serviceable parts.

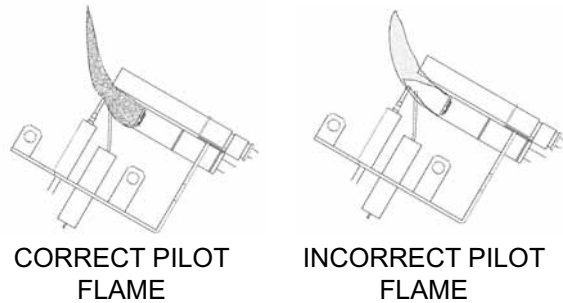

**FIGURES 28**

**VENTURI ADJUSTMENT**

**Air shutter adjustment must only be done by a qualified gas installer!**

Closing the air shutter will cause a more yellow flame, but can lead to carboning.

**WARNING: Carbon can be distributed in surrounding living area if the air shutter is improperly adjusted.**

Opening the air shutter will cause a more blue flame, but can cause flame lifting from the burner ports. The flame may not appear yellow immediately; allow 15 to 30 minutes for the final flame colour to be established.

Opening the air shutter will also reduce exhaust odours smelled within the room. See *Trouble Shooting Guide*.

AIR SHUTTER OPENINGS	
NG	3/16"
LP	1/2"

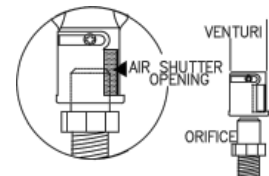

**FIGURES 29**

# REPLACEMENTS

Contact your dealer for questions concerning prices and availability of replacement parts. Normally all parts can be ordered through your Continental® dealer or distributor.

When ordering replacement parts always give the following information:

**FOR WARRANTY REPLACEMENT PARTS, A PHOTOCOPY OF THE ORIGINAL INVOICE WILL BE REQUIRED TO HONOUR THE CLAIM.**

\* IDENTIFIES ITEMS WHICH ARE NOT ILLUSTRATED. FOR FURTHER INFORMATION, CONTACT YOUR CONTINENTAL®

## REPLACEMENT PARTS

#	PART NO.	DESCRIPTION
1	W357-0001	PIEZO IGNITER
2	W662-0001	OXYGEN DEPLETION SENSOR SYSTEM - NG
2	W662-0002	OXYGEN DEPLETION SENSOR SYSTEM - LP
3*	W680-0004	THERMOPILE
4	W725-0030	NATURAL GAS VALVE
4	W725-0031	PROPANE GAS VALVE
5*	W385-0245	CONTINENTAL® LOGO
6*	W750-0112	20FT OF WIRE
7	GL-664	ONE PIECE LOG SET (W135-0335)
8*	W361-0016	GLOWING EMBERS
9*	W550-0001	CHARCOAL EMBERS
10	W010-0764	PAN BURNER(NG)
10	W010-0987	PAN BURNER(LP)
11	W455-0026	#38 NATURAL GAS BURNER ORIFICE
11	W455-0059	#53 PROPANE GAS BURNER ORIFICE
12	W335-0050	HOOD
13	W565-0058	CURTAIN MESH
14	W555-0033	CURTAIN ROD
15*	W080-0507	CURTAIN ROD BRACKET
16	W500-0184	CURTAIN SUPPORT PLATE
17	W630-0010	BLACK TASSELS

## ACCESSORIES

#	PART NO.	DESCRIPTION
18*	W690-0001	MILLIVOLT THERMOSTAT
19*	W660-0011	REMOTE CONTROL - ADVANTAGE PLUS
20*	W660-0013	MODULATING REMOTE
21*	W500-0033	VARIABLE SPEED SWITCH WALL MOUNTING PLATE
22	GZ550-KT	BLOWER KIT
23*	GD65	FAN KIT
24*	GD36	THERMOSTATIC SENSOR CONTROL KIT Use w/ GD65 ONLY
25*	GD825-N	MODULATING REGULATOR NG
25*	GD825-P	MODULATING REGULATOR LP
26	CDV4L	LOUVRE OVERLAY
26	CDV4LSS	LOUVRE OVERLAY - STAINLESS STEEL
27	HOIK-1	HERITAGE ORNAMENTAL INSETS - BLACK
27	HOIG-1	HERITAGE ORNAMENTAL INSETS - GOLD PLATED
27	HOIKG-1	HERITAGE ORNAMENTAL INSETS - BLACK GOLD PLATED
27	HOIBC-1	HERITAGE ORNAMENTAL INSETS - BRUSHED COPPER PLATED
27	HOIBG-1	HERITAGE ORNAMENTAL INSETS - BRUSHED GOLD PLATED
27	HOISS-1	HERITAGE ORNAMENTAL INSETS - BRUSHED STAINLESS STEEL
28	DOIG-1	DIAMOND ORNAMENTAL INSETS - GOLD PLATED
28	DOIKG-1	DIAMOND ORNAMENTAL INSETS - BLACK GOLD PLATED
28	DOIBC-1	DIAMOND ORNAMENTAL INSETS - BRUSHED COPPER PLATED
28	DOIBG-1	DIAMOND ORNAMENTAL INSETS - BRUSHED GOLD PLATED
28	DOISS-1	DIAMOND ORNAMENTAL INSETS - BRUSHED STAINLESS STEEL
29	GOIG-1	GOTHIC ORNAMENTAL INSETS - GOLD PLATED
29	GOIKG-1	GOTHIC ORNAMENTAL INSETS - BLACK GOLD PLATED
29	GOIBC-1	GOTHIC ORNAMENTAL INSETS - BRUSHED COPPER PLATED
29	GOIBG-1	GOTHIC ORNAMENTAL INSETS - BRUSHED GOLD PLATED
30	SOIG-1	SEASHELL ORNAMENTAL INSETS - GOLD PLATED
30	SOIKG-1	SEASHELL ORNAMENTAL INSETS - BLACK GOLD PLATED
30	SOIBC-1	SEASHELL ORNAMENTAL INSETS - BRUSHED COPPER PLATED
30	SOIBG-1	SEASHELL ORNAMENTAL INSETS - BRUSHED GOLD PLATED
31	EOIG-1	ECLIPSE ORNAMENTAL INSETS - GOLD PLATED
31	EOIKG-1	ECLIPSE ORNAMENTAL INSETS - BLACK GOLD PLATED
31	EOIBC-1	ECLIPSE ORNAMENTAL INSETS - BRUSHED COPPER PLATED
31	EOIBG-1	ECLIPSE ORNAMENTAL INSETS - BRUSHED GOLD PLATED

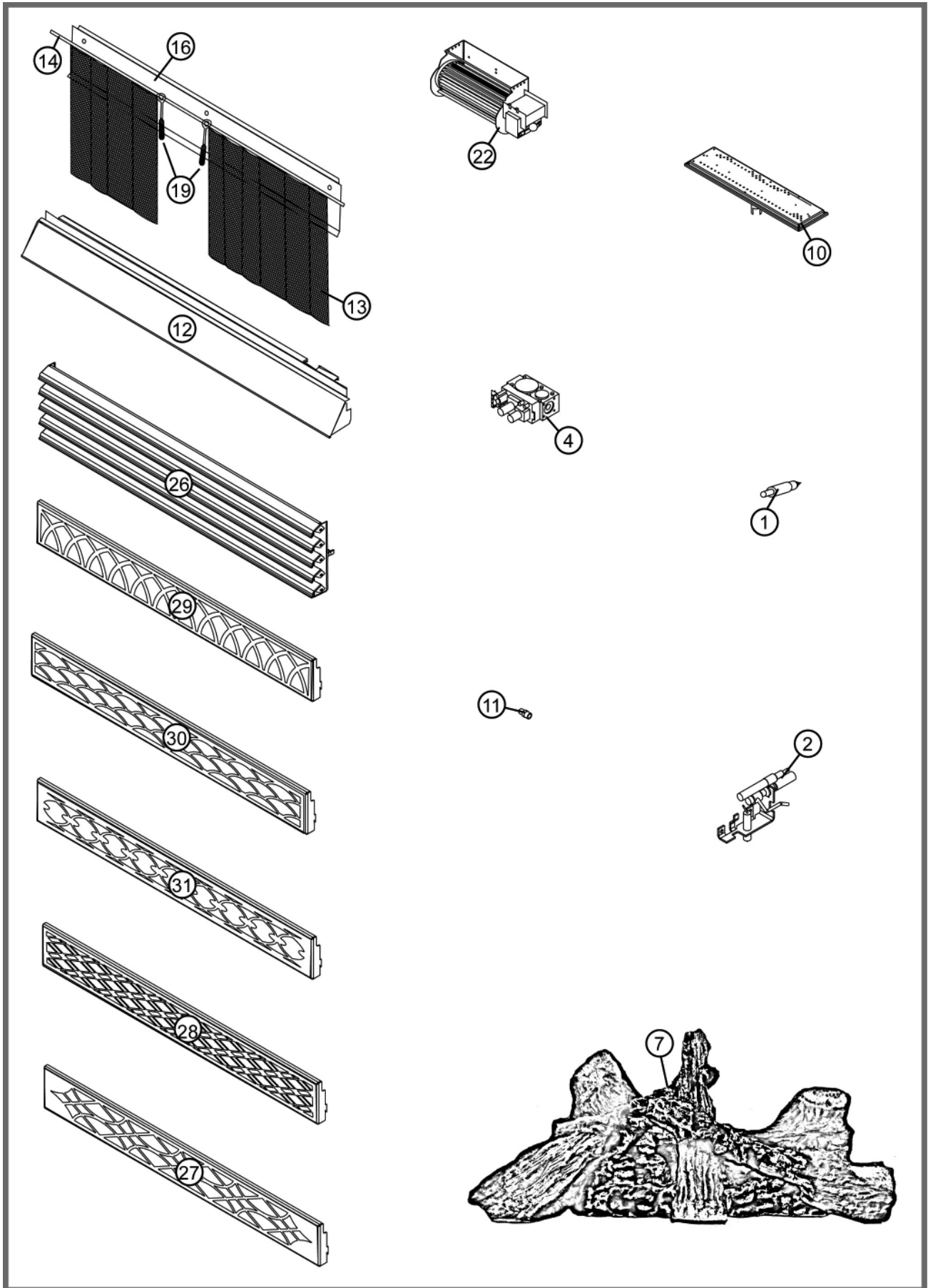

# TROUBLE SHOOTING GUIDE

BEFORE ATTEMPTING TO TROUBLESHOOT, PURGE YOUR UNIT AND INITIALLY LIGHT THE PILOT AND THE MAIN BURNER WITH THE GLASS DOOR REMOVED.

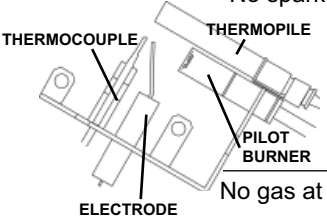
SYMPTOM	PROBLEM	TEST SOLUTION
Main burner goes out; pilot stays on.	Pilot flame is not large enough or not engulfing the thermopile	<ul style="list-style-type: none"> <li>- service or replace Oxygen Depletion Sensor System</li> <li>- correct piping and/or regulator to provide correct pressure</li> </ul>
	Thermopile shorting	<ul style="list-style-type: none"> <li>- clean thermopile connection to the valve. Reconnect.</li> <li>- replace Oxygen Depletion Sensor System / valve.</li> </ul>
	Remote wall switch wire is too long; too much resistance in the system.	<ul style="list-style-type: none"> <li>- shorten wire to correct length or wire gauge.</li> </ul>
	Faulty thermostat or switch.	<ul style="list-style-type: none"> <li>- replace.</li> </ul>
Main burner goes out; pilot goes out.	Insufficient air supply	<ul style="list-style-type: none"> <li>- open window or door. (Use one of the methods described in ANSI Z223.1 Section 5.3 or the applicable local code.)</li> </ul>
	Out of propane gas.	<ul style="list-style-type: none"> <li>- fill the tank.</li> </ul>
	Pilot flame is not large enough. (Supply pressure too low.)	<ul style="list-style-type: none"> <li>- service or replace Oxygen Depletion Sensor System</li> <li>- correct piping and / or regulator to provide correct pressure.</li> </ul>
Pilot goes out when the gas knob is released.  <b>The gas valve has an interlock device which will not allow the pilot burner to be lit until the thermocouple has cooled. Allow approximately 60 seconds for the thermocouple to cool.</b>	System is not correctly purged.	<ul style="list-style-type: none"> <li>- purge the gas line. If a glass door has been installed, ensure that the door is open or removed prior to purging.</li> </ul>
	Out of propane gas.	<ul style="list-style-type: none"> <li>- fill the tank.</li> </ul>
	Pilot flame is not large enough. (Supply pressure too low.)	<ul style="list-style-type: none"> <li>- service or replace Oxygen Depletion Sensor System</li> </ul>
	Thermocouple shorting / faulty.	<ul style="list-style-type: none"> <li>- loosen and tighten thermocouple.</li> <li>- clean thermocouple and valve connection.</li> <li>- replace Oxygen Depletion Sensor System</li> <li>- test and replace valve.</li> </ul>
	Faulty valve.	<ul style="list-style-type: none"> <li>- replace.</li> </ul>
Pilot burning; no gas to main burner; gas knob is on 'HI'; wall switch / thermostat is on.	Thermostat or switch is defective.	<ul style="list-style-type: none"> <li>- connect a jumper wire across the wall switch terminals; if main burner lights, replace switch / thermostat.</li> </ul>
	Wall switch wiring is defective.	<ul style="list-style-type: none"> <li>- disconnect wires from valve. Connect a jumper wire across terminals 1 &amp; 3; if the main burner lights, check the wires for defects and / or replace wires.</li> </ul>
	Main burner orifice is	<ul style="list-style-type: none"> <li>- remove stoppage in orifice.</li> </ul>
	Faulty valve.	<ul style="list-style-type: none"> <li>- replace.</li> </ul>
Pilot will not light.	Out of propane gas	<ul style="list-style-type: none"> <li>- fill the tank.</li> </ul>
	No spark at pilot burner	<ul style="list-style-type: none"> <li>- check if pilot can be lit by a match</li> <li>- check that the wire is connected to the push button ignitor.</li> <li>- check if the push button ignitor needs tightening.</li> <li>- replace the wire if the wire insulation is broken or frayed.</li> <li>- replace the electrode if the ceramic insulator is cracked or broken.</li> <li>- replace the push button ignitor.</li> </ul>
	No gas at the pilot burner	<ul style="list-style-type: none"> <li>- check that the manual valve is turned on.</li> <li>- check the pilot orifice for blockage.</li> <li>- replace the valve / Oxygen Depletion Sensor System.</li> <li>- call the gas distributor.</li> </ul>

SYMPTOM	PROBLEM	TEST SOLUTION
Pilot goes out while standing; Main burner is in 'OFF' position.	Gas piping is undersized.	<ul style="list-style-type: none"> <li>- turn on all gas appliances and see if pilot flame flutters, diminishes or extinguishes, especially when main burner ignites. Monitor appliance supply working pressure.</li> <li>- check if supply piping size is to code. Correct all undersized piping.</li> </ul>
Main burner will not light, or is slow to light; noisy pilot.	Inlet pressure too high. Pilot flame blowing off, missing thermopile.	Adjust inlet pressure to ensure maximum 7.0" W.C. at gas valve for Natural gas and 13.0" W.C. for Propane.
Flames are consistently too large or too small. Carboning occurs.	Unit is over-fired or under-fired.	<ul style="list-style-type: none"> <li>- check pressure readings:</li> </ul> <p>Inlet pressure can be checked by turning screw (A) counter-clockwise 2 or 3 turns and then placing pressure gauge tubing over the test point. Check with burner operating on "HI". Gauge should read 7" (minimum 4.5") water column for natural gas or 13" (11" minimum) water column for propane.</p> <p>Outlet pressure can be checked the same as above using screw (B). Check with burner operating on "HI". Gauge should read 3.5" water column for natural gas or 10" water column for propane.</p> <p><b>AFTER TAKING PRESSURE READINGS, BE SURE TO TURN SCREWS CLOCKWISE FIRMLY TO RESEAL. DO NOT OVERTORQUE.</b></p> <p>Leak test with a soap and water solution.</p>
Carbon is being deposited on logs or combustion chamber surfaces.	Air shutter has become blocked	<ul style="list-style-type: none"> <li>- ensure air shutter opening is free of lint or other obstructions.</li> </ul>
	Flame is impinging on the logs or combustion chamber.	<ul style="list-style-type: none"> <li>- check that the logs are correctly positioned.</li> <li>- *open air shutter to increase the primary air. See air shutter openings, page 13.</li> <li>- check the input rate: check the manifold pressure and orifice size as specified by the rating plate values.</li> </ul>
Exhaust fumes smelled in room, headaches.	Not enough combustion air.	- increase fresh air supply. (Use one of the methods described in ANSI Z223.1 Section 5.3 or the applicable local code.)
	Not enough ventilation air.	- increase fresh air supply. (Use one of the methods described in ANSI Z223.1 Section 5.3 or the applicable local code.)
	Flame is impinging on the logs or combustion chamber.	<ul style="list-style-type: none"> <li>- check that the logs are correctly positioned.</li> <li>- open air shutter to increase the primary air. See air shutter openings, page 13.</li> <li>- check the input rate: check the manifold pressure and orifice size as specified by the rating plate values.</li> </ul>
Remote wall switch is in "OFF" position; main burner comes on when gas knob is turned to "ON" position.	Wall switch is mounted upside down	- reverse.
	Remote wall switch is grounding.	- replace.
	Remote wall switch wire is grounding.	- check for ground (short); repair ground or replace wire.
	Faulty valve.	- replace.

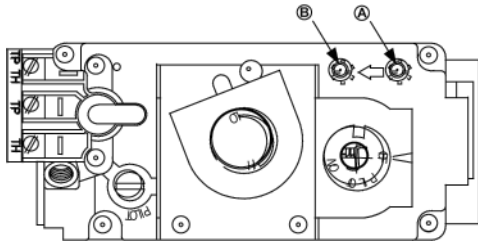

\* Check for ceiling or oscillating fans that maybe influencing the flame.







## Free Manuals Download Website

<http://myh66.com>

<http://usermanuals.us>

<http://www.somanuals.com>

<http://www.4manuals.cc>

<http://www.manual-lib.com>

<http://www.404manual.com>

<http://www.luxmanual.com>

<http://aubethermostatmanual.com>

Golf course search by state

<http://golfingnear.com>

Email search by domain

<http://emailbydomain.com>

Auto manuals search

<http://auto.somanuals.com>

TV manuals search

<http://tv.somanuals.com>