

COBY®

DVD-298

Progressive scan DVD/CD/CD-R/CD-RW/JPEG Player
with Card Slot , USB and HDMI Ports

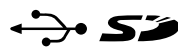

298SP



Instruction Manual

Please read this manual carefully before operation.

PRECAUTIONS

	CAUTION <i>RISK OF ELECTRIC SHOCK</i> <i>DO NOT OPEN</i>	
CAUTION: TO REDUCE THE RISK OF FIRE AND ELECTRIC SHOCK, DO NOT REMOVE THE COVER (OR BACK) OF THE UNIT. REFER SERVICING ONLY TO QUALIFIED SERVICE PERSONNEL.		

For Customer Use:

Enter below the serial number that is located on the bottom of the unit. Retain this information for future reference.

Model No. _____ DVD-298 _____

Serial No. _____



The lightning flash with arrowhead symbol within an equilateral triangle is intended to alert the user to the presence of uninsulated "dangerous voltage" within the product's enclosure that may be of sufficient magnitude to constitute a risk of electric shock.



The exclamation point within an equilateral triangle is intended to alert the user to the presence of important operation and servicing instructions in the literature accompanying the appliance.

WARNING:

To prevent fire or shock hazard, do not expose this device to rain or moisture. Dangerous high voltage is present inside the enclosure. Do not open the cabinet.

Handling the cords on this product will expose you to lead, a chemical known to the State of California to cause cancer, and birth defects or other reproductive harm. Wash hands after handling.

CAUTION:

This Digital Video Disc player employs a laser system. To prevent direct exposure to the laser beam, do not try to open the enclosure or defeat the safety interlocks. When open and the interlocks are defeated, visible laser radiation is present.

To prevent electric shock, match wide blade of plug to wide slot of outlet and fully insert.

Use of controls, adjustments, or performance of procedures other than those specified herein may result in hazardous radiation exposure. **DO NOT STARE INTO THE BEAM.**

NOTICE:

This product incorporates copyright protection technology that is protected by U.S. patents and other intellectual property rights. Use of this copyright protection technology must be authorized by Macrovision, and is intended for home and other limited viewing uses only unless otherwise authorized by Macrovision. Reverse engineering or disassembly is prohibited.

FCC Notice:

FCC Statement: this device complies with Part 15 of the FCC Rules. Operation is subject to the following two conditions:

(1) This device may not cause harmful interference, and (2) This device must accept any interference received, including interference that may cause undesired operation.

Note: This equipment has been tested and found to comply with the limits for Class B digital devices, pursuant to Part 15 of the FCC rules. These limits are designed to provide reasonable protection against harmful interference in a residential installation. This equipment generates, uses and can radiate radio frequency energy and, if not installed and used in accordance with the instructions, may cause harmful interference to radio communications. However, there is no guarantee that interference will not occur in a particular installation. If this equipment does cause harmful interference to radio or television reception, which can be determined by turning the equipment off and on, the user is encouraged to try to correct the interference by one or more of the following measures:

- Reorient or relocate the receiving antenna.- Increase the separation between the equipment and receiver.- Connect the equipment into an outlet on a circuit different from that to which the receiver is connected.- Consult the dealer or an experienced radio/TV technician for help.

Use of shielded cable is required to comply with Class B limits in Subpart B of Part 15 of the FCC rules.

PRECAUTIONS

Do not make any changes or modifications to the equipment unless otherwise specified in the manual. If such changes or modifications should be made, you could be required to stop operation of the equipment.

Manufactured under license from Dolby Laboratories. Dolby and the double-D symbol are trademarks of Dolby Laboratories. Confidential Unpublished Works.
© 1992-1997 Dolby Laboratories. All rights reserved.



This player has built-in copyright protection technology that prevents copying from a DVD disc to any media.

If a video recorder is connected to the player, the video output image will be distorted during recording.



For recycling or disposal information about this product, please contact your local authorities or the Electronics Industries Alliance: www.eiae.org.

IMPORTANT SAFETY INSTRUCTIONS

1. **Read Instructions:** All the safety and operating instructions should be read before the product is operated.
2. **Retain Instructions:** The safety and operating instructions should be retained for future reference.
3. **Heed Warnings:** All warnings on the product and in the operating instructions should be adhered to.
4. **Follow Instructions:** All operating and usage instructions should be followed.
5. **Cleaning:** Unplug this product from the wall outlet before cleaning. Do not use liquid cleaners or aerosol cleaners. Use a damp cloth for cleaning.
6. **Attachments:** Use only attachments recommended by the manufacturer. Use of other attachments may be hazardous.
7. **Water and Moisture:** Do not use this product near water (e.g., near a bath tub, washbowl, kitchen sink, laundry tub, in wet basements, or near a swimming pool and the like).
8. **Accessories:** Do not place this product on an unstable cart, stand, tripod, bracket, or table. Use only with carts, stands, tripods, brackets, or tables recommended by the manufacturer or sold with the product. Any mounting of the product should follow the manufacturer's instructions and should use a mounting accessory recommended by the manufacturer.
9. A product and cart combination should be moved with care. Quick stops, excessive force, and uneven surfaces may cause the product and cart combination to overturn.
10. **Ventilation:** Slots and openings in the cabinet are provided for ventilation to ensure reliable operation of the product and to protect it from overheating. These openings should never be blocked by placing the product on a bed, sofa, rug, or other similar surface. This product should not be placed in a built-in installation such as a bookcase or rack unless proper ventilation is provided or the manufacturer instructions have been adhered to.
11. **Power Sources:** This product should be operated only from the type of power source indicated on the rating label. If you are not sure of the type of power supply to your home, consult your product dealer or local power company. For products intended to operate from battery power or other sources, refer to the operating instructions.
12. **Grounding or Polarization:** This product may be equipped with a polarized alternating-current line plug that has one blade wider than the other. This plug will only fit into the power outlet in one direction. This is a safety feature. If you are unable to insert the plug fully into the outlet, try reversing the direction of the plug. If the plug should still fail to fit, contact an electrician to replace the obsolete outlet. Do not defeat the safety purpose of the polarized plug.
13. **Power-Cord Protection:** Power supply cords should be routed so that they are not likely to be walked on or pinched by items placed upon or against them, paying particular attention to cords at plugs, convenience receptacles, and at the point which they exit from the product.
14. **Protective Attachment Plug:** The product may be equipped with an attachment plug with overload protection. This is a safety feature. See the operating instructions for replacement or directions to reset the protective device. If replacement of the plug is required, be sure the service technician has used a replacement plug that has the same overload protection as the original plug as specified by the manufacturer.



IMPORTANT SAFETY INSTRUCTIONS

15. **Outdoor Antenna Grounding:** If an outside antenna is connected to the product, be sure the antenna system is grounded so as to provide some protection against voltage surges and built-up static charges. Article 810 of the National Electrical Code, ANS/NFPA 70 provides information with regard to proper grounding of the mast and supporting structure, grounding of the lead-in wire to an antenna-discharge unit, size of grounding conductors, location of antenna-discharge unit, connection to grounding electrodes, and requirements for the grounding electrode (see figure).

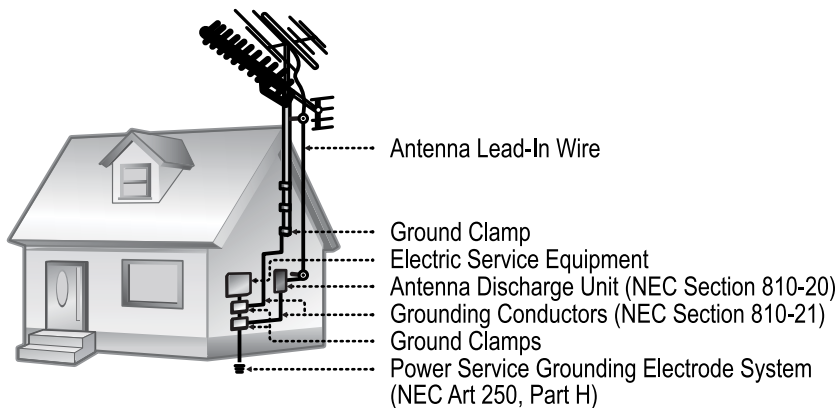

16. **Lightning:** For added protection for this product, unplug it from the wall outlet and disconnect the antenna or cable system during a lightning storm or when it is left unattended and unused for long periods of time. This will prevent damage to the product due to lightning or power-line surges.
17. **Power Lines:** An outside antenna system should not be located in the vicinity of overhead power lines or other electric light or power circuits, or where it can fall into such power lines or circuits. When installing an outside antenna system, extreme care should be taken to keep from touching such power lines or circuits, as contact with them might be fatal.
18. **Overloading:** Do not overload wall outlets, extension cords, or integral convenience receptacles as this can result in a risk of fire or electric shock.
19. **Object and Liquid Entry:** Never push objects of any kind into this product through openings as they may touch dangerous voltage points or short-out parts that could result in a fire or electric shock. Never spill liquid of any kind on the product.
20. **Servicing:** Do not attempt to service this product yourself as opening or removing covers may expose you to dangerous voltage or other hazards. Refer all servicing to qualified service personnel.
21. **Damage Requiring Service:** Unplug this product from the wall outlet and refer servicing to qualified service personnel under the following conditions: a) when the power-supply or plug is damaged; b) if liquid has been spilled or if objects have fallen into the product; c) if the product has been exposed to rain or water; d) if the product does not operate normally by following the operating instructions. Adjust only those controls that are covered by the operating instructions as improper adjustment of other controls may result in damage and will often require extensive work by a qualified technician to restore the product to its normal operation; e) if the product has been dropped or damaged in any way; f) when the product exhibits a

IMPORTANT SAFETY INSTRUCTIONS

distinct change in performance—this indicates a need for service.

22. **Replacement Parts:** When replacement parts are required, be sure that your service technician has used replacement parts specified by the manufacturer or have the same characteristics as the original part. Unauthorized substitutions may result in fire, electric shock, or other hazards.
23. **Safety Check:** Upon completion of any service or repairs to this product, ask the service technician to perform safety checks to ensure that the product is in proper operating condition.
24. **Wall or Ceiling Mounting:** The product should be mounted to a wall or ceiling only as recommended by the manufacturer.
25. **Heat:** The product should be situated away from heat sources such as radiators, heat registers, stoves, or other products (including amplifiers) that produce heat.

TABLE OF CONTENTS

PRECAUTIONS	2
IMPORTANT SAFETY INSTRUCTIONS	4
TABLE OF CONTENTS	5
ABOUT OPTICAL DISCS	9
Disc Requirements	9
Disc Care and Maintenance	9
Handling a Disc	9
Cleaning a Disc	9
FEATURES	10
LOCATION OF CONTROLS	11
Front Panel	11
Rear Panel	11
Remote Control	12
CONNECTIONS	13
Audio/Video Connections at a Glance	13
Standard Television Connection	14
Progressive Scan Video Connection	14
Stereo (2-Channel) Audio Connection with Amplifier	15
Surround (5.1-Channel) Audio Connection with Amplifier	15
HDMI Connection	16
USB/SD Card Connection	17
GETTING STARTED	18
Remote Control	18
Power Supply	18
BASIC OPERATIONS	19
Menu Navigation	19
Numeric Keypad	19
Adjusting the Volume	19
Disc Error Messages	19
Power Management	19
Basic Playback	20
Play/Pause/Stop	20
Previous/Next (Skip)	20
Forward/Reverse (Search)	20
Slow	20
PLAYER FUNCTIONS	21
Menu / Title	21
Mute	21
Setup	21
On-Screen Display	21
Goto	21
Repeat Mode	21



TABLE OF CONTENTS

Repeat Mode.....	22
Repeat A-B Mode	22
Video Out Mode	22
TV System Mode	22
DVD/USB/SD	22
Volume Up/Down	22
Zoom	22
Multi-Angle/Subtitle/Audio	23
Program.....	23
SETUP.....	24
Screen & Custom Settings.....	24
Language Settings	25
Audio Settings.....	25
Screen Settings.....	25
Audio Output Mode Settings.....	25
SPECIFICATIONS.....	26
TROUBLESHOOTING.....	27

ABOUT OPTICAL DISCS

Disc Requirements

This DVD player supports playback of the following discs.

Type	Disc Mark	Content Type	Disc Size	Max. Playback Time
DVD-Video Discs		Audio + Video (moving picture)	12 cm	133 min (SS-SL)
				242 min (SS-DL)
				266 min (DS-SL)
				484 min (DS-DL)
Audio Compact Discs (CDs)		Audio	12 cm	74 min
JPEG CDs	--	Still Picture	12 cm	--

This unit can play back CD-R and CD-RW discs that contain audio titles or JPEG picture files. Discs not listed above are not supported by this unit (e.g., PC CD-ROM, CD-Extra, CD-G, CD-I, etc.)

Disc Care and Maintenance

Optical discs (DVDs, CDs) contain high-density compressed data and need proper handling.

Handling a Disc

- Hold a DVD/CD by its edges. Avoid touching the recorded side of the disc. To remove a DVD/CD from its storage case, press down on the center retention mechanism of the case and lift the disc out.
- Do not subject discs to prolonged exposure to direct sunlight, high humidity, or high temperatures.
- Do not bend or press discs.
- To reduce the risk of scratches, always put discs back in their case after use. Store discs vertically in a cabinet.
- Do not place stickers or labels on either side of a disc.

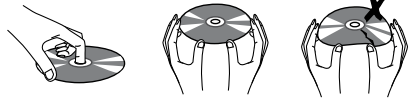

Cleaning a Disc

Use a dry, soft cloth to wipe off any fingerprints and dusts from the playing surface of the disc. Wipe in a straight line radially from the center to the outside edge of the disc. Small dust particles and light stains will not affect playback quality.



Never use chemicals such as record sprays, anti-static sprays, benzene, or thinners to clean a disc. Doing so will damage the surface of the disc permanently.

FEATURES

- Progressive Scan DVD Player
- Compact and Slim Design
- DVD, DVD±R/RW, CD, CD-R/RW, and JPEG Compatible
- Dolby Digital Decoder
- Digital, and Analog AV Outputs for Home Theater Use
- NTSC/PAL Compatible
- Convenient Front Panel and On-Screen Display
- Multiple Language, Subtitle, and Camera Angle Support
- Picture Zoom Function
- Parental Lock Control
- 100-240V Automatic Power Switching

LOCATION OF CONTROLS

Front Panel

1. Play/Pause Button
2. Stop Button
3. Next Button
4. Previous Button
5. Open/Close Button
6. SD Card Slot
7. USB Port
8. Disc Tray
9. Power Button
10. Front Panel Display
11. Remote Control Sensor

Rear Panel

1. S-Video out
2. Composite Video Out
3. Composite Video Out (Progressive Scan)
4. 2.1-Channel Audio Out:
L-CH (Left Channel)
R-CH (Right Channel)
5. Coaxial Digital Audio Out
6. HDMI Port (High-Definition Multi-media Interface)

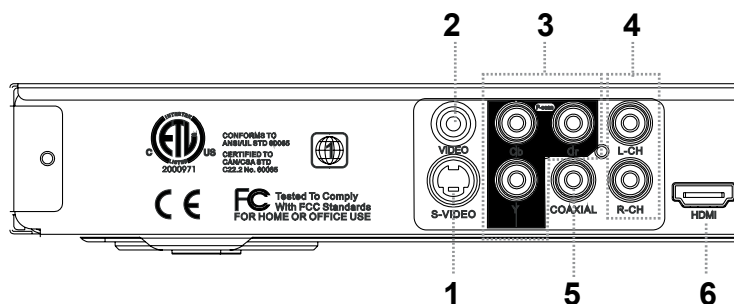

LOCATION OF CONTROLS

Remote Control

1. POWER ON/OFF button
2. DISPLAY button
3. MENU button
4. CLEAR button
5. PLAY/PAUSE button
6. REVERSE button
7. PREV button
8. GOTO button
9. RESET button
10. DIRECTION & OK button
11. ANGLE button
12. ZOOM button
13. DVD/USD/SD button
14. AUDIO button
15. SUBTITLE button
16. A-B button
17. P-SCAN button
18. OPEN/CLOSE button
19. TITLE button
20. NUMERIC buttons
21. FF button
22. STOP button
23. NEXT button
24. PRG button
25. SETUP button
26. VOL+ button
27. SLOW button
28. VOL- button
29. STEP button
30. MUTE button
31. REPEAT button
32. P/N button

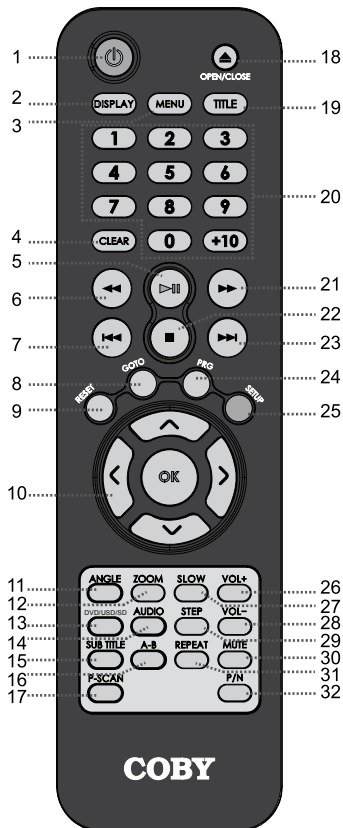

The remote control transmits a directional infrared beam. Be sure to aim the remote control directly at the infrared remote sensor during operation. The sensor may not be able to receive signals properly if the sensor is covered, if there is a large object between the remote control and the sensor, or if it is exposed to direct sunlight or a strong artificial light (e.g., fluorescent or strobe lights). In this case, change the direction of the light or reposition the unit to avoid direct lighting.

CONNECTIONS

Audio / Video Connections at a Glance

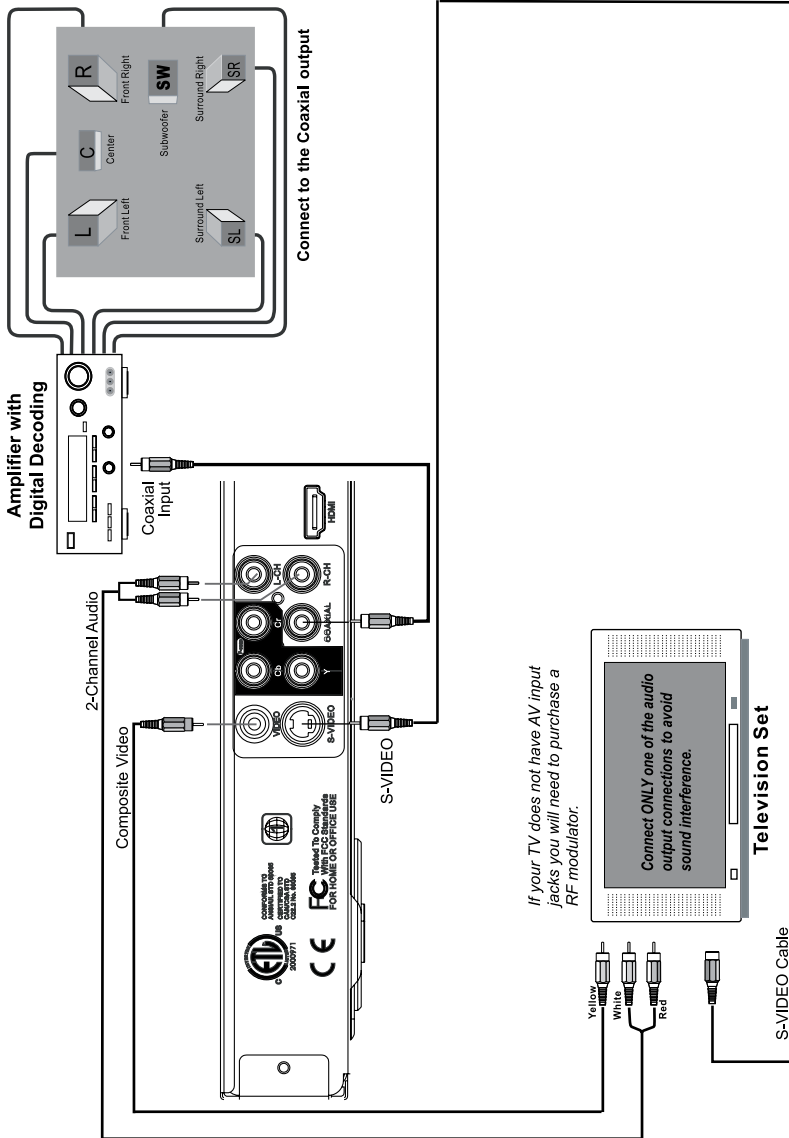

! The player has built in copy-right protection technology that prevents copying from a DVD disc to any media.
If a video recorder is connected to the player, the video output image will be distorted during recording.

▲ Connect only one type of audio or video connection at a time to minimize interference.

▲ Connect the AC power cord to the wall outlet **AFTER** all other cables are connected.

Connect ONLY one of the audio output connections to avoid sound interference.

CONNECTIONS

Standard Television Connection

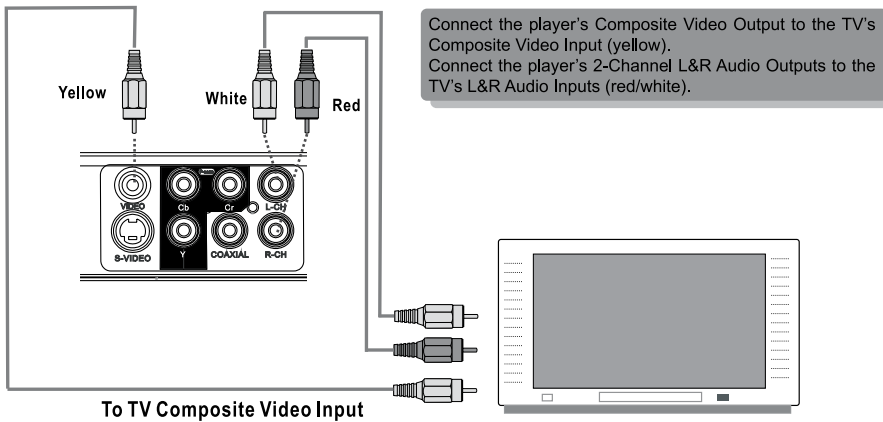

Progressive Scan Video Connection

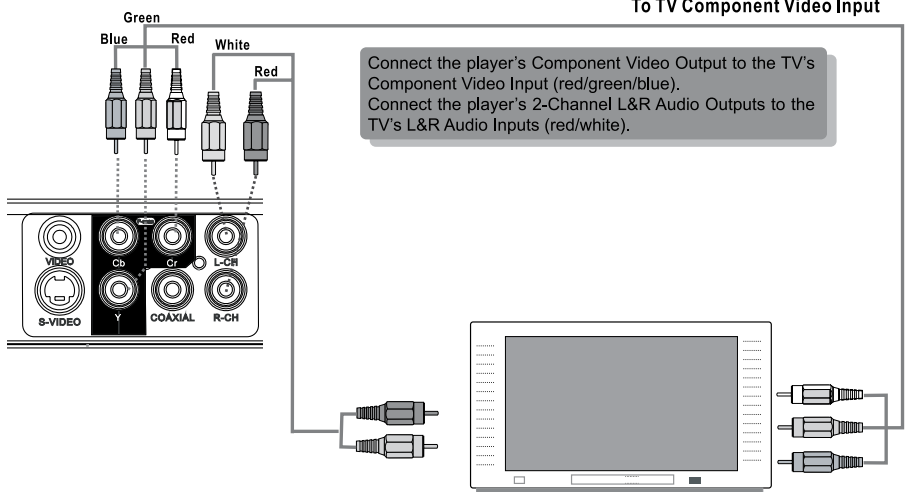

- 1 The player is equipped with composite AV outputs at the rear panel (yellow/red/white). Your TV will require at least one set of AV inputs. The supplied AV patch cord will connect your player's AV output to your TV's inputs.
- 2 The player is equipped with 2-channel stereo or 5.1-channel surround sound outputs on the rear panel. For stereo or surround sound, a Stereo TV or Surround AV receiver is necessary. For Mono TVs, you can connect either the Left or Right stereo audio output to the Mono TV's audio input.
- 3 Depending on the brand of your TV, you may need to press a button labeled "Line", "Input", or "Video/TV" in order to set your TV to the correct input line. This will switch the TV from broadcast reception mode to on of the AV input signals. (Some TVs may have more than on AV input line.)

CONNECTIONS

Stereo (2-Channel) Audio Connection with Amplifier

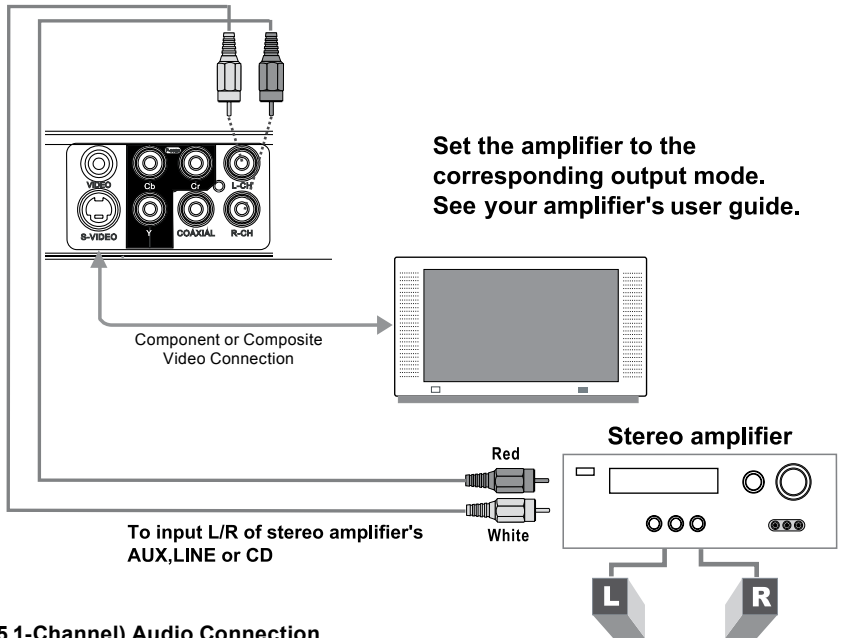

Surround (5.1-Channel) Audio Connection with Amplifier

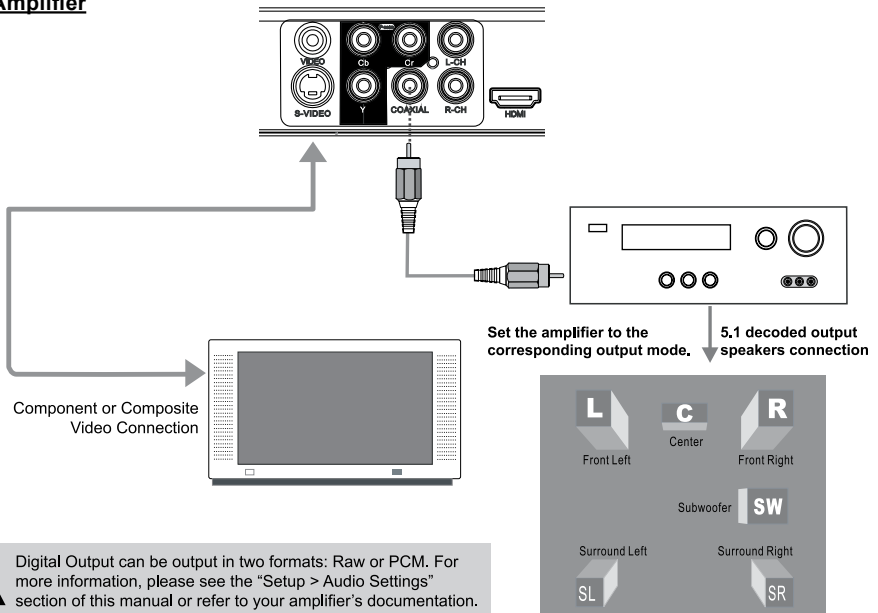

Digital Output can be output in two formats: Raw or PCM. For more information, please see the "Setup > Audio Settings" section of this manual or refer to your amplifier's documentation.

CONNECTIONS

HDMI Connection

Connect the HDMI port to output audio/video signal.

NOTE:

Before HDMI connection, please set the HDMI output on.
Please refer to Setup section for details.

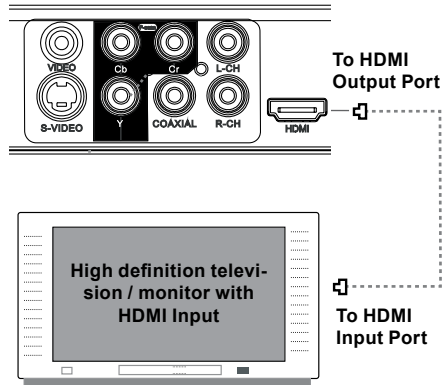

CONNECTIONS

USB/SD Card Connection

Insert an USB flash drive or a SD card to the corresponding slot.

To access the USB/Card

- Press the DVD/USB/SD button on the remote control or press and hold STOP button on the player for 2-3 seconds to show the Device Select menu.



Device Select

- Press the UP/DOWN direction button on the remote control to select USB and press OK to access.

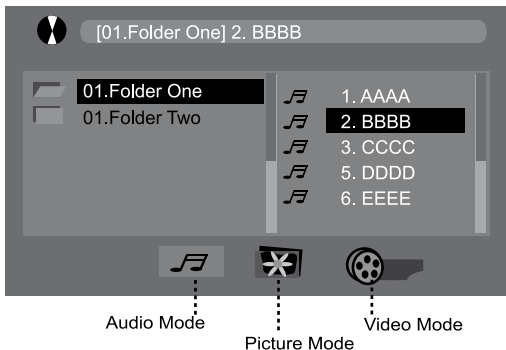

Audio Playback

Select Audio Mode by Direction button.

Press UP/DOWN direction button to select the desired track and press the OK button to play.

Press the ⏩ / ⏪ button to fast-forward / reverse through the current file.

Press the PLAY button for normal playback.

Photo Playback

Select Picture Mode by Direction button.

Press UP/DOWN direction button to select the desired photo and press the OK button to start picture slideshow playback.

Press the PLAY button to pause, press it again to resume slideshow.

Press the Left/Right direction button to rotate the current photo, press the Up/Down direction button to reverse the current picture.

Press ⏩ to view the next photo, press ⏪ to view the previous photo.

Press the Stop button to stop and return to main menu.

Video Playback

Select Video Mode by Direction button.

Press UP/DOWN direction button to select the desired track and press the OK button to play.

Press the PLAY button to pause playback, press it again to resume.

Press the ⏩ / ⏪ button to fast-forward / reverse through the current track.

Press the PLAY button for normal playback.

Press ⏩ to play the next track, press ⏪ to play the previous track.

Press the Stop button to stop and return to main menu.

GETTING STARTED

Remote Control

- Refer to the diagram. Remove the battery compartment cover located on the rear of the remote control. Insert batteries, making sure to match their polarities (+/-) to the markings on the inside of the compartment. Replace the cover.
- To use the remote, point it at the remote sensor of the player. Operate the remote within 15 feet of the sensor and at an angle of +/- 60 degrees.
- Batteries in the remote will last for approximately 1 year. Replace the batteries if the remote control does not work. Do not mix old with new batteries, or different types of batteries.
- Remove the batteries from the remote if it will not be used for a long period of time.

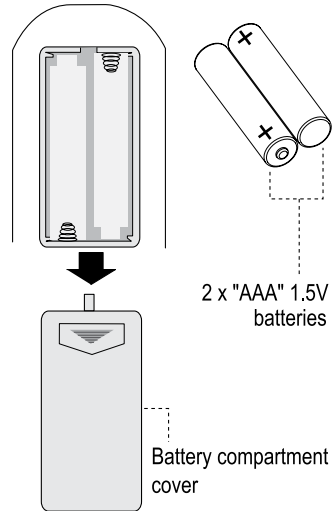

WARNING

- The batteries used in the remote control may present a fire or chemical burn if mistreated. Do not recharge, disassemble, incinerate, or heat the battery (~212°F).
- Keep batteries away from children.

Power Supply

This unit should be used with 100-240V 50/60Hz AC wall outlets, only.

Caution:

- *Do not connect the power plug to a power outlet other than that which is indicated here and on the label as this may result in the risk of fire or electric shock.*
- *Do not handle the power plug with wet hands. Doing so may cause electric shock.*

BASIC OPERATIONS

Menu Navigation

To navigate DVD disc menus or the player's setup menus:

- Press the Direction keys to select a desired feature or option in the menu.
- Press ENTER to confirm a selection in the menu.
 - For some menu options, you may be able to use the numeric keypad to input data.
- Press **CLEAR** to cancel an entry.



Numeric Keypad

- Use the numeric keypad to skip directly to a DVD chapter or CD track. (Some discs may not allow direct access function.)
- Use the numeric keypad to input numeric data in menu option fields when possible.



Adjusting the Volume

- Press VOL+ or VOL- to adjust your player's volume level output.

Disc Error Messages

The following messages will be displayed on-screen if there is a problem with the format of the loaded disc.

- **WRONG REGIONAL DISC.** The region code of the disc does not match the player's region code (Region 1).
- **WRONG PASSWORD.** The parental rating level of the disc is higher than the parental rating level setting of the player. The player will not play the disc.
- **WRONG DISC.** The player is equipped with automatic disc quality detection software. If the player detects a disc that is damaged or has a format problem, it may play the disc at a lower quality or stop play completely, depending on how damaged the disc is.
- **DTS Discs:** This player does not have a built-in DTS decoder.
 - Connect to a digital amplifier using a Digital Audio Connection to enjoy DTS audio discs.
 - Select 2-Channel Stereo Downmix instead of the DTS setting.

Note:

DVD disc production quality may vary; some discs may deviate from the industry standard. Some incorrectly-formatted discs may still play, however, the playback and operational quality of the disc may be substandard.

Power Management







If the player will not be in use for a long period of time, set the Power Switch to the OFF position, unplug the player, and remove the batteries from the remote control.

BASIC OPERATIONS



Basic Playback

1. Prepare the connections and power supply.
Set the Power Switch to the ON position to turn the player on.
2. Load a disc.
Press the Open/Close button to open the disc tray. Insert a disc with the label-side up.
Press the Open/Close button again to close the disc tray.
 - If a single-sided disc is inserted upside-down, the player will display "NO DISC" or "BAD DISC".
3. Start playback.
Press PLAY to start playback (some discs may start playing automatically).





Play/Pause/Stop

- Press  to play the disc for the first time.
- Press  during playback to pause. Press  again to resume playback.
- Press  during playback to stop the disc ("Pre-Stop"). Press  to resume playback at the time-point at which the disc was stopped.
- Press  when the disc is "Pre-Stopped" to stop playback completely. (When  is pressed, the disc will start playing from the beginning.)

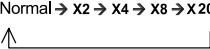

Previous/Next (Skip)

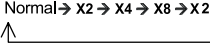
- Press  to skip to the next track (DVD, CD, etc).
- Press  to return to the previous track (DVD, CD, etc).

Forward/Reverse (Search)

- Repeatedly press  to search forward through a disc.
Normal → X2 → X4 → X8 → X20

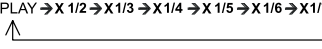
- Repeatedly press  to reverse.
Normal → X2 → X4 → X8 → X20

- Press  for normal playback.

Slow

- Press SLOW for slow-motion playback. Each successive press of SLOW will change the rate of slow-motion playback. Press  to resume normal playback.
PLAY → X 1/2 → X 1/3 → X 1/4 → X 1/5 → X 1/6 → X 1/7

- Press STEP frame-by-frame playback. Each successive press of STEP will advance the video one frame. Press  to resume normal playback.

Note:

Audio will be muted during fast-forward, fast-reverse, and slow-motion playback.

PLAYER FUNCTIONS

Menu / Title

- Press the MENU key during DVD playback to return to the disc's Main menu.
- Press the TITLE key during DVD playback to return to the disc's Title menu.

Mute

- Press MUTE to muffle/ release sound.

Setup

Press the SETUP key to enter the player's setup menu. Enter the Setup menu to adjust the player's internal settings; please see the SETUP section for more details.

On-Screen Display

The On-Screen Display (OSD) indicator is a user-friendly interface designed to display playback type status. The OSD indicator will display information based on the type of disc that has been loaded (i.e., DVD or CD).

Press the Display key to show time information on-screen; press it a third time to exit the on-screen display mode.

Goto

To select the desired section to play (search).

- Press the GOTO button to display the search bar.
- Press the DIRECTION button to select the desired item.
- Press the NUMERIC button to input data.
- Press the OK button to start playback.

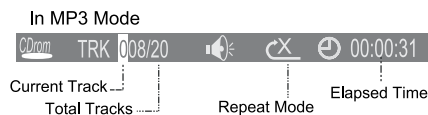
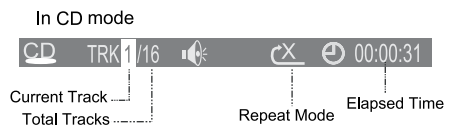
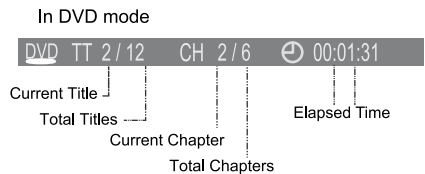

PLAYER FUNCTIONS

Repeat Mode

Press REPEAT to change the repeat mode of the player. Each successive press of REPEAT will change the mode as follows:

	DVD Mode	CD Mode	MP3 Mode
REPEAT x1	REPEAT OFF	REPEAT OFF	REPEAT OFF
REPEAT x2	REPEAT CHAPTER	REPEAT 1	REPEAT 1
REPEATX3	REPEAT TITLE	REPEAT ALL	REPEAT DIRECTION
REPEATX4	REPEAT ALL		REPEAT ALL

Note: Some DVD discs do not allow Repeat mode.

Repeat A-B Mode

To repeat a specific section of a disc (play on a loop):

1. Press A-B to set the desired start point ("A") of the section to be repeated.
2. Press A-B again to set the desired end point ("B") of the section to be repeated.
3. The section "A-B" will now play repeatedly as a loop. Press A-B again to resume normal-playback.

Video Out Mode

- Press P-SCAN button to shift between the Video Out modes S-Video + CVBS, P-Scan and YUV.

TV System Mode

- Press P/N button to shift between the TV System modes Auto, NTSC and PAL.

DVD/USB/SD

- Press the DVD/USB/SD button to select and enter DVD,USB or SD Card mode. See [USB/SD Card Connection Section](#) for operation details.

Volume Up /Down

- While playing a disc, press the VOL+ or VOL- button to adjust the volume level output.



Zoom

Press ZOOM to change the magnification level of the picture.

- During DVD playback, each successive press of ZOOM will change the level of magnification to: 2X -> 3X -> 4X -> 1/2 X -> 1/3X -> 1/4 X -> OFF
- During JPEG CD playback, each successive press of ZOOM will change the level of magnification to: 2X -> 3X -> 4X -> 1/2 X -> 1/3X -> 1/4 X -> OFF

When the magnification level is greater than Normal/100%, use the NAVIGATION keys to pan around the magnified picture.

When the magnification level is equal to 100%, use the NAVIGATION keys to rotate the picture.

Note: The picture quality will decrease as the zoom level (magnification) increases.

PLAYER FUNCTIONS

Multi-Angle/Subtitle/Audio

- During playback of a DVD that has been mastered with multiple angles, press ANGLE to view the available alternate camera angles. (A DVD may have up to 9 selectable angles.)
- During playback of a DVD that has been mastered with subtitles, press SUBTITLE to view the available subtitle tracks. (A DVD may have up to 32 selectable subtitles.)
- During playback of a DVD that has been mastered with alternate language/audio tracks, press AUDIO to hear the alternate tracks. (A DVD may have up to 8 selectable audio tracks.)

Program

Preset the target files to be played automatically by a given order. Press the PROGRAM button to display the program menu. (e.g. DVD Mode).

Note:

Use the numeric keypad to input numbers directly to the fields. Use the navigation keys to move between entry fields.

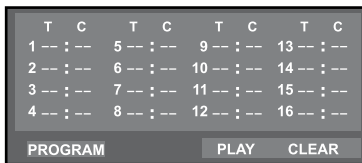

- Load a DVD and enter press the PROGRAM button to enter Program mode.
- Use the navigation keys to select a field.
 - Use the numeric keypad to enter track numbers in the left "T" columns (or press CLEAR to delete).
 - Use the numeric keypad to enter chapter numbers in the right "C" columns (or press CLEAR to delete).
- To start over, use the navigation keys to select "Clear" to delete all Track/Chapter selections.
- To play your programmed selections, press Play/Pause button or use the navigation keys to select "Play". Press PROGRAM to cancel.

SETUP

Various features of the player can be adjusted in the SETUP menu:

1. Press the SETUP button to display the setup menu.
2. Press the direction button to select the desired item.
3. Press OK to confirm.

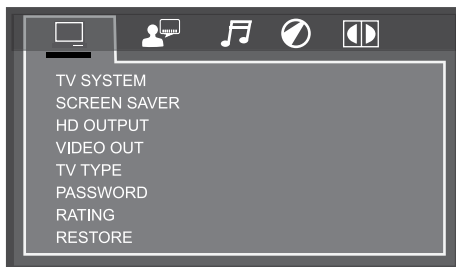

Screen & Custom Settings

Item	Description	Setting
TV SYSTEM	Sets the player's Video Out signal type. Set this to correspond with your TV. The standard for North America is NTSC.	NTSC
SCREEN SAVER	The screensaver prevents burn-in damage to the player's screen.	ON
HD OUTPUT	Sets High Definition Output Level.	HD OFF
VIDEO OUT	Sets the player's Video Out mode.	S-VIDEO+CVBS
TV TYPE	Sets the aspect ratio of the display. 4:3 is used with standard television displays; 16:9 is used with widescreen television displays.	4:3LB
PASSWORD	To change the password: enter the old password and then the new password. Press the OK button to confirm. The initial password is 8888. To unlock: Enter the correct password and then press the OK button.	8888
RATINGt	Sets the maturity rating level of the player. The player will not play any discs rated higher than this setting. There are eight rating levels. Level 1 will restrict playback to discs suitable for people of all ages. Level 8 will allow playback of all discs, including those suitable for adults only. To set the rating level: 1. Enter the correct password to unlock. See Password. 2. Select the desired rating level and press the OK button to confirm.	8
RESTORE	Resets all settings to their factory default state. This will not reset the Parental Ctrl password.	RESTORE

SETUP

Language Settings

Item	Description	Default Setting
OSD LANGUAGE	Sets the language of the player's on-screen display.	English
AUDIO LANGUAGE	Sets the default language audio track of loaded DVDs.	English
SUBTITLE LANGUAGE	Sets the default subtitle track of loaded DVDs.	OFF
MENU LANGUAGE	Sets the default menu language of loaded DVDs.	English
DIVX [R] VOD	Reads the DIVX information.	
POWER RESUME	Sets the Power Resume ON/OFF	OFF

Audio Settings

Item	Description	Default Setting
AUDIO OUT	Sets the player's Optical Out (audio) signal. For use with 5.1-channel receivers (see your receiver's manuals for more details).	SPDIF/RAW
HDMI AUDIO	Sets the HDMI Audio mode.	AUTO

Screen Settings

Item	Description	Default Setting
BRIGHTNESS	Adjust the screen's brightness	6
CONTRAST	Adjust the screen's contrast	6
HUE	Adjust the screen's hue	0
SATURATION	Adjust the screen's saturation	0
SHARPNESS	Adjust the screen's sharpness	0

Audio Output Mode Settings

Item	Description	Default Setting
OP Mode	Sets the audio output mode	LINE OUT
DYNAMIC RANGE	Sets the DYNAMIC RANGE	OFF
DUAL MONO	Sets the player's Optical Out (audio) mode	STEREO

SPECIFICATIONS

Video Format	MPEG 2
Audio Format	MPEG 1, LAYER 1, LAYER 2 , LAYER3
Signal Output	Color System: PAL / NTSC Audio System: DOLBY DIGITAL down mix stereo DOLBY DIGITAL digital output Audio DAC 24 bit/96KHz Video Output: 1Vpp (at 75ohm) Audio Output: (Stereo): 2Vrms (1KHz, 0dB)
Frequency Response	CD: 2Hz-20KHz(EIAJ) DVD: 4Hz-22KHz(48K) 4Hz-22KHz(96K)
S / N ratio	CD audio: 90dB
THD	CD audio: 0.05%(EIAJ)
Output Terminals	Video (composite) output x 1 Down Mix Stereo output (Left and Right) x 1 Digital audio (coaxial) output x 1
Power input	AC100-240V~50/60Hz 10W(Max.)
Pickup	Wave length: 655nm
Laser power	CLASS1

TROUBLESHOOTING

If you have a problem with this player, please read the troubleshooting guide below and check our website at www.cobyusa.com for Frequently Asked Questions (FAQs) and firmware updates. If these resources do not resolve the problem, please contact Technical Support.

COBY Electronics Technical Support

56-65 Rust Street
Maspeth, NY 11378

Hours: 8:00 AM–11:00 PM EST, seven days a week.

Email: techsupport@cobyusa.com

Phone: 718-416-3197, 800-681-2629, or 800-727-3592

Web: www.cobyusa.com

There is no power to the device.

- Ensure that the Power Switch on the main unit is physically set to the ON position.
- Ensure that the AC adapter cord is securely connected to the player and the proper wall outlet.

The device will not play the disc.

- Ensure that a supported disc is loaded in the player label-side up.
- Ensure that the disc's rating level does not exceed the player's parental rating level.
- Ensure that the disc is not damaged or too dirty. Clean the disc or try another disc.
- Moisture may have condensed inside the player. Remove the disc and leave the player on for 1-2 hours and then try again.

There is no picture.

- Ensure that the TV set has been powered on and is set to the correct AV mode.
- Ensure that the connections between the player and the TV are secure and correct.
- Check if the connection cables are damaged.
- Restore the player to its factory-default settings: open the disc tray, and then press PROGRAM and ZOOM together.

The picture is noisy or distorted.

- The disc may be damaged or dirty. Clean the disc or try another one.
- Reset your TV's color system.
- Ensure that the player is connected directly to the TV (and not through a VCR, cable box, satellite receiver, etc.)

The picture is not full-screen.

- Change the aspect ratio setting of your player from the Setup menu.
- Select a different aspect ratio option from the DVD disc menu.

TROUBLESHOOTING

There is no sound or distorted sound.

- Ensure that the TV and amplifier have been turned on and properly set up.
- Ensure that the TV and amplifier connections are secure and correct.
- Try a different Audio track of the DVD by pressing AUDIO.
- Ensure that the MUTE function of the TV, Amplifier, or Player is not engaged.

The remote control doesn't work.

- Ensure that the Power Switch has been physically set to the ON position.
- Ensure that there are no obstacles between the remote and the player.
- Point the remote at the remote sensor on the main unit.
- Ensure that the batteries in the remote retain a charge and have been installed correctly.
- Try replacing the remote's batteries.

The player has malfunctioned.

- Unplug the player. After 30 minutes, plug in and power on the player -- the restore function should reset the player.

NOTES

COBY Electronics Corp.

56-65 Rust Street
Maspeth, NY 11378

www.cobyusa.com
www.ecoby.com

Free Manuals Download Website

<http://myh66.com>

<http://usermanuals.us>

<http://www.somanuals.com>

<http://www.4manuals.cc>

<http://www.manual-lib.com>

<http://www.404manual.com>

<http://www.luxmanual.com>

<http://aubethermostatmanual.com>

Golf course search by state

<http://golfingnear.com>

Email search by domain

<http://emailbydomain.com>

Auto manuals search

<http://auto.somanuals.com>

TV manuals search

<http://tv.somanuals.com>