

DXG-A85V HD

User's Manual

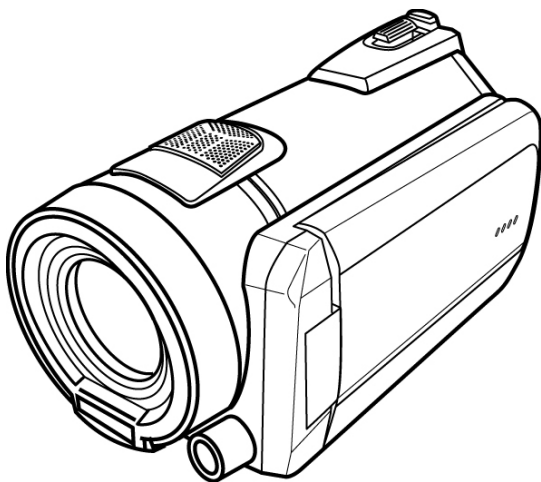

DXG USA

<i>About this manual</i>	v
<i>Copyright</i>	v
<i>Precautions</i>	vi
<i>Before You Start</i>	viii
1 Introduction	1
1.1 <i>System requirements</i>	1
1.2 <i>Features</i>	1
1.3 <i>Unpacking the camcorder</i>	2
1.4 <i>About the camcorder</i>	3
1.4.1 Front and Top view	3
1.4.2 Bottom view	3
1.4.3 Left view	4
1.4.4 Back view	4
1.4.5 Control Panel.....	5
1.4.6 Adjusting the LCD display.....	6
1.4.7 About the LEDs.....	11
2 Getting started	12
2.1 <i>Inserting an SD card</i>	12
2.2 <i>Inserting the battery</i>	13
2.3 <i>Charging the battery</i>	14
2.4 <i>Turning on/ off the camcorder</i>	14
2.5 <i>Changing modes</i>	14
2.6 <i>Before you start</i>	15
2.6.1 Setting the date and time	15

2.6.2	Setting the language	16
2.6.3	Setting the beep.....	17
2.7	<i>Shoot/Playback video</i>	18
2.7.1	Shooting a video clip	18
2.7.2	Playing the video clip.....	20
2.8	<i>Taking/viewing pictures.....</i>	21
2.8.1	Taking a still picture.....	21
2.8.2	Viewing images.....	22
2.9	<i>Connecting to a computer</i>	23
2.10	<i>Connecting to a standard TV</i>	23
2.11	<i>Connecting to a HDTV</i>	24
3	Using the camcorder	25
3.1	<i>Camcorder mode</i>	25
3.1.1	Camcorder mode	25
3.1.2	Using AF Lock.....	26
3.1.3	Using Manual Focus.....	27
3.1.4	Using the zoom function.....	28
3.1.5	Using the LED light	28
3.1.6	Using the Flash module, auto and force.....	28
3.1.7	Using the Stabilizer function.....	28
3.1.8	Quick access controls	28
3.2	<i>Camera mode.....</i>	29
3.2.1	Camera mode icons	29
3.2.2	Using AF Lock.....	30
3.2.3	Using Manual Focus.....	30

3.2.4	Using the zoom function.....	30
3.2.5	Using the LED light module.....	30
3.2.6	Using the Flash module, auto and force	31
3.2.7	Using the Stabilizer function.....	31
3.2.8	Quick access controls	31
3.3	<i>Camcorder Playback mode.....</i>	31
3.3.1	Camcorder Playback mode icons	31
3.3.2	Camera Playback mode icons	33
3.4	<i>Thumbnail mode</i>	34
4	Using the menus	35
4.1	<i>Camcorder menu.....</i>	35
4.1.1.	Video resolution.....	35
4.1.2.	Video quality	36
4.1.3.	White balance	37
4.1.4.	Color effect	38
4.1.5.	Stabilizer	39
4.1.6.	Dual Video mode.....	40
4.2	<i>Camcorder playback menu</i>	41
4.2.1	Delete.....	41
4.2.2	Protect	43
4.2.3	Autoplay	44
4.3	<i>Camera menu</i>	45
4.3.1	Resolution.....	45
4.3.2	Photo Quality	46
4.3.3	White balance	46

4.3.4	Color effect	47
4.3.5	Selftimer	48
4.3.6	Aspect Ratio.....	49
4.3.7	Face Detection	49
4.4	Camera playback menu.....	51
4.4.1	Delete.....	51
4.4.2	Protect	53
4.4.3	Autoplay	54
4.5	System menu.....	55
4.5.1	Setting the beep.....	55
4.5.2	Auto power off.....	55
4.5.3	TV standard.....	56
4.5.4	Format	57
4.5.5	Default.....	58
4.5.6	Language	58
4.5.7	Frequency	59
4.5.8	Date/time	59
	Appendix	60
	Specifications	60
	Troubleshooting	63

Preface

Congratulations on your purchase of this advanced camcorder. Make sure that you read this manual carefully and keep it in a safe place for future reference.

About this manual

Every effort has been made to ensure that the contents of this manual are correct and up to date. However, no guarantee is made regarding the accuracy of the contents. If the contents of this manual do not tally with the camera, please take the camera as a criterion. We reserve the right to change the contents of this manual and specifications of the product without prior notice.

If the accessories do not tally with the actual package, please take the actual package as the criterion.

Copyright

© Copyright 2009.

All rights reserved. No part of this publication may be reproduced, transmitted, transcribed, stored in a retrieval system or translated into any language or computer language, in any form or by any means, electronic, mechanical, magnetic, optical, manual or otherwise, without the prior written permission of the manufacturer.

Precautions

General precautions

- Do not use or store the product in dusty, dirty, or sandy areas, as its components may be damaged.
- Do not store the product in a hot environment. High temperatures can shorten the life of electronic devices, damage batteries and warp or melt certain plastics.
- Do not store the product in cold areas. When the product warms up to its normal temperature, moisture can form inside; this may damage the electronic circuits.
- Do not attempt to open the casing or attempt your own repairs. High-voltage internal components create the risk of electric shock when exposed.
- Do not drop or knock the product. Rough handling may damage the internal components.
- Do not use harsh chemicals, cleaning solvents or strong detergents to clean the product. Wipe the product with a slightly damp soft cloth.
- Do not fire the flash while it is too close to the subject's eyes. Intense light from the flash can cause eye damage if it is fired too close to the eyes. When using the flash, the camcorder should be at least one meter from the eyes of the subject.
- Do not open the battery cover while an image is being recorded. Doing so will not only make storage of the current image impossible, it can also corrupt other image data already stored in file.
- If the product or any of its accessories are not working properly, take them to your nearest qualified service center. The personnel there will assist you and if necessary, arrange for the product to be repaired.
- Test for proper operation before using the camcorder.

Notes on the LCD Screen

Caution must be observed when dealing with the fluid contained in the LCD. Ensure that fluid does not leak if the screen becomes cracked or damaged. If this occurs, follow these steps:

- If the fluid makes contact with skin, wipe it with a clean cloth then rinse with a large amount of water.
- If the fluid makes contact with eyes, wash eyes with clean water for at least 15 minutes and seek immediate medical attention.
- If the fluid is swallowed, first rinse mouth with water, then drink a large amount of water and induce vomiting. Seek immediately medical attention.

Operation conditions

- This camcorder is designed for use in temperatures ranging from 0°C to 40°C (32°F to 104°F).
- Do not use or keep the camcorder in the following areas:
 - In areas subject to direct sunlight
 - In areas subject to high humidity or dust
 - Near air conditioners, heaters, or other areas subject to temperature extremes
 - Inside of a closed vehicle, especially one parked in the sun.
 - In areas subject to strong vibration

Power supply

- Use only the type of battery that came with your camcorder. Using any other type of battery may damage the equipment and invalidate the warranty.
- Ensure the battery is inserted correctly. Inserting the battery incorrectly can cause damage to the product and possibly start a fire.

- Remove the battery to avoid the fluid leakage if the camcorder is not going to be used for a long time.
- If the battery is crushed or damaged, remove it immediately to avoid the battery fluid leakage and abnormal expansion.

Before You Start

Take some test shots before performing a formal recording.

Before taking pictures with this camcorder in any important occasion (such as a wedding ceremony or an overseas trip), do test the camcorder beforehand to ensure that it functions properly. Any additional loss caused by the malfunction of this product (such as costs of photography or any loss of benefit generated by the photography) is not the responsibility of the manufacturer and no compensation will be given for it.

Copyright information

Take care to observe "No Photography" notices in certain locations. In these cases, you cannot record any live performance, improvisation or exhibits, even for personal purposes. Any transfer of pictures or memory card data must be conducted under the constraints of copyright law.

1 Introduction

Read this section to learn about the features and functions of the camcorder. This chapter also covers system requirements, package contents, and description of the hardware components.

1.1 System requirements

The camcorder requires a PC with the following specifications:

- Operating System : Windows XP SP2 32/64bit, Vista 32/64bit and Windows7 32/64bit
- CPU: Intel/AMD Dual-Core or above
- Memory: At least 1GB or above
- Graphic Card: DirectX 9 is must, DirectX 10 is recommendation
- Interface: Standard USB 1.1 Port or Higher
- Hard Disk: At least 2GB of Available Disk Space

● **Note:**

A USB 1.1 port may enable you to transfer files to and from your host PC, but transfer speeds may be much faster with a USB 2.0 port.

1.2 Features

The camcorder offers a variety of features and functions including:

- Full HD 1080p (30fps.)
- 3.0 TFT LCD Touch Display (16:9)
- 12X Optical Zoom, 10X Digital Zoom
- Li-ion Battery NP120
- Excellent AE performance by continuous IRIS
- Supports Dual-Video Capture
- Supports Face Detection

- Support Auto Focus (AF) Lock function
- Support Manual Focus (MF) function

1.3 Unpacking the camcorder

The following items should be present in the package. If any item is missing or appears damaged, contact your dealer immediately.



Camcorder



Pouch



User manual



USB cable



**DC-in adapter
(optional)**



Battery charger



Power cord



AV cable



**HDMI cable
(optional)**



**Remote control
(optional)**

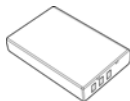

**Li-ion battery
NP-120**



**CD-ROM
(Application software)**

1.4 About the camcorder

Refer to the following illustrations to familiarize yourself with the buttons and controls of this camcorder.

1.4.1 Front and Top view

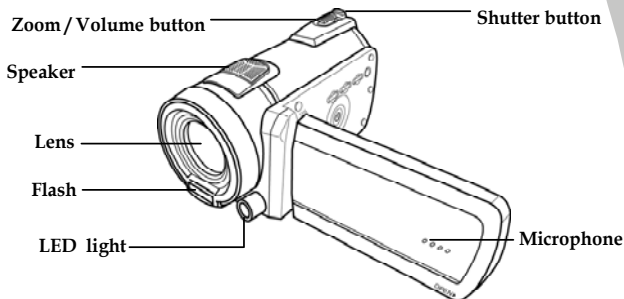

1.4.2 Bottom view

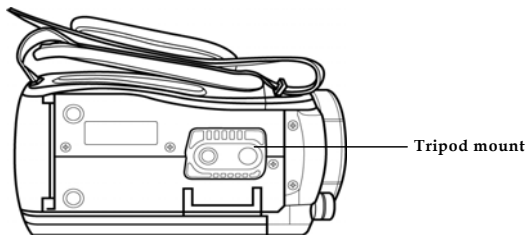

1.4.3 Left view

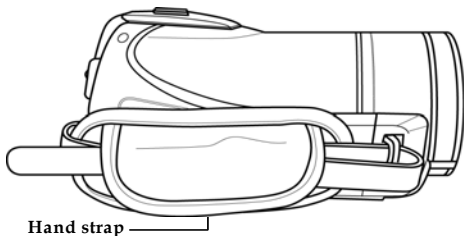

1.4.4 Back view

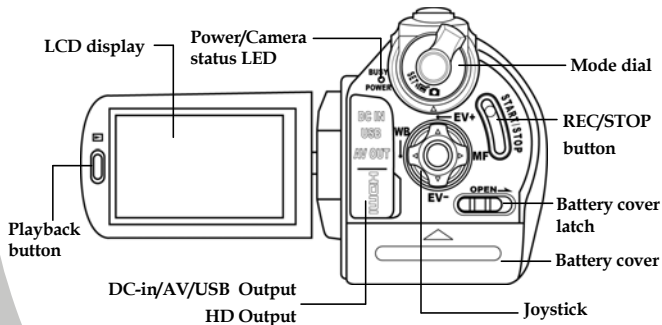

1.4.5 Control Panel

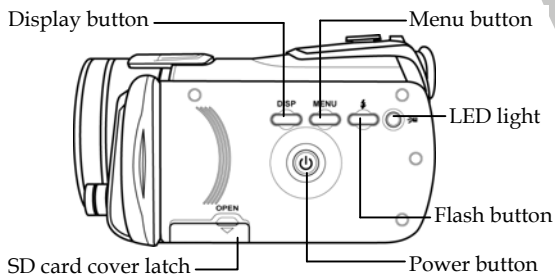





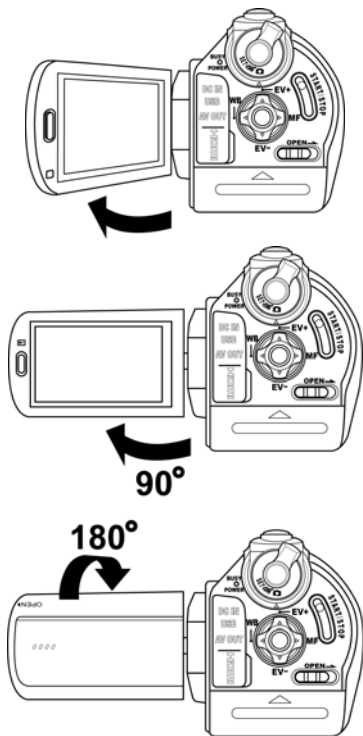

1.4.6 Adjusting the LCD display

Flip and twist the LCD screen as shown while capturing a still image or recording a video clip.



See the table below for a description of each button's function.

Button	Name	Function
	Power button	Press to turn power on/off.
	Menu button	Press to display main OSD menus.
	Mode dial	Use to turn Camcorder , Camera , and SET modes.
	Joystick	<ul style="list-style-type: none"> ● In Camcorder and Camera mode: <ol style="list-style-type: none"> 1. Move up/ down to adjust the exposure settings. 2. Move right to enable the MF function. The MF icon  appears on the LCD screen when enabled. 3. Press the joystick to enable AF Lock. The AF Lock icon  appears on the screen. 4. Move left to adjust the white balance settings. ● In Camera Playback mode: <ol style="list-style-type: none"> 1. Move right and left to view the stored images. 2. When the image is zoomed in,







direction keys appear on the LCD screen. You may press the joystick to move the image.
(up/down ↔ left/right).

3. Move the joystick up to enter the Thumbnail mode.
4. In the **Thumbnail** mode, move up, down, left, right to select the thumbnail images and then press the center joystick button to view the image in full screen mode.

● In **Camcorder Playback** mode:

1. Press right and left to view the stored video clips and press the center joystick button to play/stop the video clips.
2. In **Playing** mode, move right to fast-forward a video clip and move left to rewind a video clip.
3. Move the joystick up to enter the Thumbnail mode.
4. In the **Thumbnail** mode, move up, down, left, right to select a desired video clip and then press the center joystick button to show the video clip.

- In **SET** mode, press left and right to highlight menu items and press the center joystick button to confirm.

	Shutter button	<ul style="list-style-type: none"> ● In Camera mode, press to take a photo. ● In Camcorder mode, you can also press to take a photo before and during recording a video clip.
	REC/Stop button	<ul style="list-style-type: none"> ● In Camcorder mode, press to start recording a video clip.
	Playback button	In Camcorder and Camera mode, press to enter playback mode.
	Display button	Press once to turn off all OSD icons and press again to display all OSD icons off.
	Zoom button	<ul style="list-style-type: none"> ● In Camcorder and Camera modes, press right/ left to zoom in and out. ● In Camera Playback mode, press right to zoom in your photo. ● In Camcorder Playback mode, press right/left to increase or decrease the volume of the video clip you are playing.
	LED light button	<ul style="list-style-type: none"> ● In Camcorder and Camera modes, press the button to turn on/ off the increase light.



Flash
button

- In **Camera** modes, press the button to switch between the flash modes.



Battery
cover latch

- Slide the latch to open the battery card cover when you insert/remove the battery.

1.4.7 About the LEDs

The following table describes the camcorder LEDs:

LED	Color	Definition
Power / Rec/ Camcorder Status	Green	Power-on
	Green/ Red Blinking	Recording
	Red	Camcorder busy
Self-timer	Red Blinking	Self-timer is activated.
	Red Blinking Rapidly	2 seconds self-timer remaining.

2 Getting started

Read this section to learn how to start using the camcorder. This section covers basic functions such as switching on, inserting the battery and memory cards, and configuring preliminary settings. See later chapters for advanced functions.

2.1 Inserting an SD card (SD card sold separately)

An SD card can be installed in the camcorder to provide additional storage space for still images, video clips, or other files.

1. Open the LCD screen cover and open the SD card compartment cover.



2. Insert an SD card, making sure the contacts are facing downwards.



3. Close the SD card compartment cover.

2.2 Inserting the battery

This camcorder is designed to use a rechargeable Li-ion battery. Only use the batteries supplied or similar batteries recommended by the manufacturer or your dealer.

● **Note:**

Install the battery exactly as described here. Installing the battery incorrectly could cause damage to the camcorder and possibly start a fire.

1. Slide the battery cover latch as shown, the battery cover opens automatically.

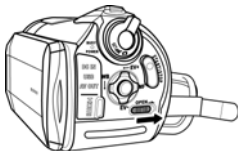

2. Insert the battery as shown.

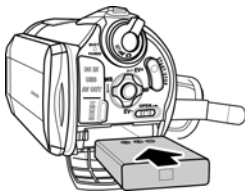

3. Close the battery cover.

2.3 Charging the battery

You can charge the battery with the charging unit provided. Follow the steps below to charge your battery.

1. Insert the Li-ion battery into the charging bay. Connect one end of the power cord to the charging unit and then plug the other end to the wall outlet as shown.
2. The red LED will light up for proper charging.
3. After full charge, the LED turns to green.
4. It takes about 290 minutes to achieve full charge. Actual charging time depends on current battery capacity and charging conditions.

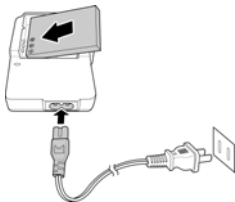

2.4 Turning on/ off the camcorder

Press and hold the power button to turn the camcorder on/off.

2.5 Changing modes

The camcorder can operate in three modes, **Camcorder**, **Camera**, and **SET**. Move the mode dial to toggle different modes.



2.6 Before you start

Before you start using the camcorder, some basic settings such as date and time, languages and beep function need to be configured.

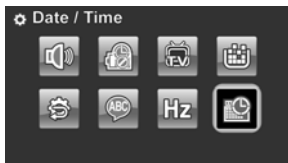

2.6.1 Setting the date and time

1. Turn on the camcorder, and move the mode dial to **SET**. Move the joystick left and right or tap the screen to highlight **Date / Time**. Press the center joystick button to confirm.

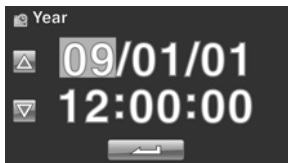

2. Move the joystick left and right or tap the screen to highlight each field.





3. Adjust each value by moving the joystick up, down, or tap the  /  . Press the center joystick button or tap  to save your changes and leave the **Date/Time** menu.
4. Press the **Enter** button to exit the menu.

2.6.2 Setting the language

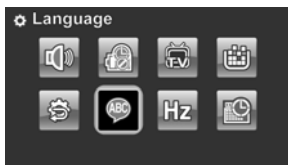
1. Turn on the camcorder, and move the mode dial to **SET**. Move the joystick left and right or tap the screen to highlight **Language**. Press the center joystick button to enter the **Language** menu.



2. Move the joystick left and right or tap the screen to select the following languages: English, Japanese, French, Italian, Spanish, Portuguese, Dutch, Simplified Chinese, Traditional Chinese, Korean, Turkish, German, Russian, and Arabic. Move the joystick up and down or tap  /  to go to the previous/next page. After the language is selected, press the center joystick button or tap  to confirm.



3. Press the **Enter** button to exit the menu.

2.6.3 Setting the beep

1. Turn on the camcorder, and move the mode dial to **SET**. Move the joystick left and right or tap the screen to highlight **Beep**. Press the center joystick button to enter the **Beep** menu.

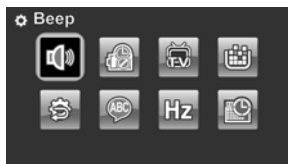

2. Move the joystick left and right to select **Beep Off** or **Beep On** options. Press the center joystick button to confirm.

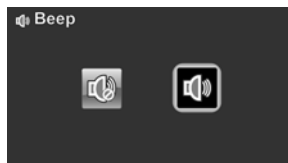

Notes:

Remove the LCD protective film to increase the sensitivity of the touch panel.

2.7 Shoot/Playback video

2.7.1 Shooting a video clip

1. Turn on the camcorder and move the mode dial to **Camcorder mode**.

Camcorder mode





2. Use the LCD screen to frame the video.
3. Press the **REC/STOP** button to start recording.
4. Press the **REC/STOP** button again to stop recording.
5. The video clip is automatically saved with a unique file name.

Notes:

1. The maximum length of each video recording file is approximately 3.75 GB.
2. The high-resolution settings result in larger files, and therefore shorter length.

3. The LCD preview and the ratio of a still-image capture can vary depending on the different video resolution settings. See the following table:

Video resolution	Preview	Taking pictures and focusing
WQVGA	16:9 ratio	4:3 ratio
WVGA		
720P		
1080P		













4. Before shooting a video clip, you can still take a photo in **Camcorder** mode.

2.7.2 Playing the video clip

1. In **Camcorder** mode, press the **Playback** button. The most recent file displays on the LCD screen.

Camcorder playback mode indicator



2. Move the joystick right and left to or tap  /  to select a desired video clip and press the center joystick button or . The video clip starts playing.
3. Move the joystick left or tap  to rewind the video clip and move the joystick right or tap  to fast forward 2x, 4x, and 8x.
4. Press the **REC/ STOP** button or tap  to pause the video playback. Press the **REC/ STOP** button again or tap  to resume the video playback.
5. When viewing the video clip, move the **Zoom** button left or right to adjust the volume.
6. Press the center joystick button or tap  to stop playing. Tap  to view the video clip in 1/2 x slow playback. Tap  twice to toggle between 1/2x and 2x speeds. Tap  then tap  to toggle among 1/4, 1/8 & 1/16 speeds.
7. Press the **Playback** button again to return to **Camcorder** mode.

8. During playback, press the zoom button left or right to adjust volume.

2.8 Taking/viewing pictures

2.8.1 Taking a still picture

1. Turn on the camcorder and move the **Mode Dial** to **Camera** mode.







2. Use the LCD screen to frame the picture.
3. Press the **Shutter** button to capture the image.
4. The picture is automatically saved with a unique file name.

2.8.2 Viewing images

1. In **Camera** mode, press the **Playback** button. The most recent image displays on the LCD screen.

Camera
Playback mode



2. Press the joystick right and left or tap  /  to scroll through the images.
3. Move the **Zoom** button right to zoom in the picture. There are four direction keys appears on the LCD screen. You may use the joystick to pan across the picture.
4. Move the joystick up fully or tap  to view the thumbnails of all stored images.
5. Move the joystick left and right to select an image. Move the joystick up and down or tap  /  to go to the previous/next page
6. Press the **Playback** button again to return to **Camera** mode.

2.9 Connecting to a computer

Read this section to learn how to transfer files to a PC, show the video clips or photos on a TV.

Connect the camcorder to a computer with the USB cable provided.



2.10 Connecting to a standard TV

Connect the camcorder to a standard TV as shown with the AV cable provided.

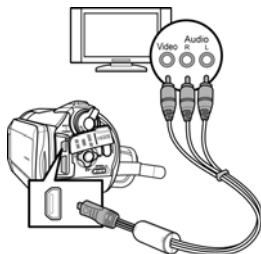

2.11 Connecting to a HDTV

Read this section to learn how to show the video clips or photos on a HDTV. Connecting to a HDTV offers the high resolution for displaying the video clips or photos.

Connect the camcorder to a HD TV as shown with the HDMI cable provided.

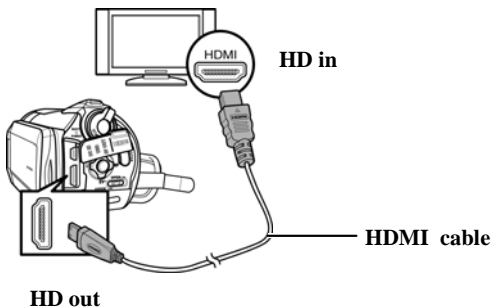

Notes:

When connected to an HDTV, dual video output is supported. You can view videos on the TV and operate the LCD panel at the same time.

3 Using the camcorder

Read this section to learn how to use the camcorder.

3.1 Camcorder mode

Use this mode to capture video clips or record voice and store them on an SD card.

3.1.1 Camcorder mode



Use the following picture to familiarize yourself with the **Camcorder** mode icons and symbols.

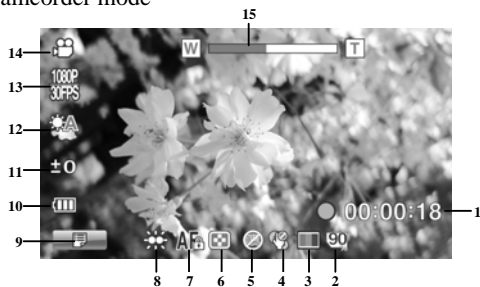











Camcorder mode



Camcorder mode:

See the table below for a description of each icon and symbol.

1		Recording time elapsed
2		Memory status indicator  : SD card in

3		Stabilizer indicator
4		Dual video indicator
5		Color effect indicator
6		Quality indicator
7		Auto Focus (AF) lock or Manual Focus (MF) indicator
8		LED light indicator
9		Menu indicator. Tap to enter the video menu.
10		Battery indicator
11		EV compensation indicator
12		White balance indicator
13		Video resolution indicator
14		Camcorder mode indicator
15		Zoom indicator

3.1.2 Using AF Lock

The **Auto Focus (AF) Lock** function is used to lock focus on a desired image.

1. Press the **OK** button to enable AF Lock. The AF Lock icon appears on screen.



2. Aim the camera on your desired subject.
3. Press the REC button to record video or the shutter button to capture image.



3.1.3 Using Manual Focus

The **Manual Focus (MF)** function is used to manually set the focus.

1. Press right repeatedly until **MF** is displayed on screen.



2. Aim the camera on your desired subject.
3. Move the zoom buttons left or right to manually adjust focus.

- **Note:** To zoom in or out the image, tap the  icon on the screen. The  icon is displayed, move the zoom buttons left or right. To toggle back to MF mode, tap the  icon again.

4. Press the REC button to record video or the shutter button to capture image.

3.1.4 Using the zoom function

The camcorder is equipped with 5x optical zoom and 10X digital zoom.

Move the **Zoom** button **right** to get closer to a subject.

Move the **Zoom** button **left** to move away from a subject.



3.1.5 Using the LED light

Use the LED light to illuminate subjects in dark environments.

Press the **LED Light** button to switch on the flash light and press again to switch it off.

3.1.6 Using the Flash module, auto and force

Use the auto and force flash module to illuminate subjects in dark environments when press the shutter button.

You may switch the auto and force flash module by toggling the **Flash button**. The  or  displays on your camcorder when activated.

3.1.7 Using the Stabilizer function

Use the Stabilizer function to reduce vibration caused by camcorder shanks during a video shoot.

See section 4.1.5 "Stabilizer".

3.1.8 Quick access controls

You can also make adjustments to exposure by pressing the joystick up and down.

In **Camcorder** and **Camera** modes, press the joystick up and down to adjust the EV compensation settings. Press the joystick left to choose white balance settings.

3.2 Camera mode

Use **Camera** mode to capture still pictures and store them in the on an SD card.

3.2.1 Camera mode icons





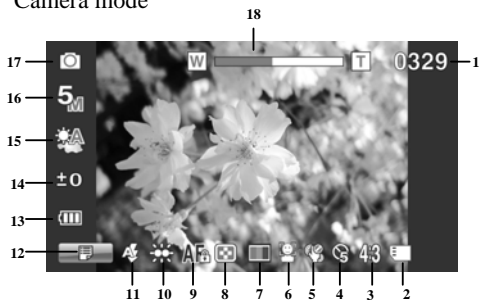







Use the following picture to familiarize yourself with the **Camera** mode icons and symbols.

Camera mode



See the table below for a description of each icon and symbol.

1	0329	Remaining number of photos
2		Memory status indicator SD card in
3	4:3	Aspect ratio indicator
4		Self-timer indicator
5		Stabilizer indicator

6		Face tracking indicator
7		Color effect indicator
8		Quality indicator
9		Auto Focus (AF) lock or Manual Focus (MF) indicator
10		LED light indicator
11		Flash indicator
12		Menu indicator. Tap to enter the camera menu.
13		Battery indicator
14		EV compensation indicator
15		White balance indicator
16		Video resolution indicator
17		Camera mode indicator
18		Zoom indicator

3.2.2 Using AF Lock

See section 3.1.2 "Using AF Lock".

3.2.3 Using Manual Focus

See section 3.1.3 "Using Manual Focus".

3.2.4 Using the zoom function

See section 3.1.4 "Using the zoom function".

3.2.5 Using the LED light module

See section 3.1.5 “Using the LED light”.

3.2.6 Using the Flash module, auto and force

See section 3.1.6 “Using the Flash module, auto and force”.

3.2.7 Using the Stabilizer function

See section 3.1.7 “Using the Stabilizer function”.

3.2.8 Quick access controls

See section 3.1.8 “Quick access controls”.

3.3 Camcorder Playback mode

Use **Camcorder Playback** mode to review all the movie files stored on the SD card.

3.3.1 Camcorder Playback mode icons





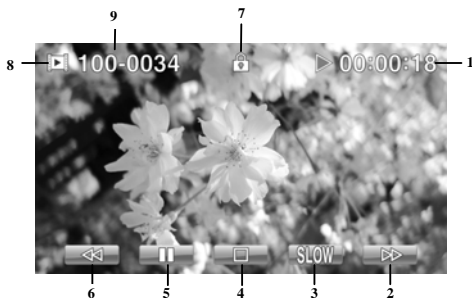



Refer to the following picture to familiarize yourself with the **Camcorder Playback** mode icons and symbols.

Camcorder playback mode



Camcorder mode:

See the table below for a description of each icon and symbol.

1		Displays the elapsed time while playing the video clip
2		Fast forward icon. Tap to fast forward the video clip
3		Slow motion icon. Tap to play the video in slow motion
4		Stop icon. Tap to stop the video.
5		Pause icon. Tap to pause the video.
6		Rewind icon. Tap to rewind the video.
7		File protect indicator
8		Camcorder playback mode icon
9		Displays the file number of the video clip

Camera Playback mode

Use **Camera Playback** mode to review all the image files stored in the camcorder.

3.3.2 Camera Playback mode icons

Refer to the following picture to familiarize yourself with the **Camera Playback** mode icons and symbols.



See the table below for a description of each icon and symbol.



1		Next icon. Tap to go to the next image.
2		Thumbnail icon. Tap to display images in thumbnail.
3		Menu icon. Tap to display the playback menu.
4		Back icon. Tap to return to the previous image.
5		Camera playback mode icon.
6	100-0033	File number indicator
7		File protect indicator

3.4 Thumbnail mode

When in **Camera Playback** or **Camcorder Playback** modes, move the joystick up or tap  to show images as thumbnails.

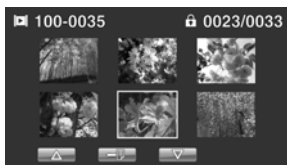
1. Turn on the camcorder and make sure it is in **Camera Playback** or **Camcorder Playback** mode.
2. The most recent image / video clip displays on the screen. Move the joystick up or tap  to view **six** thumbnail images / video clips on the LCD screen.



3. Move the joystick left and right or tap the screen highlight an image or a video clip. Move the joystick up and down or tap  /  to go to the previous/next page.
4. Press the center joystick button or tap the screen to view the image or playback the video clip in full screen mode.
5. Move the joystick up or tap  to return to thumbnail view.

4 Using the menus

Read this section to learn how to configure the camcorder settings and use the advanced features.

4.1 Camcorder menu

When in **Camcorder** mode, press the **Menu** button or tap  to show the camcorder options menu.

4.1.1. Video resolution

Use the resolution option to determine the resolution of the captured video. The larger screen size requires more memory storage space.

1. Turn the camcorder on and ensure it is in **Camcorder** mode.
2. Press the **Menu** button or tap  to enter the **Camcorder** menu.
3. Move the joystick left and right or tap the screen to highlight the **Resolution** option. Press the center joystick button to display the submenu.
4. Press the joystick left and right to select **1080i/60FPS**, **1080P/30FPS**, **720P/60FPS**, **720P/30FPS**, **WVGA/60FPS**, **WVGA/30FPS**, or **WQVGA/240FPS**. Press the center joystick button to confirm and exit the submenu.

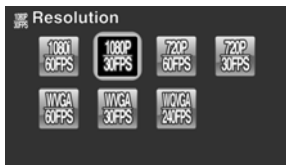

5. Press the **Enter** button to exit the menu.

● **Note:**

In 1080P mode, you can capture a photo when the video is recording. The still image resolution is 2560*1440.

4.1.2. Video quality

There are two different levels of video quality setting. Higher quality video needs more memory storage space.

1. Turn the camcorder on and ensure it is in **Camcorder** mode.
2. Press the **Menu** button or tap  to enter the **Camcorder** menu.
3. Move the joystick left and right or tap the screen to highlight the **Quality** option. Press the center joystick button to display the submenu.
4. Press the joystick left and right or tap the screen to select the desired option. Press the center joystick button to confirm and exit the submenu.

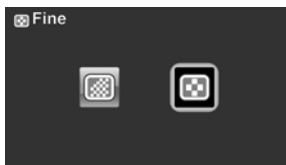

5. Press the **Enter** button to exit the menu.

4.1.3. White balance

Use this option to correct color difference for different lighting conditions. When white balance is set to **Auto**, the camcorder automatically compensates for different lighting conditions.

1. Turn the camcorder on and ensure it is in **Camcorder** mode.
2. Press the **Menu** button or tap  to enter the **Camcorder** menu
3. Move the joystick left and right or tap the screen to highlight the **White Balance** menu. Press the center joystick button to display the submenu.
4. Move the joystick left and right or tap to select **Auto**, **Sunny**, **Cloudy**, **Tungsten**, or **Fluorescent**. Press the center joystick button to confirm and exit the submenu.

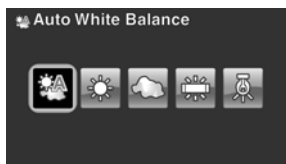
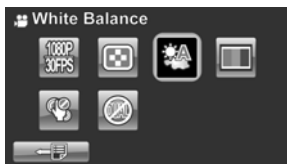

5. Press the **Enter** button to exit the menu.

4.1.4. Color effect

The camcorder can capture standard color images, black and white images, or sepia tone to give an old-fashioned look.

1. Turn the camcorder on and ensure it is in **Camcorder** mode.
2. Press the **Menu** button or tap  to enter the **Camcorder** menu
3. Move the joystick left and right or tap the screen to highlight the **Effect** menu. Press the center joystick button to display the submenu.
4. Move the joystick left and right or tap to select **Natural**, **B&W**, or **Sepia**. Press the center joystick button to confirm and exit the submenu.

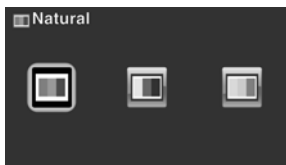



5. Press the **Enter** button to exit the menu.

4.1.5. Stabilizer

Use this function to reduce vibration caused by camcorder shakes during a video shoot.

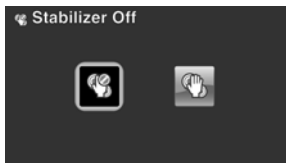
1. Turn the camcorder on and ensure it is in **Camcorder** mode.
2. Press the **Menu** button or tap  to enter the **Camcorder** menu
3. Move the joystick left and right or tap the screen to highlight the **Stabilizer** menu. Press the center joystick button to display the submenu.
4. Move the joystick left and right or tap to select **Off** or **Stabilizer** options. Press the center joystick button to confirm and exit the submenu.



5. Press the **Enter** button to exit the menu.
6. An icon  displays on the screen.

4.1.6. Dual Video mode

Use this function to record two deferent resolution video clips at same time.

1. Turn the camcorder on and ensure it is in **Camcorder** mode.
2. Press the **Menu** button or tap  to enter the **Camcorder** menu
3. Move the joystick left and right or tap the screen to highlight the **Dual Video** menu. Press the center joystick button to display the submenu.
4. Move the joystick left and right or tap to select **Off**, **1080P/WQVGA**, or **720P/WQVGA** . Press the center joystick button to confirm and exit the submenu.

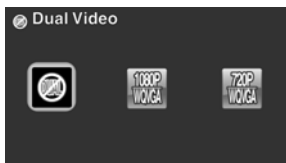
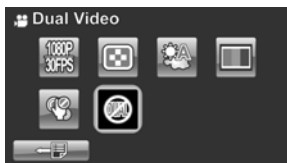

5. Press the **Enter** button to exit the menu.

- **Note:**
Select to capture two simultaneous video files. Use 1080P(30fps) or WQVGA(30fps) to easily upload videos to YouTube or Facebook.

- **Note:**
When this dual video function is enabled, the still image resolution for 720 mode is 1280x720 and 1080 mode is 1920x1080.



4.2 Camcorder playback menu

Use the playback menu to manage the files stored on the SD card.

4.2.1 Delete

Use this function to delete files.

1. Turn the camcorder on and ensure it is in **Camcorder** mode. Press the **Playback** button and then press the **Menu** button or tap  to display the **Camcorder Playback** menu.
2. Move the joystick left and right or tap the screen to select **Delete One** or **Delete All** options.

If you select **Delete One**, the playback screen appears again. Move the joystick right and left or tap  /  to locate the file you want to delete and press the center joystick button to confirm.



If you select **Delete All**, a prompt appears on screen for confirmation. Move the joystick left and right or tap the screen to select the desired option. Press the center joystick button to confirm. All files stored in memory will be deleted.







3. Press the **Menu** button or tap  to exit the menu.

● **Note:**

Once deleted, files cannot be recovered so make sure you have a backup before you delete. Files that have been protected will not be deleted. You have to unlock the files first before deleting them.

4.2.2 Protect

Use this function to lock files to prevent accidental deletion.

1. Turn the camcorder on and ensure it is in **Camcorder** mode. Press the **Playback** button and then press the **Menu** button or tap  to display **Camcorder Playback** menu.
2. Move the joystick left and right or tap the screen to select **Protect** menu. Press the center joystick button to display the submenu.
3. Then playback screen appears again. Move the joystick or tap  to locate the file you want to protect. Press the center joystick button or tap  to protect or unprotect the file. A lock  icon is displayed to show that the file is protected.



4. Press the **Menu** button again or tap  to exit the menu.

● **Note:**

To unlock a file, repeat the above steps. The  lock icon disappears when the file is unlocked.

4.2.3 Autoplay

This camcorder includes an **Autoplay** function, which plays each video clip in turn.

1. Turn the camcorder on and ensure it is in **Camcorder** mode. Press the **Playback** button and then press the **Menu** button or tap  to display **Camcorder Playback** menu.
2. Move the joystick left and right or tap the screen to select **Autoplay** menu. Press the center joystick button to display the submenu.
3. Move the joystick right and left or tap the screen to select the desired options. Press the center joystick button to confirm.



4. Press the **Menu** button again or tap  to exit the menu.

4.3 Camera menu

In **Camera** mode, press the **Menu** button to show the **Camera Options** menu.

4.3.1 Resolution

Use this option to set the size of the captured image. Larger images contain more detail and therefore use more memory space.

1. Turn the camcorder on and ensure it is in **Camera** mode.
2. Press the **Menu** button or tap  to enter the **Camera** menu
3. Move the joystick left and right or tap the screen to highlight the **Resolution** menu. Press the center joystick button to display the submenu.
4. Move the joystick left and right to select from **12M**, **10M**, **5M**, **2M**, **10M burst** or **2M burst**. Press the center joystick button to confirm.



5. Press the **Enter** button to exit the menu.

4.3.2 Photo Quality

There are two different levels of video quality setting. Higher quality video needs more memory storage space.

1. Turn the camcorder on and ensure it is in **Camera** mode.
2. Press the **Menu** button or tap  to enter the **Camera** menu.
3. Move the joystick left and right or tap the screen to highlight the **Quality** option. Press the center joystick button to display the submenu.
4. Press the joystick left and right or tap the screen to select the desired option. Press the center joystick button to confirm and exit the submenu.

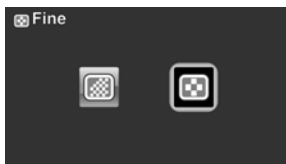

5. Press the **Enter** button to exit the menu.

4.3.3 White balance

Use this option to correct color difference due to lighting conditions.

1. Turn the camcorder on and ensure it is in **Camera** mode.
2. Press the **Menu** button or tap  to enter the **Camera** menu.

3. Move the joystick left and right or tap the screen to highlight the **White Balance** option. Press the center joystick button to display the submenu.
4. Move the joystick left and right to select **Auto**, **Sunny**, **Cloudy**, **Tungsten**, or **Fluorescent**. Press the center joystick button to confirm.

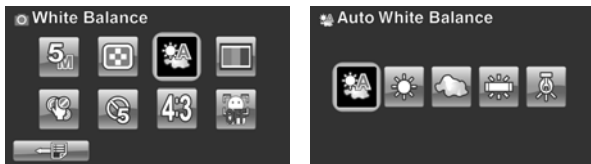

5. Press the **Enter** button to exit the menu.

4.3.4 Color effect

The camcorder can capture standard color images, black and white images, or sepia tone to give an old-fashioned look.

1. Turn the camcorder on and ensure it is in **Camera** mode.
2. Press the **Menu** button or tap  to enter the **Camera** menu.
3. Move the joystick left and right or tap the screen to highlight the **Effect** menu. Press the center joystick button to display the submenu.
4. Move the joystick left and right or tap to select **Natural**, **B&W**, or **Sepia**. Press the center joystick button to confirm and exit the submenu.

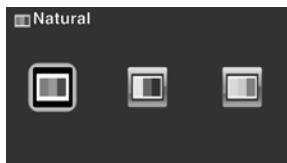

5. Press the **Enter** button to exit the menu.

4.3.5 Self-timer

Use the self timer function to take a photo of yourself.

1. Turn the camcorder on and ensure it is in **Camera** mode.
2. Press the **Menu** button or tap  to enter the **Camera** menu.
3. Move the joystick left and right or tap the screen to highlight the **Self-timer** menu. Press the center joystick button to display the submenu.
4. Move the joystick left and right or tap to select **Off**, **5 seconds**, or **10 seconds** options. Press the center joystick button to confirm.

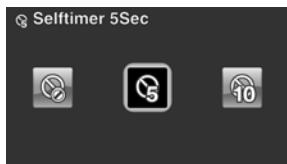
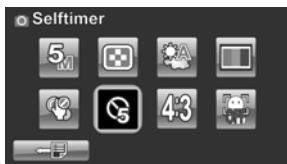

5. Press the **Enter** button to exit the menu.

4.3.6 Aspect Ratio

Use the aspect ratio function to adjust the aspect ratio of the display.

1. Turn the camcorder on and ensure it is in **Camera** mode.
2. Press the **Menu** button or tap  to enter the **Camera** menu.
3. Move the joystick left and right or tap the screen to highlight the **Aspect Ratio** menu. Press the center joystick button to display the submenu.
4. Move the joystick left and right or tap to select **4:3**, **16:9**, or **3:2** options. Press the center joystick button to confirm.

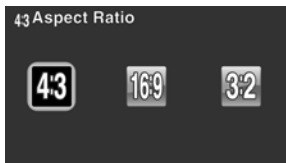

5. Press the **Enter** button to exit the menu.

4.3.7 Face Detection

Use the face detection function to detect faces to capture photo.

1. Turn the camcorder on and ensure it is in **Camera** mode.
2. Press the **Menu** button or tap  to enter the **Camera** menu.
3. Move the joystick left and right or tap the screen to highlight the **Face Detection** menu. Press the center joystick button to display the submenu.

4. Move the joystick left and right or tap to select **on** or **off**. Press the center joystick button to confirm.

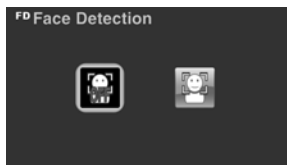
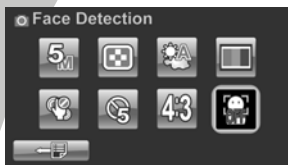





5. Press the **Enter** button to exit the menu.

4.4 Camera playback menu

4.4.1 Delete

Use this function to delete files.

1. Turn the camcorder on and ensure it is in **Camera** mode. Press the **Playback** button and then press the **Menu** button or tap  to display the **Camera Playback** menu.
2. Move the joystick left and right or tap the screen to select **Delete One** or **Delete All** options.

If you select **Delete One**, the playback screen appears again. Move the joystick right and left or tap  /  to locate the file you want to delete and press the center joystick button or tap  to confirm.



If you select **Delete All**, a prompt appears on screen for confirmation. Move the joystick left and right or tap the screen to select the desired option. Press the center joystick button to confirm. All files stored in memory will be deleted.







3. Press the **Menu** button or tap  to exit the menu.

● **Note:**

Once deleted, files cannot be recovered so make sure you have a backup before you delete. Files that have been protected will not be deleted. You have to unlock the files first before deleting them.

4.4.2 Protect

Use this function to lock files to prevent accidental deletion.

1. Turn the camcorder on and ensure it is in **Camera** mode. Press the **Playback** button and then press the **Menu** button or tap  to display **Camera Playback** menu.
2. Move the joystick left and right or tap the screen to select **Protect** menu. Press the center joystick button to display the submenu.
3. Then playback screen appears again. Move the joystick or tap  to locate the file you want to protect. Press the center joystick button or tap  to protect or unprotect the file. A lock  icon is displayed to show that the file is protected.



4. Press the **Menu** button again or tap  to exit the menu.

● **Note:**

To unlock a file, repeat the above steps. The  lock icon disappears when the file is unlocked.

4.4.3 Autoplay

The camcorder includes a slide show function, which displays each image in turn with a regular interval between pictures.

1. Turn the camcorder on and ensure it is in **Camera** mode. Press the **Playback** button and then press the **Menu** button or tap  to display **Camera Playback** menu.
2. Move the joystick left and right or tap the screen to select Autoplay menu. Press the center joystick button to display the submenu.
3. Move the joystick right and left or tap the screen to select the desired options. Press the center joystick button to confirm. The images are displayed automatically.



4. Press the **Menu** button again or tap  to exit the menu.

4.5 System menu

The system menu is used to configure miscellaneous camcorder functions.

4.5.1 Setting the beep

See section 2.6.3 "Setting the Beep".

4.5.2 Auto power off

Use this function to switch the camcorder off automatically after a period of inactivity for power saving.

1. Turn on the camcorder and switch to **SET** mode.
2. Move the joystick left and right or tap highlight the **Auto Power Off** option. Press the center joystick button to display the submenu.
3. Move the joystick left and right or tap to select **Off**, **5 minute**, or **10 minutes**. Press the center joystick button to confirm.

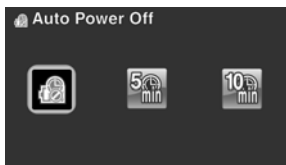

4.5.3 TV standard

Use the TV option to set the TV system for the area.

1. Turn on the camcorder and switch to **SET** mode.
2. Move the joystick left and right or tap to highlight the **TV standard** option. Press the center joystick button to display the submenu.
3. Move the joystick left and right or tap to select **NTSC** or **PAL**, and press the center joystick button to confirm.

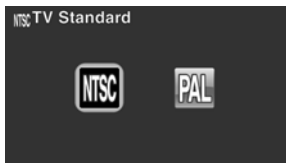
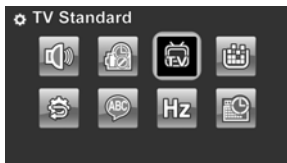

4.5.4 Format

Use this function to format the current storage media. This format action will delete everything on the media.

1. Turn on the camcorder and switch to **SET** mode.
2. Move the joystick left and right or tap to highlight the **Format** option. Press the center joystick button to display the submenu.
3. Move the joystick left and right or tap to select X or ✓, and press the center joystick button to confirm.

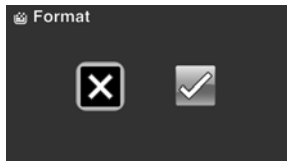
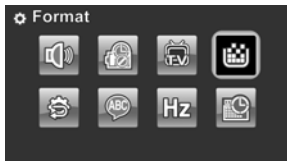

4. The current media (memory card) is formatted.

4.5.5 Default

Use this option to reset all settings to the default settings.

1. Turn on the camcorder and switch to **SET** mode.
2. Move the joystick left and right highlight the **Default** option. Press the center joystick button to display the submenu.
3. Move the joystick left and right to select X or \checkmark , and press the center joystick button to confirm.



4.5.6 Language

See section 2.6.2 "Setting the language".

4.5.7 Frequency

Use the Frequency option to set the frequency system for your area.

To set the frequency:

1. Turn on the camcorder and switch to **SET** mode.
2. Move the joystick left and right to highlight the **Frequency** option. Press the center joystick button to display the submenu.
3. Move the joystick left and right to select **50 Hz** or **60 Hz**. Press the center joystick button to confirm.

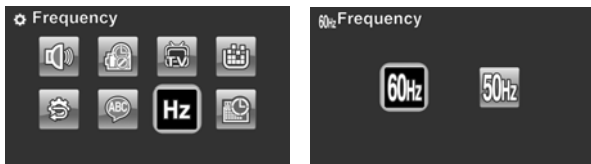

4.5.8 Date/time

See section 2.6.1 "Setting the date and time".

Appendix

Specifications

General	
Imaging sensor	1/2.3" CMOS 10.0 Megapixel sensor
Active pixels	10.0 Megapixel
Storage media	Internal: Built-in 128MB Flash Memory External: SD Card (Up to SDHC 16GB Class6)
Sensor sensitivity	Auto
Color effects	Natural/B&W/Sepia
Lens	12X Optical zoom lens Wide: F1.85, f=6.3mm Tele: F3.1, f=75.6mm (36-428mm equivalent to 35mm) 9G13E with ND filter
Focus range	Normal: 10cm ~ inf. (Wide) 90cm ~inf. (Tele) Macro: 10cm ~ 90cm

General

Still image	Formats: JPEG (EXIF2.2), DCF Resolution: 2M, 5M, 10M, 12M, 20M (Firmware interpolation) Continuous Shots: 10M, Max. 7 photos/sec; 2M, Max. 30 photos/sec.
Movie clips	Format: H.264 (MOV) Resolution: WQVGA (240fps), WVGA (30fps), WVGA (60fps), 720p (30fps), 720p (60fps), 1080p (30fps)
Zoom	Movie: 12X Optical Zoom, 10X Digital Zoom Camera: 12X Optical zoom, 10X Digital zoom Playback: Still Image (8X)
TFT Monitor	3.0" TFT (960 x 240 pixels) (16:9)
LED light (Video)	Effective Range: 0.5m ~ 1m Mode: On / Off
Strobe (Camera)	Mode: Auto / Forced / Off
White balance	Auto/Sunny/Cloudy/Tungsten/ Fluorescent

General

EV compensation	-2.0 EV~+2.0 EV
Self-timer	Off, 5, 10 seconds
PC interface	MSDC: USB 2.0 (high speed)
TV out format	NTSC/PAL/ HDMI
Shutter	Still: 1/2-1/2000 Video: 1/30-1/4000
Auto power off	Off, 5 min., 10 min
Power supply	Li-Ion battery NP-120 battery/DC-in via USB
Dimension	67 (W) x 71.6 (H) x 128.7 (D) mm
Weight	Approx. 328+-5g (without batteries)

Troubleshooting

Problem	Possible Cause	Solution
Cannot turn on the camcorder.	The batteries are not inserted correctly. The batteries have no power.	<ul style="list-style-type: none">• Insert the batteries correctly. (See 2.2 Inserting the batteries.)• Please charge the battery. (See 2.3 Charging the battery.)
The camcorder suddenly turns off.	The auto power off function was enabled. The camcorder is running out of battery power.	<ul style="list-style-type: none">• Turn the power on again.• Please charge the battery. (See 2.3 Charging the battery.)
The captured image is not stored in memory.	Before the image is saved the power has been cut off.	When battery indicator turns empty (without green bars), replace the battery immediately.

Problem	Possible Cause	Solution
The camcorder turns off when capturing image using self-timer.	The camcorder is running out of battery power.	<ul style="list-style-type: none"> • Please charge the battery. (see 2.3 Charging the battery)
The image is out of focus.	The subject is beyond focus range.	<ul style="list-style-type: none"> • Please take a picture within the available focus range and choose normal or macro mode. (See 3.2.2 Using AF Lock).

Problem	Possible Cause	Solution
<p>Memory card cannot be used.</p>	<p>The memory card is protected.</p> <p>The memory card contains non-DCF images taken by other camcorders.</p> <p>The SD card speed is too low.</p>	<ul style="list-style-type: none"> • Unlock the memory card. • Format the memory card. (See 4.5.4 Format.) Before formatting the card, ensure you back up the files. • You can set the video or photo to lower quality. (See 4.1.2 Video quality)
<p>All buttons are inactive.</p>	<p>Short circuit occurred when connecting the camcorder with other devices.</p>	<ul style="list-style-type: none"> • Remove the batteries from the camcorder and insert again.



SDHC Logo is a trademark of SD-3C, LLC.

Website:

Please visit our website at www.dygusa.com for any product updates or special announcements.

You can also check out our online support desk where you can register your product, send emails to our technical support, and find a list of frequently asked questions (FAQs).



DXG USA

Free Manuals Download Website

<http://myh66.com>

<http://usermanuals.us>

<http://www.somanuals.com>

<http://www.4manuals.cc>

<http://www.manual-lib.com>

<http://www.404manual.com>

<http://www.luxmanual.com>

<http://aubethermostatmanual.com>

Golf course search by state

<http://golfingnear.com>

Email search by domain

<http://emailbydomain.com>

Auto manuals search

<http://auto.somanuals.com>

TV manuals search

<http://tv.somanuals.com>