

Fold^NGo[®]

Care Center

Instruction Manual

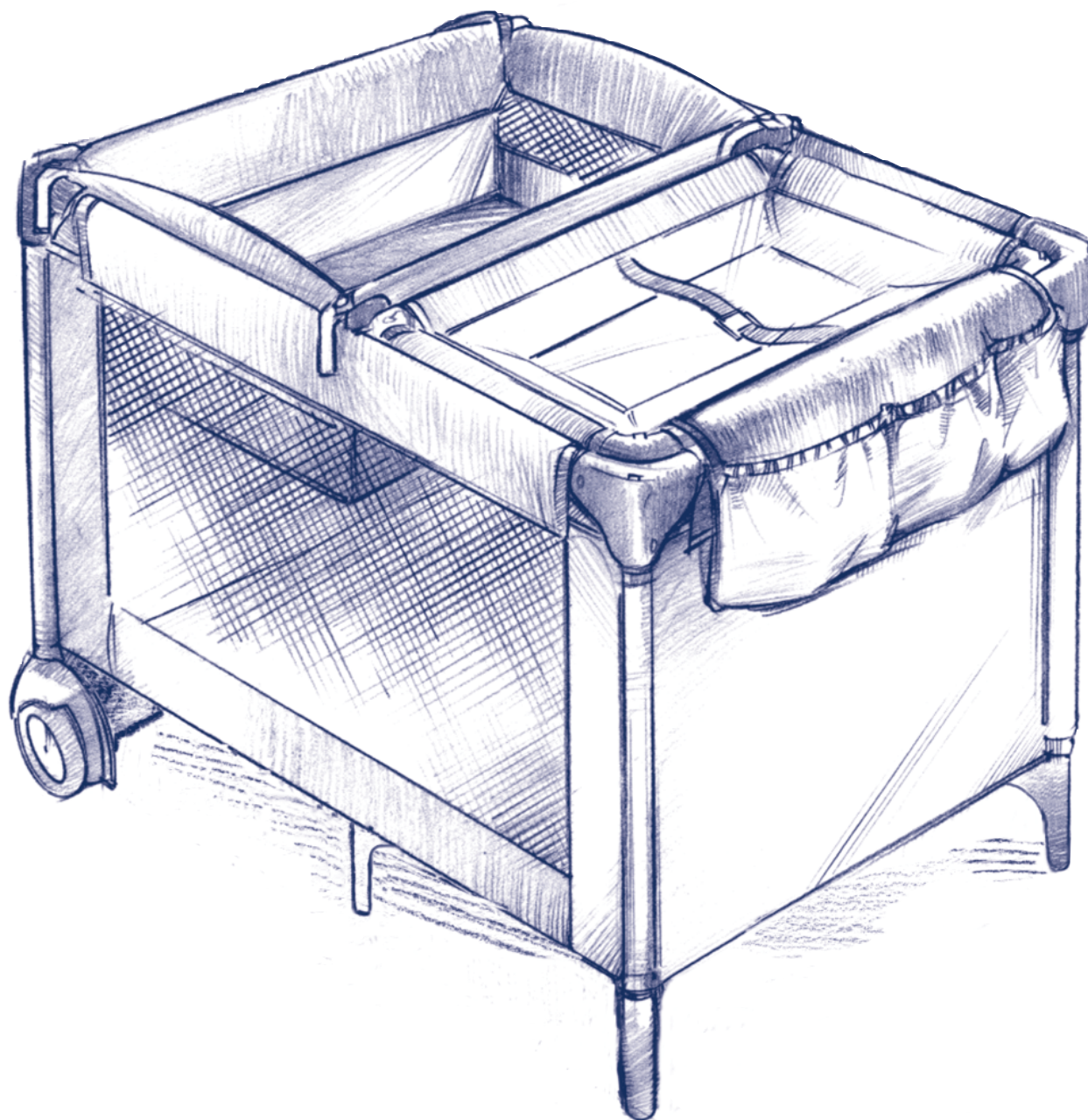

**Do not use this product until
you read and understand
these instructions.**

English PM-1645AA 6/00

Century[®]

DEDICATED TO QUALITY

IMPORTANT INFORMATION

Table of Contents

Page:

1 Important Information

2 Warnings

3 Assembly and Use

Playard

Bassinet

Changer

7 Folding and Storing

Changer

Bassinet

Playard

9 Maintenance

Cleaning

9 Replacement Parts

Safety First Checklist

- ✓ Read and understand instruction manual before assembling and using Fold'N Go Care Center.
- ✓ Do not use in any vehicle.
- ✓ Never leave child unattended.
- ✓ Use with only one (1) child at a time.
- ✓ Do not use bassinet as a car bed.
- ✓ Do not use bassinet if infant can push up on hands and knees or sit unassisted.
- ✓ Do not carry bassinet with child in it.
- ✓ Do not move or fold Playard with child in it.
- ✓ Do not add padding or other objects inside Playard which may permit child to climb out or cause a suffocation hazard.
- ✓ Do not use accessories other than those provided by Century.

Weight, Height and Activity Limits

Bassinet and Changer:

Maximum Weight: 8.2 kg (18 lbs.)

Maximum Height: 63.5 cm (25 inches)

Activity: Discontinue use if child can push up on hands and knees or sit unassisted.

Playard:

Maximum Weight: 14 kg (30 lbs.)

Maximum Height: 89 cm (35 inches)

Activity: Discontinue use if child can climb out of Playard.

Need Help?

If you should have any problems with this product, *call toll-free 1-800-837-4044 from anywhere in the U.S. or Canada or fax at 1-610-286-4555.*

Or write us at: Century Products
P.O. Box 100
Elverson, PA 19520-9974
Attention: Customer Service Department

Please have the following information available. See label on bottom tubing of Playard.

Model Number: _____

Manufacture Date: _____

Date of Purchase: _____

*Save instruction manual
for future reference.*



WARNINGS

Failure to follow all warnings and instructions could result in serious injury or death.

- **Never leave child unattended. Always keep child in view.**
- **This product is intended for use by one child at a time.**
- **Bassinet, Changer and/or Playard, including side rails, *MUST* be fully erected prior to use.**
- **Keep product away from stoves, heaters, campfires, fireplaces and other hazards which can burn or cause injury to child.**
- **DO NOT use accessories other than those provided by Century.**
- **Strings can cause strangulation. DO NOT place items with a string around a child's neck (such as hood strings, pacifier cords, etc.). DO NOT suspend strings over product or attach strings to toys.**
- **DO NOT place product near a window where cords from blinds or drapes can strangle child.**
- **DO NOT use product in a motor vehicle. Serious injury or death could result from a sudden stop or accident.**

ASSEMBLY and USE

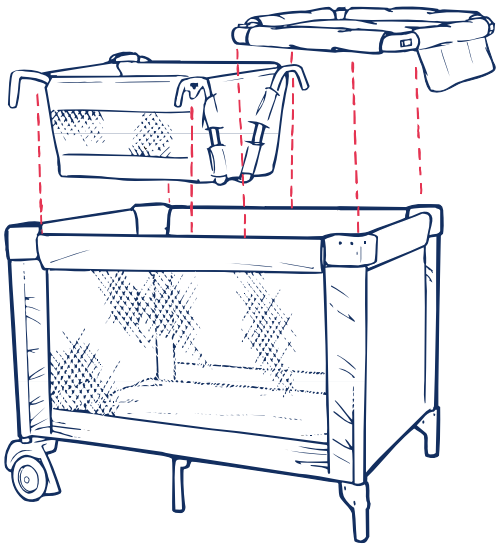

- 2 Stand Playard on legs and wheels and unfasten **Floorboard Attachment Straps**.

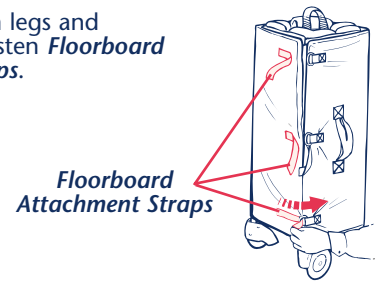

- 3 Separate Playard legs to approximately 60 cm (2 feet) apart.



- 4 Pull up on **Top Rails** until all "click" and lock.

IMPORTANT: Floor loop **MUST** remain raised at least 45.7 cm (18 inches) in order for rails to lock.

NOTE: Test by pushing down on each top rail to be sure they are locked.

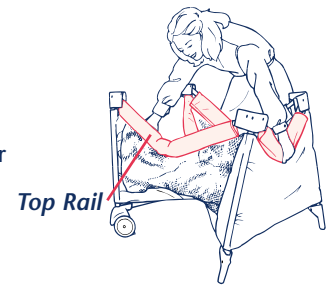

Playard

WARNING

Avoid serious injury or death:

- Use Playard for a child who is unable to climb out of Playard and weighs less than 14 kg (30 lbs.) and is less than 89 cm (35 inches) tall.
- **DO NOT** use Playard without floorboard being properly secured to Playard floor.
- **DO NOT** add padding or objects inside Playard that will permit child to climb out.
- **DO NOT** move or fold Playard with child in it.
- **SUFFOCATION HAZARD:** To help prevent suffocation from entrapment, use only floorboard provided by Century. **NEVER** use additional mattress or padding.

WARNING

All top rails **MUST** be straight and locked in position or child may become entrapped and suffocate.

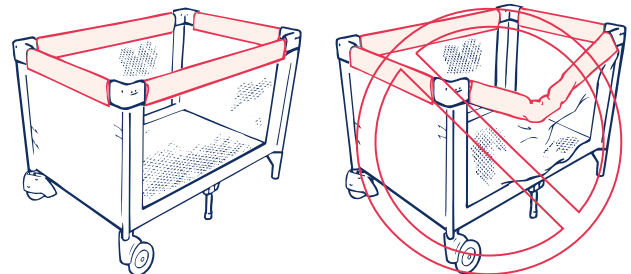

- 1 Pull travel bag up and over top of Playard.

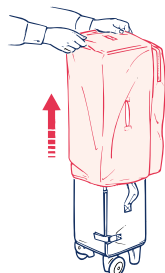

- 5 Push down on center of Playard floor until it is flat and **locks** into position.

NOTE: Locking action is automatic.

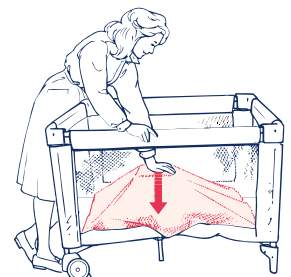

ASSEMBLY and USE continued

HINT: It may be necessary to lift end of Playard to push center down.

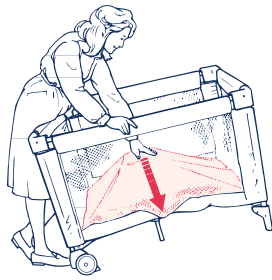

- 6 Place floorboard in Playard with padded side facing up.

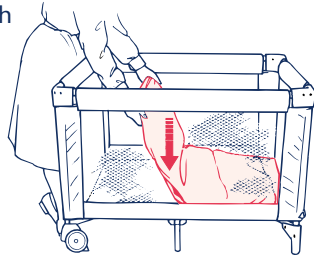

NOTE: *DO NOT* install floorboard if using bassinet. Go to bassinet assembly section.

- 7 Secure ends of floorboard to Playard by passing **Attachment Straps** through holes in bottom of Playard floor and securing to underside of Playard.

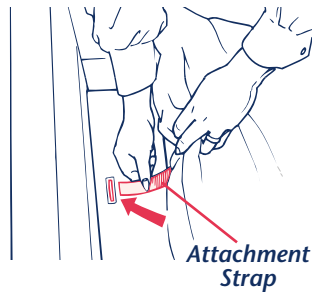

WARNING

To prevent child from suffocating, attachment straps **MUST** be secured to underside of Playard.

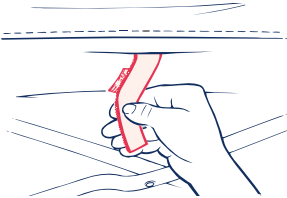

Playard assembly is now complete and ready to use.

Bassinet

WARNING

Avoid serious injury or death:

- Use bassinet with infant who weighs less than 8.2 kg (18 lbs.) and is less than 63.5 cm (25 inches) tall.
- **DO NOT** use without floorboard being properly placed in bassinet.
- Discontinue use of bassinet if infant can push up on hands and knees or sit unassisted.
- **DO NOT** carry bassinet with infant in it.
- **DO NOT** use as a car bed.
- **SUFFOCATION HAZARD:** To help prevent suffocation from entrapment, use only floorboard provided by Century. **NEVER** use additional mattress or padding.

- 1 Lay bassinet on flat surface and spread open.



- 2 Rotate and extend four (4) **Hooks** until they "click" in place.

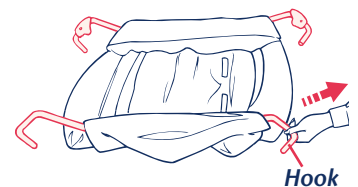

- 3 If floorboard is installed in Playard, remove floorboard.

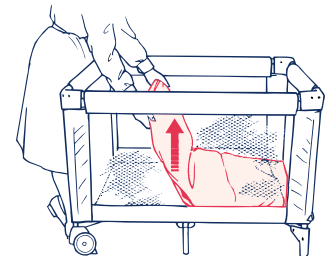

- 4 Fold **Floorboard** into "W" shape and place in center of bassinet.

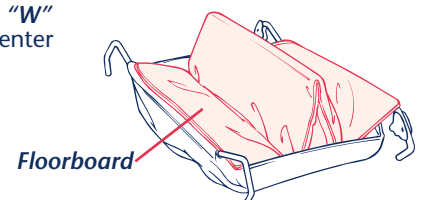

ASSEMBLY and USE continued

- 5 Insert one side of floorboard under *Pocket* on side of bassinet.

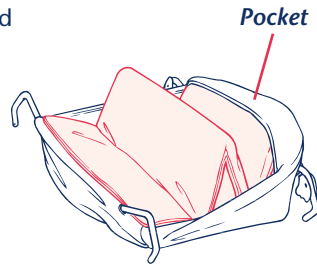

- 6 Pull *Pocket* down over floorboard to hold floorboard in place.
Repeat steps 5 and 6 for other side of floorboard.

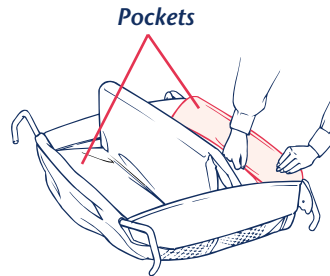

- 7 Push down on center of floorboard to flatten.

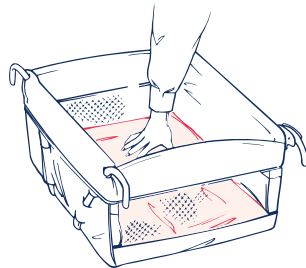

Bassinet assembly is now complete.

- Bassinet can be used *with* or *without* changer.
- Bassinet can be used *with* or *without* Playard.

To use bassinet with Playard:

- 1 Place bassinet in Playard so that hooks go over long rails with "*T-Slots*" facing center of Playard.

NOTE: "*T-Slots*" **MUST** face center of Playard when using with changer.

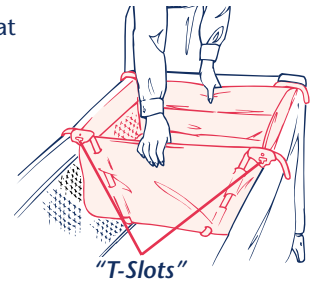

- 2 Secure bassinet to Playard:

- Pass *Attachment Strap* through opening in corner of side panel of Playard.
- Fasten strap to outside of Playard.

Repeat for other strap.

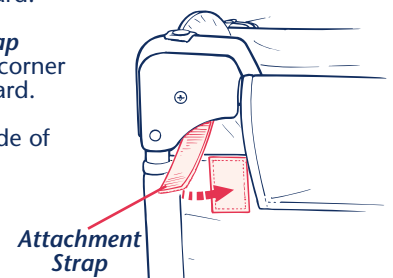

Bassinet is now ready for use with Playard.

To use bassinet without Playard:



WARNING

Prevent falls and suffocation:

- Use only on a surface that is flat, level and stable.
- Keep bassinet away from surface edges.

- 1 Set bassinet on flat and stable surface that will keep floorboard level so child will not roll into corner or side of bassinet resulting in breathing difficulties.

- 2 Keep at least 30.5 cm (12 inches) away from surface edges and stay within reach of child. Child's wiggling and rocking may cause bassinet to move and possibly fall off surfaces.

ASSEMBLY and USE continued

Changer

Changer can *only* be used when bassinet is installed in Playard.

WARNING

Avoid serious injury or death:

- Always use restraint belt to prevent falls.
- Use with infant who weighs less than 8.2 kg (18 lbs.) and is less than 63.5 cm (25 inches) tall.
- Discontinue use of changer if infant can push up on hands and knees or sit unassisted.
- **DO NOT** carry changer with infant in it.

- 1 Lay changer on flat surface.

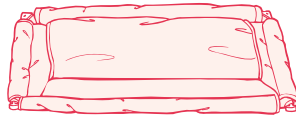

- 2 Grasp middle of each long side and gently pull apart until short sides "click" and lock in place.

NOTE: Make sure changer sides are fully extended and locked.

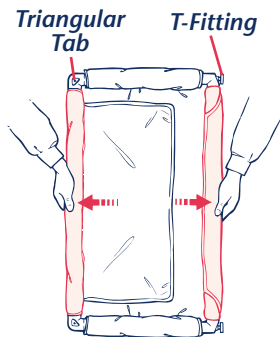

- 3 With vinyl side facing up, insert two (2) "T-Fittings" on changer into "T-Slots" in bassinet and push down to secure.

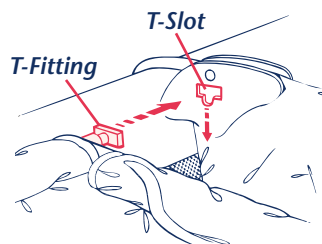

- 4 Push *Triangular Tabs* into *Triangular Holes* in Playard corners.

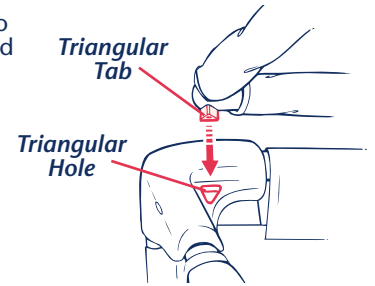

- 5 Secure changer to Playard:

- Pass *Attachment Strap* through opening in corner of side panel of Playard.
- Fasten strap to outside of Playard.

Repeat for other strap.

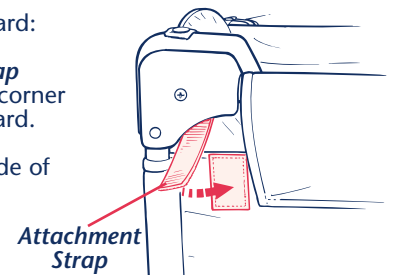

- 6 Place storage pocket flap over side of Playard.

NOTE: *DO NOT* place supplies weighing more than 2.3 kg (5 lbs.) in storage pocket.

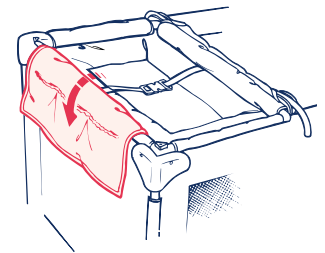

Changer is now ready for use.

FOLDING and STORING

Changer

1 Unfasten attachment straps.

2 Unhook "T-Fittings" from "T-Slots" by pulling up slightly on long side closest to bassinet, then pull changer away from bassinet.

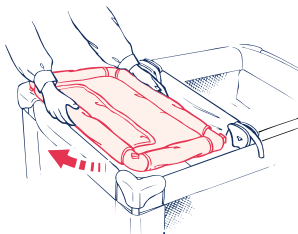

3 Grasp short sides and feel for release buttons in center of short sides.

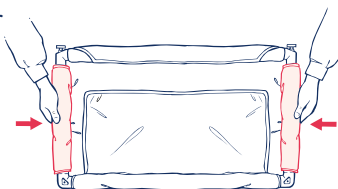

4 Press buttons on each side and push closed.

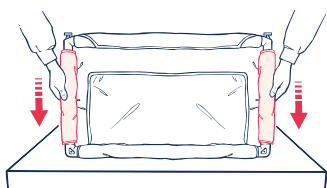

5 Place changer in pocket of travel bag.

3 Remove floorboard from bassinet.

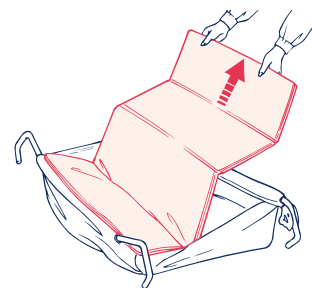

4 Press release buttons on each hook and push hook into larger tube.



5 Rotate hooks to center of bassinet.

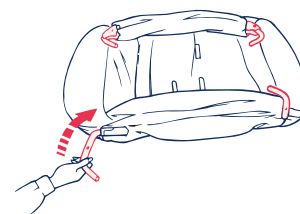

6 Fold bassinet.

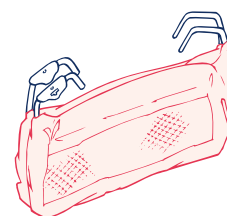

Bassinet

1 Unfasten both attachment straps.

2 Remove bassinet from Playard.

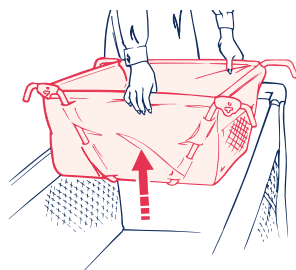

7 Place bassinet in pocket of travel bag.

IMPORTANT: If continuing to use Playard, be sure to properly secure floorboard in Playard.

FOLDING and STORING continued

Playard

1 To remove floorboard:

- Unfasten attachment straps.
- Remove floorboard and set aside.

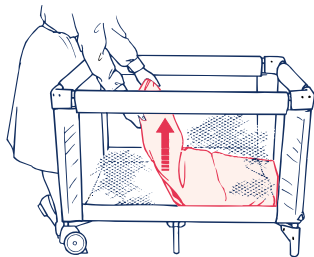

2 Lift **Floor Handle**, rotate counterclockwise to unlock floor and pull up, approximately 45.7 cm (18 inches).

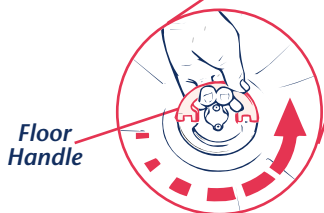
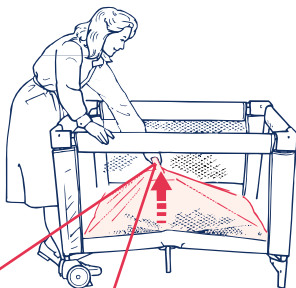

3 To fold top rails:

- Pull up on top rail slightly.
- Squeeze **Release Button** on bottom of top rail and push rail down. (Release buttons are identified by printed arrows.)

Repeat for other sides.

NOTE:

- If rails are difficult to unlock, raise center of floor higher and squeeze **Release Button** again.
- If only one side of rail folds, squeeze **Release Button** again to fully fold.

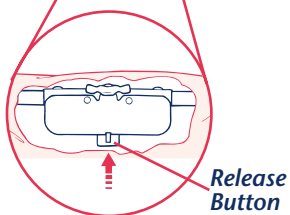
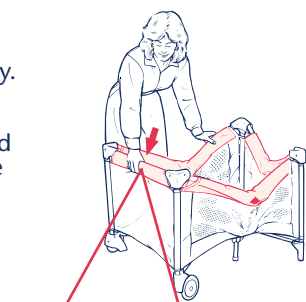

4 Gather Playard frame together while pulling up on **Floor Loop**.

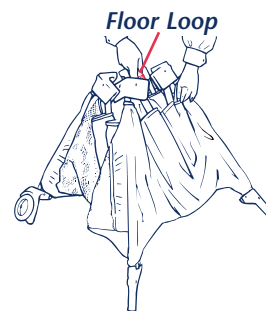

5 Wrap floorboard around Playard frame with padding facing in.

NOTE: Floorboard **Handle** **MUST** be aligned with wheels as shown.

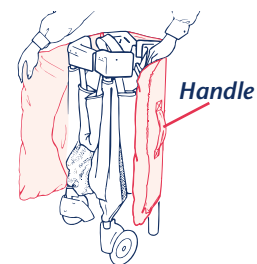

6 Secure **Attachment Straps** by threading through loops on end of floorboard and folding back onto itself.

NOTE: Make sure floorboard is positioned above wheels.

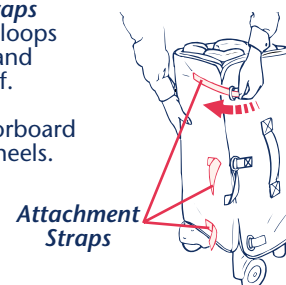

7 Position travel bag over Playard so **Handle** comes through **Opening** in side of bag.

Pull travel bag over Playard.

Pull **Floor Loop** through opening on top of travel bag.

NOTE: To prevent rubbing, make sure travel bag is positioned above wheels.

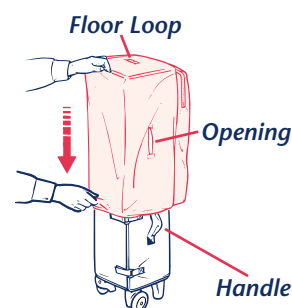

MAINTENANCE

Cleaning

Playard, Bassinet, Changer, Floorboard and Travel Bag

- Surface wash with mild detergent and water, air dry.
- Quickly clean up any spills with warm soapy water.

REPLACEMENT PARTS

<i>Parts List (Model 10-751-XXX-01)</i>	<i>Price</i>	<i>Quantity</i>	<i>Total</i>
---	--------------	-----------------	--------------

A. Travel Bag

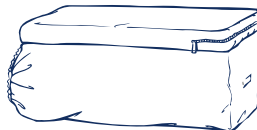

US \$ 10.00 x _____ = \$ _____
(CAN \$ 15.50)

B. Padded Floorboard



US \$ 25.00 x _____ = \$ _____
(CAN \$ 38.75)

C. Instruction Manual



FREE x _____ = FREE

NOTE: Prices subject to change.

Total Parts \$ _____

REPLACEMENT PARTS ORDER FORM

Total Parts \$ _____
Sales Tax \$ _____
Shipping & Handling \$ _____
Outside Continental USA \$ _____
Total \$ _____

Sales Tax

- **California, Illinois, Indiana, Maryland and New York** Residents Add Sales & Applicable Local Taxes
- **Ohio** Residents Add 5.75% Sales Tax
- **Pennsylvania** Residents Add 6% Sales Tax except for **Philadelphia** and **Allegheny Counties** add 7% Sales Tax
- **South Carolina** Residents Add 5% Sales Tax

Shipping & Handling

US \$ 0.01 to \$ 9.99 = US \$ 3.00
(CAN \$ 0.01 to \$ 15.49 = CAN \$ 4.75)

US \$ 10.00 and over = US \$ 5.00
(CAN \$ 15.50 and over = CAN \$ 7.75)

Outside Continental USA

Add: US \$ 10.00
(CAN \$ 15.50)

We must have this information to process your order: see label on bottom tubing of Playard.

Model No.: _____

Manufacture Date: _____

Please make checks payable to **CENTURY PRODUCTS** or charge to **VISA, MASTERCARD** or **DISCOVER**.

Orders outside USA **Must** use credit card.

Cardholder's Name: _____

Card Number: _____

Card Exp. Date: _____

Check enclosed for \$ _____

NOTE: If requested color is not available, a similar color will be substituted.

SHIP TO:

Name: _____

Address: _____

City: _____

State: _____ Zip: _____

Telephone No.: (____) _____

MAIL BOTH PAGES OF ORDER TO:

**CENTURY PRODUCTS
P.O. BOX 100
ELVERSON, PA 19520-9974
ATTENTION: CUSTOMER SERVICE DEPARTMENT**

FAX BOTH PAGES OF ORDER TO:

(610) 286-4555

PM-1645AA 6/00



Remember

We are here to help you!

For immediate help, call our Customer Service Department at 1-800-837-4044 from anywhere in the U.S. or Canada or fax at 1-610-286-4555.



Free Manuals Download Website

<http://myh66.com>

<http://usermanuals.us>

<http://www.somanuals.com>

<http://www.4manuals.cc>

<http://www.manual-lib.com>

<http://www.404manual.com>

<http://www.luxmanual.com>

<http://aubethermostatmanual.com>

Golf course search by state

<http://golfingnear.com>

Email search by domain

<http://emailbydomain.com>

Auto manuals search

<http://auto.somanuals.com>

TV manuals search

<http://tv.somanuals.com>