

GETTING ACQUAINTED

This section contains important basic information about using the watch. Be sure to read this section before trying to use the watch for the first time.

About this manual

- Each section of this manual provides you with the information you need to perform operations in each mode. Further details and technical information can be found in the "REFERENCE" section.
- Button operations are indicated using the letters and arrow marks shown in the illustration.

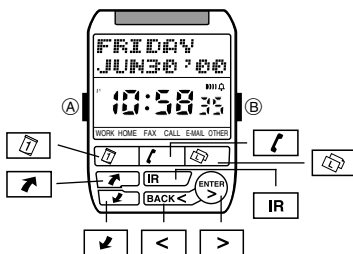

- This watch indicates days of the week and months as shown below.
Days of the week: **SUNDAY** (Sunday), **MONDAY** (Monday), **TUESDAY** (Tuesday), **WEDNESDAY** (Wednesday), **THURSDAY** (Thursday), **FRIDAY** (Friday), **SATURDAY** (Saturday)
Months: **JAN** (January), **FEB** (February), **MAR** (March), **APR** (April), **MAY** (May), **JUN** (June), **JUL** (July), **AUG** (August), **SEP** (September), **OCT** (October), **NOV** (November), **DEC** (December)
- The term "the watch" in this manual refers to the CASIO PC-UNITE Watch (Module 1910).
- The term "M-1510 Watch" in this manual refers to the CASIO PC-UNITE or PCX Watch (Module 1510).
- The term "Watch Application" in this manual refers to the CASIO PC-UNITE Watch Version 2.0 Software Application.
- PC-UNITE is a trademark of CASIO COMPUTER CO., LTD.

General Guide

- In the case of data storage modes (Contact, Schedule, User, Browser, To Do), the initial screens shown below appear first for about one second. After that, the data stored in the mode appears.
- If a data storage mode does not have any data, the message **NO DATA!** appears after the initial screen.

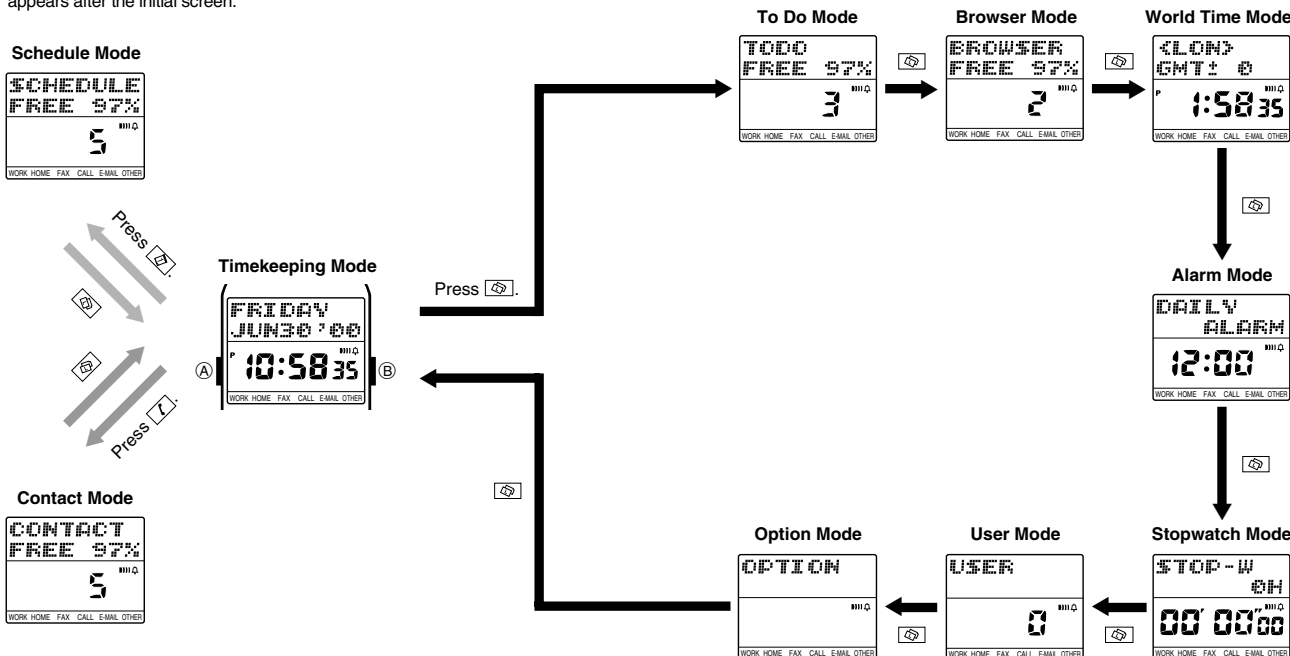

- The following describes all the mode change key operations you can perform.

When you want to do this:	Do this:
Cycle through modes	Press [Mode].
Display the World Time City while in the Timekeeping Mode	Hold down [World Time].
Display your Home Time City while in the Timekeeping Mode	Hold down [Home Time].
Display your next appointment in the Schedule Mode	Hold down [Next].
Go to the Contact Mode from any mode	Press [Contact].
Go to the Schedule Mode from any mode	Press [Schedule].
Go to the Timekeeping Mode from the Contact Mode	Press [Timekeeping].
Go to the Timekeeping Mode from the Schedule Mode	Press [Timekeeping].
Go to the Weekly Schedule screen from the Timekeeping Mode	Press [Weekly].
Return to the Timekeeping Mode from the Weekly Schedule screen	Press [Timekeeping].

Home Time City

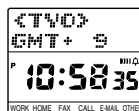

World Time Mode



Schedule Mode



Inputting Text and Other Data

The following describes general procedures for inputting text, symbols and numbers. The operations described here can be used in any mode where you can input data. See the other sections of this manual that describe the various modes for information about displaying record input screens.

Record Operation Menu



The record operation menu lets you select the operation you want to perform while inputting, editing, and deleting data in a mode that stores data (Contact, Schedule, User, Browser, To Do).

- The actual content of the record operation menu depends on what mode you are in when you display it.
- Unavailable menu items are replaced with ****. If memory is full, for example, the **NEW** item is replaced by **** indicating you cannot input new data.

Text Input Buttons

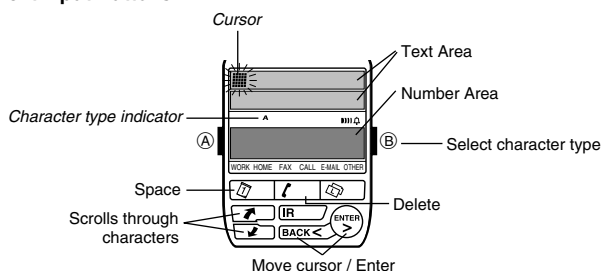

- The flashing cursor (■) shows the location where the next character will be input.

Display Areas

The display has two areas for input and recall, a *text area* and a *number area*. As their names suggest, the text area is for inputting and displaying text (Contact name field, Schedule description field, Browser text field, etc.), while the number area is for inputting and displaying numbers (time, date, telephone number fields, etc.).

- In the Contact Mode and User Mode, the lower line of the text area is used for number display.

To input characters

- While the cursor is flashing in the text area of the display, use \leftarrow and \rightarrow to move the cursor to the location where you want to input a character.
- Use B to select the type of character you want to input.
- Each press of B cycles through the character types as shown below. The currently selected character type is indicated on the display by the character type indicator.

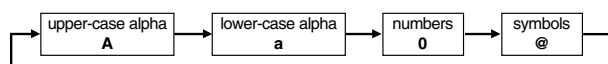

- Use \uparrow and \downarrow to scroll through the available characters at the cursor location.
- When the character you want is shown, press \rightarrow to move the cursor to the next position.
- \leftarrow and \rightarrow keys move the cursor left and right.

Note

- See the "CHARACTER LIST" for details about the characters you can input on the watch.

To delete a character

- Use \leftarrow and \rightarrow to move the cursor to the character you want to delete.
- Press DEL to delete the character at the cursor position.

To insert a character

- Use \leftarrow and \rightarrow to move the cursor to the location where you want to insert a character.
- Press SPACE to insert a space at the current cursor position.
- Input the character you want.

To input numbers

- While the cursor or digits are flashing in the number area of the display, use \leftarrow and \rightarrow to move the cursor to the digit you want to input.
- Use \uparrow and \downarrow to change the setting.

Turning On the Display Backlight

Except when you are making settings or performing a data communication operation, pressing the B button in any mode turns on the backlight for about two seconds. The backlight uses an EL (electro-luminescent) panel that causes the entire display to glow for easy reading in the dark.

If you need to keep the backlight on longer, keep the B button depressed. Even if you do, however, the backlight automatically turns off after about six seconds.

Important!

- You may not be able to see the backlight if you turn it on under direct sunlight.
- The backlight turns off automatically if an alarm or other buzzer operation is performed while it is on.
- The EL backlight vibrates slightly when it is turned on, which can cause a noticeable sound. This does not indicate malfunction.
- The electro-luminescent panel loses illuminating power after very long use.

CONTACT MODE

The Contact Mode lets you store names, telephone numbers, e-mail addresses and other data for later recall when you need it. See "Data Fields" for details on Contact Mode data fields.

- With the M-1510 Watch, this function is called the Telememo Mode instead of Contact Mode.

Entering the Contact Mode

In any mode, press the F key to enter the Contact Mode.

- The display initially shows how many Contact records are stored and the percentage of memory that is unused. Next, the display changes to the index screen.

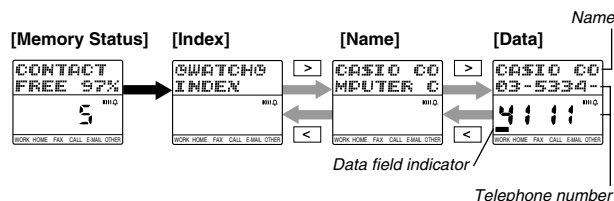

- From the index screen, press \rightarrow to change to the name screen. Press \leftarrow to return to the index screen.
- The data screen shows the telephone number, fax number, and other data.
- Field names are shown along the bottom of the display. The data field indicator is located above the name of the field screen that is on the display. In the above screen, for example, the number shown is a work telephone number.
- The following is the meaning of each available field name: **WORK** (work number), **HOME** (home number), **FAX** (work and home fax numbers), **CALL** (two mobile phone, pager, or other numbers), **E-MAIL** (e-mail address), **OTHER** (other).
- The message NO DATA! appears when you display the name or data screen while there is no Contact Mode data stored in memory.

Inputting Contact Data

Use the following procedure to input a new Contact record. See "Inputting Text and Other Data" for full details about inputting characters.

To input a new Contact record

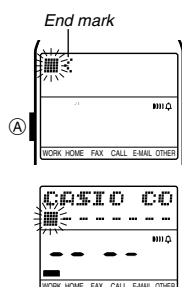

- In the Contact Mode, display the name or data screen.
- Hold down A for about two seconds until the record operation menu appears.
- MENU is flashing on the operation menu, so press the \rightarrow key to display the new record input screen.
- Input the name, and then press the END key.
- Input data for the other fields, pressing END after each.
- The number area initially contains all hyphens. You can leave the hyphens or replace them with numbers or spaces.
- When you are finished inputting all the data you want, press the A button to return to the name screen.

- A Contact record must have at least a name to be stored. Other fields can be skipped by pressing END without inputting anything.

Recalling Contact Records

Contact data that is input on this watch or received from another watch is listed in the SWATCHES index. This data is listed in the sequence that it is input, without sorting.

When you input data on your computer, sort it, and then download it to the watch, it is listed in an index of the same sequence as that produced by the computer sort operation.

Whenever you want to recall Contact data, the first step is to select which index (SWATCHES or index sorted on a computer) you want to use.

Index Sequence in Watch Memory

Indexes are stored in watch memory in the sequence shown below.

- Index sorted on a computer
- Indexes imported from M-1510 Watch
- SWATCHES Index

To view data in an index imported from M-1510 Watch or in the SWATCHES index, scroll down past the index sorted on a computer and then scroll through the data in the imported or SWATCHES index.

- You cannot edit or delete an index using the watch.

To recall a Contact record

- Press \leftarrow to display the index screen.
- Use \leftarrow and \rightarrow to select the letter that starts the name field data of the record you want to recall.
 - To recall a record in the NAME INDEX index, scroll down to NAME INDEX .
- Press \rightarrow to display the name field screen of the first record whose name field begins with the letter you selected in step 2.
 - If there is no data stored under the letter you select in step 2, pressing \rightarrow in step 3 displays the message NO DATA . Note that you cannot scroll from the NO DATA screen. You must press \leftarrow to return to the letter selection screen in step 2.
- Press \rightarrow to scroll forward through the names or \leftarrow to scroll back.
- When the name field screen for the Contact record you want to recall is displayed, press \rightarrow to display its data screen.
- Use \leftarrow and \rightarrow to view the other fields of the Contact record.
 - The data field indicator at the bottom of the screen shows which field's data is currently on the display.
 - Only fields that contain data appear. Fields without data are skipped automatically.

Editing a Contact Record

- Display the name or data screen of the record you want to edit.
- Hold down the A button for about two seconds until the record operation menu appears.
- Press \rightarrow to move the flashing to EDIT , and then press the \rightarrow key to display the record editing screen.
- Make any changes to the record you want, pressing the EDIT key after you finish editing each field.
 - If you want to leave the data in a field as it is, press the EDIT key without making any changes.
- When you are finished making all the changes you want, press the A button.

Deleting a Contact Record

- Display the name or data screen of the record you want to delete.
- Hold down the A button for about two seconds until the record operation menu appears.
- Press \rightarrow to move the flashing to DELETE , and then press the \rightarrow key.
- In response to the confirmation message that appears on the display, press the \rightarrow key to delete the record or the A button to abort the procedure without deleting anything.

SCHEDULE MODE

The Schedule Mode helps to keep you on time all the time by letting you take a record of your appointments with you wherever you go. Schedule alarms sound to remind you of important events. See "Data Fields" for details on Schedule Mode fields.

Entering the Schedule Mode

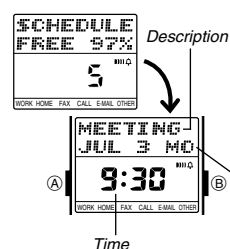

In the any mode, press the Q key to enter the Schedule Mode.

- The display initially shows how many Schedule records are stored and the percentage of memory that is unused. Next, the display changes to the next scheduled appointment.

Month Day Day of week

Time

Inputting a Schedule Record

Use the following procedure to input a new Schedule record. See "Inputting Text and Other Data" for full details about inputting characters.

To input a new Schedule record

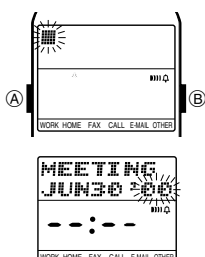

- In the Schedule Mode, hold down the A button for about two seconds until the record operation menu appears.
- NEW is flashing on the operation menu, so press the \rightarrow key to display the new record input screen.
- Input the description of the appointment, and then press the EDIT key.
 - The initial date set for a new Schedule record is today's date, as kept in the Timekeeping Mode.

- Input the date (year, month, day), and time (hour and minutes).
 - Use \leftarrow and \rightarrow to move the flashing between the digits, and \uparrow and \downarrow to cycle through numbers at the flashing digit.
- To create a Schedule record as an All Day Event (for an anniversary, birthday, or event that takes all day), set the year, month, and day, and then press the MEMO key. This causes the time setting to disappear from the display.
- When you are finished inputting all the data you want, press the A button.
 - The Schedule record screen shows the day of the week in place of the year.
 - Schedule records are automatically sorted according to date and time.
 - A standard Schedule record must have description and date, and time data to be stored. An All Day Event Schedule record must have description and date data.
 - When inputting a Schedule record, if you input a time but then change your mind and want to change the record to an All Day Event, you can simply delete the time. If you do this, however, the time you originally input remains associated with the All Day Event, even though it does not appear on the watch display. When you upload the record to your computer, the time you originally input appears on the computer screen, even though the record is for an All Day Event.

Recalling Schedule Records

In the Schedule Mode, press \rightarrow to scroll forward through records or \leftarrow to scroll back.

Schedule Reminder Alarm

You can set a schedule reminder alarm to sound at the time for which appointments are scheduled (0:00), or at 5, 10, 15, 30, 45, or 60 minutes before appointment times. When the watch is in the Timekeeping Mode, the description, time, and date of a Schedule record appears on the display when its schedule reminder time is reached.

- The schedule reminder alarm setting is applied for all schedule records. You cannot make individual settings for each schedule record.
- The initial factory default for schedule reminder alarms is 10 minutes before the Schedule record time.
- The schedule reminder alarm sounds for about 20 seconds or until you press any button or key.
- A schedule reminder alarm cannot be set for an All Day Event Schedule record.
- The description remains on the display for about three minutes in the Timekeeping Mode, or until you press any key after the schedule reminder alarm stops sounding.
- If another Schedule time is reached within about three minutes after a previous Schedule time, the second alarm does not sound unless you cleared the first record's description from the display by pressing any key after its schedule reminder alarm stops sounding.

Setting the Schedule Reminder Alarm Time

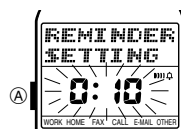

- In the Schedule Mode, hold down the A button for about two seconds until the record operation menu appears.
- Press \rightarrow to move the flashing to REM and then press \rightarrow .
 - At this time the current schedule reminder alarm setting appears flashing on the display.

- The schedule reminder alarm setting indicates how many minutes before the Schedule record time the alarm will sound.
- Use \leftarrow and \rightarrow to change the setting.
 - You can select one of the following for this setting: $0:00$ (same time as Schedule record time), $0:05$ (5 minutes), $0:10$ (10 minutes), $0:15$ (15 minutes), $0:30$ (30 minutes), $0:45$ (45 minutes), $1:00$ (1 hour).
 - After you select the setting you want, press the A button.

Weekly Schedule Screen

In the Schedule Mode, press \rightarrow to change to the Weekly Schedule screen for the week that contains today's date.

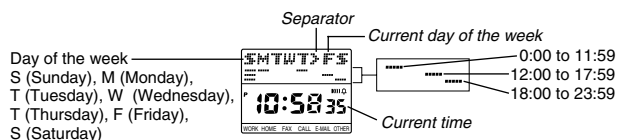

- A bar (—) appears under each day of the week where you have an appointment scheduled. The position of each bar indicates the relative part of the day for which the appointment is scheduled.
- A day for which there is an All Day Event Schedule record is indicated by \equiv alternating with \times .
- To return to the Schedule record screen, press \leftarrow (or Q).

Editing a Schedule Record

1. Recall the record you want to edit.
2. Hold down the (A) button for about two seconds until the record operation menu appears.
3. Use [↔] and [↔] to move the flashing to **EDIT**, and then press the [↔] key.
4. Make any changes you want to the description and date/time field data.
 - Press [↔] to toggle the display between the description field and the date/time field screens.
 - While the date/time field screen is on the display, use [←] and [→] to move the flashing in the following sequence.

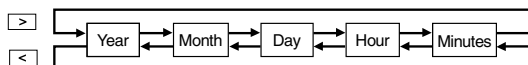

- To change the Schedule record to an All Day Event, press [M] while any of the date digits are flashing. This causes the time setting to disappear. Press [M] again to make the time setting reappear.
5. When you are finished making all the changes you want, press the (A) button.

Deleting a Schedule Record

1. Recall the record you want to delete.
2. Hold down the (A) button for about two seconds until the record operation menu appears.
3. Press [↔] to move the flashing to **CLR**, and then press the [↔] key.
4. In response to the confirmation message that appears on the display, press the [↔] key to delete the record or the (A) button to abort the procedure without deleting anything.

TO DO MODE

The To Do Mode makes it possible to keep track of all the important things you need to do. See "Data Fields" for details on To Do Mode fields.

Entering the To Do Mode

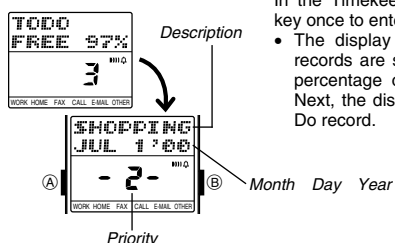

In the Timekeeping Mode, press the [↔] key once to enter the To Do Mode.

- The display initially shows how many records are stored in the mode and the percentage of memory that is unused. Next, the display changes to show a To Do record.

Inputting a To Do Record

Use the following procedure to input a new To Do record. See "Inputting Text and Other Data" for full details about inputting characters.

To input a new To Do record

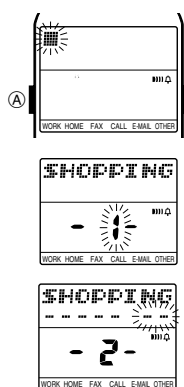

1. In the To Do Mode, hold down the (A) button for about two seconds until the record operation menu appears.
2. **NEW** is flashing on the operation menu, so press the [↔] key to display the new record input screen.
3. Input the description of the task, and then press the [↔] key.
4. Use [↔] and [↔] to input the priority of the task as a value from 1 (highest) through 4 (lowest), and then press the [↔] key.
5. Input the year, month, and day.
 - The number area initially contains all hyphens. Replace all the hyphens with values for the year, month, and day.
 - Use [←] and [→] to move the flashing between digits, and [↔] and [↔] to cycle through numbers at the flashing digit.

6. When you are finished inputting all the data you want, press the (A) button.
 - To Do records are stored in the order you input them.
 - A To Do record must have description data to be stored.

Recalling a To Do Record

In the To Do Mode, press [↔] to scroll forward through records or [↔] to scroll back.

Checking Finished Tasks

You can check off completed tasks in order to identify them as done.

To check a finished task

1. Recall the record whose task you want to check.
2. Hold down the [↔] key for two seconds, until ✓ (the checkmark) replaces the priority value on the screen.
 - Holding down [↔] for two seconds again changes back to the priority value.

Editing a To Do Record

1. Recall the record you want to edit.
2. Hold down the (A) button for about two seconds until the record operation menu appears.
3. Press [↔] to move the flashing to **EDIT**, and then press the [↔] key.
4. Make the changes you want to the description, priority, and date.
- Press [↔] to cycle between the description, priority, and date field screens.
- While the date field screen is on the display, use [←] and [→] to move the flashing the following sequence.

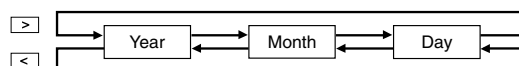

5. When you are finished making all the changes you want, press the (A) button.

Deleting a To Do Record

1. Recall the record you want to delete.
2. Hold down the (A) button for about two seconds until the record operation menu appears.
3. Press [↔] to move the flashing to **CLR**, and then press the [↔] key.
4. In response to the confirmation message that appears on the display, press the [↔] key to delete the record or the (A) button to abort the procedure without deleting anything.

BROWSER MODE

The Browser Mode makes it possible to keep text on hand all the time. See "Data Fields" for details on Browser Mode data fields.

About Browser Mode Text

Browser data is grouped according to units called pages. A page consists of a title and text.

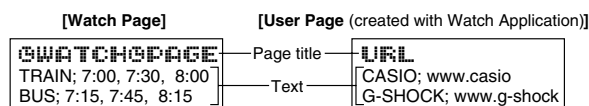

- The Browser Mode has a default page named **WATCHSPACE**. All Browser text you input using the procedure under "Inputting Browser Data" is input into the **WATCHSPACE**. The **WATCHSPACE** cannot be renamed, deleted, or moved.
- You can use the Watch Application to create your own user pages and input Browser text into them on your computer. Then you can download your Browser pages to the watch. You cannot create user pages with the watch.

Entering the Browser Mode

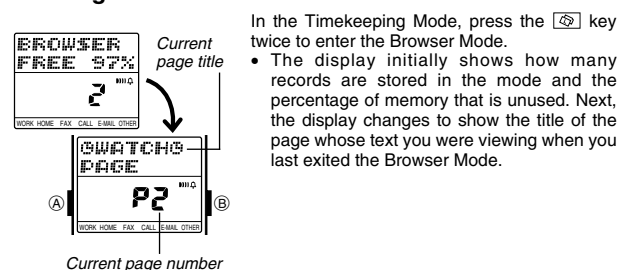

In the Timekeeping Mode, press the [↔] key twice to enter the Browser Mode.

- The display initially shows how many records are stored in the mode and the percentage of memory that is unused. Next, the display changes to show the title of the page whose text you were viewing when you last exited the Browser Mode.

Inputting Browser Data

- In the Browser Mode, use the and keys to scroll through the page titles until **WATCHPAGE** is shown.
- Press the key to open the **WATCHPAGE**.
- The contents of the **WATCHPAGE** appear on the display. The message **NO DATA!** appears if the **WATCHPAGE** does not contain any data yet.

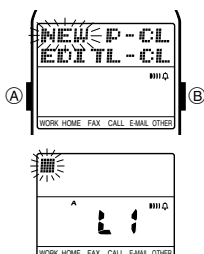

- Hold down the button for about two seconds until the operation menu appears.
- NEW** is flashing on the operation menu, so press the key to display the new data input screen.
- Input the text you want.
 - See "Inputting Text and Other Data" for details on inputting text.
- After the text is the way you want it, press the button to return to the Browser data display screen.

Recalling Browser Data

You can scroll the page titles in watch memory on the display to find the one you want. Then you can view the text stored under a specific page title.

To recall a Browser page and scroll through its text

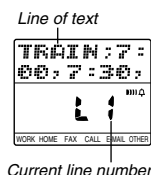

- In the Browser Mode, use and to scroll through the page titles until the one you want is on the display.
- Press the key to display the first line of text stored under the page title you selected.
- Use and to scroll line-by-line through the text stored in the page.
 - Pressing returns to the page title screen.

Editing Browser Data

You cannot edit the page title of Browser data.

To edit Browser data

- Recall the line of Browser text that you want to edit.
- Hold down the button for about two seconds until the operation menu appears.
- Use and to move the flashing to **EDIT**, and then press the key.
- Make any changes to the text you want.
- When you are finished making all the changes you want, press the button.

Deleting Browser Data

You can delete a single line of text from a page or an entire page.

To delete a single line of text

- Recall the line of text you want to delete.
- Hold down the button for about two seconds until the operation menu appears.
- Press to move the flashing to **DEL**, and then press the key.
- In response to the confirmation message that appears on the display, press the key to delete the line or the button to abort the procedure without deleting anything.

To delete an entire page

- Recall the title of the page you want to delete and then press to display the text in the page.
 - Note that the following step will not display the operation menu if a page title is on the display. You must display the contents of the page first.
- Hold down the button for about two seconds until the operation menu appears.
- Press to move the flashing to **P-CL**, and then press the key.
- In response to the confirmation message that appears on the display, press the key to delete the page or the button to abort the procedure without deleting anything.
 - Displaying the **WATCHPAGE** contents in step 1 of the above procedure causes all **WATCHPAGE** contents to be deleted. The **WATCHPAGE** itself, however, is not deleted.

USER MODE

The user data identifies the watch as yours and also provides of reference of your own phone numbers, fax numbers, and other data when it is required. See "Data Fields" for details on User Mode data fields.

Notes

- You can exchange user data with another watch using the User data exchange function.
- With the M-1510 Watch, this function is called the Owner Mode instead of User Mode.

Entering the User Mode

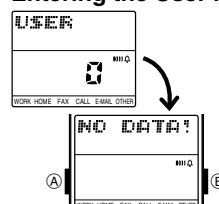

In the Timekeeping Mode, press the key six times to enter the User Mode.

- The initial screen shows if the User Mode contains data, and if it does not.

Inputting User Data

Use the following procedure to input new data. See "Inputting Text and Other Data" for full details about inputting characters.

To input new User data

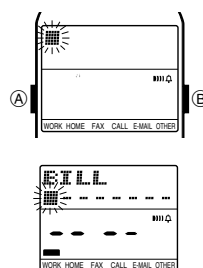

- In the User Mode, hold down the button for about two seconds until the record operation menu appears.
- NEW** is flashing on the operation menu, so press the key to display the new data input screen.
- Input the name, and then press the key.
- Input data for the other fields, pressing after each.
- When you are finished inputting all the data you want, press the button.

Recalling User Data

In the User Mode, use and to switch between the name screen and data screen.

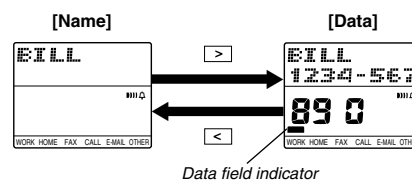

- While the data screen is on the display, you can use and to view other fields.
- The data screen's data field indicator shows the field screen that is currently displayed. See "CONTACT MODE" for information about data field indicator.

Editing User Data

- In the User Mode, hold down the button for about two seconds until the record operation menu appears.
- EDIT** is flashing on the operation menu, so press the key to display the record editing screen.
- Make any changes to the data you want, pressing the key after you finish editing each field.
 - If you want to leave the data in a field as it is, press the key without making any changes.
- When you are finished making all the changes you want, press the button.

Deleting User Data

- In the User Mode, hold down the button for about two seconds until the record operation menu appears.
- Press or to move the flashing to **DEL**, and then press the key.
- In response to the confirmation message that appears on the display, press the key to delete the data or the button to abort the procedure without deleting anything.

WORLD TIME MODE

The World Time Mode shows the current time in 27 cities (29 time zones) around the world, along with the current time in your home city (Home Time).

Entering the World Time Mode

In the Timekeeping Mode, press the $\boxed{\text{WORLD}}$ key three times to enter the World Time Mode.

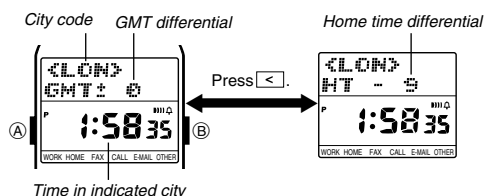

- In the World Time Mode, pressing $\boxed{\text{WORLD}}$ toggles the upper part of the display between GMT differential (time difference between GMT and the displayed zone) and Home Time differential (time difference between your Home Time and the displayed zone).
- See "World Time Mode Timekeeping" for details about city codes, GMT differential, and technical information about the World Time Mode.

Viewing the Time in Another City

In the World Time Mode, press $\boxed{\text{NEXT}}$ to scroll forward through the city codes and to $\boxed{\text{PREV}}$ scroll back.

- City codes scroll in the sequence shown in the "CITY CODE TABLE".

Daylight Saving Time (DST)

Hold down the $\boxed{\text{DST}}$ key for two seconds to toggle the displayed time zone between Daylight Saving Time (Summer Time) and Standard Time. The indicator **DST** on the display indicates that the zone is set for Daylight Saving Time.

- Daylight Saving Time automatically advances the time setting by one hour from Standard Time.
- You can make individual Daylight Saving Time settings for each time zone.

ALARM MODE

You can use the Alarm Mode to set a Daily Alarm that sounds at the same time each day, while turned on. You can also turn on an Hourly Time Signal that causes the watch to beep twice every hour on the hour.

Entering the Alarm Mode

In the Timekeeping Mode, press the $\boxed{\text{ALARM}}$ key four times to enter the Alarm Mode.

Setting the Daily Alarm Time

Use the following procedure to set the time that you want the Daily Alarm to sound each day.

To set the Daily Alarm

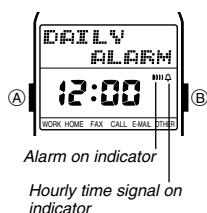

- In the Alarm Mode, hold down the $\boxed{\text{A}}$ button for two seconds until the hour digits of the alarm time start to flash on the display.
- Use $\boxed{\text{NEXT}}$ and $\boxed{\text{PREV}}$ to change the hour setting.
- When setting the alarm time using the 12-hour format, take care to set the time correctly as am (no indicator) or pm (**P** indicator).
- Use the $\boxed{\text{NEXT}}$ or $\boxed{\text{PREV}}$ keys to move the flashing to the minutes digits.
- Use the $\boxed{\text{NEXT}}$ and $\boxed{\text{PREV}}$ keys to change the minutes setting.
- After the alarm time is the way you want it, press the $\boxed{\text{A}}$ button to return to the Daily Alarm display screen.

Daily Alarm Operation

The alarm sounds at the preset time each day for about 20 seconds, or until you stop it by pressing any button or key.

To test the alarm

In the Alarm Mode, hold down the $\boxed{\text{WORLD}}$ key to sound the alarm.

Turning the Daily Alarm and Hourly Time Signal On and Off

The Daily Alarm and Hourly Time Signal sound only while they are turned on.

To turn the Daily Alarm and Hourly Time Signal on and off

In the Alarm Mode, press the $\boxed{\text{DST}}$ key to cycle through the on and off settings as shown below.

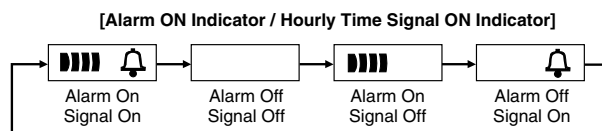

STOPWATCH MODE

With the Stopwatch Mode, you can measure elapsed time, split times, and two finishes. The range of the stopwatch is 23 hours, 59 minutes, 59.99 seconds.

Entering the Stopwatch Mode

In the Timekeeping Mode, press the $\boxed{\text{STOPWATCH}}$ key five times to enter the Stopwatch Mode.

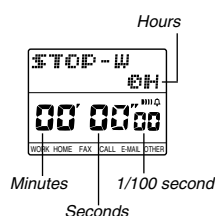

Using the Stopwatch

The $\boxed{\text{NEXT}}$ and $\boxed{\text{PREV}}$ keys are used to control stopwatch operations as shown below.

- Note that the $\boxed{\text{NEXT}}$ and $\boxed{\text{PREV}}$ keys are disabled while the backlight is lit.

(a) Elapsed Time

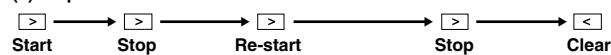

(b) Split Time



(c) Two Finishes

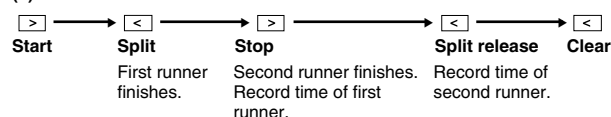

TIME AND DATE SETTINGS

Use the procedures described in this section to set the time and date after the battery is replaced.

Calibrating the Seconds Count

Use the following procedure to calibrate the seconds count on a time signal from a radio, TV, or other source.

To calibrate the seconds count

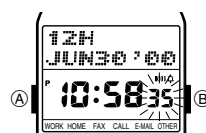

- In the Timekeeping Mode, hold down the $\boxed{\text{A}}$ button for two seconds, until the seconds digits start to flash on the display.
 - The seconds digits are flashing because they are selected.
- Press the $\boxed{\text{NEXT}}$ key to set the seconds count to $\boxed{00}$ when the time signal you are calibrating to sounds.

- Pressing $\boxed{\text{NEXT}}$ while the seconds count is in the range of 30 to 59 resets the seconds to $\boxed{00}$ and adds 1 to the minutes. If the seconds count is in the range of 00 to 29, the minutes count is unchanged.
- Press the $\boxed{\text{A}}$ button to return to the current time display.

Setting the Clock

Use the following procedure to select a city as your Home Time City, and then set its time and date. You can also specify whether you prefer to use 12-hour or 24-hour timekeeping for all screens that show times.

Important!

Changing the city setting usually changes the time setting and sometimes changes the date setting. Because of this, you should select your Home Time City before setting the time and date.

To set the clock

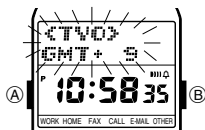

- In the Timekeeping Mode, hold down the (A) button for two seconds, until the seconds digits start to flash on the display.
 - The seconds digits are flashing because they are selected.
- Press the (B) key to display the Home Time city setting.

- Use (left arrow) and (right arrow) to scroll through the available city codes until the one you want is displayed.
 - City codes scroll in the sequence shown in the "CITY CODE TABLE".
- After setting the Home Time city, use (left arrow) and (right arrow) to move the flashing in the sequence shown below to select other digits and settings.

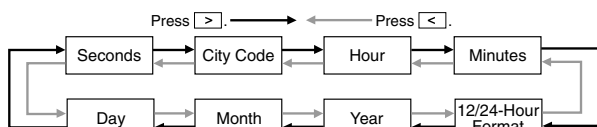

- Use the (left arrow) and (right arrow) keys to change the digits when the hour, minutes, year, month, or day setting is selected (flashing).
 - When the 12/24-hour setting is selected, use (left arrow) to toggle between 12-hour (12:00) and 24-hour (24:00) timekeeping.
- After the clock is set the way you want it, press the (A) button to return to the current time display.

Notes

- The year can be set in the range of 1995 to 2039.
- The day of the week is automatically displayed in accordance with the year, month, and day setting.
- The watch's built-in full automatic calendar automatically makes allowances for different month lengths and leap years. Once you set the date, there should be no reason to change it except after the replacement of the watch's battery.

Daylight Saving Time

Use the following procedure to switch between Standard Time and Daylight Saving Time (summer time). Daylight Saving Time automatically advances the time setting by one hour from Standard Time.

To switch between Standard Time and Daylight Saving Time



- In the Timekeeping Mode, hold down the (A) button for two seconds, until the seconds digits start to flash on the display.
- Press the (B) button to toggle between Standard Time and Daylight Saving Time.
 - The indicator **DST** on the display indicates that the Home Time is set for Daylight Saving Time.
- Press the (A) button to return to the current time display.

DATA COMMUNICATION

The procedures in this section tell you how to exchange data with a personal computer running Watch Application or any of the PC link applications on the CD-ROM that comes with the watch, or with another PC-UNITE or PCX watch (Module 1510 or 1910).

Important!

See "Data Communication Precautions" for important information about orienting the watch for data communication and information about communication errors.

Communicating with a Computer

In this configuration, all of the data selection and settings are performed on the computer side. Perform the following procedure when the message "Put the watch in the data transfer mode, and point the two infrared ports towards each other." appears on the computer.

To communicate with a computer

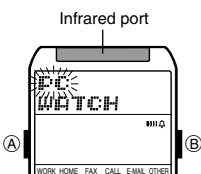

- Use (right arrow) to enter the Timekeeping Mode.
- Press the (IR) key.
- (IR) is flashing on the operation menu, so press the (right arrow) key to enter the PC Communication Mode.

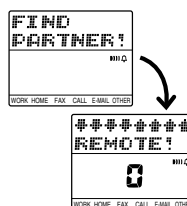

- Align infrared ports of the watch and computer, and click **OK** on the message dialog box on the computer's screen.

- The watch establishes an infrared link with the computer and data transfer starts.
- After data communication is complete, the message (IR) appears on the watch display, and then the watch changes to the Timekeeping Mode.

Interrupting Data Communication

Press the (IR) key to interrupt a data communication operation.

- Communication stops and the message **TRANSFER ERROR!** appears on the display. Press any key to return to the Timekeeping Mode.

User Data Exchange

With the following operation, the two watches exchange the data in their respective User Mode. Received data is ultimately stored in the **CONTACTS** index of the Contact Mode.

- With the M-1510 Watch, this function is called the Owner Mode instead of User Mode.
- When exchanging data with an M-1510 Watch, see the documentation that comes with the M-1510 for its required button and key operations.

To exchange User data

- Use (right arrow) to enter the Timekeeping Mode.
- Press the (IR) key.
- Press (left arrow) or (right arrow) to move the flashing to **WATCH**, and then press the (right arrow) key.
 - Note that the **WATCH** item is not shown if the watch does not have any data input in its User Mode.
- (IR) is flashing on the operation menu, so press the (right arrow) key.
- Align infrared ports of the two watches.
- The watches establish an infrared link with each other and data transfer starts.
- After data communication is complete, the message (IR) appears on the watch display, and then the watches change to the Contact Mode, showing the received data.

Communicating with Another Watch

Use the following procedures to exchange Contact, Schedule, To Do, Browser, and User data with another watch. In this configuration, one watch is the sender and the other watch is the receiver.

- User data cannot be received in the User Mode. It can be received in the Contact Mode or by performing the User Data Exchange procedure.
- This watch can send Contact, Schedule, To Do, and User Mode data one record at a time. Browser data is sent one page at a time.

To send data to another watch (sender operation)

- Enter the mode that contains the record you want to send, and display the data.
- A data communication operation cannot be performed while the Contact Mode index screen or Schedule Mode Weekly Schedule screen is on the display. Switch to a data screen before trying to send or receive data.
- When sending Browser Mode data, be sure to display the text data on the page you want to send before starting the send operation.

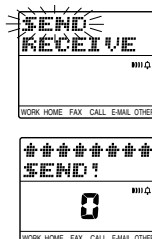

- Press the (IR) key.
- Press (left arrow) or (right arrow) to move the flashing to **WATCH**, and then press the (right arrow) key.
- (IR) is flashing on the operation menu, so press the (right arrow) key.
- Align infrared ports of the two watches.
 - The watches establish an infrared link with each other and data transfer starts.
 - After data communication is complete, the message (IR) appears on the watch display, and then the watch changes to the screen that shows the data that was sent.

To receive data from another watch (receiver operation)

- Enter the mode for the data you will be receiving.
- A data communication operation cannot be performed while the Contact Mode index screen or Schedule Mode Weekly Schedule screen is on the display. Switch to a data screen before trying to send or receive data.
- Press the (IR) key.
- Press (left arrow) or (right arrow) to move the flashing to **WATCH**, and then press the (right arrow) key.



- Press \leftarrow or \rightarrow to move the flashing to RECEIVED.
- Press the \rightarrow key to start the data receive operation.
- Align infrared ports of the two watches.
 - The watches establish an infrared link with each other and data transfer starts.
 - After data communication is complete, the message RECEIVED! appears on the watch display, and then the watch changes to the screen that shows the data that was received.

REFERENCE

This section contains more detailed and technical information about watch operations.

Changing the Text Scrolling Speed

Text is displayed in the upper part of the display. When the text is too long to fit on the display, it automatically scrolls vertically or horizontally. Use the following procedure to control the speed of the text scrolling.

To change the text scrolling speed



- In the Timekeeping Mode, press the OPTION key seven times to enter the Option Mode.
- OPTION should be flashing on the display. Press the \rightarrow key to display the scroll speed screen.
- Press \leftarrow or \rightarrow to toggle between HIGH (high speed) and LOW (low speed).
- After you are finished making the setting you want, press the \leftarrow key to return to the Option Mode.
 - Press OPTION to return to the Timekeeping Mode.

Display Contrast

Use the following procedure to adjust the relative darkness of the display figures.

To adjust display contrast



- In the Timekeeping Mode, press the OPTION key seven times to enter the Option Mode.
 - Press \leftarrow to move the flashing to CONTRAST, and then press \rightarrow .
 - Press the \leftarrow key to make display figures darker, and the \rightarrow key to make them lighter.
4. After you are finished making the setting you want, press the \leftarrow key to return to the Option Mode.
- Press OPTION to return to the Timekeeping Mode.

Input Confirmation Tone

Use the following procedure to turn the input confirmation tone on and off.

To turn the input confirmation tone on and off



- In the Timekeeping Mode, press the OPTION key seven times to enter the Option Mode.
- Press \rightarrow to move the flashing to SOUND, and then press \rightarrow .
- The sound setting is flashing on the display, so press \leftarrow or \rightarrow to execute the displayed setting.

- If the button or key confirmation tone is currently turned on, the display shows SOUND ON. If the tone is currently off, the display shows SOUND OFF.
4. After you are finished making the setting you want, press the \leftarrow key to return to the Option Mode.
- Press OPTION to return to the Timekeeping Mode.

Text Data Scrolling

Text is displayed in the upper part of the display. When the text is too long to fit on the display, it automatically scrolls vertically or horizontally. Pressing (A) stops the scrolling and displays the first block. Each subsequent press of (A) scrolls one block at a time. Automatic scrolling starts again when you press (A) while the final block of text data is on the display.

- When text scrolls vertically, eight-character lines scroll upwards on the display.

Example: Vertical scrolling of CASIO COMPUTER CO., LTD.

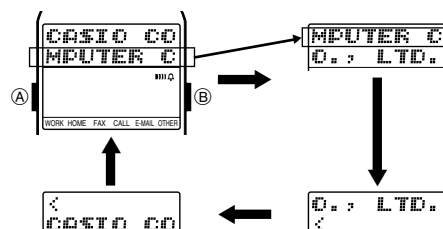

Data and Setting Scrolling

The \leftarrow , \rightarrow , \leftarrow and \rightarrow keys are used in various modes and screens to scroll through data on the display. When you are setting the time or date, or inputting text, holding down these keys scroll through the settings at high speed.

Initial Displays

When you enter the Contact, To Do, Browser, or World Time Mode, the data you were viewing when you last exited the mode appears first.

Auto Screen Operations

- The normal default mode for this watch is the Timekeeping Mode. If you leave the watch in any mode (except for the World Time and Stopwatch Modes) for two or three minutes without performing any operation, it automatically changes to the Timekeeping Mode.
- If you leave a data input or settings screen (a screen with a flashing cursor on the display for two or three minutes without performing any operation, the watch automatically saves anything you have input up to that point and exits the input or setting screen.

12-hour/24-hour Timekeeping Formats

The 12-hour/24-hour timekeeping format you select in the Timekeeping Mode is also applied in the Schedule, World Time and Alarm Modes.

- With the 12-hour format, the P (PM) indicator appears to the left of the hour digits for times in the range of noon to 11:59 pm. No indicator is shown from midnight to 11:59 am.
- With the 24-hour format, times are indicated in the range of 0:00 to 23:59, with 24 indicator.

World Time Mode Timekeeping

The following points describe how time is kept in the World Time Mode.

- World Time Zone times are calculated in accordance with the GMT (Greenwich Mean Time) differential for each zone, using the time set in the Timekeeping Mode.
- The seconds count of the World Time is synchronized with the seconds count of the Timekeeping Mode.
- The GMT differentials used by this watch are based on Universal Time Coordinated (UTC) data.

Data Communication Precautions



The following explains important points to note during data communication, and provides details about communication error messages.

Important!

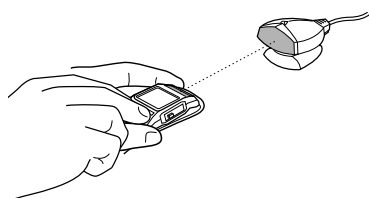
- Keep the watch and the other device perfectly still during data communication.
- Do not allow anything to break the path between the two infrared ports during data communication.
- Infrared communication may not be possible outdoors or in other areas exposed to bright light. Best results are obtained under indoor lighting of 500 lux.
- The two infrared ports should be oriented so they are no more than 20cm from each other, and are at an angle of less than 30 degrees from each other.
- Data communication at an angle greater than 15 degrees may be possible if the two infrared ports are moved closer to each other.
- Proper infrared communication may be impossible if the two infrared ports are too close to each other.
- You may need to position the infrared ports closer together when transferring large volumes of data, when performing data transfer in an area that is relatively hot, or when watch battery power is low.
- A separate nearby infrared data transfer operation can interfere with the data communication operation of this watch.
- When positioning the watch for infrared data communication, make sure you fold the band snugly underneath the watch case as shown in the illustration.



Precautions when Exchanging Data with an M-1510 Watch

- This watch can receive Telememo Mode index data from an M-1510 Watch. Received index data is stored in the Contact Mode before the **SWATCHES** index.
- This watch does not display a category icon for Schedule records received from an M-1510 Watch. When you send a Schedule record from this watch to an M-1510 Watch, the M-1510 Watch displays a category icon that looks like .
- When you send an All Day Event Schedule record to an M-1510 Watch, the M-1510 automatically adds a time of 12:00 before storing the data. Or if you originally input and later deleted a time when inputting the record, it automatically adds the time you originally input. Note that the M-1510 schedule reminder alarm also sounds in accordance with the automatically added time.
- When this watch receives a To Do record from an M-1510 Watch, this watch does not display a category icon or time (hour, minutes) for the record. When you send a To Do record from this watch to an M-1510 Watch, the M-1510 displays a category icon that looks like , and a time of --:--.
- When this watch receives Browser data that includes indexes from an M-1510 Watch, this watch does not display the indexes.
- Any character sent from an M-1510 Watch or downloaded from your computer that is not supported by this watch is replaced by .

Data Communication Errors

The following describes error messages that can appear during data communication, and what you should do to correct them.

Message	Meaning
MODEL ERROR!	The software installed on the computer does not support data communication with this watch.
TRANSFER ERROR!	The path between the infrared ports is blocked, the watch was moved, or some other external influence is interfering with proper data communication.
DATAFULL ERROR!	The receiving watch memory is full.
ERROR!	Any communication error other than the above.

Memory Capacity

Watch memory can hold a total of 24 Kbytes of data. Memory is shared between the Contact, Schedule, To Do, User, and Browser Modes. The following table shows how many data items (records, appointments, tasks, or pages) can be stored in each mode under various data conditions.

- The maximum capacity is 16 Kbytes for the Contact Mode, and 8 Kbytes for other modes.
- Note that the memory capacities in the table below are based on the premise that there is no data stored in any of the other modes.

	Data Configuration	Approximate Number of Records
Contact	Name: 8 characters (16 bytes) Telephone: 12 digits, one field only (8 bytes)	680
	Name: 10 characters (16 bytes) Telephone: 12 digits, one field only (8 bytes) Fax: 12 digits, one field only (8 bytes) Call: 12 digits, one field only (8 bytes) e-mail: 32 characters (40 bytes) Other: 10 characters (16 bytes)	170
Schedule	Date and Time: 8 bytes Description: 15 characters (16 bytes)	340
	Date and Time: 8 bytes Description: 50 characters (56 bytes)	128
To Do	Priority and Date: 8 bytes Description: 15 characters (16 bytes)	340
	Priority and Date: 8 bytes Description: 50 characters (56 bytes)	128

- The capacity of the **Browser Mode** is 8,100 characters when there is a **SWATCHSPACE** only (no user pages). If there is no data in the **SWATCHSPACE**, there can be up to 30 user pages in memory.
User Page title: 4 characters (24 bytes)
Text: Six lines with 30 characters each (192 bytes)
Each page title requires a minimum of eight bytes, plus the memory used for input characters. The above values include these minimums.
The actual number of allowable user pages depends on the number of lines of text in each page.
- There can be only one set of User Mode data in memory.

Data Fields

The following lists the data fields in each mode and shows the number of characters that can be input into each field.

Contact Mode and User Mode

Field Name	Contents
NAME	Up to 63 characters
WORK, HOME	Up to 12 numbers, spaces, hyphens
W.FAX, H.FAX	Up to 12 numbers, spaces, hyphens
CALL 1, CALL 2	Up to 12 numbers, spaces, hyphens
E-MAIL	Up to 63 characters
OTHER	Up to 63 characters

- "WORK" is for a work phone number, while "HOME" is for a home phone number.
- "W.FAX" is for a work fax number, while "H.FAX" is for a home fax number.
- The "CALL 1" and "CALL 2" fields can be used for cell phone numbers, pager numbers, etc.
- The "OTHER" field can be used for miscellaneous information.

Schedule Mode

Field Name	Contents
Description	Up to 127 characters
Date/Time	Year, month, day, hour, minutes

To Do Mode

Field Name	Contents
Description	Up to 127 characters
Priority	Value from 1 to 4, checkmark for completed tasks
Date	Year, month, day

Browser Mode

Field Name	Contents
Page Title	Downloaded from your computer
Body Text	127 characters per line

BUSY Indicator

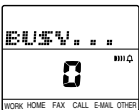
The indicator  appears on the display while the watch is accessing memory data to perform any of the following operations.

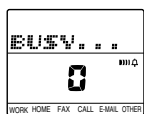

- Data input, editing, deletion
- During data recall, scrolling from the last record to the first record (or from the first record to the last record).
- Checking a finished To Do record task

Battery Precautions

The **BATT** indicator appears on the display of the watch when battery power drops below a certain level, or when you try to use this watch under very cold conditions. If the **BATT** indicator appears because of use under cold conditions, it should clear (and normal operation should return) after the watch is brought back to normal temperature. As battery power drops lower, the backlight will fail to light and display characters will become dim. Should any or all of this happen, have the battery replaced as soon as possible. Using the watch while the battery is low can result in abnormal operation. Note that all data in the watch memory is deleted when its battery is replaced. Be sure to make separate back up copies of all important data to protect against its loss.

ALWAYS LEAVE BATTERY REPLACEMENT UP TO THE DEALER WHERE YOU BOUGHT THE WATCH OR TO AN AUTHORIZED CASIO DISTRIBUTOR.

CHARACTER LIST

Upper-case alpha

A	B	C	D	E	F	G	H	I	J	K	L	M
N	O	P	Q	R	S	T	U	V	W	X	Y	Z

Lower-case alpha

a	b	c	d	e	f	g	h	i	j	k	l	m
n	o	p	q	r	s	t	u	v	w	x	y	z

Numbers

0	1	2	3	4	5	6	7	8	9
---	---	---	---	---	---	---	---	---	---

Symbols

!	"	#	\$	%	&	'	()	*	+	,	-
.	/	:	;	<	=	>	?	@	[\]	^
_	`	{		}	~							

CITY CODE TABLE

City Code	City	GMT Differential	Other major cities in same time zone
---		-11	PAGO PAGO
HNL	HONOLULU	-10	PAPETE
ANC	ANCHORAGE	-09	NOME
LAX	LOS ANGELES	-08	SAN FRANCISCO, LAS VEGAS, VANCOUVER, SEATTLE, DAWSON CITY
DEN	DENVER	-07	EL PASO, EDMONTON
CHI	CHICAGO	-06	HOUSTON, DALLAS/FORT WORTH, NEW ORLEANS, MEXICO CITY, WINNIPEG
NYC	NEW YORK	-05	MONTREAL, DETROIT, MIAMI, BOSTON, PANAMA CITY, HAVANA, LIMA, BOGOTA
CCS	CARACAS	-04	LA PAZ, SANTIAGO, PORT OF SPAIN
RIO	RIO DE JANEIRO	-03	SAO PAULO, BUENOS AIRES, BRASILIA, MONTEVIDEO
---		-02	
---		-01	PRAIA
GMT		+00	DUBLIN, LISBON, CASABLANCA, DAKAR, ABIDJAN
LON	LONDON		
PAR	PARIS	+01	MILAN, ROME, MADRID, AMSTERDAM, ALGIERS, HAMBURG, FRANKFURT, VIENNA, STOCKHOLM, BERLIN
CAI	CAIRO	+02	ATHENS, HELSINKI, ISTANBUL, BEIRUT, DAMASCUS, CAPE TOWN
JRS	JERUSALEM		
JED	JEDDAH	+03	KUWAIT, RIYADH, ADEN, ADDIS ABABA, NAIROBI
THR	TEHRAN	+3.5	SHIRAZ
DXB	DUBAI	+04	ABU DHABI, MUSCAT
KBL	KABUL	+4.5	
KHI	KARACHI	+05	MALE
DEL	DELHI	+5.5	MUMBAI, CALCUTTA
DAC	DHAKA	+06	COLOMBO
RGN	YANGON	+6.5	
BKK	BANGKOK	+07	JAKARTA, PHNOM PENH, HANOI, VIENTIANE
HKG	HONG KONG	+08	SINGAPORE, KUALA LUMPUR, BEIJING, TAIPEI, MANILA, PERTH, ULAANBAATAR
TYO	TOKYO	+09	SEOUL, PYONGYANG
ADL	ADELAIDE	+9.5	DARWIN
SYD	SYDNEY	+10	MELBOURNE, GUAM, RABAU
NOU	NOUMEA	+11	PORT VILA
WLG	WELLINGTON	+12	CHRISTCHURCH, NADI, NAURU ISLAND

* Based on data as of June 1999.

Free Manuals Download Website

<http://myh66.com>

<http://usermanuals.us>

<http://www.somanuals.com>

<http://www.4manuals.cc>

<http://www.manual-lib.com>

<http://www.404manual.com>

<http://www.luxmanual.com>

<http://aubethermostatmanual.com>

Golf course search by state

<http://golfingnear.com>

Email search by domain

<http://emailbydomain.com>

Auto manuals search

<http://auto.somanuals.com>

TV manuals search

<http://tv.somanuals.com>