

ORIGINAL

DIGITAL SAMPLING SYNTHESIZER

FZ-1

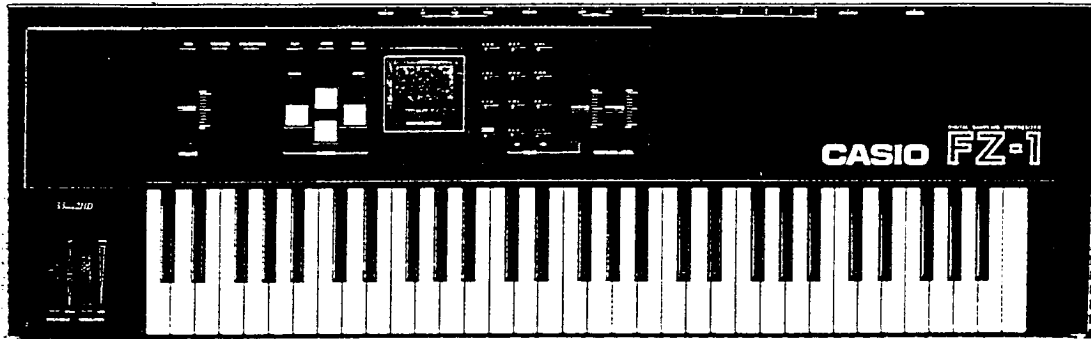

OPERATION MANUAL  
MANUAL DE OPERACION

CASIO®

JANUÁRIO

Thank you for purchasing the Casio FZ-1 Digital Sampling Synthesizer. The FZ-1 is an entirely new type of digital keyboard, which features outstanding sampling quality, as well as digital synthesis capabilities. To obtain optimum performance and assure long-term reliability, be sure to read this manual carefully before using your new FZ-1.

## MAIN FEATURES

---

- High quality sampling synthesizer features a sampling rate of 36kHz, and the first 16-bit linear sampling resolution in its class.
- Sampling time at 36kHz is 14.5 seconds (29.1 seconds at 18kHz, 58.2 seconds at 9kHz). Sampling time at 36kHz can be expanded to 29.1 seconds through the use of an optional memory expansion (RAM board MB-10).
- Features a wide graphic LCD which allows monitoring of waveforms. Waveforms can be edited in real time without the use of an external device such as a personal computer.
- A total of 64 basic voice memory areas are built-in for storage of basic waveforms created through sampling or synthesis. After initial creation, such parameters as amp envelope and loop can be independently set for each voice memory. Up to 8 separate keyboard setups (including keyboard split and other keyboard data) can be stored in onboard Banks, each of which may contain up to 64 areas.
- Features a built-in 3.5 inch 2HD floppy disk drive allowing convenient data save and load operations.
- MIDI compatible, plus the ability to independently set each voice to separate MIDI channels.
- Features a 25-pin port for direct data communication with other FZ-1 units.

# CONTENTS

<b>GENERAL GUIDE — FRONT PANEL</b> .....	4	<b>III. MIX WRITE</b> .....	39
<b>CONNECTING EXTERNAL DEVICES</b>		A) DEFINE VOICE .....	40
— REAR PANEL .....	6	B) VOICE SELECT .....	41
<b>USING THE FLOPPY DISK DRIVE</b> .....	8	C) KEYBOARD SET .....	42
		D) LEVEL SET .....	43
<b>SECTION 1: MODES &amp; BASIC OPERATIONS</b> .....	10	E) DELAY TIME .....	44
I. FZ-1 MODE TRANSITION DIAGRAMS .....	10	F) DETUNE .....	45
II. SUMMARY OF MODES .....	10	G) EXECUTE MIX .....	46
III. USING THE CURSOR, ENTER &		<b>IV. CROSS-MIX WRITE</b> .....	47
ESCAPE KEYS .....	12	A) DEFINE VOICE .....	47
IV. PRACTICE EXERCISE .....	12	B) VOICE SELECT .....	48
V. USING THE VALUE SLIDER, VALUE KEYS &		C) KEYBOARD SET .....	49
TEN-KEYS .....	13	D) LEVEL SET .....	50
VI. BASIC OPERATION .....	14	E) DELAY TIME .....	51
		F) DETUNE .....	52
<b>SECTION 2: PLAY MODE</b> .....	17	G) CROSS ZONE .....	53
I. SELECTING THE PLAY MODE .....	17	H) EXECUTE X-MIX .....	55
II. LOADING DISK DATA .....	17	<b>V. REVERSE WRITE</b> .....	56
III. SETTING THE BANK NUMBER .....	18	A) DEFINE VOICE .....	57
IV. SETTING THE VOICE NUMBER .....	19	B) VOICE SELECT .....	58
V. MASTER TUNING .....	19	C) KEYBOARD SET .....	58
VI. KEY TRANSPOSE .....	20	D) EXECUTE REVERSE .....	60
VII. PITCH BEND .....	21		
VIII. MODULATION WHEEL .....	21	<b>SECTION 4: VOICE EDIT SUB-MODE</b> .....	61
IX. FOOT SWITCH .....	21	I. DEFINE VOICE .....	61
X. FOOT VARIABLE RESISTANCE .....	21	II. CREATE VOICE .....	63
XI. CALL/SET MENU .....	21	A) TRUNCATE .....	63
		B) DCA ENVELOPE .....	66
<b>SECTION 3: SOURCE SELECT SUB-MODE</b> .....	22	C) DCF ENVELOPE .....	67
I. SAMPLING .....	22	D) LOOP SET .....	69
A) DEFINE VOICE .....	24	SET START POINT .....	69
B) KEYBOARD SET .....	25	SET END POSITION .....	70
C) LEVEL SET .....	26	SET LOOP & CROSS-FEED TIMES .....	70
D) LENGTH SET .....	27	SPECIFY NEXT LOOP .....	71
E) AUTO SAMPLING .....	28	E) LFO SET .....	72
F) MANUAL SAMPLING .....	29	F) VELOCITY SENSITIVITY .....	73
II. WAVE SYNTHESIS .....	31	G) TUNE/MEMORY — READ .....	74
A) DEFINE VOICE .....	31	<b>III. KEYBOARD SET</b> .....	75
B) KEYBOARD SET .....	32	<b>IV. DUMP VOICE</b> .....	77
C) PRESET WAVE .....	33	<b>V. COPY VOICE</b> .....	77
D) SINE SYNTHESIS .....	34	<b>VI. DELETE VOICE</b> .....	79
E) CUT SAMPLE .....	35	<b>VII. REPLACE VOICE</b> .....	80
F) HAND DRAWING .....	37		

---

<b>SECTION 5: BANK EDIT SUB-MODE</b> .....	<b>82</b>
I. DEFINE BANK .....	83
II. CREATE BANK .....	84
III. DUMP BANK .....	86
IV. COPY BANK .....	86
V. DELETE BANK .....	88
VI. DELETE AREA .....	89
VII. REPLACE BANK .....	90
<b>SECTION 6: EFFECT/MIDI SUB-MODE</b> .....	<b>92</b>
I. BEND RANGE .....	92
II. MODULATION WHEEL .....	93
III. AFTER TOUCH .....	94
IV. FOOT VARIABLE RESISTANCE .....	96
V. MIDI FUNCTIONS .....	97
VI. DUMP EFFECT .....	99
<b>SECTION 7: DATA DUMP SUB-MODE</b> .....	<b>100</b>
I. FULL DUMP .....	101
II. BANK DUMP .....	107
III. VOICE DUMP .....	113
IV. EFFECT DUMP .....	119
V. SELECT DEVICE .....	123
VI. FORMAT DISK .....	126
<b>SECTION 8: OPTIONAL SOFTWARE</b> .....	<b>128</b>
<b>SECTION 9: ERROR MESSAGES</b> .....	<b>129</b>
<b>CARE OF YOUR UNIT</b> .....	<b>130</b>
<b>SPECIFICATIONS</b> .....	<b>132</b>

# GENERAL GUIDE — FRONT PANEL

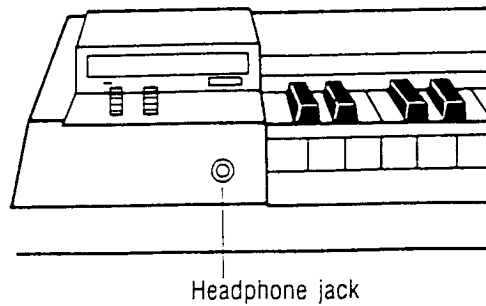
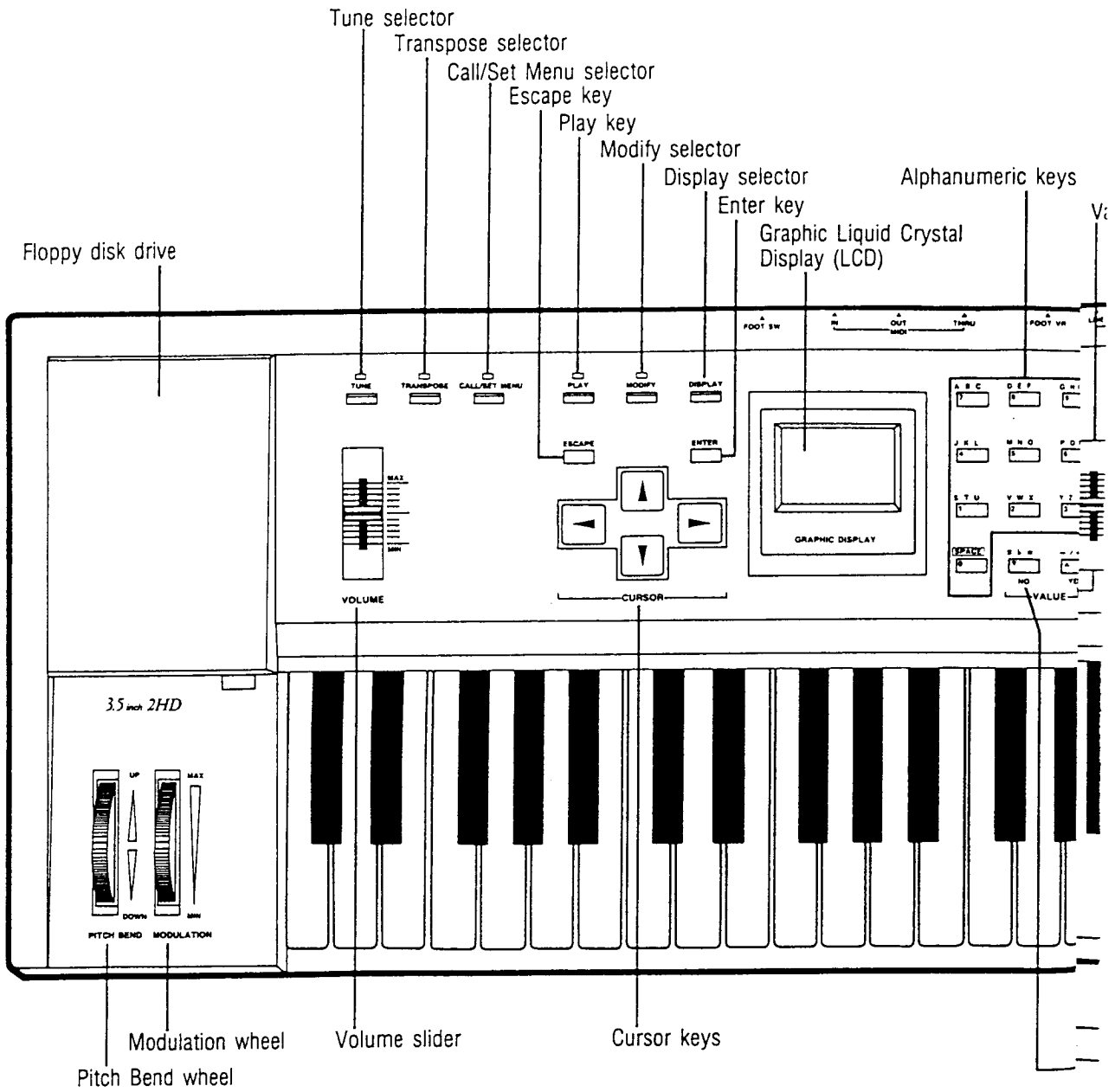

Value slider

Sampling Level slider

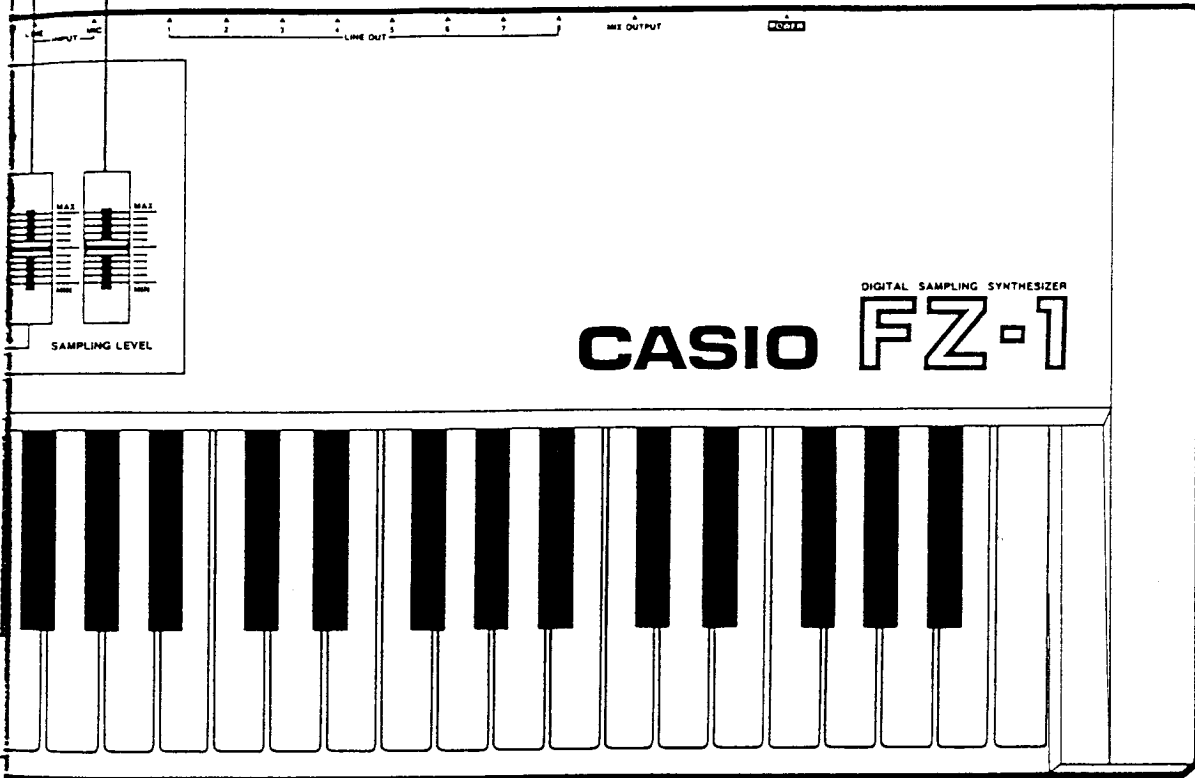

Yes key

No key

# CONNECTING EXTERNAL DEVICES — REAR PANEL

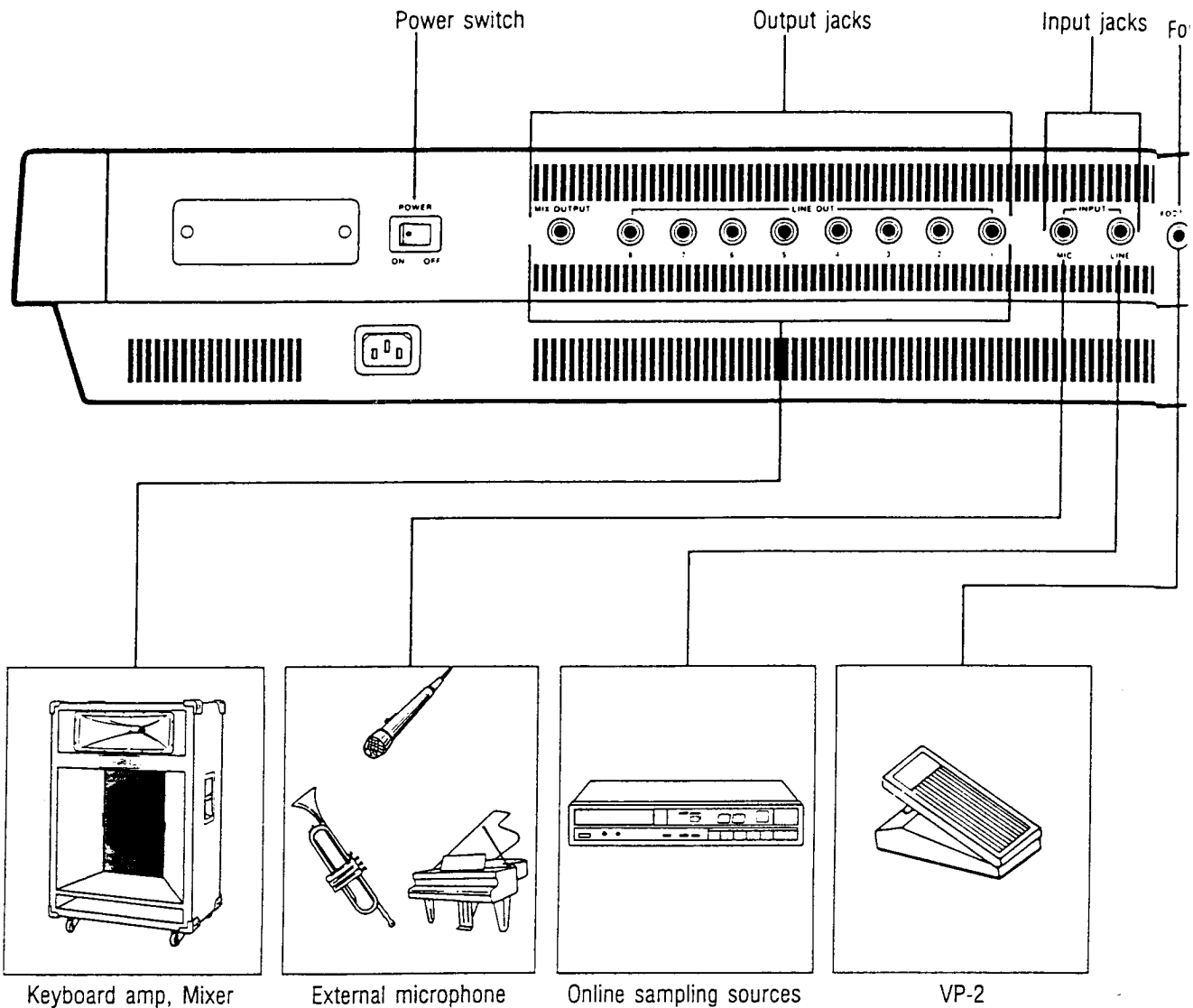



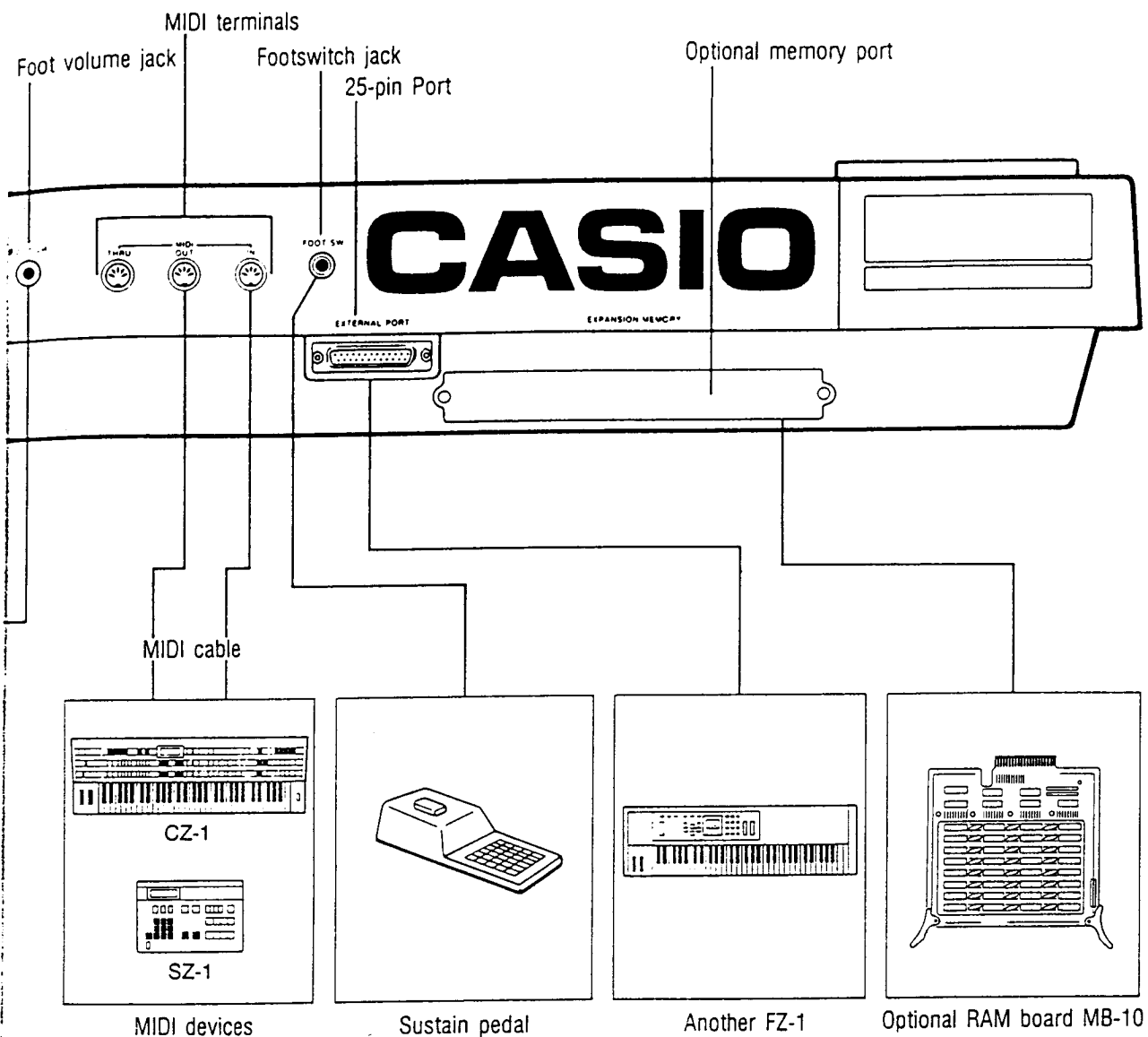

**CAUTION:**  
 Please note that the 25-pin Port is not a normal RS-232C terminal, and therefore cannot be used with a conventional RS-232C cable.

# USING THE FLOPPY DISK DRIVE

Your FZ-1 is equipped with a floppy disk drive which is used to drive 3.5" floppy disks for convenient storage of sound data.

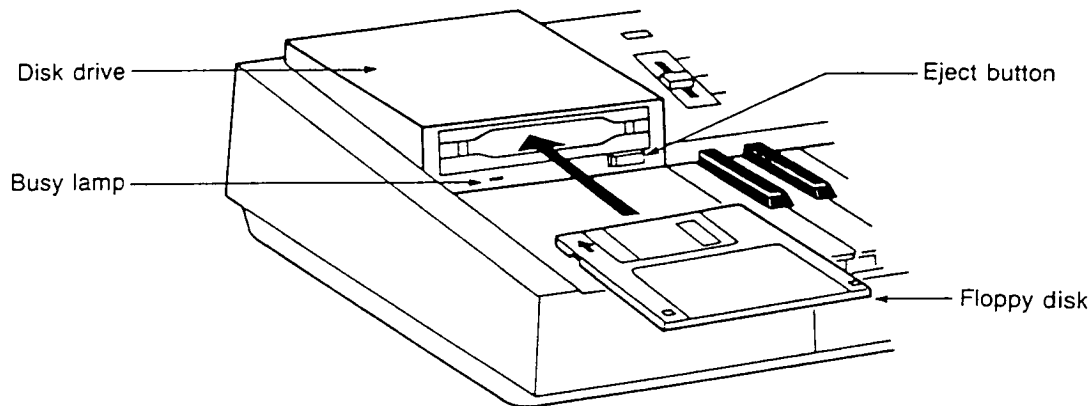

## BUSY LAMP

This LED indicator lights during disk access.

## DISK DRIVE

Insert floppy disks here.

## EJECT BUTTON

Press this button to remove a disk from the drive.

## ■ Inserting a Floppy Disk

Insert the disk into the drive slot with the label facing UP. Push it in until you hear a click indicating that the disk is fully inserted.

## ■ Removing a Floppy Disk

- ① Confirm that the busy indicator lamp is off.  
Never remove a disk or turn off power while the busy indicator is illuminated. Doing so may damage the disk and cause you to lose valuable sound data.
- ② Press the Eject button and remove the disk.

## NOTE

Be sure to insert floppy disks gently, straight into the disk drive slot.

## ■ About Floppy Disks

The FZ-1 uses 3.5-inch Double Sided, High Density, Double Track 135TPI micro-floppy disks. These type of disks are typically labeled "MFD2HD."

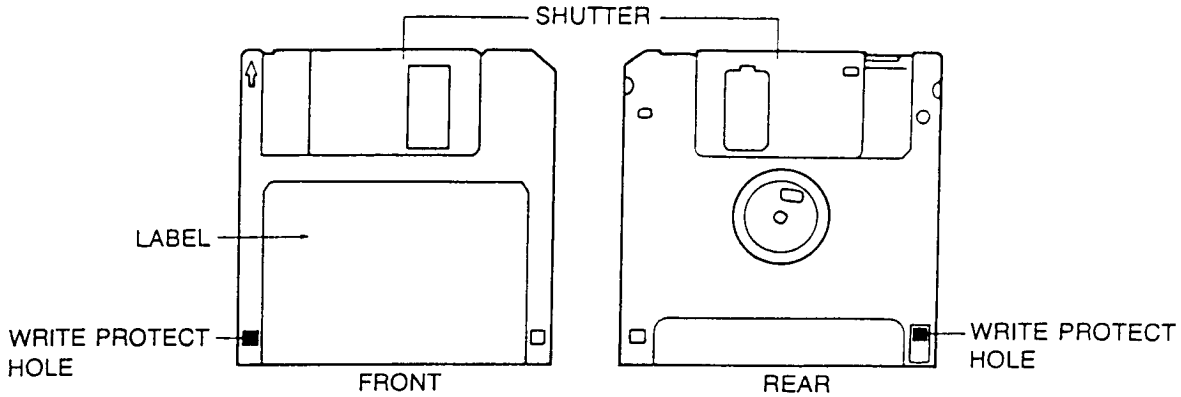

### WRITE PROTECT HOLE

Used to protect data already input on disk.

### SHUTTER

Protects magnetic disk housed in plastic shell.

## • Formatting Disks

Before using a newly purchased floppy disk, it must be formatted. This procedure prepares the disk for use in the FZ-1. For details on how to format disks, refer to "Formatting Disks" in Section 7 of this manual.

## • Care of Floppy Disks

- \*Never store disks where they will be exposed to high temperature, high humidity, direct sunlight, dust or dirt.
- \*Never open the disk shutter. Doing so may expose the magnetic disk to dust, dirt and scratches which may prevent the correct reading or writing of data.
- \*Never transport your FZ-1 while a disk is in the disk drive.
- \*Keep floppy disks away from sources of magnetism, such as speakers, TV sets, transformers, telephones and magnets. Magnetic fields may erase the data on your disk.

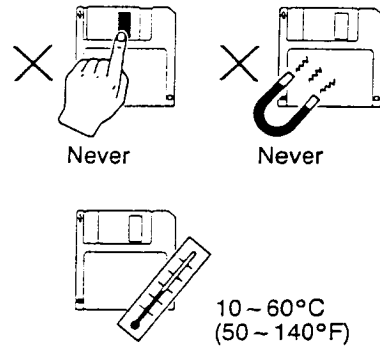

## ■ About the write protect hole

3.5" micro-floppy disks feature a "write protect hole" which prevents you from erasing or altering disk data when open. Slide the tab to open or close the hole as necessary to prevent accidental data loss or make changes in data.

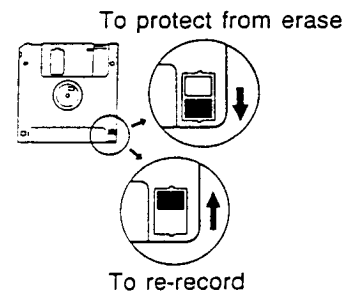

## ■ Backup copies

It's always best to make backup copies of important disks. Be sure to store these copies separately.

# MODES & BASIC OPERATIONS

## I. FZ-1 MODE TRANSITION DIAGRAMS

Throughout this manual you will find Mode Transition Diagrams, such as the one shown below.

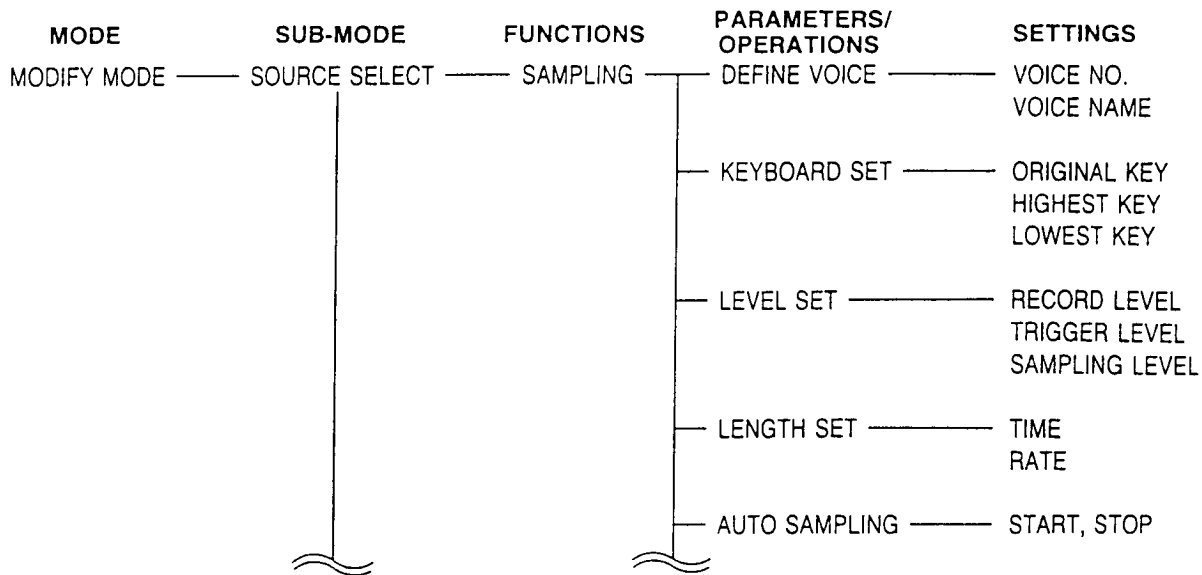

These diagrams are extremely useful aids in understanding the transitions made in FZ-1 operations. You will note that the diagrams break FZ-1 operations down into 4 basic categories — Modes, Sub-modes, Functions and Parameters/Operations. These correspond to the MENUs which may be called up on the FZ-1 display.

## II. SUMMARY OF MODES

### MODES

At the extreme left of the diagrams are listed operational MODES. The FZ-1 features 2 such basic modes, the PLAY Mode and the MODIFY Mode.

### SUB-MODES

Within the Modify Mode, there are 6 Sub-modes.

These include the SOURCE SELECT Sub-mode, the VOICE EDIT Sub-mode, the BANK EDIT Sub-mode, the EFFECT/MIDI Sub-mode, the DATA DUMP Sub-mode and the OPTION SOFTWARE Submode.

### FUNCTIONS

Next in the hierarchal order of transition are FUNCTIONS. The PLAY Mode features 3 different Functions, however there are several Functions within each Sub-mode of the Modify Mode. The following example shows the Functions within the Source Select Sub-mode.

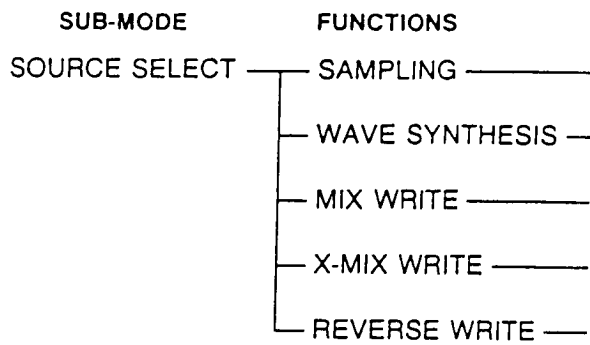

Notice that there are 5 different Functions within the Source Select Sub-mode. The number of Functions varies with each Sub-mode.

## PARAMETERS/OPERATIONS

Within each Function are various Parameters and Operations. Note that some of these are Parameters, which affect the characteristics of the sound, while others are Operations or switches used in turning functions on and off, etc.

The following example shows the Parameters/Operations within the WAVE SYNTHESIS Function, in the SOURCE SELECT Sub-mode of the MODIFY Mode.

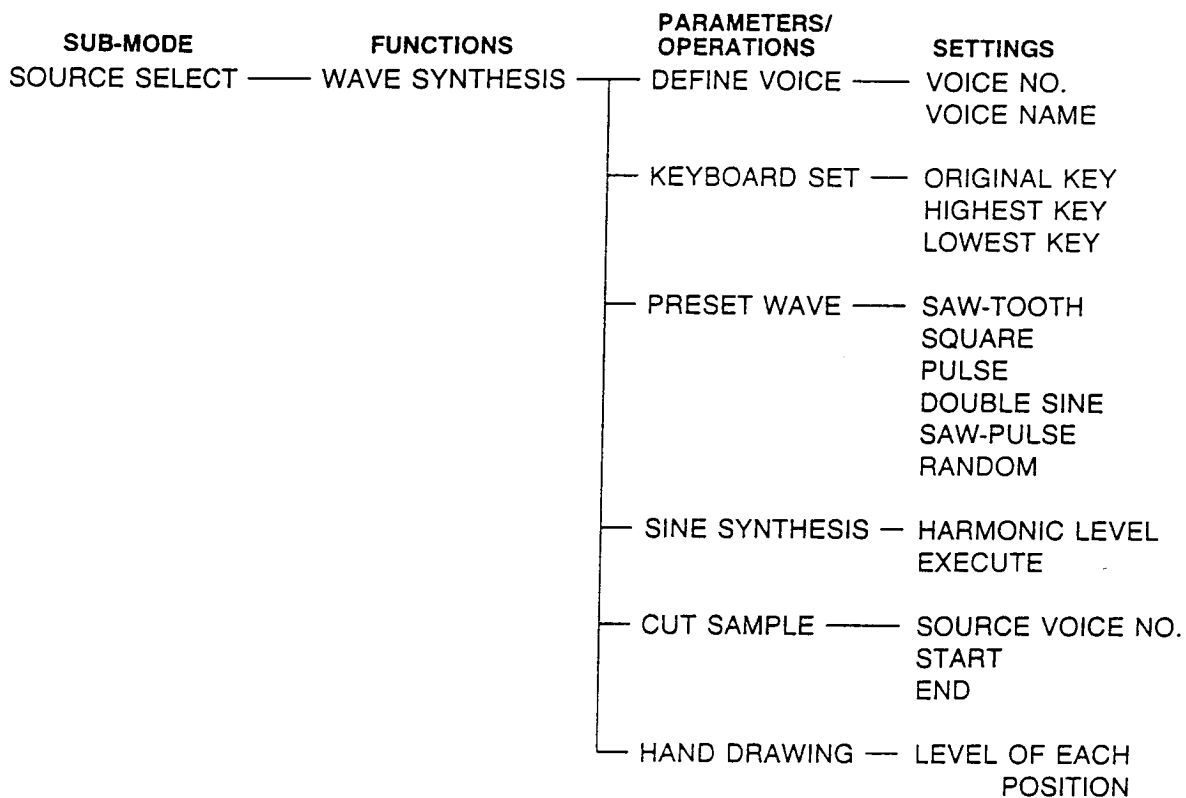

### III. USING THE CURSOR, ENTER & ESCAPE KEYS

These keys, in combination with the Mode Transition Diagrams, are vital elements of FZ-1 operation. The Cursor, Enter & Escape keys are used to move in and out of each level of transition, as illustrated in the Mode Transition Diagrams found in each section of this manual. As the diagrams suggest, to set — for example — a Parameter, you must first enter the appropriate Mode, Sub-mode and Function.

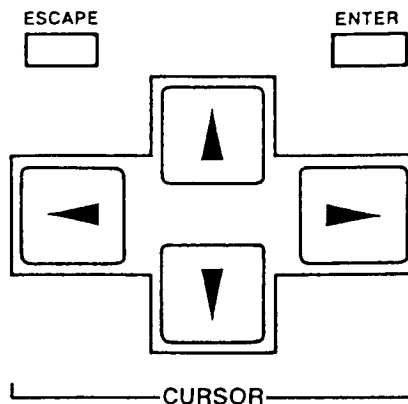

### IV. PRACTICE EXERCISE (DO THIS!!)

The following practice exercise will familiarize you with how to use the Cursor keys, Enter key and Escape key to move freely in and out of each level of the FZ-1 operational hierarchy.

**Objective:** To specify a Pulse Wave in the Preset Wave Parameter of the Wave Synthesis Function.

<p>(1) Enter the Modify Mode by pressing the Modify selector.</p>		<pre> MAIN MENU =[SOURCE SELECT] [VOICE EDIT] [BANK EDIT] [EFFECT/MIDI ] [DATA DUMP] [OPT SOFTWARE]         </pre>
<p>(2) Enter the Source Select Sub-mode by moving the Cursor with the Cursor [▲] key so that SOURCE SELECT is specified and pressing the Enter key. (Already in this position when Modify Mode is first selected.)</p>		<pre> SOURCE SELECT =[SAMPLING ] [WAVE SYNTH] [MIX WRITE] [X-MIX WRITE] [REVERSE WRITE]         </pre>
<p>(3) Enter the Wave Synthesis Function by moving the Cursor with the Cursor keys so that WAVE SYNTHESIS is selected and pressing the Enter key.</p>		<pre> WAVE SYNTH =[DEFINE VOICE] [KEYBOARD SET] [PRESET WAVE] [SIN SYNTHESIS] [CUT SAMPLE] [HAND DRAWING]         </pre>
<p>(4) Enter the Preset Wave Parameter/Operation by moving the Cursor with the Cursor keys so that PRESET WAVE is selected and pressing the Enter key.</p>		<pre> PRESET WAVE - VOICE No.02 - (SYNTH-DRUM ) - NO SOUND - - PRESET WAVE - =         </pre>

Now, notice that you have a choice of operation at this level. To specify a Pulse Wave (our objective), simply move the Value slider so that PULSE is selected.

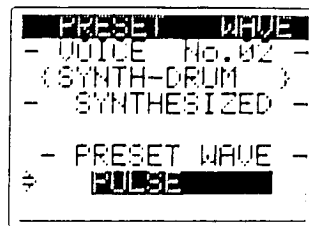
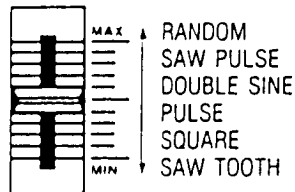

This completes the setting of this Parameter/Operation. You're now ready to exit from this level by pressing the Escape key. Each time you press the Escape key, you will move back "up" the operational hierarchy — from Parameter/Operation to Function, and from Function to Sub-mode.

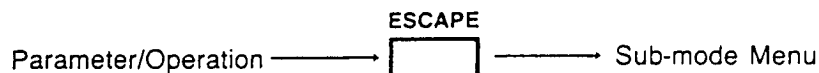

Practice this exercise until you understand these relationships thoroughly, as they are a key to FZ-1 operation. Be sure to refer to the Transition Diagrams if you have any questions about operational transition when using your FZ-1.

## V. USING THE VALUE SLIDER, VALUE KEYS & TEN-KEYS

Many FZ-1 operations require the use of the ten-keys, Value slider and Value keys. These are used to specify numeric values, as well as in assigning names and numbers to Banks and Voices. Note that the YES and NO keys are also known as the Value keys. Often when using these keys, you may find it convenient to approximate a certain value with the Value slider, and use the Value keys to adjust the value more precisely.

When any operation requiring the input of a numeric value is selected with the cursor, the ten-keys will operate as number keys only.

Notice that there are also three letters assigned to each number key. When the input of a name (characters) is required, the keys can be used to specify both letters and numbers.

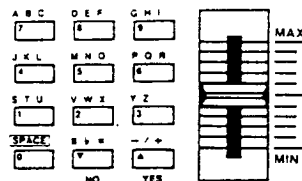

Pressing the keys once selects the first letter (character), pressing it twice selects the second, and pressing it a third time selects the last letter. If you press it a fourth time, the corresponding number is selected.

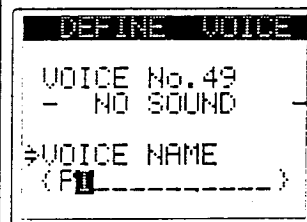
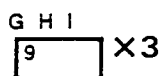

To input the next character or alter characters which have already been specified, simply move the cursor with the Cursor keys.

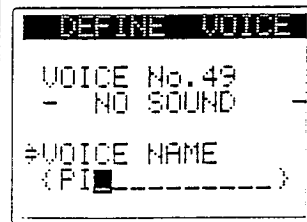

## VI. BASIC OPERATION

### A) PRELIMINARY SETUP

- (a) Before plugging the FZ-1 in, make sure the Power switch is turned OFF, and power is OFF on all peripheral equipment.
- (b) Use the supplied AC cord to connect the FZ-1 to an AC outlet.
- (c) Connect the FZ-1 to amps, mixing consoles, sampling sources, etc.
- (d) Turn down the volume all the way on the FZ-1, as well as on connected amps, mixers, and other equipment. Then turn on the power on the FZ-1 and peripheral equipment.

### B) BASIC OPERATION

#### (1) CREATING VOICES

The FZ-1 features a total of 5 different methods of voice creation, based on sampling and wave synthesis. These include the following.

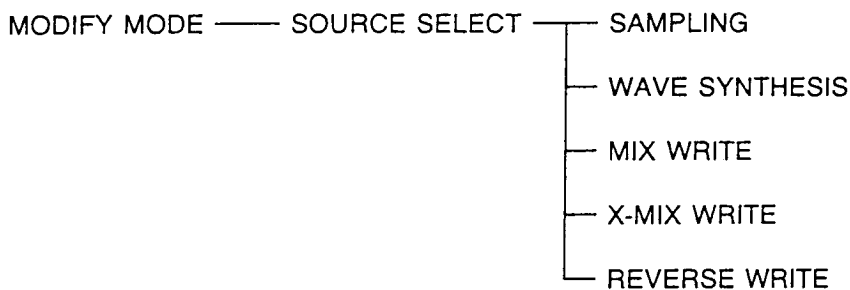

#### SAMPLING

The FZ-1 features 16 bit linear sampling, at three selectable sampling rates — 36kHz, 18kHz and 9kHz. Sampling time may be set freely, with a maximum sampling time of 14.56 seconds at 36kHz.

#### WAVE SYNTHESIS

Wave Synthesis allows the creation of voices through 6 preset waves, sine (additive) synthesis, cutting samples, and hand drawing of waveforms.

#### MIX WRITE

Using Mix Write, 2 different voices already created may be mixed to create a new voice. This method also allows the detuning of voices.

#### X-MIX WRITE

Cross Mix writing allows the cross mixing of 2 different voices which have already been created. Voices may also be detuned with this method.

#### REVERSE WRITE

Through Reverse Write, a voice created through sampling or synthesis may be rewritten in reverse. Refer to Section 2 for further details on creating voices in the Source Select Sub-mode.



## (2) EDITING VOICES

Once the "raw" voice materials have been created, they can be edited through the Voice Edit Sub-mode. This process includes Truncating voices, setting DCA and DCF envelopes, setting Loops and LFOs, Velocity Sensitivity and other parameters that affect each voice.

Refer to Section 3 for further information on Voice Edit operations.

## (3) CREATING BANKS

Once voices have been created using any of the 5 different methods, they can be assigned to BANKs. The FZ-1 features 8 different BANKs, each capable of storing up to 64 voices. Each voice which is assigned to a BANK is assigned an AREA number. In other words, each BANK holds up to 64 different AREAs, with each AREA containing a voice.

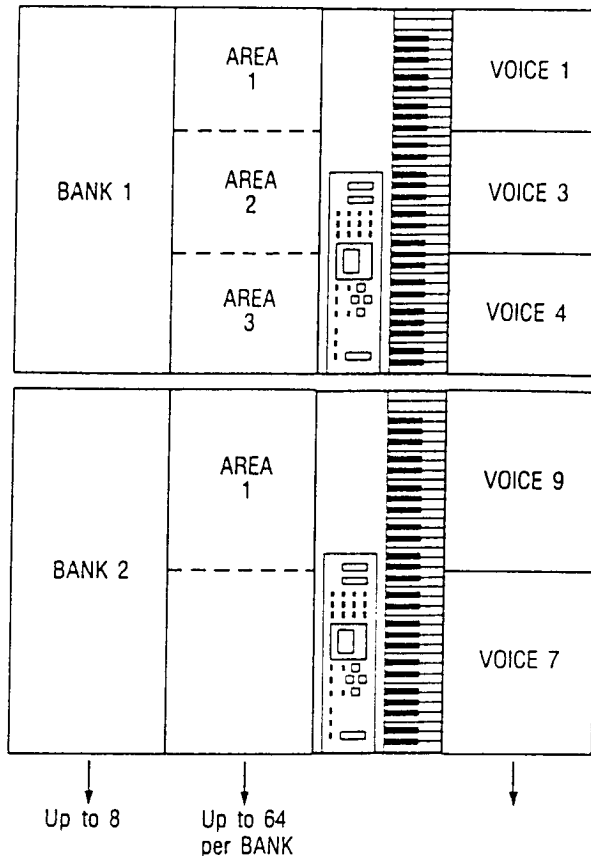

Each Bank is actually a separate keyboard setup, as it may be programmed with data for utilization of Keyboard Split and Velocity Split functions, for assignment of different voices throughout the keyboard. Refer to Section 4 for further information on Banks.

## C) DATA MANAGEMENT

The basic key to taking advantage of the FZ-1's outstanding voice creation potential is skillful data management. Basically speaking, Voice, Bank and Effect data is transferred for storage on floppy disks through data SAVE operations. Data which is stored on floppy disk may then be transferred back into the FZ-1 through LOAD operations.

### •FZ-1 MEMORY BASICS

First of all, there are some terms which you should become familiar with in order to understand this manual and FZ-1 operations.

You're undoubtedly familiar with the meaning of "VOICE." This is any sound which you create through sampling or synthesis with the FZ-1. FZ-1 VOICES can be assigned to AREAs in the FZ-1 memory. These AREAs are further assigned to BANKs, which are the equivalent of separate keyboard setups. The FZ-1 is capable of storing up to 8 BANKs, each containing up to 64 AREAs. For further information on Data Management procedures, refer to Section 7: Data Dump Sub-mode.

## D) PERFORMANCE

Once data is loaded into the FZ-1, it operates much like any conventional sampling keyboard or synthesizer, and features a pitch bending wheel as well as a modulation wheel. Refer to Section 2 for information on performance in the Play Mode.

# SECTION 2: PLAY MODE

PLAY MODE — BANK PLAY  
 — VOICE PLAY  
 — LOAD EXECUTE

In the Play Mode, data is loaded from disks, after which you can select individual Voices or entire programmed Banks for performance.

## I. SELECTING THE PLAY MODE

To select the Play Mode, press the Play Mode selector.

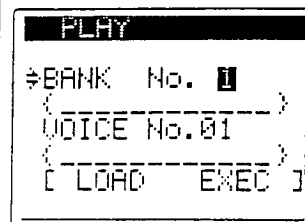

## II. LOADING DISK DATA

In the PLAY Mode, data which has been saved to floppy disk can be loaded into the FZ-1 through the following operation.

(1) Insert accessory disk FL-A into floppy disk drive.

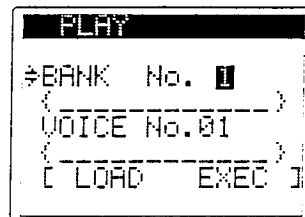
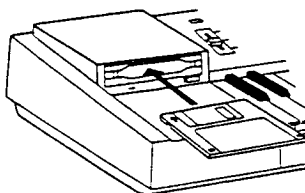

(2) Move cursor so that LOAD EXECUTE is selected.

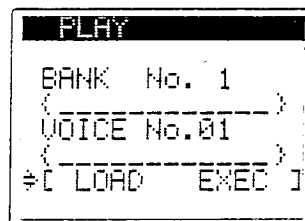

(3) Press the ENTER key.

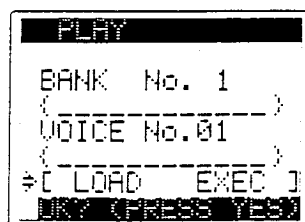

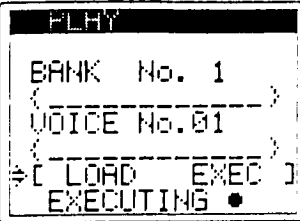
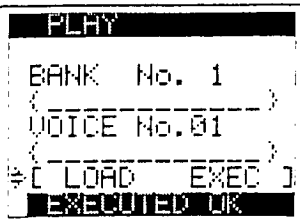

<p>(4) Press the YES key. Wait approximately 1 minute for data to load into FZ-1.</p>	<p style="text-align: center;">- / + ▲ YES</p>	 <pre> PLAY BANK No. 1 ( VOICE No. 01 ) ( LOAD EXEC ) EXECUTING ● </pre>
<p>An EXECUTED OK message indicates that data has been successfully loaded into the FZ-1.</p>		 <pre> PLAY BANK No. 1 ( VOICE No. 01 ) ( LOAD EXEC ) EXECUTED OK </pre>

**NOTE**

When LOAD EXECUTE is performed in the PLAY Mode, all data from the inserted disk is loaded, even if a device other than the disk is selected in the SELECT DEVICE Function of the DATA DUMP Sub-mode.

**III. SETTING THE BANK NUMBER**

<p>(1) Move cursor so that BANK No. is selected.</p>	<p style="text-align: center;">▲</p>	 <pre> PLAY ⇒BANK No. 1 ( PIANO 1 ) VOICE No. 01 ( PIANO 1 CZ 1 ) [ LOAD EXEC ] </pre>
<p>(2) Specify BANK No. with ten-keys.</p>	<p style="text-align: center;">S T U 1</p>	 <pre> PLAY ⇒BANK No. 1 ( PIANO 1 ) VOICE No. 01 ( PIANO 1 CZ 1 ) [ LOAD EXEC ] </pre>

**NOTES**

- \*Bank play is selected automatically after a [LOAD EXEC] operation is completed. Voice play is selected when cursor is in VOICE No. position or [LOAD EXEC] position, prior to Load execution.
- \*In initialized state, Bank No. 1 is selected.

## IV. SETTING THE VOICE NUMBER

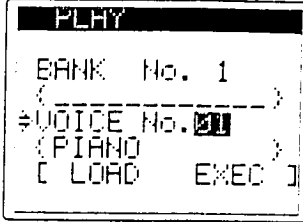
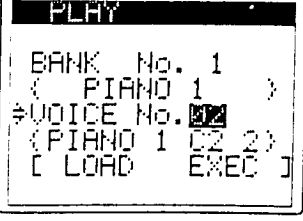

<p>(1) Move cursor so that VOICE No. is selected.</p>		
<p>(2) Specify VOICE No. with ten-keys.</p>	<p>SPACE + V W X</p> <p>0 + 2</p>	

### NOTE

In initialized state, Voice No. 01 is selected.

## V. MASTER TUNING

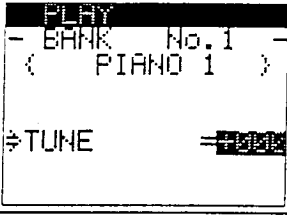
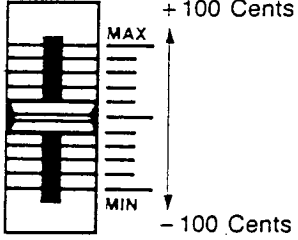
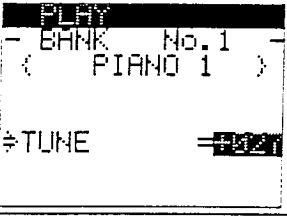
The FZ-1 features Master Tuning, which may be adjusted within a  $\pm 100$  cent range.

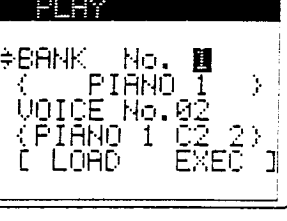

<p>(1) Move the cursor to the BANK position and press the TUNE selector.</p>		
<p>(2) Adjust tuning with Value slider or ten keys.</p>		
<p>(3) Press the Tune selector once again to return to normal PLAY Mode (or whatever mode you were in.)</p>		

### NOTES

- \*Tuning affects all Banks.
- \*Initialized Master Tuning value is 00.
- \*Master Tuning is effective until altered, or until power is turned OFF.

## VI. KEY TRANSPOSE

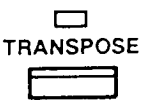
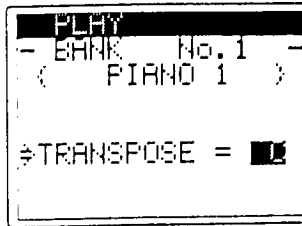
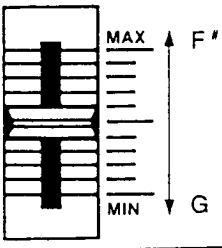
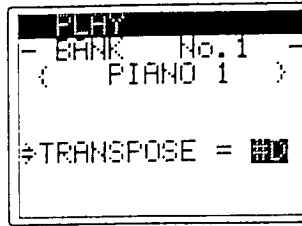
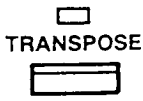
The Key Transpose function allows you to transpose within a C = G-F# range (down to G, up to F#).

<p>(1) Press the Transpose selector.</p>		
<p>(2) Adjust key with Value slider.</p>		
<p>(3) Press the Transpose selector once again to return to normal PLAY Mode (or whatever mode you were in.)</p>		

### NOTES

- \*Transposition affects all Banks.
- \*Initialized Key Transpose value is "C".
- \*Key Transpose is effective until altered, or until power is turned OFF.
- \*Keyboard Set positions are not affected by Key Transpose setting (only pitch is affected).

## **VII. PITCH BEND**

The Pitch Bend Wheel may be used to control pitch bend according to the Bend Range value set in the EFFECT/MIDI Sub-mode. Initialized Pitch Bend value is  $\pm 3$  half tones.

## **VIII. MODULATION WHEEL**

The Modulation Wheel may be used to control modulation according to LFO and other parameters set in the EFFECT/MIDI Sub-mode.

## **IX. FOOT SWITCH**

A foot switch may be connected for control of the sustain function.

## **X. FOOT VARIABLE RESISTANCE**

A foot pedal may be used to control the depth of LFO, DCA and DCF effects set in the EFFECT/MIDI Sub-mode.

## **XI. CALL/SET MENU**

The Call/Set Menu function allows you to exit any level in the MODIFY Mode to the PLAY Mode, and return automatically to the same position without entering each level of the operational hierarchy. By pressing the Call/Set Menu selector, the last position you were in while in the MODIFY Mode is entered into memory. You can now exit to the PLAY mode. To return to the former position in the MODIFY Mode, simply press the Call/Set Menu selector again.

## SECTION 3:

# SOURCE SELECT SUB-MODE

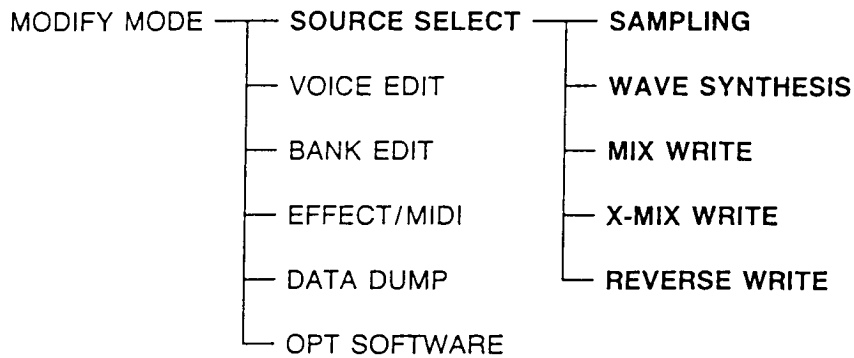

The Source Select Sub-mode may be selected from the Modify Mode menu. To access the Modify Mode menu, press the MODIFY selector.

Within the Source Select Sub-mode are 5 Functions, corresponding to the 5 ways of creating voices on the FZ-1.

This Section contains five parts, as listed below.

- I. Sampling
- II. Wave Synthesis
- III. Mix Write
- IV. Cross Mix Write
- V. Reverse Write

## I. SAMPLING

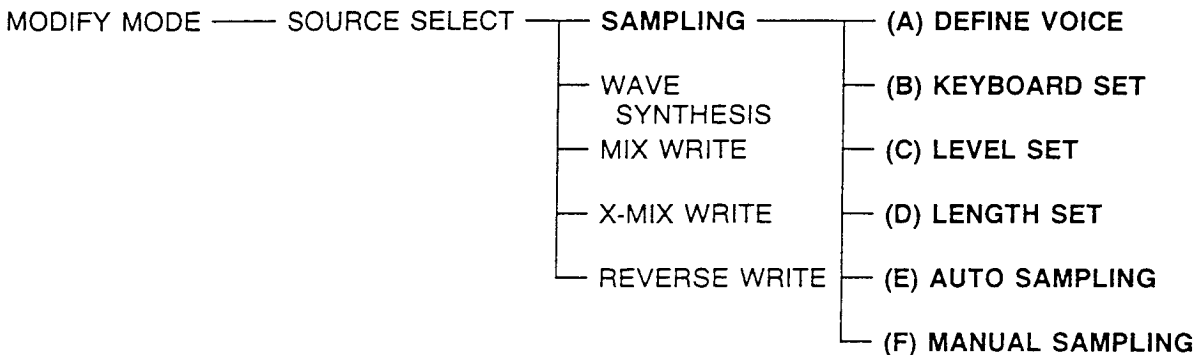



## ■ About Sampling

Sampling allows you to take a sound signal from an external sound source and store its waveform data in the FZ-1 memory. The sampled sound may become the raw material for synthesis, or it can be used as it is. Sampling is especially useful in reproducing real musical instrument sounds. It accurately reproduces complex harmonic changes, such as those that occur in the attack and decay of piano notes.

Sampling is actually a digital recording technique like that used in compact disks and digital delay devices. It works by taking discrete samples — or “snapshots” of an actual sound signal, many thousands of times per second.

The number of these “snapshots” is determined by Sampling Frequency. For example, an 18kHz sampling frequency means that 18,000 samples are taken each second. The frequency level of the source signal is measured and quantified (stored as a number) in the FZ-1's memory. In following, its easy to deduce that the more samples taken per second, the more closely the resulting FZ-1 sound will resemble the original source sound. Of course, the more samples you take per second, the more memory space you will need to store the quantified data.

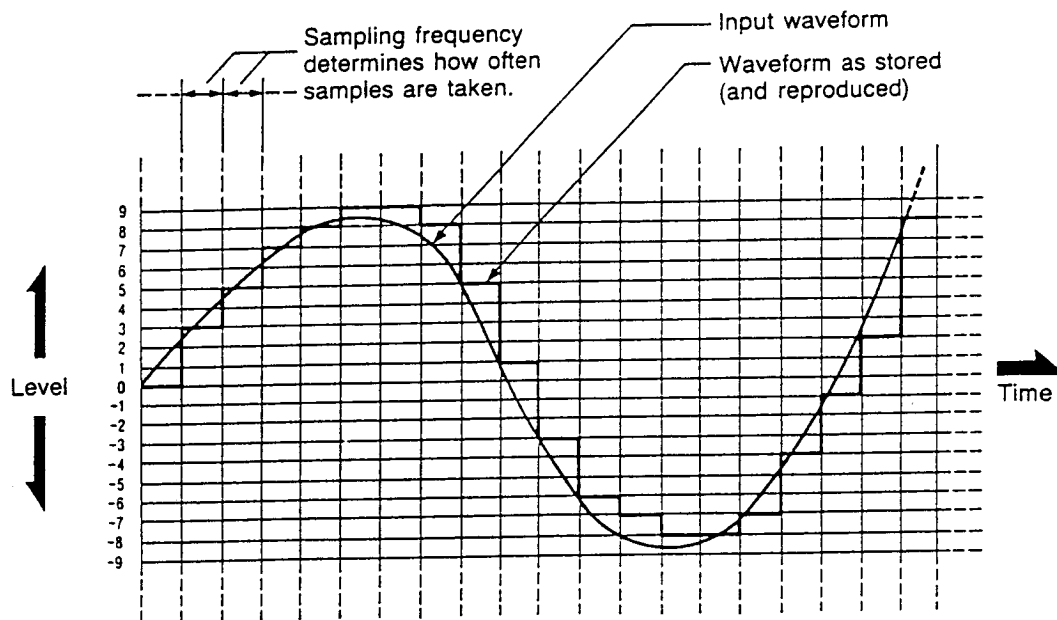

When sampling with the FZ-1, you have a choice of 3 different Sampling Frequencies. The frequency selected has a direct effect on maximum Sampling Lengths.

SAMPLING RATE	SAMPLING TIME	
	NO RAM BOARD	WITH RAM BOARD
36 kHz	14.5 sec	29.1 sec
18 kHz	29.1 sec	58.2 sec
9 kHz	58.2 sec	116.5 sec





MEMORY CAPACITY: 1 M Byte

SAMPLING BIT: 16 bit

## ■ SAMPLING OPERATIONS

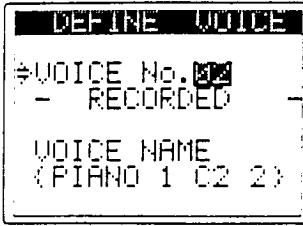
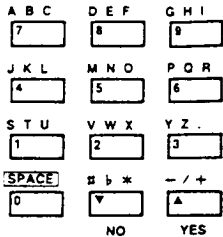
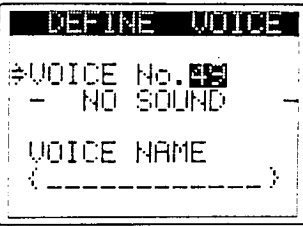
### (A) DEFINE VOICE

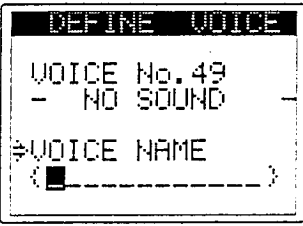
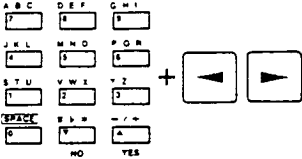
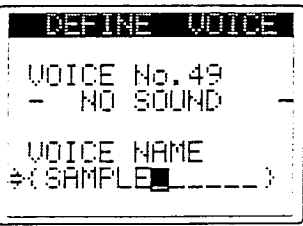
Assign a Voice Number and a Voice Name to the sound to be sampled.

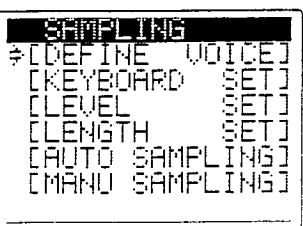
<p>(1) Enter DEFINE VOICE Operation in Sampling Function.</p>	<p>ENTER</p> 	
<p>(2) Assign a VOICE No. to sound about to be sampled using the alphanumeric Ten keys.</p> <p>*If the specified voice number has not already been selected, a NO SOUND message appears in the display.</p> <p>*If the specified voice number already exists in memory, a RECORDED message appears in the display.</p>		
<p>(3) Move cursor to VOICE NAME position.</p>		
<p>(4) Assign a VOICE NAME using the alphanumeric ten-keys and cursor keys.</p>		
<p>(5) Press ESCAPE key to exit to Sampling Function menu.</p>	<p>ESCAPE</p> 	

## (B) KEYBOARD SET

Establish key to which sample will be assigned (Original Key), as well as range within which sample will sound on the keyboard (Key Width).

(1) Enter KEYBOARD SET Operation in Sampling Function.

\*If the voice specified has not yet been sampled, initialized parameters will be displayed for Original, Highest and Lowest positions.

\*If the voice specified already exist, previously set parameters will be displayed.

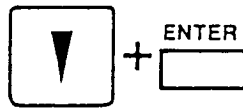

```

KEYBOARD SET
- VOICE No.43 -
(SAMPLE SOUND)
- NO SOUND -
=>ORIGINAL = C05
  HIGHEST = F02
  LOWEST = G02
    
```

(2) Specify ORIGINAL sampling key by pressing the corresponding key on the keyboard. Cursor automatically moves to HIGHEST position.

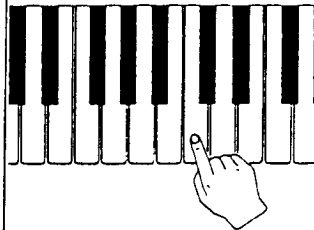

```

KEYBOARD SET
- VOICE No.49 -
(SAMPLE SOUND)
- NO SOUND -
ORIGINAL = C05
=>HIGHEST = C07
  LOWEST = C02
    
```

(3) Specify the high-end limit of sample sounding range by pressing the corresponding key. Cursor automatically moves to LOWEST position.

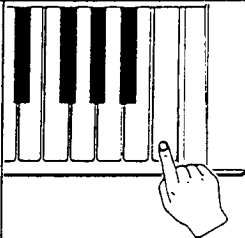

```

KEYBOARD SET
- VOICE No.49 -
(SAMPLE SOUND)
- NO SOUND -
ORIGINAL = C05
HIGHEST = C07
=>LOWEST = G02
    
```

(4) Specify the low-end limit of sample sounding range by pressing the corresponding key. Cursor automatically moves back to ORIGINAL position.

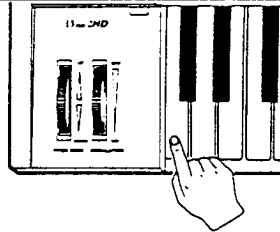

```

KEYBOARD SET
- VOICE No.49 -
(SAMPLE SOUND)
- NO SOUND -
=>ORIGINAL = C05
  HIGHEST = C07
  LOWEST = C02
    
```

(5) Press ESCAPE key to exit to Sampling Function menu.



```

SAMPLING
[DEFINE VOICE]
=>[KEYBOARD SET]
[LEVEL SET]
[LENGTH SET]
[AUTO SAMPLING]
[MANU SAMPLING]
    
```

### NOTES

\*LOWEST-HIGHEST range may be set between C-2 — C-7.





However, this range is restricted to 3 octaves above and 3 octaves below ORIGINAL position.

\*In addition to using keyboard keys, Value keys and Value slider may also be used to specify ORIGINAL, HIGHEST & LOWEST positions.

\*If HIGHEST position is set below LOWEST, positions are automatically reversed, with LOWEST becoming HIGHEST, and vice versa.

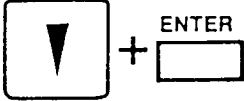
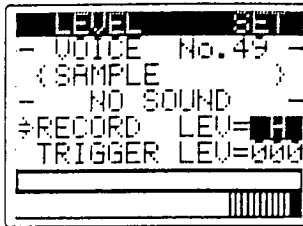
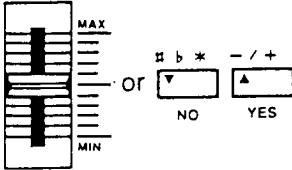
## (C) LEVEL SET

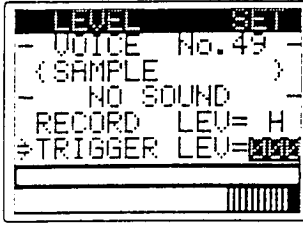
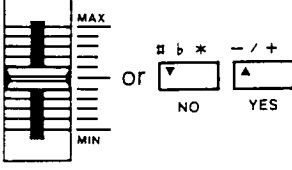
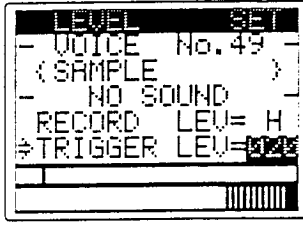
Specify sample recording level and sensitivity of recording trigger used in Auto Trigger Sampling. The sample recording level features a "H" and an "L" setting. Set to "H" (High) in most cases, however "L" (Low) should be used when sampling any high-decibal sound.

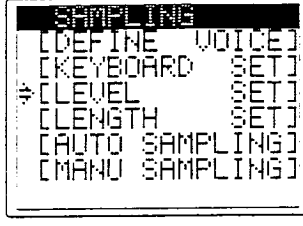
<p>(1) Enter LEVEL SET Operation in Sampling Function. Cursor is initially in the RECORD LEVEL position.</p>		
<p>(2) Specify "H" (high) or "L" (low) recording level using the Value slider or Value keys.</p>		
<p>(3) Move cursor to the TRIGGER LEVEL position.</p>		
<p>(4) Specify trigger sensitivity by setting TRIGGER LEVEL at any point within the 000 — 127 range with the Value slider or Value keys.</p>		
<p>(5) Press ESCAPE key to exit to Sampling Function menu.</p>		





### ■ ABOUT SAMPLING LEVELS

The "sampling level" is actually dependant on the relative values of three different levels; the original level of the sound to be sampled, the "input level" as controlled by the Sampling Level slider, and the Trigger Sensitivity level. Undistorted sampling requires accurate control of the relative positions of all three levels.

- Notice that the bar at the top of the Sampling Level Meter moves when the Trigger Level is altered. Use this in combination with the Peak Hold marker of the Level Meter and the Sampling Level slider to accurately control overall sampling level. While in the Level Set Operation, the sound to be sampled may be input in order to check and make fine adjustments of these levels before proceeding with actual recording.
- LEVEL SET parameters affect all voices.
- In initialized state, Recording Level is set to "H" and Trigger Level is set to "000".

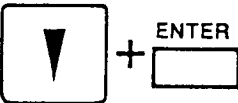
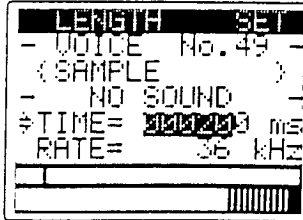
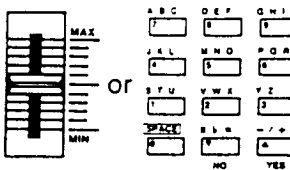
## (D) LENGTH SET

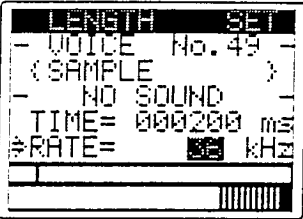
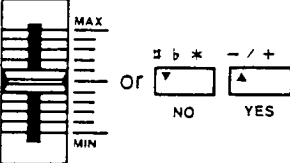
Specify the Sampling Time and Sampling Rate of the sound to be sampled.



(1) Enter LENGTH SET Operation in Sampling Function.																
(2) Specify SAMPLING TIME with the Value slider or Value keys. Sampling time is set in units of 10msec.		<table border="1"> <thead> <tr> <th rowspan="2">SAMPLING RATE</th> <th colspan="2">SAMPLING TIME</th> </tr> <tr> <th>NO RAM BOARD</th> <th>WITH RAM BOARD</th> </tr> </thead> <tbody> <tr> <td>36 kHz</td> <td>14.5 sec</td> <td>29.1 sec</td> </tr> <tr> <td>18 kHz</td> <td>29.1 sec</td> <td>58.2 sec</td> </tr> <tr> <td>9 kHz</td> <td>58.2 sec</td> <td>116.5 sec</td> </tr> </tbody> </table>	SAMPLING RATE	SAMPLING TIME		NO RAM BOARD	WITH RAM BOARD	36 kHz	14.5 sec	29.1 sec	18 kHz	29.1 sec	58.2 sec	9 kHz	58.2 sec	116.5 sec
SAMPLING RATE	SAMPLING TIME															
	NO RAM BOARD	WITH RAM BOARD														
36 kHz	14.5 sec	29.1 sec														
18 kHz	29.1 sec	58.2 sec														
9 kHz	58.2 sec	116.5 sec														
(3) Move cursor to SAMPLING RATE position.																
(4) Specify SAMPLING RATE with Value slider or Value keys. Choose from 36kHz, 18kHz or 9kHz.																
(5) Press ESCAPE key to exit to Sampling Function menu.																

### NOTES

- \*Through the use of an optional memory expansion kit (RAM BOARD MB-10), maximum sampling lengths for each sampling rate can be doubled.
- \*LENGTH SET parameters affect all voices.

## (E) AUTO SAMPLING

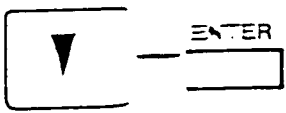
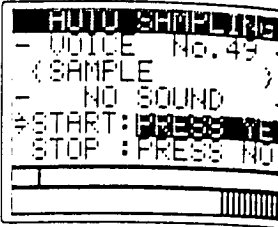
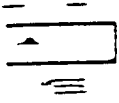
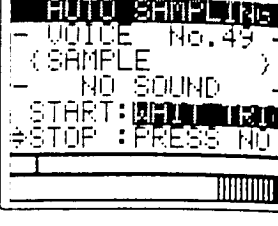
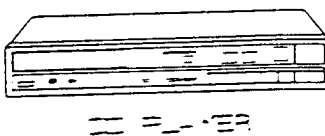
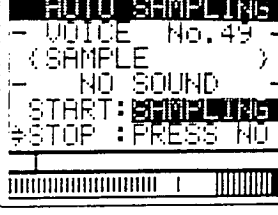
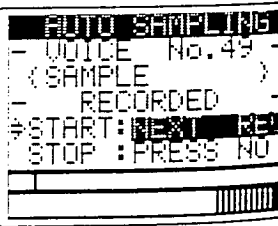
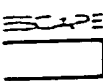
Execute auto sampling using recording trigger, accuracy = meters set in previous operations.



<p>(1) Enter AUTO SAMPLING Operation in Sampling Function.</p>		
<p>(2) Press YES key to initialize sampling operation. *Foot switch may be used in place of YES key for this operation.</p>		
<p>(3) Input sound to be sampled.</p>		
<p>*Sampling begins automatically when level meets preset Trigger Level, continuing for preset time period. *To interrupt auto sampling, press NO key. *After auto sampling execution, sample may be sounded with Original key, and within preset Key Width. *NO SOUND message changes to RECORDED message immediately after auto sample execution. *Auto Sampling may be reexecuted by pressing the YES key once again.</p>		
<p>(4) Press ESCAPE key to exit to Sampling Function menu.</p>		

### NOTE

SYNTHESIZED or RECORDED messages appearing in place of NO SOUND message indicate that specified voice already exists, having been created by wave synthesis or recorded through sampling, respectively.

## (F) MANUAL SAMPLING

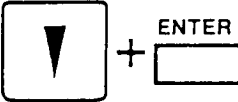
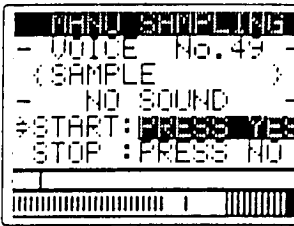
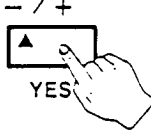
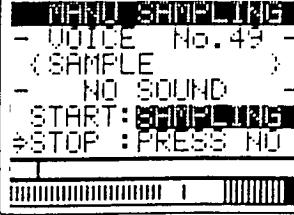
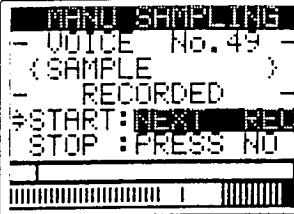
Execute sampling manually, without using sampling trigger function.

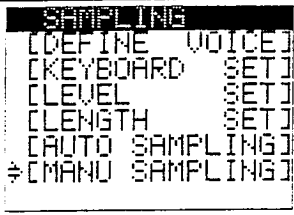







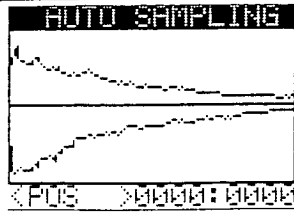

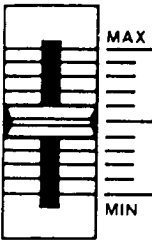
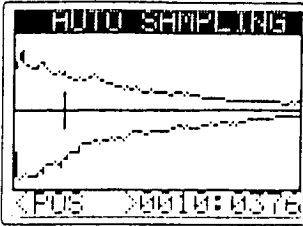
<p>(1) Enter MANUAL SAMPLING Operation in Sampling Function.</p>		
<p>(2) Press YES key to begin manual sampling operation.</p>		
<p>*Sampling continues for duration of preset period (Sampling Length).          *To interrupt sampling, press NO key.          *After manual sampling execution, sample may be sounded with Original key, and within preset Key Width.          *NO SOUND message changes to RECORDED message immediately after manual sample execution.          *Manual Sampling may be reexecuted by pressing the YES key once again.</p>		
<p>(4) Press ESCAPE key to exit to Sampling Function menu.</p>		

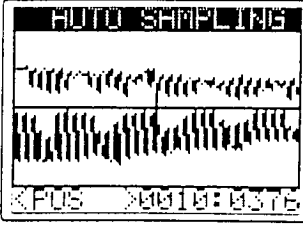
### NOTES

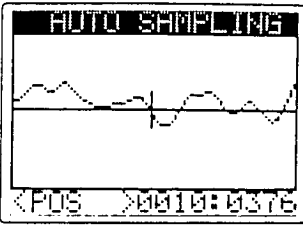
- \*Foot switch may be used in place of YES key for this operation.
- \*SYNTHESIZED or RECORDED messages appearing in place of NO SOUND message indicate that specified voice already exists, having been created by wave synthesis or recorded through sampling, respectively.

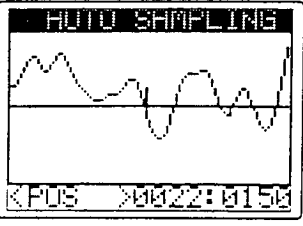
## ■ SAMPLING GRAPHIC DISPLAY

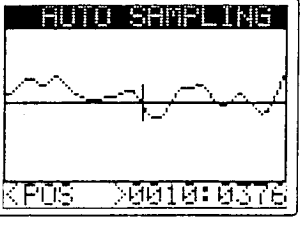
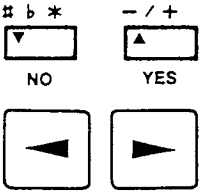
<p>Immediately after Auto Sampling or Manual Sampling execution (while in NEXT REC state), press the DISPLAY key to display the waveform of the sample just recorded.</p>		
---	---	---

<p>Using the Value slider or Value keys, move the indicator to the right or left. Sampling data corresponding to the position of the indicator is shown at the bottom of the display.</p>		
<p>By pressing the [▼] Cursor key, an enlarged view of any section in the waveform selected by the indicator may be specified, along the horizontal axis.</p>		
<p>Press the [▼] Cursor key again for further enlargement of the specified section along the horizontal axis.</p>		
<p>Repeatedly pressing the [▼] Cursor key provides enlargement of Sampling Data, for verification of minute signal details.</p>		
<p>Pressing the [▲] Cursor key provides a reduced view of the waveform, centering on the indicator position.</p>		
<p>To move the indicator along the waveform one position at a time (right and left), press the YES or NO key. Notice that the value of each position is shown at the bottom right-hand corner of the display. By using the Cursor [◀] &amp; [▶] keys, you can shift 48 positions at a time, to the right or left. This shift is equal to 1/2 the width of the Graphic Display.</p>		



## ■ DELETING EXISTING VOICES

When Auto Sampling or Manual Sampling Operations are entered, RECORDED messages may appear in place of NO SOUND messages. These indicate that a voice already exists corresponding to the Voice No. selected.

A [DELETE?] prompt asks you if you want to delete the existing voice and replace it with a sample. To delete, simply press the YES key and continue with sampling operation.

## II. WAVE SYNTHESIS

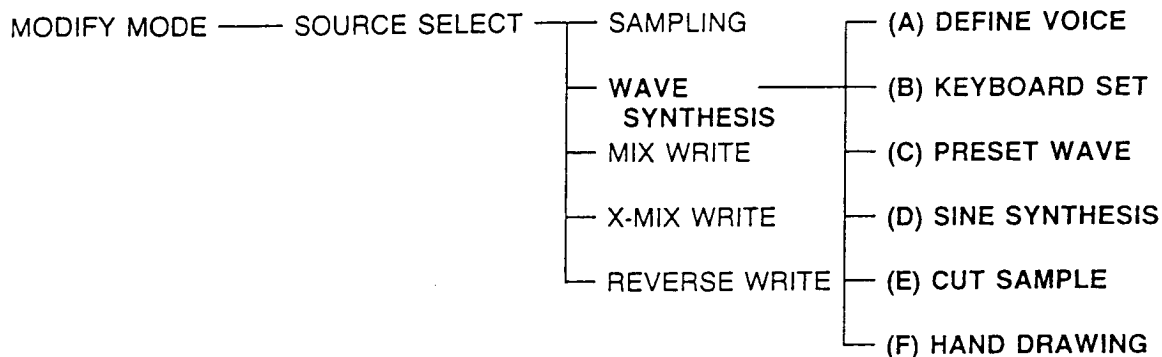

## ■ ABOUT WAVE SYNTHESIS

The FZ-1 features 4 different types of wave synthesis. These include selection of Preset Waves, Sine Synthesis, which is a form of additive synthesis, Cut Sample synthesis, wherein waveforms from sampled sounds are cut to form new waveforms, and Hand Drawing, which allows wave forms to be "drawn" using the cursor keys and level controllers.

## ■ WAVE SYNTHESIS OPERATIONS

### (A) DEFINE VOICE

Assign a Voice Number and a Voice Name to the sound to be created.

(1) Enter DEFINE VOICE Operation in Wave Synthesis Function.

ENTER

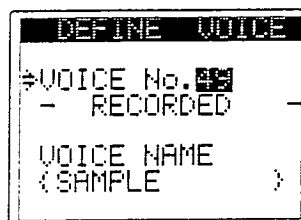



(2) Assign a VOICE No. to sound about to be created using the alphanumeric ten-keys.

\*If the specified voice number has not already been selected, a NO SOUND message appears in the display.

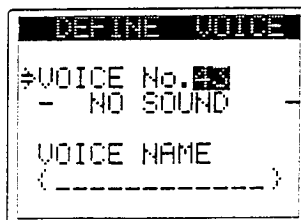
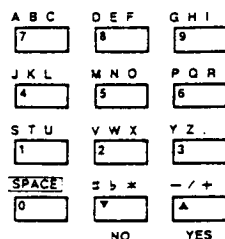

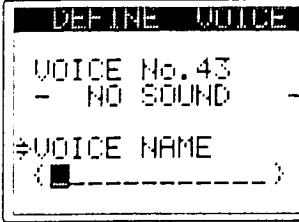
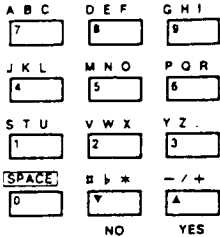
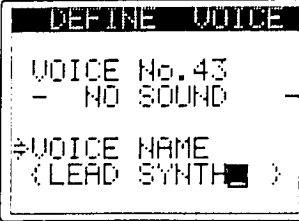
\*If the specified voice number already exists in memory, a SYNTHESIZED (or RECORDED) message appears in the display.

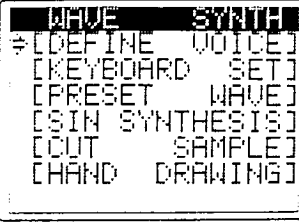

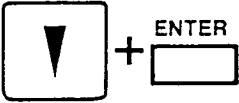
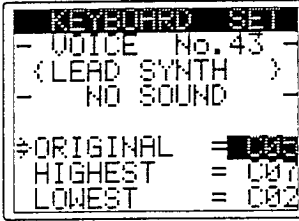
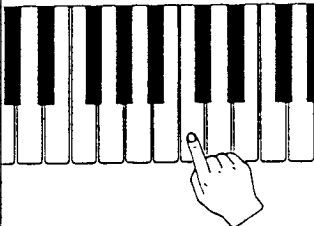

<p>(3) Move cursor to VOICE NAME position.</p>		
<p>(4) Assign a VOICE NAME using the alpha-numeric ten-keys.</p>		
<p>(5) Press ESCAPE key to exit to Wave Synthesis Function menu.</p>		

## (B) KEYBOARD SET

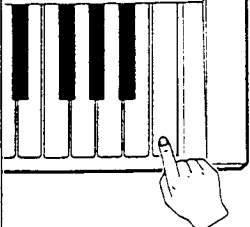
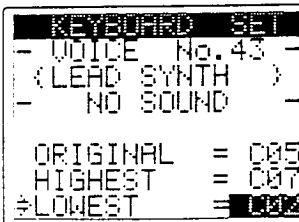
Establish key to which synthesized voice will be assigned (Original Key), as well as range within which the voice will sound on the keyboard (Key Width).

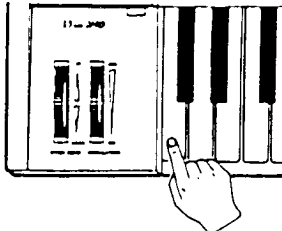
<p>(1) Enter KEYBOARD SET Operation in Wave Synthesis Function.</p> <p>*If no voice exists corresponding to the specified voice number, then initialized parameters will be displayed for Original, Highest and Lowest positions.</p> <p>*If the voice specified already exists, previously set parameters will be displayed.</p>		
<p>(2) Specify ORIGINAL position by pressing the corresponding key on the keyboard.</p>		
<p>(3) Specify the high-end limit of key width range by pressing the corresponding key.</p>		



<p>(4) Specify the low-end limit of key width range by pressing the corresponding key.</p>		<pre> KEYBOARD SET - VOICE No.43 - ( LEAD SYNTH ) - NO SOUND - =&gt; ORIGINAL = C03     HIGHEST = C07     LOWEST  = C02 </pre>
<p>(5) Press ESCAPE key to exit to Wave Synthesis Function menu.</p>	<p>ESCAPE</p> 	<pre> WAVE SYNTH [DEFINE VOICE] =&gt; [KEYBOARD SET]     [PRESET WAVE]     [SIN SYNTHESIS]     [CUT SAMPLE]     [HAND DRAWING] </pre>

### NOTES

- \*Lowest-Highest range may be set between C-2 — C-7. However, this range is restricted to 3.5 octaves above and 2.5 octaves below Original position.
- \*In addition to using keyboard keys, Value keys and Value slider may also be used to specify Original, Highest & Lowest positions.
- \*If Highest position is set below Lowest, positions are automatically reversed, with Lowest becoming Highest, and vice versa.

## (C) PRESET WAVE

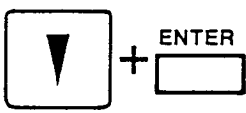
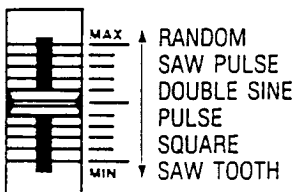
Used to select a preset waveform, as with conventional synthesizers.

<p>(1) Enter PRESET WAVE Operation in Wave Synthesis Function.</p>		<pre> PRESET WAVE - VOICE No.43 - ( LEAD SYNTH ) - NO SOUND - - PRESET WAVE - =&gt; </pre>
<p>(2) Specify desired preset waveform with Value slider, Value keys or ten-keys.</p>		<pre> PRESET WAVE - VOICE No.43 - ( LEAD SYNTH ) - SYNTHESIZED - - PRESET WAVE - =&gt; PULSE </pre>
<p>(3) Press the DISPLAY selector for a graphic display of the specified waveform.</p>	<p>DISPLAY</p> 	<pre> PRESET WAVE [GRAPHIC DISPLAY OF PULSE WAVEFORM] =&gt; PULSE </pre>

(4) Press the ESCAPE key to exit to the Wave Synthesis Function menu.

ESCAPE

```

WAVE SYNTH
[DEFINE VOICE]
[KEYBOARD SET]
⇨ [PRESET WAVE]
[SIN SYNTHESIS]
[OUT SAMPLE]
[HAND DRAWING]
    
```

## (D) SINE SYNTHESIS

Create sound source waveforms through additive synthesis of sine waves.

(1) After performing DEFINE VOICE Operation enter SINE SYNTHESIS Operation in Wave Synthesis Function.

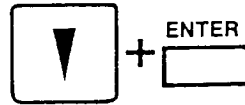

```

SIN SYNTHESIS
- VOICE No.44 -
(SYNTH-DRUM )
- NO SOUND -
⇨SIN No.01 = 000
[ EXECUTE ]
    
```

(2) Specify LEVEL of fundamental sine wave using Value slider, Value keys or ten-keys. Level may be set within a 000 — 256 range.

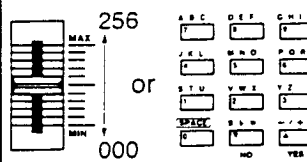

```

SIN SYNTHESIS
- VOICE No.44 -
(SYNTH-DRUM )
- NO SOUND -
⇨SIN No.01 = 123
[ EXECUTE ]
    
```

(3) Press [▶] cursor key to select 2nd harmonic.



```

SIN SYNTHESIS
- VOICE No.44 -
(SYNTH-DRUM )
- NO SOUND -
⇨SIN No.02 = 000
[ EXECUTE ]
    
```

(4) Specify LEVEL of 2nd harmonic using Value slider, Value keys or ten-keys. Level may be set within a 000 — 256 range.

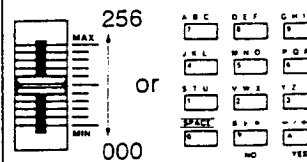







```

SIN SYNTHESIS
- VOICE No.44 -
(SYNTH-DRUM )
- NO SOUND -
⇨SIN No.02 = 123
[ EXECUTE ]
    
```

(5) Repeat procedures (3) and (4) to set levels of up to 48 harmonics.

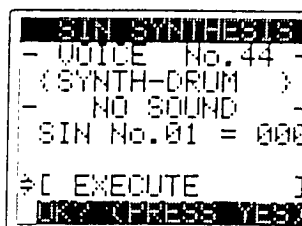
```

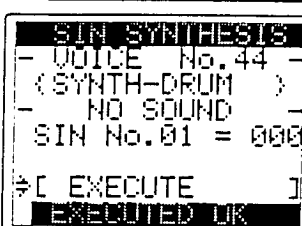
SIN SYNTHESIS
- VOICE No.44 -
(SYNTH-DRUM )
- NO SOUND -
⇨SIN No.03 = 123
[ EXECUTE ]
    
```

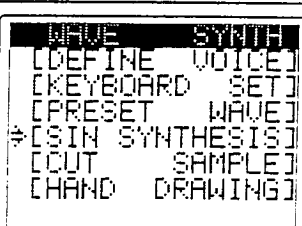
<p>*After setting level of each harmonic, press DISPLAY selector for a graphic display of all harmonic levels. If only fundamental harmonic is set, other harmonics may be input by using the [▶] cursor key, Value slider, Value keys and ten-keys.</p>		
<p>(6) Move cursor to [EXECUTE] position and press ENTER key.</p>	 + ENTER 	 <pre> SIN SYNTHESIS - VOICE No.44 - (SYNTH-DRUM ) - NO SOUND - SIN No.01 = 000 =&gt;[ EXECUTE ] [OK] [PRESS] [YES] </pre>
<p>(7) Respond to the [OK?] prompt by pressing the YES key.</p>	<p>- / +</p>  <p>YES</p>	 <pre> SIN SYNTHESIS - VOICE No.44 - (SYNTH-DRUM ) - NO SOUND - SIN No.01 = 000 =&gt;[ EXECUTE ] [EXECUTED OK] </pre>
<p>(8) Press ESCAPE key to exit to Wave Synthesis Function menu.</p>	<p>ESCAPE</p> 	 <pre> WAVE SYNTH [DEFINE VOICE] [KEYBOARD SET] [PRESET WAVE] =&gt;[SIN SYNTHESIS] [OUT SAMPLE] [HAND DRAWING] </pre>

## ■ ABOUT GRAPHIC DISPLAY

Pressing the cursor [▶] key repeatedly increments the no. of the harmonic.

To decrement the no., simply press the cursor [◀] key repeatedly, in the same way.

When creating voices using a large number of harmonics, you'll probably find it easiest to hold down the cursor [▶] key and raise and lower levels of each sine wave using the Value slider.



### NOTES





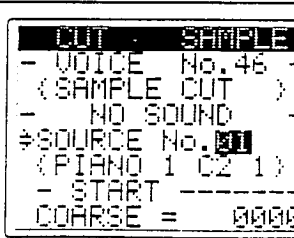

\*Initialized values of fundamental sine wave and all harmonics is 000.

\*Sine synthesis operation is not completed until [EXECUTE] procedure is performed. Therefore, resulting sounds cannot be played until after this procedure.

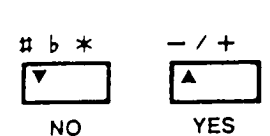
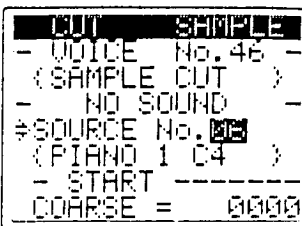
## (E) CUT SAMPLE

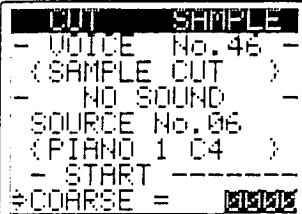
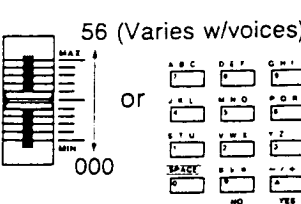
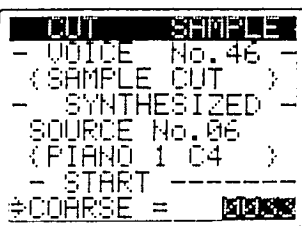
Cut out part of a sampled waveform for use as an independent sound source.

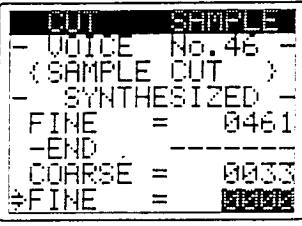
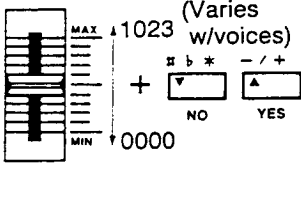
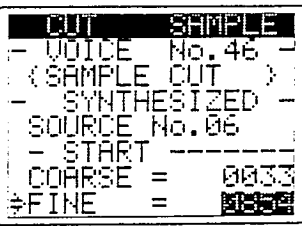
<p>(1) After performing DEFINE VOICE Operations, enter CUT SAMPLE Operation in Wave Synthesis Function.</p>	 + ENTER 	 <pre> CUT SAMPLE - VOICE No.46 - (SAMPLE CUT ) - NO SOUND - =&gt;SOURCE No.01 (PIANO 1 C2 1) - START ----- COARSE = 0000 </pre>
---	---	--

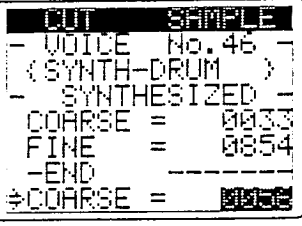
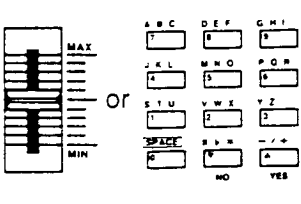
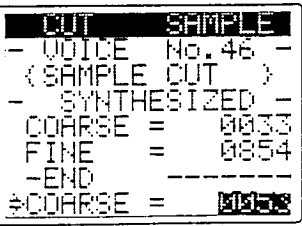
<p>(2) Specify the number of the sampled Voice to be used as the source with the ten-keys, Value slider or Value keys. *The name of the selected voice is displayed along with the number.</p>		
<p>(3) Move the cursor to the COARSE position.</p>		
<p>(4) Roughly specify the starting point of the sample cut with the COARSE parameter. Set using the Value slider or Value keys. *NO SOUND message changes to SYNTHESIZED message and voice may be sounded after COARSE parameter is established.</p>		
<p>(5) Move the cursor to the FINE position.</p>		
<p>(6) Make a finer approximation of the starting point of the sample cut with the FINE parameter. Set using the Value slider, Value keys and ten-keys.</p>		
<p>(7) Press the cursor [▼] key.</p>		
<p>(8) Roughly specify the ending point of the sample cut with the COARSE parameter. Set using the Value slider or Value keys.</p>		

(9) Move the cursor to the FINE position.



(10) Make a finer approximation of the ending point of the sample cut with the FINE parameter. Set using the Value slider, Value keys and ten-keys.

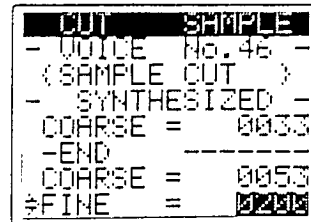
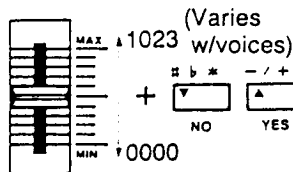

## ■ CUT SAMPLE GRAPHIC EDITING

The specified CUT SAMPLE starting and stopping points can be displayed graphically.

(1) Press the DISPLAY key when the cursor is in the starting COARSE or FINE positions, or when it's in the ending COARSE or FINE positions to show the starting or ending points, respectively.

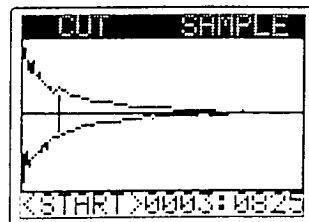

This graphic display function operates in the same way as the Sampling Function graphic display, however the indicator represents the starting or ending point in this case.

## (F) HAND DRAWING

Create original waveforms or modify Preset waveforms and waveforms created through Sine Synthesis or Cut Sample operations through Hand Drawing.

### ■ ABOUT HAND DRAWING

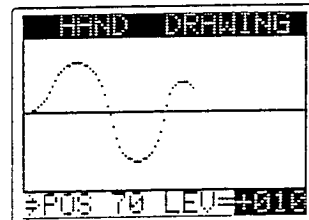

In the Hand Drawing operation, waveforms are divided into up to 96 POSITIONS. Each of these 96 positions is assigned a LEVEL, resulting in a waveform as shown at the right.

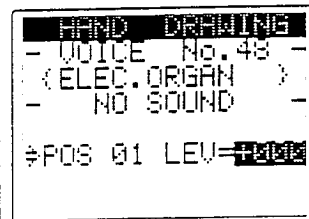
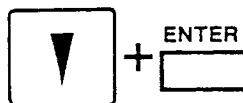

(1) After performing DEFINE VOICE operations enter HAND DRAWING Operation in Wave Synthesis Function.

\*When modifying a Voice created other synthesis operations, SYNTHESIZED message appears on display.

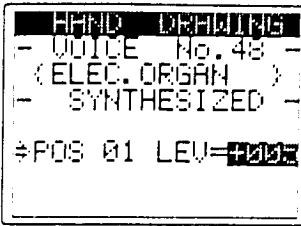
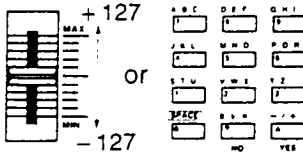
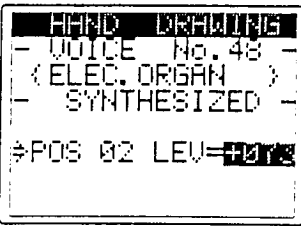

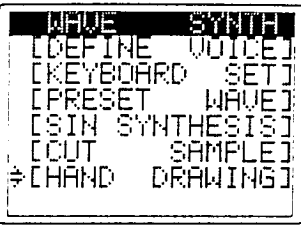
<p>(2) Specify Position number (1 – 96) using the Cursor [▶] &amp; [◀] keys.</p>		
<p>(3) Specify (or alter) the Value of each Position using the Value slider, Value keys or ten-keys. *Repeat steps (2) and (3) for all positions, using the cursor [▶] key to increment positions.</p>		
<p>(4) Press the ESCAPE key to exit to the Wave Synthesis Function menu.</p>		

## ■ HAND DRAWING GRAPHIC DISPLAY

In the Hand Drawing operation, waveform positions and relative values can be displayed graphically. Waveforms may also be written in this mode.

### To view or alter existing waveforms:

(1) Press the DISPLAY key when the normal Hand Drawing display is selected.

DISPLAY  

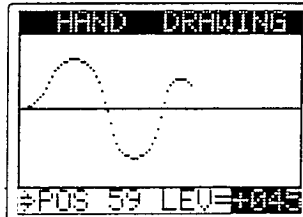

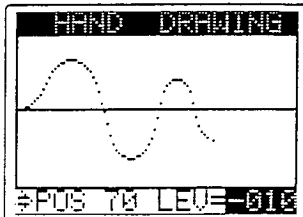

(2) Use the [▶] cursor key to move along waveform time axis, progressing in position as the cursor moves to the right. The position number and relative level is shown at the bottom of the graphic display.



### To create new waveforms through hand writing:

(1) Press the DISPLAY key when the normal Hand Drawing display is selected.

DISPLAY  

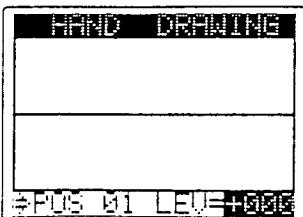



(2) Use the [▶] cursor key to move along waveform time axis, progressing in position as the cursor moves to the right. Input values for each position using the Value slider, Value keys or ten-keys. The position number and relative level is shown at the bottom of the graphic display.

You may find it easiest to hold down the cursor [▶] key and move the Value slider to "draw" the waveform shape. This may take some practice. Note that you can use the cursor [◀] key to decrement position.

\*Note that levels can only be changed by using Value keys or ten-keys after waveform has been completed.

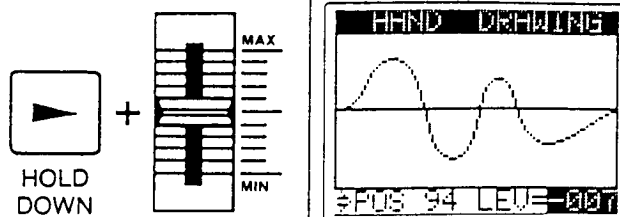

### III. MIX WRITE

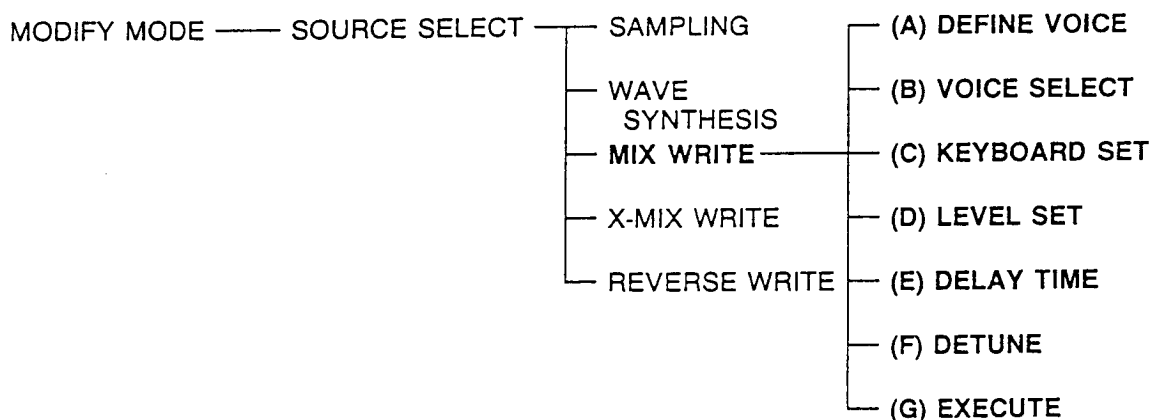

#### ■ ABOUT MIX WRITE FUNCTION

Using the Mix Write function, 2 different voices which have been created by sampling can be "mixed" together to create a new voice. The wave data for voices is mixed together as is, with voice parameters having no effect on the new voice.





## ■ INSERT DISK FL-B

In Mix Write operations, it's necessary to use two voices which have been created through sampling. If you haven't sampled any sounds yet, insert disk FL-B into the disk drive and perform LOAD operations, as described in Section 2: Play Mode "Load of Disk Data." This disk contains multiple timbres, which of course make for the most interesting mixes.

## ■ MIX WRITE OPERATIONS

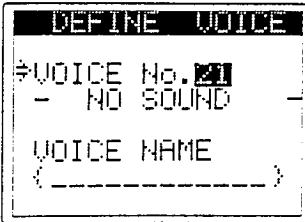

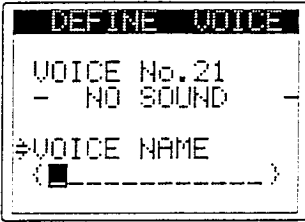
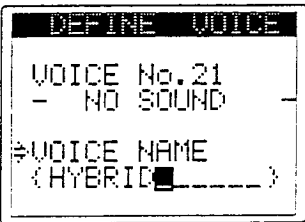
### (A) DEFINE VOICE

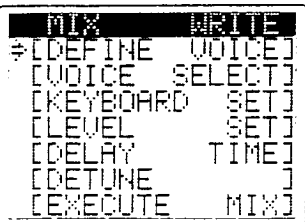
Assign a Voice Number and a Voice Name to the new sound to be created.

<p>(1) Enter DEFINE VOICE Operation in Mix Write Function.</p>	<p style="text-align: center;">ENTER  </p>																													
<p>(2) Assign a VOICE No. to sound about to be created using the alphanumeric ten-keys.</p> <p>*If the specified voice number has not already been selected, a NO SOUND message appears in the display.</p> <p>*If the specified voice number already exists in memory, a RECORDED (or SYNTHESIZED) message appears in the display.</p>	<p style="text-align: center;"> <table border="0"> <tr> <td>A B C</td> <td>D E F</td> <td>G H I</td> </tr> <tr> <td>7</td> <td>8</td> <td>9</td> </tr> <tr> <td>J K L</td> <td>M N O</td> <td>P Q R</td> </tr> <tr> <td>4</td> <td>5</td> <td>6</td> </tr> <tr> <td>S T U</td> <td>V W X</td> <td>Y Z .</td> </tr> <tr> <td>1</td> <td>2</td> <td>3</td> </tr> <tr> <td>SPACE</td> <td>0</td> <td>NO YES</td> </tr> </table> </p>	A B C	D E F	G H I	7	8	9	J K L	M N O	P Q R	4	5	6	S T U	V W X	Y Z .	1	2	3	SPACE	0	NO YES								
A B C	D E F	G H I																												
7	8	9																												
J K L	M N O	P Q R																												
4	5	6																												
S T U	V W X	Y Z .																												
1	2	3																												
SPACE	0	NO YES																												
<p>(3) Move cursor to VOICE NAME position.</p>	<p style="text-align: center;">  </p>																													
<p>(4) Assign a VOICE NAME using the Value keys.</p>	<p style="text-align: center;"> <table border="0"> <tr> <td>A B C</td> <td>D E F</td> <td>G H I</td> <td></td> </tr> <tr> <td>7</td> <td>8</td> <td>9</td> <td></td> </tr> <tr> <td>J K L</td> <td>M N O</td> <td>P Q R</td> <td></td> </tr> <tr> <td>4</td> <td>5</td> <td>6</td> <td></td> </tr> <tr> <td>S T U</td> <td>V W X</td> <td>Y Z .</td> <td></td> </tr> <tr> <td>1</td> <td>2</td> <td>3</td> <td></td> </tr> <tr> <td>SPACE</td> <td>0</td> <td>NO YES</td> <td>+ ← →</td> </tr> </table> </p>	A B C	D E F	G H I		7	8	9		J K L	M N O	P Q R		4	5	6		S T U	V W X	Y Z .		1	2	3		SPACE	0	NO YES	+ ← →	
A B C	D E F	G H I																												
7	8	9																												
J K L	M N O	P Q R																												
4	5	6																												
S T U	V W X	Y Z .																												
1	2	3																												
SPACE	0	NO YES	+ ← →																											
<p>(5) Press ESCAPE key to exit to Mix Write Function menu.</p>	<p style="text-align: center;">ESCAPE  </p>																													

## (B) VOICE SELECT

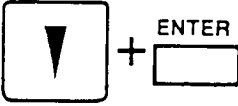
Specify the numbers of the 2 voices to be mixed.

<p>(1) Enter the VOICE SELECT Operation in the Mix Write Function.</p>		<pre> VOICE SELECT - VOICE No. 21 - (HYBRID ) - NO SOUND - =&gt;1ST VOICE No. 01 (CLA GR C3 ) 2ND VOICE No. 01 (CLA GR C3 )         </pre>																											
<p>(2) Specify the Voice No. of one of the voices to be mixed, using the ten-keys or Value slider.</p>	<table border="1"> <tr><td>A B C</td><td>D E F</td><td>G H I</td></tr> <tr><td>7</td><td>8</td><td>9</td></tr> <tr><td>J K L</td><td>M N O</td><td>P Q R</td></tr> <tr><td>4</td><td>5</td><td>6</td></tr> <tr><td>S T U</td><td>V W X</td><td>Y Z .</td></tr> <tr><td>1</td><td>2</td><td>3</td></tr> <tr><td>SPACE</td><td>← → *</td><td>- / +</td></tr> <tr><td>0</td><td>▼</td><td>▲</td></tr> <tr><td></td><td>NO</td><td>YES</td></tr> </table>	A B C	D E F	G H I	7	8	9	J K L	M N O	P Q R	4	5	6	S T U	V W X	Y Z .	1	2	3	SPACE	← → *	- / +	0	▼	▲		NO	YES	<pre> VOICE SELECT - VOICE No. 21 - (HYBRID ) - NO SOUND - =&gt;1ST VOICE No. 02 (CLA GR F3 ) 2ND VOICE No. 01 (CLA GR C3 )         </pre>
A B C	D E F	G H I																											
7	8	9																											
J K L	M N O	P Q R																											
4	5	6																											
S T U	V W X	Y Z .																											
1	2	3																											
SPACE	← → *	- / +																											
0	▼	▲																											
	NO	YES																											
<p>(3) Move the cursor to the 2ND VOICE position.</p>		<pre> VOICE SELECT - VOICE No. 21 - (HYBRID ) - NO SOUND - 1ST VOICE No. 02 (CLA GR F3 ) =&gt;2ND VOICE No. 01 (CLA GR C3 )         </pre>																											
<p>(4) Specify the Voice No. of the second voice to be mixed, using the ten-keys or Value slider.</p>	<table border="1"> <tr><td>A B C</td><td>D E F</td><td>G H I</td></tr> <tr><td>7</td><td>8</td><td>9</td></tr> <tr><td>J K L</td><td>M N O</td><td>P Q R</td></tr> <tr><td>4</td><td>5</td><td>6</td></tr> <tr><td>S T U</td><td>V W X</td><td>Y Z .</td></tr> <tr><td>1</td><td>2</td><td>3</td></tr> <tr><td>SPACE</td><td>← → *</td><td>- / +</td></tr> <tr><td>0</td><td>▼</td><td>▲</td></tr> <tr><td></td><td>NO</td><td>YES</td></tr> </table>	A B C	D E F	G H I	7	8	9	J K L	M N O	P Q R	4	5	6	S T U	V W X	Y Z .	1	2	3	SPACE	← → *	- / +	0	▼	▲		NO	YES	<pre> VOICE SELECT - VOICE No. 21 - (HYBRID ) - NO SOUND - 1ST VOICE No. 02 (CLA GR F3 ) =&gt;2ND VOICE No. 02 (ACO GR F3 )         </pre>
A B C	D E F	G H I																											
7	8	9																											
J K L	M N O	P Q R																											
4	5	6																											
S T U	V W X	Y Z .																											
1	2	3																											
SPACE	← → *	- / +																											
0	▼	▲																											
	NO	YES																											
<p>(5) Press the ESCAPE key to exit to Mix Write Function menu.</p>		<pre> MIX WRITE [DEFINE VOICE] =&gt;[VOICE SELECT] [KEYBOARD SET] [LEVEL SET] [DELAY TIME] [DETUNE ] [EXECUTE MIX]         </pre>																											

## (C) KEYBOARD SET

Establish key to which voice will be assigned (Original Key), as well as range within which voice will sound on the keyboard (Key Width).

(1) Enter KEYBOARD SET Operation in Sampling Function.

\*If the voice specified has not yet been created, initialized parameters will be displayed for Original, Highest and Lowest positions.

\*If the voice specified already exists, previously set parameters will be displayed.

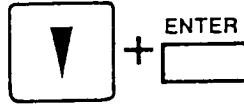

```

KEYBOARD SET
- VOICE No.21 -
<HYBRID >
- NO SOUND -

⇨ ORIGINAL = 002
  HIGHEST  = 007
  LOWEST   = 002
    
```

(2) Specify ORIGINAL key by pressing the corresponding key on the keyboard. Cursor automatically moves to HIGHEST position.

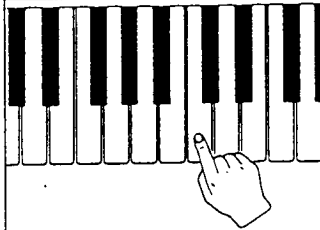

```

KEYBOARD SET
- VOICE No.21 -
<HYBRID >
- NO SOUND -

ORIGINAL = 085
⇨ HIGHEST = 007
  LOWEST  = 002
    
```

(3) Specify the high-end limit of voice sounding range by pressing the corresponding key. Cursor automatically moves to LOWEST positions.



```

KEYBOARD SET
- VOICE No.21 -
<HYBRID >
- NO SOUND -

ORIGINAL = 085
  HIGHEST = 007
⇨ LOWEST  = 002
    
```

(4) Specify the low-end limit of voice sounding range by pressing the corresponding key. Cursor automatically moves back to ORIGINAL position.

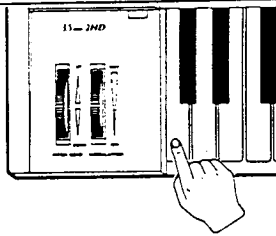

```

KEYBOARD SET
- VOICE No.21 -
<HYBRID >
- NO SOUND -

⇨ ORIGINAL = 002
  HIGHEST  = 007
  LOWEST   = 002
    
```

(5) Press ESCAPE key to exit to Mix Write Function menu.



```





MIX WRITE
[DEFINE VOICE]
[VOICE SELECT]
⇨ [KEYBOARD SET]
 [LEVEL SET]
 [DELAY TIME]
 [DETUNE ]
 [EXECUTE MIX]
    
```

**NOTES**

- \*Lowest-Highest range may be set between C-2 — C-7. However, this range is restricted to 3 octaves above and 3 octaves below Original position.
- \*In addition to using keyboard keys, ten-keys and Value slider may also be used to specify Original, Highest & Lowest positions.
- \*If Highest position is set below Lowest, positions are automatically reversed, with Lowest becoming Highest, and vice versa.

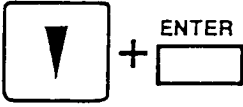
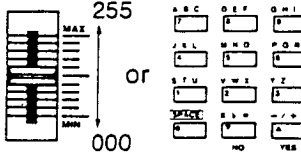
**(D) LEVEL SET**

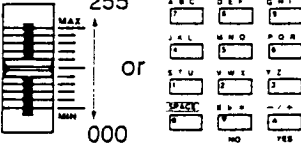
Set level of both voices to be mixed.





<p>(1) Enter LEVEL SET Operation in Mix Write Function.</p>		<pre> LEVEL SET - VOICE No.21 - (HYBRID ) NO SOUND =&gt;1ST LEVEL = 127 2ND LEVEL = 127                     </pre>
<p>(2) Specify level of first voice in mix, using Value slider or ten-keys.</p>		<pre> LEVEL SET - VOICE No.21 - (HYBRID ) NO SOUND =&gt;1ST LEVEL = 058 2ND LEVEL = 127                     </pre>
<p>(3) Move cursor to 2ND LEVEL position.</p>		<pre> LEVEL SET - VOICE No.21 - (HYBRID ) NO SOUND 1ST LEVEL = 058 =&gt;2ND LEVEL = 127                     </pre>
<p>(4) Specify level of second voice in mix, using Value slider or ten-keys.</p>		<pre> LEVEL SET - VOICE No.21 - (HYBRID ) NO SOUND 1ST LEVEL = 058 =&gt;2ND LEVEL = 127                     </pre>
<p>(5) Press ESCAPE key to exit to Mix Write Function menu.</p>		<pre> MIX WRITE [DEFINE VOICE] [VOICE SELECT] [KEYBOARD SET] =&gt;[LEVEL SET] [DELAY TIME] [DETUNE ] [EXECUTE MIX]                     </pre>

**NOTE**

Level may be set within 000 — 255 range. Initialized value is 127.

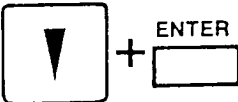
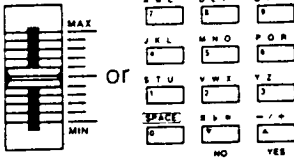
## (E) DELAY TIME

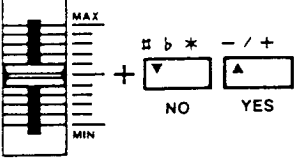
Specify the starting point of the second voice in reference to the starting point of the first voice.

<p>(1) Enter DELAY TIME Operation in Mix Write Function.</p>		<pre> DELAY TIME - VOICE No.21 - (HYBRID ) - NO SOUND - -- 2ND START -- ⇨COARSE = 0000 FINE = 0000         </pre>
<p>(2) Roughly specify the DELAY TIME of the second voice, using the Value slider or ten-keys.</p>		<pre> DELAY TIME - VOICE No.21 - (HYBRID ) - NO SOUND - -- 2ND START -- ⇨COARSE = 0002 FINE = 0000         </pre>
<p>(3) Move cursor to the FINE position.</p>		<pre> DELAY TIME - VOICE No.21 - (HYBRID ) - NO SOUND - -- 2ND START -- COARSE = 0002 ⇨FINE = 0000         </pre>
<p>(4) Make a finer approximation of DELAY TIME of second voice using the ten-keys.</p>		<pre> DELAY TIME - VOICE No.21 - (HYBRID ) - NO SOUND - -- 2ND START -- COARSE = 0002 ⇨FINE = 0000         </pre>
<p>(5) Press the ESCAPE key to exit to Mix Write Function menu.</p>		<pre> MIX WRITE [DEFINE VOICE] [VOICE SELECT] [KEYBOARD SET] [LEVEL SET] ⇨[DELAY TIME] [DETUNE ] [EXECUTE MIX]         </pre>

### NOTE

Initialized values of COARSE & FINE parameters set at 000.

## ■ DELAY TIME GRAPHIC DISPLAY

When setting this parameter, delay time of the second voice may be displayed graphically. Delay Time may also be set in this mode.

- (1) Press DISPLAY selector while normal DELAY TIME display is selected.  
 \*The graphic display operates in the same way as the Cut Sample Graphic display, however the indicator shows only the delay time in this case.

DISPLAY  

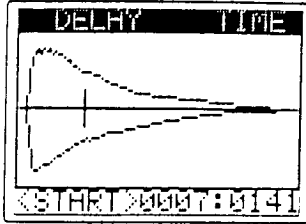

### NOTE

If the 1st voice is subsequently detuned, actual length of waveform is longer after mix execution. However, the Delay Time graphic display shows only the original length.

## (F) DETUNE

Set the tuning of the two voices to be mixed.

- (1) Enter DETUNE Operation in Mix Write Function.



```

DETUNE
- VOICE No.21 -
(HYBRID )
- NO SOUND -
=>1ST TUNE = 000
2ND TUNE = +000
    
```

- (2) Specify detuning of first voice using Value slider, Value keys or ten-keys.

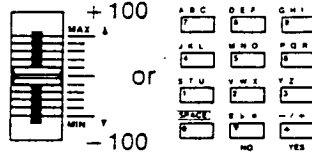

```

DETUNE
- VOICE No.21 -
(HYBRID )
- NO SOUND -
=>1ST TUNE = +100
2ND TUNE = +000
    
```

- (3) Move cursor to 2ND TUNE position.



```

DETUNE
- VOICE No.21 -
(HYBRID )
- NO SOUND -
1ST TUNE = +100
=>2ND TUNE = +000
    
```

- (4) Specify detuning of second voice using Value slider, Value keys or ten-keys.

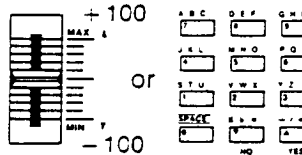







```

DETUNE
- VOICE No.21 -
(HYBRID )
- NO SOUND -
1ST TUNE = +100
=>2ND TUNE = -100
    
```

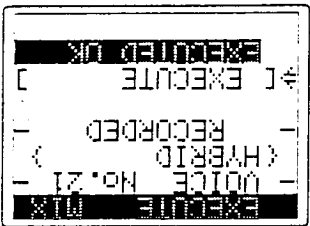
If a voice created by Wave Synthesis is specified as one of the voices in the Mix Write operation, the display shows a VOICE NO. ERROR message when the ENTER key is pressed in procedure (2) above.

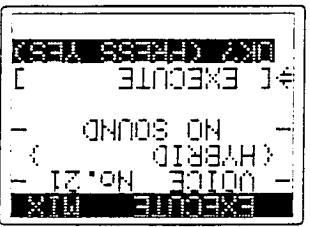
NOTE

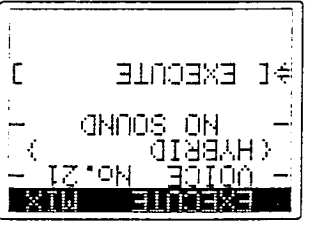
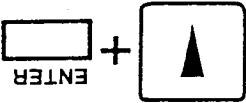

		<p>(4) Press ESCAPE key to exit to Mix Write Function menu.</p>
		<p>(3) Respond to [OK?] prompt by pressing YES key.</p>
		<p>(2) Press ENTER key.</p>
		<p>(1) Enter EXECUTE MIX Operation in Mix Write Function.</p>

Mix sounds according to parameters set in previous procedures.

(G) EXECUTE MIX

\* Tuning may be raised or lowered by 50 cents, or one half step.  
 \* Initialized tuning for each voice is that of ORIGINAL key set when voice was sampled.

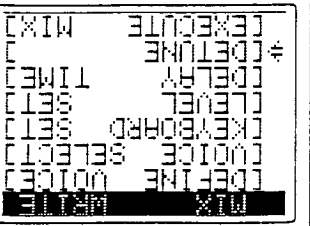
NOTES

		<p>(5) Press ESCAPE key to exit to Mix Write Function menu.</p>
---	---	---



# IV. CROSS-MIX WRITE

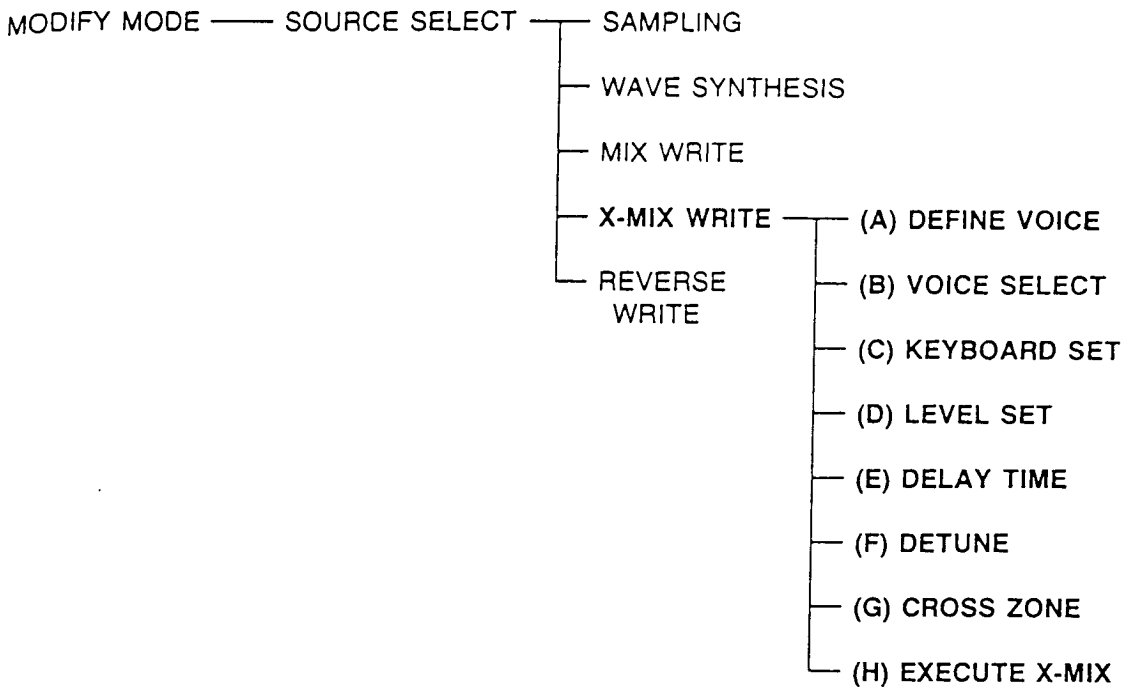

## ■ ABOUT THE X-MIX FUNCTION



Whereas the Mix Write Function is used to "blend" two sounds into a single sound, the Cross-Mix Write Function can be used to bring two sounds together by "connecting" them at a cross point.

## ■ X-MIX WRITE OPERATIONS

### (A) DEFINE VOICE

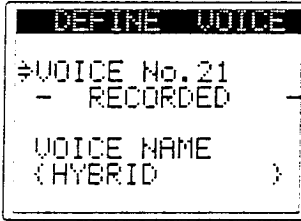
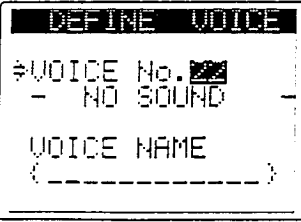

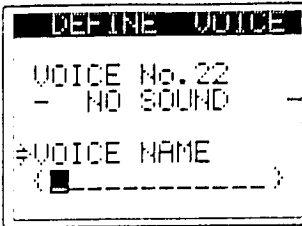
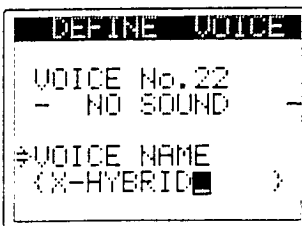
Assign a Voice Number and a Voice Name to the new sound to be created.

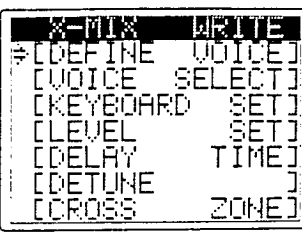

<p>(1) Enter DEFINE VOICE Operation in Cross-Mix Write Function.</p>	<p style="text-align: center;">ENTER  <input type="text"/></p>																												
<p>(2) Assign a VOICE No. to sound about to be created using the alphanumeric ten-keys.</p> <p>*If the specified voice number has not already been selected, a NO SOUND message appears in the display.</p> <p>*If the specified voice number already exists in memory, a RECORDED (or SYNTHESIZED) message appears in the display.</p>	<table border="0" style="width: 100%; text-align: center;"> <tr> <td>A B C</td> <td>D E F</td> <td>G H I</td> </tr> <tr> <td><input type="text"/></td> <td><input type="text"/></td> <td><input type="text"/></td> </tr> <tr> <td>J K L</td> <td>M N O</td> <td>P Q R</td> </tr> <tr> <td><input type="text"/></td> <td><input type="text"/></td> <td><input type="text"/></td> </tr> <tr> <td>S T U</td> <td>V W X</td> <td>Y Z</td> </tr> <tr> <td><input type="text"/></td> <td><input type="text"/></td> <td><input type="text"/></td> </tr> <tr> <td>SPACE</td> <td>= &gt; *</td> <td>- / +</td> </tr> <tr> <td><input type="text"/></td> <td><input type="text"/></td> <td><input type="text"/></td> </tr> <tr> <td></td> <td>NO</td> <td>YES</td> </tr> </table>	A B C	D E F	G H I	<input type="text"/>	<input type="text"/>	<input type="text"/>	J K L	M N O	P Q R	<input type="text"/>	<input type="text"/>	<input type="text"/>	S T U	V W X	Y Z	<input type="text"/>	<input type="text"/>	<input type="text"/>	SPACE	= > *	- / +	<input type="text"/>	<input type="text"/>	<input type="text"/>		NO	YES	
A B C	D E F	G H I																											
<input type="text"/>	<input type="text"/>	<input type="text"/>																											
J K L	M N O	P Q R																											
<input type="text"/>	<input type="text"/>	<input type="text"/>																											
S T U	V W X	Y Z																											
<input type="text"/>	<input type="text"/>	<input type="text"/>																											
SPACE	= > *	- / +																											
<input type="text"/>	<input type="text"/>	<input type="text"/>																											
	NO	YES																											

(3) Move cursor to VOICE NAME position.																													
(4) Assign a VOICE NAME using the ten-keys.	<table border="1" data-bbox="708 353 935 591"> <tr><td>A B C</td><td>D E F</td><td>G H I</td></tr> <tr><td>7</td><td>8</td><td>9</td></tr> <tr><td>J K L</td><td>M N O</td><td>P Q R</td></tr> <tr><td>4</td><td>5</td><td>6</td></tr> <tr><td>S T U</td><td>V W X</td><td>Y Z</td></tr> <tr><td>1</td><td>2</td><td>3</td></tr> <tr><td>SPACE</td><td>*/</td><td>-/+</td></tr> <tr><td>0</td><td>Y</td><td>A</td></tr> <tr><td></td><td>NO</td><td>YES</td></tr> </table>	A B C	D E F	G H I	7	8	9	J K L	M N O	P Q R	4	5	6	S T U	V W X	Y Z	1	2	3	SPACE	*/	-/+	0	Y	A		NO	YES	
A B C	D E F	G H I																											
7	8	9																											
J K L	M N O	P Q R																											
4	5	6																											
S T U	V W X	Y Z																											
1	2	3																											
SPACE	*/	-/+																											
0	Y	A																											
	NO	YES																											
(5) Press ESCAPE key to exit to Cross-Mix Write Function menu.	<p>ESCAPE</p> 																												

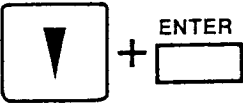
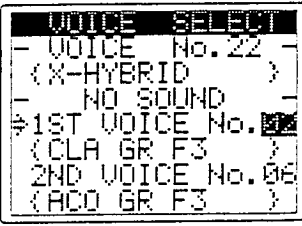
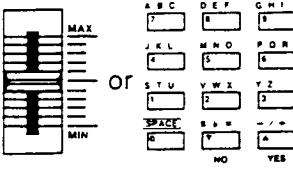
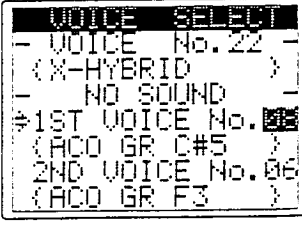
## (B) VOICE SELECT

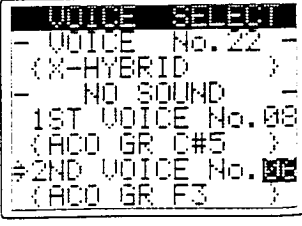
Specify the numbers of the 2 voices to be cross-mixed.

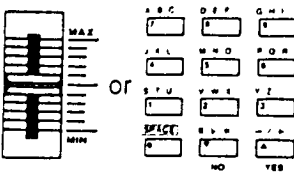
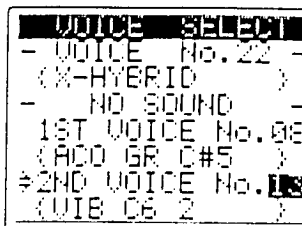

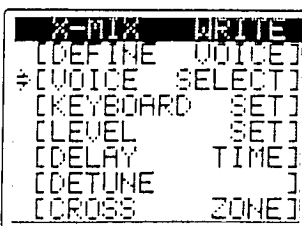
(1) Enter the VOICE SELECT Operation in the Cross-Mix Write Function.		
(2) Specify the Voice No. of one of the voices to be cross-mixed, using the ten-keys or Value slider.		
(3) Move the cursor to the 2ND VOICE position.		

<p>(4) Specify the Voice No. of the second voice to be cross-mixed, using the Value keys or Value slider.</p>	 <p>A vertical slider with 'MAX' at the top and 'MIN' at the bottom. To its right is a keypad with buttons labeled 'ABC', 'DEF', 'GHI', 'JKL', 'MNO', 'PQR', 'STU', 'VWX', 'YZ', 'SLCT', and 'NO/YES'.</p>	 <pre> <b>VOICE SELECT</b> - VOICE No.22 - (X-HYBRID ) - NO SOUND - 1ST VOICE No.08 (ACD GR C#5 ) #2ND VOICE No.18 (OIB C6 2 ) </pre>
<p>(5) Press the ESCAPE key to exit to Cross-Mix Write Function menu.</p>	<p>ESCAPE</p> 	 <pre> <b>CROSS MIX WRITE</b> [DEFINE VOICE] # [VOICE SELECT] [KEYBOARD SET] [LEVEL SET] [DELAY TIME] [DETUNE ] [CROSS ZONE] </pre>

### (C) KEYBOARD SET

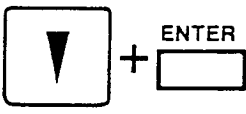
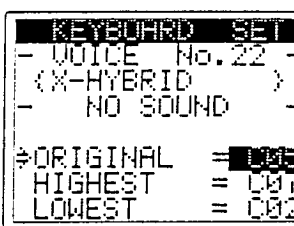
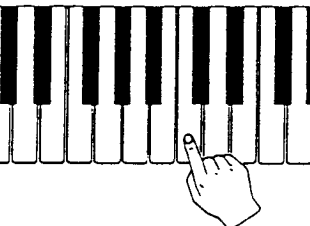
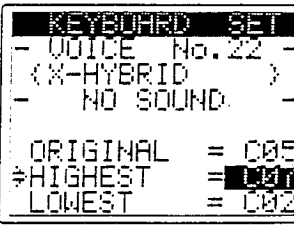
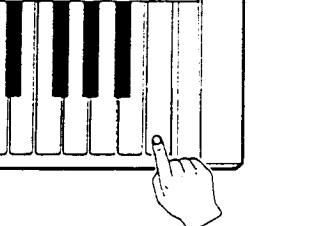
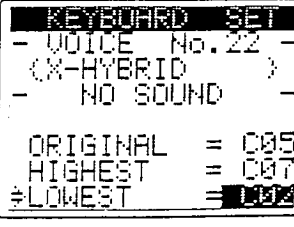
Establish key to which voice will be assigned (Original Key), as well as range within which voice will sound on the keyboard (Key Width).

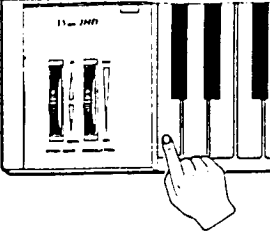
<p>(1) Enter KEYBOARD SET Operation in Cross Mix Write Function.</p> <p>*If the voice specified has not yet been created, initialized parameters will be displayed for Original, Highest and Lowest positions.</p> <p>*If the voice specified already exists, previously set parameters will be displayed.</p>	 <p>A square button with a downward-pointing triangle and a rectangular button labeled 'ENTER'.</p>	 <pre> <b>KEYBOARD SET</b> - VOICE No.22 - (X-HYBRID ) - NO SOUND - #ORIGINAL = 005 HIGHEST = 007 LOWEST = 002 </pre>
<p>(2) Specify ORIGINAL key by pressing the corresponding key on the keyboard. Cursor automatically moves to HIGHEST position.</p>	 <p>A diagram of a piano keyboard with a hand's index finger pointing to the C85 key.</p>	 <pre> <b>KEYBOARD SET</b> - VOICE No.22 - (X-HYBRID ) - NO SOUND - ORIGINAL = 005 #HIGHEST = C85 LOWEST = 002 </pre>
<p>(3) Specify the high-end limit of voice sounding range by pressing the corresponding key. Cursor automatically moves to LOWEST position.</p>	 <p>A diagram of a piano keyboard with a hand's index finger pointing to the C02 key.</p>	 <pre> <b>KEYBOARD SET</b> - VOICE No.22 - (X-HYBRID ) - NO SOUND - ORIGINAL = 005 HIGHEST = 007 #LOWEST = C02 </pre>



<p>(4) Specify the low-end limit of voice sounding range by pressing the corresponding key.</p> <p>*Cursor automatically moves back to ORIGINAL position.</p>		<pre> KEYBOARD SET - VOICE No.22 - (X-HYBRID ) - NO SOUND - =&gt;ORIGINAL = 002 HIGHEST = 007 LOWEST = 002 </pre>
<p>(5) Press ESCAPE key to exit to Cross-Mix Write Function menu.</p>	<p>ESCAPE</p> 	<pre> X-MIX WRITE [DEFINE VOICE] [VOICE SELECT] =&gt;[KEYBOARD SET] [LEVEL SET] [DELAY TIME] [DETUNE ] [CROSS ZONE] </pre>

**NOTES**

- \*Lowest-Highest range may be set between C-2 — C-7. However, this range is restricted to 3 octaves above and 3 octaves below Original position.
- \*In addition to using keyboard keys, ten-keys and Value slider may also be used to specify Original, Highest & Lowest positions.
- \*If Highest position is set below Lowest, positions are automatically reversed, with Lowest becoming Highest, and vice versa.

**(D) LEVEL SET**

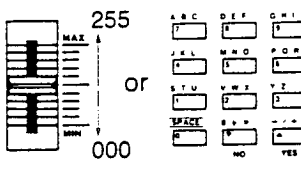
Set level of both voices to be cross-mixed.

<p>(1) Enter LEVEL SET Operation in Cross-Mix Write Function.</p>		<pre> LEVEL SET - VOICE No.22 - (X-HYBRID ) - NO SOUND - =&gt;1ST LEVEL = 127 2ND LEVEL = 127 </pre>
<p>(2) Specify level of first voice in cross-mix, using Value slider or ten-keys.</p>		<pre> LEVEL SET - VOICE No.22 - (X-HYBRID ) - NO SOUND - =&gt;1ST LEVEL = 171 2ND LEVEL = 127 </pre>
<p>(3) Move cursor to 2ND LEVEL position.</p>		<pre> LEVEL SET - VOICE No.22 - (X-HYBRID ) - NO SOUND - 1ST LEVEL = 171 =&gt;2ND LEVEL = 127 </pre>

(4) Specify level of second voice in cross-mix, using Value slider or ten-keys.

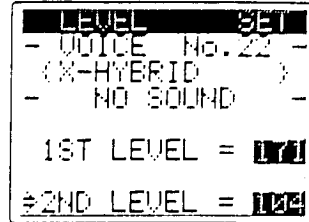
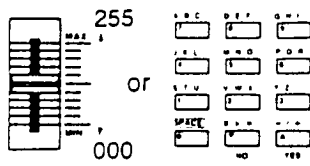

(5) Press ESCAPE key to exit to Cross-Mix Write Function menu.

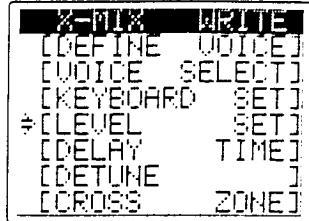

**NOTE**

Level may be set within 000 ~ 255 range. Initialized value is 127.

**(E) DELAY TIME**

Specify the starting point of the second voice in reference to the starting point of the first voice.

(1) Enter DELAY TIME Operation in Cross-Mix Write Function.

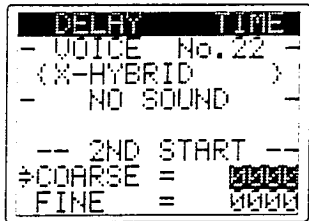
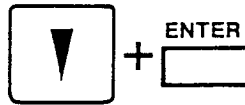

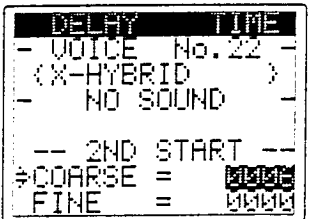
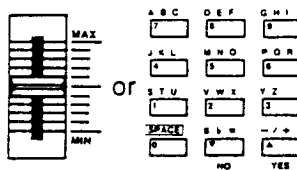

(2) Roughly specify the DELAY TIME of the second voice, using the Value slider or ten-keys.

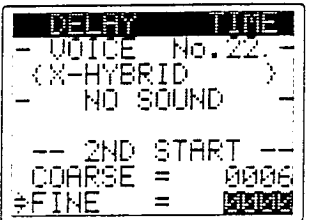

(3) Move cursor to the FINE position.



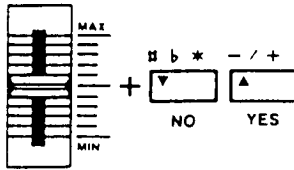
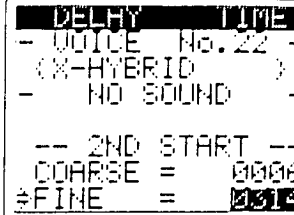

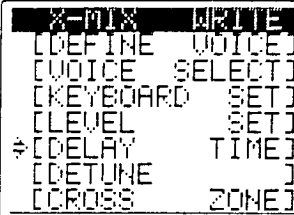
<p>(4) Make a finer approximation of DELAY TIME of second voice using the ten-keys.</p>		
<p>(5) Press the ESCAPE key to exit to Cross-Mix Write Function menu.</p>	<p>ESCAPE</p> 	

**NOTE**

Initialized values of COARSE & FINE parameters set at 000.

**■ DELAY TIME GRAPHIC DISPLAY**



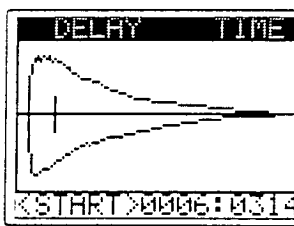
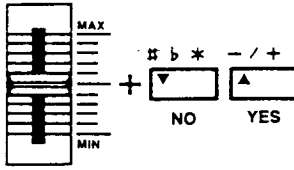
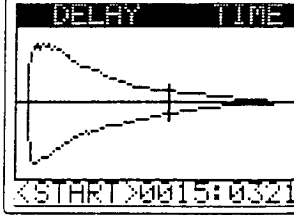

When setting this parameter, delay time of the second voice may be displayed graphically. Delay Time may also be set in this mode.

<p>(1) Press DISPLAY selector while normal DELAY TIME display is selected.</p>	<p>DISPLAY</p> 	
<p>*The graphic display operates in the same way as the Cut Sample Graphic display, however the indicator shows only the delay time in this case.</p>		

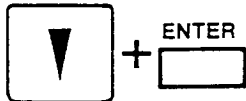
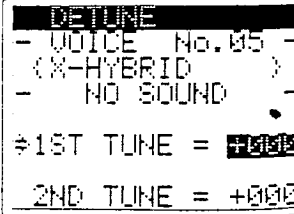
**(F) DETUNE**

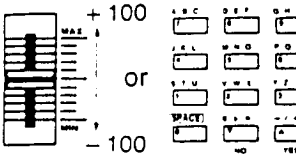
Alter the tuning of the two voices to be cross-mixed.

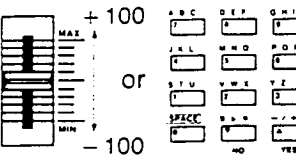
<p>(1) Enter DETUNE Operation in Cross-Mix Write Function.</p>		
--	---	--



<p>(2) Specify detuning of first voice using Value slider, Value keys or ten-keys.</p>		<pre> DETUNE - VOICE No.05 - (X-HYBRID ) - NO SOUND - #1ST TUNE = +100 2ND TUNE = +000 </pre>
<p>(3) Move cursor to 2ND TUNE position.</p>		<pre> DETUNE - VOICE No.05 - (X-HYBRID ) - NO SOUND - 1ST TUNE = +100 #2ND TUNE = +100 </pre>
<p>(4) Specify detuning of second voice using Value slider, Value keys or ten-keys.</p>		<pre> DETUNE - VOICE No.05 - (X-HYBRID ) - NO SOUND - 1ST TUNE = +100 #2ND TUNE = -100 </pre>
<p>(5) Press ESCAPE key to exit to Cross-Mix Write Function menu.</p>		<pre> X-MIX WRITE [DEFINE VOICE] [VOICE SELECT] [KEYBOARD SET] [LEVEL SET] [DELAY TIME] # [DETUNE ] [<u>CROSS</u> ZONE] </pre>

**NOTE**





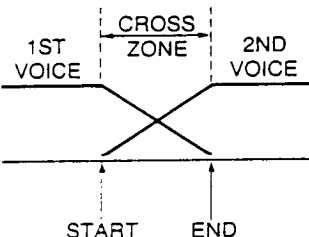
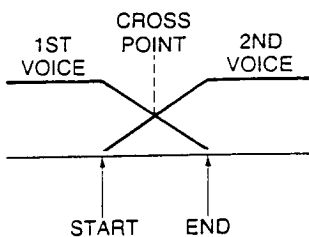

Initialized tuning for each voice is that of ORIGINAL key set when voice was sampled.

**(G) CROSS ZONE**

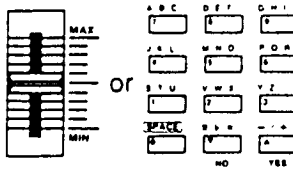
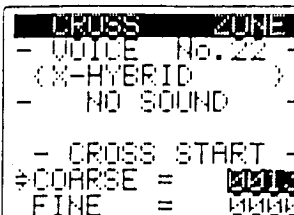
Set width of "Cross Zone."

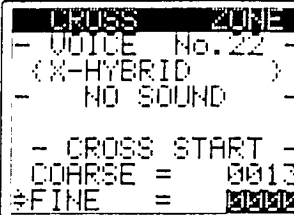
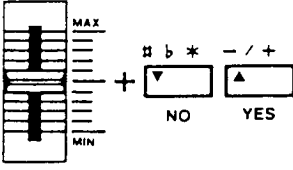
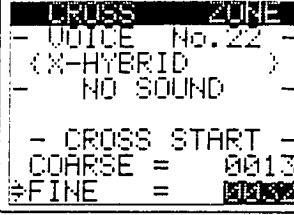

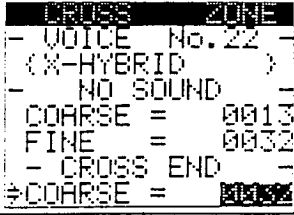
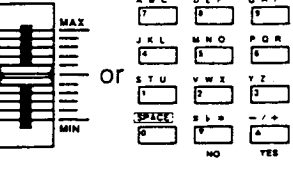
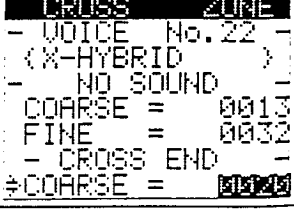
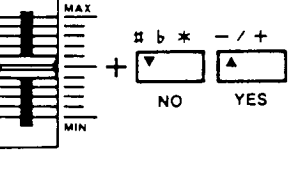
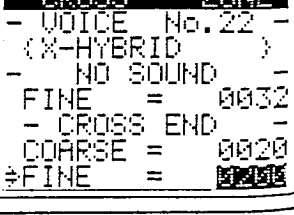

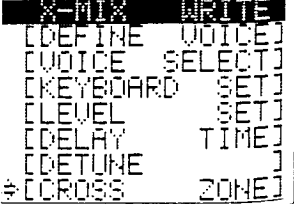
<p>This zone is equal to the time period wherein both cross-mixed voices sound. Note that the middle of this zone corresponds to the "Cross Point."</p>		
<p>(1) Enter the CROSS ZONE Operation in Cross Mix Function.</p>		<pre> CROSS ZONE - VOICE No.22 - (X-HYBRID ) - NO SOUND - - CROSS START - #COARSE = 0000 FINE = 0000 </pre>



<p>(2) Roughly set starting point of Cross Zone using the Value slider, Value keys or ten-keys.</p>	 <p>The diagram shows a vertical value slider with 'MAX' at the top and 'MIN' at the bottom. To its right is a keypad with keys labeled ABC, DEF, GHI, JKL, MNO, PQR, STU, VWX, YZ, and SPACE. Below the keypad are 'NO' and 'YES' indicators.</p>	 <p>CROSS ZONE - VOICE No.22 - (X-HYBRID ) - NO SOUND - - CROSS START - ⇨COARSE = 0013 FINE = 0000</p>
<p>(3) Move cursor to FINE position.</p>		 <p>CROSS ZONE - VOICE No.22 - (X-HYBRID ) - NO SOUND - - CROSS START - COARSE = 0013 ⇨FINE = 0000</p>
<p>(4) Make a finer approximation of Cross Zone starting point using the Value slider, Value keys or ten-keys.</p>	 <p>The diagram shows the value slider and keypad. A '+' sign is next to the slider. Below the keypad are 'NO' and 'YES' indicators.</p>	 <p>CROSS ZONE - VOICE No.22 - (X-HYBRID ) - NO SOUND - - CROSS START - COARSE = 0013 ⇨FINE = 0000</p>
<p>(5) Press cursor [▼] key.</p>		 <p>CROSS ZONE - VOICE No.22 - (X-HYBRID ) - NO SOUND - COARSE = 0013 FINE = 0032 - CROSS END - ⇨COARSE = 0032</p>
<p>(6) Roughly set ending point of Cross Zone using the Value slider, Value keys or ten-keys.</p>	 <p>The diagram shows the value slider and keypad. The word 'OR' is between the slider and keypad. Below the keypad are 'NO' and 'YES' indicators.</p>	 <p>CROSS ZONE - VOICE No.22 - (X-HYBRID ) - NO SOUND - COARSE = 0013 FINE = 0032 - CROSS END - ⇨COARSE = 0032</p>
<p>(7) Make a finer approximation of Cross Zone ending point using the Value slider, Value keys or ten-keys.</p>	 <p>The diagram shows the value slider and keypad. A '+' sign is next to the slider. Below the keypad are 'NO' and 'YES' indicators.</p>	 <p>CROSS ZONE - VOICE No.22 - (X-HYBRID ) - NO SOUND - FINE = 0032 - CROSS END - COARSE = 0020 ⇨FINE = 0020</p>
<p>(8) Press ESCAPE key to exit to Cross Mix Function menu.</p>		 <p>X-MIX WRITE [DEFINE VOICE] [VOICE SELECT] [KEYBOARD SET] [LEVEL SET] [DELAY TIME] [DETUNE ] ⇨[CROSS ZONE]</p>

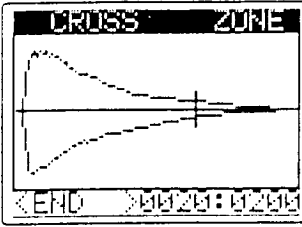

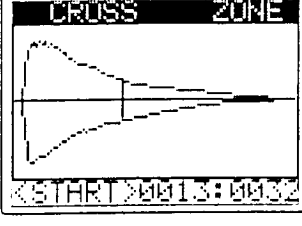

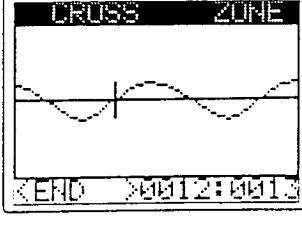
## ■ CROSS ZONE GRAPHIC DISPLAY

When setting this parameter, delay time of the second voice may be displayed graphically. Cross Zone may also be set in this mode.

<p>(1) Press DISPLAY selector while normal CROSS ZONE display is selected.</p>	<p>DISPLAY</p> 	
<p>*The graphic display operates in the same way as the Cut Sample Graphic display, however the indicator shows only the cross zone in this case.</p>		
<p>*Pressing the cursor [▼] key repeatedly gives increasing magnified views of the waveform, centering on the indicator. *To decrease magnification, simply press the cursor [▲] key repeatedly, in the same way.</p>		

## (H) EXECUTE X-MIX

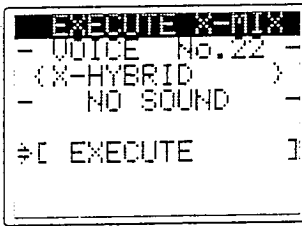
Cross-Mix sounds according to parameters set in previous procedures.

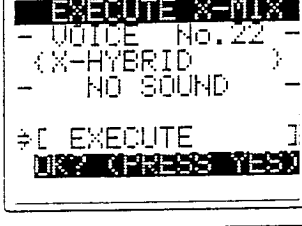
<p>(1) Enter EXECUTE CROSS-MIX Operation in Mix Write Function.</p>	 + ENTER 	
<p>(2) Press ENTER key.</p>	<p>ENTER</p> 	

(3) Respond to [OK?] prompt by pressing YES key.	<div style="text-align: center;">       - / +  <input type="button" value="▲"/>        YES     </div>	<pre> EXECUTE X-MIX - VOICE No. 22 - (X-HYBRID ) - NO SOUND - ⇨ [ EXECUTE ] EXECUTING ●       </pre>
		<pre> EXECUTE X-MIX - VOICE No. 22 - (X-HYBRID ) - RECORDED - ⇨ [ EXECUTE ] EXECUTED OK       </pre>
(4) Press ESCAPE key to exit to Mix Write Function menu.	<div style="text-align: center;">       ESCAPE  <input type="button" value="□"/> </div>	<pre> X-MIX WRITE [ VOICE SELECT ] [ KEYBOARD SET ] [ LEVEL SET ] [ DELAY TIME ] [ DETUNE ] [ CROSS ZONE ] ⇨ [ EXECUTE X-MIX ]       </pre>

## V. REVERSE WRITE

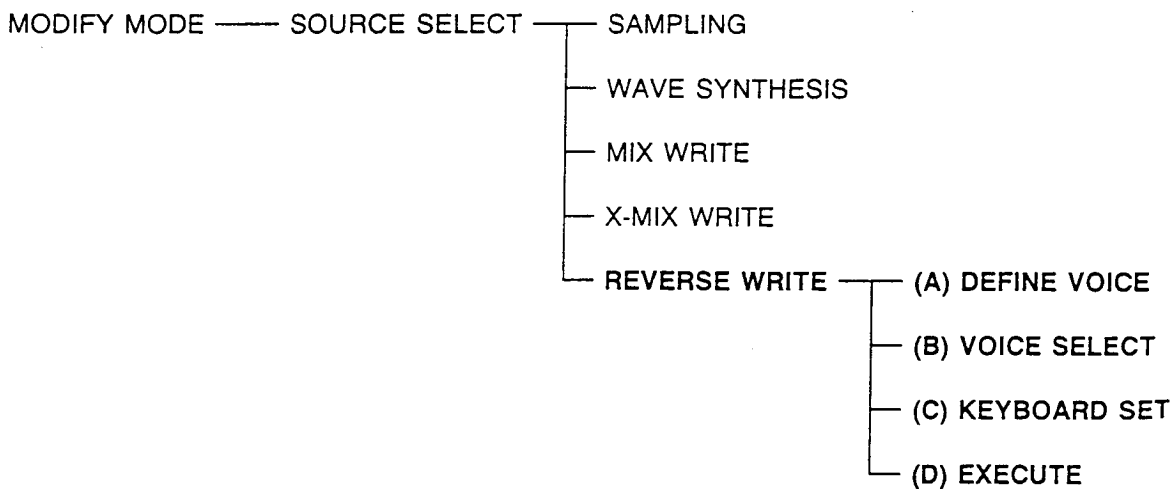





### ■ ABOUT REVERSE WRITE

The REVERSE WRITE Function can be used to reverse voices created through sampling or synthesis methods.

# ■ REVERSE WRITE PROCEDURES

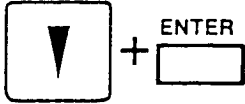
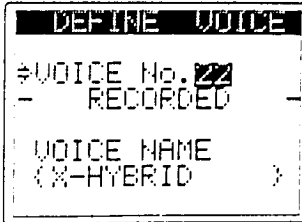
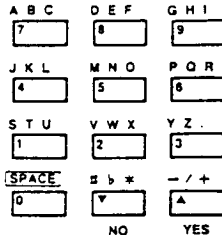
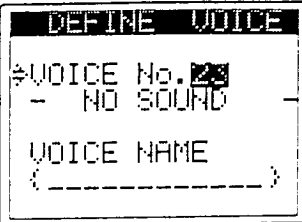

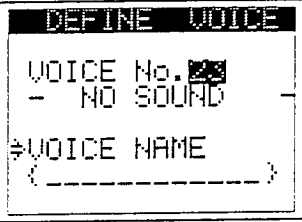
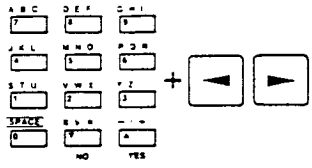
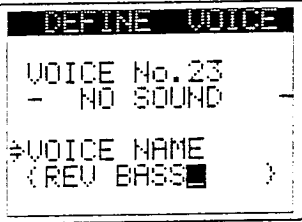
## (A) DEFINE VOICE

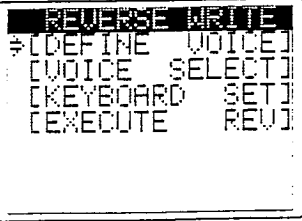
Assign a Voice Number and a Voice Name to the new sound to be created.

<p>(1) Enter DEFINE VOICE Operation in Reverse Write Function.</p>		
<p>(2) Assign a VOICE No. to sound about to be created using the alphanumeric ten-keys.</p> <ul style="list-style-type: none"> <li>*If the specified voice number has not already been selected, a NO SOUND message appears in the display.</li> <li>*If the specified voice number already exists in memory, a RECORDED (or SYNTHESIZED) message appears in the display.</li> </ul>		
<p>(3) Move cursor to VOICE NAME position.</p>		
<p>(4) Assign a VOICE NAME using the Value keys.</p>		
<p>(5) Press ESCAPE key to exit to Reverse Write Function menu.</p>		

## (B) VOICE SELECT

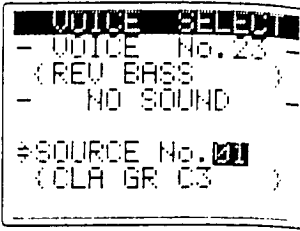
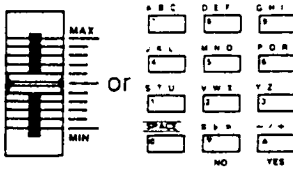
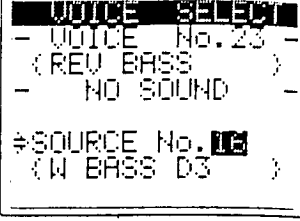
Specify the number of the voice to be reversed.

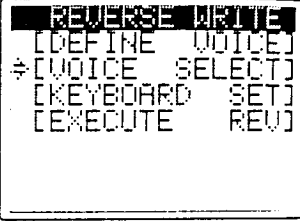
<p>(1) Enter the VOICE SELECT Operation in the Reverse Write Function.</p>		
<p>(2) Specify the Voice No. of the voice to be reversed, using the ten-keys or Value slider.</p>		
<p>(3) Press the ESCAPE key to exit to Reverse Write Function menu.</p>		

## (C) KEYBOARD SET

Establish key to which voice will be assigned (Original Key), as well as range within which voice will sound on the keyboard (Key Width).

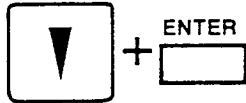
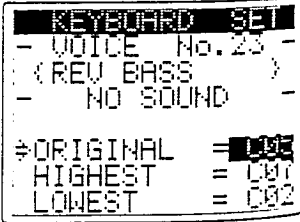
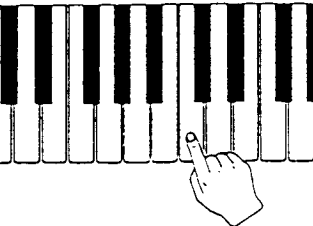
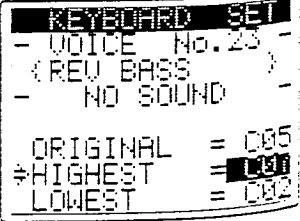
<p>(1) Enter KEYBOARD SET Operation in Reverse Write Function.</p> <p>*If the voice specified has not yet been created, initialized parameters will be displayed for Original, Highest and Lowest positions.</p> <p>*If the voice specified already exists, previously set parameters will be displayed.</p>		
<p>(2) Specify ORIGINAL key by pressing the corresponding key on the keyboard.</p>		

(3) Specify the high-end limit of voice sounding range by pressing the corresponding key. Cursor automatically moves to LOWEST position.

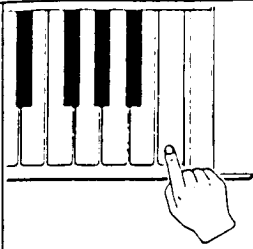

```

KEYBOARD SET
- VOICE No. 23 -
(REV BASS)
- NO SOUND -
ORIGINAL = C65
HIGHEST = C87
=>LOWEST = C02
    
```

(4) Specify the low-end limit of voice sounding range by pressing the corresponding key. Cursor automatically moves back to ORIGINAL position.

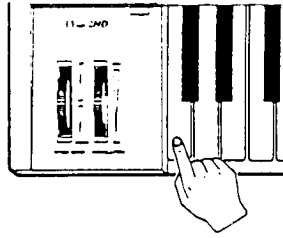

```

KEYBOARD SET
- VOICE No. 23 -
(REV BASS)
- NO SOUND -
=>ORIGINAL = C02
HIGHEST = C87
LOWEST = C65
    
```

(5) Press ESCAPE key to exit to Reverse Write Function menu.



```





REVERSE WRITE
[DEFINE VOICE]
[VOICE SELECT]
=>[KEYBOARD SET]
[EXECUTE REV]
    
```

### NOTES

- \*Lowest-Highest range may be set between C-2 — C-7. However, this range is restricted to 3 octaves above and 3 octaves below Original position.
- \*In addition to using keyboard keys, ten-keys and Value slider may also be used to specify Original, Highest & Lowest positions.
- \*If Highest position is set below Lowest, positions are automatically reversed, with Lowest becoming Highest, and vice versa.

## (D) EXECUTE REVERSE

Reverse voice specified in previous procedures.

<p>(1) Enter EXECUTE REVERSE Operation in Reverse Write Function.</p>	 + 	<pre>EXECUTE REV - VOICE No.23 -  (REV BASS ) - NO SOUND - ⇨ [ EXECUTE ]</pre>
<p>(2) Press ENTER key.</p>		<pre>EXECUTE REV - VOICE No.23 -  (REV BASS ) - NO SOUND - ⇨ [ EXECUTE ] OK? PRESS YES</pre>
<p>(3) Respond to [OK?] prompt by pressing YES key.</p>	 <p>YES</p>	<pre>EXECUTE REV - VOICE No.23 -  (REV BASS ) - NO SOUND - ⇨ [ EXECUTE ] EXECUTING ●</pre>
		<pre>EXECUTE REV - VOICE No.23 -  (REV BASS ) - RECORDED - ⇨ [ EXECUTE ] EXECUTED OK</pre>
<p>(4) Press ESCAPE key to exit to Reverse Write Function menu.</p>		<pre>REVERSE WRITE [DEFINE VOICE] [VOICE SELECT] [KEYBOARD SET] ⇨ [EXECUTE REV]</pre>

## SECTION 4:

# VOICE EDIT SUB-MODE

The Voice Edit Sub-mode may be selected from the Modify Mode menu. To access the Modify Mode menu, press the MODIFY selector.

The Voice Edit Sub-mode is used to "edit" or alter voices created in the Source Select Sub-mode, through sampling or synthesis. Within this Sub-mode are 7 Functions.

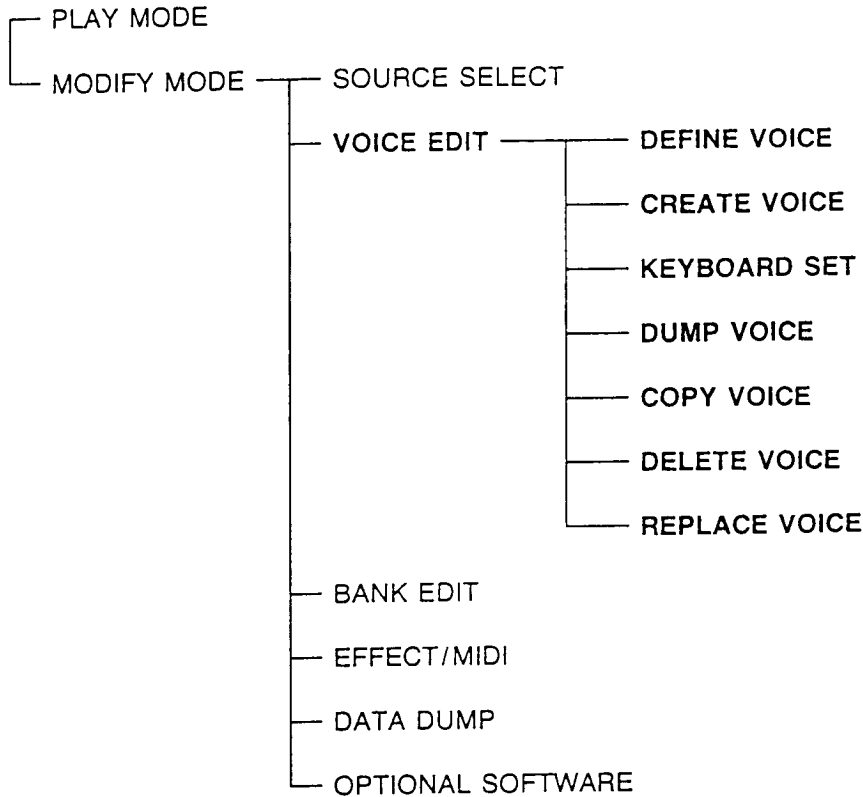



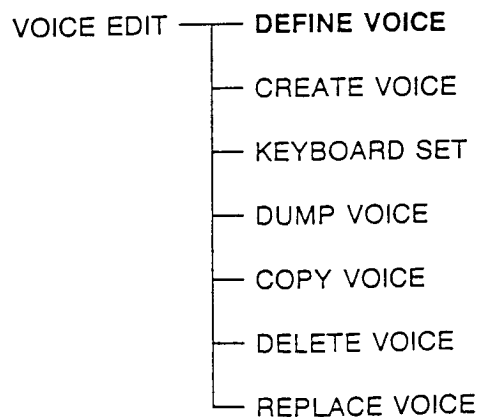

## I. DEFINE VOICE

Alter VOICE NAME of voices created using Source Select Sub-mode.

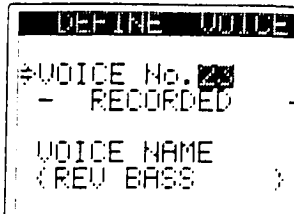
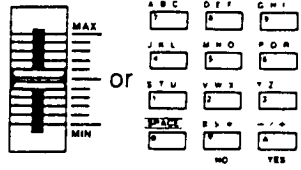
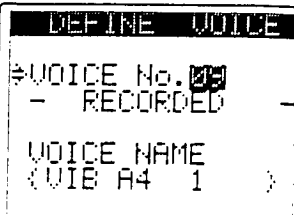

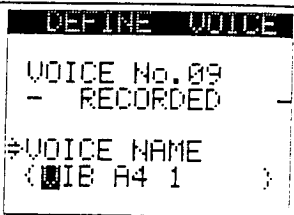
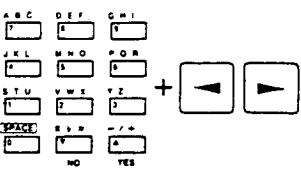
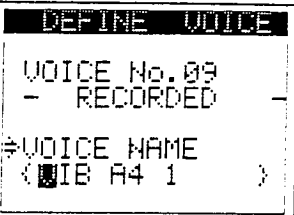

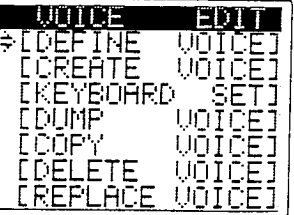
<p>(1) Enter DEFINE VOICE Function in Voice Edit Sub-mode.</p>	<p>ENTER</p> 	
<p>(2) Specify number of voice to be altered, using ten-keys, Value keys or Value slider.</p>		
<p>(3) Move cursor to VOICE NAME position.</p>		
<p>(4) Input new name if desired using ten-keys and right cursor key.</p>		
<p>(5) Press ESCAPE key to exit to Voice Edit Sub-mode menu.</p>	<p>ESCAPE</p> 	

## II. CREATE VOICE



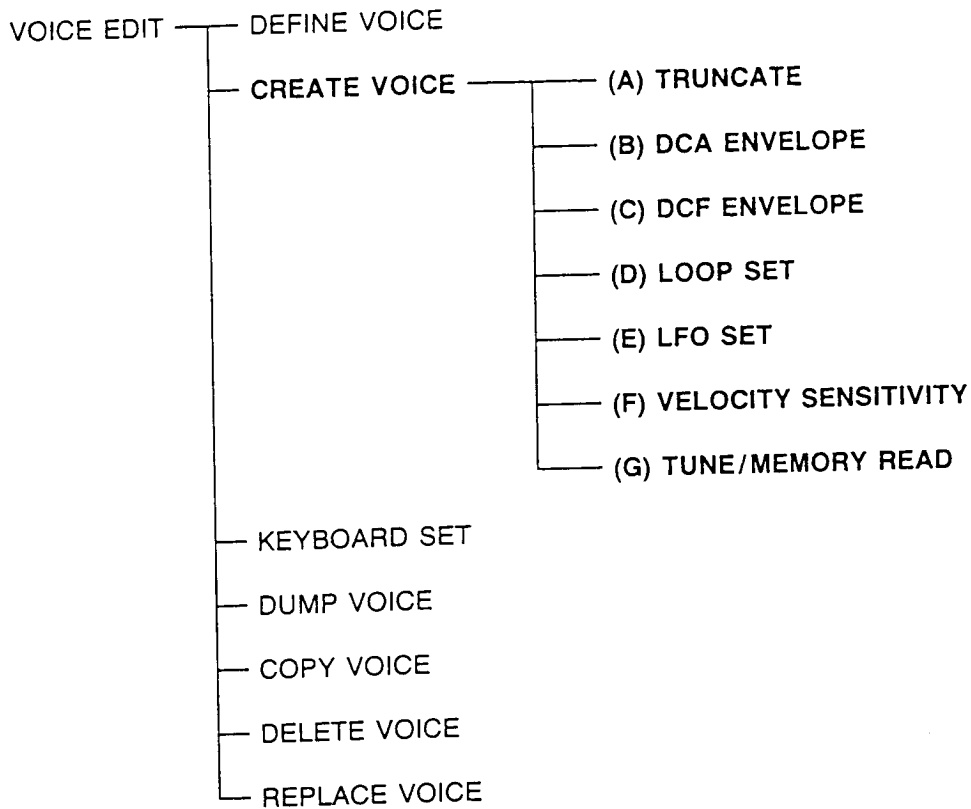

This Function is used for the actual editing of sounds created in the Source Select Sub-mode. Naturally, it would not always be necessary to edit sounds, but you can choose from any or all of the operations within this function to alter sound characteristics. Note that these operations will affect the sound specified in the Define Voice function.

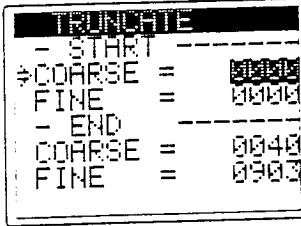
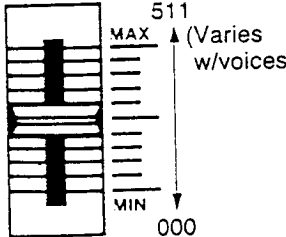
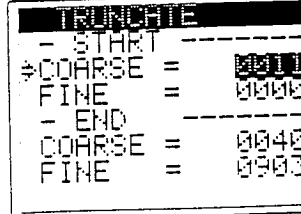

### (A) TRUNCATE

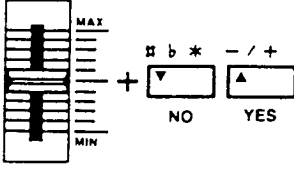

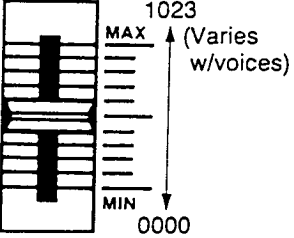
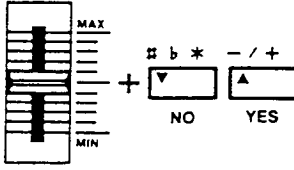



"Cut" out a section of a sampled sound by specifying a new starting point and stopping point.

<p>(1) Enter the TRUNCATE Operation in Create Voice Function.</p>	<p style="text-align: center;">ENTER</p> <div style="border: 1px solid black; width: 50px; height: 20px; margin: auto;"></div>	 <pre> TRUNCATE - START ----- ⇨ COARSE = 0000   FINE   = 0000 - END -----   COARSE = 0040   FINE   = 0900           </pre>
<p>(2) Roughly set starting point of section to be truncated using the Value slider, Value keys or ten-keys.</p>	 <p style="text-align: center;">511 MAX ↑ (Varies w/voices) MIN ↓ 000</p>	 <pre> TRUNCATE - START ----- ⇨ COARSE = 0011   FINE   = 0000 - END -----   COARSE = 0040   FINE   = 0900           </pre>

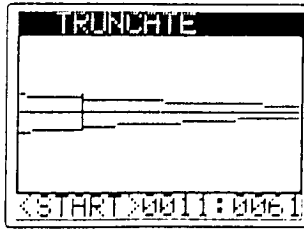
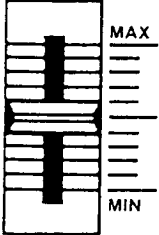
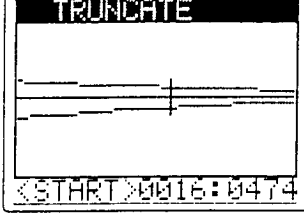
<p>(3) Move cursor to FINE position.</p>		<pre> TRUNCATE - START ----- COARSE = 0011 #FINE = 0002 - END ----- COARSE = 0040 FINE = 0903 </pre>
<p>(4) Make a finer approximation of starting point using the Value slider, Value keys or ten-keys.</p>		<pre> TRUNCATE - START ----- COARSE = 0011 #FINE = 0051 - END ----- COARSE = 0040 FINE = 0903 </pre>
<p>(5) Press cursor [▼] key.</p>		<pre> TRUNCATE - START ----- COARSE = 0011 FINE = 0061 - END ----- #COARSE = 0040 FINE = 0903 </pre>
<p>(6) Roughly set ending point of section to be truncated using the Value slider, Value keys or ten-keys.</p>		<pre> TRUNCATE - END ----- COARSE = 0011 FINE = 0061 - END ----- #COARSE = 0040 FINE = 0556 </pre>
<p>(7) Make a finer approximation of ending point using the Value slider, Value keys or ten-keys.</p>		<pre> TRUNCATE - START ----- COARSE = 0011 FINE = 0061 - END ----- COARSE = 0040 #FINE = 0556 </pre>
<p>(8) Press ESCAPE key to exit to Create Voice Function menu.</p>		<pre> CREATE VOICE # [TRUNCATE] [DCR ENVELOPE] [DCF ENVELOPE] [LOOP SET] [LPD SET] [VELOCITY SENS] [TUNE/MEM READ] </pre>

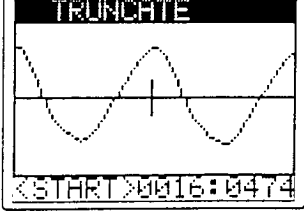
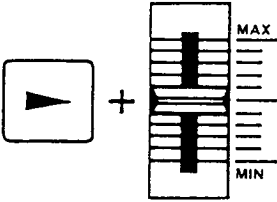

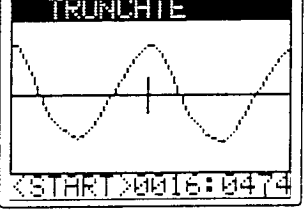

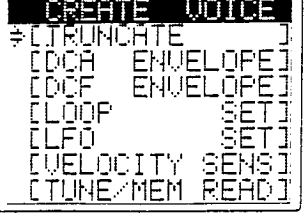
## ■ TRUNCATE GRAPHIC DISPLAY

When setting this parameter, truncation of the specified voice may be displayed graphically. Truncate parameters may also be set in this mode.

<p>(1) Press DISPLAY selector while normal TRUNCATE display is selected.</p> <p>*The graphic display operates in the same way as the Cut Sample Graphic display, however the indicator first shows the presently set start value.</p>	<p>DISPLAY</p> 	
<p>(2) Roughly adjust start position using Value slider or Value keys.</p>		
<p>(3) Press the cursor [▼] key and an enlarged view of the center section is shown.</p> <p>*When only small amounts of sampling data exist, this display may be shown first.</p>		
<p>(4) Use the Value slider, Value keys and cursor keys to attain enlarged views to the right and left of the center point. Adjustment can be made for each sampling point.</p>		
<p>(5) Press the cursor [▼] subsequently to enlarge view on vertical axis.</p>		
<p>(6) Press ESCAPE key to exit to Create Voice Function menu.</p>	<p>ESCAPE</p> 	

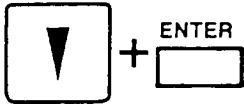

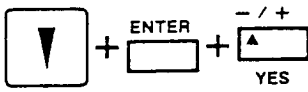
## (B) DCA ENVELOPE

Establish voice's volume change over time through DCA envelope parameters.

<p>(1) Enter DCA ENVELOPE Operation in Create Voice Function.</p>		<pre> DCA ENVELOPE #RATE KF =+02 LEVEL KF =+00 STEP 1 =+00 RATE 1 = 99 LEVEL 1 = 99 [ COPY FROM DCF ]           </pre>																											
<p>(2) Set values for each DCA ENVELOPE parameter, using cursor [▼] [▲] keys, Value slider, Value keys and ten-keys.</p>	<table border="1"> <tr> <td>A B C</td> <td>D E F</td> <td>G H I</td> </tr> <tr> <td>7</td> <td>8</td> <td>9</td> </tr> <tr> <td>J K L</td> <td>M N O</td> <td>P Q R</td> </tr> <tr> <td>4</td> <td>5</td> <td>6</td> </tr> <tr> <td>S T U</td> <td>V W X</td> <td>Y Z .</td> </tr> <tr> <td>1</td> <td>2</td> <td>3</td> </tr> <tr> <td>[SPACE]</td> <td>← →</td> <td>- / +</td> </tr> <tr> <td>0</td> <td>▼</td> <td>▲</td> </tr> <tr> <td></td> <td>NO</td> <td>YES</td> </tr> </table>	A B C	D E F	G H I	7	8	9	J K L	M N O	P Q R	4	5	6	S T U	V W X	Y Z .	1	2	3	[SPACE]	← →	- / +	0	▼	▲		NO	YES	<pre> DCA ENVELOPE RATE KF =-02 LEVEL KF =+02 STEP 1 =SUS RATE 1 = 99 #LEVEL 1 = 99 [ COPY FROM DCF ]           </pre>
A B C	D E F	G H I																											
7	8	9																											
J K L	M N O	P Q R																											
4	5	6																											
S T U	V W X	Y Z .																											
1	2	3																											
[SPACE]	← →	- / +																											
0	▼	▲																											
	NO	YES																											
<p>(3) Use the cursor [◀] &amp; [▶] to increment or decrement STEP number.</p>		<pre> DCA ENVELOPE RATE KF =-02 LEVEL KF =+02 #STEP 2 =SUS RATE 2 = 99 LEVEL 2 = 99 [ COPY FROM DCF ]           </pre>																											
<p>(4) If desired, use [COPY FROM DCF] function to copy STEP and RATE parameter settings from DCF Envelope operation.</p>		<pre> DCA ENVELOPE RATE KF =-02 LEVEL KF =+02 STEP 2 =SUS RATE 2 = 99 LEVEL 2 = 99 # [ COPY FROM DCF ] EXECUTED OK           </pre>																											
<p>(5) Press ESCAPE key to exit to Create Voice menu.</p>		<pre> CREATE VOICE [ TRUNCATE ] # [ DCA ENVELOPE ] [ DCF ENVELOPE ] [ LOOP SET ] [ LFO SET ] [ VELOCITY SENS ] [ TUNE/MEM READ ]           </pre>																											

## ■ DCA ENVELOPE GRAPHIC DISPLAY

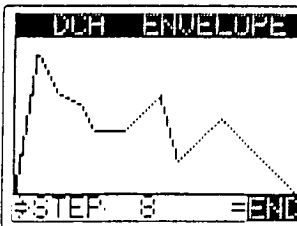
The DCA ENVELOPE parameters can be set using a graphic display.

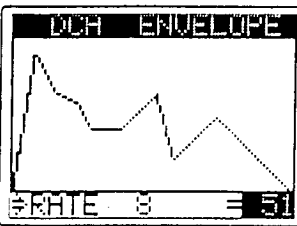
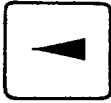
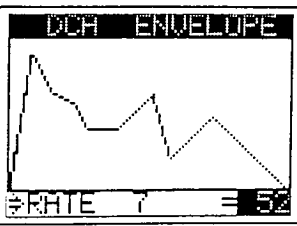



<p>(1) Press DISPLAY key while normal DCA ENVELOPE display is selected.</p>	<p>DISPLAY</p> 	
<p>(2) Use cursor [▼] [▲] keys to select STEP, RATE &amp; LEVEL parameters. Set parameters using Value slider, Value keys or ten-keys.</p>		
<p>(3) Use cursor [◀] [▶] keys to increment or decrement STEP.</p>		



### NOTE

When in this mode, all keys sound according to present parameter settings.

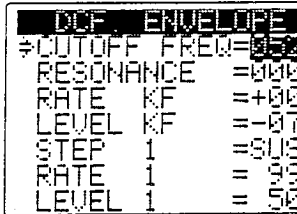
## (C) DCF ENVELOPE

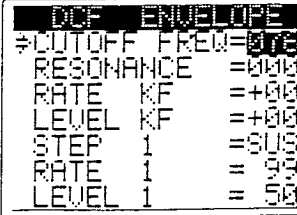

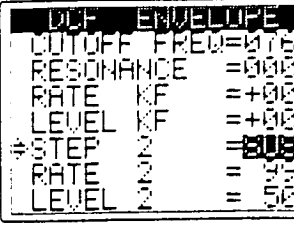
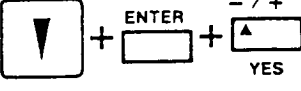
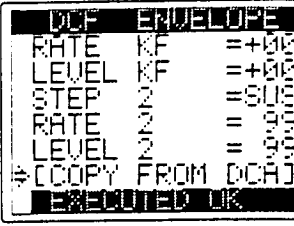

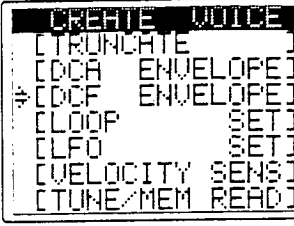
Establish filter envelope settings including cutoff bias of filter and Q level (resonance).

<p>(1) Enter DCF ENVELOPE Operation in Create Voice Function.</p>	 + ENTER 																									
<p>(2) Set values for each DCF ENVELOPE parameter, using cursor [▼] [▲] keys, Value slider, Value keys and ten-keys.</p>	 + <table border="1" data-bbox="790 1512 965 1691"> <tr> <td>ABC</td><td>DEF</td><td>GHI</td></tr> <tr> <td>7</td><td>8</td><td>9</td></tr> <tr> <td>JKL</td><td>MNO</td><td>PQR</td></tr> <tr> <td>4</td><td>5</td><td>6</td></tr> <tr> <td>STU</td><td>VWX</td><td>YZ.</td></tr> <tr> <td>1</td><td>2</td><td>3</td></tr> <tr> <td>SPACE</td><td>0</td><td>/+&gt;</td></tr> <tr> <td>0</td><td>NO</td><td>YES</td></tr> </table>	ABC	DEF	GHI	7	8	9	JKL	MNO	PQR	4	5	6	STU	VWX	YZ.	1	2	3	SPACE	0	/+>	0	NO	YES	
ABC	DEF	GHI																								
7	8	9																								
JKL	MNO	PQR																								
4	5	6																								
STU	VWX	YZ.																								
1	2	3																								
SPACE	0	/+>																								
0	NO	YES																								

<p>(3) Use the cursor [◀] &amp; [▶] to increment or decrement STEP number.</p>		
<p>(4) If desired, use [COPY FROM DCA] function to copy STEP and RATE parameter settings from DCF Envelope operation.</p>		
<p>(5) Press ESCAPE key to exit to Create Voice Function menu.</p>		

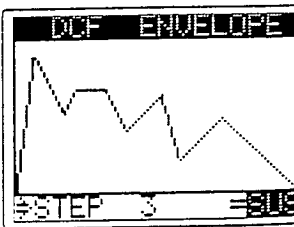
### ■ DCF ENVELOPE GRAPHIC DISPLAY

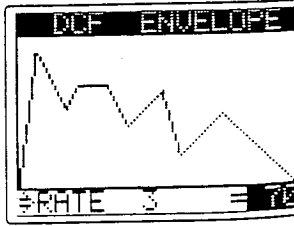
The DCF ENVELOPE parameters can be set using a graphic display.

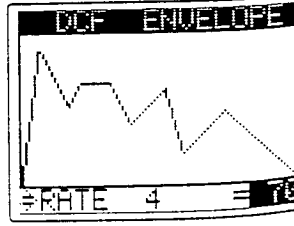
<p>(1) Press DISPLAY key while normal DCF ENVELOPE display is selected.</p>		
<p>(2) Use cursor [▼] [▲] keys to select STEP, RATE &amp; LEVEL parameters. Set parameters using Value slider, Value keys or ten-keys.</p>		
<p>(3) Use cursor [◀] [▶] keys to increment or decrement STEP.</p>		





#### NOTE

When in this mode, all keys sound according to present parameter settings.

## (D) LOOP SET

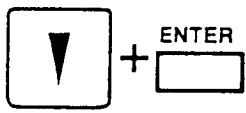
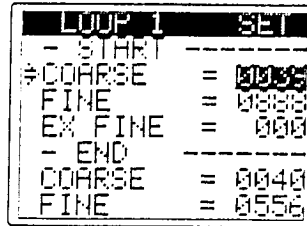
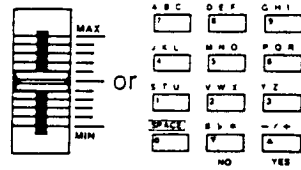
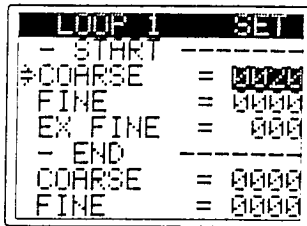

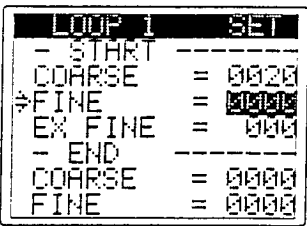
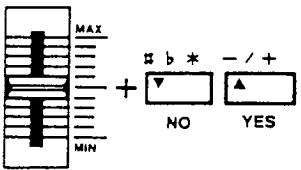
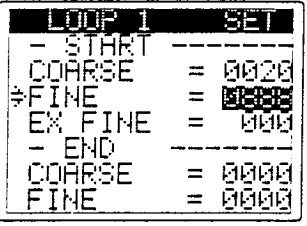
Specify LOOP parameters for selected voice, including Start Point, End Point, Loop Time, Cross-feed Time and Trace/Skip-Next settings.

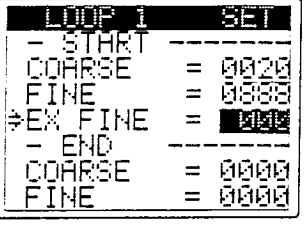
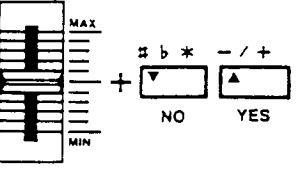
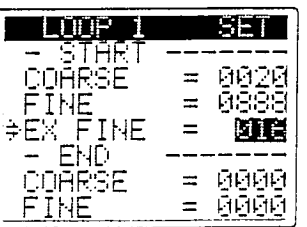
### SET START POINT

<p>(1) Enter LOOP SET Operation in Create Voice Function.</p>		
<p>(2) Roughly specify Loop START point, using Value slider or Value keys.</p>		
<p>(3) Move cursor to FINE position.</p>		
<p>(4) Make a finer approximation of LOOP START point, using Value slider or Value keys.</p>		
<p>(5) Move cursor to EX FINE position.</p>		
<p>(6) Using Value keys and ten-keys, specify exact position of Loop START point. *Note that EX FINE increments are equal to 256 divisions of sampled sound.</p>		

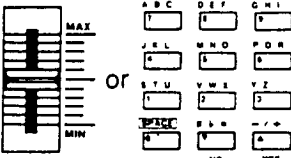

## SET END POSITION

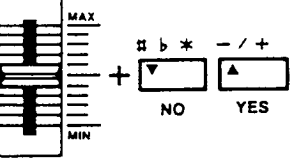
(7) Move cursor to END COARSE position.		<pre> LOOP 1 SET - START ----- COARSE   = 0020 FINE     = 0888 EX FINE  = 016 - END ----- ⇒COARSE  = 0020 FINE     = 0556         </pre>
(8) Roughly specify Loop END point, using Value slider or Value keys.		<pre> LOOP 1 SET - START ----- COARSE   = 0020 FINE     = 0888 EX FINE  = 016 - END ----- ⇒COARSE  = 0040 FINE     = 0556         </pre>
(9) Move cursor to FINE position.		<pre> LOOP 1 SET - START ----- COARSE   = 0038 FINE     = 0888 EX FINE  = 016 - END ----- COARSE   = 0040 ⇒FINE    = 0556         </pre>
(10) Make a finer approximation of Loop END point, using Value slider or Value keys.		<pre> LOOP 1 SET - START ----- COARSE   = 0020 FINE     = 0888 EX FINE  = 016 - END ----- COARSE   = 0040 ⇒FINE    = 0556         </pre>

### ■ LOOP SET GRAPHIC DISPLAY

These parameters can also be set using a Graphic Display. Operation of this graphic display is similar to that of the Truncate and other functions.

### SET LOOP & CROSS-FEED TIMES

(11) Press cursor [▼] key.		<pre> LOOP 1 SET COARSE   = 0020 FINE     = 0888 EX FINE  = 160 - END ----- COARSE   = 0040 FINE     = 0548 ⇒LOOP TIME = 0000         </pre>
----------------------------	---	--

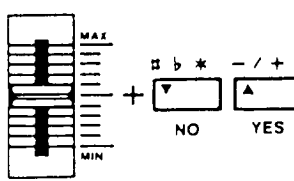
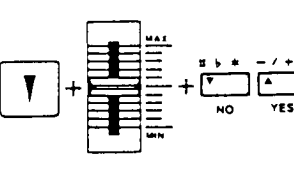
<p>(12) Specify LOOP TIME using Value slider, Value keys or ten-keys.</p>		<pre> LOOP 1  SET COARSE = 0020 FINE   = 0888 EX FINE = 160 - END  ----- COARSE = 0040 FINE   = 0548 =&gt;LOOP TIME= 1023 </pre>
<p>(13) Specify CROSS TIME using Value slider, value keys or ten-keys.</p>		<pre> LOOP 1  SET FINE   = 0888 EX FINE = 160 - END  ----- COARSE = 0040 FINE   = 0548 LOOP TIME= 1023 =&gt;CROSS TIME= 0000 </pre>

**■ About the Cross-Fade Function**

The cross-fade effect is similar to the Cross-Mix write function. As the FZ-1 uses a Jump Back loop method, this effect allows for a smooth transition from the loop end point to the loop start point. Cross fade time is, practically speaking, the same as Cross-Mix time in the Cross-Mix Write function. In the initialized state, Cross-fade time is set at "000."

**SPECIFY NEXT LOOP**

If no END point is specified in above procedures, the next LOOP may be specified.

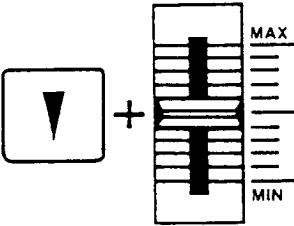
<p>(1) Press the cursor [▶] key.</p>		<pre> LOOP 2  SET FINE   = 0888 EX FINE = 160 - END  ----- COARSE = 0040 FINE   = 0548 =&gt;LOOP TIME= 808 CROSS TIME= 1023 </pre>
<p>(2) Enter parameters for second loop as in above procedures.</p>		<pre> LOOP 2  SET FINE   = 0050 EX FINE = 0160 - END  ----- COARSE = 0040 FINE   = 0548 LOOP TIME= 808 =&gt;CROSS TIME= 0000 </pre>
<p>(3) To TRACE or SKIP the specified section, select the TRACE or SKIP at the bottom of the menu.</p>		<pre> LOOP 2  SET EX FINE = 160 - END  ----- COARSE = 0040 FINE   = 0548 LOOP TIME= 808 CROSS TIME= 298 =&gt;NEXT  = 808 </pre>

## (E) LFO SET

Specify modulation-related parameters.

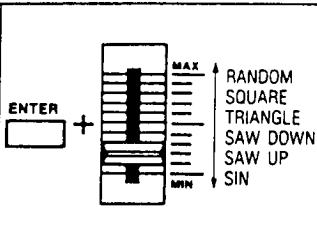
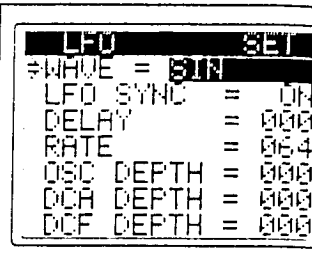
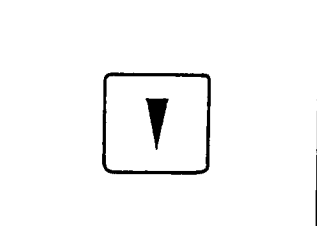
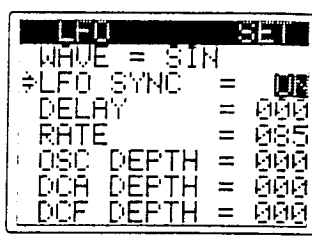
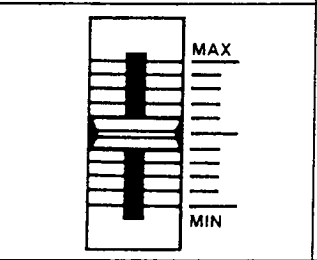
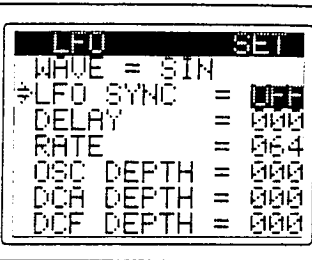
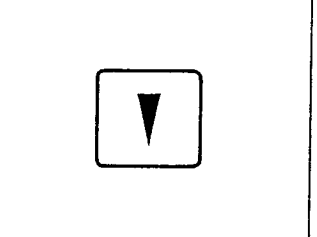
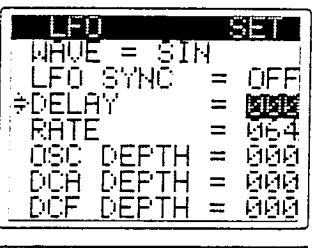
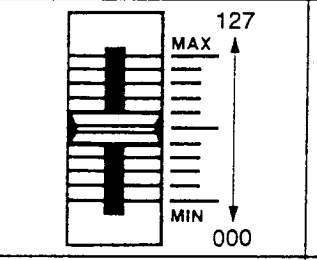
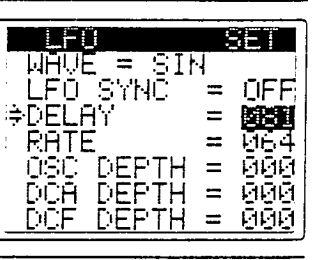
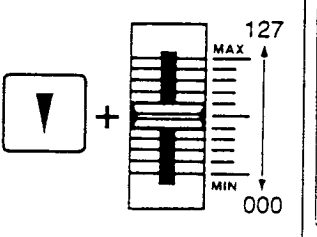
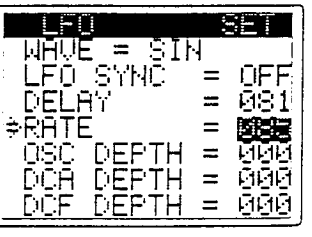

<p>(1) Specify type of WAVE to be used in LFO using the Value slider or Value keys.</p>		
<p>(2) Move cursor to LFO SYNC position.</p>		
<p>(3) Specify whether LFO is synced within voice, using Value slider. (Set to ON or OFF.) *If voice is used in a BANK, LFO SYNC parameter can be used to synch modulation with other voices in BANK.</p>		
<p>(4) Move cursor to DELAY position.</p>		
<p>(5) Specify delay of LFO using Value slider or Value keys.</p>		
<p>(6) Specify RATE of modulation using Value slider or Value keys.</p>		

(7) Specify DEPTH of OSC (pitch) modulation using Value slider or Value keys.		<pre> LFO SET WAVE = SIN LFO SYNC = OFF DELAY = 081 RATE = 085 ⇒ OSC DEPTH = 018 DCA DEPTH = 000 DCF DEPTH = 000 </pre>
(8) Specify DEPTH of DCA (amp) modulation using Value slider or Value keys.		<pre> LFO SET WAVE = SIN LFO SYNC = OFF DELAY = 081 RATE = 085 OSC DEPTH = 013 ⇒ DCA DEPTH = 008 DCF DEPTH = 000 </pre>
(9) Specify DEPTH of DCF (filter) modulation using Value slider or Value keys.		<pre> LFO SET WAVE = SIN LFO SYNC = OFF DELAY = 081 RATE = 085 OSC DEPTH = 013 DCA DEPTH = 078 ⇒ DCF DEPTH = 008 </pre>
(10) Press ESCAPE key to exit to Create Voice Function menu.	<p>ESCAPE</p>	<pre> CREATE VOICE [TRUNCATE] [DCA ENVELOPE] [DCF ENVELOPE] [LOOP SET] ⇒ [LFO SET] [VELOCITY SENS] [TUNE/MEM READ] </pre>

## (F) VELOCITY SENSITIVITY

Specify sensitivity parameters of FZ-1 velocity-sensitive functions.

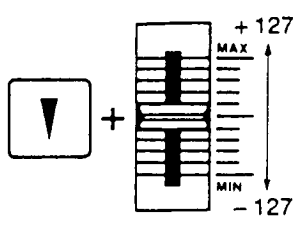
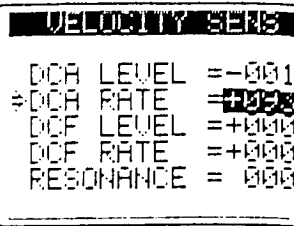
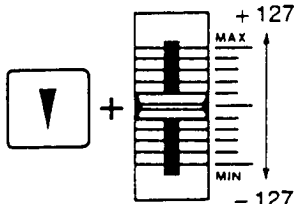
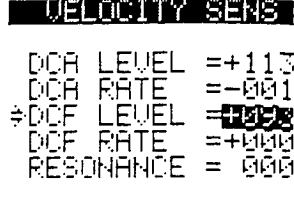
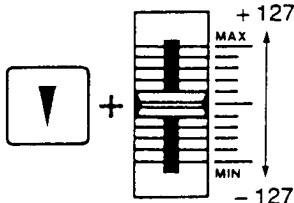
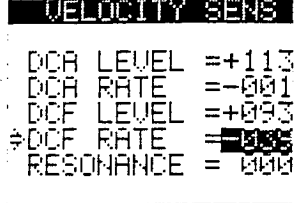
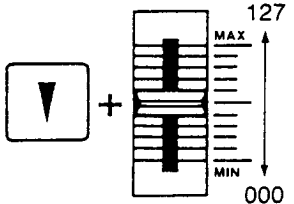
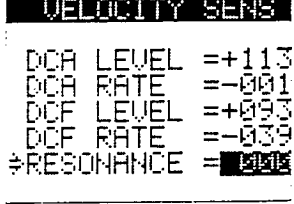
(1) Enter VELOCITY SENSITIVITY Operation in Create Voice Function.		<pre> VELOCITY SENS ⇒ DCA LEVEL = +000 DCA RATE = +000 DCF LEVEL = +000 DCF RATE = +000 RESONANCE = 000 </pre>
(2) Specify LEVEL of DCA (volume) sensitivity using Value slider, Value keys or ten-keys.		<pre> VELOCITY SENS ⇒ DCA LEVEL = +018 DCA RATE = +000 DCF LEVEL = +056 DCF RATE = +000 RESONANCE = 000 </pre>

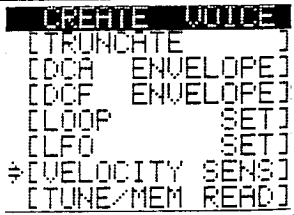
<p>(3) Specify RATE of change in DCA according to velocity, using Value slider, Value keys or ten-keys.</p>		
<p>(4) Specify affect of velocity on changes in filter cutoff frequency (DCF LEVEL), using Value slider, Value keys or ten-keys.</p>		
<p>(5) Specify RATE of change in filter cutoff frequency according to velocity, using Value slider, Value keys or ten-keys.</p>		
<p>(6) Specify velocity effect on Resonance peak value using Value slider, Value keys or ten-keys.</p>		
<p>(7) Press ESCAPE key to exit to Create Voice menu.</p>		

### (G) TUNE/MEMORY-READ

The Tune setting can be used to alter tunings of individual voices created in the Source Select Sub-mode.

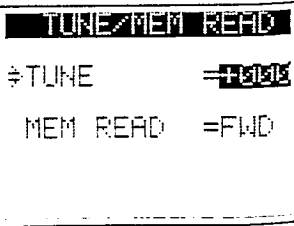
<p>(1) Enter TUNE/MEMORY-READ Operation in Create Voice Function.</p>		
---	---	--

(2) Specify tuning of selected voice using Value slider, Value keys or ten-keys.

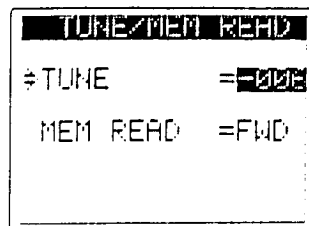
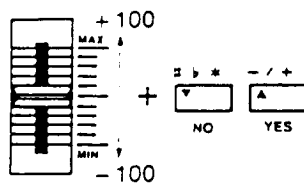

(3) Move cursor to MEM READ position.

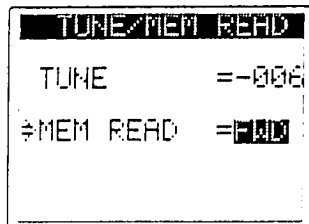

(4) Select FWD, REV or CUE function with Value slider, Value keys or ten-keys.

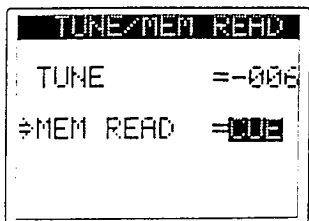
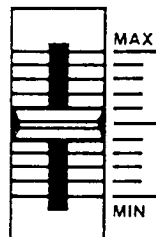

### ■ ABOUT MEMORY READ



The Memory-Read setting is used to specify how voices created through Sampling are voiced. Choose from FWD (as sampled), REV (reverse) and CUE parameters. The cue parameter can be used to obtain a "scratch" type sound similar to that effected when cueing a record back and forth (as heard in "rap" and other types of music).

Subsequently, when a voice is programmed for CUE operation it is sounded by operating the Pitch Bender, instead of keyboard keys.

### III. KEYBOARD SET

Alter the keyboard set parameters set in Voice Edit Sub-mode.

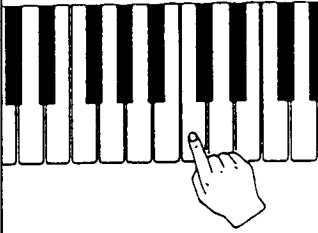
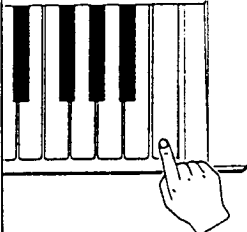
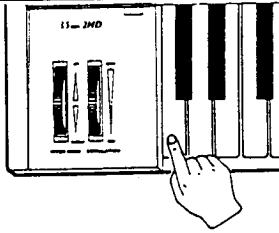
- VOICE EDIT — DEFINE VOICE
- CREATE VOICE
- **KEYBOARD SET**
- DUMP VOICE
- COPY VOICE
- DELETE VOICE
- REPLACE VOICE

(1) Enter KEYBOARD SET Function in Voice Edit Sub-mode.		<pre> KEYBOARD SET - VOICE No.09 - (VIB A4 1 ) - RECORDED -  ORIGINAL = #104 HIGHEST = #104 LOWEST = C02 </pre>
(2) Specify ORIGINAL key by pressing the corresponding key on the keyboard.		<pre> KEYBOARD SET - VOICE No.09 - (VIB A4 1 ) - RECORDED -  ORIGINAL = C05 HIGHEST = #104 LOWEST = C02 </pre>
(3) Specify the high-end limit of voice sounding range by pressing the corresponding key. Cursor automatically moves to LOWEST position.		<pre> KEYBOARD SET - VOICE No.09 - (VIB A4 1 ) - RECORDED -  ORIGINAL = C05 HIGHEST = C07 LOWEST = C02 </pre>
(4) Specify the low-end limit of voice sounding range by pressing the corresponding key. Cursor automatically moves back to ORIGINAL position.		<pre> KEYBOARD SET - VOICE No.09 - (VIB A4 1 ) - RECORDED -  ORIGINAL = C02 HIGHEST = C07 LOWEST = C02 </pre>
(5) Press ESCAPE key to exit to Voice Edit Sub-mode main menu.		<pre> VOICE EDIT [DEFINE VOICE] [CREATE VOICE] HIGHEST [KEYBOARD SET] [Dump VOICE] [Copy VOICE] [DELETE VOICE] [REPLACE VOICE] </pre>

#### NOTES

- \*Lowest-Highest range may be set between C-2 — C-7. However, this range is restricted to 3 octaves above and 3 octaves below Original position.
- \*In addition to using keyboard keys, Value keys and Value slider may also be used to specify Original, Highest & Lowest positions.
- \*If Highest position is set below Lowest, positions are automatically reversed, with Lowest becoming Highest, and vice versa.

## IV. DUMP VOICE

This function allows Load, Save, Verify and Erasure of voice data created in the Voice Edit Sub-mode. Operations in this Function are exactly the same as those or the "Voice Dump Function" of the Data Dump Sub-mode. For details, refer to SECTION 6 of this manual. \*Note that when using this function in the Voice Edit Sub-mode, the Voice number has already been defined at this stage.

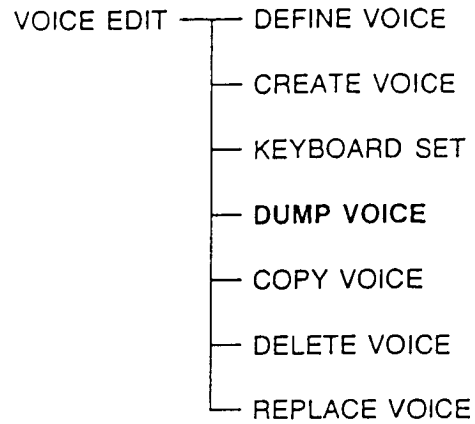



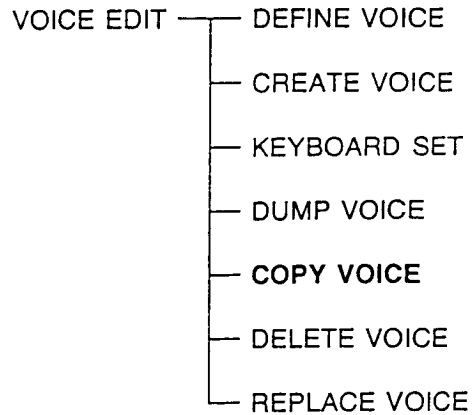

## V. COPY VOICE

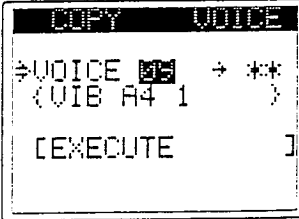
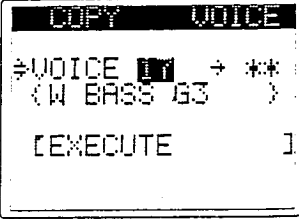
Copy Voice and Edit data from one voice into another.

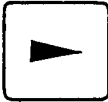

<p>(1) Enter COPY VOICE Function in Voice Edit Sub-mode.</p>	<p style="text-align: center;">ENTER</p> <div style="border: 1px solid black; width: 50px; height: 20px; margin: auto;"></div>																												
<p>(2) Enter Voice Number of SOURCE voice using Value slider, Value keys or ten-keys.</p>	<table border="0" style="width: 100%; text-align: center;"> <tr> <td>A B C</td> <td>D E F</td> <td>G H I</td> </tr> <tr> <td>7</td> <td>8</td> <td>9</td> </tr> <tr> <td>J K L</td> <td>M N O</td> <td>P Q R</td> </tr> <tr> <td>4</td> <td>5</td> <td>6</td> </tr> <tr> <td>S T U</td> <td>V W X</td> <td>Y Z .</td> </tr> <tr> <td>1</td> <td>2</td> <td>3</td> </tr> <tr> <td>SPACE</td> <td># b *</td> <td>- / +</td> </tr> <tr> <td>0</td> <td>v</td> <td>A</td> </tr> <tr> <td></td> <td>NO</td> <td>YES</td> </tr> </table>	A B C	D E F	G H I	7	8	9	J K L	M N O	P Q R	4	5	6	S T U	V W X	Y Z .	1	2	3	SPACE	# b *	- / +	0	v	A		NO	YES	
A B C	D E F	G H I																											
7	8	9																											
J K L	M N O	P Q R																											
4	5	6																											
S T U	V W X	Y Z .																											
1	2	3																											
SPACE	# b *	- / +																											
0	v	A																											
	NO	YES																											



<p>(3) Press cursor [▶] key.</p>		<pre> COPY VOICE #VOICE 17 → <del>44</del> (W BASS G3 ) [EXECUTE ] </pre>																											
<p>(4) Enter Voice Number of DESTINATION voice (voice to be copied into) using Value slider, Value keys or ten-keys.</p>	<table border="1"> <tr> <td>A B C</td> <td>D E F</td> <td>G H I</td> </tr> <tr> <td>7</td> <td>8</td> <td>9</td> </tr> <tr> <td>J K L</td> <td>M N O</td> <td>P Q R</td> </tr> <tr> <td>4</td> <td>5</td> <td>6</td> </tr> <tr> <td>S T U</td> <td>V W X</td> <td>Y Z .</td> </tr> <tr> <td>1</td> <td>2</td> <td>3</td> </tr> <tr> <td>SPACE</td> <td>B * *</td> <td>- / +</td> </tr> <tr> <td>0</td> <td>↓</td> <td>↑</td> </tr> <tr> <td></td> <td>NO</td> <td>YES</td> </tr> </table>	A B C	D E F	G H I	7	8	9	J K L	M N O	P Q R	4	5	6	S T U	V W X	Y Z .	1	2	3	SPACE	B * *	- / +	0	↓	↑		NO	YES	<pre> COPY VOICE #VOICE 17 → 45 (W BASS G3 ) [EXECUTE ] </pre>
A B C	D E F	G H I																											
7	8	9																											
J K L	M N O	P Q R																											
4	5	6																											
S T U	V W X	Y Z .																											
1	2	3																											
SPACE	B * *	- / +																											
0	↓	↑																											
	NO	YES																											
<p>(5) Move cursor to [EXECUTE] position and press Enter key.</p>	 + 	<pre> COPY VOICE VOICE 17 → 45 (W BASS G3 ) #EXECUTE ] OK? (PRESS YES) </pre>																											
<p>(6) Respond to [OK?] prompt by pressing YES key. *If specified DESTINATION voice number already contains a voice, a [VOICE DELETE?] prompt appears in place of [OK?] prompt. To replace with SOURCE voice, press YES key.</p>	<p>- / +</p>  YES	<pre> COPY VOICE VOICE 17 → 45 (W BASS G3 ) #EXECUTE ] EXECUTED OK </pre>																											
<p>(7) Press ESCAPE key to exit to Voice Edit Sub-mode main menu.</p>	<p>ESCAPE</p> 	<pre> VOICE EDIT [DEFINE VOICE] [CREATE VOICE] [KEYBOARD SET] [DUMP VOICE] #COPY VOICE] [DELETE VOICE] [REPLACE VOICE] </pre>																											

**NOTE**

Throughout COPY VOICE operations, SOURCE voice may be sounded on keyboard.

# VI. DELETE VOICE



Erase entire voice or unused parts of voice from FZ-1 memory.



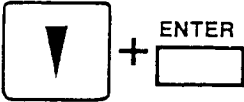
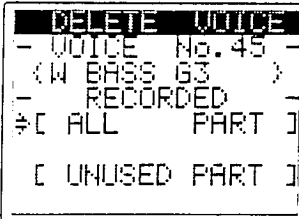

VOICE EDIT

- DEFINE VOICE
- CREATE VOICE
- KEYBOARD SET
- DUMP VOICE
- COPY VOICE
- DELETE VOICE
- REPLACE VOICE

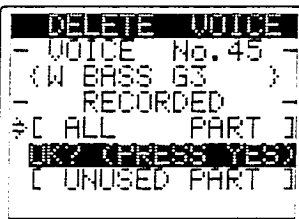
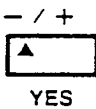
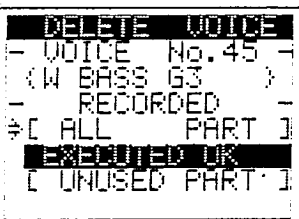
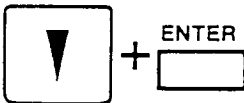
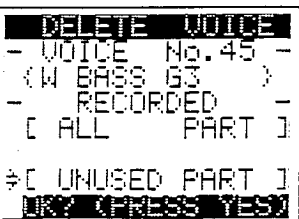
## ■ ABOUT UNUSED VOICE PARTS

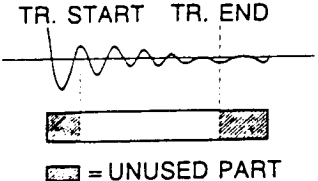
If sampled sounds are Truncated or Loop "Skip Next" settings are made, certain portions of the sound are not actually used, however they remain in the FZ-1 memory until otherwise specified. This function may be used to delete the entire sound, or just the "unused" parts.

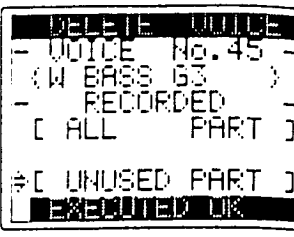
<p>(1) After defining voice to be deleted, enter DELETE VOICE Function in Voice Edit Sub-mode.</p>		
<p><b>To delete ENTIRE voice:</b> (1) Move cursor to ALL PART position &amp; press ENTER key.</p>		
<p>(2) Respond to [OK?] prompt by pressing YES key.</p>		
<p><b>To delete only UNUSED PART of voice:</b> (1) Move cursor to UNUSED PART position &amp; press ENTER key.</p>		

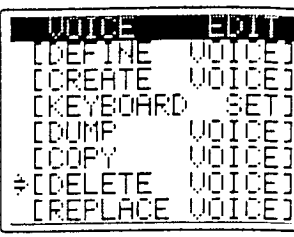
<p>(2) Respond to [OK?] prompt by pressing YES key.</p> <p>TR. START TR. END</p>  <p>■ = UNUSED PART</p>	<p>- / +</p>  <p>YES</p>	
<p>(3) Press ESCAPE key to exit to Voice Edit Sub-mode main menu.</p>	<p>ESCAPE</p> 	

**NOTE**

In either DELETE VOICE operation, delete may be aborted by pressing NO key in response to [OK?] prompt. Then press ESCAPE key to exit to Voice Edit Sub-mode main menu.

**VII. REPLACE VOICE**



Replace voice data and edit parameters of a specified voice with the voice data and edit parameters of another.





- VOICE EDIT
- DEFINE VOICE
  - CREATE VOICE
  - KEYBOARD SET
  - DUMP VOICE
  - COPY VOICE
  - DELETE VOICE
  - REPLACE VOICE

**■ ABOUT THE REPLACE VOICE FUNCTION**

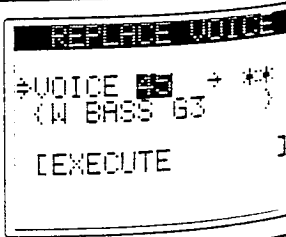
This function is similar to the Copy Voice function, however in this case the SOURCE voice is deleted after being assigned to a DESTINATION voice number.

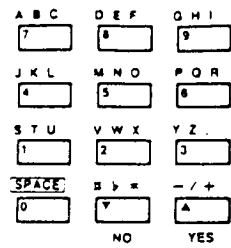
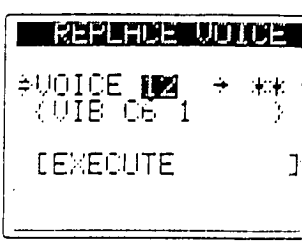
**■ REPLACE VOICE OPERATIONS**

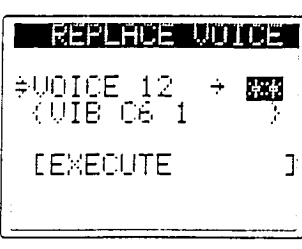
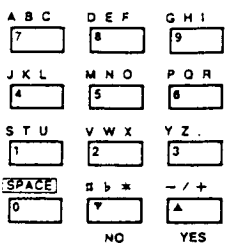
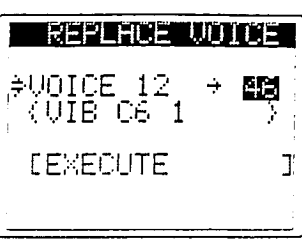
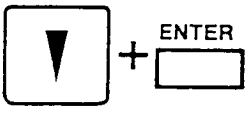
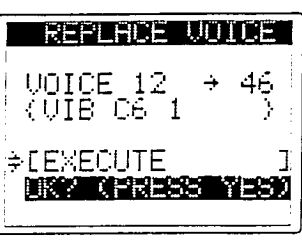
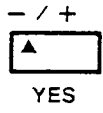
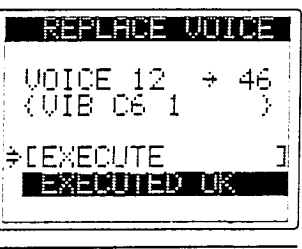
<p>(1) Enter REPLACE VOICE Function in Voice Edit Sub-mode.</p>	 + ENTER 	
---	---	--

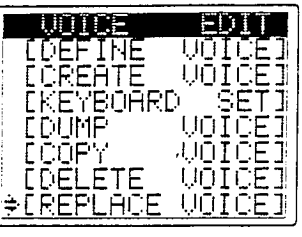
<p>(2) Enter Voice Number of SOURCE voice using Value slider, Value keys or ten-keys.</p>		
<p>(3) Press cursor [▶] key.</p>		
<p>(4) Enter Voice Number of DESTINATION voice (voice to be replaced) using Value slider, Value keys or ten-keys.</p>		
<p>(5) Move cursor to [EXECUTE] position and press Enter key.</p>		
<p>(6) Respond to [OK?] prompt by pressing YES key.</p>		
<p>(7) Press ESCAPE key to exit to Voice Edit Sub-mode main menu.</p>		

**NOTES**

- \*If specified DESTINATION voice number already contains a voice, a [VOICE DELETE?] prompt appears in place of [OK?] prompt. To replace with SOURCE voice, press YES key.
- \*Throughout REPLACE VOICE operations, SOURCE voice may be sounded on keyboard.

## SECTION 5:

# BANK EDIT SUB-MODE

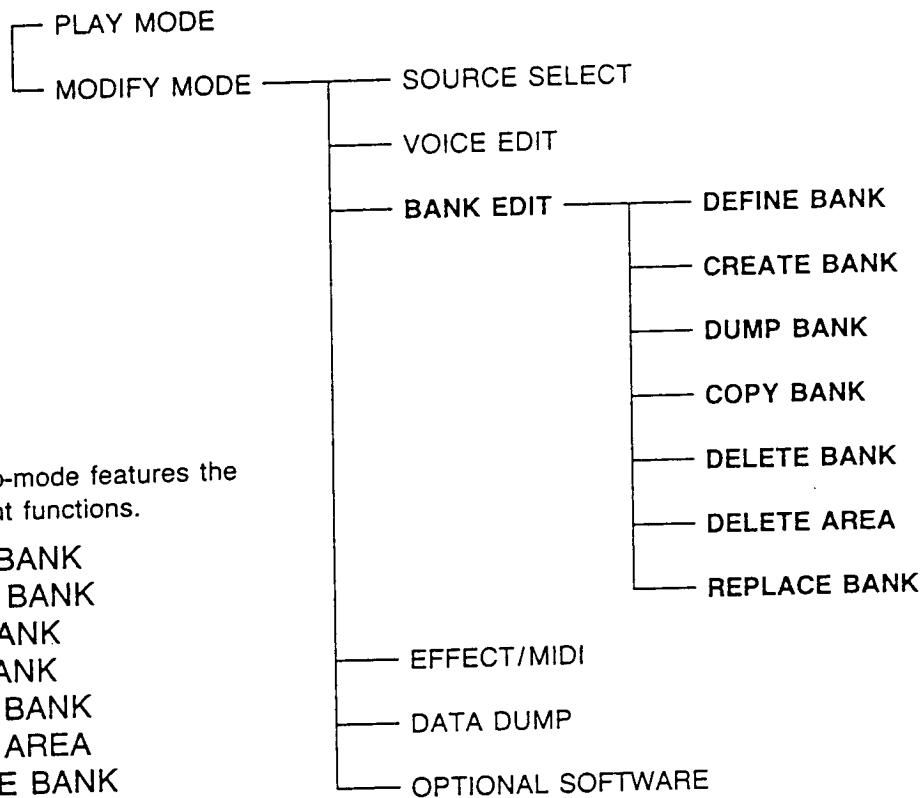

The Bank Edit Sub-mode features the following 7 different functions.

- I. DEFINE BANK
- II. CREATE BANK
- III. DUMP BANK
- IV. COPY BANK
- V. DELETE BANK
- VI. DELETE AREA
- VII. REPLACE BANK

## ■ ABOUT BANKS

Once you've created and edited a number of voices and specified their sounding range on the keyboard, they can be grouped into keyboard setups known as "BANKs."



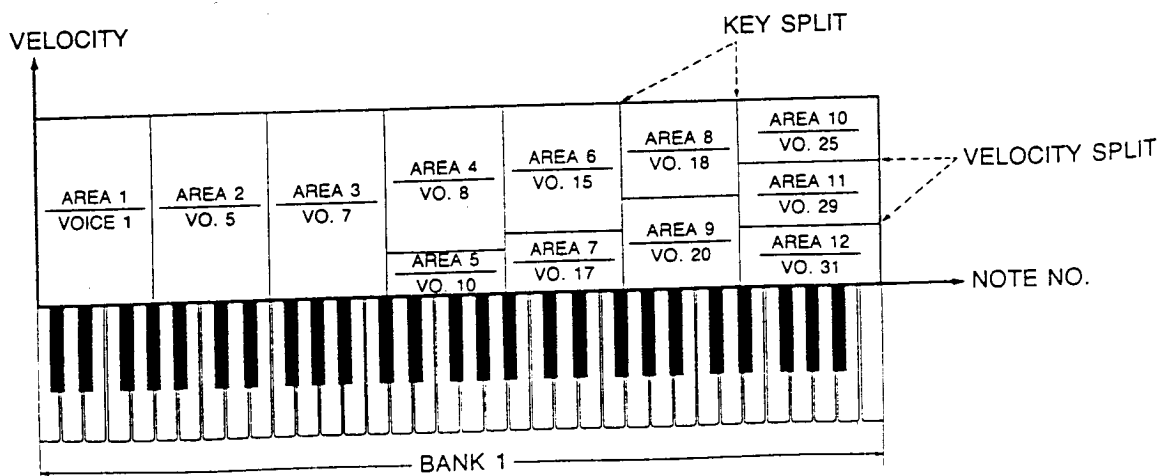

A single BANK may feature as many as 64 different VOICES, which are assigned positions on the keyboard according to KEY SPLIT and VELOCITY SPLIT parameters. Each VOICE within the BANK is also assigned to an AREA, of which each BANK contains 64 (equal to the maximum number of voices per Bank).

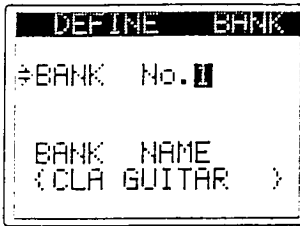
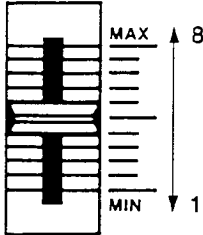
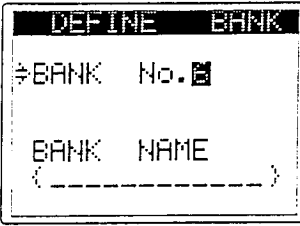

# I. DEFINE BANK

Specify the name and number of the Bank to be created.

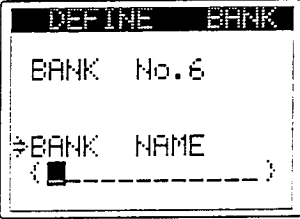
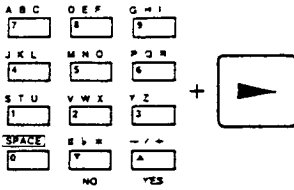
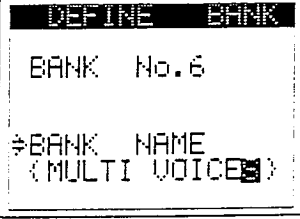
- BANK EDIT
- DEFINE BANK
  - CREATE BANK
  - DUMP BANK
  - COPY BANK
  - DELETE BANK
  - DELETE AREA
  - REPLACE BANK

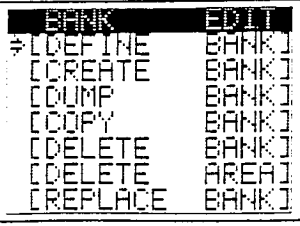
(1) Enter DEFINE BANK Function in Bank Edit Sub-mode.		
(2) Specify Bank Number of Bank to be created, using ten-keys, Value keys or Value slider.		
(3) Move cursor to BANK NAME position.		
(4) Input Bank Name using alphanumeric ten-keys and cursor [▶] key and Enter key.		
(5) Press ESCAPE key to exit to Bank Edit Sub-mode menu.		

## II. CREATE BANK

Assign Voices to Bank according to Create Bank parameters.



BANK EDIT	DEFINE BANK
	CREATE BANK
	DUMP BANK
	COPY BANK
	DELETE BANK
	DELETE AREA
	REPLACE BANK

### ■ ABOUT THE CREATE BANK FUNCTION

Within the Create Bank Function are parameters set in 6 different operations, which are set for each VOICE to be programmed in the BANK. These are set in the following order.

- (A) AREA NO.
- (B) KEYBOARD SPLIT (ORIGINAL, HIGHEST, LOWEST)
- (C) VELOCITY SPLIT (MAXIMUM TOUCH, MINIMUM TOUCH)
- (D) AREA LEVEL
- (E) MIDI CHANNEL
- (F) OUTPUT CHANNELS

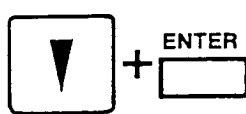
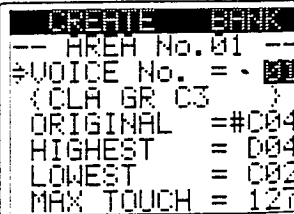
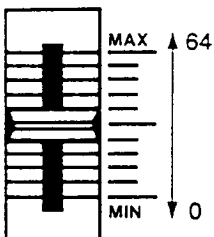
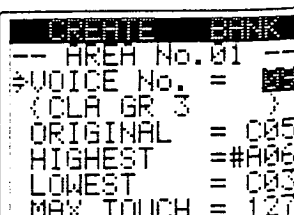
### ■ CREATE BANK OPERATIONS

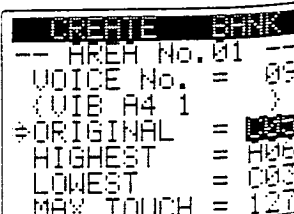

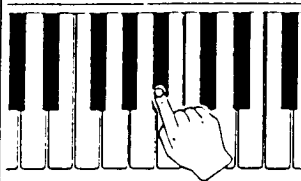
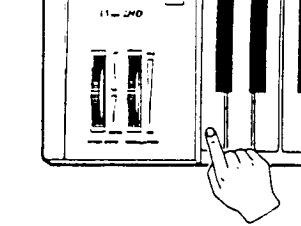
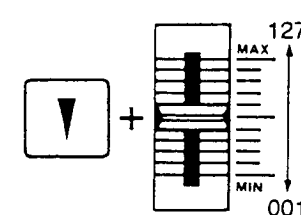
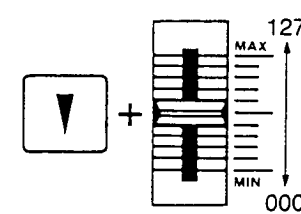
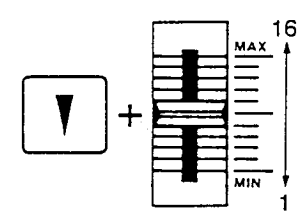
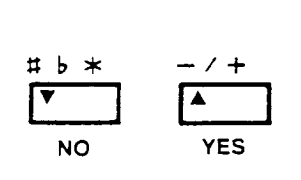
<p>(1) Enter CREATE BANK Function in Bank Edit Sub-mode.</p>		
<p>(2) Specify the VOICE No. to be assigned to specified AREA within BANK, using Value slider, Value keys or ten-keys.</p>		
<p>(3) Press cursor [▼] key.</p>		

<p>(4) Specify ORIGINAL key of Voice within Bank by pressing corresponding key on keyboard.</p>		<pre> CREATE BANK -- AREA No. 01 -- VOICE No. = 09 (VIB A4 1 ) ORIGINAL  =#A03 #HIGHEST  =#003 LOWEST    = 003 MAX TOUCH = 127 </pre>
<p>(5) Specify HIGHEST &amp; LOWEST keys of Voice within Bank by pressing corresponding key on keyboard.</p>		<pre> CREATE BANK -- AREA No. 01 -- VOICE No. = 09 (VIB A4 1 ) ORIGINAL  =#A04 HIGHEST   =#606 LOWEST    = 003 #MAX TOUCH = 127 </pre>
<p>(6) Specify VELOCITY RANGE of Voice by setting MAX TOUCH and MIN TOUCH parameters, using cursor, Value slider, Value keys or ten-keys.</p>		<pre> CREATE BANK -- AREA No. 01 -- (VIB A4 1 ) ORIGINAL  =#A04 HIGHEST   =#606 LOWEST    = 003 MAX TOUCH = 090 #MIN TOUCH = 012 </pre>
<p>(7) Specify volume of individual Voice within Bank by setting AREA LEVEL parameter, using Value slider, Value keys or ten-keys.</p>		<pre> CREATE BANK -- AREA No. 01 -- ORIGINAL  =#A04 HIGHEST   =#606 LOWEST    = 003 MAX TOUCH = 090 MIN TOUCH = 012 #AREA LEVEL = 127 </pre>
<p>(8) Assign a MIDI CHANNEL to the specified Voice, using the Value keys or ten-key.</p>		<pre> CREATE BANK -- AREA No. 01 -- HIGHEST   =#606 LOWEST    = 003 MAX TOUCH = 090 MIN TOUCH = 012 AREA LEVEL = 127 #MIDI CH  = 01 </pre>
<p>(9) To switch output through certain channels, press the Yes key when cursor flashes over corresponding dot. Press No key if no output is desired from that channel. Cursor increments automatically.</p>		<pre> CREATE BANK -- AREA No. 01 -- LOWEST    = 003 MAX TOUCH = 090 MIN TOUCH = 012 AREA LEVEL = 127 MIDI CH   = 01 #OUTPUT   = . . . . . </pre>



**NOTE**

Note that each AREA within a single Bank may be assigned a MIDI AREA channel (Area Channels 1 — 16). This is separate from the MIDI Basic Channel, which is set for the FZ-1 and other MIDI device. For further information, refer to Section 6.

<p>(10) Repeat procedures (2) through (9) for each Voice in Bank, pressing the cursor [▶] key to increment the AREA number.</p>		<pre> CREATE BANK -- AREA No. 02 -- =&gt;VOICE No. = ***  ORIGINAL  =**** HIGHEST   =**** LOWEST    =**** MAX TOUCH = ***         </pre>
<p>(11) Press ESCAPE key to exit to Bank Edit Sub-mode main menu.</p>	<p>ESCAPE</p> 	<pre> BANK EDIT [DEFINE BANK] =&gt;[CREATE BANK] [Dump BANK] [Copy BANK] [DELETE BANK] [DELETE AREA] [REPLACE BANK]         </pre>

**III. DUMP BANK**



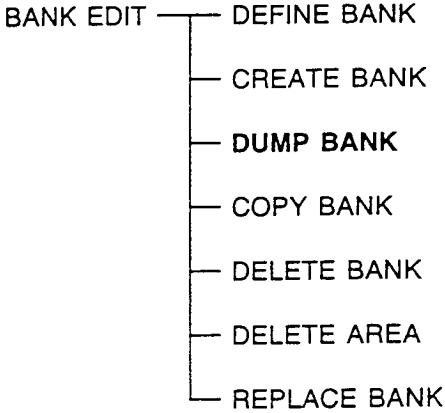

This function allows Load, Save, Verify and Erasure of Bank data created in the Create Bank Function. Operations in this Function are exactly the same as those of the "Bank Dump Function" of the Data Dump Sub-mode. For details, refer to Section 7 of this manual.

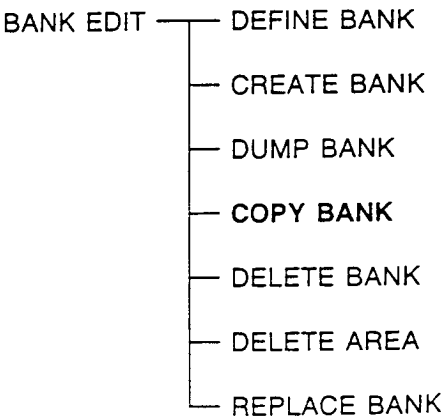

**IV. COPY BANK**

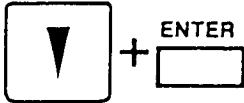
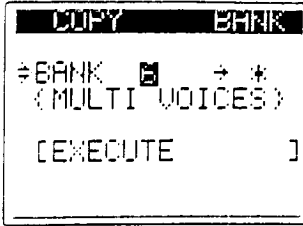
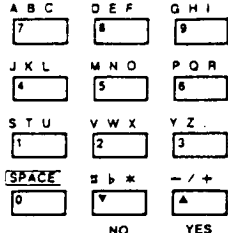
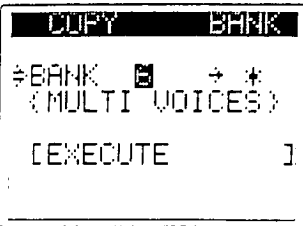
Copy Bank data from one Bank into another.

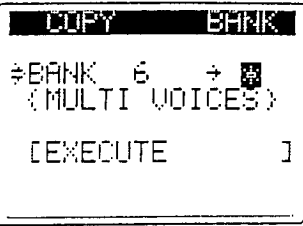
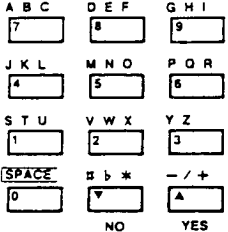
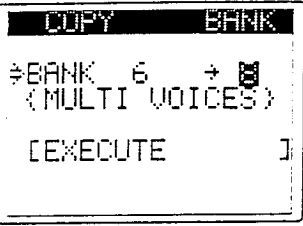

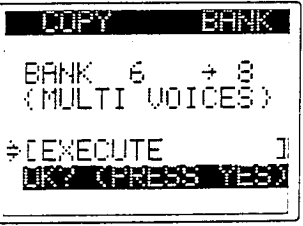
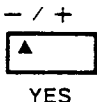
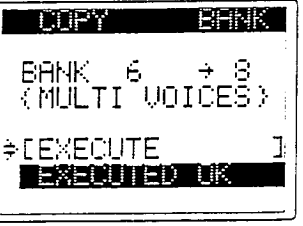
<p>(1) Enter COPY BANK Function in Bank Edit Sub-mode.</p>		
<p>(2) Enter Bank Number of SOURCE Bank using Value slider, Value keys or ten-keys.</p>		
<p>(3) Press cursor [▶] key.</p>		
<p>(4) Enter Bank Number of DESTINATION Bank (Bank to be copied into) using Value slider, Value keys or ten-keys.</p>		
<p>(5) Move cursor to [EXECUTE] position and press ENTER key.</p>		
<p>(6) Respond to [OK?] prompt by pressing YES key.</p>		

**NOTE**

If specified DESTINATION Bank number already contains a Bank, a [BANK DELETE?] prompt appears in place of [OK?] prompt. To replace with SOURCE Bank, press YES key.

(7) Press ESCAPE key to exit to Bank Edit Sub-mode main menu.

ESCAPE

```

BANK EDIT
[DEFINE BANK]
[CREATE BANK]
[DUMP BANK]
⇨ [COPY BANK]
[DELETE BANK]
[DELETE AREA]
[REPLACE BANK]
    
```

**NOTE**

Throughout COPY BANK operations, SOURCE voices may be sounded on keyboard.

**V. DELETE BANK**

Delete entire contents of a Bank, or only bank organization (saving voices).

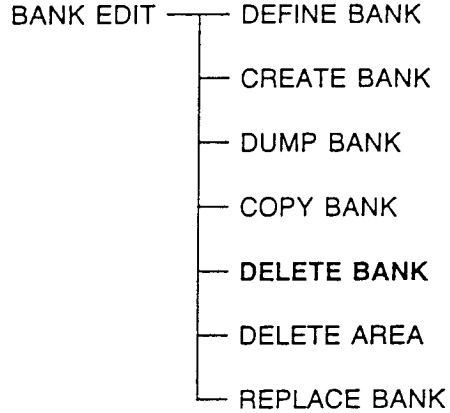

**To delete Bank structure only:**

(1) Enter DELETE BANK Function in Bank Edit Sub-mode.

+ ENTER

```

DELETE BANK
- BANK No.6 -
(MULTI VOICES)
⇨ [BANK ONLY ]
[BANK & VOICE ]
    
```

(2) Move cursor to BANK ONLY position & press ENTER key.

ENTER

```



DELETE BANK
- BANK No.6 -
(MULTI VOICES)
⇨ [BANK ONLY ]
[OK? PRESS YES]
[BANK & VOICE ]
    
```

(3) Respond to [OK?] prompt by pressing YES key.

- / +  
  
 YES

```

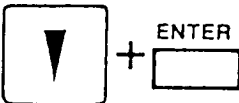
DELETE BANK
- BANK No.6 -
(MULTI VOICES)
⇨ [BANK ONLY ]
[EXCLUDED OK]
[BANK & VOICE ]
    
```



<p>To delete entire contents of Bank:</p> <p>(1) Move cursor to BANK &amp; VOICE position &amp; press ENTER key.</p>		<pre> DELETE BANK - BANK No.6 - (MULTI VOICES) =&gt;[BANK ONLY ] [BANK &amp; VOICE ] [OK? (PRESS YES)] </pre>
<p>(2) Respond to [OK?] prompt by pressing YES key.</p>		<pre> DELETE BANK - BANK No.6 - (MULTI VOICES) =&gt;[BANK ONLY ] [BANK &amp; VOICE ] [EXECUTED OK] </pre>
<p>(3) Press ESCAPE key to exit to Bank Edit Sub-mode menu.</p>		<pre> BANK EDIT [DEFINE BANK] [CREATE BANK] [DUMP BANK] [COPY BANK] =&gt;[DELETE BANK] [DELETE AREA] [REPLACE BANK] </pre>

## VI. DELETE AREA

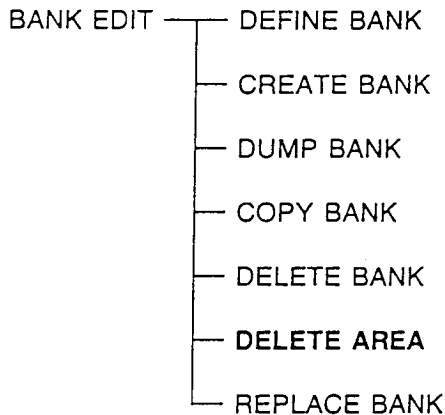
Delete any Area from selected Bank.

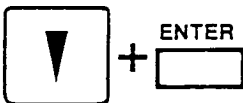

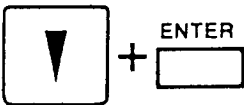
<p>(1) Enter DELETE AREA Function in the Bank Edit Sub-mode.</p>		<pre> DELETE AREA - BANK No.6 - (MULTI VOICES) =&gt;DELETE AREA= [01] (VIB A4 1 ) [EXECUTE ] </pre>																											
<p>(2) Specify AREA to be deleted from BANK using ten-keys.</p>	<table border="0"> <tr> <td>A B C</td> <td>D E F</td> <td>G H I</td> </tr> <tr> <td>[7]</td> <td>[8]</td> <td>[9]</td> </tr> <tr> <td>J K L</td> <td>M N O</td> <td>P Q R</td> </tr> <tr> <td>[4]</td> <td>[5]</td> <td>[6]</td> </tr> <tr> <td>S T U</td> <td>V W X</td> <td>Y Z .</td> </tr> <tr> <td>[1]</td> <td>[2]</td> <td>[3]</td> </tr> <tr> <td>SPACE</td> <td>[*]</td> <td>[- / +]</td> </tr> <tr> <td>[0]</td> <td>[v]</td> <td>[^]</td> </tr> <tr> <td></td> <td>NO</td> <td>YES</td> </tr> </table>	A B C	D E F	G H I	[7]	[8]	[9]	J K L	M N O	P Q R	[4]	[5]	[6]	S T U	V W X	Y Z .	[1]	[2]	[3]	SPACE	[*]	[- / +]	[0]	[v]	[^]		NO	YES	
A B C	D E F	G H I																											
[7]	[8]	[9]																											
J K L	M N O	P Q R																											
[4]	[5]	[6]																											
S T U	V W X	Y Z .																											
[1]	[2]	[3]																											
SPACE	[*]	[- / +]																											
[0]	[v]	[^]																											
	NO	YES																											





<p>(3) Press cursor [▼] key and Enter key.</p>		<pre> DELETE AREA - BANK No. 6 (MULTI VOICES)  DELETE AREA= 01 (VIB A4 1) =&gt;[EXECUTE ] OK? (PRESS YES) </pre>
<p>(4) Respond to [OK] prompt by pressing YES key.</p>		<pre> DELETE AREA - BANK No. 6 (MULTI VOICES)  DELETE AREA= 01 (VIB A4 1) =&gt;[EXECUTE ] EXECUTED OK </pre>
<p>(5) Press ESCAPE key to exist to Bank Edit Sub-mode Menu.</p>		<pre> BANK EDIT [DEFINE BANK] [CREATE BANK] [DUMP BANK] [COPY BANK] [DELETE BANK] =&gt;[DELETE AREA] [REPLACE BANK] </pre>

## VII. REPLACE BANK

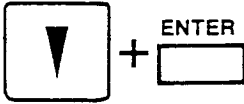
Replace entire contents of a Bank with those of another.

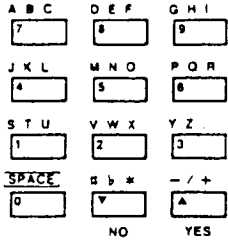
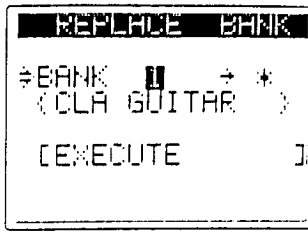
- BANK EDIT
- DEFINE BANK
  - CREATE BANK
  - DUMP BANK
  - COPY BANK
  - DELETE BANK
  - DELETE AREA
  - REPLACE BANK

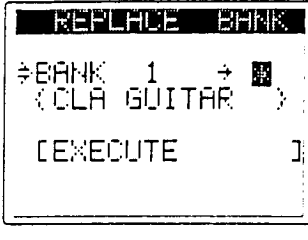
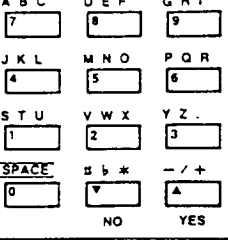
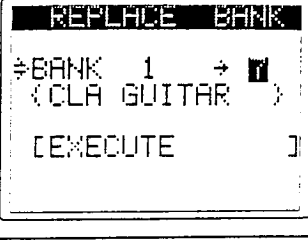
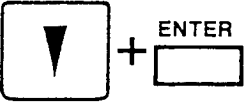
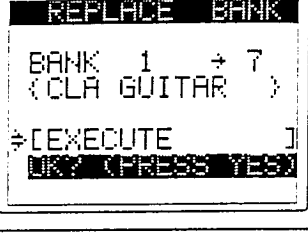
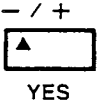
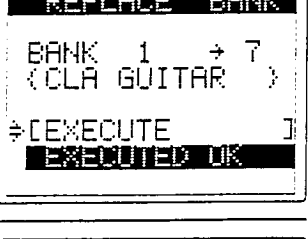
<p>(1) Enter REPLACE BANK Function in Bank Edit Sub-mode.</p>		<pre> REPLACE BANK =&gt;BANK [ ] + * (MULTI VOICES)  [EXECUTE ] </pre>
---	---	--

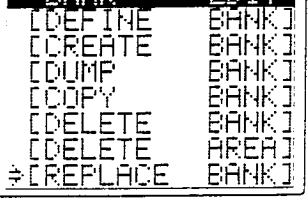
<p>(2) Enter Bank Number of SOURCE Bank using Value slider, Value keys or ten-keys.</p>		
<p>(3) Press cursor [▶] key.</p>		
<p>(4) Enter Bank Number of DESTINATION Bank (Bank to be replaced) using Value slider, Value keys or ten-keys.</p>		
<p>(5) Move cursor to [EXECUTE] position.</p>		
<p>(6) Respond to [OK?] prompt by pressing YES key.</p>		
<p>(7) Press ESCAPE key to exit to Bank Edit Sub-mode main menu.</p>		

**NOTE**

If data already exists in DESTINATION BANK, a [BANK DELETE?] prompt will appear. Press Yes key to replace former contents or No key to abort.

## SECTION 6:

# EFFECT/MIDI SUB-MODE

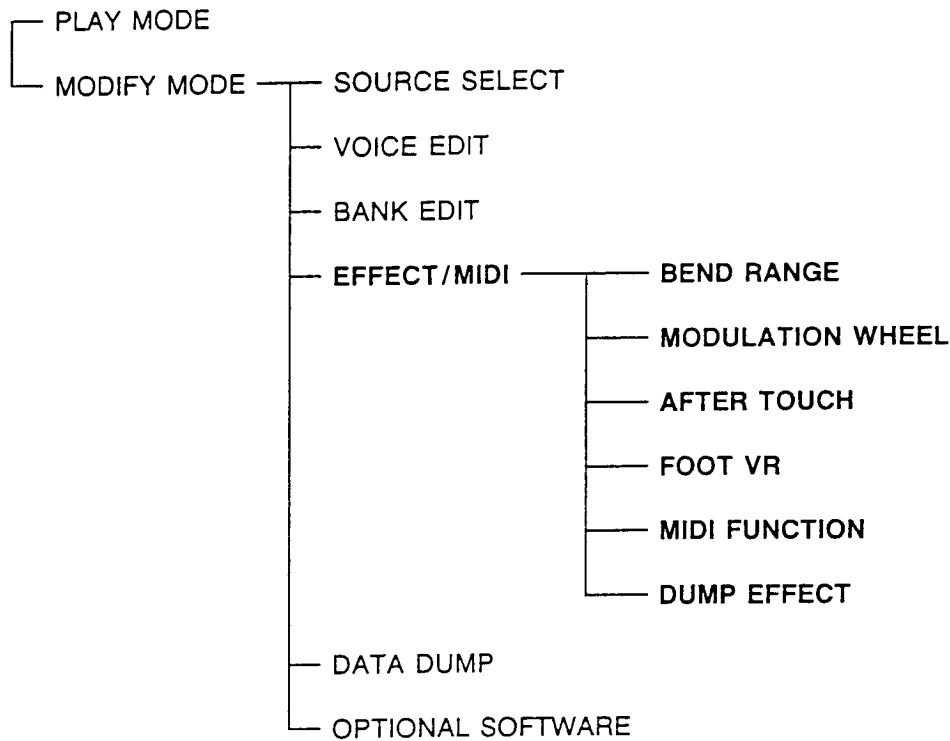

### ■ ABOUT THE EFFECT/MIDI SUB-MODE

This sub-mode includes settings and parameters which relate to effects such as the Pitch Bender, Modulation Wheel, Foot Variable Resistance, and After Touch, as well as MIDI settings.

### I. BEND RANGE

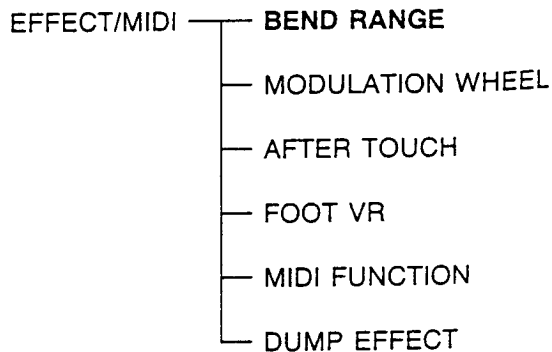

Set the bend range of the Pitch Bender.

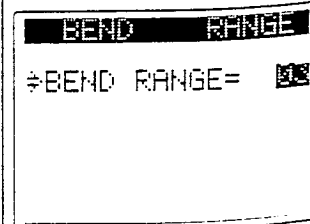

(1) Enter the BEND RANGE Function in the Effect/MIDI Sub-mode.

ENTER

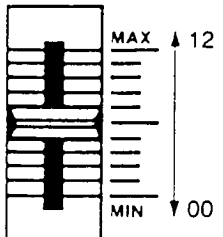
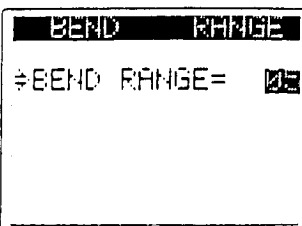

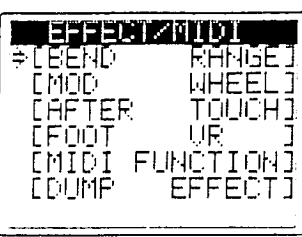
<p>(2) Specify BEND RANGE using the Value slider, Value keys or ten-keys. This range is set in half-step increments, between 00 and 12.</p>	 <p>A vertical slider with 25 horizontal steps. The top step is labeled 'MAX' with an upward arrow and the number '12'. The bottom step is labeled 'MIN' with a downward arrow and the number '00'. A thick black bar indicates the current range is set to 03.</p>	 <p>BEND RANGE      ⇒ BEND RANGE = 03</p>
<p>(3) Press ESCAPE key to exit to Effect/MIDI Sub-mode main menu.</p>	<p>ESCAPE</p> 	 <p>EFFECT/MIDI      ⇒ [BEND RANGE]      [MOD WHEEL]      [AFTER TOUCH]      [FOOT VR]      [MIDI FUNCTION]      [DUMP EFFECT]</p>

**NOTE**  
 In the initialized state, BEND RANGE is set to 03.

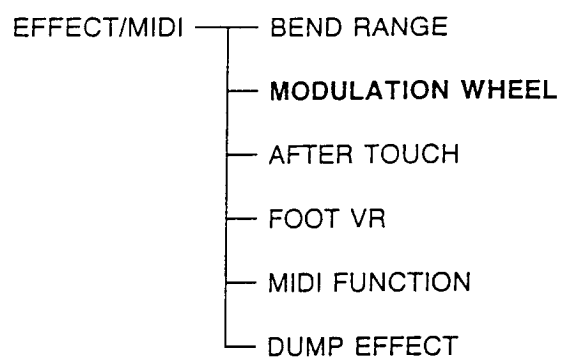

## II. MODULATION WHEEL

Specify parameters for modulation wheel-controlled effects.

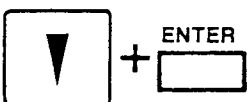
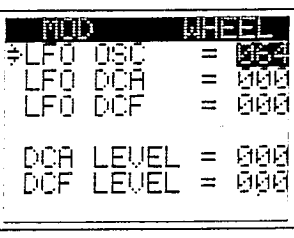
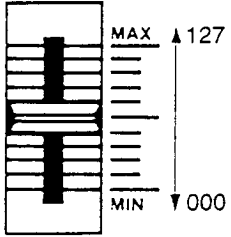
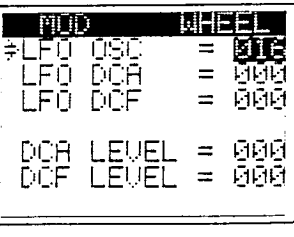

<p>(1) Enter MODULATION WHEEL Function in Effect/MIDI Sub-mode.</p>	 <p>A square key with a downward-pointing triangle and a plus sign next to a rectangular key labeled 'ENTER'.</p>	 <p>MOD WHEEL      ⇒ LFO OSC = 064      LFO DCA = 000      LFO DCF = 000      DCA LEVEL = 000      DCF LEVEL = 000</p>
<p>(2) Specify LFO OSC (vibrato depth control) parameter using Value slider, Value keys or ten-keys. Initialized value is 064. May be set within 000 — 127 range.</p>	 <p>A vertical slider with 25 horizontal steps. The top step is labeled 'MAX' with an upward arrow and the number '127'. The bottom step is labeled 'MIN' with a downward arrow and the number '000'. A thick black bar indicates the current value is set to 016.</p>	 <p>MOD WHEEL      ⇒ LFO OSC = 016      LFO DCA = 000      LFO DCF = 000      DCA LEVEL = 000      DCF LEVEL = 000</p>

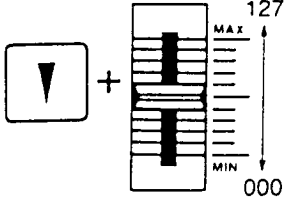
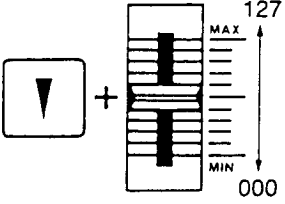
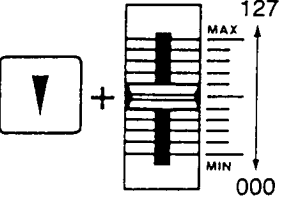
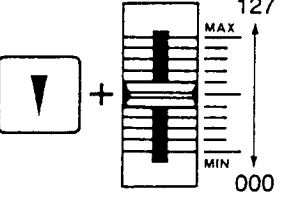



<p>(3) Specify LFO DCA (tremolo depth control) parameter using Value slider, Value keys or ten-keys. Initialized value is 000. May be set within 000 — 127 range.</p>		<pre> MOD WHEEL LFO OSC = 010 ⇨ LFO DCA = 000 LFO DCF = 000  DCA LEVEL = 000 DCF LEVEL = 000 </pre>
<p>(4) Specify LFO DCF (growl depth control) parameter using Value slider, Value keys or ten-keys. Initialized value is 000. May be set within 000 — 127 range.</p>		<pre> MOD WHEEL LFO OSC = 010 LFO DCA = 011 ⇨ LFO DCF = 000  DCA LEVEL = 000 DCF LEVEL = 000 </pre>
<p>(5) Specify DCA LEVEL (volume level control) parameter using Value slider, Value keys or ten-keys. Initialized value is 000. May be set within 000 — 127 range.</p>		<pre> MOD WHEEL LFO OSC = 010 LFO DCA = 011 LFO DCF = 110  ⇨ DCA LEVEL = 000 DCF LEVEL = 000 </pre>
<p>(6) Specify DCF LEVEL (filter cutoff bias control) parameter using Value slider, Value keys or ten-keys. Initialized value is 000. May be set within 000 — 127 range.</p>		<pre> MOD WHEEL LFO OSC = 010 LFO DCA = 011 LFO DCF = 110  DCA LEVEL = 075 ⇨ DCF LEVEL = 000 </pre>
<p>(7) Press ESCAPE key to exit to Effect/MIDI Sub-mode main menu.</p>	<p>ESCAPE</p> 	<pre> EFFECT/MIDI [BEND RANGE] ⇨ [MOD WHEEL] [AFTER TOUCH] [FOOT VR ] [MIDI FUNCTION] [DUMP EFFECT] </pre>

### III. AFTER TOUCH

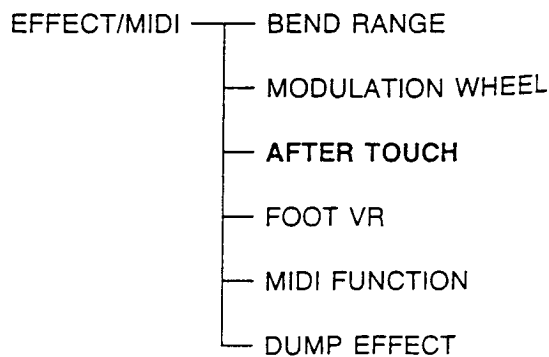
Specify parameters for AFTER TOUCH controlled effects.

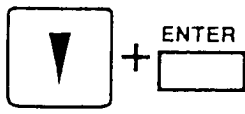
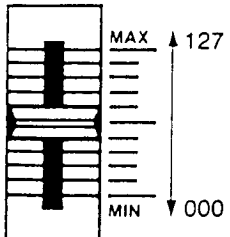
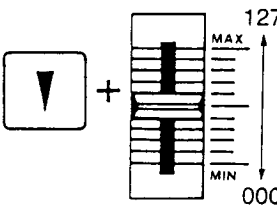
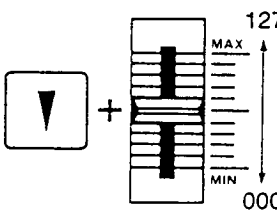
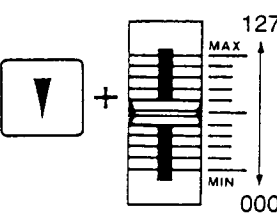
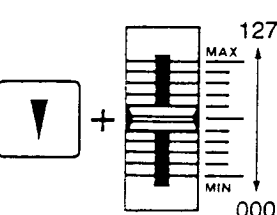

<p>(1) Enter AFTER TOUCH Function in Effect/MIDI Sub-mode.</p>		<pre> AFTER TOUCH ≠LFO OSC = 000 LFO DCA = 000 LFO DCF = 000  DCA LEVEL = 000 DCF LEVEL = 000 </pre>
<p>(2) Specify LFO OSC (vibrato depth control) parameter using Value slider, Value keys or ten-keys. Initialized value is 000. May be set within 000 — 127 range.</p>		<pre> AFTER TOUCH ≠LFO OSC = 005 LFO DCA = 000 LFO DCF = 000  DCA LEVEL = 000 DCF LEVEL = 000 </pre>
<p>(3) Specify LFO DCA (tremolo depth control) parameter using Value slider, Value keys or ten-keys. Initialized value is 000. May be set within 000 — 127 range.</p>		<pre> AFTER TOUCH LFO OSC = 005 ≠LFO DCA = 010 LFO DCF = 000  DCA LEVEL = 000 DCF LEVEL = 000 </pre>
<p>(4) Specify LFO DCF (growl depth control) parameter using Value slider, Value keys or ten-keys. Initialized value is 000. May be set within 000 — 127 range.</p>		<pre> AFTER TOUCH LFO OSC = 005 LFO DCA = 011 ≠LFO DCF = 120  DCA LEVEL = 000 DCF LEVEL = 000 </pre>
<p>(5) Specify DCA LEVEL (volume level control) parameter using Value slider, Value keys or ten-keys. Initialized value is 000. May be set within 000 — 127 range.</p>		<pre> AFTER TOUCH LFO OSC = 005 LFO DCA = 011 LFO DCF = 120  ≠DCA LEVEL = 065 DCF LEVEL = 000 </pre>
<p>(6) Specify DCF LEVEL (filter cutoff bias control) parameter using Value slider, Value keys or ten-keys. Initialized value is 000. May be set within 000 — 127 range.</p>		<pre> AFTER TOUCH LFO OSC = 005 LFO DCA = 011 LFO DCF = 120  DCA LEVEL = 065 ≠DCF LEVEL = 065 </pre>
<p>(7) Press ESCAPE key to exit to Effect/MIDI Sub-mode main menu.</p>		<pre> EFFECT/MIDI [BEAD RANGE] [MOD WHEEL] ≠[AFTER TOUCH] [FOOT UR ] [MIDI FUNCTION] [DUMP EFFECT] </pre>

# IV. FOOT VARIABLE RESISTANCE

Specify parameters for FOOT VARIABLE RESISTANCE controlled effects.

- EFFECT/MIDI — BEND RANGE
- MODULATION WHEEL
- AFTER TOUCH
- FOOT VR
- MIDI FUNCTION
- DUMP EFFECT

(1) Enter FOOT VR Function in Effect/MIDI Sub-mode.

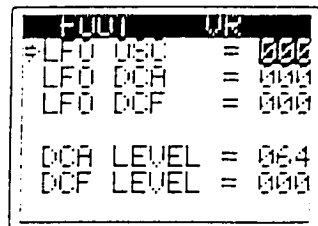
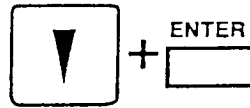

(2) Specify LFO OSC (vibrato depth control) parameter using Value slider, Value keys or ten-keys. Initialized value is 000. May be set within 000 — 127 range.

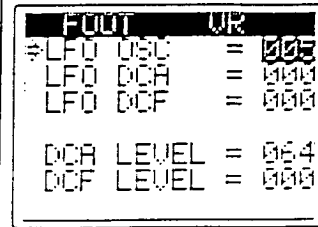
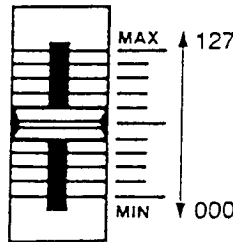

(3) Specify LFO DCA (tremolo depth control) parameter using Value slider, Value keys or ten-keys. Initialized value is 000. May be set within 000 — 127 range.

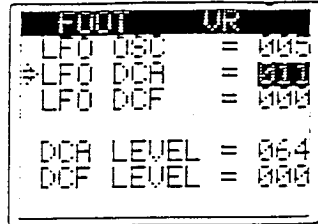
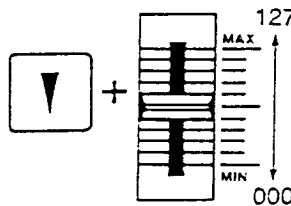

(4) Specify LFO DCF (growl depth control) parameter using Value slider, Value keys or ten-keys. Initialized value is 000. May be set within 000 — 127 range.

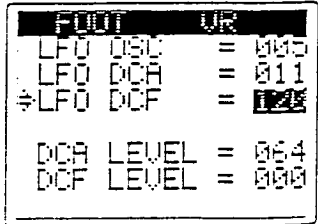
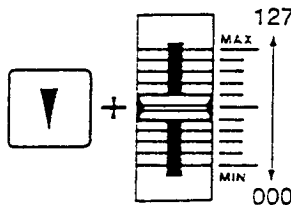

(5) Specify DCA LEVEL (volume level control) parameter using Value slider, Value keys or ten-keys. Initialized value is 064. May be set within 000 — 127 range.

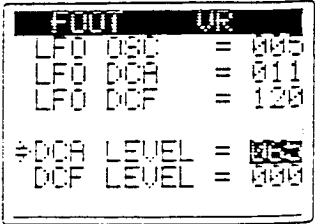
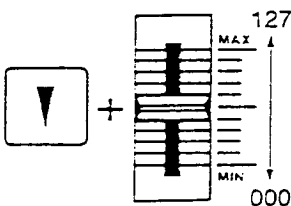

(6) Specify DCF LEVEL (filter cutoff bias control) parameter using Value slider, Value keys or ten-keys. Initialized value is 000. May be set within 000 — 127 range.

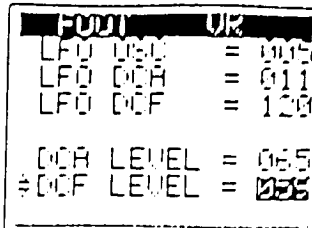
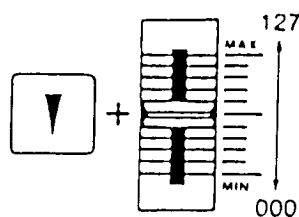

(7) Press ESCAPE key to exit to Effect/MIDI Sub-mode main menu.

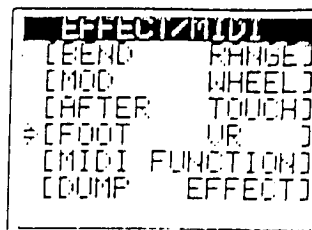
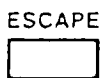

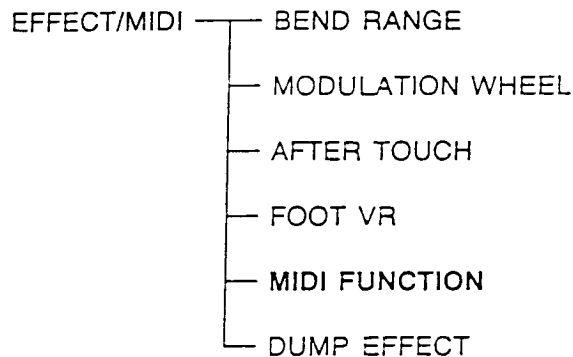

## V. MIDI FUNCTIONS

The FZ-1 utilizes MODE 3 for MIDI data transmission, however multiple MIDI Channels may be used in each Bank (one per AREA) for MIDI receive operations. In this operation, specify the Basic MIDI Channel and whether it, or Channels assigned to each AREA in the Bank are received. When the AREA setting is selected, MIDI channels assigned in the CREATE BANK Function (See Section 5) are received.

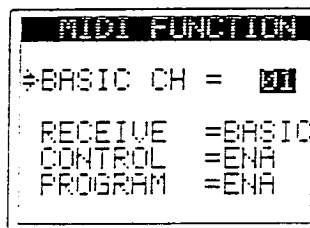
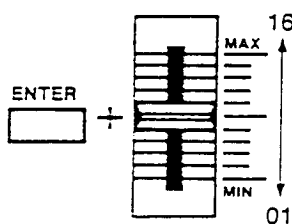

(1) Set the MIDI BASIC Channel (1 — 16) using the Value slider, Value keys or ten-keys.

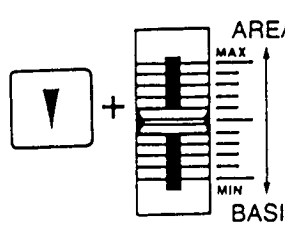
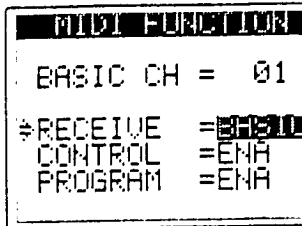
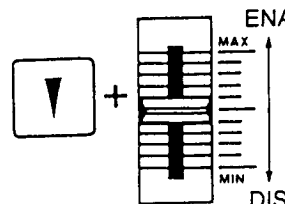
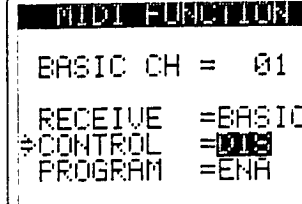
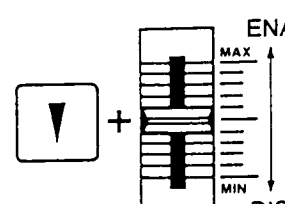
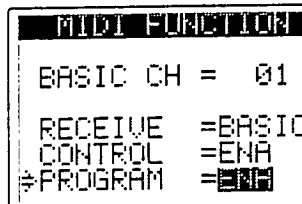

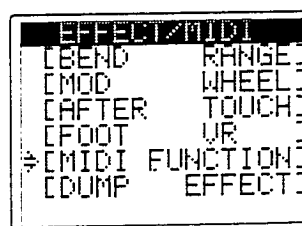
<p>(2) Select whether BASIC or AREA MIDI data is received, using the Value slider or Value keys.</p>		
<p>(3) Specify Control Change ENABLE nor DISENABLE using the Value slider or Value keys.</p>		
<p>(4) Specify Program Change ENABLE or DISENABLE using the Value slider or Value keys.</p>		
<p>(5) Press ESCAPE key to exit to Effect/MIDI Sub-mode main menu.</p>		

#### NOTE

In the initialized state, BASIC CH is set to 01, RECEIVE is set to BASIC, and CONTROL & PROGRAM are both set to ENABLE.

#### MIDI DATA TRANSMIT/RECEIVE

The FZ-1 is capable of transmitting/receiving the following MIDI data.

	MESSAGES	TRANS	REC
1	NOTE ON/OFF, VELOCITY	○	○
2	AFTER TOUCH	○	○
3	MODULATION WHEEL	○	○
4	PITCH BEND	○	○
5	SUSTAIN PEDAL ON/OFF	○	○
6	MASTER VOLUME		○
7	FOOT VOLUME	○	○
8	PROGRAM CHANGE	○	○
9	LOCAL CONTROL OFF		○
10	MIDI EXCLUSIVE EFFECT	○	○
11	MIDI EXCLUSIVE DUMP	○	○

When AREA is selected in the RECEIVE parameter, the following data is received.

	MESSAGES	REC from BASIC CH	REC from AREA CH
1	NOTE ON/OFF, VELOCITY		o
2	AFTER TOUCH		o
3	MODULATION WHEEL		o
4	PITCH BEND		o
5	SUSTAIN PEDAL ON/OFF		o
6	MASTER VOLUME		o
7	FOOT VOLUME		o
8	PROGRAM CHANGE	o	
9	LOCAL CONTROL OFF	o	
10	MIDI EXCLUSIVE EFFECT	o	
11	MIDI EXCLUSIVE DUMP	o	

## VI. DUMP EFFECT

Execute effect Load, Save, Verify and Erase operations.

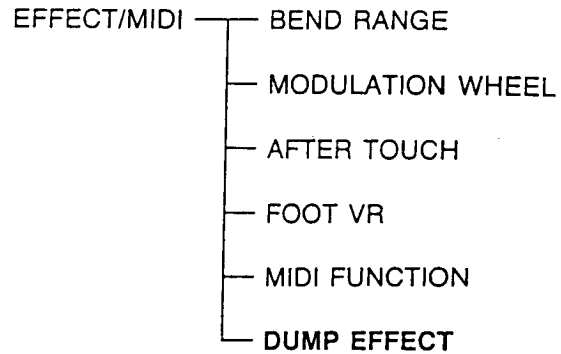

<p>(1) Enter DUMP EFFECT Function in EFFECT/MIDI Sub-mode.</p>		
<p>(2) Move cursor to position corresponding to desired operation. *Subsequent procedures are the same as in the EFFECT DUMP Function in the Data Dump Sub-mode. (See section 7.)</p>		

## SECTION 7:

# DATA DUMP SUB-MODE

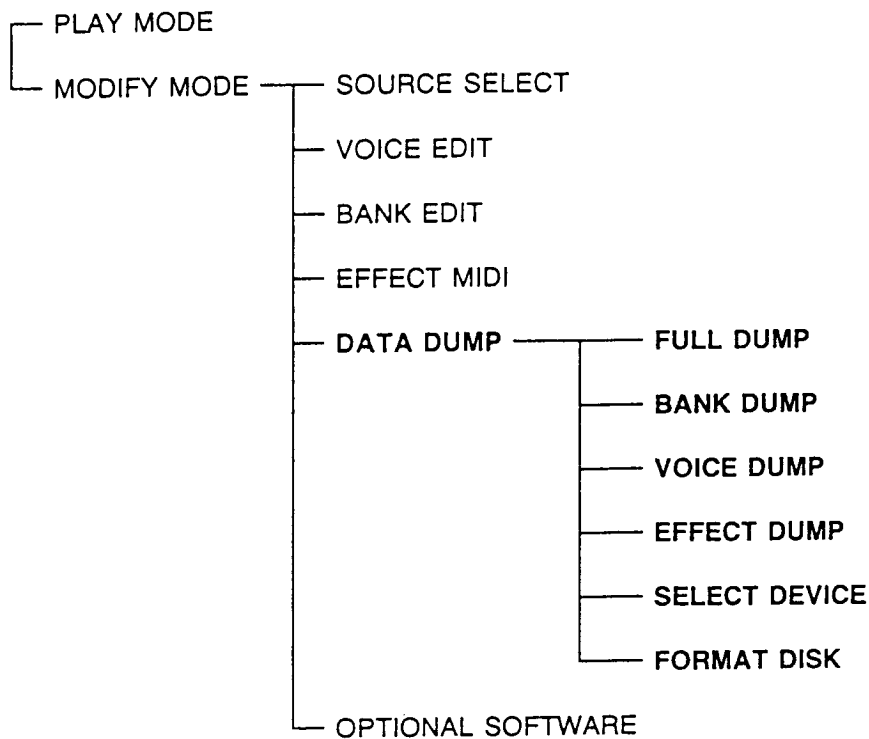

### ■ ABOUT THE DATA DUMP SUB-MODE

The Data Dump Sub-mode is used to transfer data from the FZ-1 to floppy disks for storage (SAVE operations), to input data from floppy disks back into the FZ-1 (LOAD operations), as well as transferring data between two FZ-1 units or computers using PORT and MIDI operations.

This sub-mode contains 6 basic Functions;

#### I. FULL DUMP

Used to dump (transfer) all data from/to the FZ-1, including BANK data, VOICE data and EFFECT data. MIDI FUNCTION data is not transferred through this Function.

#### II. BANK DUMP

Used to dump only BANK data from/to the FZ-1.

#### III. VOICE DUMP

Used to dump only VOICE data from/to the FZ-1.

#### IV. EFFECT DUMP

Used to dump only EFFECT data from/to the FZ-1. Effect data includes Bend Range, Modulation Wheel, After Touch and Foot VR data, however MIDI Function data is NOT transferred through this Function.

## V. SELECT DEVICE

Used to select which type of output FZ-1 is transferred through; DISK, MIDI or PORT. A REMOTE MODE may also be selected through this Function, for communication of data with a personal computer.

## VI. FORMAT DISK

Before new floppy disks are used for storing FZ-1 data, they must be formatted. This function is used to specify disk formatting.

### ■ <FOR YOUR INFORMATION>

- \*During Dump or Formatting operations, all other FZ-1 functions are inoperable.
- \*Disks must be formatted before performing SAVE operations.
- \*Data saved on disk through SAVE FULL operations can be input back into FZ-1 through LOAD FULL or MERGE FULL operations, however specific Banks or Voices cannot be input back into the FZ-1 through LOAD BANK, MERGE BANK or LOAD VOICE operations. Likewise, data from SAVE BANK operations can be input back into the FZ-1 through LOAD BANK & MERGE BANK operations, and SAVE VOICE data is input back into FZ-1 through LOAD VOICE operations.
- \*A single disk is capable of holding multiple Banks, Voices and Effects, so it is necessary to manage data by assigning names. Each piece of data saved to disk is known as a "file," and a single disk holds up to 64 files — provided that the total number of bytes saved is within the disk's capacity. FULL SAVE data is also counted as a single File.
- \*In the VOICE DUMP Function, the voice selected sounds on the keyboard. In other Functions, the selected Bank sounds.
- \*The same File Name may be assigned to differing types of data on the same disk. For example, a Bank, Effect and Voice may all be assigned the same name, although two Banks, for example, may not be given the same name.

### ■ <FZ-1 INITIALIZATION>

The LOAD FULL Operation in the Full Dump Function may be used to initialize the FZ-1 (erase all memory contents). Simply perform the LOAD FULL procedures without inserting a disk in the disk drive.

## I. FULL DUMP

Transfer all data from/to FZ-1.

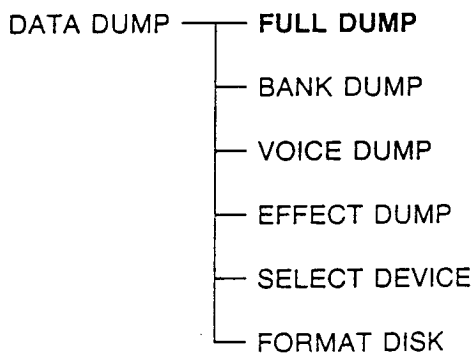









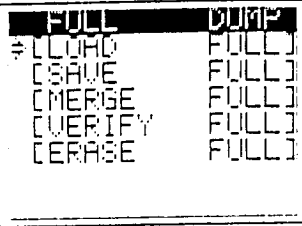

# LOAD FULL OPERATIONS

Transmit all data into the FZ-1 from DISK, MIDI or PORT.

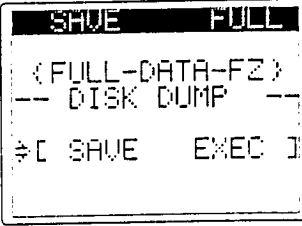
<p>(1) Enter FULL DUMP Function in Data Dump Sub-mode.</p>	<p>ENTER  <input type="text"/></p>	
<p>(2) Press ENTER key.          *Display indicates DISK DUMP, MIDI DUMP or PORT DUMP in correspondance with SELECT DEVICE setting.</p>	<p>ENTER  <input type="text"/></p>	
<p>(3) Press ENTER key.</p>	<p>ENTER  <input type="text"/></p>	
<p>(4) Respond to [OK?] prompt by pressing YES key.</p>	<p>- / +  <input type="text"/>          YES</p>	
<p>Data loaded from disk into FZ-1.</p>		
<p>(5) Press ESCAPE key to exit to Full Dump menu.</p>	<p>ESCAPE  <input type="text"/></p>	

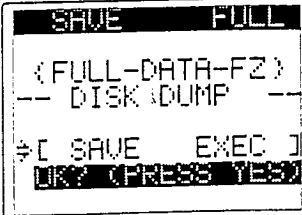

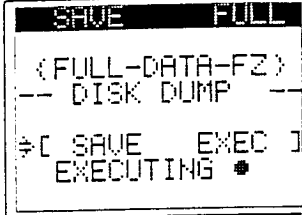

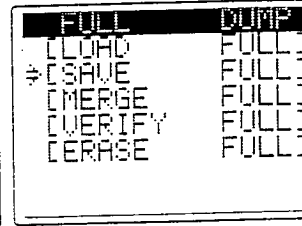

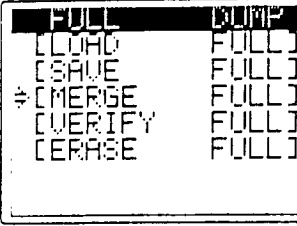

# SAVE FULL OPERATIONS

Transmit all data from DISK, MIDI or PORT into FZ-1.

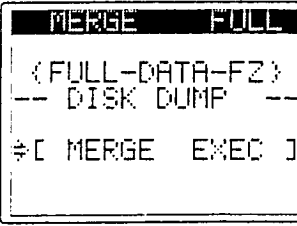
<p>(1) Enter FULL DUMP Function in Data Dump Sub-mode.</p>	<p>ENTER</p> 	
<p>(2) Move cursor to SAVE FULL position and press ENTER key. *Display indicates DISK DUMP, MIDI DUMP or PORT DUMP in correspondance with SELECT DEVICE setting.</p>	 + ENTER 	
<p>(3) Press ENTER key.</p>	<p>ENTER</p> 	
<p>(4) Respond to [OK?] prompt by pressing YES key.</p>	<p>- / +</p>  <p>YES</p>	
<p>Data saved into disk.</p>		
<p>(5) Press ESCAPE key to exit to Full Dump menu.</p>	<p>ESCAPE</p> 	

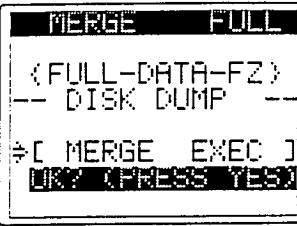
# MERGE FULL OPERATIONS

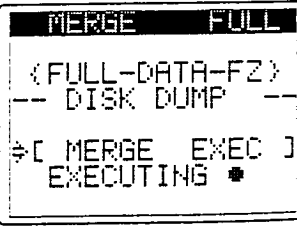
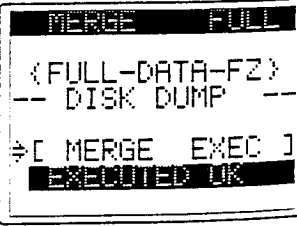
Input data from DISK, MIDI or PORT into open Banks or Voices in FZ-1 without erasing existing FZ-1 data.

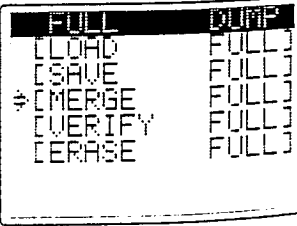



<p>(1) Enter FULL DUMP Function in Data Dump Sub-mode.</p>	<p>ENTER</p> 	 <pre> FULL      DUMP [LOAD    FULL] [SAVE    FULL] ⇒[MERGE  FULL] [VERIFY  FULL] [ERASE   FULL]             </pre>
<p>(2) Move cursor to MERGE FULL position and press ENTER key. *Display indicates DISK DUMP, MIDI DUMP or PORT DUMP in correspondance with SELECT DEVICE setting.</p>	 + ENTER 	 <pre> MERGE     FULL (FULL-DATA-FZ) -- DISK DUMP -- ⇒[ MERGE EXEC ]             </pre>
<p>(3) Press ENTER key.</p>	<p>ENTER</p> 	 <pre> MERGE     FULL (FULL-DATA-FZ) -- DISK DUMP -- ⇒[ MERGE EXEC ] [OK? CHRESS YES?]             </pre>
<p>(4) Respond to [OK?] prompt by pressing YES key.</p>	<p>- / +</p>  <p>YES</p>	 <pre> MERGE     FULL (FULL-DATA-FZ) -- DISK DUMP -- ⇒[ MERGE EXEC ] EXECUTING ●             </pre>
<p>Data merged.</p>		 <pre> MERGE     FULL (FULL-DATA-FZ) -- DISK DUMP -- ⇒[ MERGE EXEC ] EXECUTED OK             </pre>
<p>(5) Press ESCAPE key to exit to Full Dump menu.</p>	<p>ESCAPE</p> 	 <pre> FULL      DUMP [LOAD    FULL] [SAVE    FULL] ⇒[MERGE  FULL] [VERIFY  FULL] [ERASE   FULL]             </pre>

## NOTE

When the MERGE FULL operation is executed, EFFECT data existing in the FZ-1 is erased, and new parameters are input.

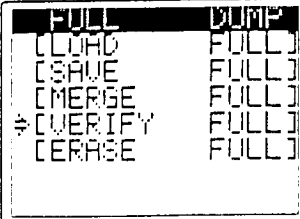
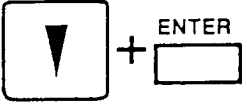
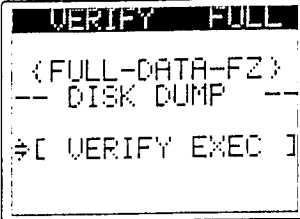

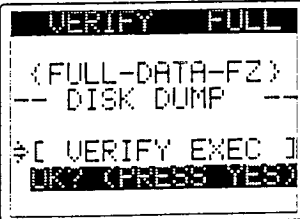

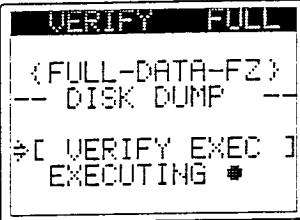
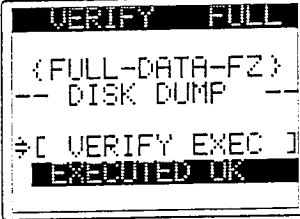
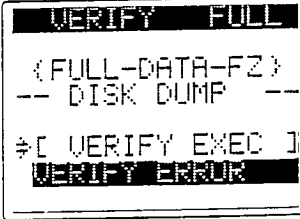

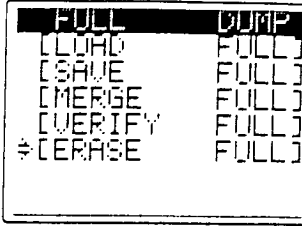

## VERIFY FULL OPERATIONS

Verify that data in FZ-1 and data in Disk, other MIDI device or second FZ-1 is the same.

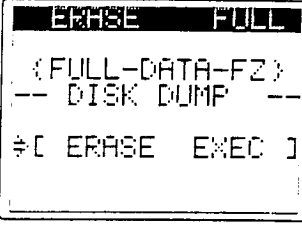
<p>(1) Enter FULL DUMP Function in Data Dump Sub-mode.</p>	<p>ENTER</p> 	
<p>(2) Move cursor to VERIFY FULL position and press ENTER key. *Display indicates DISK DUMP, MIDI DUMP or PORT DUMP in correspondance with SELECT DEVICE setting.</p>		
<p>(3) Press ENTER key.</p>	<p>ENTER</p> 	
<p>(4) Respond to [OK?] prompt by pressing YES key.</p>	<p>- / +</p>  <p>YES</p>	
<p>*If data matches, an "EXECUTED OK" message appears.</p>		
<p>*If data does not match, a "VERIFY ERROR" message appears.</p>		

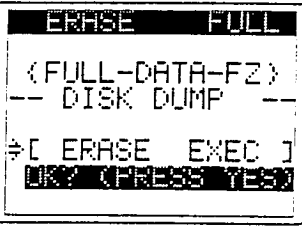
## ERASE FULL OPERATIONS

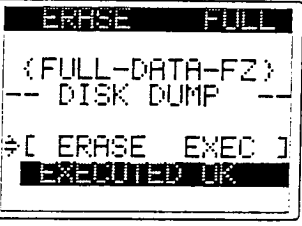
Erase all contents of Disk. (This operation cannot be entered when MIDI or PORT are selected in SELECT DEVICE Function.)

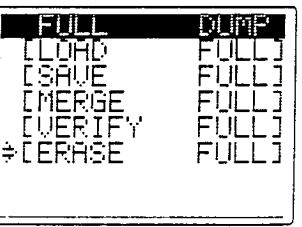
(1) Enter FULL DUMP Function in Data Dump Sub-mode.	<p>ENTER</p> 	 <pre> FULL DUMP [LOAD FULL] [SAVE FULL] [MERGE FULL] [VERIFY FULL] =&gt;[ERASE FULL]         </pre>
(2) Move cursor to ERASE FULL position and press ENTER key.	 + ENTER 	 <pre> ERASE FULL (FULL-DATA-FZ) -- DISK DUMP -- =&gt;[ ERASE EXEC ]         </pre>
(3) Press ENTER key.	<p>ENTER</p> 	 <pre> ERASE FULL (FULL-DATA-FZ) -- DISK DUMP -- =&gt;[ ERASE EXEC ] [OK?] [PRESS YES]         </pre>
(4) Respond to [OK?] prompt by pressing YES key.	<p>- / +</p>  <p>YES</p>	 <pre> ERASE FULL (FULL-DATA-FZ) -- DISK DUMP -- =&gt;[ ERASE EXEC ] EXECUTED OK         </pre>
(5) Press ESCAPE key to exit to Full Dump menu.	<p>ESCAPE</p> 	 <pre> FULL DUMP [LOAD FULL] [SAVE FULL] [MERGE FULL] [VERIFY FULL] =&gt;[ERASE FULL]         </pre>





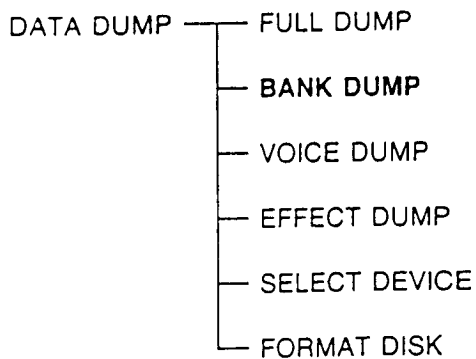

## II. BANK DUMP

Transfer BANK data to/from FZ-1. VOICES which have been assigned to specific AREAs are also transferred through these operations.

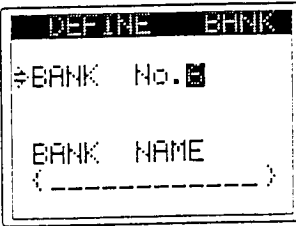

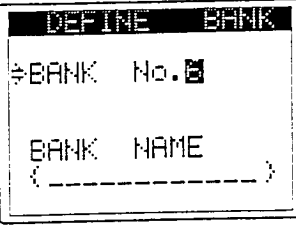
### DEFINE BANK OPERATIONS

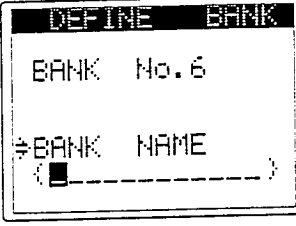
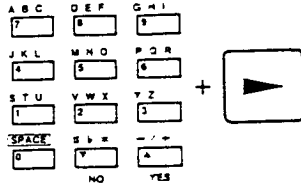
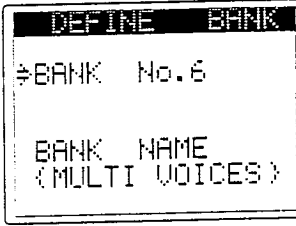
Specify the name and number of FZ-1 Bank to be dumped.

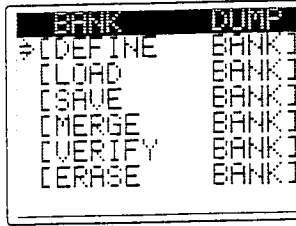
<p>(1) Enter DEFINE BANK Operation in Bank Dump Function.</p>	<p>ENTER</p> 	
<p>(2) Specify BANK No. using the ten-keys.</p>	<p>A B C</p> 	
<p>(3) Move cursor to BANK NAME position.</p>		
<p>(4) Assign a BANK NAME using the alphanumeric ten-keys and cursor keys.</p>		
<p>(5) Press ESCAPE key to exit to Bank Dump menu.</p>	<p>ESCAPE</p> 	

# LOAD BANK OPERATIONS

Load Bank data into FZ-1 from DISK, MIDI or PORT.

<p>(1) Enter LOAD BANK Operation in Bank Dump Function.</p>	<p>ENTER [ ]</p>	<p>disk name — file name</p>	<pre> LOAD BANK &lt;XXXX&gt; =&gt; (BRIAN) ----- SELECT &amp; ENTER         </pre>
<p>(2) Select Bank to be loaded, using cursor keys. Cursor [▲] and [▼] keys are used to scroll up and down.</p>			<pre> LOAD BANK &lt;XXXX&gt; =&gt; (BRIAN) ----- SELECT &amp; ENTER         </pre>
<p>Cursor [◀] and [▶] keys may be used to select succeeding/preceding "pages" (displays) of File (Bank) names.</p>			<pre> LOAD BANK &lt;YYYY&gt; =&gt; (ED) (XYZ) ----- SELECT &amp; ENTER         </pre>
<p>(3) Press ENTER key.</p>	<p>ENTER [ ]</p>		<pre> LOAD BANK - BANK No.1 - &lt;ED&gt; -- DISK DUMP -- =&gt; [LOAD EXEC] OK? PRESS YES         </pre>
<p>(4) Respond to [OK?] prompt by pressing YES key.</p>	<p>- / + [▲] YES</p>		<pre> LOAD BANK - BANK No.1 - &lt;ED&gt; -- DISK DUMP -- =&gt; [LOAD EXEC] EXECUTING •         </pre>
			<pre> LOAD BANK - BANK No.1 - &lt;ED&gt; -- DISK DUMP -- =&gt; [LOAD EXEC] EXECUTED OK         </pre>

## NOTE

Only Bank data which has been save through SAVE BANK operations can be loaded through LOAD BANK operation.

(5) Press ESCAPE key to exit to Bank Dump menu.

ESCAPE



```

BANK DUMP
[DEFINE BANK]
=>[LOAD BANK]
[SAVE BANK]
[MERGE BANK]
[VERIFY BANK]
[ERASE BANK]
    
```

## SAVE BANK OPERATIONS

Transmit data from FZ-1 to DISK, MIDI device or other FZ-1 through PORT.

(1) Enter SAVE BANK Operation in Bank Dump Function.

\*Display indicates DISK DUMP, MIDI DUMP or PORT DUMP in correspondance with SELECT DEVICE setting.

ENTER



```

SAVE BANK
- BANK No.1 -
< DRUMS >
-- DISK DUMP --
=>[ SAVE EXEC ]
    
```

(2) Press ENTER key.

ENTER



```

SAVE BANK
- BANK No.1 -
< DRUMS >
-- DISK DUMP --
=>[ SAVE EXEC ]
[OK? (PRESS YES)]
    
```

(3) Respond to [OK?] prompt by pressing YES key.

- / +



YES

```

SAVE BANK
- BANK No.1 -
< DRUMS >
-- DISK DUMP --
=>[ SAVE EXEC ]
EXECUTING ●
    
```

(4) Press ESCAPE key to exit to Bank Dump menu.

```

BANK DUMP
[DEFINE BANK]
[LOAD BANK]
=>[SAVE BANK]
[MERGE BANK]
[VERIFY BANK]
[ERASE BANK]
    
```





### NOTE

When a Bank Name has not been specified in DEFINE BANK operations, press the cursor [▶] key to access the menu shown at the right. Input a File (Bank) Name as in DEFINE BANK operations.



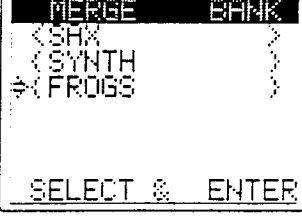

## MERGE BANK OPERATIONS

Input Bank data into FZ-1 without erasing existing Bank data.

<p>(1) Enter MERGE BANK Operation in Bank Dump Function.</p>	<p>ENTER  </p>	
<p>(2) Select Bank to be loaded, using cursor keys. Cursor [▲] and [▼] keys are used to scroll up and down.</p>		
<p>Cursor [◀] and [▶] keys may be used to select succeeding/preceding "pages" (displays) of File (Bank) names.</p>		

### NOTE

Display indicates DISK DUMP, MIDI DUMP or PORT DUMP in correspondance with SELECT DEVICE setting.

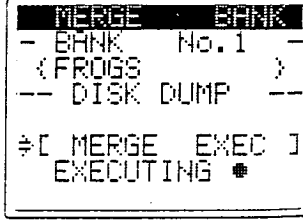
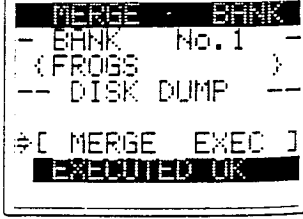
<p>(3) Press ENTER key.</p>	<p>ENTER  </p>	
<p>(4) Respond to [OK?] prompt by pressing YES key.</p>	<p>- / +            YES</p>	
		

(5) Press ESCAPE key to exit to Bank Dump menu.

\*New Bank data is input only into AREAs which do not already contain data.

ESCAPE



```

BANK DUMP
[DEFINE BANK]
[LOAD BANK]
[SAVE BANK]
* [MERGE BANK]
[VERIFY BANK]
[ERASE BANK]
    
```

## VERIFY BANK OPERATIONS

Verify that Bank data in FZ-1 matches that in DISK, MIDI device or another FZ-1.

(1) Enter VERIFY BANK Operation in Bank Dump Function.

ENTER



```

VERIFY BANK
* < DRUMS >
< SYNTH >
< FROGS >

SELECT & ENTER
    
```

(2) Select Bank to be verified, using cursor keys. Cursor [▲] and [▼] keys are used to scroll up and down.



```

VERIFY BANK
< DRUMS >
* < SYNTH >
< FROGS >

SELECT & ENTER
    
```

Cursor [◀] and [▶] keys may be used to select succeeding/preceding "pages" (displays) of File (Bank) names.



```

VERIFY BANK
* < RAIN >
< VIOLIN >
< CELLO >

SELECT & ENTER
    
```

### NOTE

Display indicates DISK DUMP, MIDI DUMP or PORT DUMP in correspondance with SELECT DEVICE setting.

(3) Press ENTER key.



ENTER



```

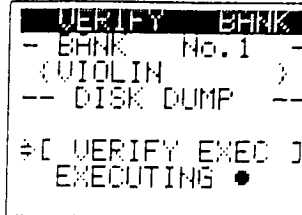
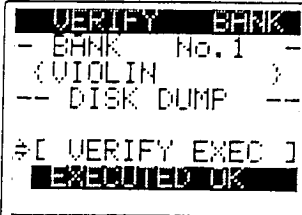
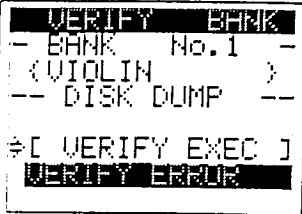

VERIFY BANK
- BANK No.1 -
< VIOLIN >
-- DISK DUMP --

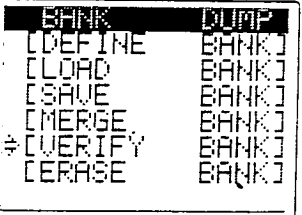

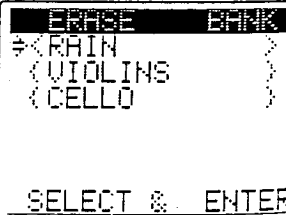

* [ VERIFY EXEC ]
  [ OK? (PRESS YES) ]
    
```

<p>(4) Respond to [OK?] prompt by pressing YES key.</p>	<p style="text-align: center;">- / +            YES</p>	
<p>*If data matches, an "EXECUTED OK" message appears.</p>		
<p>*If data does not match, a "VERIFY ERROR" message appears.</p>		
<p>(5) Press ESCAPE key to exit to Bank Dump menu.</p>	<p style="text-align: center;">ESCAPE  </p>	

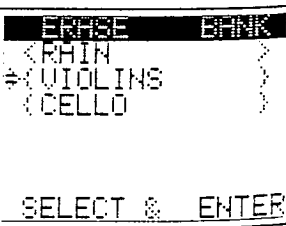
## ERASE BANK OPERATIONS

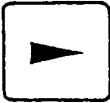
Erase Bank from Disk memory. (This operation cannot be entered when MIDI or PORT are selected in SELECT DEVICE Function.)

<p>(1) Enter ERASE BANK Operation in Bank Dump Function.</p>	<p style="text-align: center;">ENTER  </p>	
<p>(2) Select Bank to be erased, using cursor keys. Cursor [▲] and [▼] keys are used to scroll up and down.</p>	<p style="text-align: center;"> </p>	

<p>Cursor [ ◀ ] and [ ▶ ] keys may be used to select succeeding/preceding "pages" (displays) of File (Bank) names.</p>		<pre> ERASE BANK &lt;FLUTE =&gt;&lt;FUZZ GUITAR &lt;STRAT SELECT &amp; ENTER </pre>
<p>(3) Press ENTER key.</p>	<p>ENTER</p> 	<pre> ERASE BANK - BANK No.1 - &lt;FUZZ GUITAR &gt; -- DISK DUMP -- =&gt;[ ERASE EXEC ] OK? (PRESS YES) </pre>
<p>(4) Respond to [OK?] prompt by pressing YES key.</p>	<p>- / +</p>  <p>YES</p>	<pre> ERASE BANK - BANK No.1 - &lt;FUZZ GUITAR &gt; -- DISK DUMP -- =&gt;[ ERASE EXEC ] EXECUTING * </pre>
		<pre> ERASE BANK - BANK No.1 - &lt;FUZZ GUITAR &gt; -- DISK DUMP -- =&gt;[ ERASE EXEC ] EXECUTED OK </pre>
<p>(5) Press ESCAPE key to exit to Bank Dump menu.</p>	<p>ESCAPE</p> 	<pre> BANK DUMP [DEFINE BANK] [LOAD BANK] [SAVE BANK] [MERGE BANK] [VERIFY BANK] =&gt;[ERASE BANK] </pre>

### III. VOICE DUMP

Transfer Voice data to/from FZ-1. Only voice data which has been saved through SAVE VOICE operations can be loaded through LOAD VOICE operation.

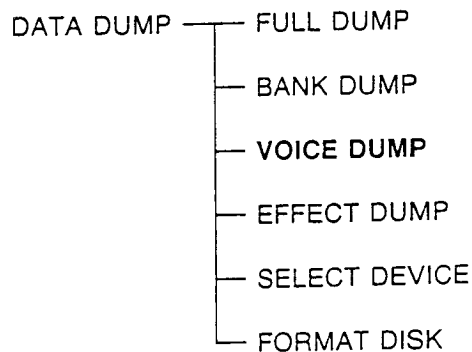

# DEFINE VOICE OPERATIONS

Specify the name and number of FZ-1 Voice to be dumped.

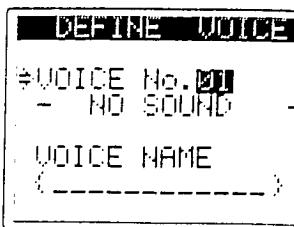
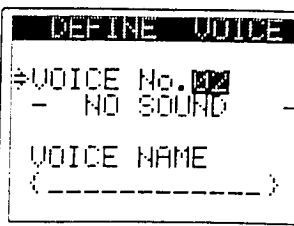
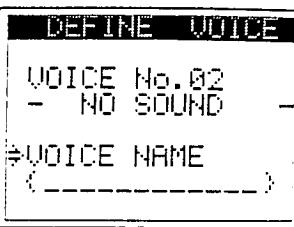
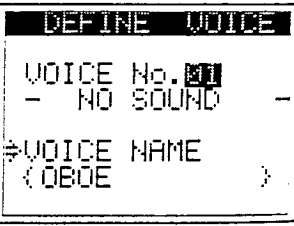
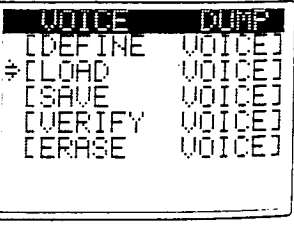
<p>(1) Enter DEFINE Voice Operation in Voice Dump Function.</p>	<p style="text-align: center;">ENTER</p> <div style="border: 1px solid black; width: 40px; height: 15px; margin: auto;"></div>	 <pre> DEFINE VOICE =&gt;VOICE No. 01 - NO SOUND - VOICE NAME (-----)         </pre>																											
<p>(2) Specify VOICE No. using the ten-keys.</p>	<table border="0" style="width: 100%; text-align: center;"> <tr> <td>A B C</td> <td>D E F</td> <td>G H I</td> </tr> <tr> <td>7</td> <td>8</td> <td>9</td> </tr> <tr> <td>J K L</td> <td>M N O</td> <td>P Q R</td> </tr> <tr> <td>4</td> <td>5</td> <td>6</td> </tr> <tr> <td>S T U</td> <td>V W X</td> <td>Y Z .</td> </tr> <tr> <td>1</td> <td>2</td> <td>3</td> </tr> <tr> <td>SPACE</td> <td>0 b *</td> <td>- / +</td> </tr> <tr> <td>0</td> <td>v</td> <td>^</td> </tr> <tr> <td></td> <td>NO</td> <td>YES</td> </tr> </table>	A B C	D E F	G H I	7	8	9	J K L	M N O	P Q R	4	5	6	S T U	V W X	Y Z .	1	2	3	SPACE	0 b *	- / +	0	v	^		NO	YES	 <pre> DEFINE VOICE =&gt;VOICE No. 02 - NO SOUND - VOICE NAME (-----)         </pre>
A B C	D E F	G H I																											
7	8	9																											
J K L	M N O	P Q R																											
4	5	6																											
S T U	V W X	Y Z .																											
1	2	3																											
SPACE	0 b *	- / +																											
0	v	^																											
	NO	YES																											
<p>(3) Move cursor to VOICE NAME position.</p>	<div style="border: 1px solid black; width: 40px; height: 40px; margin: auto; text-align: center; line-height: 40px;">▼</div>	 <pre> DEFINE VOICE VOICE No. 02 - NO SOUND - =&gt;VOICE NAME (-----)         </pre>																											
<p>(4) Specify VOICE NAME using the alphanumeric ten-keys and cursor keys.</p>	<table border="0" style="width: 100%; text-align: center;"> <tr> <td>A B C</td> <td>D E F</td> <td>G H I</td> </tr> <tr> <td>7</td> <td>8</td> <td>9</td> </tr> <tr> <td>J K L</td> <td>M N O</td> <td>P Q R</td> </tr> <tr> <td>4</td> <td>5</td> <td>6</td> </tr> <tr> <td>S T U</td> <td>V W X</td> <td>Y Z .</td> </tr> <tr> <td>1</td> <td>2</td> <td>3</td> </tr> <tr> <td>SPACE</td> <td>0 b *</td> <td>- / +</td> </tr> <tr> <td>0</td> <td>v</td> <td>^</td> </tr> <tr> <td></td> <td>NO</td> <td>YES</td> </tr> </table>	A B C	D E F	G H I	7	8	9	J K L	M N O	P Q R	4	5	6	S T U	V W X	Y Z .	1	2	3	SPACE	0 b *	- / +	0	v	^		NO	YES	 <pre> DEFINE VOICE VOICE No. 01 - NO SOUND - =&gt;VOICE NAME (0BDE)         </pre>
A B C	D E F	G H I																											
7	8	9																											
J K L	M N O	P Q R																											
4	5	6																											
S T U	V W X	Y Z .																											
1	2	3																											
SPACE	0 b *	- / +																											
0	v	^																											
	NO	YES																											
<p>(5) Press ESCAPE key to exit to Voice Dump menu.</p>	<p style="text-align: center;">ESCAPE</p> <div style="border: 1px solid black; width: 40px; height: 15px; margin: auto;"></div>	 <pre> VOICE DUMP [DEFINE VOICE] =&gt;[LOAD VOICE] [SAVE VOICE] [VERIFY VOICE] [ERASE VOICE]         </pre>																											







# LOAD VOICE OPERATIONS

Load Voice data into FZ-1 from DISK, MIDI or PORT.

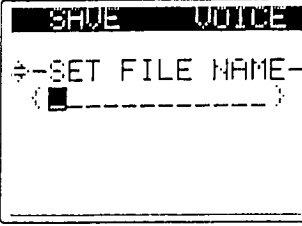
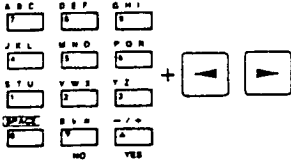
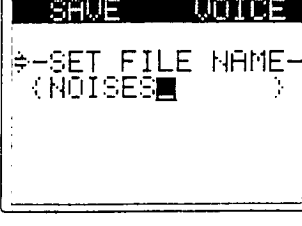
<p>(1) Enter LOAD VOICE Operation in Voice Dump Function.</p>	<p>disk name →</p> <p>ENTER</p> <p>file name</p>	<pre> LOAD VOICE =&gt; &lt;CELLI   &lt;VIOLINS   &lt;OBOE                                 &gt;                                 &gt; SELECT &amp; ENTER                     </pre>
<p>(2) Select Voice to be loaded, using cursor keys. Cursor [▲] and [▼] keys are used to scroll up and down.</p>	<p>▼</p>	<pre> LOAD VOICE &lt;CELLI =&gt; &lt;VIOLINS   &lt;OBOE   &lt;FRGGS                                 &gt;                                 &gt; SELECT &amp; ENTER                     </pre>
<p>Cursor [◀] and [▶] keys may be used to select succeeding/preceding "pages" (displays) of File (Bank) names.</p>	<p>▶</p>	<pre> LOAD VOICE =&gt; &lt;RAIN   &lt;FUZZ GUITAR   &lt;PANIC                                 &gt;                                 &gt; SELECT &amp; ENTER                     </pre>
<p>(3) Press ENTER key.</p>	<p>ENTER</p>	<pre> LOAD VOICE - VOICE No.01 - &lt;RAIN -- DISK DUMP -- =&gt; [ LOAD EXEC ]     [PRESS YES]                     </pre>
<p>(4) Respond to [OK?] prompt by pressing YES key.</p>	<p>- / +</p> <p>▲</p> <p>YES</p>	<pre> LOAD VOICE - VOICE No.01 - &lt;RAIN -- DISK DUMP -- =&gt; [ LOAD EXEC ]     EXECUTED OK                     </pre>
<p>(5) Press ESCAPE key to exit to Load Voice menu.</p>	<p>ESCAPE</p>	<pre> VOICE DUMP [DEFINE VOICE] =&gt; [LOAD VOICE]   [SAVE VOICE]   [VERIFY VOICE]   [ERASE VOICE]                     </pre>

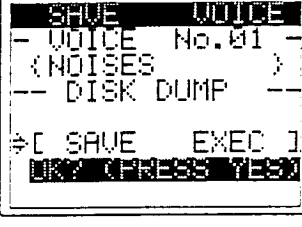

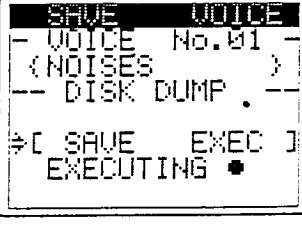

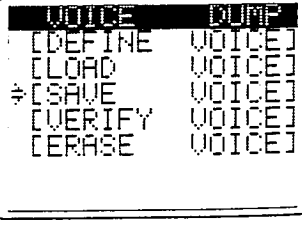

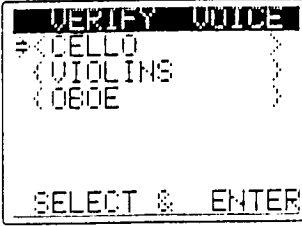

## SAVE VOICE OPERATIONS

Transmit Voice data from FZ-1 to DISK, MIDI device or other FZ-1 through PORT.

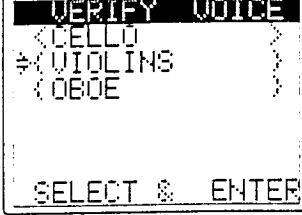

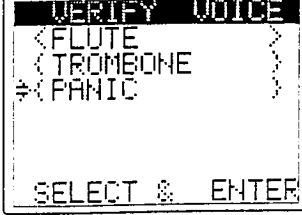
<p>(1) Enter SAVE VOICE Operation in Voice Dump Function. *Display indicates DISK DUMP, MIDI DUMP or PORT DUMP in correspondance with SELECT DEVICE setting.</p>	<p>ENTER </p>	
<p>(2) Set File Name using ten-keys.</p>		
<p>(3) Press ENTER key.</p>	<p>ENTER </p>	
<p>(4) Respond to [OK?] prompt by pressing YES key.</p>	<p>- / +  YES</p>	
<p>(5) Press ESCAPE key to exit to Voice Dump menu.</p>	<p>ESCAPE </p>	

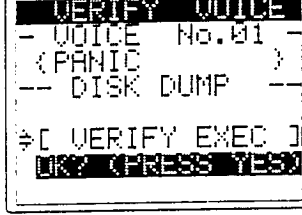
# VERIFY VOICE OPERATIONS

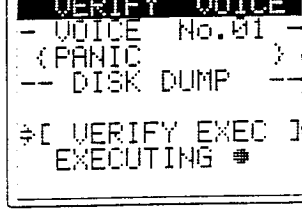
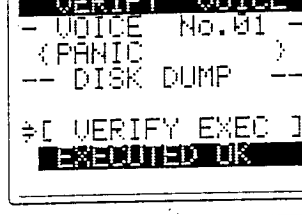
Verify that Voice data in FZ-1 matches that in DISK, MIDI device or another FZ-1.



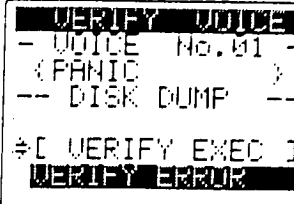

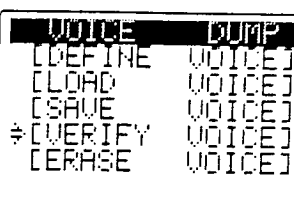

<p>(1) Enter VERIFY VOICE Operation in Voice Dump Function.</p>	<p>ENTER</p> 	
<p>(2) Select Voice to be verified, using cursor keys. Cursor [▲] and [▼] keys are used to scroll up and down.</p>		
<p>Cursor [◀] and [▶] keys may be used to select succeeding/preceding "pages" (displays) of File (Voice) names.</p>		
<p>(3) Press ENTER key. *Display indicates DISK DUMP, MIDI DUMP or PORT DUMP in correspondance with SELECT DEVICE setting.</p>	<p>ENTER</p> 	
<p>(4) Respond to [OK?] prompt by pressing YES key.</p>	<p>- / +</p>  <p>YES</p>	
<p>*If data matches, an "EXECUTED OK" message appears.</p>		



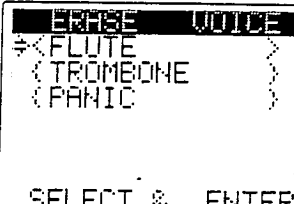

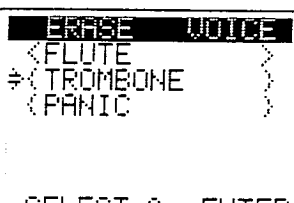
<p>*If data does not match, a "VERIFY ERROR" message appears.</p>		 <pre> VERIFY VOICE - VOICE No. 01 - &lt; PANIC &gt; -- DISK DUMP -- # [ VERIFY EXEC ] VERIFY ERROR </pre>
<p>(5) Press ESCAPE key to exit to Voice Dump menu.</p>	<p>ESCAPE</p> 	 <pre> VOICE DUMP [ DEFINE VOICE ] [ LOAD VOICE ] [ SAVE VOICE ] # [ VERIFY VOICE ] [ ERASE VOICE ] </pre>

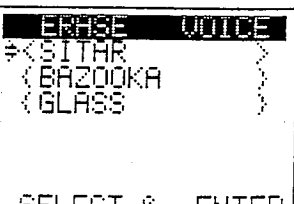
### ERASE VOICE OPERATIONS

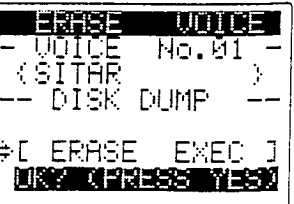
Erase Voice from Disk memory. (This operation cannot be entered when MIDI or PORT are selected in SELECT DEVICE Function.)

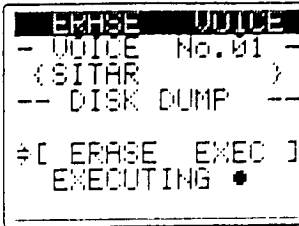
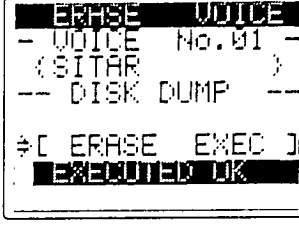
<p>(1) Enter ERASE VOICE Operation in Voice Dump Function.</p>	<p>ENTER</p> 	 <pre> ERASE VOICE # &lt; FLUTE &gt; &lt; TROMBONE &gt; &lt; PANIC &gt;  SELECT &amp; ENTER </pre>
<p>(2) Select Voice to be erased, using cursor keys. Cursor [▲] and [▼] keys are used to scroll up and down.</p>		 <pre> ERASE VOICE &lt; FLUTE &gt; # &lt; TROMBONE &gt; &lt; PANIC &gt;  SELECT &amp; ENTER </pre>
<p>Cursor [◀] and [▶] keys may be used to select succeeding/preceding "pages" (displays) of File (Voice) names.</p>		 <pre> ERASE VOICE # &lt; SITHAR &gt; &lt; BAZOOKA &gt; &lt; GLASS &gt;  SELECT &amp; ENTER </pre>
<p>(3) Press ENTER key.</p>	<p>ENTER</p> 	 <pre> ERASE VOICE - VOICE No. 01 - &lt; SITHAR &gt; -- DISK DUMP -- # [ ERASE EXEC ] PRESS YES </pre>

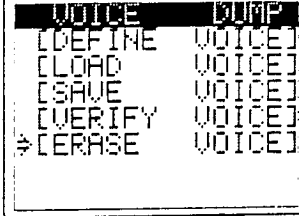
<p>(4) Respond to [OK?] prompt by pressing YES key.</p>	<p style="text-align: center;">- / +            YES</p>	
		
<p>(5) Press ESCAPE key to exit to Voice Dump menu.</p>	<p style="text-align: center;">ESCAPE  </p>	

#### IV. EFFECT DUMP



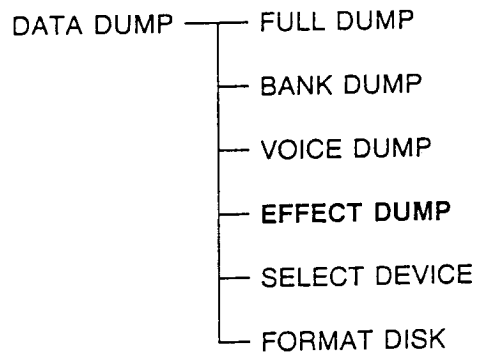

Transfer effect data, including Bend Range, Modulation, After Touch and Foot VR parameters, to/from FZ-1.

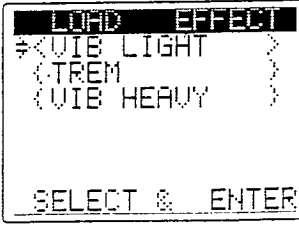

#### LOAD EFFECT OPERATIONS

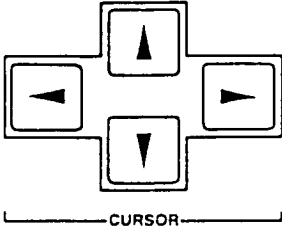
Load Effect data into FZ-1 from DISK, MIDI or PORT.







<p>(1) Enter LOAD EFFECT Operation in Effect Dump Function.</p>	<p style="text-align: center;">ENTER  </p> <p style="text-align: right;">disk name — file name —</p>	
---	---	---

<p>(2) Select Effect to be loaded, using cursor keys. Cursor [▲] and [▼] keys are used to scroll up and down, while [◀] and [▶] keys may be used to select succeeding/preceding "pages" (displays) of File (Effect) names.</p>		<pre> LOAD EFFECT &lt;UIB LIGHT &gt; &lt;TREM &gt; =&gt;UIB HEAVY &gt;  SELECT &amp; ENTER </pre>
<p>(3) Press ENTER key.</p>		<pre> LOAD EFFECT &lt;UIB HEAVY &gt; -- DISK DUMP -- =&gt;[ LOAD EXEC ] PRESS YES </pre>
<p>(4) Respond to [OK?] prompt by pressing YES key.</p>		<pre> LOAD EFFECT &lt;UIB HEAVY &gt; -- DISK DUMP -- =&gt;[ LOAD EXEC ] EXECUTING ● </pre>
		<pre> LOAD EFFECT &lt;UIB HEAVY &gt; -- DISK DUMP -- =&gt;[ LOAD EXEC ] EXECUTED OK </pre>
<p>(5) Press ESCAPE key to exit to Effect Dump menu.</p>		<pre> EFFECT DUMP =&gt;[LOAD EFFECT] [SAVE EFFECT] [VERIFY EFFECT] [ERASE EFFECT] </pre>

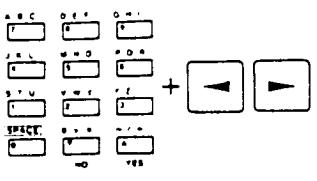
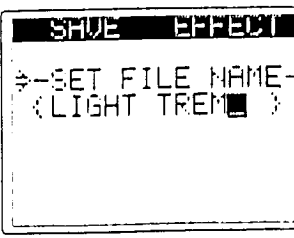
## SAVE EFFECT OPERATIONS

Transmit Effect data from FZ-1 to DISK, MIDI device or other FZ-1 through PORT.

<p>(1) Enter SAVE VOICE Operation in Effect Dump Function.</p>		<pre> SAVE EFFECT =&gt;--SET FILE NAME-- (-----) </pre>
--	---	---

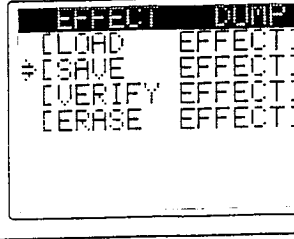
<p>(2) Assign a File Name to the effect to be saved using the alphanumeric ten-keys and cursor keys.</p>		
<p>(3) Press ENTER key.</p>	<p>ENTER</p> 	
<p>(4) Respond to [OK?] prompt by pressing YES key.</p>	<p>- / +</p>  <p>YES</p>	
<p>(5) Press ESCAPE key to exit to Effect Dump menu.</p>	<p>ESCAPE</p> 	

## VERIFY EFFECT PROCEDURES

Verify that Effect data in FZ-1 matches that in DISK, MIDI device or another FZ-1.

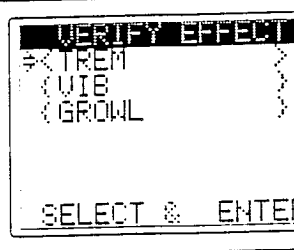
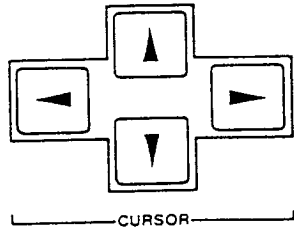
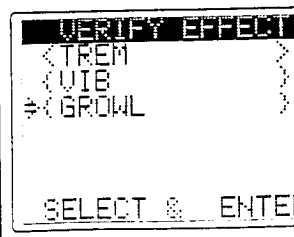



<p>(1) Enter VERIFY EFFECT Operation in Effect Dump Function.</p>	<p>ENTER</p> 	
<p>(2) Select Effect to be verified, using cursor keys. Cursor [▲] and [▼] keys are used to scroll up and down, while [◀] and [▶] keys may be used to select succeeding/preceding "pages" (displays) of File (Effect) names.</p> <p>* Display indicates DISK DUMP, MIDI DUMP or PORT DUMP in correspondance with SELECT DEVICE setting.</p>	 <p>CURSOR</p>	

(3) Press ENTER key.	<p style="text-align: center;">ENTER</p> <div style="border: 1px solid black; width: 40px; height: 15px; margin: auto;"></div>	<pre style="font-family: monospace;"> VERIFY EFFECT (GROWL      ) -- DISK DUMP -- =&gt;[ VERIFY EXEC ]   [OK?] [PRESS YES?]</pre>
(4) Respond to [OK?] prompt by pressing YES key.	<p style="text-align: center;">- / +</p> <div style="border: 1px solid black; width: 40px; height: 15px; margin: auto; position: relative;"> <span style="position: absolute; top: -5px; left: 5px;">▲</span> </div> <p style="text-align: center;">YES</p>	<pre style="font-family: monospace;"> VERIFY EFFECT (GROWL      ) -- DISK DUMP -- =&gt;[ VERIFY EXEC ]   EXECUTING ●</pre>
*If data matches, an "EXECUTED OK" message appears.		<pre style="font-family: monospace;"> VERIFY EFFECT (GROWL      ) -- DISK DUMP -- =&gt;[ VERIFY EXEC ]   EXECUTED OK</pre>
*If data does not match, a "VERIFY ERROR" message appears.		<pre style="font-family: monospace;"> VERIFY EFFECT (-----) -- DISK DUMP -- =&gt;[ VERIFY EXEC ]   VERIFY ERROR</pre>
(5) Press ESCAPE key to exit to Effect Dump menu.	<p style="text-align: center;">ESCAPE</p> <div style="border: 1px solid black; width: 40px; height: 15px; margin: auto;"></div>	<pre style="font-family: monospace;"> DUMP  EFFECT [LOAD  EFFECT] [SAVE  EFFECT] =&gt;[VERIFY EFFECT] [ERASE EFFECT]</pre>

## ERASE EFFET OPERATIONS

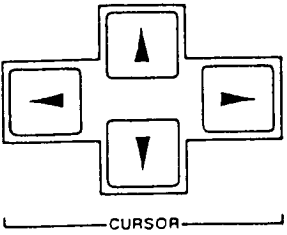
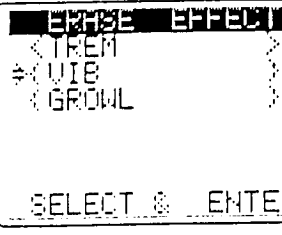
Erase Effect from Disk memory. (This operation cannot be entered when MIDI or PORT are selected in SELECT DEVICE Function.)

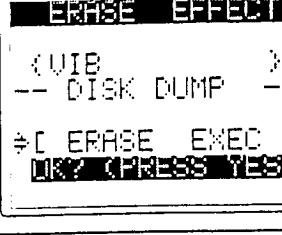
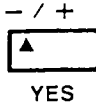
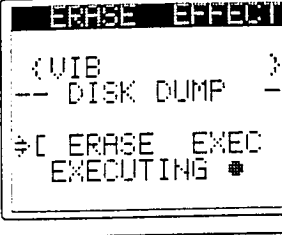
(1) Enter ERASE EFFECT Operation in Effect Dump Function.	<p style="text-align: center;">ENTER</p> <div style="border: 1px solid black; width: 40px; height: 15px; margin: auto;"></div>	<pre style="font-family: monospace;"> ERASE EFFECT &lt;TREM      &gt; (VIE       ) (GROWL     )  SELECT &amp; ENTER</pre>
---	--	---

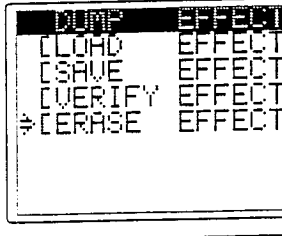

<p>(2) Select Effect to be erased, using cursor keys. Cursor [▲] and [▼] keys are used to scroll up and down, while [◀] and [▶] keys may be used to select succeeding/preceding "pages" (displays) of File (Effect) names.</p>		
<p>(3) Press ENTER key.</p>		
<p>(4) Respond to [OK?] prompt by pressing YES key.</p>		
		
<p>(5) Press ESCAPE key to exit to Effect Dump menu.</p>		

## V. SELECT DEVICE

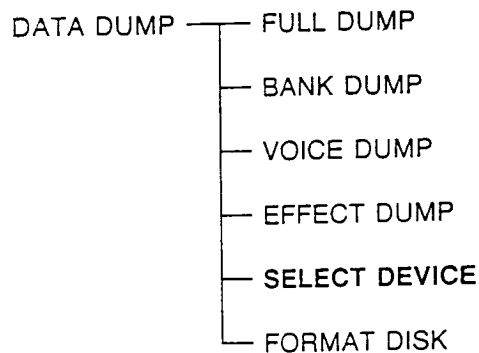
Specify the type of device the FZ-1 is to communicate with, and transfer data through Remote Mode, Port Dump or MIDI Dump.

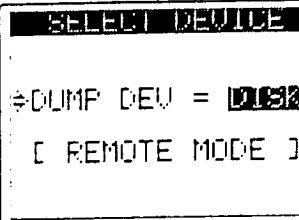
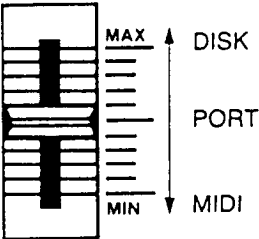
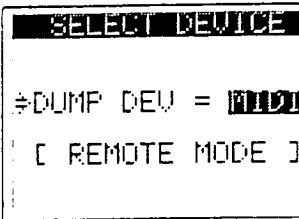

## SELECT DEVICE OPERATIONS

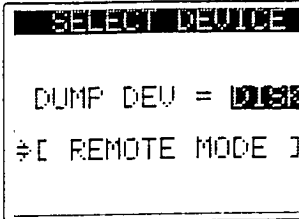
(1) Enter SELECT DEVICE Function in Data Dump Sub-mode.		
(2) Specify DISK, PORT or MIDI, using the Value keys.		
(3) Select REMOTE MODE, if desired.		

## REMOTE MODE OPERATIONS

In the Remote Mode, data can be transferred from a computer into the FZ-1. (Once a transmission command is received from the computer, data transmission cannot be controlled at the FZ-1.)

## PORT DUMP, MIDI DUMP OPERATIONS

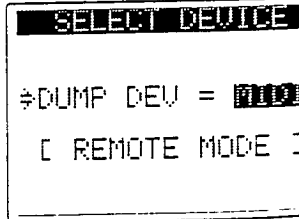

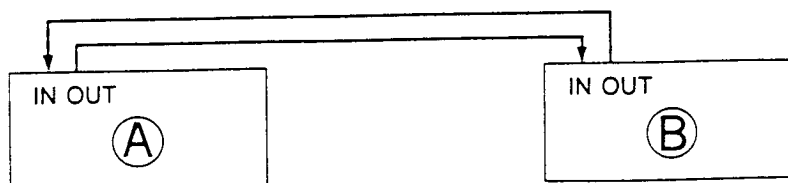

<p>Selecting MIDI or PORT in the SELECT DEVICE parameter allows transmission of data through the MIDI terminals or special 25-pin Port.</p>		
---	---	--

## MIDI COMMUNICATIONS

For MIDI communications, devices must be connected as shown in the diagram below. Note that both IN, and OUT connections must be made to enable data communication, and both devices must be set to the same MIDI Channel (See Section 6: MIDI Functions.)

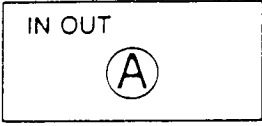
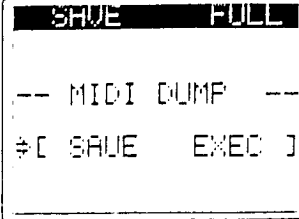
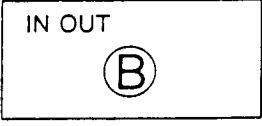
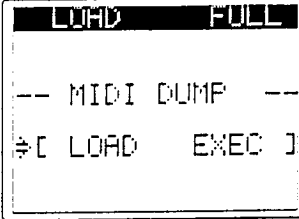

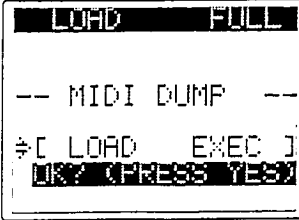
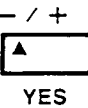
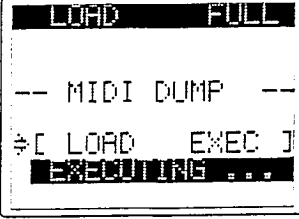
**EXAMPLE: Transmission of all data from Unit A to Unit B.**

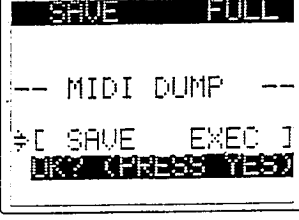
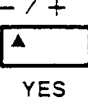
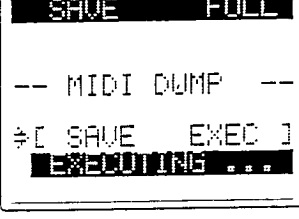
<p>(1) Set Unit A to SAVE FULL.</p>		
<p>(2) Set Unit B to LOAD FULL.</p>		
<p>(3) Press Unit B ENTER key.</p>		
<p>(4) Press Unit B YES key. *Unit B now shows an EXECUTING message.</p>		
<p>(5) Press Unit A ENTER key.</p>		
<p>(6) Press Unit A YES key. *Data transmission from Unit A to Unit B begins.</p>		

**NOTES**

- \*MERGE and VERIFY operations are executed in the same way as LOAD operation (Unit set to receive), Unit set to transmit only in SAVE operations.
- \*BANK, VOICE, and EFFECT data are transmitted in the same way as above example.



## PORT COMMUNICATIONS

The FZ-1 is equipped with a special 25-pin terminal for direct connection with other FZ-1 units. To transmit data through the port, set the SELECT DEVICE parameter to PORT. Other procedures are the same as when transmitting using MIDI. (See above explanation.)

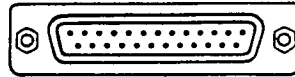

EXTERNAL PORT

```

SELECT DEVICE
#DUMP DEV = PORT
[ REMOTE MODE ]
    
```

## VI. FORMAT DISK

Before a floppy disk can be used in the FZ-1, it must be formatted.

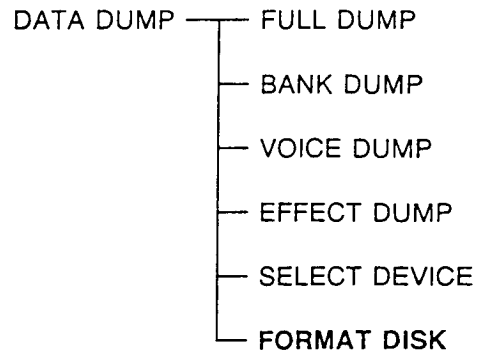

(1) Insert a new disk in the floppy disk drive.

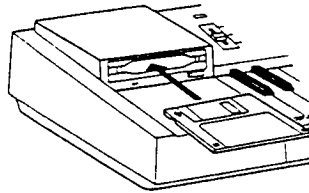

(2) Enter FORMAT DISK Function in Data Dump Sub-mode.

ENTER



```

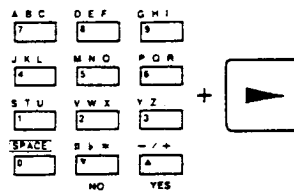

FORMAT DISK
#-- DISK NAME --
<  >
[ FORMAT EXEC ]
    
```

(3) Assign a name to the disk, using alphanumeric ten-keys and cursor keys.



```

FORMAT DISK
#-- DISK NAME --
< WOODWINDS  >
[ FORMAT EXEC ]
    
```

(4) Move cursor to FORMAT EXEC position.		<pre> FORMAT DISK -- DISK NAME -- &lt;WOODWINDS  &gt; =&gt;[ FORMAT EXEC ] </pre>
(5) Press ENTER key.	<p>ENTER</p> 	<pre> FORMAT DISK -- DISK NAME -- &lt;WOODWINDS  &gt; =&gt;[ FORMAT EXEC ] OK? [PRESS YES] </pre>
(6) Respond to [OK?] prompt by pressing YES key.	<p>- / +</p>  <p>YES</p>	<pre> FORMAT DISK -- DISK NAME -- &lt;WOODWINDS  &gt; =&gt;[ FORMAT EXEC ] EXECUTING ... </pre>
		<pre> FORMAT DISK -- DISK NAME -- &lt;WOODWINDS  &gt; =&gt;[ FORMAT EXEC ] EXECUTED OK </pre>

**NOTES**

- \*All existing data is erased when disk is formatted.
- \*It is impossible to save data to unformatted disks.

## SECTION 8:

# OPTIONAL SOFTWARE

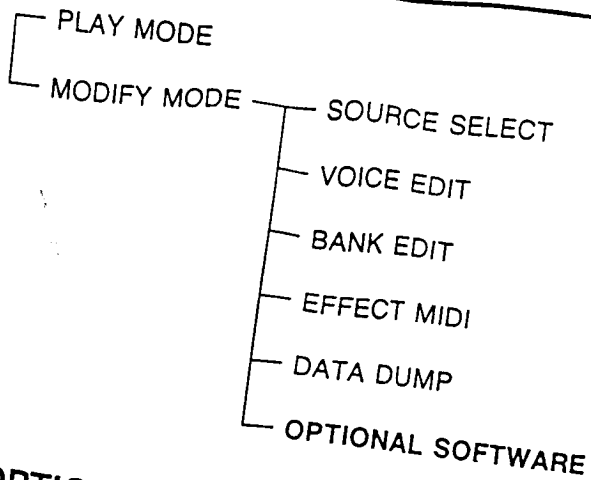

### ■ ABOUT OPTIONAL SOFTWARE

This optional software equips the FZ-1 with additional menus & functions. When using optional software it is necessary to use a special disk sheet. (Do not confuse Optional Software with FZ-1 Sound Disk which features sampled sounds.)

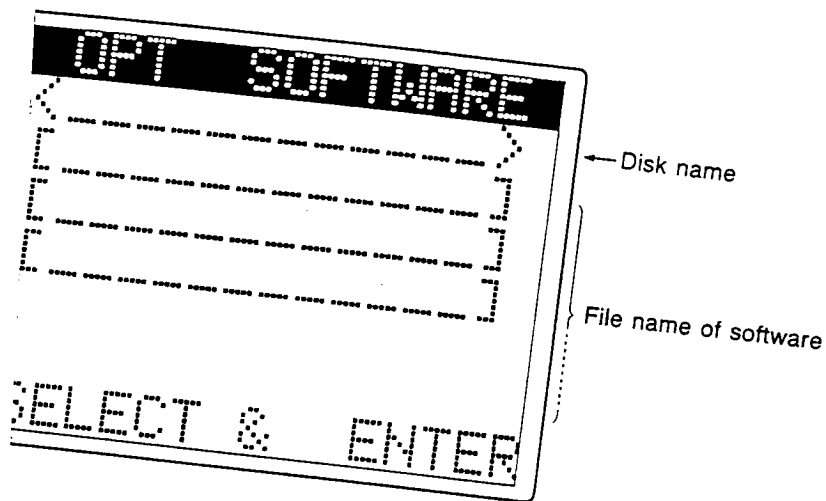

## SECTION 9:

**ERROR MESSAGES**

DISPLAY MESSAGE	MEANING
DISK ERROR	Disk is not formatted or is defective.
FILE NAME EXISTS	Specified File Name already exists. Press ENTER and YES keys to erase existing data and input new data.
NO DISK SPACE	Disk is full (contains maximum number of files).
FILE NOT FOUND	The specified File cannot be found on the input disk, or no information is recorded on the disk.
DISK PROTECTED	The disk Protect Hole is set to the PROTECT side.
DISK NOT READY	Disk is not inserted into floppy disk drive.
VERIFY ERROR	Data in FZ-1 differs from that of disk (or peripheral device) when Verify procedure is performed.
CANCELED	Appears when NO or ESCAPE key are pressed in response to [NEXT DISK?] prompt. This prompt appears when file save requires the use of a second disk.
TIME OUT ERROR	Data has not been transmitted within a specified time period when transmitting through MIDI or PORT. Appears after 10 seconds on the transmitting side, 30 seconds on receiving side.
DATA ERROR	Data Dump through MIDI or PORT was not successful.
NO MEMORY SPACE	FZ-1 memory became full through LOAD or MERGE operation. (Same message appears when number of Banks, Voices or Areas exceeds limit.) Data is NOT transmitted in this case.

# CARE OF YOUR UNIT

---

## 1. Avoid heat, humidity, and direct sunlight.

Do not overexpose the unit to direct sunlight, place it near a heater, or in any area subject to high temperature.

---

## 2. Severe impacts can result in malfunction.

When carrying or transporting the unit, protect the keyboard and buttons by packing with soft cloth.

---

## 3. Keep the unit free of liquids, dust, particles, etc.

Do not allow foreign matter to enter between the keys. Be especially careful of metallic objects such as hairpins, sewing needles or coins. Also, do not allow the unit to get wet.

---

## 4. Never attempt to modify any part of the unit.

Your keyboard is a precision musical instrument made up of sophisticated electronic parts. Any modification of, or tampering with internal components can cause trouble or malfunction.

---

## 5. Do not use lacquer thinner or similar chemicals for cleaning.

Clean the keyboard with a soft cloth dampened with a mild detergent solution. Soak the cloth in the detergent solution and squeeze it until almost dry.

---

## 6. In case of malfunction ....

Check whether buttons and connections are set correctly as indicated in this manual. If the unit still does not work properly, contact the original retailer or a nearby dealer. Never attempt to repair the unit yourself. This can result in serious damage of the components.

---

## 7. Save Sound Data

Be sure to save sound data to a floppy disk while the FZ-1 is still ON, as all data is erased when power is turned OFF.

---

## ■ Handling of the optional RAM Board (MB-10)

RAM Boards are made up of high-precision electronic components. When handling a RAM Board, the following points should be observed.

- ① Static electricity may damage internal circuitry. Before handling a RAM Board, touch a door knob or other metallic object to discharge static electricity from your body.
- ② Take care not to touch exposed portions of electronic components directly.
- ③ Make sure that RAM Board's connector section is kept free from dust or dirt, which may cause bad connections with the FZ-1. If this section becomes dirty, clean with a dampened cloth. Do not touch it directly with your fingers.

## ■ Observe the following when installing the RAM Board

- ① Be sure that the RAM Board is inserted correctly in the rails at both sides.
- ② Insert the RAM Board with the side connectors straight. Then bend the side connectors in as shown in the figure at the right. Press them until you hear a click.
- ③ Incorrectly inserting the RAM Board may damage the FZ-1's internal circuitry, so take care that it is inserted properly.

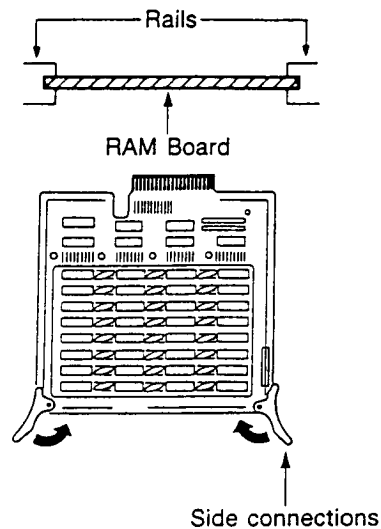

# SPECIFICATIONS

<b>Keyboard:</b>	61-key, 5 octaves (C2 ~ C7), Initial/After Touch
<b>Polyphonic:</b>	8-voice polyphonic
<b>No. of Voices:</b>	64
<b>No. of Banks:</b>	8 (64 Areas per Bank)
<b>Sampling Resolution:</b>	16 bit
<b>Sampling Rates:</b>	36/18/9kHz
<b>Max. Sampling Times:</b>	14.5/29.1/58.2 seconds
<b>w/expansion memory:</b>	29.1/58.2/116.5 seconds
<b>Memory capacity:</b>	1M byte
<b>w/expansion memory:</b>	2M bytes
<b>External memory:</b>	3.5" micro floppy disk drive (MF-2HD)
<b>Source Select:</b>	sampling, wave synthesis, mix write, cross-mix write, reverse write
<b>Voice Edit:</b>	define voice, truncate, DCA envelope, DCF envelope, loop set, LFO set, velocity sensitivity, tune/memory read, keyboard set, dump voice, copy voice, delete voice, replace voice
<b>Bank Edit:</b>	define bank, area no./voice no., original, highest, lowest, max. touch, min. touch, area level, MIDI channel, output channel, dump bank, copy bank, delete bank, delete area, replace bank
<b>Effect/MIDI:</b>	bend range, modulation wheel, after touch, foot VR, MIDI function, dump effect
<b>Data Dump:</b>	full dump, bank dump, voice dump, effect dump, select device, format disk
<b>Controllers:</b>	cursor keys, value keys, value slider, ten-key pad, enter key, escape key, display key, tune key, transpose key, call/set menu key, play key, modify key, volume slider, sampling level slider
<b>Wheels:</b>	pitch bend wheel, modulation wheel
<b>Inputs/Outputs:</b>	line out 1 ~ 8 (output impedance: 1K $\Omega$ ) (output voltage: 0.3V RMS max.) mix out (output impedance: 1K $\Omega$ ) (output voltage: 2.4V RMS max.) mic input (input impedance: 10K $\Omega$ ) (input sensitivity: 4mV) line in (input impedance: 100K $\Omega$ ) (input sensitivity: 100mV) headphones, foot switch, foot VR, MIDI IN/OUT/THRU, expansion memory, external port
<b>Dump Device:</b>	floppy disk, MIDI, port
<b>Display:</b>	96 x 64 dot graphic liquid crystal display (built-in backlight), 16 character x 8 lines
<b>Power:</b>	AC 100, 120, 220, 240V
<b>Power Consumption:</b>	39W

<b>Dimensions:</b>	1036(W) × 325(D) × 120(H)mm (40 <sup>13/16</sup> " × 12 <sup>13/16</sup> " × 4 <sup>3/4</sup> " )
<b>Weight:</b>	17.5kg (38.5 lbs.)
<b>Accessories:</b>	floppy sound disk × 2, power cord, plug cord set, dust cover

\*Design and specifications are subject to change without notice.

## ■ OPTIONS

•2HD sound disk (5 per set) FL-1 through 6

No.	Title	Tone
FL-1	1 BRASS ENSEMBLE	BRASS ENSEMBLE 1, 2, 3
	2 HARPSICHORD	HARPSICHORD 1, 2, 3
	3 CLASSICAL GUITAR	CLASSICAL GUITAR 1, 2, 3
	4 MARIMBA	MARIMBA 1, 2, 3, 4, 5
	5 CELLO/VIOLIN	CELLO 1, 2 / VIOLIN 1, 2 / SPLIT A, B
FL-2	1 ORCHESTRA	ORCHESTRA 1, 2, 3, 4
	2 FLUTE	FLUTE 1, 2, 3, 4
	3 TRUMPET/TROMBONE	TRUMPET 1, 2 / TROMBONE 1, 2 / SPLIT A, B
	4 OBOE	OBOE 1, 2, 3, 4
	5 CLARINET	CLARINET 1, 2, 3, 4
FL-3	1 ELECTRIC PIANO	ELECTRIC PIANO 1, 2, 3
	2 BACKING GUITAR	BACKING GUITAR 1, 2, 3
	3 BRASS ENSEMBLE II	BRASS ENSEMBLE 4, 5, 6
	4 STRING ENSEMBLE	STRING ENSEMBLE 1, 2, 3, 4
	5 CHORUS	CHORUS 1, 2, 3, 4
FL-4	1 ELECTRIC ORGAN	ELECTRIC ORGAN 1, 2, 3, 4
	2 ELECTRIC GUITAR	ELECTRIC GUITAR 1, 2, 3 / MUTED GUITAR
	3 ELECTRIC BASS	ELECTRIC BASS 1, 2, 3, 4
	4 CLAVI	CLAVI 1, 2, 3
	5 DRUMS	DRUMS 1, 2, 3, 4 (3, 4 for MIDI)
FL-5	1 JAZZ PIANO	JAZZ PIANO 1, 2, 3
	2 JAZZ GUITAR	JAZZ GUITAR 1, 2, 3
	3 SLAP BASS/WOOD BASS	SLAP BASS 1, 2 / WOOD BASS 1, 2
	4 VIBRAPHONE	VIBRAPHONE 1, 2, 3, 4, 5
	5 ACOUSTIC GUITAR	ACOUSTIC GUITAR 1, 2, 3, 4
FL-6	1 SEMI ACOUSTIC GUITAR	SEMI ACOUSTIC GUITAR 1, 2, 3
	2 CLASSICAL GUITAR II	CLASSICAL GUITAR 4, 5, 6
	3 TENOR/ALTO SAX	TENOR SAX 1, 2 / ALTO SAX 1, 2 / SPLIT A, B
	4 TRUMPET/TROMBONE II	TRUMPET 3, 4 / TROMBONE 3, 4 / SPLIT A, B
	5 PERCUSSION	PERCUSSION 1, 2, 3, 4

- 2HD blank disk FE-1
- Expansion memory (RAM) MB-10
- Flight case HC-150
- Foot switch SP-10, SP-2, SP-1
- Foot pedal VP-2
- Headphones CP-2



**WARNING:**

CHANGING THE VOLTAGE SELECTOR MAY REQUIRE THE USE OF A DIFFERENT LINE CORD OR ATTACHMENT PLUG, OR BOTH. TO REDUCE THE RISK OF FIRE OR ELECTRIC SHOCK, REFER SERVICING TO QUALIFIED SERVICE PERSONNEL.

**GUIDELINES LAID DOWN BY FCC RULES FOR USE OF THE UNIT IN THE U.S.A.  
(not applicable to other areas).**

This equipment generates and uses radio frequency energy and if not installed and used properly, that is, in strict accordance with the manufacturer's instructions, may cause interference to radio and television reception. It has been type tested and found to comply with the limits for a Class B computing device in accordance with the specifications in Subpart J of Part 15 of FCC Rules, which are designed to provide reasonable protection against such interference in a residential installation. However, there is no guarantee that interference will not occur in a particular installation. If this equipment does cause interference to radio or television reception, which can be determined by turning the equipment off and on, the user is encouraged to try to correct the interference by one or more of the following measures:

- ..... reorient the receiving antenna
- ..... relocate the computer with respect to the receiver
- ..... move the computer away from the receiver
- ..... plug the computer into a different outlet so that computer and receiver are on different branch circuits.

If necessary, the user should consult the dealer or an experienced radio/television technician for additional suggestions. The user may find the following booklet prepared by the Federal Communications Commission helpful: "How to Identify and Resolve Radio-TV Interference Problems". This booklet is available from the US Government Printing Office, Washington, D.C., 20402, Stock No. 004-000-00345-4.



## Free Manuals Download Website

<http://myh66.com>

<http://usermanuals.us>

<http://www.somanuals.com>

<http://www.4manuals.cc>

<http://www.manual-lib.com>

<http://www.404manual.com>

<http://www.luxmanual.com>

<http://aubethermostatmanual.com>

Golf course search by state

<http://golfingnear.com>

Email search by domain

<http://emailbydomain.com>

Auto manuals search

<http://auto.somanuals.com>

TV manuals search

<http://tv.somanuals.com>