

Adit 3500

QUICK START GUIDE



Part Number: 002-0250-0010

Product Release: 1.6

September 2007

Copyright 2007 Carrier Access Corporation. All rights reserved.

The information presented in this manual is subject to change without notice and does not represent a commitment on the part of Carrier Access Corporation. The hardware and software described herein are furnished under a license or non-disclosure agreement. The hardware, software, and manual may be used or copied only in accordance with the terms of this agreement. It is against the law to reproduce, transmit, transcribe, store in a retrieval system, or translate into any medium - electronic, mechanical, magnetic, optical, chemical, manual, or otherwise - any part of this manual or software supplied with the Adit 3500 for any purpose other than the purchaser's personal use without the express written permission of Carrier Access Corporation.

The Carrier Access Logo and Adit are registered trademarks of Carrier Access Corporation. All other brand or product names are trademarks or registration trademarks of their respective companies or organizations.

Contact Information:

Carrier Access Corporation
5395 Pearl Parkway
Boulder, CO 80301-2490
Corporate Phone: (303) 442-5455
Fax: (303) 443-5908
www.carrieraccess.com

Customer Support Direct: (800) 786-9929
E-mail: tech-support@carrieraccess.com

QUICK START GUIDE

In this Guide

- Unpacking and Inspection
- Installation Environment
- User Safety
- Installation
 - Compliant Installation
 - Ferrite Beads
 - Wall Mounting
 - Rack Mounting
 - Battery Backup
- Chassis Overview
- Interface Connectors
- Reset Button
- Alarm/Status LEDs
- Web-Based Management
- Setting up a CLI Connection
- Log in
- Key Enabled Software Features
- Basic Configuration
- Web-Based Management
 - Restore Factory Defaults
 - Modify Default Admin User
 - Configure WAN Interface for Internet Connectivity
 - Configure the Adit 3500 as a SIP Gateway

Unpacking and Inspection

WARNING! OBSERVE PRECAUTIONS FOR HANDLING ELECTROSTATIC DEVICES.

1. Inspect containers for damage during shipment. Report any damage to the freight carrier for possible insurance claims.
2. Compare packing list with office records. Report any discrepancies to the office.
3. Open shipping containers, be careful not to damage contents.
4. Inspect contents and report any damage.
5. If equipment must be returned for any reason, carefully repack equipment in the original shipping container with original packing materials if possible.
6. If equipment is to be installed later, replace equipment in original shipping container and store in a safe place until ready to install.

Electrostatic Discharge (ESD) Precautions

ESD can damage processors, circuit cards, and other electronic components. Always observe the following precautions before installing a system component.

1. Do not remove a component from its protective packaging until ready to install it.
2. Wear a wrist grounding strap and attach it to a metal part of the system unit before handling components. If a wrist strap is not available, maintain contact with the system unit throughout any procedure requiring ESD protection.



WARNING! INTEGRATED CIRCUITS (ICs) ARE EXTREMELY SUSCEPTIBLE TO ELECTROSTATIC DISCHARGE. UNLESS YOU ARE A QUALIFIED SERVICE TECHNICIAN WHO USES TOOLS AND TECHNIQUES THAT CONFORM TO ACCEPTED INDUSTRY PRACTICES, DO NOT HANDLE ICs.

The ESD warning label appears on packages and storage bags that contain static-sensitive products and components.

Installation Environment

The environment in which you are installing the Adit 3000 must meet the following conditions:

- Operating temperature range: 32° to 104° F (0° to 40° C)
- Storage temperature range: -40° to 158° F (-40° to 70° C)
- Maximum operating altitude: 10,000 ft. (3,048 m)
- Maximum non-operating altitude: 40,000 ft. (12,192 m)
- Relative humidity (non-condensing) range: 0 to 95%

WARNING! THE ADIT 3000 IS DESIGNED FOR WALL AND RACK MOUNTING ONLY. IT IS NOT DESIGNED FOR DESKTOP USE.

User Safety

CAUTION! WHEN USING YOUR TELEPHONE EQUIPMENT, BASIC SAFETY PRECAUTIONS SHOULD ALWAYS BE FOLLOWED TO REDUCE THE RISK OF FIRE, ELECTRIC SHOCK AND INJURY TO PERSONS, INCLUDING THE FOLLOWING:

- Do not use this product near water for example, near a bathtub, washbowl, kitchen sink or laundry tub, in a wet basement or near a swimming pool.
- Avoid using a telephone (other than a cordless type) during an electrical storm. There may be a remote risk of electric shock from lightning.
- Do not use the telephone to report a gas leak in the vicinity of the leak.
- Use only the power cord and batteries indicated in this manual. Do not dispose of batteries in a fire. They may explode. Check with local codes for possible special disposal instructions.
- Refer to the installation section of this manual for a safe and proper installation procedure. All wiring external to this equipment should follow the current provision of the National Electrical Code.

Installation

The following are instructions for a compliant installation of the Adit 3500. Please note the following warnings, before installing the unit.

For wall and rack mount instructions, use the links listed below to the appropriate section:

- **Wall Mounting**
- **Rack Mounting**
- **Battery Backup**

WARNING! OBSERVE PRECAUTIONS FOR HANDLING ELECTROSTATIC DEVICES. SEE *Electrostatic Discharge (ESD) Precautions* ON PAGE 4 FOR DETAILED INFORMATION.

WARNING! THE ADIT 3500 DS1 NETWORK INTERFACE PORTS ARE CERTIFIED WITH ACTA, INDUSTRY CANADA AND UL FOR DIRECT CONNECTION TO PUBLIC DIGITAL NETWORKS. TO PREVENT EQUIPMENT DAMAGE FROM LIGHTNING SURGES, AC INDUCTION OR POWER LINE CONTACT, UTILIZE LISTED PRIMARY PROTECTORS AT THE BUILDING ENTRANCE WITH MINIMUM 4 OHM CURRENT-LIMITING AND MAXIMUM 600V IMPULSE BREAKDOWN AT 1000V/USEC. THE ADIT 3500 DS1 PORTS COME EQUIPPED WITH SECONDARY OVERVOLTAGE AND OVERCURRENT PROTECTION. THE INSTALLATION IS REQUIRED TO MEET LOCAL OR NATIONAL ELECTRIC CODES FOR COMMUNICATION SYSTEMS.

WARNING! THE ADIT 3500 FXS INTERFACE PORTS ARE INTENDED TO SERVE INDOOR COMMUNICATION CONDUCTORS ONLY. OVERVOLTAGE AND OVERCURRENT PROTECTION IS PROVIDED TO PREVENT EQUIPMENT DAMAGE FROM LIGHTNING SURGES OR AC POWER LINE CONTACT INSIDE BUILDINGS. THE FXS PORTS ARE NOT SUITABLE FOR CONNECTION TO EXPOSED OUTDOOR COMMUNICATION CONDUCTORS.

Compliant Installation



NOTE: It is important the DS1/E1 Network Interface Cables are secured separately from the power and Signal Cables.

1. Inspect the unit.
2. Mount the unit.
 - Wall mounting installation, see *Wall Mounting* on page 9.
 - Wall mounting with Battery Backup Unit, see *Battery Backup* on page 12.
 - Rack mounting installation, see *Rack Mounting* on page 10.
3. Ground the unit.

WARNING! THE ADIT 3500 IS REQUIRED TO BE PERMANENTLY GROUNDED FOR THE PROTECTION OF USERS AND SERVICE PERSONNEL. REFER TO *Grounding the Unit* ON PAGE 3 FOR DETAILED INSTRUCTIONS.

4. Connect DS1 (T1), and Ethernet connections as needed.
5. Connect RS-232 connector and connect via HyperTerm on your PC.
Note: With this running before power is enabled, you can monitor the boot process.
6. Attach PBX and phone line cables.
7. Connect Power to the unit.
8. Monitor the boot process on your PC, when complete the status light should be green.
9. For any software enabled features, enter the key command. See the **key** command in the Adit 3000 CLI Reference Manual, for detailed information.
10. To verify use the **show version** command.
11. To provision the unit. See *Web-Based Management* on page 23, for detailed instructions.

Ferrite Beads

The following ferrite bead is required on the Adit 3500 configurations that do not have the FXS 4 channel option. The ferrite bead will enable the Adit to be compliant with EMI standards FCC Part 15 and ICES-003 Class A.

Ferrite beads shipped with Adit chassis:

Ferrite Provided	Part Number	Intended For
1 large	P/N 010-0051	Power cable, which requires a loop through the bead (see drawing).

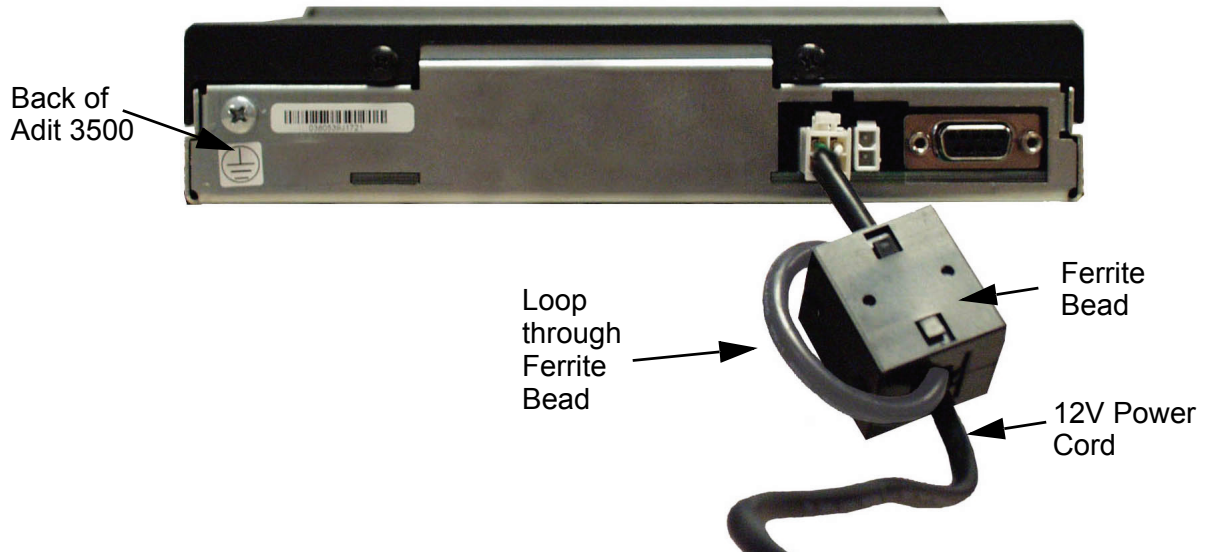

For additional information on Ferrite beads and their installation on the Adit 3500, please contact Carrier Access Customer Support at (800) 786-9929.

Wall Mounting

Before beginning the mounting process, verify that the installation area is a stable environment, clean and free from extremes of temperature, shock, vibration and EMI.
See *Installation Environment* on page 5.

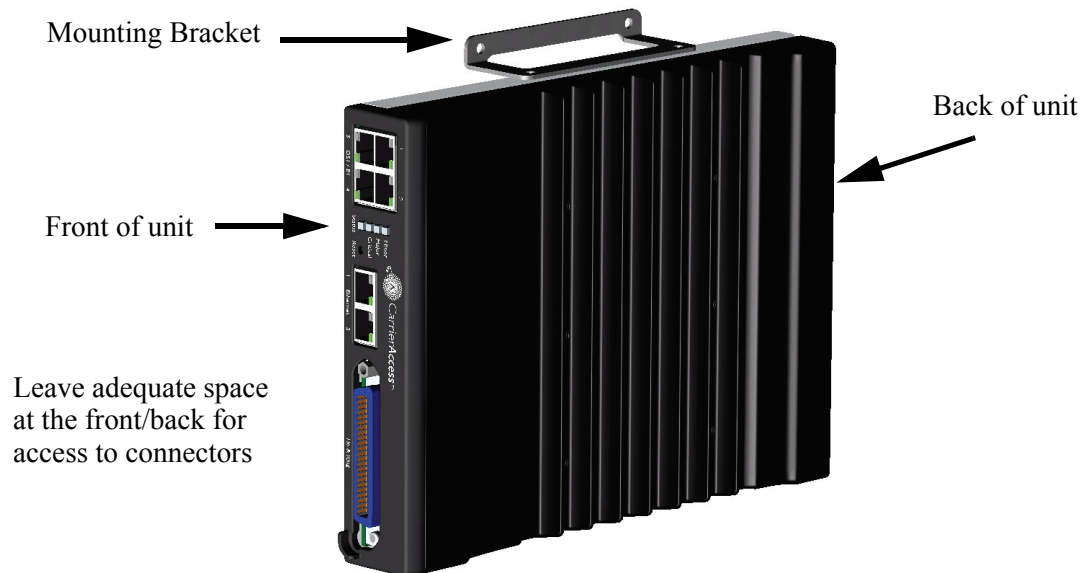

The Adit 3000 is delivered with mounting brackets that can easily be attached for quick and easy wall mounting, as shown in the illustration above.

To install the unit to the wall:

1. Attach the wall mount brackets to the Adit 3000, with wall attachment flange pointing away from the unit, as shown above. Attach with 4 screws provided (2 for each bracket).
2. Mount the unit to the wall using appropriate mounting screws (not included).
Note: it is acceptable to mount on drywall with suitable anchor-type mounting screws.

NOTE: The Adit 3000 must be mounted with the brackets on the top and bottom, as shown above.

Rack Mounting

This is an Optional Feature.

NOTE: Rack mounting kits are available for both 19 and 23 inch racks. 1 Rack Unit (RU) of spacing is required above the Adit 3000 in the Rack Mount Unit.

To rack mount the Adit 3000, follow the instructions below:

1. Attach bracket ears to Rack Mounting Tray using four #10-32 x 1/4" screws on each side. The Mounting Ears can be used for both a 19 or 23 inch rack. The drawing below shows a top view of the 2 versions.

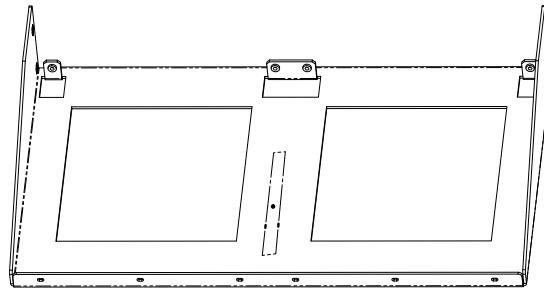

Rack Mounting Tray

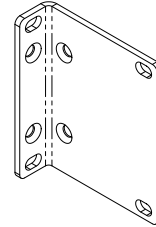

Mounting Ear

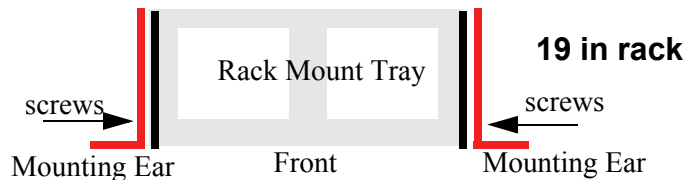
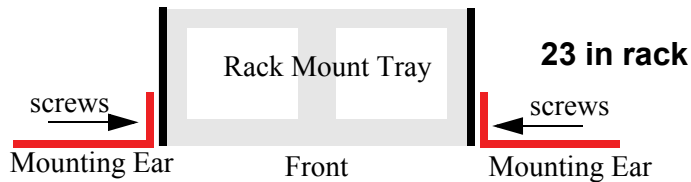

2. Attach the Rack Mounting Tray assembly (with mounting ears attached) to rack, using four #10-32 x 1/4" screws (two on each mounting ear).
3. Remove wall mount and screws, if attached, from Adit 3500 unit.
Note: Adit 3500 and wall mounting bracket are not assembled from the factory.

4. Place the Adit 3000 on the Tray Slide and attach with the 4 screws removed in step 2.

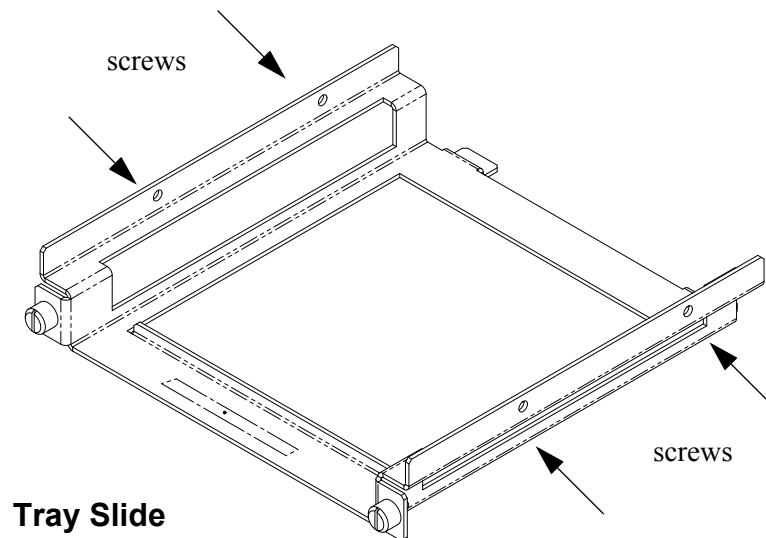

5. Slide the assembled piece (Adit 3000 and Tray Slide) onto the installed Rack Mounting Tray.

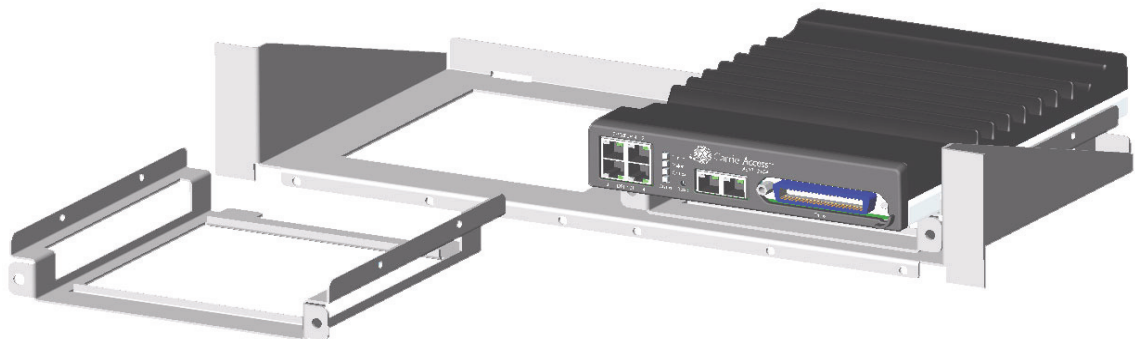

6. Secure the Tray Slide to the Rack Mounting Tray with the attached screws on the Tray Slide.

NOTE: The mounting brackets are designed to not allow units to be mounted closer than recommended.

Battery Backup

This is an Optional Feature.

The Adit 3500 Battery Backup is designed specifically for the Adit 3500. The battery backup unit is a single 12V sealed lead-acid battery in a metal enclosure designed for wall mounting.

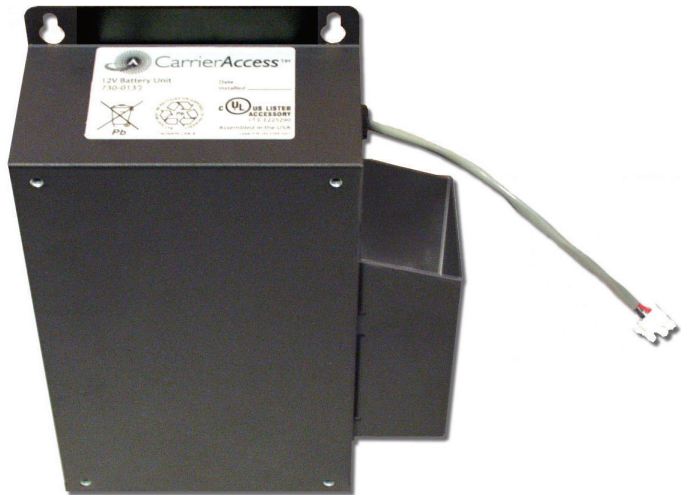

Installation

There are two possible configurations to wall mount the Adit 3500 and the Battery Backup.

NOTE: It is recommended that the BBU be mounted to a wooden backboard using (4) #6 screws, or to drywall using (4) #6 screws with anchors. These screws are not provided.

1. Battery Backup attached to wall, with Adit 3500 mounted on the Battery Backup
2. Adit 3500 and Battery Backup attached to wall.

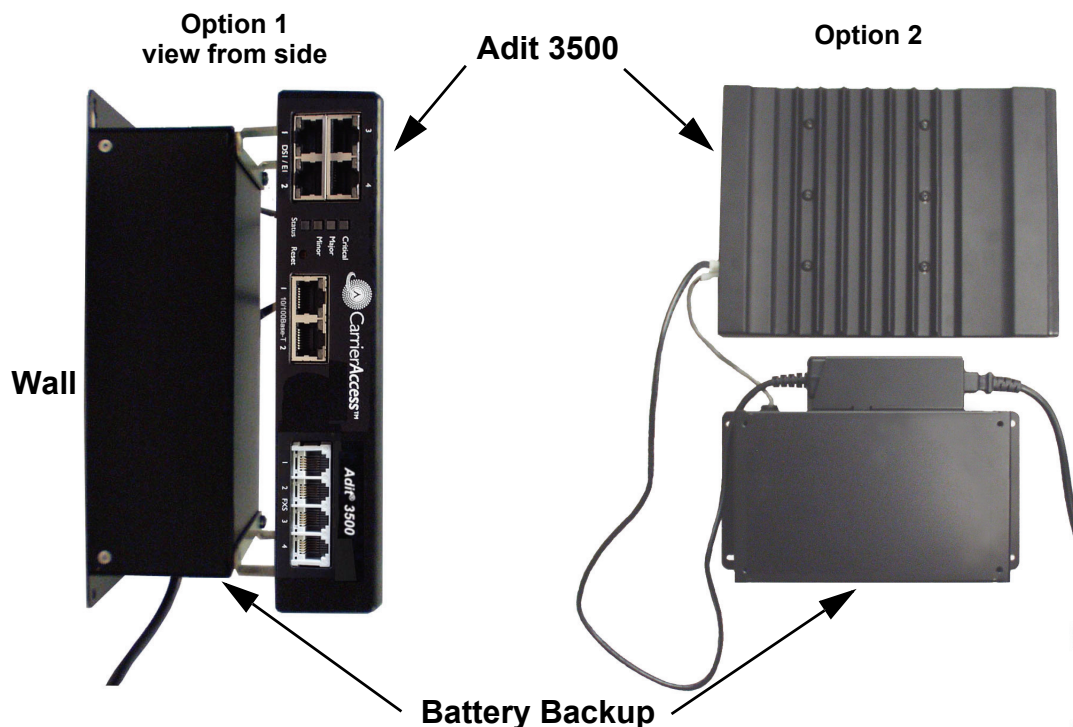

#1 Adit 3500 mounted on top of the Battery Backup

This method will use a minimal amount of wall space. Note: This installation will require a minimum wall space of space of: 9" (H) x 14" (W) x 5" (D).

1. Mount the Battery Backup to the wall with (4) #6 x 1 coarse thread screws Note: Screws are not provided

- Mark the location for the top 2 screws (using BBU mounting keyhole as a guide)
- Screw these 2 screws into the wall at marked locations.
Note: do not screw tight to the wall, leave 1/4" to allow BBU mounting keyholes to slip over screw head.
- Attach the BBU by slipping the screw heads through the keyhole slots of the BBU, and let unit drop slightly to allow screwheads to enter top of the keyhole.
- Screw bottom 2 screws into mounting holes at the bottom of the unit.
- Tighten all screws to the wall.

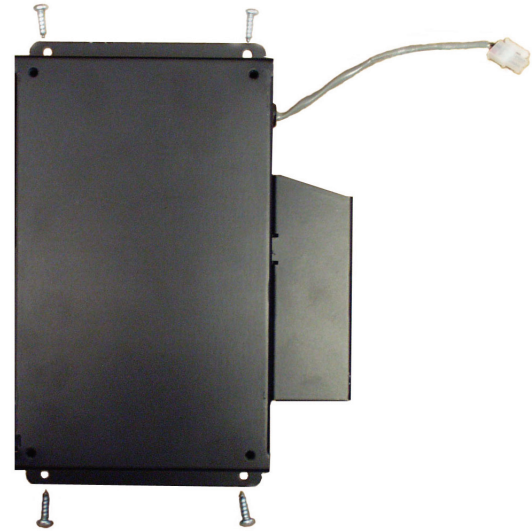

2. Attach Adit 3500 Wall Mounting Brackets to the BBU. Note: Brackets are provided with the Adit 3500 unit.

- Each bracket is attached to the outer facing side of the BBU.
Note the bracket orientation in the graphic.

3. Insert Adit 3500 Power cord through the holder on the right. This supports the weight of the adapter portion of the power cord.

- The connector to the wall runs out the bottom, while the connector to the Adit 3500 will run out of the top.

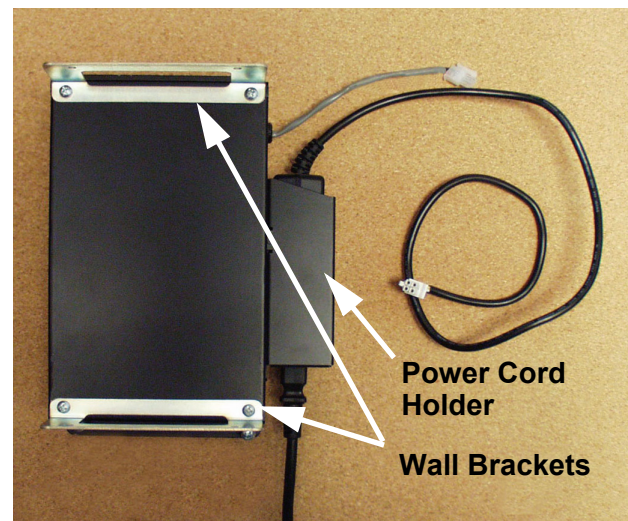

Quick Start Guide

Installation

4. Attach Adit 3500 to the assembled BBU and brackets.

- Each bracket attaches to the side of the Adit 3500.
Note the orientation of the Adit in the graphic.

5. Attach power cords.

- Connect cord from BBU to the Adit 3500 (2 pin connector).
- Connect 12V power cord to Adit 3500.

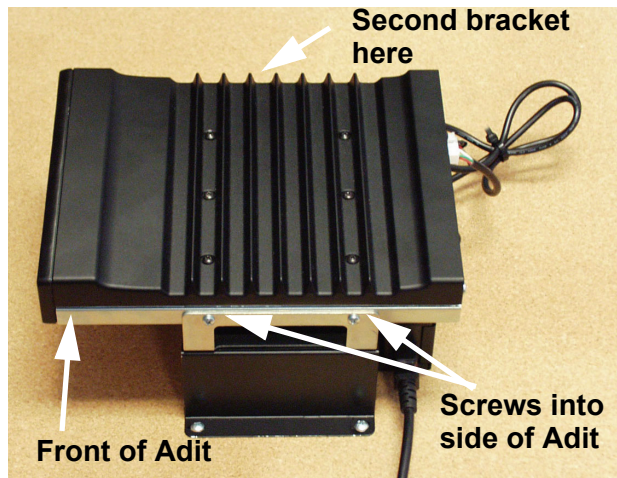

#2 Adit 3500 and Battery Backup mounted to the wall

This method requires a more wall space. Note: This installation will require a minimum of wall space of: 17" (H) x 14" (W) x 2.5" (D).

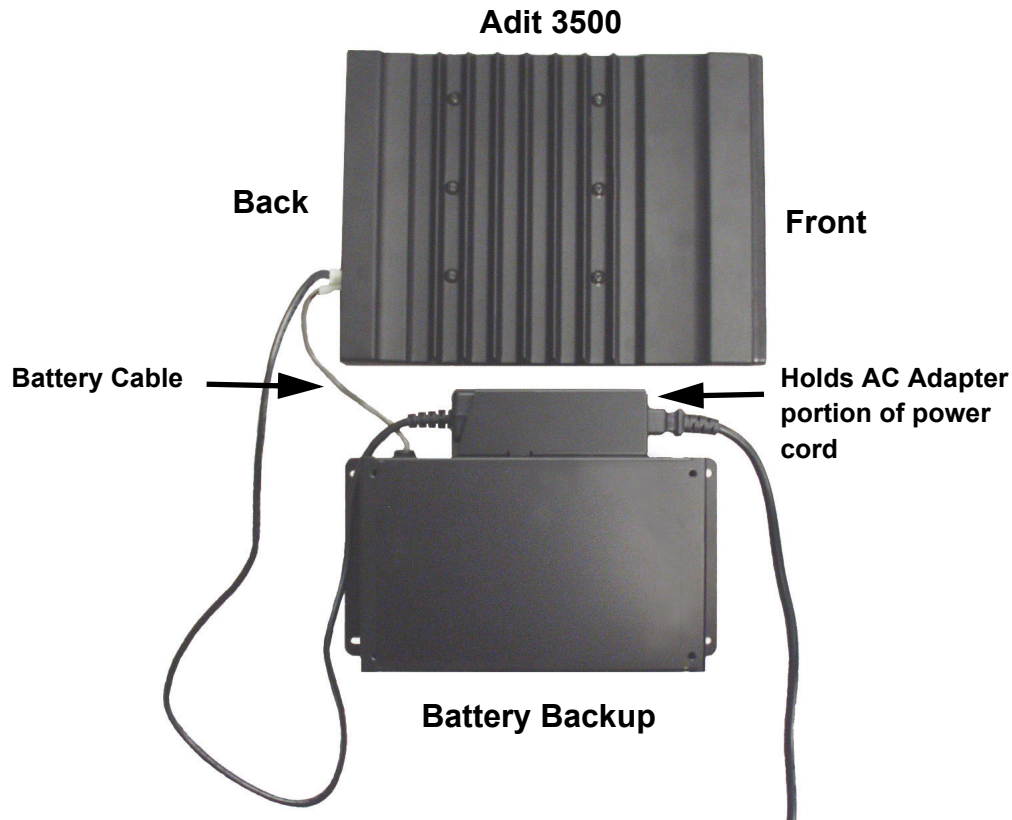

- 1. Mount the Battery Backup to the wall with (4) #6 screws, by:**
 - Mark the location of the left-side 2 screws (using the BBU mounting keyhole as a guide). Note: this installation of the BBU is oriented with the mounting keyholes to the left side.
 - Screw these 2 screws into the wall at marked locations. Note: do not screw tight to the wall, leave 1/4" to allow BBU mounting keyholes to slip over screw head.
 - Attach the BBU by slipping the screw heads through the keyhole slots at the left of the BBU, and slide unit to the right to allow screwheads to enter the narrow end of the keyhole.
 - Screw the second set of 2 screws into mounting holes on the right of the unit.
 - Tighten all screws to the wall.
- 2. Insert Adit 3500 Power cord through the holder on the top of the BBU. This supports the weight of the adapter portion of the power cord.**
- 3. Attach Adit 3500 to the wall following the instructions, *Wall Mounting* on page 9. Attaching the Adit 3500 to the wall above the BBU.**

Note: there is a distance limit between the Adit and the BBU (note the length of the battery cable to the Adit).
- 4. Attach power cords.**
 - Connect cord from BBU to the Adit 3500 (2 pin connector).
 - Connect 12V power cord to Adit 3500.

Adit 3500 Battery Backup Power Connector

The following cable, is hard wired to the Adit 3500 Battery Backup and connects the Adit 3500.



Pinout

Wire	Definition
Red	12V (+)
Black	12V (-)

Chassis Overview

The following illustrations show all connectors on the Adit 3500.

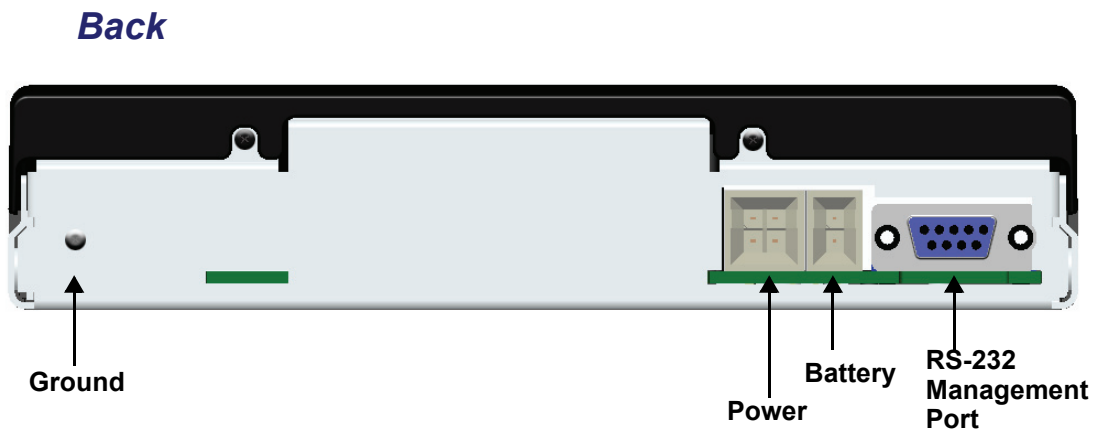
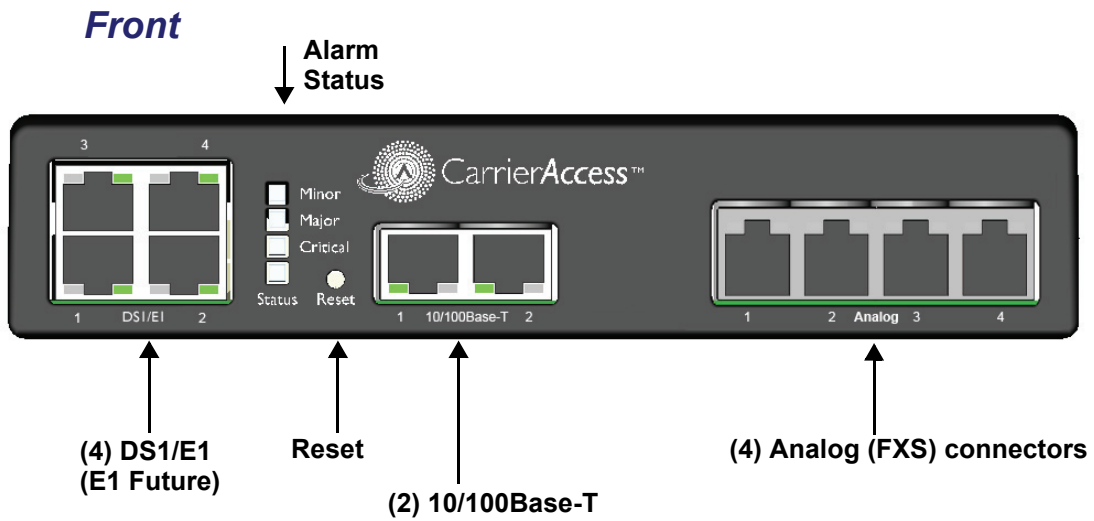

Interface Connectors

The following are the Adit 3500 interface connectors:

Note: The following is dependant upon how the system (hardware) is configured. Systems can be ordered with/without FXS, and can have from 1-4 DS1 ports.

Front of Adit

- 4 DS1 Ports (used for DS1 WAN and/or PRI/CAS trunks) (RJ-45C connector).
 - (1) T1-based WAN - uses 1 or 2 DS1 ports
 - (1) PRI/CAS group - uses 1 or 2 DS1 ports
- (1) 10/100Base-TX WAN port (RJ-45 connector)
- (1) 10/100Base-TX LAN port (RJ-45 connector)
- 4 FXS (RJ-11 connector)

Back of Adit

- RS-232 craft port connector for local management
- Power input connector
- Battery input connector
- Ground connector

Grounding the Unit

WARNING! THE ADIT 3500 IS REQUIRED TO BE PERMANENTLY GROUNDED FOR THE PROTECTION OF USERS AND SERVICE PERSONNEL.

Chassis ground is located on the back of the unit.
To ground the unit:

1. Connect a minimum 14 AWG ground wire with a #8 ring tongue terminal (not included) to the chassis ground on the back of the unit. Secure with the 8-32 screw and lock washer provided.
2. Connect the opposite end of the ground wire to a suitable earth grounding point such as a building grounding electrode, metal water pipe, or metal building structure that is in compliance with article 250 of NEC.

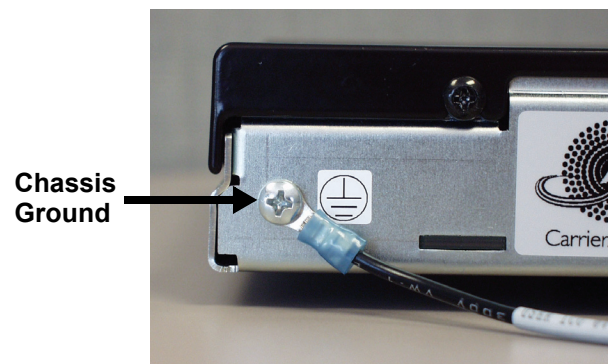

12 VAC Power Connection

The Adit 3500 is powered by a 12 VAC Power Converter, which provides 12 VDC to the unit.

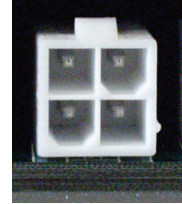
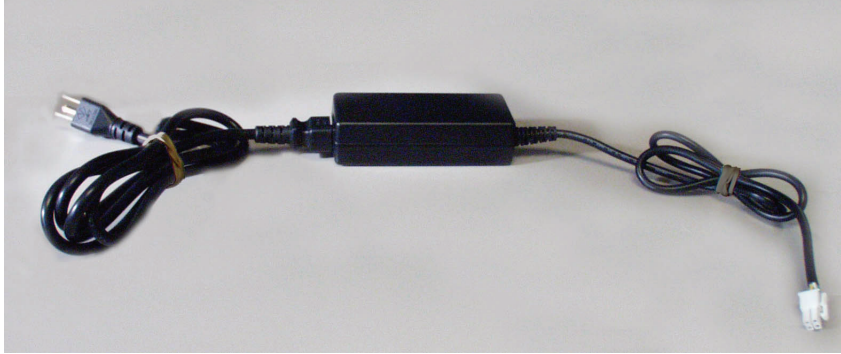

Item		Specification
Input	Rate input voltage	AC100V-240V
	Vibration input voltage range	AC90V-255V
	Frequency Rated	50-60 Hz
	Frequency Vibration	47-63Hz
	Input rated current	15A max. at 115VAC cool start 30A max. at 230VAC cool start
	Leakage current	0.25mA
	Efficiency	70% Min.
Output	Output voltage	13.5VDC
	Output max. current	2.2A±150mA (V out = 9VDC-13VDC)
	Output min. current	0A (V out = 14VDC)
	Line regulation	±1%
	Load regulation	±5%
	Short circuit protection	Output shut down auto restart

Battery Connection

The Battery connector on the Adit 3500 is a 2 pin connector provided specifically for the Battery Backup option. See *Battery Backup* on page 10 for additional information.



DS1/E1 Connection Ports

Each DS1/E1 connection port is equipped with a standard RJ-48C (female) on the Adit 3500 unit. Note: E1 will be available in a future release.

The pinouts are as follows:

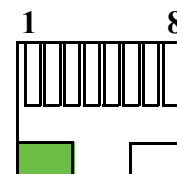

DS1/E1 RJ-48C

The pinouts are as follows:

Pin	Name	Description
1	Receive Ring	Receive from DS1 network
2	Receive Tip	Receive from DS1 network
3	N/C	Not connected
4	Transmit Ring	To DS1 network
5	Transmit Tip	To DS1 network
6 -8	N/C	Not connected

The LEDs are as follows (left LED only):

State	Description
Off	Off line
Green	Normal
Red	Loss of Signal (LOS)
Yellow	Bipolar Violation (BPV)
Flashing Green	Loopback active
Flashing Yellow	Yellow Alarm (Remote Alarm Indication)
Flashing Red (Slow)	Loss of Frame (LOF) or Alarm Indication Signal (AIS)
Flashing Red (Fast)	Self-test Failure

10/100Base-TX Ethernet

The 10/100Base-TX Ethernet (female) ports provide connectivity for Router WAN and/or LAN ports and for management connection via Telnet and/or SNMP to a Network Management System.

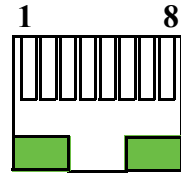

Ethernet (RJ-45)

The pinouts are as follows:

Note: This is a hub pinout, you will need a straight cable to connect to a PC.

Pin	Name	Description
1	Receive +	Receive from network
2	Receive -	Receive from network
3	Transmit +	Transmit to network
4-5	N/C	Not connected
6	Transmit -	Transmit to network
7-8	N/C	Not connected

The LEDs are as follows:

LED	State	Description
Left LED	The left LED shall show Link Status.	
	Off	Link Down
	Green	Link Up
	Flashing Green	Traffic on Link
	Yellow	Collision status
Right LED	The right LED shall indicate Link Speed.	
	Off	10 Mbit/sec, down or not connected
	Green	100 Mbit/sec

RS-232 Craft Port (Female DB-9)

The RS-232 craft port connector (female) is for connection to an external PC or Hayes-compatible modem for local or remote configuration, management, and performance monitoring using the Adit 3500 Command Line Interface (CLI).

The RS-232 craft port connects via a female DB-9 connector on the Adit 3500.

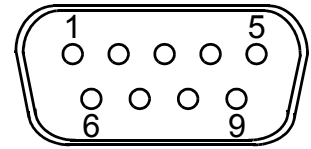

The pinouts are as follows:

Pin	Direction	Description
1	Outbound	Carrier Detect
2	Outbound	Receive Data
3	Inbound	Transmit Data
4	Inbound	Data Terminal Ready
5	N/A	Signal Ground
6	Outbound	Data Set Ready
7	Inbound	Request to Send
8	Outbound	Clear to Send
9	N/C	Not connected

RJ-11 Connector

There are four RJ-11 (female) connectors for the FXS ports.

The pinouts are as follows:

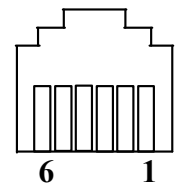

Pin	Name	Description
1 - 2	N/C	Not connected
3	R	Ring
4	T	Tip
5 - 6	N/C	Not connected

Reset Button

The system can be reset by pressing the reset button located on the front panel.



Alarm/Status LEDs

LED	State	Description
Critical	Off	No critical alarms present
	Red	Critical alarms present. Critical alarms include: user-configured manor environmental inputs.
Major	Off	No major alarms present
	Red	Major alarm present. Major alarms include: user-configured manor environmental inputs, DS1 short, DS1 open, DS1 facility alarm, DS1 RAI, DS1 AIS, DS1 LOF, DS1 LOS, WAN fault, Ethernet fault and dead card alarms.
Minor	Off	No minor alarms present
	Red	Minor alarms present. Minor alarms include: user-configured manor environmental inputs, DS1 excessive line code violations.
Status	Off	No power to system
	Green	Application running, no detected system problems.
	Green Flashing	Power-On Self Test (POST) successful. System booted. Loading Application.
	Green/Yellow	Flashing alternate colors. Application Self Test in Process.
	Yellow	Yellow while booting. If this stays a steady yellow the Power-On Self Test (POST) failed.
	Yellow Flashing	Power-On Self Test (POST) In Process.
	Red	System Failure

Web-Based Management

The web-based management interface allows you to control various system parameters. The interface is accessed through a web browser.

To access the management console:

NOTE: The following assumes that you have connected the PC to the LAN port of the Adit 3500.

1. Launch a web browser on your PC in the LAN to which the Adit 3500's LAN port is connected. Note: If connection to the 3500 is to be through an Ethernet or T1 WAN, the remote admin WAN access must be enabled with the following command sequence:

Command	Description
Username: admin Password: *****	Log into the system (username and password).
Adit 3500> enable	Enter the Privileged mode.
Password: *****	Enter password for the Privileged mode.
#configure terminal	Enter the Configuration mode.
(config)# remote-admin web primary-port enable	Enable remote web admin.

2. Type the Adit 3500's IP address or name in the address bar.
Example: `http://192.168.1.1`.
 - Default IP address is **http://192.168.1.1**
Note: to display the current IP address of the systems, use the following CLI command:
#show interface ethernet 1 (LAN)
#show interface ethernet 2 (Eth WAN)
3. Login to the unit.
Enter User Name and Password. Note: these setting should be changed from the default settings after the initial login.
 - Default user name is **admin**
 - Default password is **admin 123**

NOTE: After a few minutes of inactivity, the session will automatically timeout and the operator will be required to log in to continue the session.

WARNING! IF YOUR USER NAME AND PASSWORD ARE SET TO THE DEFAULT SETTING, IT IS RECOMMENDED THAT YOU MODIFY THEM FOR SECURITY PURPOSES.

Setting up a CLI Connection

A CLI connection will require the LAN or WAN IP address of the unit. Note: If the WAN IP address is used, the remote admin WAN access must be enabled with the following command sequence:

Command	Description
Username: admin Password: *****	Log into the system (username and password).
Adit 3500> enable	Enter the Privileged mode.
Password: *****	Enter password for the Privileged mode.
#configure terminal	Enter the Configuration mode.
(config)# remote-admin web primary-port enable	Enable remote web admin.

NOTE: For Adit 3500 CLI commands see the *Adit 3000 CLI Reference Manual*. This is a separate document and can be found on the CD that is provided with the product, or on the Carrier Access customer website.

To connect with CLI, set up the connection:

- If connecting via the Ethernet 100Base-TX connection, use a Telnet TCP/IP program to access the CLI. This requires an IP address of the unit.
Note: to display the current IP address of the unit, use the **ifconfig** command.
- If connecting via RS-232, the port settings should be set to:
Bits per second: **115200** Data bits: **8**
Parity: **None** Stop bits: **1**
Flow control: **None**
- Set your Terminal Emulation to: **VT100**

NOTE: When using Tera Term (Telnet program) TCP/IP, CLI commands will not be recognized until the following setup is completed.

- In Tera Term go to **Setup/Terminal**
- Set the **New-line/Transmit** value **CR+LF**

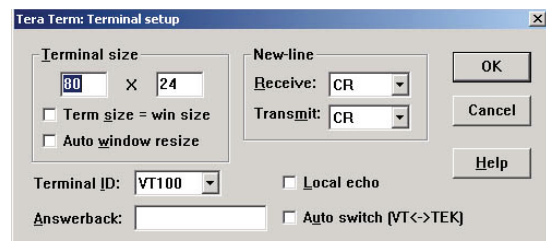

Log in

After successful connection, via telnet or HyperTerm, the user must login. Default Logins are:

Login: **admin**

Password: **admin123**

After successful login the prompt will be displayed as follows:

Adit 3500>

NOTE: It is recommended that you change your password from the default.

Key Enabled Software Features

The Adit 3500 has additional features that are not provided on the base system. These features can be purchased with the product or added later as needed. These features are enabled via a Software Key (example: G.729). The number of keyed features may expand with the development of the product, therefore to see a list of current keyed features, or to purchase a key, contact Carrier Access Customer Service or Sales.

To enter a software key, use the following CLI command:

Syntax: (config)# key *key-code*

Example: (config)# key cxusdfutkj3diosn412C

NOTE: Keys may only be entered through the CLI (not through the GUI).

The Key Enabled Software Features are displayed on the **Advanced/Technical Information** window.

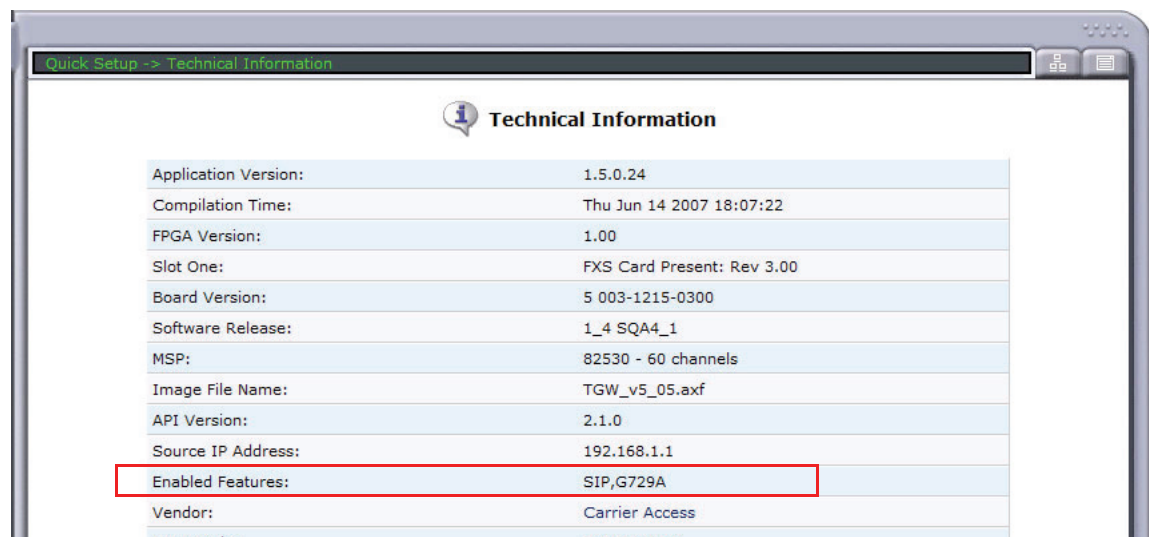

Quick Start Guide

Key Enabled Software Features

This information is also displayed with the following CLI command:

```
Adit 3500> show version

Application Version: 1.5.0
Compilation Time: Thu Jun 14 2007 18:07:22
FPGA Version: 1.00
Board Version: 5 003-1215-0300
IXP400 Software Release: 1_4 SQA4_1
MSP:
    82530 - 60 channels
    Image File Name: TGW_v5_05.axf
    API Version      : 2.1.0
    Source IP Addr  : 192.168.1.1
Voice Slot 1 : FXS Card Present: Rev  3.00
Vendor: Carrier Access
CLEI Code: IPMHX00LRA
Product Features:
    SIP enabled.
    G729A enabled.
```

Basic Configuration

The following configuration is divided into logical sections, where each section configures an additional function. The first must be configured before the second and so forth, however, you may stop at any section and not add the following feature.

NOTE: The order in which commands are entered can affect the successful provisioning of the Adit 3500.

- **Setup Adit 3500 for access via Web-Browser**
- **Restore Factory Defaults**
- **Modify Default Admin User**
- **Configure WAN Interface for Internet Connectivity**
- **Configure the Adit 3500 as a SIP Gateway**

Setup Adit 3500 for access via Web-Browser

The following steps will configure the Adit 3500 to allow access to the Web Browser for configuration, through the LAN (1) or WAN (2) 10/100Base-T Ethernet connections.

Note: for LAN access, no additional configuration is required to access the Adit using the web browser.

To configure the WAN access:

1. Connect to the CLI via the DB-9 RS-232. See *Setting up a CLI Connection* on page 24.
2. Enable the remote admin WAN access with the following command sequence:

Command	Description
<code>Username: admin</code> <code>Password: *****</code>	Log into the system (username and password).
<code>Adit 3500> enable</code> <code>Password: *****</code>	Enter the Privileged mode. Enter password for the Privileged mode.
<code>#configure terminal</code>	Enter the Configuration mode.
<code>(config)# remote-admin web</code> <code>primary-port enable</code>	Enable remote web admin.

Restore Factory Defaults

If the unit is not out-of-the-box, you may want to verify that the unit is set to defaults.

Note: this will reset the IP address back to the default setting of 192.168.1.1.

In the web-browser:

- Select **Advanced** from the Navigation bar
- Select **Restore Defaults**

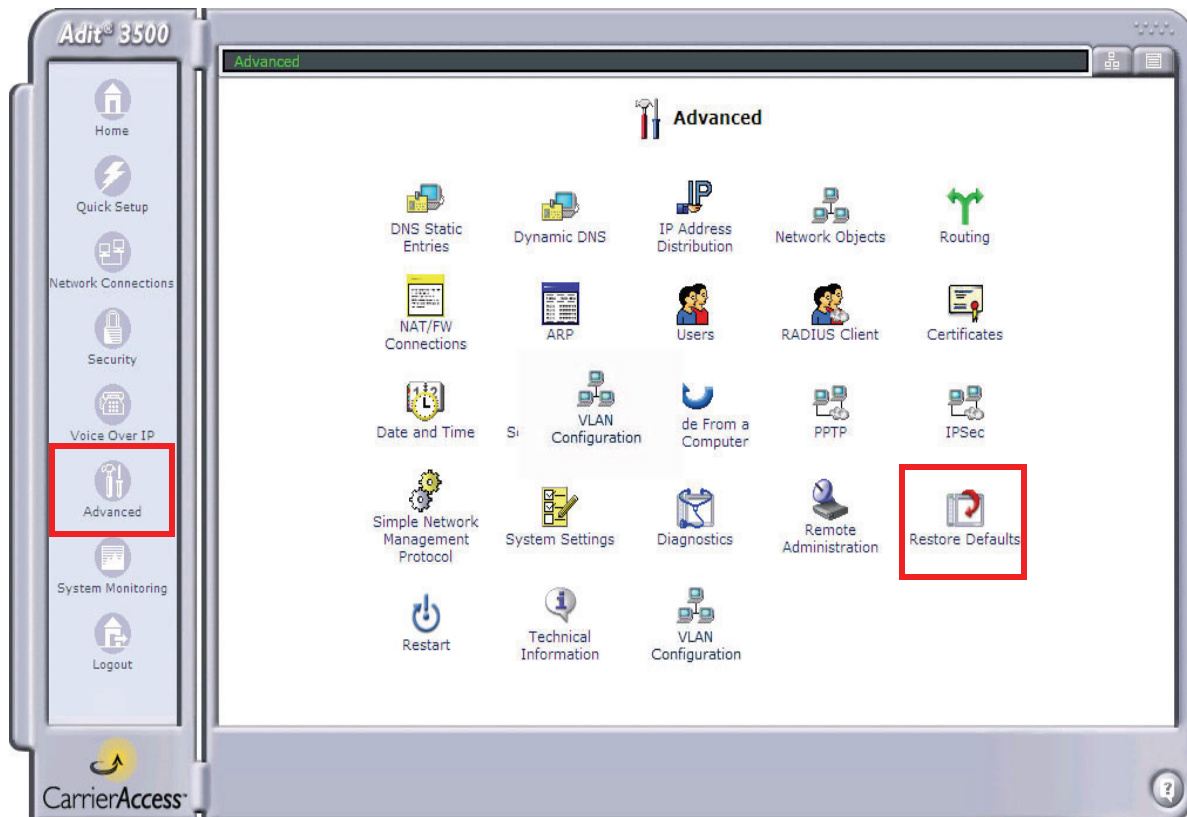

- Select **OK** to restore defaults

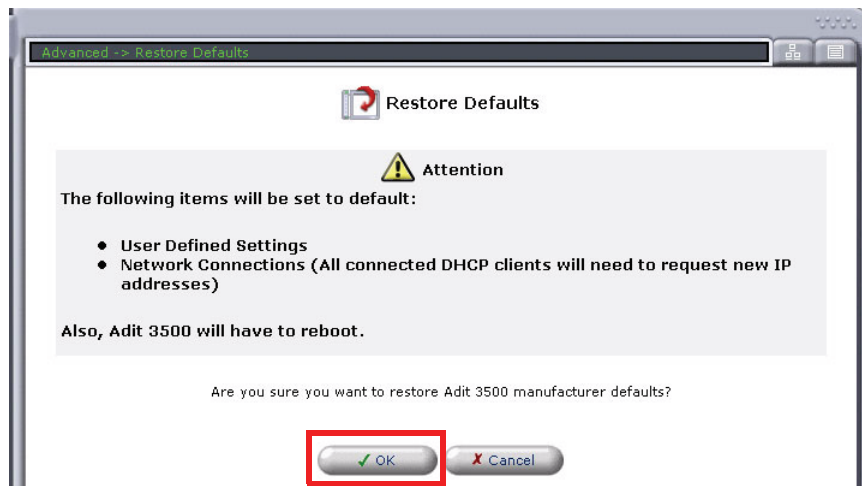

Modify Default Admin User

For security purposes it is recommended that the Administrator User be changed from the default settings.

Modify the Administrator User in the web-browser:

- Select **Advanced** from the Navigation bar
- Select **Users** icon

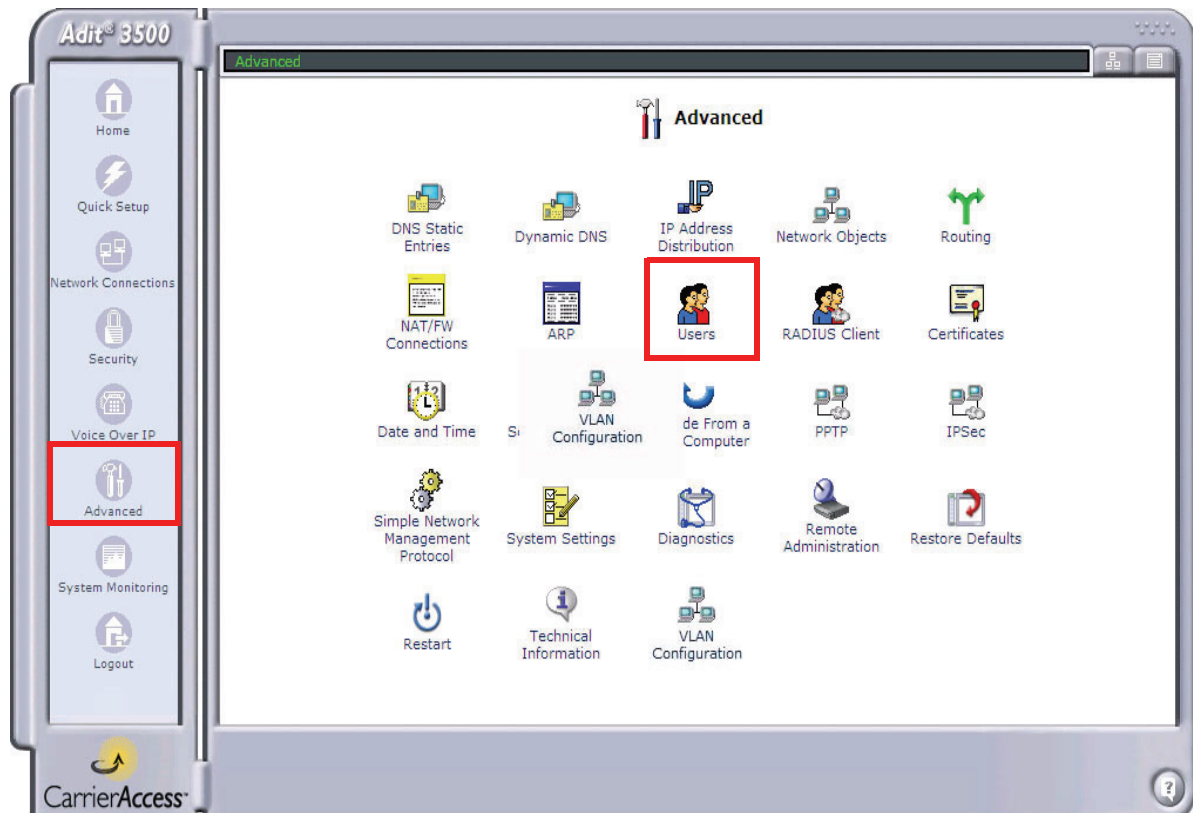

- Select **Administrator**, to open the profile.



- Modify the User information, and select **OK** to save. It is important to note that you need to have a minimum of one user with **Administrative Privileges**. For users with other access levels, use the **New User** to add additional users on the system.
Note: For security purposes, the password should be changed from the default setting.

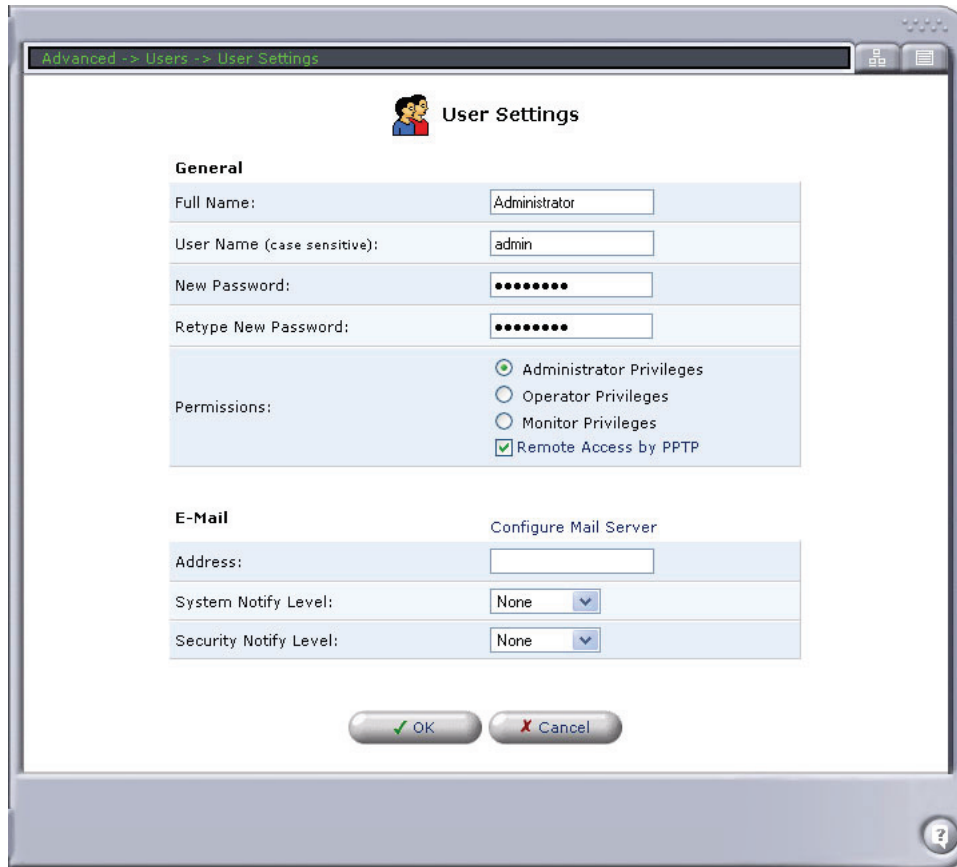

- You will be required to login again, if you have modified the User Profile that you are logged in with.

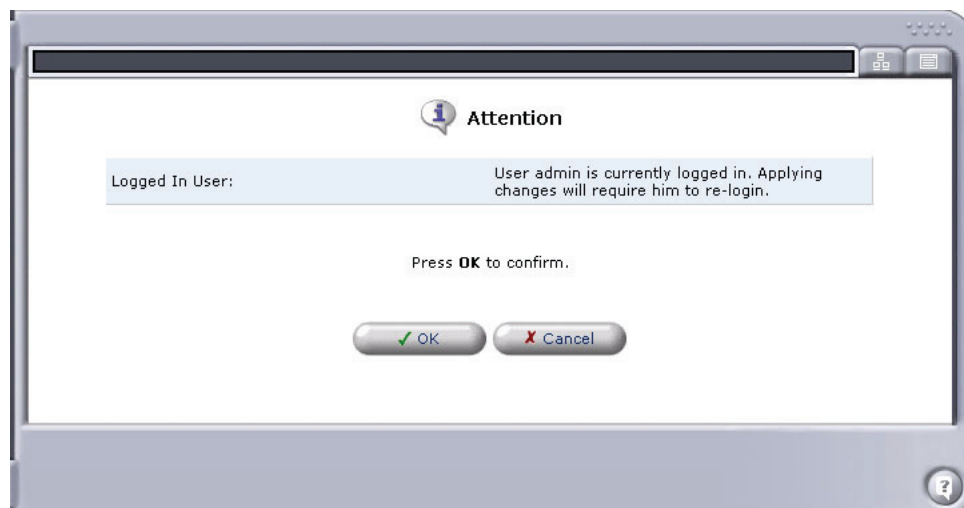

Configure WAN Interface for Internet Connectivity

There are options to this WAN configuration. This is the connection to the end user's internet provider. It can be the following:

- **Single T1 (PPP)**
- **Multiple T1s (Multilink)**
- **Ethernet WAN**

Single T1 (PPP)

To configure a single T1 utilizing PPP:

1. Select **Network Connections** from the Navigation bar.
2. Select (click) a **T1 Interface** (from T1 1 - T1 4) to configure, **T1 1** is recommended.
Note: Using **T1 1** and the preconfigured **Serial 1** makes this configuration very simple. If you use T1 2-T1 4, you will need to delete the preconfigured **Serial 1** and make a New Connection (Serial 1) based on the T1 2-T1 4 that you selected.

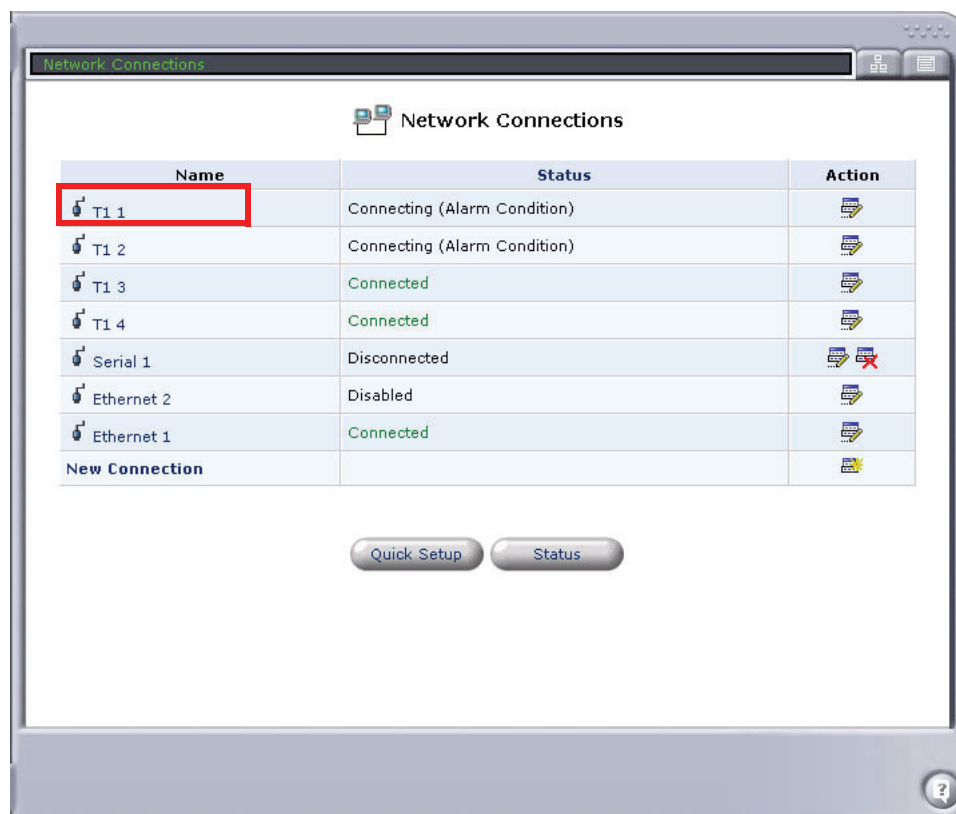

3. Select the **Settings** button.



4. Set the proper **Framing Type** and **Line Coding**.

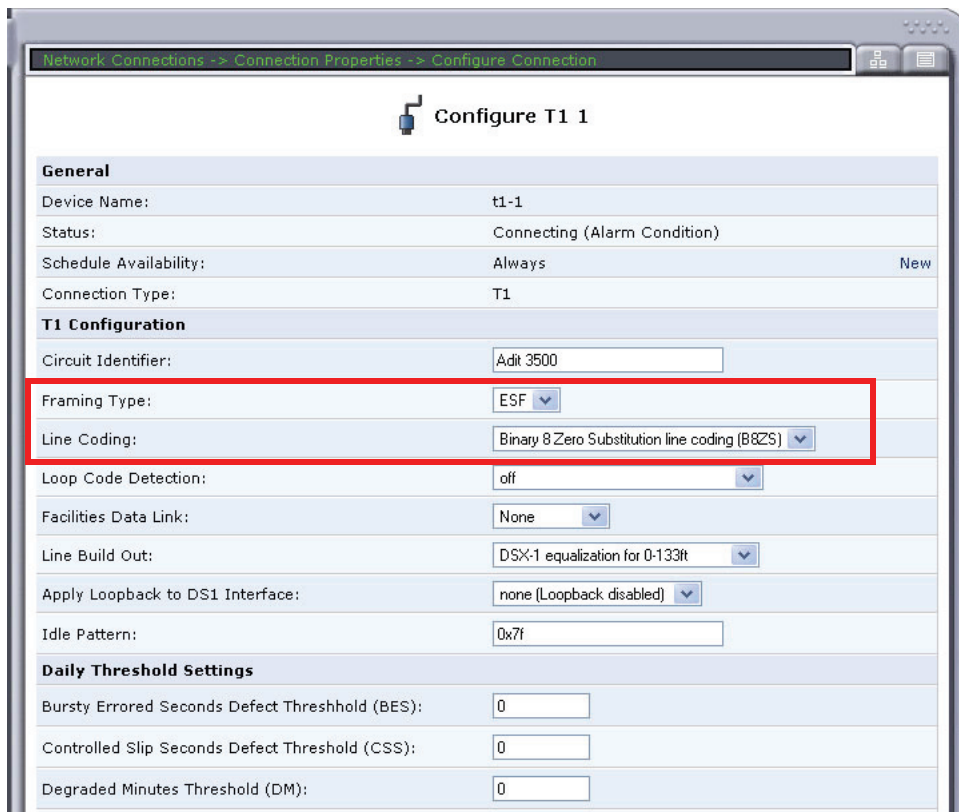

5. Select **OK** to apply the new settings and exit this window.
6. Select **OK** again to return to the **Network Connections** window.

7. Select (click) the **Serial 1** connection.



8. Select the **Settings** button.

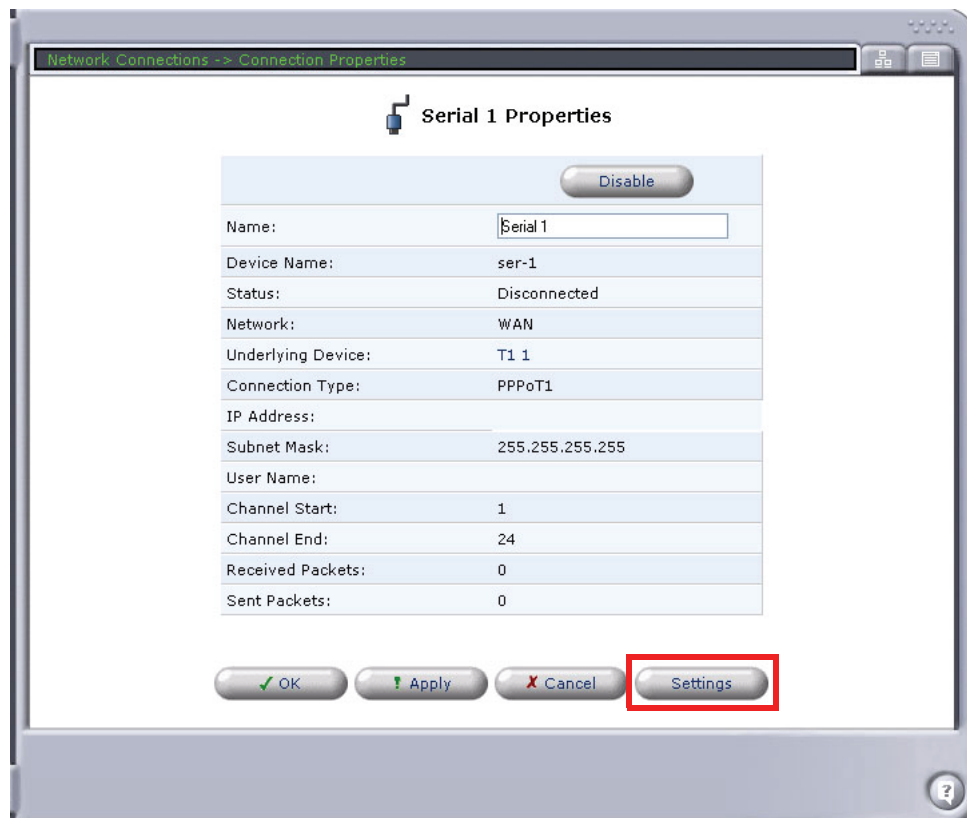

9. Set the following on the **Configure Serial 1** window:
 - **Network Type** to **WAN** (this is the default setting)
 - **PPP Authentication** to your required preferences

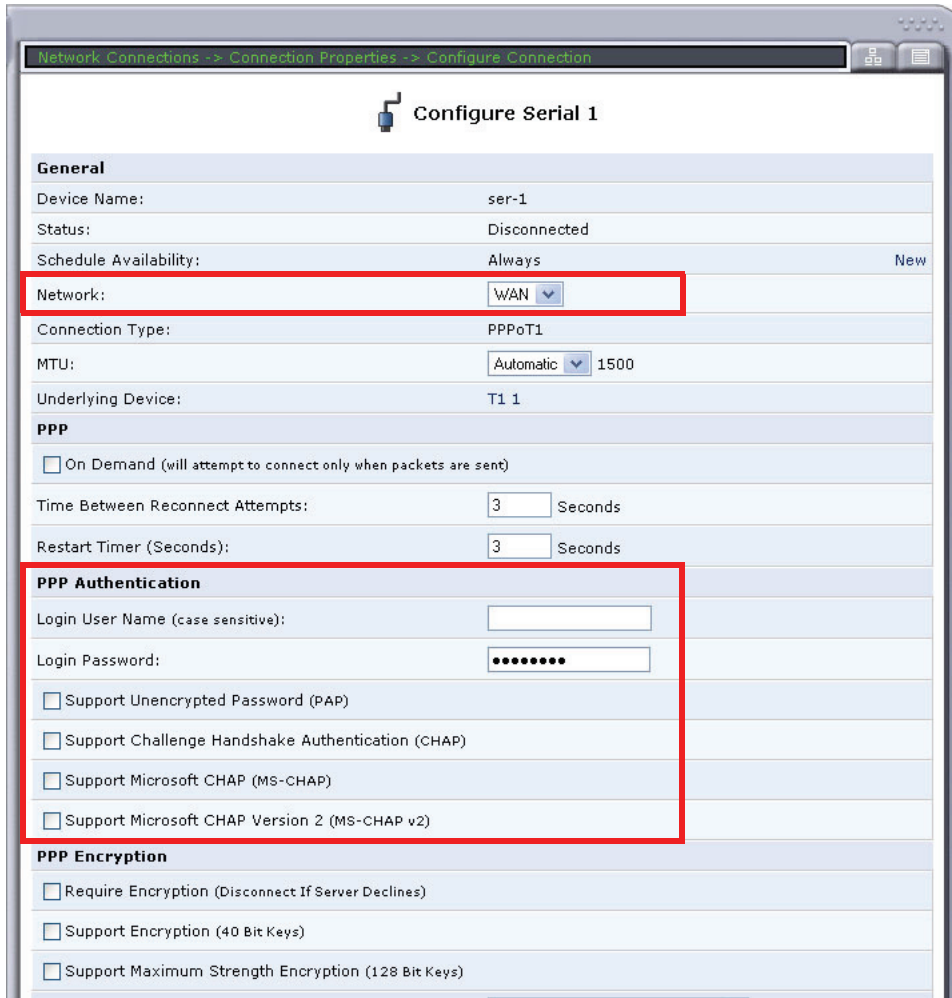

10. Select **OK** to apply the new settings and exit this window.
11. Select **OK** again to return to the **Network Connections** window.

Multiple T1s (Multilink)

To configure Multiple T1s utilizing Multilink PPP:

1. Select **Network Connections** from the Navigation bar.
2. Select (click) a **T1 Interface** (from T1 1 - T1 4) to configure.

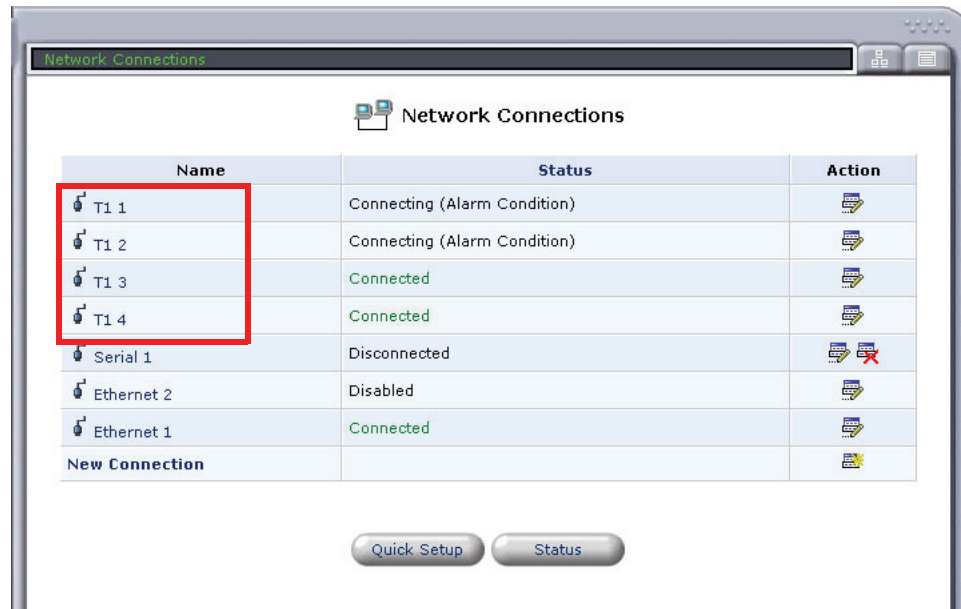

3. Select the **Settings** button.

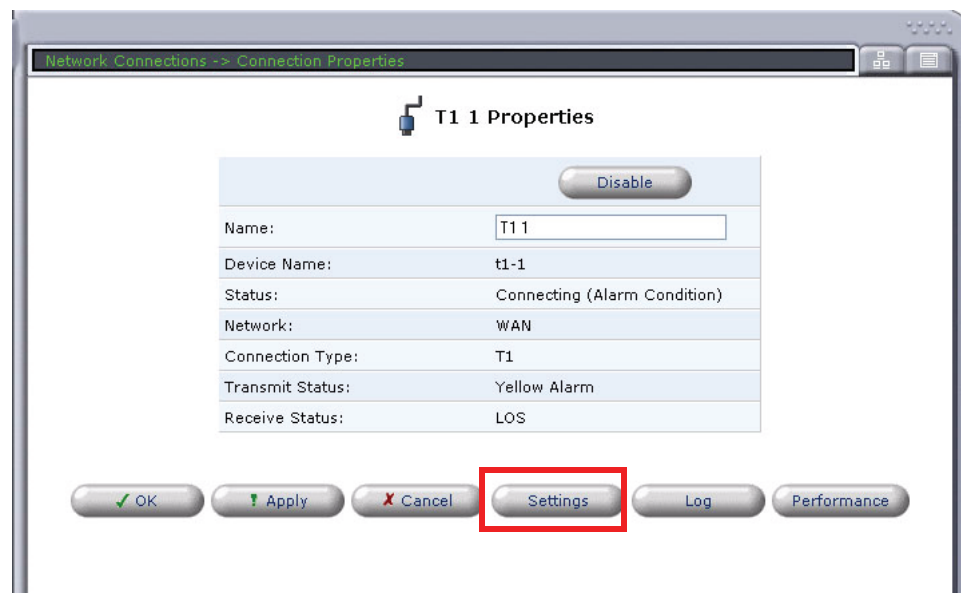

4. Set the proper **Framing Type** and **Line Coding**.

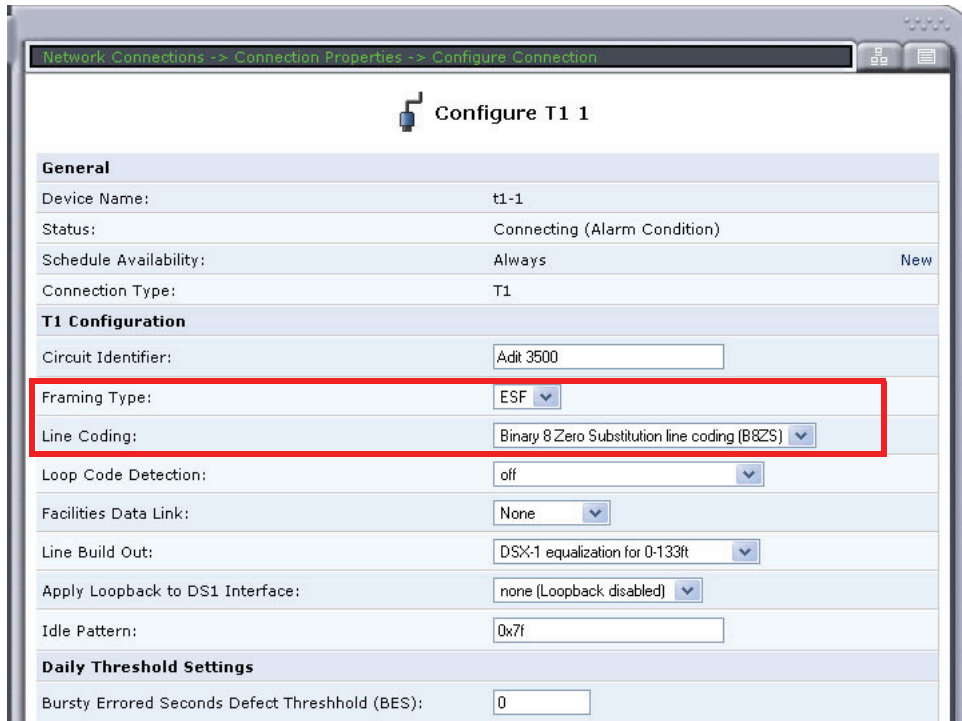

5. Select **OK** to apply the new settings and exit this window.
6. Select **OK** again to return to the **Network Connections** window.
7. Repeat steps #1-6 for additional T1s required for the ML-PPP
8. Select (click) the delete icon associated with the **Serial 1** connection. Select **OK** to confirm the deletion of this connection.

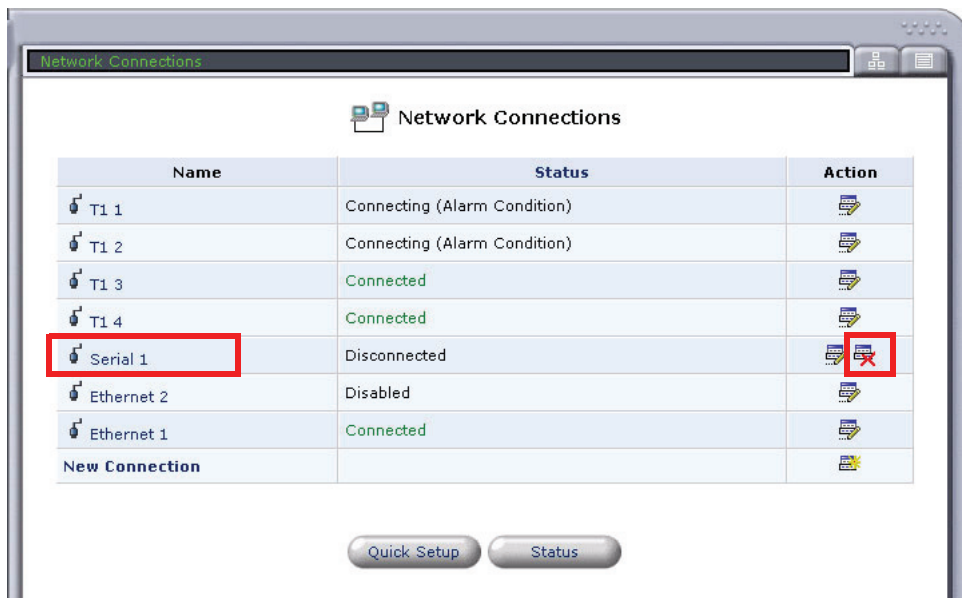

9. Select (click) **New Connection** to create the ML-PPP connection.

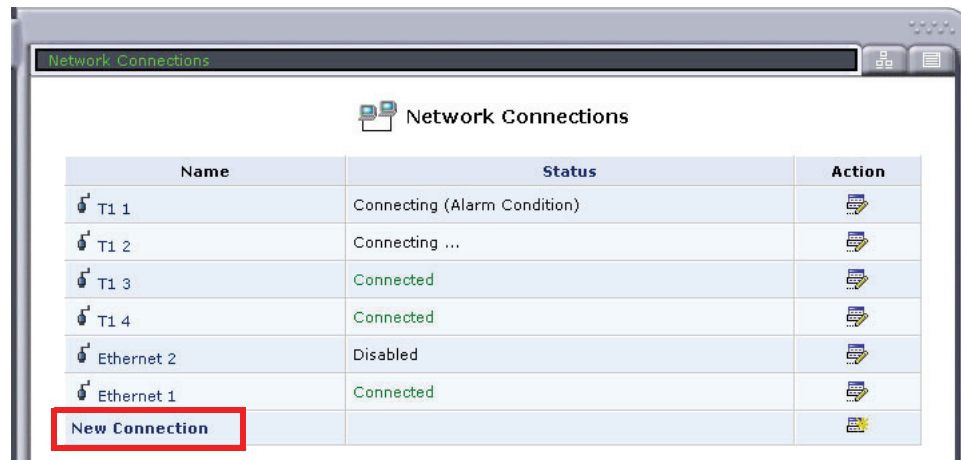

10. Select the **Multilink Point-to-Point Protocol over DS0 (Multilink)**, and select Next.

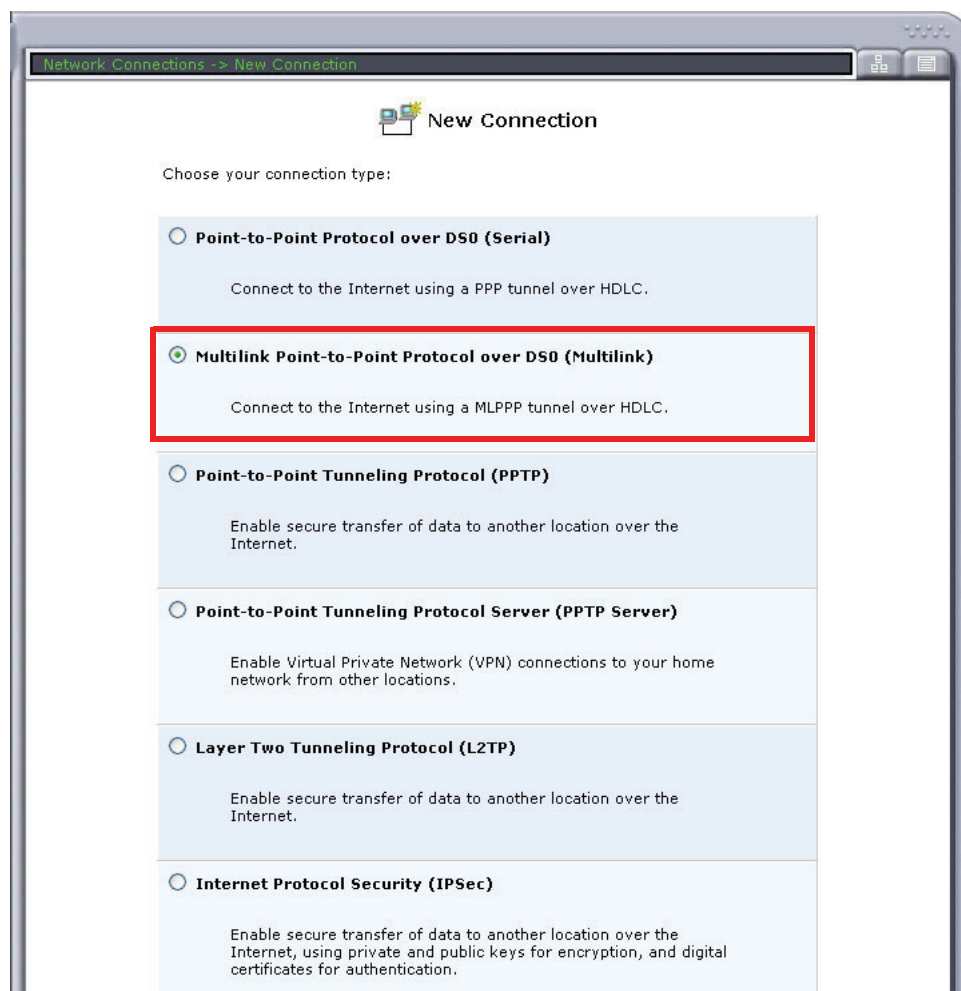

11. Enter **User Name** and **Password**.
12. Select the T1s for this Multilink and the channel ranges.
13. Select **Next**.

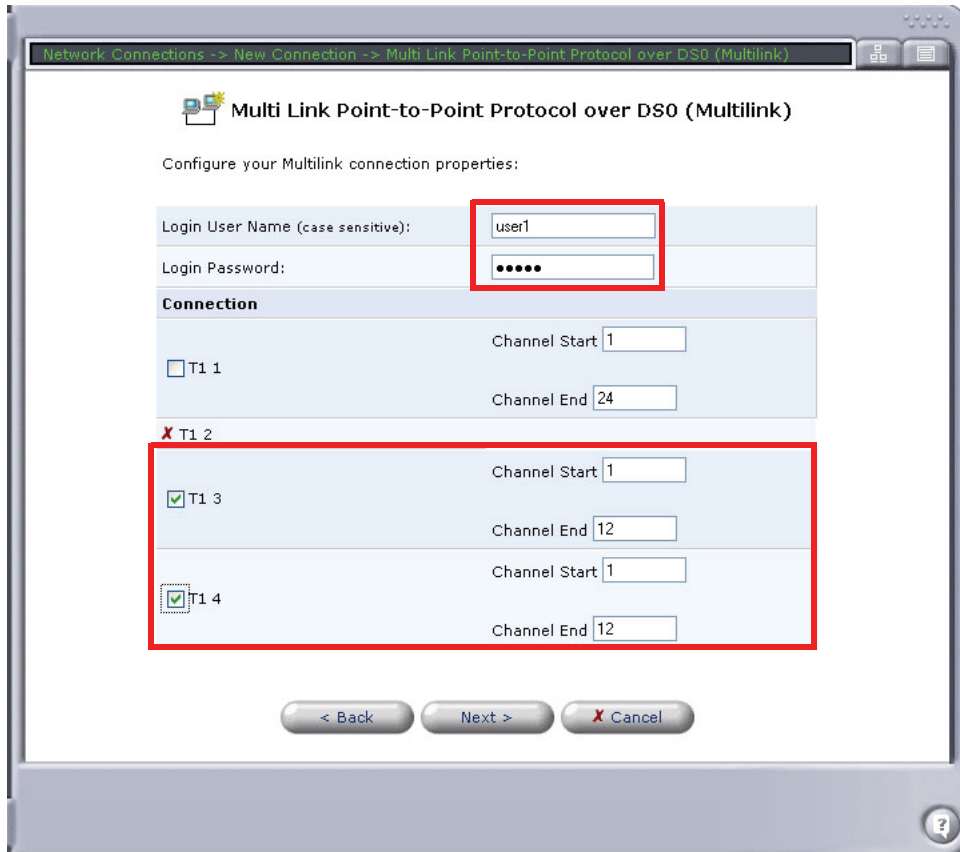

14. A summary of the Multilink connection will be displayed. If correct, select **Finish**.

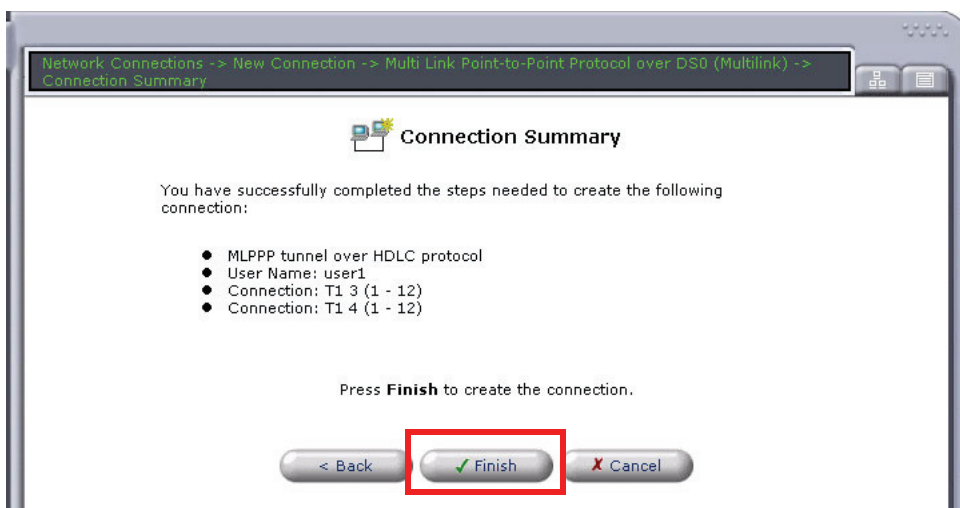

15. The new Multilink connection will display on the Network Connections window.
16. Select (click) the **Multilink 1** connection.

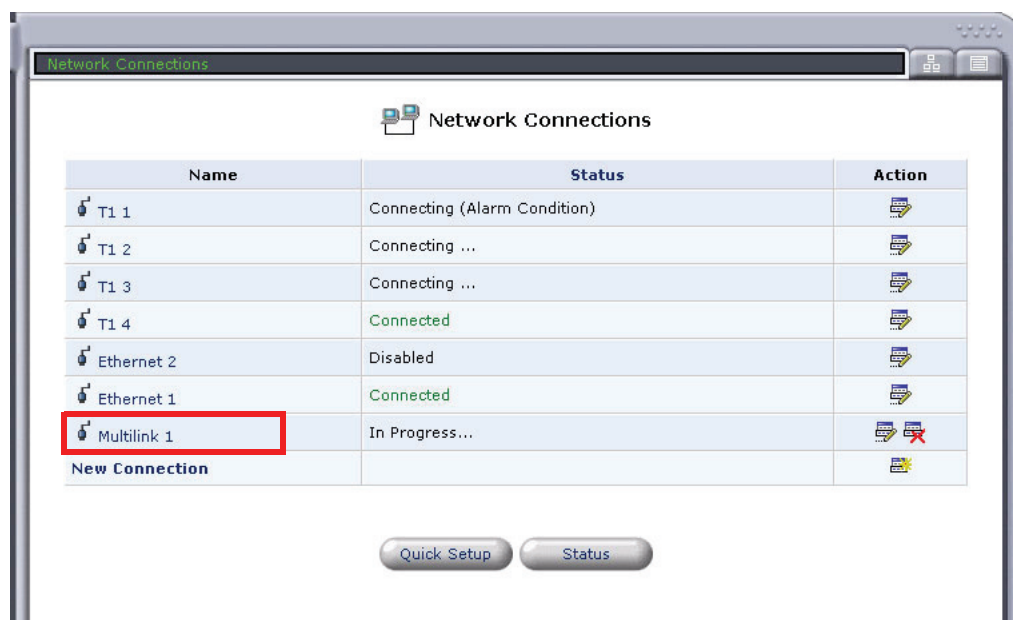

17. Select the **Settings** button.



18. Set the following on the **Configure Multilink 1** window:
- **Network Type** to **WAN** (this is the default setting)
 - **PPP Authentication** to your required preferences

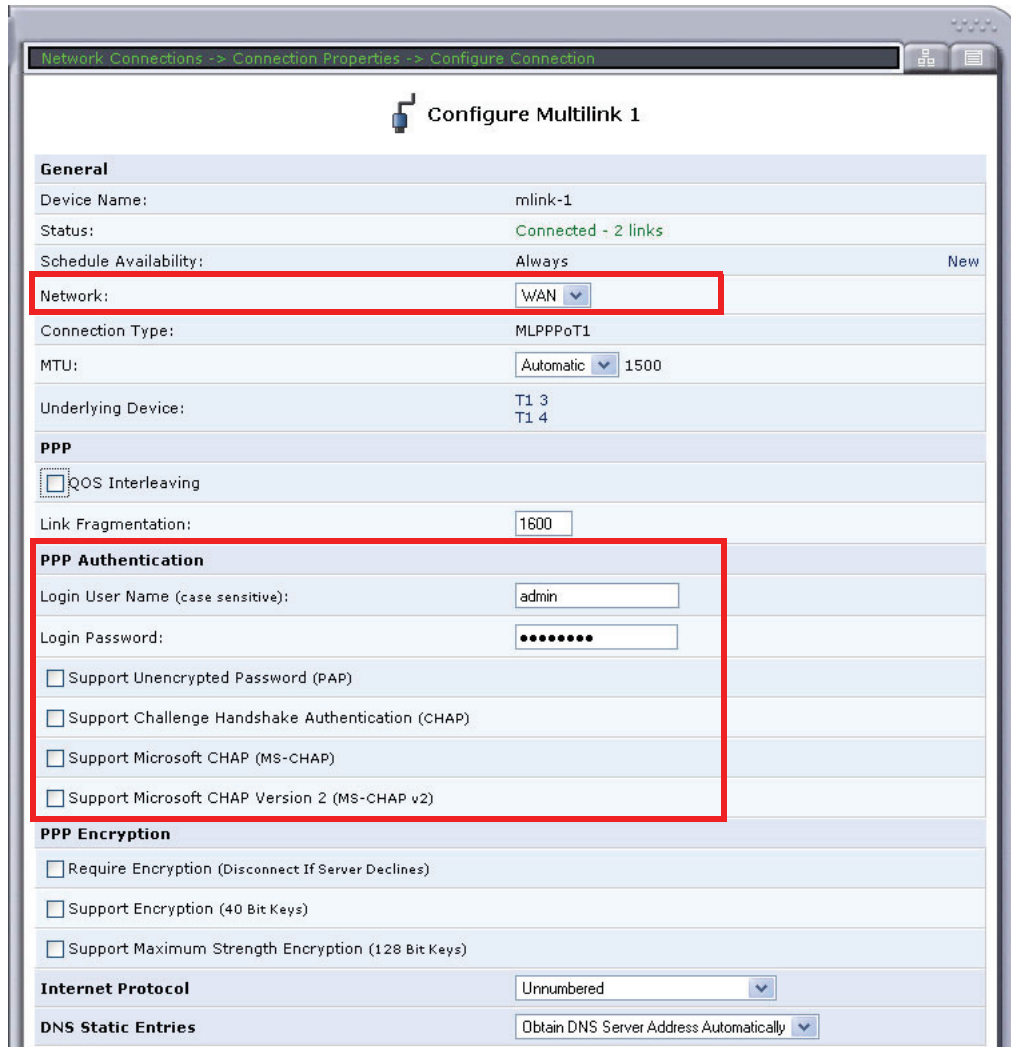

19. Select **OK** to apply the new settings and exit this window.
20. Select **OK** again to return to the **Network Connections** window.

Ethernet WAN

To configure the WAN utilizing Ethernet feed:

1. Select **Network Connections** from the Navigation bar.
2. Select (click) the delete icon associated with the **Serial 1** connection. Select **OK** to confirm the deletion of this connection.

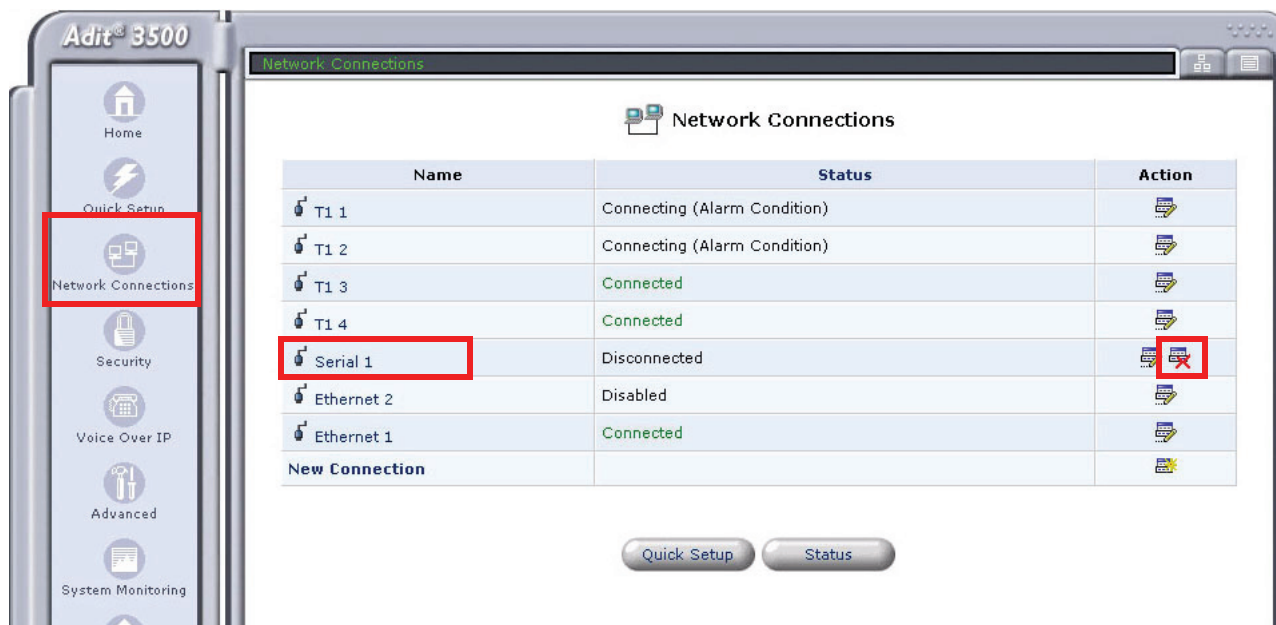

3. Select (click) the **Ethernet 2** (WAN Ethernet) connection to configure.



4. Select the **Enable** button, to configure the WAN Ethernet up (or in-service).
5. Select the **Settings** button.

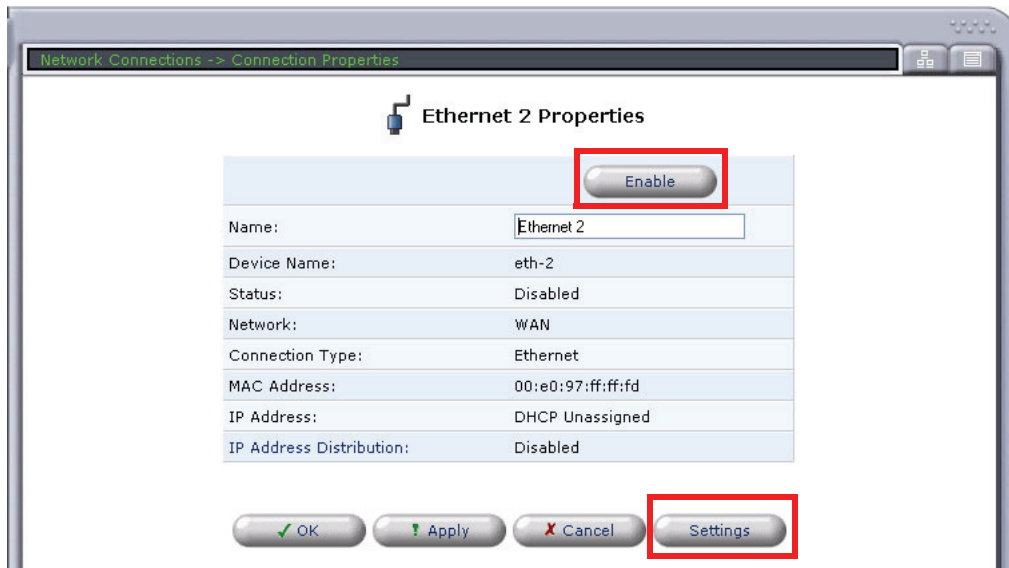

6. Set **Network** type to **WAN**.
7. Set **Internet Protocol** option (method of IP address assignment).

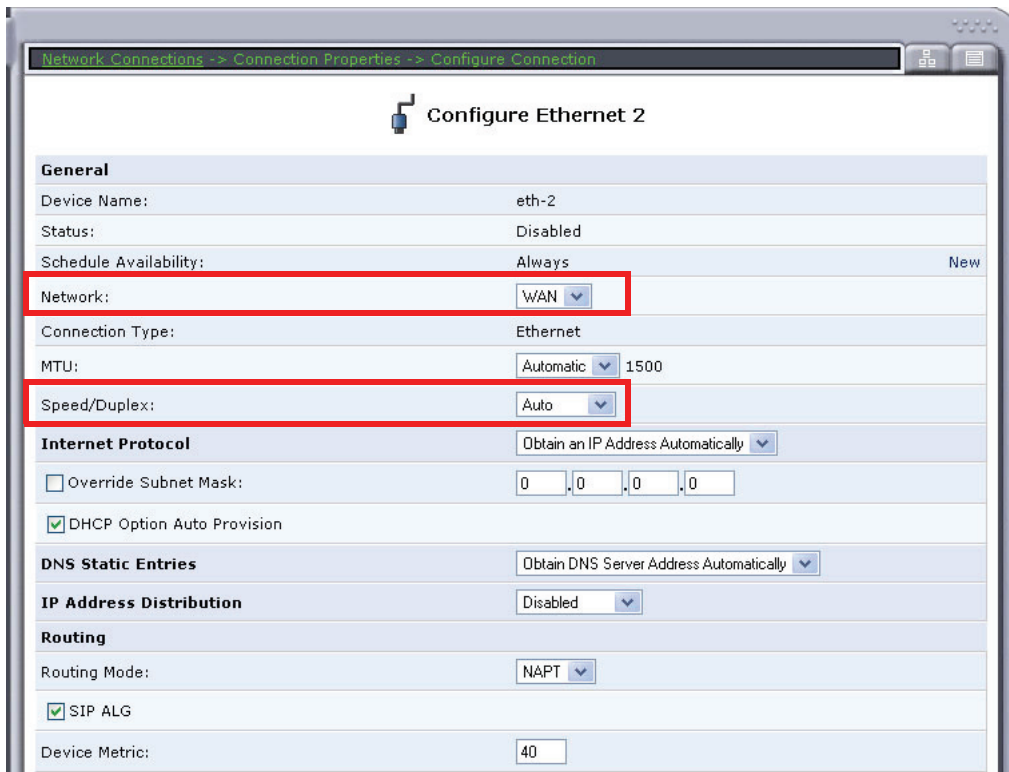

8. Select **OK** to apply the new settings and exit this window.
9. Select **OK** again to return to the **Network Connections** window.

Configure the Adit 3500 as a SIP Gateway

1. Select **Voice Over IP** from the Navigation bar.

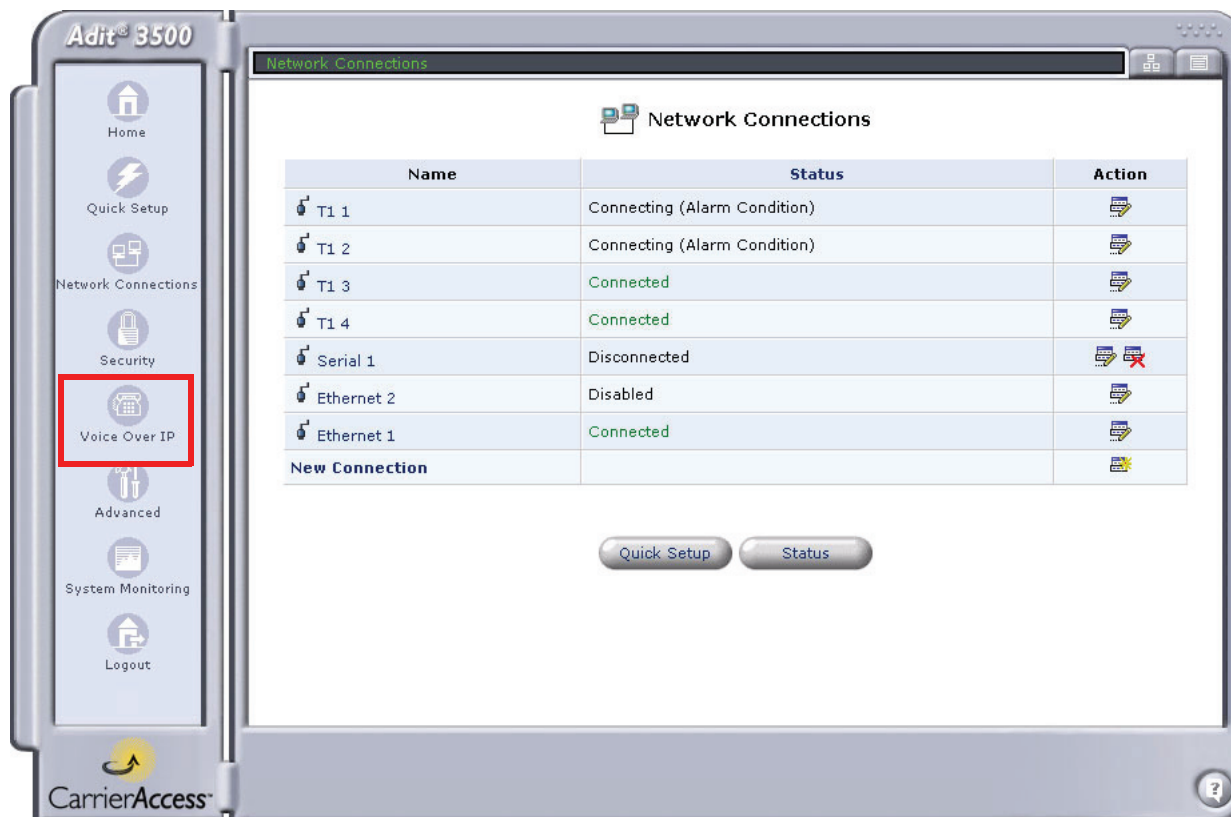

2. On the **IP Telephony** tab, under **Proxy Servers**:
 - Set **Proxy Type** to Generic/custom (BroadSoft or Sylanro). Example: **BroadSoft**
 - Select **Use SIP Proxy** and enter **SIP Proxy IP address**
 - Select supported **Codecs**

The screenshot shows the 'Voice Over IP' configuration window. The 'IP Telephony' tab is selected and highlighted with a red box. Below the tabs, the 'Proxy Servers' section is also highlighted with a red box. This section includes the following settings:

- Proxy Type:** BroadSoft 11.1 Info Mode (dropdown)
- Route Direct Phone Entries in Phonebook Through Proxy
- Enabled/Disable:** IP/DNS Address
- Use SIP Proxy: 192.168.100.100 (text input)
- Port:** 5060 (text input)
- Use SIP Outbound Proxy: 0.0.0.0 (text input)
- Port:** 5060 (text input)
- Codecs:** Packetization Time
- G.711, 64kbps, u-Law: 20 (dropdown)
- G.711, 64kbps, A-Law: 20 (dropdown)
- G.729A, 8kbps: 20 (dropdown)

At the bottom of the window, the 'Advanced >>' button is highlighted with a red box.

3. Select **Apply** to save the new settings.
4. Select the **Advanced** button.

5. Modify any advanced VoIP settings as needed and select **Apply**.

Advanced VoIP Configuration

SIP Interop

Calling Feature Mode: Local

Privacy Mode: None

Enable PRACK: Enabled

SIP Early Media

Early Media: Auto

SIP Session Timer

Mode: Disabled

Refresher: UAC

Timeout: 1800

IP Packet Priority

SIP TOS: 0xdc (HEX)

RTP TOS: 0xb8 (HEX)

FXS Signaling

Calling Party Disconnect (CPD) Duration: 900

Features

Sylantro Centralized Conferencing: Enabled

Registration

Number of Registrations Per Minute (1-300, 0=disabled): 60

Registration Expires Timeout (30-86400 sec): 3600

Registration Window Size (1-304): 10

Retry Timeout (SIP T1) (200-5000 ms): 500

Tries Per Cycle (1-10): 2

Failed Registration Timer (30-86400 sec): 60

T.38 Fax-Relay

T.38 Signaling: NSE preferred

T.38 Error Correction Scheme: Redundancy

T.38 Redundancy

Ls Redundancy (0-8): 3

Hs Redundancy (0-3): 0

OK Apply Cancel

6. Select **OK** to exit window.

7. If using the FXS ports, select the **Phone Settings** tab.
8. Select the **Action** icon on line #1 to edit.



9. Enter the Phone Number in the **User ID** field.
10. Enter **Authentication** information as needed.
11. Select **OK** to apply and exit this window.
12. Select **OK** to acknowledge that with these changes, active calls will be dropped.
13. **Repeat this step for each FXS Line.**

The screenshot shows the 'Line Settings' configuration window for Voice Over IP. The window is titled 'Line Settings' and contains several sections:

- Identification**
 - Begin Line Number: 1
 - End Line Number: 1
 - User ID: 000000001 (highlighted with a red box)
 - Description: Line 1
- Packet Processing**
 - Codec Pref1: G.711u
 - Codec Pref2: G.711A
 - Codec Pref3: G.729A
 - Fax Mode: None
 - Modem/SuperG3 Fax Mode: None
 - Silence Suppression: Enabled
 - Jitter Buffer: Static
- Voice Processing**
 - Transmit Gain (-12 though +6): 0
 - Receive Gain (-12 through +6): 0
 - Impedance: USA : 900 Ohms + 2.16uF
 - Echo Cancellation: Enabled
- Signaling**
 - Protocol: LoopStart
 - Calling Party Disconnect (CPD): Enabled
- Calling Features**
 - Call Waiting: Enabled
 - Call Waiting Caller ID: Enabled
 - Block Outgoing Caller ID: Enabled
- Authentication** (highlighted with a red box)
 - Authentication: Enabled
 - Authentication User ID: 000000001
 - Authentication Password: ••••••••
- Logging**
 - Per Line Logging: Enabled
- Notes:**
 - Not affected when line ranges used: User ID, Description, Authen. User ID and Authen. Password

14. The current User ID of the FXS lines will display.

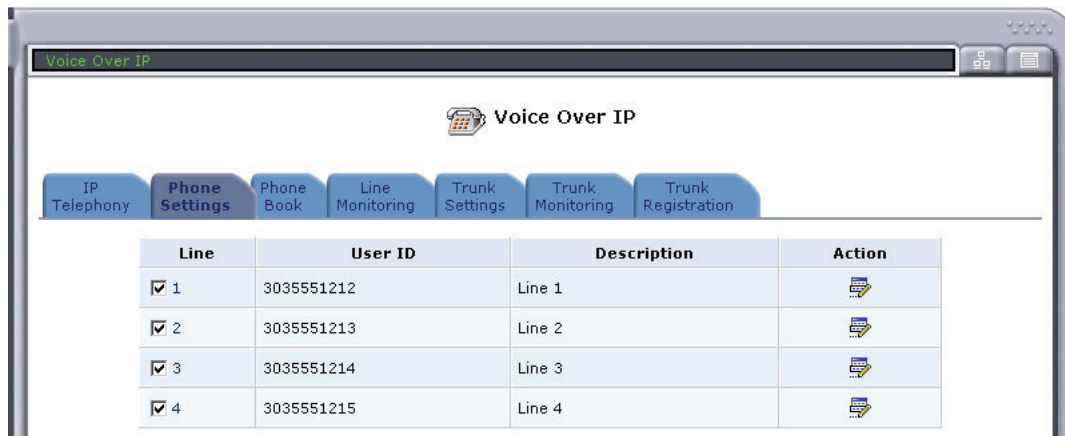

15. Select the **Line Monitoring** tab. This window displays the SIP status of the FXS ports.
Note: When a telephone port is successfully registered the Registration Status column displays "Registered" in green."



16. Select the **Trunk Settings** tab.



17. Select (click) on the trunk to configure.

18. Set the **Trunk Signaling** type to PRI or CAS.

19. Set the **Signaling Type**.
20. Select **New Entry** to assign numbers to your PRI interface(s).

Trunk Settings

General

Connection: T1 1
 T1 2
 T1 3
 T1 4

Interface Type: Network

Trunk Signaling: PRI

Signaling Type: PRI-n2

PCM Coding: u-law

Terminal Endpoint Identifier: 0

Identification

Trunk ID: 000000005

Description: Trunk 1

Packet Processing

Codec Pref1: G.711u

Codec Pref2: G.711A

Codec Pref3: G.729A

Fax Mode: None

Modem/SuperG3 Fax Mode: None

Silence Suppression: Enabled

Jitter Buffer: Static

Voice Processing

Transmit Gain (-12 through +6): 0

Receive Gain (-12 through +6): 0

Echo Cancellation: Enabled

Authentication

Authentication: Enabled

Authentication User ID:

Authentication Password:

Digit Map

Per Trunk Digit Map: Disabled

Destination	Strip	Prefix	Action
New Entry			

OK Apply Cancel

Quick Start Guide

Basic Configuration

21. Enter the **phone number range** for numbers to be routed to the trunk interface for incoming SIP calls, on the Call Destination window. Use Strip and Prefix entries to translate the incoming destination number from SIP to the destination number to be sent to the PRI/CAS interface.

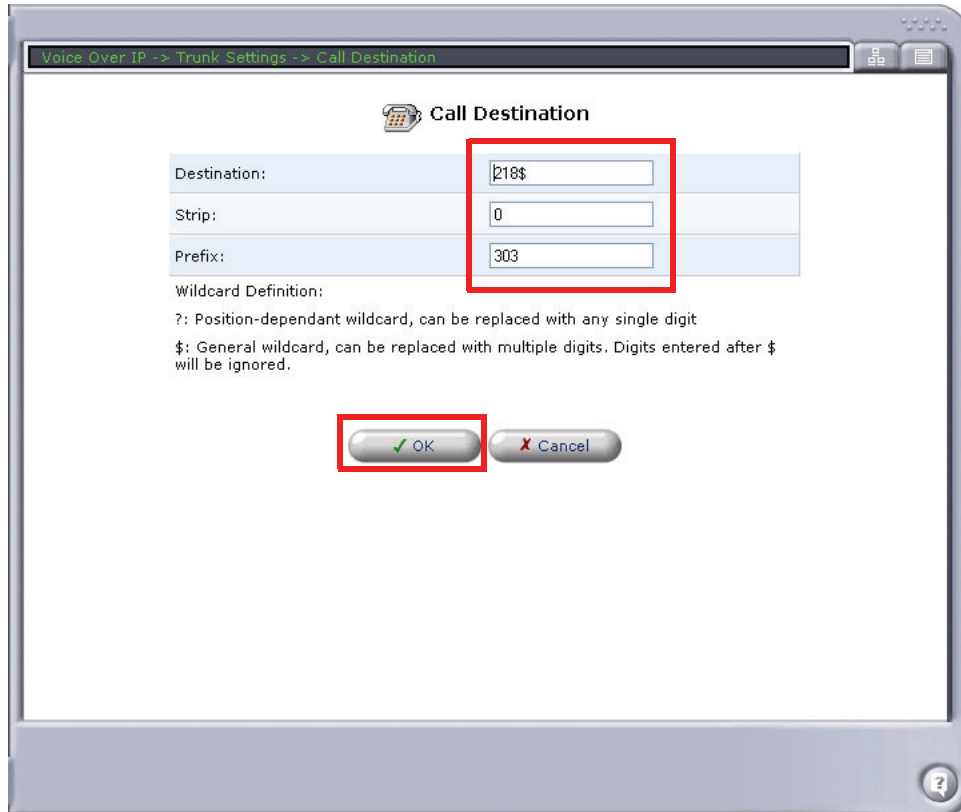

Voice Over IP -> Trunk Settings -> Call Destination

Call Destination

Destination:

Strip:

Prefix:

Wildcard Definition:
?: Position-dependant wildcard, can be replaced with any single digit
\$: General wildcard, can be replaced with multiple digits. Digits entered after \$ will be ignored.

22. Select **OK** to save and exit this window.
Note: this information will display at the bottom of the **Trunk Settings** window.

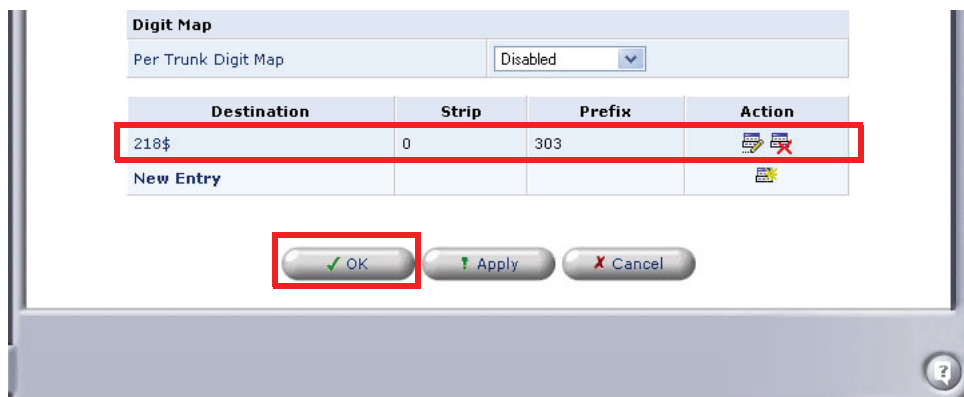

Digit Map

Per Trunk Digit Map

Destination	Strip	Prefix	Action
218\$	0	303	
New Entry			

23. Select **OK** again to return to the Voice Over IP window.

24. Select the **Trunk Monitoring** tab to view the status of any calls on the PRI.

The screenshot shows the 'Voice Over IP' configuration window. The 'Trunk Monitoring' tab is highlighted with a red box. Below the navigation tabs, there are summary statistics and a detailed table of channel statuses.

DS1#2	LapdStatus	Sabme	Fmr
0	Inactive	0	0

TotalIncomingCalls	CompletedIncomingCalls	TotalOutgoingCalls	CompletedOutgoingCalls
0	0	0	0

* Channel	Channel Status	RTP RX/TX/Lost (Packets)	Jitter (ms)	Overflow
✓ T1 2_1	inactive			
✓ T1 2_2	inactive			
✓ T1 2_3	inactive			
✓ T1 2_4	inactive			
✓ T1 2_5	inactive			
✓ T1 2_6	inactive			
✓ T1 2_7	inactive			
✓ T1 2_8	inactive			
✓ T1 2_9	inactive			
✓ T1 2_10	inactive			
✓ T1 2_11	inactive			
✓ T1 2_12	inactive			
✓ T1 2_13	inactive			
✓ T1 2_14	inactive			
✓ T1 2_15	inactive			
✓ T1 2_16	inactive			
✓ T1 2_17	inactive			
✓ T1 2_18	inactive			
✓ T1 2_19	inactive			
✓ T1 2_20	inactive			
✓ T1 2_21	inactive			
✓ T1 2_22	inactive			
✓ T1 2_23	inactive			

Refresh

Quick Start Guide

Basic Configuration

Free Manuals Download Website

<http://myh66.com>

<http://usermanuals.us>

<http://www.somanuals.com>

<http://www.4manuals.cc>

<http://www.manual-lib.com>

<http://www.404manual.com>

<http://www.luxmanual.com>

<http://aubethermostatmanual.com>

Golf course search by state

<http://golfingnear.com>

Email search by domain

<http://emailbydomain.com>

Auto manuals search

<http://auto.somanuals.com>

TV manuals search

<http://tv.somanuals.com>