

## Contents

Introduction .....	3
Before connecting.....	3
Limited warranty .....	4
Safety precautions .....	4
Important safety instructions .....	5
Front panel controls .....	6
Rear panel connections.....	7
Remote control.....	8
Front panel display.....	9
Loudspeaker connections .....	9
Analog audio connections .....	10
Digital audio connections .....	10
Video connections .....	11
HDMI connections .....	11
5.1/6.1/7.1 Direct In .....	12
7.1 Preamp Out .....	12
Aerial connections .....	13
Front Input connections .....	13
<b>640R setup .....</b>	<b>14</b>
1. Speaker configuration .....	14
2. Speaker delay.....	15
3. Level calibration.....	16
4. Source setup .....	16
5. Assigning HDMI .....	17
Surround Sound modes .....	18
Operating instructions .....	19
Decode modes.....	20-22
Audio split mode .....	24
Recorder 1/2.....	24
Tone/Sub/LFE configuration.....	24
Input naming .....	24
OSD setup .....	25
Multi-Room connections .....	26
Custom installation use.....	27
Reset/Back-up memory.....	27
Troubleshooting .....	27
Technical Specifications .....	28

## Introduction

**Thank you for purchasing this Cambridge Audio Azur range AV receiver. The 640R is designed for excellent multi-channel surround-sound performance without compromising on music reproduction.**

As such, the seven 100W audiophile grade fully discrete amplifiers are kept as separate as possible from the processing and input stages and feature a large power supply with a low flux toroidal transformer. This careful design of the amplifier stages ensure that the 640R can reproduce the dynamics and scale required for modern movie soundtracks whilst also being able to reproduce a genuinely musical performance with either stereo or multi-channel music sources.

A full range of digital and analog inputs are fitted. Digital inputs allow for the connection of suitably equipped DVD players, satellite/set-top boxes and games consoles for decoding into stereo, stereo + sub or various digital surround formats. The latest formats are supported including Dolby Digital and DTS in 5.1, 6.1 or 7.1 variants. The 640R is also capable of decoding encoded analog or digital stereo sources in Dolby Pro Logic® II or IIx and DTS Neo:6, again in 5.1, 6.1 or 7.1 variants for a convincing and effective surround experience from a matrix encoded stereo source. Sophisticated post-processing of 5.1 or 6.1 digital material is also possible with PLIIx or DTS Neo:6 to turn these formats into 6.1 or 7.1.

Conventional analog stereo inputs allow the connection of audiophile CD players and the like, and an Analog Stereo Direct mode ensures the very best possible stereo reproduction for these.

The 640R also carries a 5.1 / 6.1 / 7.1 channel analog input. This feature allows for the connection of a DVD Audio or SACD player equipped with a 5.1 output and is compatible with future external 6.1/7.1 audio formats.

As well as the full complement of audio inputs, the 640R also performs Composite, S-Video and Component Video input switching and transcoding. The component video inputs and outputs are progressive scan and HDTV compatible and the unit features full On-Screen Display (OSD) on all analog video outputs. Transcoding allows composite video and/or S-Video to be converted to Component video for a simpler interface to the TV/Monitor.

In addition HDMI switching allows the very latest DVD players and Set-top boxes to be routed through the 640R to the TV/Monitor allowing direct digital transfer of high definition video for the very best picture quality.

Multi-Room compatibility is featured in the form of A-BUS Ready™/Incognito Ready™ outputs for either Cambridge Audio Incognito keypads (and power supply) or other manufacturers products compatible with the A-BUS standard. This allows a 2 or 3 zone multi-room system to be easily constructed, second and third zone video outputs mean the remote rooms can even have video capability.

An RS232 port, IR Emitter In and Control Bus In/Out also make it easy to integrate the 640R into a Custom Install situation.

All this proprietary engineering is housed within our low resonance, acoustically damped chassis. An Azur Navigator remote control is also provided, giving full remote control of your AV receiver in an attractive and easy to use handset.

Remember your 640R can only be as good as the system it is connected to. Please do not compromise on your source equipment, speaker package or video and audio cabling. Naturally we particularly recommend DVD/CD players or other source equipment from the Cambridge Audio Azur range, which have been designed to the same exacting standards as our receivers. Your dealer can also supply excellent quality Cambridge Audio interconnects to ensure your system realises its full potential.

Thanks for taking the time to read this manual, we do recommend you keep it for future reference.



Matthew Bramble  
Technical Director

## Before connecting

The process of setting up the 640R is first to make all the connections to your speakers and source equipment and then set the unit up via its On-Screen Display (OSD), as there are various settings and adjustments that need to be made before the 640R can be used.

**However before you actually decide which connections to make or perform any adjustments it is strongly advised that you read through the '640R setup' section of this manual first, starting on page 14.**

A lot of explanation is included that will help you to choose the right connection types for both your sources and TV.

## Limited warranty

Cambridge Audio warrants this product to be free from defects in materials and workmanship (subject to the terms set forth below). Cambridge Audio will repair or replace (at Cambridge Audio's option) this product or any defective parts in this product. Warranty periods may vary from country to country. If in doubt consult your dealer and ensure that you retain proof of purchase.

To obtain warranty service, please contact the Cambridge Audio authorised dealer from which you purchased this product. If your dealer is not equipped to perform the repair of your Cambridge Audio product, it can be returned by your dealer to Cambridge Audio or an authorised Cambridge Audio service agent. You will need to ship this product in either its original packaging or packaging affording an equal degree of protection.

Proof of purchase in the form of a bill of sale or receipted invoice, which is evidence that this product is within the warranty period, must be presented to obtain warranty service.

This Warranty is invalid if (a) the factory-applied serial number has been altered or removed from this product or (b) this product was not purchased from a Cambridge Audio authorised dealer. You may call Cambridge Audio or your local country Cambridge Audio distributor to confirm that you have an unaltered serial number and/or you purchased from a Cambridge Audio authorised dealer.

This Warranty does not cover cosmetic damage or damage due to acts of God, accident, misuse, abuse, negligence, commercial use, or modification of, or to any part of, the product. This Warranty does not cover damage due to improper operation, maintenance or installation, or attempted repair by anyone other than Cambridge Audio or a Cambridge Audio dealer, or authorised service agent which is authorised to do Cambridge Audio warranty work. Any unauthorised repairs will void this Warranty. This Warranty does not cover products sold AS IS or WITH ALL FAULTS.

REPAIRS OR REPLACEMENTS AS PROVIDED UNDER THIS WARRANTY ARE THE EXCLUSIVE REMEDY OF THE CONSUMER. CAMBRIDGE AUDIO SHALL NOT BE LIABLE FOR ANY INCIDENTAL OR CONSEQUENTIAL DAMAGES FOR BREACH OF ANY EXPRESS OR IMPLIED WARRANTY IN THIS PRODUCT. EXCEPT TO THE EXTENT PROHIBITED BY LAW, THIS WARRANTY IS EXCLUSIVE AND IN LIEU OF ALL OTHER EXPRESS AND IMPLIED WARRANTIES WHATSOEVER INCLUDING, BUT NOT LIMITED TO, THE WARRANTY OF MERCHANTABILITY AND FITNESS FOR A PRACTICAL PURPOSE.

Some countries and US states do not allow the exclusion or limitation of incidental or consequential damages or implied warranties so the above exclusions may not apply to you. This Warranty gives you specific legal rights, and you may have other statutory rights, which vary from state to state or country to country.

### Plug Fitting Instructions (UK Only)

The cord supplied with this appliance is factory fitted with a UK mains plug fitted with a 5 amp fuse inside. If it is necessary to change the fuse, it is important that a 5 amp one is used. If the plug needs to be changed because it is not suitable for your socket, or becomes damaged, it should be cut off and an appropriate plug fitted following the wiring instructions below. The plug must then be disposed of safely, as insertion into a mains socket is likely to cause an electrical hazard. Should it be necessary to fit a 3-pin BS mains plug to the power cord the wires should be fitted as shown in this diagram. The colours of the wires in the mains lead of this appliance may not correspond with the coloured markings identifying the terminals in your plug. Connect them as follows:

The wire which is coloured BLUE must be connected to the terminal which is marked with the letter 'N' or coloured BLACK.

The wire which is coloured BROWN must be connected to the terminal which is marked with the letter 'L' or coloured RED.

The wire which is coloured GREEN/YELLOW must be connected to the terminal which is marked with the letter 'E' or coloured GREEN.

If your model does not have an earth wire, then disregard this instruction.

If a standard 13 amp (BS 1363) plug is used, a 5 amp fuse must be fitted, or if any other type of plug is used a 5 amp fuse must be fitted, either in the plug or adaptor, or on the distribution board.

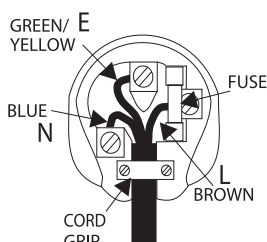

## Safety precautions

### Checking the Power Supply Rating

For your own safety please read the following instructions carefully before attempting to connect this unit to the mains.

Check that the rear of your unit indicates the correct supply voltage. If your mains supply voltage is different, consult your dealer.

This unit is designed to operate only on the supply voltage and type that is indicated on the rear panel of the unit. Connecting to other power sources may damage the unit.

This equipment must be switched off when not in use and must not be used unless correctly earthed. To reduce the risk of electric shock, do not remove the unit's cover (or back). There are no user serviceable parts inside. Refer servicing to qualified service personnel. If the power cord is fitted with a moulded mains plug the unit must not be used if the plastic fuse carrier is not in place. Should you lose the fuse carrier the correct part must be reordered from your Cambridge Audio dealer.

The lightning flash with the arrowhead symbol within an equilateral triangle is intended to alert the user to the presence of un-insulated 'dangerous voltage' within the product's enclosure that may be of sufficient magnitude to constitute a risk of electric shock to persons.



The exclamation point within an equilateral triangle is intended to alert the user to the presence of important operating and maintenance instructions in the service literature relevant to this appliance.

The crossed-out wheeled bin is the European Union symbol for indicating separate collection for electrical and electronic equipment. This product contains electrical and electronic equipment which should be reused, recycled or recovered and should not be disposed of with unsorted regular waste. Please return the unit or contact the authorised dealer from whom you purchased this product for more information.



### Approvals



This product complies with European Low Voltage (73/23/EEC) and Electromagnetic Compatibility (89/336/EEC) Directives when used and installed according to this instruction manual. For continued compliance only Cambridge Audio accessories should be used with this product and servicing must be referred to qualified service personnel.

**NOTE: THE MANUFACTURER IS NOT RESPONSIBLE FOR ANY RADIO OR TV INTERFERENCE CAUSED BY UNAUTHORIZED MODIFICATIONS TO THIS EQUIPMENT. SUCH MODIFICATIONS COULD VOID THE USER AUTHORITY TO OPERATE THE EQUIPMENT.**

This equipment has been tested and found to comply with the limits for a Class B digital device, pursuant to Part 15 of the FCC Rules. These limits are designed to provide reasonable protection against harmful interference in a residential installation. This equipment generates, uses and can radiate radio frequency energy and, if not installed and used in accordance with the instructions, may cause harmful interference to radio communications. However, there is no guarantee that interference will not occur in a particular installation.

If this equipment does cause harmful interference to radio or television reception, which can be determined by turning the equipment off and on, the user is encouraged to try to correct the interference by one or more of the following measures:

- Re-orient or relocate the receiving antenna.
- Increase the separation between the equipment and receiver.
- Connect the equipment into an outlet on a circuit different from that to which the receiver is connected.
- Consult the dealer or an experienced radio/TV technician for help.

## Important safety instructions

Please take a moment to read these notes before installing your 640R, as they will enable you to get the best performance and prolong the life of the unit. We advise you follow all instructions, heed all warnings and keep the instructions for future reference.

### Ventilation

**IMPORTANT** - The unit will become hot when in use.

Please ensure there is ample ventilation (at least 10cm clearance all round). Do not put any objects on top of this unit. Do not situate it on a rug or other soft surface and do not obstruct any air inlets or outlet grilles. Do not install near any heat sources such as radiators, heat registers, stoves, or other apparatus (including amplifiers) that produce heat. Do not stack multiple units on top of each other. Do not place in an enclosed area such as a bookcase or in a cabinet without sufficient ventilation.

Do not obstruct the rear heat tunnel ventilation grille. Ensure that small objects do not fall through any ventilation grille. If this happens, switch off immediately, disconnect from the mains supply and contact your dealer for advice.

### Positioning

Choose the installation location carefully. Avoid placing it in direct sunlight or close to a source of heat. Also avoid locations subject to vibration and excessive dust, cold or moisture. Do not place the unit on an unstable surface or shelf. The unit may fall, causing serious injury to a child or adult as well as serious damage to the product. Do not place a CD player or other equipment on top of the unit.

This unit must be installed on a sturdy, level surface. Do not place in a sealed area such as a bookcase or in a cabinet. Any space open at the back (such as a dedicated equipment rack) is fine however. When a cart is used, use caution when moving the cart to avoid injury from tip-over.



**WARNING** - To reduce the risk of fire or electric shock, do not expose this unit to rain or moisture. This unit must not be used near water or exposed to dripping or splashing water or other liquids. No objects filled with liquid, such as vases, shall be placed on the unit. In the event, switch off immediately, disconnect from the mains supply and contact your dealer for advice.

Electronic audio components have a running in period of around a week (if used several hours per day). This will allow the new components to settle down, the sonic properties will improve over this time.

### Grounding and polarisation

Do not defeat the safety purpose of the polarized or grounding type plug. A polarized plug has two blades with one wider than the other. A grounding type plug has two blades and a third grounding prong. The wide blade or third prong are provided for your safety. If the provided plug does not fit your outlet, consult an electrician for replacement of the obsolete outlet.

### Power sources

The unit should be operated only from the type of power source indicated on the marking label. If you are not sure of the type of power-supply to your home, consult your product dealer or local Power Company.

This unit has been designed to be left in Standby mode when not in use, this will increase the life of the amplifier (this is true with all electronic equipment). To turn the unit off completely switch off on the rear panel. If you do not intend to use this unit for a long period of time, unplug it from the mains socket.

### Power cord protection

The unit must be installed in a manner that makes disconnection of the mains plug from the mains socket outlet (or appliance connector from the rear of the unit) possible. Where the mains plug is used as the disconnect device, the disconnect device shall remain readily operable. Protect the power cord from being walked on or pinched particularly at plugs, convenience receptacles, and the point where they exit from the unit.

Be sure to insert each power cord securely. To prevent hum and noise, do not bundle the interconnect leads with the power cord or speaker leads.

### Overloading

Do not overload wall outlets or extension cord as this can result in a risk of fire or electric shock. Overloaded AC outlets, extension cords, frayed power cords, damaged or cracked wire insulation, and broken plugs are dangerous. They may result in a shock or fire hazard.

### Lightning

For added protection during a thunderstorm, or when it is left unattended and unused for long period of time, unplug the unit from the wall outlet and disconnect the antenna or cable system. This will prevent damage to the unit from lightning and power-line surges.

### Outdoor antenna grounding

If an outside antenna or cable system is connected to the product, be sure the antenna or cable system is grounded so as to provide some protection against voltage surges and built-up static charges. Section 810 of the National Electrical Code, ANSI/NIPA No. 70-1984 (section 54 of Canadian Electrical Code, Part 1) provides information with respect to proper grounding of the mast and supporting structure, grounding of the lead-in wire to an antenna-discharge unit, size of grounding conductors, location of antenna-discharge unit, connection to grounding electrodes, and requirements for the grounding electrode.

### Cleaning

To clean the unit, wipe its case with a dry, lint-free cloth. Do not use any cleaning fluids containing alcohol, ammonia or abrasives. Do not spray an aerosol at or near the amplifier.

### Attachments

Do not use attachments not recommended by your dealer as they may cause harm to the unit. Only use the specified attachments/accessories with this unit.

### Servicing

These units are not user serviceable, never attempt to repair, disassemble or reconstruct the unit if there seems to be a problem. A serious electric shock could result if this precautionary measure is ignored. In the event of a problem or failure, please contact your dealer.

Contact the service department should any of these conditions occur:

- When the power-supply cord or plug is damaged.
- If liquid has been spilled, or objects have fallen into the amp.
- If the unit has been exposed to rain or water.
- If the unit does not operate normally after following the operation instructions, adjust only those controls that are covered by the operation instructions.
- If the unit has been dropped or damaged in any way.
- When the unit exhibits a distinct negative change in performance.

### IMPORTANT

**If the unit is run at a very high level, a sensor will detect a temperature rise and show "PROTECTION OVERLOAD" on the display. The unit will then go into Standby mode. It cannot be switched on again until the temperature has fallen to a more normal level.**

## Front panel controls

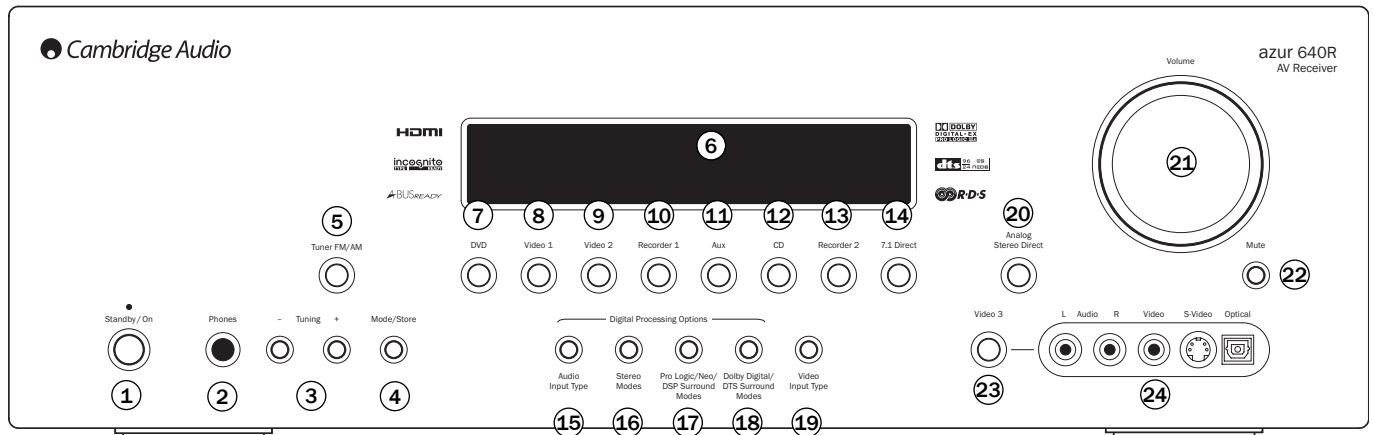

### ① Standby/On

Switches the unit between Standby mode (indicated by dim power LED) and On (indicated by bright power LED). Standby is a low power mode. The unit should be left in Standby mode when not in use.

### ② Phones

Allows for the connection of stereo headphones with a 6.35mm/¼" Jack plug. Headphones with an impedance of between 32 and 600 ohms are recommended. **Note:** Plugging in headphones will automatically mute the main and pre-amp outputs and select a 2-channel stereo down-mix to be created for headphone use.

### ③ Tuning +/-

Used to tune FM frequencies and skip presets in Tuner mode.

### ④ Mode/Store

Press to cycle between Tuner modes and for storing presets (refer to the 'Operating Instructions' of this manual for more information).

### ⑤ Tuner FM/AM

Press to select the tuner for output through the 640R. Once in Tuner mode also use this button to switch between FM and AM modes.

### ⑥ Display

Displays the status of the unit. Also receives IR commands from the supplied Azur remote control. A clear unobstructed line of sight between the remote control and the sensor is required.

### ⑦ DVD

Press to select the source equipment connected to the DVD input.

### ⑧ Video 1

Press to select the source equipment connected to the Video 1 input.

### ⑨ Video 2

Press to select the source equipment connected to the Video 2 input.

### ⑩ Recorder 1

Press to select the recording device connected to the Recorder 1 input.

### ⑪ Aux

Press to select the source equipment connected to the Aux input.

### ⑫ CD

Press to select the source equipment connected to the CD input.

### ⑬ Recorder 2

Press to select the recording device connected to the Recorder 2 input.

### ⑭ 7.1 Direct

Press to select a 7.1, 6.1 or 5.1 source (DVD-A or SACD player etc) connected to the 7.1 Direct In sockets.

**Note:** The 640R remembers the audio and video input type and processing mode for each individual source input. These are recalled each time a source is selected.

### ⑮ Audio input type

Press this button to toggle between analog or digital (optical/coaxial) input types for the currently selected source input.

### ⑯ Stereo modes

Press to listen to a source in either digitally processed stereo or stereo and sub modes.

### ⑰ Pro Logic/Neo/DSP surround modes

Press to select between various Pro Logic II/IIx, DTS Neo:6 effects for matrix encoded analog or digital material or for post-processing DD/DTS material (**Note:** The 640R is unable to auto-detect this kind of source material as it does not include embedded encoding type flags so manual selection is required). Also selects various DSP created surround sound modes for unencoded stereo sources.

### ⑱ Dolby Digital/DTS surround modes

Press to select Dolby Digital or DTS surround modes (with suitably encoded digital source material). These modes can only be decoded from digital audio sources (via Coaxial or Optical inputs).

### ⑲ Video input type

Press to select the video input type (Composite, S-Video or Component Video) you wish to use for the current source input.

### ⑳ Analog stereo direct

Press to listen directly to the analog inputs for the current source with no analog to digital or DSP processing for highest possible stereo sound quality.

### ㉑ Volume

Use to increase/decrease the level of the sound from the outputs of the 640R.

### ㉒ Mute

Press to mute the sound from the main and pre-amp outputs of the 640R. Press again to cancel mute.

### ㉓ Video 3 source button

Press to select a video camera recorder/video games console connected to the Video 3 input sockets.

### ㉔ Video 3 input sockets

Connect a video camera recorder/video games console to the 640R. Audio/Video and digital optical inputs are provided.

## Rear panel connections

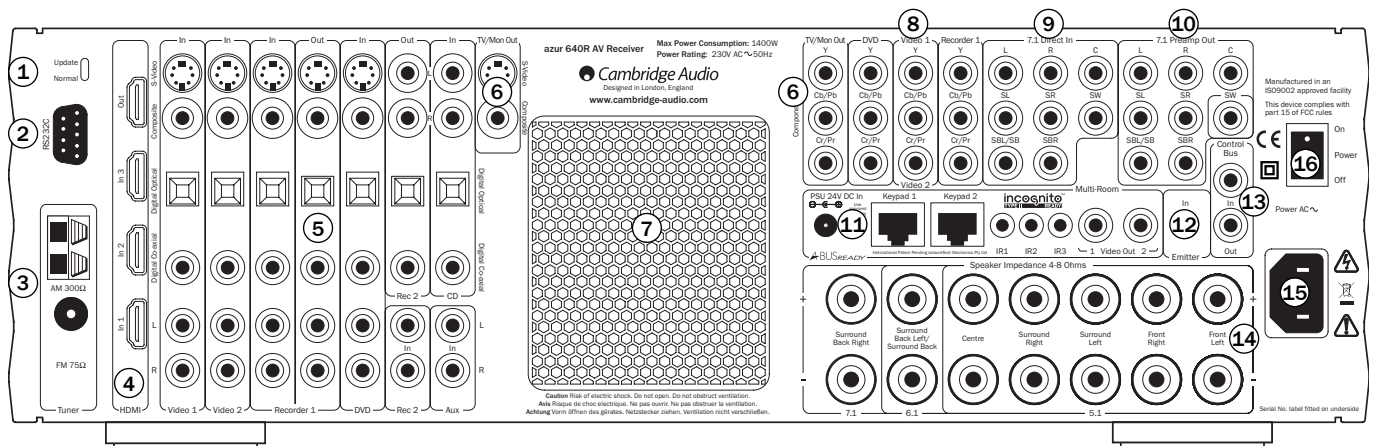

### ① Update/Normal

**For dealer use only** - Switches the 640R between normal (default) mode and software update mode. Do **not** change the mode to update or make connections to it in update mode as damage may result!

### ② RS232C

Used for control of the 640R in Custom Install situations. A full protocol is available for the 640R on our website.

### ③ FM/AM antenna

All tuner antenna connections are made here. Refer to the 'Antenna Connections' section of this manual for more information.

### ④ HDMI

Inputs and output to a suitable TV/Monitor. The HDMI inputs can be assigned in the OSD to the DVD, Video 1, Video 2 or Rec 1 sources, see later section.

### ⑤ Video 1/2, Recorder 1/2, DVD, Aux

Please refer to the connection diagrams later in this manual for more information on these inputs and outputs.

### ⑥ TV/Mon outputs

**S-Video** - Connect to your television via S-Video cable.

**Composite** - Connect to your television via 75 ohm RCA phono cable.

**Component** - Connect to the Cr/Pr, Cb/Pb, & Y terminals of a television set.

Normally only one type of connection will be used. These outputs are also used to view the 640R's On-Screen Display setup menus.

### ⑦ Heat tunnel vent grille

Allows cooling of internal circuitry. **DO NOT OBSTRUCT!**

### ⑧ Component Video inputs (DVD, Video 1/2, Recorder 1)

Connect the Component Video outputs from the source equipment.

**Note:** The preferred connection method for video inputs or outputs is always Component Video then S-Video then Composite Video then HDMI. HDMI and Component Video sources often also support Progressive Scan which gives better picture quality if supported by both your DVD player and TV.

### ⑨ 7.1 Direct In

Connect to the output terminals of a DVD-A, SACD 5.1/6.1/7.1 analog source.

### ⑩ 7.1 Preamp Out

Connect to the 5.1/6.1/7.1 channel input terminals of another amplifier system, separate power amps, subwoofer or active loudspeakers.

### ⑪ A-BUS™ Ready/Incognito Ready™ multi-room outputs

**PSU In** - Connect an Incognito PS5 to supply power to the connected multi-room keypads/speakers.

**Keypad 1/2** - Connect one or two Incognito A-BUS KP10 keypads (or other A-BUS compatible keypads) or AS10 Active Ceiling Speakers using CAT5/e cable, allowing 2nd/3rd zone multi-room capability.

**IR** - Three IR emitter outputs for remote control of source equipment.

**Video Out 1/2** - Provides video feeds to the 2nd/3rd zone.

Please refer to the 'Multi-Room' section of this manual for more information on connections and set-up.

### ⑫ Emitter In

Allows modulated IR commands from multi-room systems or IR repeater systems to be received by the 640R. Commands received here are not looped out of the Control Bus. Refer to the 'Custom Installation' section for more information.

### ⑬ Control Bus

**In** - Allows un-modulated commands from multi-rooms systems or other components to be received by the unit.

**Out** - Loop out for control bus commands to another unit.

### ⑭ Speaker terminals

Connect to loudspeakers with an impedance of between 4-8 ohms. 7.1, 6.1, 5.1 or less connections can be made.

### ⑮ Mains power lead

Once you have completed all connections, plug the AC power lead into an appropriate mains socket. The AV receiver is now ready for use.

### ⑯ Power On/Off

Switches the unit on and off.



## Remote control

The 640R is supplied with an Azur Navigator remote control. Insert the supplied AAA batteries to use. For full details of the various adjustment functions available from the remote, refer to the later sections of this manual.

### Standby/On

Switches the unit between Standby mode and On.

### Analog Direct

Directly selects a stereo analog input for the current source with no A/D conversion or DSP processing.

### Stereo Modes

Selects Stereo or Stereo + Sub modes for Analog or Digital sources (digitally processed).

### PLIIx/Neo/DSP

Selects from various matrix encoded surround processing modes for analog or digital sources (digitally processed).

### DD EX/DTS ES

Selects digital surround processing modes for Digital sources only.

### Dynamic

Press repeatedly to reach the desired dynamic compression range (Dolby Digital or DTS modes only).

### Sub On/Off

Press to turn on/off the output of the subwoofer. Also, hold down and then press the volume up and down buttons to adjust the overall sub level if desired.

### PTY (Program Type Search)

Press to search by program type when in Tuner mode. Refer to the 'Operating instructions' section of this manual for more information.

### APS (Auto Program Search)

Hold down for 4 seconds to allocate and memorise radio stations automatically.

### Display

Press to view the current source material and decoding mode. When listening to FM with RDS, press to cycle round various RDS information modes.

### Stereo Mono

When listening to FM, press to alternate between stereo and mono modes.

### Store

Press to store the current frequency when in Tuner mode.

### Mode

Press to select Auto/Manual or Preset tuning when in Tuner mode.

### Mute

Mutes the audio on the AV Receiver. Press again to cancel mute.

### Volume

Increase or decrease the volume of the AV receiver output. Also used as up/down in the OSD setup menus.

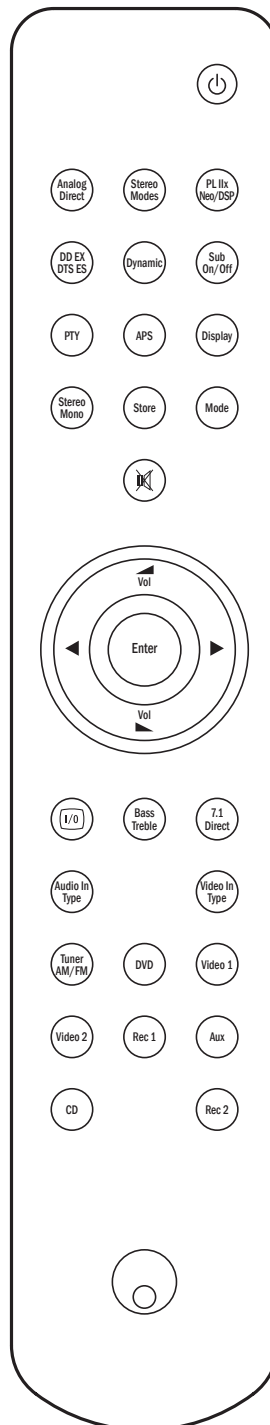

### Tune / Left & Right

Press the right arrow to increase tuner frequency/change preset. Press the left arrow to decrease tuner frequency/change preset. Also used to scroll left/right in the OSD setup menus.

### Enter

Used in the OSD setup menus.

### On-Screen Display (OSD)

Press to turn on and off the on-screen set-up menus when connected to a monitor/screen via Composite, S-video or Component connections.

### Bass/Treble

Press for bass/treble adjustment, using the Volume up/down buttons. **Note:** Bass/Treble is disabled in analog stereo direct and 7.1 direct modes.

### 7.1 Direct

Selects the 5.1/6.1/7.1 direct input.

### Audio In Type

Switches the 640R between analog and digital inputs for the currently selected source.

### Video In Type

Selects Composite video, S-Video or Component video as the analog video input type for the current source (Additionally HDMI can also be assigned in the OSD menu).

### Tuner AM/FM, DVD, Video 1, Video 2, Rec 1, Aux, CD, Rec 2

Press the corresponding button to change the input source. Pressing the Tuner AM/FM button a second time toggles between AM and FM modes.

The above button descriptions are naturally brief. Please refer to the 'Operating Instructions' section of this manual for more information on the relevant functions implemented.



## Front panel display

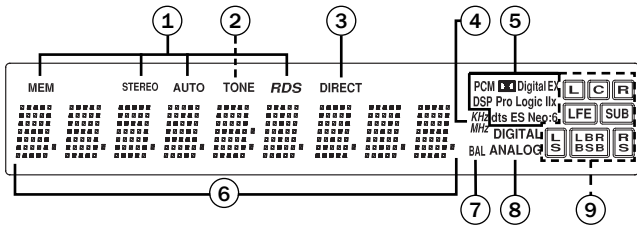

- ① Tuner mode indicators**  
Shows Memory/Store active, Stereo mode active, AutoScan active and RDS On.
- ② Tone control indicator**  
Lights when Bass and Treble controls are active.
- ③ Direct indicator**  
Lights when the 640R is in a Direct mode - Analog Stereo Direct or 7.1 Direct.
- ④ Frequency type**  
Indicates the tuned frequency in AM or FM Tuner mode.
- ⑤ Decoding mode indicators**  
Shows the current decoding mode, Dolby Digital, Dolby Digital EX etc. In conjunction with the Output Channel indicators these give full details of the current processing mode.
- ⑥ Main information display**  
Shows the current source selected, also the surround mode and station name/frequency when in tuner mode etc.
- ⑦ Balance indicator**  
Lights when the Front Left and Right speaker outputs have been set to different levels in the OSD, i.e. a balance adjustment has been made.
- ⑧ Digital/Analog indicators**  
Indicates the current source input type - digital or analog.
- ⑨ Output channel indicators**  
Shows the currently active channels depending on decoding mode and source material. Icons lit indicate active channels in the source material. Icons with a box around them indicate actual channels being output separately.

### Display examples

<p>Digital L C R LFE DIGITAL L S R</p>	<p>- Indicates a 5.1 Dolby Digital source being played back as 5.0 (Sub off). LFE indicates a low frequency effects channel is present in the source material. When this icon isn't boxed it indicates the LFE channel is not being reproduced separately.</p>
<p>dts ES L C R LFE DIGITAL L S L B R B R S</p>	<p>- Indicates a 7.1 playback of DTS ES material.</p>
<p>PCM L R SUB ANALOG</p>	<p>- Indicates a 2.1 output created in the digital domain from analog input material.</p>

## Loudspeaker connections

To avoid damaging the speakers with a sudden high-level signal, be sure to switch the power off before connecting the speakers. Check the impedance of your speakers. Speakers with an impedance of between 4 and 8 ohms (each) are recommended.

The coloured speaker terminals are positive (+) and the black speaker terminals are negative (-). Make sure correct polarity is maintained at each speaker connector or the sound can become weak and "phasey" with little bass.

Prepare the speaker cords for connection by stripping off approximately 10mm (3/8") or less (no more than 10mm, as this could cause a short-circuit) of the outer insulation. Twist the wire tightly together so there are no loose ends. Unscrew the speaker terminal knob, insert the speaker cable, tighten the knob and secure the cable.



**Note:** All connections are made via loudspeaker cable, except if using an active subwoofer which would be connected via a standard RCA phono cable. Banana Plugs (4mm standard) connected to the speaker cable are recommended for direct insertion into the speaker terminals.

Please refer to the 'Speaker Configuration' section of this manual for more information on 5.1, 6.1 and 7.1 speaker setups.

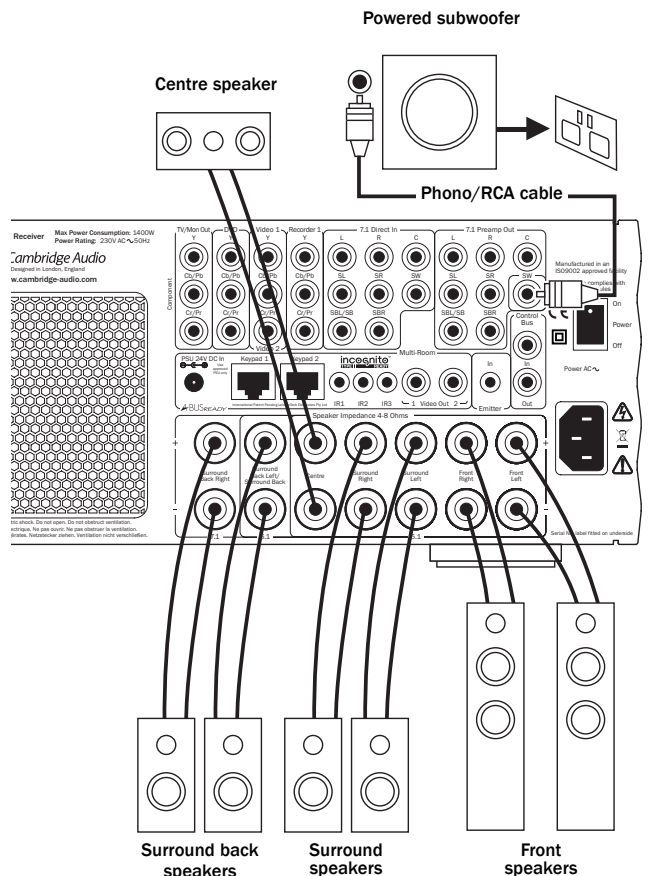

## Analog audio connections

**Note:** Do not plug in the mains power lead or turn the unit on until all connections have been made.

Connect to source equipment using stereo phono cables (stereo 2RCA-2RCA). Tape/MD/CDR recorder/players require two sets of stereo phono/RCA cables, one for recording, one for listening.

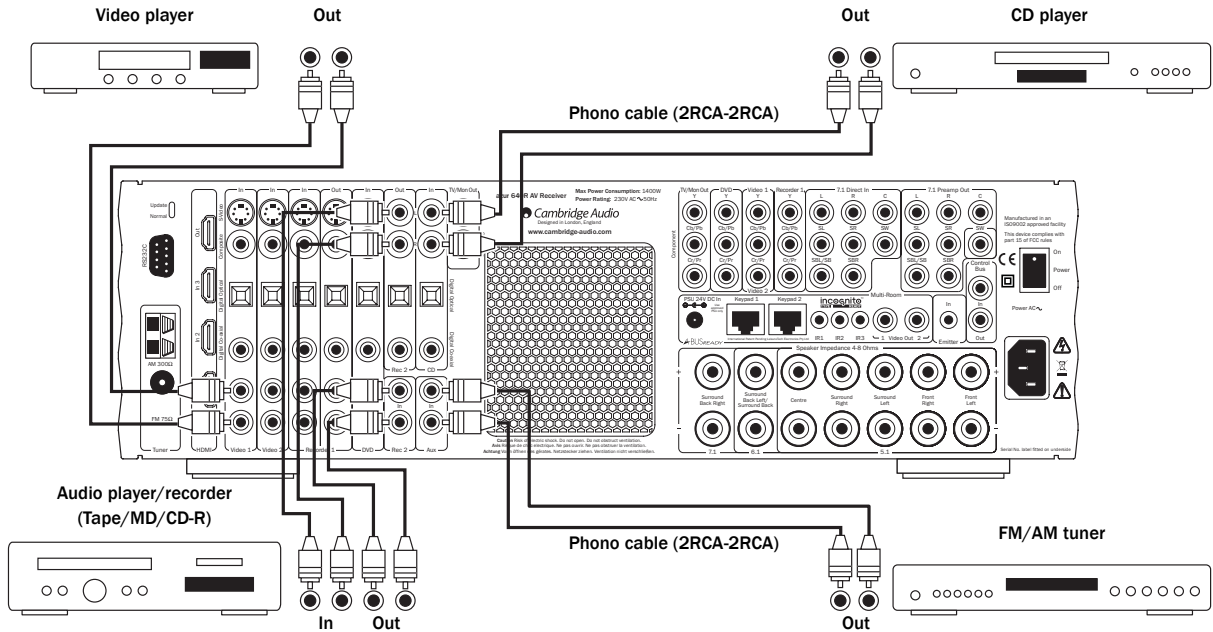

## Digital audio connections

Two types of digital audio connections can be made to the 640R:

1. Optical (Toslink)
2. Coaxial (SPDIF)

Either type can be used for a source as the 640R automatically uses the active one.

**Note:** Only one connection type should be used per source.

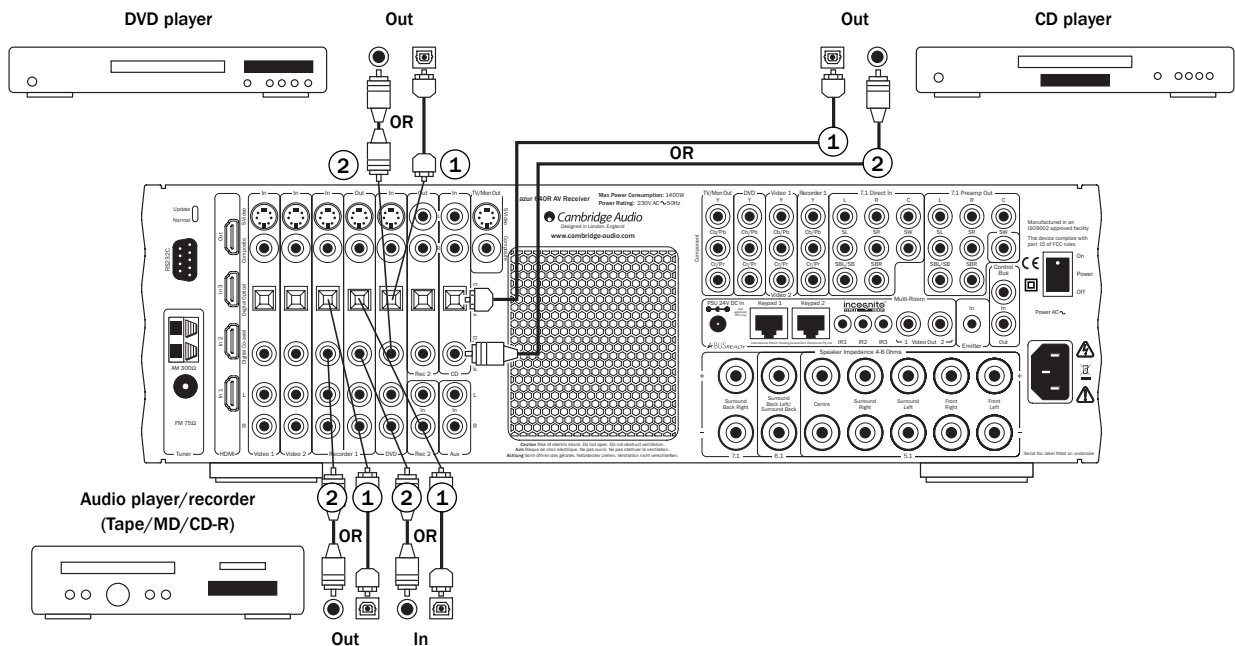

## Video connections

Three types of video connections can be made to the 640R:

1. Composite - connect with single 75 ohm video phono cable (RCA-RCA).
2. S-Video - connect with S-Video cable.

3. Component - connect with 75 ohm Component video cables (3RCA-3RCA).

For best picture quality we recommend making Component video connections, then in declining order of quality, S-Video connections and then Composite video connections.

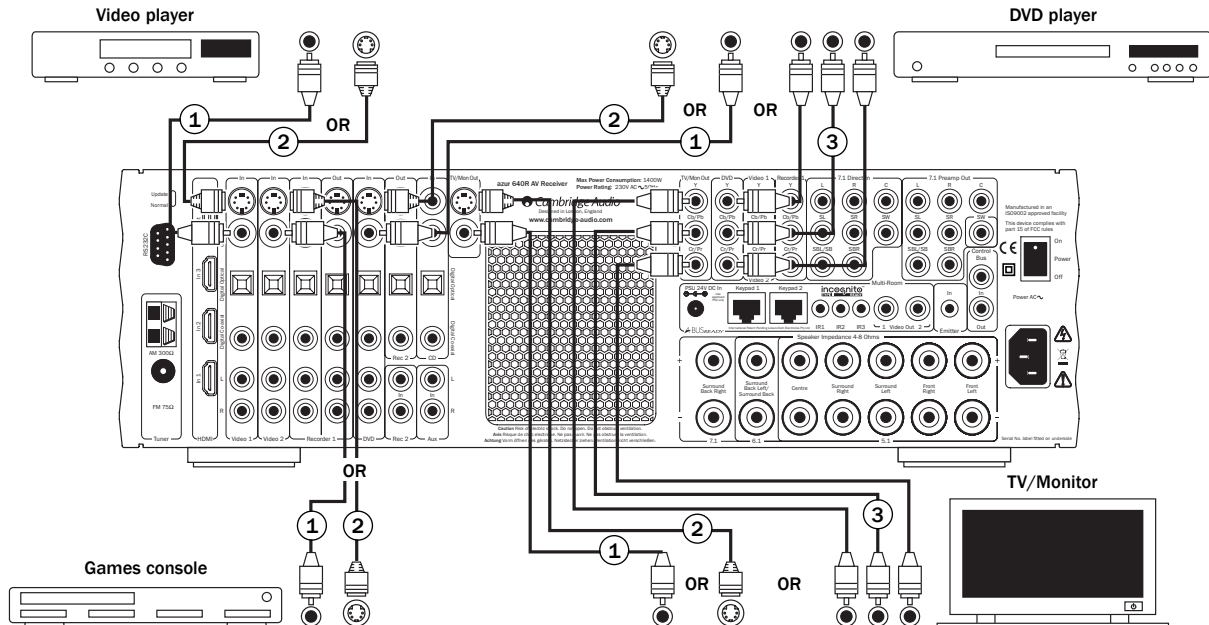

## HDMI connections

HDMI (High-Definition Multi-Media Interface) is a new all digital connection that can carry both audio and video in one cable. Direct digital transfer of video and support for various types of High Definition video content make this the best connection type for picture quality. The 3 HDMI inputs can be assigned to DVD, Video 1, Video 2 and Recorder 1 (see the "Assigning HDMI sources" section for more information).

The 640R routes the HDMI outputs of DVD players, set-top boxes etc to the TV/Monitor without any internal processing. Consult both the source and TV's manuals to find out how to set the best modes for best picture quality. As the 640R only routes/switches HDMI it is not involved in these settings itself.

The sources will also normally supply audio to the TV/Monitor over the HDMI connection, this will be separate from the audio that the 640R decodes.

**In order for the 640R itself to receive audio (Including surround-sound) from HDMI (or DVI) sources a Co-axial (SPDIF) or Optical (Toslink) digital audio connection must be made from each source to the 640R.**

DVI switching can be supported simply by using DVI to HDMI adaptors as these two connection types are compatible. When using DVI only video will be passed to the TV/Monitor. Again a Co-axial (SPDIF) or Optical (Toslink) digital audio connection must be made from each source to the 640R for it to be able to receive audio and decode surround sound etc.

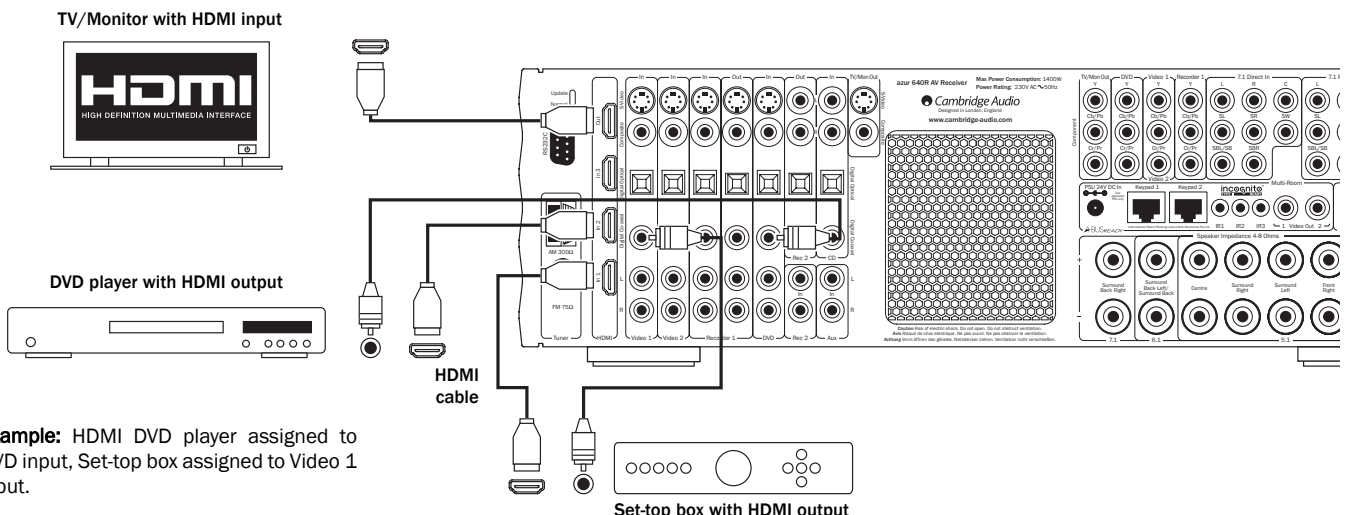

**Example:** HDMI DVD player assigned to DVD input, Set-top box assigned to Video 1 input.

## 5.1/6.1/7.1 Direct in

DVD-A or SACD players can be connected to the 640R via its 5.1/6.1/7.1 Direct inputs allowing multi-channel music playback from these new sources.

DVD-A and SACD both support 5.1 output. The 640R's direct inputs also allow optional connection of Surround Back or Surround Left and Surround Right signals for compatibility with future 6.1 or 7.1 sources or external decoders.

To select the Direct Input press the *7.1 Direct* button on the front panel or remote.

**Note:** These connections are pure analog for best sound quality and no DSP processing or Bass and Treble adjustment by the 640R is possible.

DVD-A player or SACD multi-channel player 5.1 connections

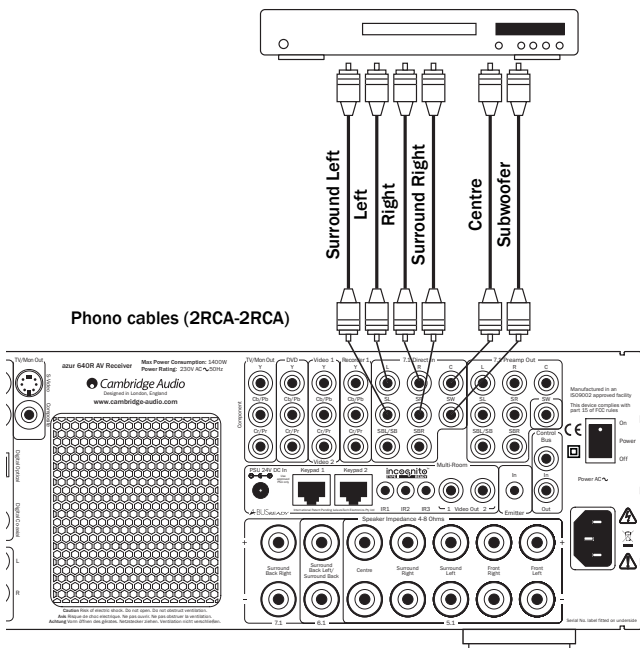

## 7.1 Preamp out

To connect external power amplifiers, use Phono/RCA leads connected to the 7.1 Preamp Outputs on the rear panel.

For 5.1/6.1/7.1 use set the 'Pre Out' setting in the 'Output Setup' OSD menu to 'Pre Out' rather than 'Normal'. This mutes all the internal power amplifiers as they are not being used.

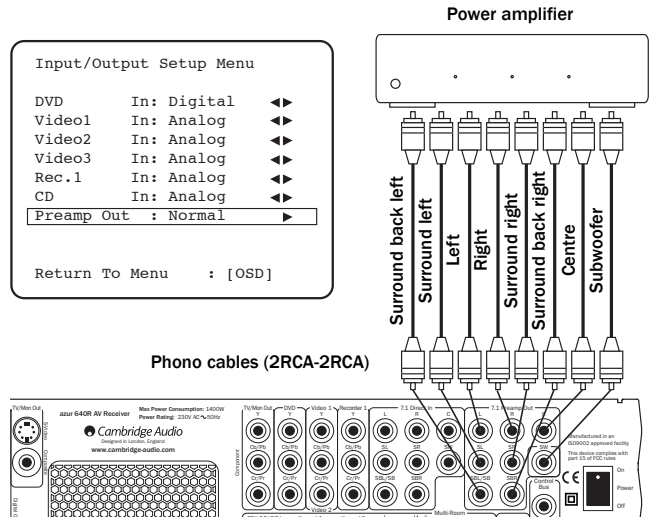

Alternatively the 640R features an External 2-Channel mode. This allows the 640R to reproduce all the surround channels of suitable source material (Centre, Surrounds and Sub) whilst the Left and Right Front speakers are driven by an external power amplifier or other amplifier capable of supporting fixed level inputs (e.g. Cambridge Audio's 740A or 840A amplifiers).

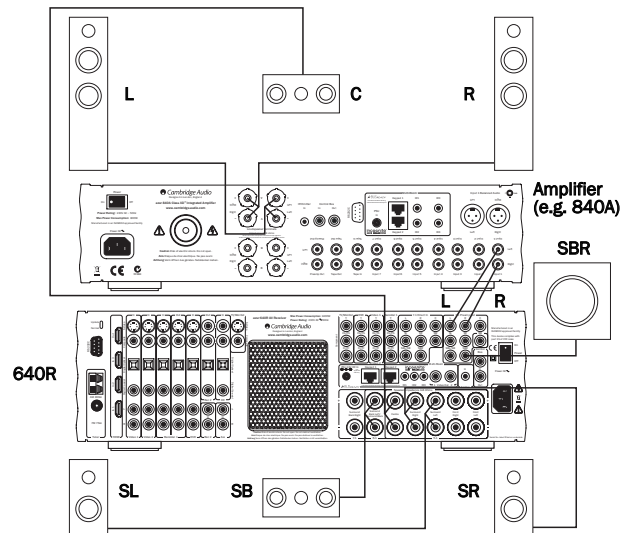

Set the 'Preamp Out' to 'Ext.2 Ch' in the OSD to mute the front left and right amplifier outputs only:

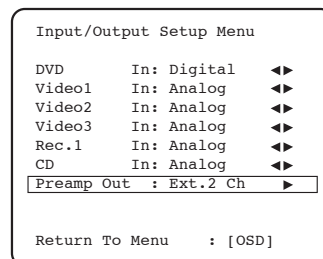

## Front input connections

The front panel Video 3 input is for temporary connections to video games consoles etc. Remove the cap to access the Video 3 inputs, and connect to a video game console or video camera's outputs using stereo phono cable (RCA-RCA) and either (1) Composite or (2) S-Video cable, depending on what your unit supports (S-Video preferred).

If your games console has an optical digital output this can also be used, allowing the 640R to decode surround sound information if the console/game supports it.

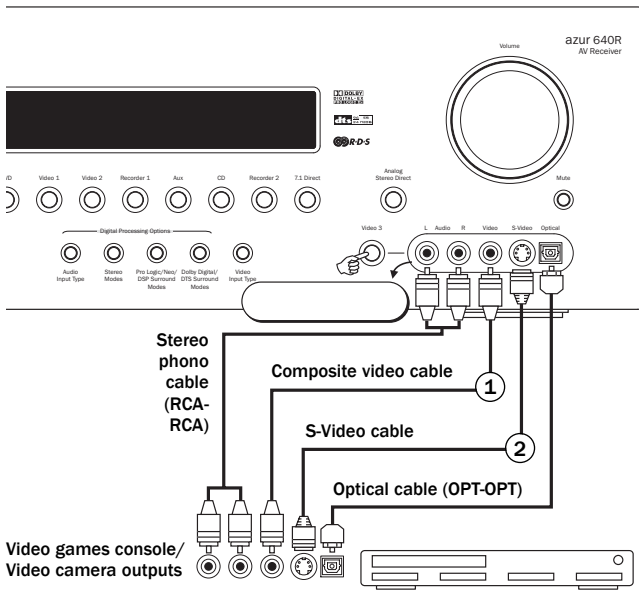

## Aerial connections

### FM aerial

Connect an aerial to the FM 75 ohm socket (a simple wire aerial is supplied only for temporary use). Extend the lead and move the aerial around until you get the best reception. For continued use, we strongly recommended using a 75 ohm outdoor FM aerial.

### AM loop aerial

Connect each end of the single length antenna to the antenna terminals. Place the antenna as far from the main system as possible to prevent unwanted noise and to obtain optimum reception. If the AM loop aerial provided does not receive sufficient reception, it may be necessary to use an outdoor AM aerial.

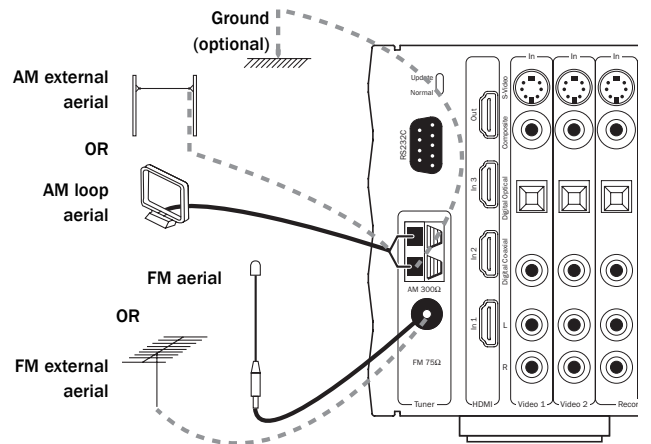



## 640R setup

The setup of the 640R is a 5 stage process as follows:

1. Speaker configuration.
2. Speaker delay
3. Level calibration
4. Source setup (2 settings)
  - Source audio type
  - Source video type
5. Assigning any HDMI sources

### 1. Speaker configuration

First decide what kind of speaker package you would like to use. The options are 5.1, 6.1 or 7.1. The 640R can support up to a 7.1 speaker setup which means 7 speakers (Front Left, Front Right, Centre, Surround Left, Surround Right, Surround Back Left, Back Right) plus a mains powered Subwoofer (the .1).

Refer to the diagrams below for typical examples of 5.1, 6.1 and 7.1 loudspeaker setups. Always adjust the speaker and listening positions until you are happy with the sound. Please refer to the loudspeaker and subwoofer manuals for more detailed positioning information.

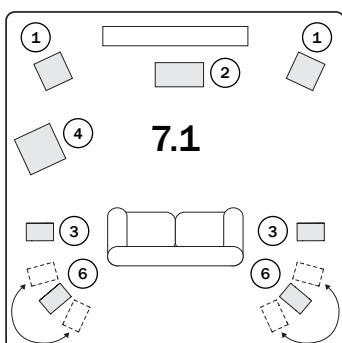
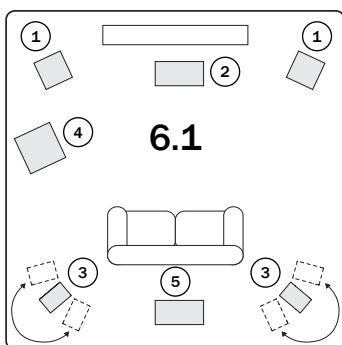
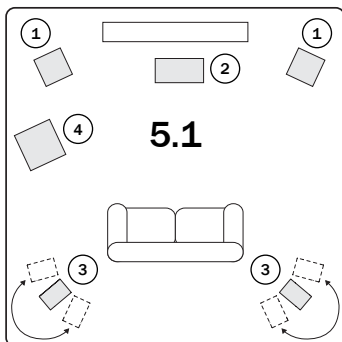

#### ① Front Left and Right speakers

For stereo and multi-channel sound.

#### ② Centre speaker

For dialogue and centre sounds. Ideally position at a similar height to the front left and right speakers (above or below the TV/monitor). Using a centre speaker from the same manufacturer/range as used for the front left and right speakers is advisable. This “timbre matching” allows surround effects to flow more naturally from left to right without obvious transitions between the speakers.

#### ③ Surround Left and Right speakers

For ambient and multi-channel sound. Floorstanding speakers should be angled towards the listening position. Bookshelf/standmount speakers should be wall mounted or used with dedicated speaker stands, positioned at or above ear height.

#### ④ Subwoofer

For improving the bass in your system, as well as reproducing dedicated LFE cinema effects when playing Dolby Digital or DTS encoded discs. Your subwoofer can often be placed almost anywhere in the room as bass is less directional, but experimentation with positioning is recommended.

#### ⑤ Surround Back Centre speaker

Sixth channel speaker required for enjoying Dolby® Digital EX or DTS®-ES or other 6.1 audio. Improves the quality of sound effects by filling the gap between the surround left and rear right speakers. Position the speaker firing towards the front of the room.

#### ⑥ Surround Back Left and Right speakers

Individual back speakers in place of a single surround back. Used with the very latest 7.1 processing types. Remember to experiment with the positions until you are happy with the sound.

In each case the 5.1/6.1/7.1 in fact relates to the maximum number of speakers that can be used, as for each the Centre, Sub and Surround speakers can all be deleted if required (although of course performance is reduced). For example, if you choose not to use a Centre Channel speaker you can set this to 'None' in the settings as shown later and the 640R will automatically redirect the centre channel audio information into the Left and Right Front channels, creating what is known as a 'Phantom Centre'.

Similarly, you might decide not to use a subwoofer if your main Left and Right speakers are capable of reproducing enough bass for a satisfying music/movie experience. The 640R will then automatically re-direct the bass from the Subwoofer/Low Frequency Effect channel to the Left and Right Front Speakers.

**Note: This setup is very important as the 640R will also automatically use this information to select appropriate Dolby and DTS decoding modes dependant not only on the source material but also the speaker package it knows you have.**

First tell the unit the type of package you have. This is done via the On-Screen Display. Highlight the 'Speaker Configuration' menu by using volume up and down on the remote then go to it by pressing *Enter*.

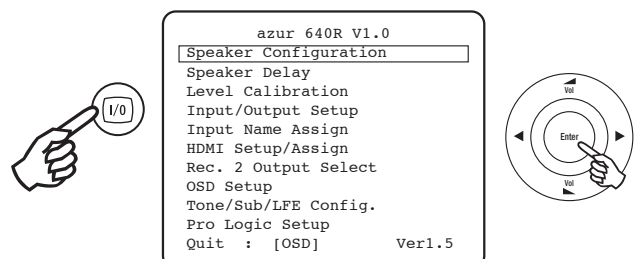

Set the package as 5.1, 6.1 or 7.1 by highlighting the Decode Mode item and using the *Left* and *Right* arrows to scroll through the options:

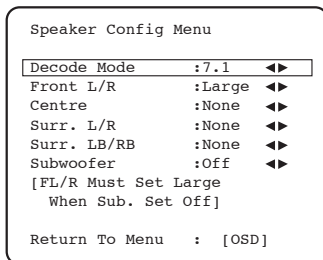

Now move down and by highlighting each speaker in turn and using the *Left* and *Right* arrows select from 'Large', 'Small' or 'None' for each speaker. 'Large' or 'Small' are used to describe each speaker in terms of bass response, they do not necessarily reflect the actual physical size of the speaker.

**Large** = Speakers with an extended low frequency response of approximately 20-40Hz to 16-20kHz (floorstanders or high quality larger stand-mounted speakers).

**Small** = Speakers with a less extended low frequency response of approximately 80-100Hz to 16-20kHz (small stand-mounted, bookshelf or satellite speakers).

Setting each speaker allows the 640R to perform what is called Bass Management and to direct low frequency bass from music and the Low Frequency Effects channel of surround sound material to those speakers best able to reproduce it. If you do not wish to use any of the speakers set its setting to 'None'.

The Subwoofer output can also be set to On or Off. If no sub is being used make sure this setting is set to Off to allow the 640R to re-direct the bass information in this channel to other speakers.

**Note:** The 640R will force some speakers to certain settings in some of the following circumstances!

The Front Left and Right speakers may be 'Large' or 'Small' but never 'None' as they are always required for any type of music/movie reproduction.

Bass must always be reproduced by either the Front Left and Right or Subwoofer channel (or both). Setting the Front Left and Right to 'Small' will result in the Subwoofer automatically being set to 'On'. Setting the Subwoofer to 'Off' will automatically result in the Front Left and Right being set to 'Large'.

If the Front Left and Right cannot reproduce low frequency bass a Subwoofer must be used. I.e. If the Front Left and Right are set as 'Small' the Sub must be Set to 'On'.

Also, setting the Front Left and Right as 'Small' will always set the other speakers as 'Small' (and the Sub to 'On'). This is because LFE/ bass information should not be redirected to the surround channels.

To store the setting simply come back out of the OSD (pressing the OSD button always moves back one menu item, and then exits and stores from the main menu screen).

## 2. Speaker delay

Because the speakers in a surround sound system are usually different distances from the listener the 640R incorporates the ability to apply a variable digital delay to each of the channels so that the sound from each arrives at the same time at the listening position for best surround-sound effect. Each pair of speakers (i.e. Front Left and Right or Surround Left and Right) are subject to the same delay and so must be situated equidistant from the listener.

To set the delay times simply measure the distances from the listening position to each speaker as shown in the following diagram:

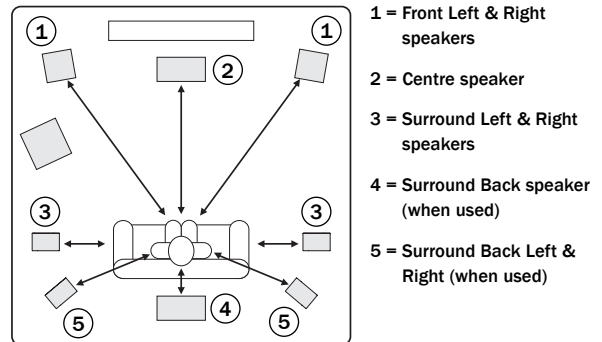

**Note:** No delay setting for the subwoofer is necessary.

Set the distances in the OSD Speaker Delay menu to the nearest value in metres (1 foot = 0.3 metres). The speed of sound is approx 340 metres per second, the 640R thus introduces approx 3mS of delay per metre of distance set.

Go to the 'Speaker Delay Menu' and highlight each speaker in turn. Set the distance to the nearest value to that which you measured by using the *Left* and *Right* arrows (the values do not need to be exact):

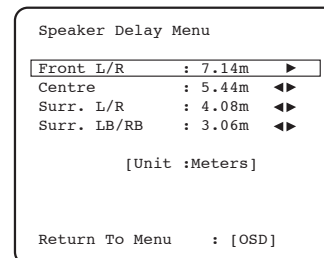

Press the OSD button to exit the menu.

**Note:** In addition to the delays as set above Dolby Pro Logic II/IIx playback also requires an extra 15 milliseconds delay to the surround channels only. This extra delay is part of the Dolby Prologic II specification and ensures that sound from the surrounds arrives just after sound from the front reducing the audibility of sound leakage from the front to the surround speakers. Because the relationship between the Dolby Digital and Dolby ProLogic IIx two delays is fixed (15mS extra to the surround channels), it is only necessary to set the delay by measuring the distances as we have described. The 640R will automatically provide the appropriate extra delay whenever you switch to a Pro Logic Mode.



### 3. Level calibration

The 640R allows level calibration to match the acoustic level between different types/sizes or even manufacturers of speaker that may be being used for each channel. This is achieved by adjusting the relative level of each speaker through the 'Level Calibration' menu in the OSD.

The basic process is to listen to or measure with an SPL meter (more accurate and recommended but not essential) the level of sound produced by each speaker and set relative levels for each speaker so that they all sound the same loudness at the normal listening position. The 640R incorporates a Test Signal Generator (broad-band white noise) to facilitate this.

Set the unit to a normal listening level or half maximum volume approximately. Press the OSD button on the remote control then select the 'Level Calibration' menu. Now turn on the test signal by highlighting this item and pressing the *Left* or *Right* arrows:

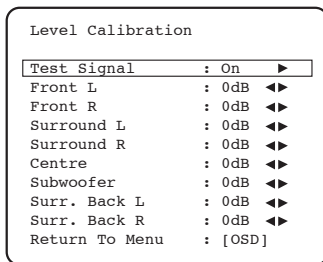

A "rushing" or "hissy" sound should be heard, initially through the Front Left Speaker.

You can now move up and down the channels using *Volume Up/Down* on the remote. Each time a new channel is selected the test signal will be heard to move to that channel. Compare the loudness of all channels as heard at the listening position.

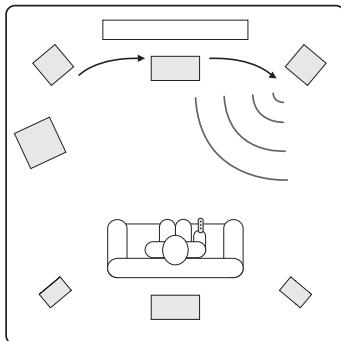

Now adjust the channels so they all sound the same (in terms of loudness only, channels of different frequency responses can sound different in terms of the "tone" of the sound i.e. more or less hissy).

Pick the channel that sounds most different and select it to listen to the test signal. Now adjust the relative level in dB (using Arrow left/right on the remote) and continue comparing it to other channels until it is of equal loudness. The level can be adjusted up to + or - 10dB in 1dB steps. Repeat the process with the next loudest channel etc. Once all channels sound the same in terms of loudness, press the OSD button again to save the settings and exit the menu.

### 4. Source setup

The next step is to select each source input in turn on the 640R and tell the unit:

- The type of audio connection you want to use for that source (Analog or Digital input)
- The type of video connection you want to use for that source (Composite, S-Video or Component)\*
- The processing mode for that source

**The 640R remembers these settings individually for every source input and automatically recalls them as and when you change source input.**

\* Remember if you wish to use HDMI for any sources this is achieved by assigning HDMI sources in the OSD in Step 5.

#### Audio connection type

Select the 'Input/Output Setup' menu. Highlight each source in turn select either analog or digital input types (use the *Left* and *Right* arrows):

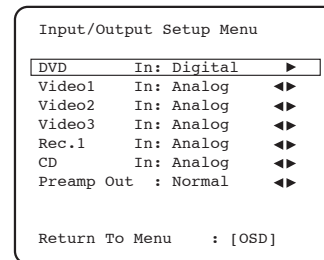

Analog inputs will require a stereo phono/RCA to phono/RCA cable connection to the 640R. Digital inputs will require either a 75ohm digital type phono/RCA to phono/RCA co-axial cable (SPDIF) or an optical fibre cable (TOSLINK). The 640R will automatically use whichever is connected. Do not make connections to both the Optical and Co-axial inputs for a source.

**Note:** The Preamp output item at the bottom of this menu selects between Normal mode (the default), Pre Out Mode (when external power amps are used) and Ext 2 Ch Mode (where external power amps for front left and right only are used). These options are covered later. Make sure this setting shows Normal.

Once you have set the audio types exit the OSD to save.

This setting can also be changed at any time without using the OSD by pressing the *Audio Input Type* button on the front panel or remote, this will then cycle between analog or digital input types for the currently selected source, as usual they will then be remembered the next time you return to that source.

### Video connection type

The 640R provides transcoding or conversion between Composite, S-Video or Component video formats. This function is very useful in that it allows for a single analog connection type to be made to the TV/Monitor even if different input video connection types are used for different source inputs. As with the video inputs, the best output connection type to make to the TV/Monitor is (in declining order of quality) Component, then S-Video then Composite.

When you set the Input Video type the 640R also automatically selects a transcoding mode as shown in the table below:

		MONITOR/TV OUTPUT TYPE		
		Composite	S-Video	Component
SELECTED VIDEO INPUT TYPE	Composite	<b>DIRECT</b>	Transcoded	Transcoded
	S-Video	Transcoded	<b>DIRECT</b>	Transcoded
	Component	Direct	Direct	<b>DIRECT</b>

This setting is remembered input by input. It can be seen that whatever the input video type, the 640R is able to provide Composite, S-Video and Component outputs concurrently. All that is required is to tell the 640R which input type you are using.

This is done by selecting each source (DVD, Video1 etc.) from the front panel (OSD off) and then pressing the *Video Input Type* button. This cycles round the three types of analog video connections that can be made on the 640R:

1. Composite Video (CVBS)
2. S-Video (S-VHS, Y/C)
3. Component Video (YCbCr / YPbPr, YUV)

For best picture quality we recommend making Component video connections, then in declining order of quality, S-Video connections and then Composite video connections.

If a digital video connection (HDMI or DVI) is available this is even better than Component and should be set in Step 5. For sources where you wish to use HDMI or DVI, just set the video type to Composite for now.

## 5. Assigning any HDMI (or DVI) sources

The 640R has 3 HDMI (High Definition Multi-Media Interface) inputs and one HDMI output. HDMI is a fully digital audio/video system that passes the picture and audio to the screen in digital format for best possible picture quality. DVI (Digital Video Interface) is a subset of HDMI that uses different connectors and only passes digital video to the TV/Monitor (no audio). The 640R is fully compatible with DVI in that simple passive DVI-HDMI adaptors are available which allow the conversion of the DVI connector to an HDMI format connector (and back again if required) for routing via the 640R. The 640R can switch both types of signal.

HDMI/DVI (henceforth referred to as HDMI) outputs on DVD players and Set-top boxes also often support higher resolution formats including progressive scan types. Consult both your HDMI source and TV manuals for details, it is often possible to select from various options, you will want to select the highest quality output that both your source and TV are compatible with.

The 640R performs HDMI switching, not processing, it routes the HDMI signals from the source equipment to the TV/Monitor without any processing, so as far as the 640R is concerned there is no setup involved other than to assign the three inputs to a desired source. The 640R does not receive audio or video over the HDMI so for surround-sound decoding etc. an audio connection must also be made from your HDMI source to the 640R. As with other sources this can be analog or digital audio. A digital audio SPDIF/Toslink connection is preferred and will be required if it is desired to decode surround-sound for the HDMI sources.

Each of the three HDMI inputs can be freely assigned to the DVD, Recorder 1, Video 1 or Video 2 inputs in the OSD. Select the 'HDMI Setup/Assign' menu. Highlight each HDMI input in turn and assign it to one of the 4 possible options (with the *Left* and *Right* arrows):

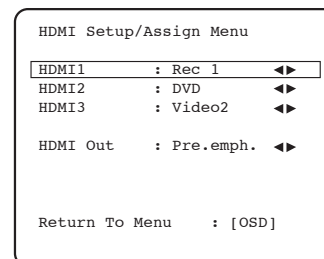

There is also an option for HDMI Output Pre-Emphasis. For cable runs <5 metres this option should be set to Normal. For longer runs this option should be set to 'PreEmph', the 640R applies some pre-emphasis to allow for cable losses in such situations. Maximum cable length depends on cable quality and to some extent the resolution of the video being transmitted (i.e. higher bit rate signals are harder to transmit long distances). HDMI cable repeaters are available and may be required for cable lengths >15 metres.

Highlight 'HDMI Out' and select either 'Normal' or 'PreEmph' mode:

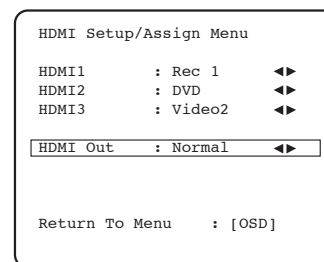

Press the OSD button to exit the menu.

## Surround sound modes

The 640R has several music and home-cinema listening modes available. The output from the 640R will depend both on the source signal present, the speaker setup selected and the decode mode selected on the 640R. Before we describe how to operate the 640R, below is a brief guide to the Surround Sound formats that the 640R is compatible with:

### **Dolby Digital**

Known also as DD (3/2) or DD 5.1, provides (up to) 5.1 output from suitable encoded Dolby Digital material, with 5 main channels (Front Left, Front Right, Centre, Surround Left, Surround Right) and a Low Frequency Effects Channel for the subwoofer, all discretely encoded. Decoding Dolby Digital requires a Dolby Digital encoded DVD disc and a digital connection from the source equipment (Such as a DVD player) to the 640R.

**Note:** Dolby Digital and DTS formats can sometimes carry less channels than their maximum such as Dolby Digital (2/0) which means a Dolby Digital encoded signal which is actually only carrying a two channel stereo signal (other channels inactive).

### **DTS**

Known also as DTS (3/2) or DTS 5.1, DTS provides (up to) 5.1 output from suitable encoded DTS material, with 5 main channels (Front Left, Front Right, Centre, Surround Left, Surround Right) and a Low Frequency Effects Channel for the subwoofer, all discretely encoded. Decoding DTS requires a suitably encoded DTS disc and a digital connection from the source equipment to the 640R.

### **Dolby Digital EX**

Known also as DD (3/3) or DD 6.1, an enhanced form of Dolby Digital. On top of the discretely encoded 5.1 channels DD EX provides an extra 6th channel (Surround Back, giving 6.1) matrix encoded into the rear surrounds for greater image depth and more solid sound localisation behind the listener. DD EX requires a DD EX encoded disc. DD EX is backwards compatible with DD 5.1 decoding. If DD EX is decoded as normal DD the Surround Back signal will be present in both Left and Right Rear Surrounds (forming a phantom rear centre). It can also be decoded as 7.1 by sending the Surround Back decode to both the Surround Back Left and Right speakers (forming two mono Back Surrounds).

### **DTS-ES Matrix**

Known also as DTS (3/3) Matrix, an enhanced form of DTS. On top of the discretely encoded 5.1 channels DTS ES also provides an extra 6th channel (Surround Back giving 6.1), matrix encoded into the rear surrounds for greater image depth and more solid sound localisation behind the listener. DTS ES requires a DTS ES encoded disc. DTS ES material is backwards compatible with DTS 5.1 decoding. If DTS ES is decoded as normal DTS the Surround Back signal will be present in both Left and Right Rear Surrounds (forming a phantom rear centre). It can also be decoded as 7.1 by sending the Surround Back decode to the both the Surround Back Left and Right speakers (forming two mono Back Surrounds).

### **DTS-ES Discrete**

Another enhanced form of DTS, also known as DTS (3/3) Discrete or DTS ES Discrete 6.1. DTS ES Discrete also provides an extra channel (Surround Back) for greater image depth and more solid sound localisation behind the listener, however in this case extra data is included in the bitstream so that all channels are discretely encoded. The Surround Back has greater separation from the other channels than is possible with matrix encoded technologies. DTS-ES Discrete requires a DTS-ES Discrete encoded disc.

DTS ES Discrete is backwards compatible with both DTS 5.1 and DTS ES Matrix 6.1 decoding. If DTS ES Discrete is decoded as normal DTS the Surround Back signal will be present in both Left and Right Rear Surrounds (forming a phantom rear centre). If DTS ES Discrete is decoded with DTS ES Matrix the Surround Back signal will be decoded separately (i.e. as 6.1) but by a matrix process, which will give the same channel separation as if the source disc were actually DTS ES Matrix (but not as good as DTS EX Discrete).

It can also be decoded as 7.1 by sending the Surround Back decode to both the Surround Back Left and Right speakers (forming two mono Back Surrounds).

### **Pro Logic II**

The replacement for original ProLogic, Pro Logic II is a technology where 5 channels (Front Left, Front Right, Centre, Surround Left, Surround Right) are encoded into a Stereo mix by an analog matrix process. Dolby

Pro Logic II material can be played back by normal Stereo equipment (as Stereo) or decoded into 5 channel surround-sound.

Dolby Pro Logic II is compatible with the earlier 4 channel (Left, Centre, Right and mono Surround) Dolby Pro Logic system (which was the decoding counterpart to Dolby Surround encoding) as used widely on Video tapes, TV broadcasts and earlier films.

**Note:** Pro Logic does not include a Low Frequency Effects channel for the Subwoofer, but the 640R can create a Subwoofer output (for 5.1) via Bass management. Refer to the 'Tone/Sub/LFE configuration' section in the 'Operating instructions' part of this manual.

### **Pro Logic IIx**

A newer version of Dolby Pro Logic II which is able to recreate 6 or 7 discrete surround sound channels (with fully stereo Back Surrounds in 7 channel mode) from suitable encoded stereo source material. Pro Logic IIx also has modes for post processing either Stereo material or 5.1 material into 6 or 7 channels whether or not it has been Pro Logic IIx encoded. When 5.1 decoding is required, Dolby Pro Logic II decoding will always be used by the 640R in place of Pro Logic IIx as IIx only works for 6 or 7 channel output.

**Note:** Pro Logic IIx does not include a Low Frequency Effects channel for the Subwoofer, but the 640R can create a Subwoofer output (for 6.1/7.1) via Bass management. Refer to the 'Tone/Sub/LFE configuration' section in the 'Operating instructions' part of this manual.

### **DTS Neo:6**

A DTS technology which is able to recreate 6 channel (Left Front, Right Front, Centre, Left Surround, Right Surround, Surround Back) surround sound from suitable analog matrix encoded stereo source material. DTS Neo:6 material can be played back by normal Stereo equipment (as Stereo) or decoded into 6 channel surround-sound.

**Note:** Neo:6 does not include a Low Frequency Effects channel for the Subwoofer, but the 640R can create a Subwoofer output via Bass management. Refer to the 'Tone/Sub/LFE configuration' section in the 'Operating instructions' part of this manual.

DTS Neo:6 can also be decoded as 7.1 by sending the Surround Back decode to the both the Surround Back Left and Right speakers (forming two mono Back Surrounds).

### **DTS 96/24**

A DTS technology that provides 5.1 channels of 96kHz / 24bit audio (along with video if required) on DVD-Video and DVD-Audio (video zone) discs (when suitably encoded in DTS 96/24). DVD players which allow 'DTS digital out' pass the DTS 96/24 bitstream over S/PDIF for decoding in the 640R.

### **DSP modes**

These modes allow a realistic surround-sound experience from source material that has no encoding at all. The surround sound effect is achieved by Digital Signal Processing of the Analog or Digital stereo source used. Five modes are possible: PassThru, Theater, Hall, Movie and Music.

## Other modes

### **Stereo/Stereo + Sub**

Only the Front Left and Front Right speakers (and subwoofer if selected) have output in this mode. If an analog source is selected it will be converted to digital via 24 bit A/D converters to allow digital domain sub creation and bass/treble controls.

If a digital source is selected the 640R will be processing either LPCM stereo (from the digital outputs of a CD player for instance) or a Stereo downmix of DD or DTS material (from the digital output of a DVD player for instance).

### **Analog Stereo Direct**

Selects the analog inputs for the current source directly with no A/D conversion, DSP processing, Bass/Treble or subwoofer channel active. Provides the very best fidelity for analog Hi-Fi source equipment. In this mode the 640R is acting just like a normal Hi-Fi integrated amplifier.

## Operating instructions

To activate the 640R, switch the Power button on the rear panel to On then press the Standby/On button on the front panel.

### Selecting the source

1. Select the desired source by pushing the corresponding source button on the front panel or remote control.

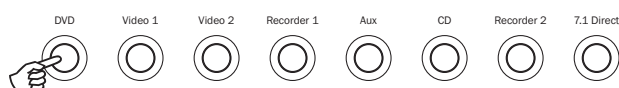

2. If necessary, press the Audio Input Type button to select the input mode of the source equipment, either analog or digital (depending on the connection made on the rear panel).

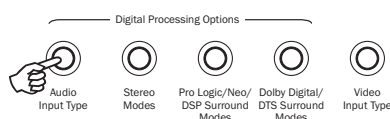

The digital or analog icons on the display show which is the currently selected input type.

**Note:** The 640R stores the input type for each source so that it is automatically recalled when that source is selected again.

### Selecting the desired listening mode

Select an appropriate mode for the source material/type you are listening to by pressing one of the 3 main Digital Processing Options buttons and cycling through sub-modes where available.

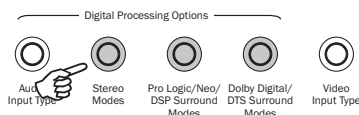

In all cases the first time a mode button is pressed the 640R will report the current decoding mode on the front panel display. Pressing the button again will then cycle to the next available mode (if there is one). If no button is pressed for 4 or 5 seconds the 640R returns to normal operation without changing mode.

**Stereo Modes** - Selects 2 channel Stereo operation for stereo material, pressing again selects Stereo + Sub mode.

This is a digitally processed mode that allows bass and treble controls, and sub generation if required. The input can be either analog (in which case it will be turned into digital by 24 bit A/D conversion) or natively digital.

Digital inputs can be connected to the SPDIF outputs from Tuner's or CD Players etc (LPCM) or the digital outputs of DVD players (set to Bitstream/Raw) playing 2-channel Dolby Digital (2/0) or DTS (2/0) material.

**Prologic/Neo:6/DSP modes** - Selects a range of surround modes with appropriate matrix encoded material.

These modes are for use with the analog or digital outputs from TV's or VCR Players for instance if the source material has been encoded using one of these processes.

ProLogic and Neo:6 are both available in various guises to decode appropriately encoded soundtracks. Additionally DSP modes are available to process sources with no encoding at all. Due to the matrix encoding process none of these modes incorporate flags that tell the 640R the type of encoding used in the source material. Thus you must manually select these modes.

**Dolby Digital EX/DTS ES Modes** - Selects a range of digital surround modes with the appropriately digitally encoded material (only). These modes are for use with the digital outputs (set to Bitstream/Raw) from DVD players or satellite receivers etc. In order for the 640R to allow selection of these modes a valid input digital bitstream must be present. This is because the 640R needs to read the incoming flags in order to determine the type of decoding which can be used and present any options that might be possible.

If no bitstream is present, pressing this button will result in the 640R displaying "Mode Unavailable".

**Note:** The modes available for each button depend both on the Speaker Configuration that has previously been set in the OSD and on the source material.

For 5.1 Speaker setups the Dolby Digital/DTS Surround Modes button will have a maximum of only one mode available which will depend on the source material. See the following 'Decode modes' tables.

The Prologic/ Neo:6/DSP modes button will present more options where possible including Post-Processed modes.

These are modes that allow extra processing to be applied after the main surround-sound decoding. For instance Dolby Digital (2/0) + PLII Music. Which adds a 5.1 ProLogic decode to a Stereo Dolby Digital decode to turn 2 channel stereo into 5.1.

This mode would be accessed by first selecting the Dolby Digital EX / DTS ES Mode button with a Dolby (2/0) bitstream present (selects a normal Dolby Digital (2/0) decode. Now press the Pro Logic/ Neo:6/DSP mode button to access the next mode which adds a PLII decode on top.

For 6.1 or 7.1 Speaker setups, the number of decoding possibilities increases as shown in the following 'Decode modes' tables. Several extra Post Processing modes are available using either Prologic IIx or Neo:6.

**Incoming Dolby Digital/DTS streams are always shown on the front panel display as Dolby Digital (x/x) or DTS (x/x), where the bracketed numbers indicate the active channels in the source material. Active output channels are shown by the icons on the right hand side of the front panel display. Possible incoming DD/DTS types are:**

- (1/0) - Mono, Centre channel only
- (2/0) - Left/Right stereo
- (2/1) - Left/Right stereo and LFE (Sub)
- (2/2) - Left/Right stereo and Left/Right surround
- (3/0) - Left, Centre, Right
- (3/1) - Left, Centre, Right and LFE (Sub)
- (3/2) - 5.1: Left, Right, Centre, Left Surround, Right Surround and LFE (Sub)
- (3/3) - 6.1: Left, Right, Centre, Left Surround, Right Surround, Surround Back and LFE (Sub)

## Decode modes - 5.1 speaker setup



Pro Logic/Neo/  
DSP Surround  
Modes



Dolby Digital/  
DTS Surround  
Modes

Incoming audio format	Native channel resolution	Modes (button cycles round)	Output channels	Modes (button cycles round)	Output Channels
PCM	<b>2</b> (5.1/7.1 if PLII/PLIIX encoded)	PCM + PLII Movie PCM + PLII Music PCM + PLII Game PCM + Neo:6 Cinema PCM + Neo:6 Music PassThru Movie Music Room Theatre Hall	>5.1 >5.1 >5.1 >5.1 >5.1 >5.1 ■ >5.1 ■ >5.1 ■ >5.1 ■ >5.1 ■ >5.1 ■	PCM	<b>2</b> ◆
Dolby Digital (2/0)	<b>2</b>	Dolby Digital (2/0) + PLII Movie Dolby Digital (2/0) + PLII Music Dolby Digital (2/0) + PLII Game	>5.1 >5.1 >5.1	Dolby Digital (2/0)	<b>2</b>
Dolby Digital (3/2)	<b>5.1</b>			Dolby Digital (3/2)	<b>5.1</b>
Dolby Digital EX (3/3)	<b>6.1</b>			Dolby Digital EX (3/3)	5.1<
DTS (2/0)	<b>2</b>			DTS (2/0)	<b>2</b>
DTS (3/2)	<b>5.1</b>			DTS (3/2)	<b>5.1</b>
DTS ES Matrix (3/3)	<b>6.1</b>			DTS ES Matrix (3/3)	5.1<
DTS ES Discrete (3/3)	<b>6.1</b>			DTS ES Discrete (3/3)	5.1<
DTS 96/24 (3/2)	<b>5.1</b>			DTS 96/24	<b>5.1</b>

### Key

- 5.1< Indicates a 5.1 decode of 6.1 material (phantom back centre).
- >6.1 Indicates 6.1 output created by a 2.0 or 5.1 decode, post-processed to 6.1.
- >7.1 Indicates 7.1 output created by a 2.0, 5.1 or 6.1 decode, post-processed to 7.1.
- >6.1< Indicates 6.1 output created from 6.1 material, decoded as 5.1 and then post-processed to 6.1.
- >7.1< Indicates 7.1 output from 6.1 material decoded as 5.1 and then post processed to 7.1.
- Mode used to force 6.1 or 7.1 EX or ES decoding where the decoder detects a disc as only 5.1 encoded but it is known to actually be EX/ES encoded (i.e. the EX or ES flags are missing from the disc). Note however that the processor cannot create ES/EX output from 5.1 encoded discs, this mode is only for when the flags are missing. To create 6.1/7.1 from a 5.1 disc use a post processed mode instead as shown above.
- ▲ 7.1 decode of material with 6.1 encoded channels, two Mono Back Surrounds created from single Back Centre Surround Channel.
- ◆ Stereo or Stereo + Sub, Press Stereo Modes Button to change.
- Digital Signal Processing created modes for signals with no encoding.

**Note:** Bold entries are being output in their native resolution/format.

In all cases, pressing the Stereo Modes button always cycles round:

Stereo Modes	Output channels
Stereo	2
Stereo + Sub	2.1

Either native Stereo or downmix of DD/DTS 5.1/6.1 etc.

**Pressing a mode button will first cause the 640R to scroll the current decode mode across the front panel display. Pressing the mode button again whilst text is scrolling on the display or within 4 seconds of it finishing will select and display the next available mode.**

## Decode modes - 6.1 speaker setup



Pro Logic/Neo/  
DSP Surround  
Modes



Dolby Digital/  
DTS Surround  
Modes

Incoming audio format	Native channel resolution	Modes (button cycles round)	Output channels	Modes (button cycles round)	Output Channels
PCM	2 (5.1/7.1 if PLII/PLIIX encoded)	PCM + PLIIX Movie PCM + PLIIX Music PCM + PLIIX Game PCM + Neo:6 Cinema PCM + Neo:6 Music PassThru Movie Music Room Theatre Hall	>6.1 >6.1 >6.1 >6.1 >6.1 >6.1 ■ >6.1 ■ >6.1 ■ >6.1 ■ >6.1 ■ >6.1 ■ >6.1 ■	PCM	2 ◆
Dolby Digital (2/0)	2	Dolby Digital (2/0) + PLIIX Movie Dolby Digital (2/0) + PLIIX Music Dolby Digital (2/0) + PLIIX Game	>6.1 >6.1 >6.1	Dolby Digital (2/0)	2
Dolby Digital (3/2)	5.1	Dolby Digital (3/2) + PLIIX Movie Dolby Digital (3/2) + PLIIX Music	>6.1 >6.1	Dolby Digital (3/2) Dolby Digital (3/2) + EX	5.1 >6.1 ●
Dolby Digital EX (3/3)	6.1	Dolby Digital (3/3) + PLIIX Movie Dolby Digital (3/3) + PLIIX Music	>6.1< >6.1<	Dolby Digital EX (3/3)	6.1
DTS (2/0)	2	DTS (2/0) + PLIIX Movie DTS (2/0) + PLIIX Music DTS (2/0) + Neo:6 Cinema DTS (2/0) + Neo:6 Music	>6.1 >6.1 >6.1 >6.1	DTS (2/0)	2
DTS (3/2)	5.1	DTS (3/2) + PLIIX Movie DTS (3/2) + PLIIX Music DTS (3/2) + Neo:6 Cinema DTS (3/2) + Neo:6 Music	>6.1 >6.1 >6.1 >6.1	DTS (3/2) DTS (3/2) + ES Matrix	5.1 >6.1 ●
DTS ES Matrix (3/3)	6.1	DTS ES Matrix (3/3) + PLIIX Movie DTS ES Matrix (3/3) + PLIIX Music DTS ES Matrix (3/3) + Neo:6 Cinema DTS ES Matrix (3/3) + Neo:6 Music	>6.1< >6.1< >6.1< >6.1<	DTS ES Matrix (3/3)	6.1
DTS ES Discrete (3/3)	6.1	DTS ES Discrete (3/3) + PLIIX Movie DTS ES Discrete (3/3) + PLIIX Music DTS ES Discrete (3/3) + Neo:6 Cinema DTS ES Discrete (3/3) + Neo:6 Music	>6.1< >6.1< >6.1< >6.1<	DTS ES Discrete (3/3)	6.1
DTS 96/24 (3/2)	5.1			DTS 96/24	5.1



## Decode modes - 7.1 speaker setup



Pro Logic/Neo/  
DSP Surround  
Modes

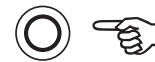

Dolby Digital/  
DTS Surround  
Modes

Incoming audio format	Native channel resolution	Modes (button cycles round)	Output channels	Modes (button cycles round)	Output Channels
PCM	<b>2</b> (5.1/7.1 if PLII/PLIIX encoded)	PCM + PLIIX Movie PCM + PLIIX Music PCM + PLIIX Game PCM + Neo:6 Cinema PCM + Neo:6 Music PassThru Movie Music Room Theatre Hall	>7.1 >7.1 >7.1 >5.1 >5.1 >7.1 ■ >7.1 ■ >7.1 ■ >7.1 ■ >7.1 ■ >7.1 ■ >7.1 ■	PCM	<b>2</b> ◆
Dolby Digital (2/0)	<b>2</b>	Dolby Digital (2/0) + PLIIX Movie Dolby Digital (2/0) + PLIIX Music Dolby Digital (2/0) + PLIIX Game	>7.1 >7.1 >7.1	Dolby Digital (2/0)	<b>2</b>
Dolby Digital (3/2)	<b>5.1</b>	Dolby Digital (3/2) + PLIIX Movie Dolby Digital (3/2) + PLIIX Music	>7.1 >7.1	Dolby Digital (3/2) Dolby Digital (3/2) + EX	<b>5.1</b> >7.1 ● ▲
Dolby Digital EX (3/3)	<b>6.1</b>	Dolby Digital (3/3) + PLIIX Music Dolby Digital (3/3) + PLIIX Movie	>7.1< >7.1<	Dolby Digital EX (3/3) Dolby Digital EX (3/3)	<b>6.1</b> <b>7.1</b> ▲
DTS (2/0)	<b>2</b>	DTS (2/0) + PLIIX Movie DTS (2/0) + PLIIX Music DTS (2/0) + Neo:6 Cinema DTS (2/0) + Neo:6 Music	>7.1 >7.1 >7.1 ▲ >7.1 ▲	DTS (2/0)	<b>2</b>
DTS (3/2)	<b>5.1</b>	DTS (3/2) + PLIIX Movie DTS (3/2) + PLIIX Music DTS (3/2) + Neo:6 Cinema DTS (3/2) + Neo:6 Music	>7.1 >7.1 >7.1 ▲ >7.1 ▲	DTS (3/2) DTS (3/2) + ES Matrix	<b>5.1</b> >7.1 ● ▲
DTS ES Matrix (3/3)	<b>6.1</b>	DTS ES Matrix (3/3) + PLIIX Movie DTS ES Matrix (3/3) + PLIIX Music DTS ES Matrix (3/3) + Neo:6 Cinema DTS ES Matrix (3/3) + Neo:6 Music	>7.1< >7.1< >7.1< ▲ >7.1< ▲	DTS ES Matrix (3/3) DTS ES Matrix (3/3)	<b>6.1</b> <b>7.1</b> ▲
DTS ES Discrete (3/3)	<b>6.1</b>	DTS ES Discrete (3/3) + PLIIX Movie DTS ES Discrete (3/3) + PLIIX Music DTS ES Discrete (3/3) + Neo:6 Cinema DTS ES Discrete (3/3) + Neo:6 Music	>7.1< >7.1< >7.1< ▲ >7.1< ▲	DTS ES Discrete (3/3) DTS ES Discrete (3/3)	<b>6.1</b> <b>7.1</b> ▲
DTS 96/24 (3/2)	<b>5.1</b>			DTS 96/24	<b>5.1</b>



## Operating instructions continued

### Dynamic Range Control

This setting controls the dynamic range of Dolby Digital or DTS movie soundtracks by compressing the dynamics in four stages to limit the difference in level between loud and quiet passages in the movie.

This can be a useful feature when watching movies late at night for instance. Four settings are possible:

DRC=0/4 No Compression (normal full dynamic range playback)

DRC=1/4

DRC=2/4

DRC=3/4

DRC=4/4 Greatest Compression (reduced dynamic range playback)

DRC can be accessed by the Dynamic button on the remote, DRC=0/4 etc is displayed, pressing the button again moves to the next setting. When finished make no adjustment for a few seconds and the 640R will save the settings and exit the menu.

**Note:** DRC only works for Dolby Digital or DTS source material which supports this feature.

### ProLogic IIx adjustments

The following adjustments affect Dolby Prologic II or IIx processing (or post-processing) in Music mode only. Movie and Game modes where available are preset as part of their specification to match the encoding or provide a specific effect. These adjustments have no affect in these modes.

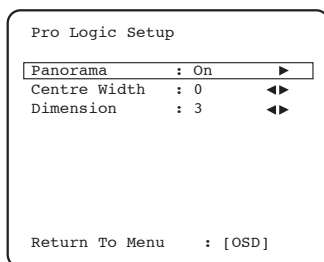

**Panorama mode** - A Prologic II/IIx mode that extends the front Stereo image to the surround sound speakers for a more enveloping experience. This mode can be either On or Off.

**Centre Width** - Allows gradual adjustment of the centre image from being produced only by the Centre speaker (Setting 0) through levels of being spread between the centre channel and Left and Right speakers to finally being produced by the Front Left and Right speakers only (Phantom Centre, Setting 7). Useful in optimising the Front/Centre/Right soundfield for best integration of the 3 speakers. Best tuned by ear.

**Dimension** - Adjusts the soundfield to be gradually shifted from the front of the room to the back to suit taste, speaker positioning and size of room. Setting 0 has the image furthest forward, 6 furthest back.

All three adjustments are a matter of personal preference, experiment for the settings that you prefer if you are using PLII or PLIIx decoding.

### Using the Tuner

1. Press the *Tuner FM/AM* button on the front panel or remote control to select Tuner mode.
2. Press the *Tuner FM/AM* button again to select FM or AM if desired.
3. Press the *Mode/Store* button on the front panel (or *Mode* button on the remote control) to select automatic tuning, manual tuning or preset mode.
4. Press the *Tuning +* and *Tuning -* buttons (or the left and right arrow buttons on the remote) to select the station you want to listen to.

In automatic tuning mode the unit scans to the next strong station. In manual tuning mode the user can step manually through the frequencies. In preset mode the unit cycles through the presets only.

Two FM modes are available, stereo and mono - Press the *Stereo Mono* button on the remote to alternate between Stereo mode and Mono mode. If the *Display* button is pressed, the RDS station names of FM stations will be displayed if available.

### Storing stations

1. Tune in a station you wish to store as explained previously.
2. Press and hold the *Mode/Store* button (or *Mode* button on the remote) for 5 seconds to bring up the "MEM" icon.
3. Use the *Tuning +/-* buttons to select a preset station number (1-15). The station number will be displayed on the screen.
4. Press the *Mode/Store* button (or *Mode* button on the remote) to memorise, while the "MEM" icon is still flashing.

### Radio Data Systems (RDS)

RDS is a method for the transmission of additional information from local radio stations. It is only available in FM mode. RDS will only work if the local broadcasting stations have RDS transmission and the signal is strong enough.

Press the *Display* button on the remote and go through the displayed functions. There are functions for PS, PTY, CT and RT:

PS (Station Name) - current station name will be shown

PTY (Program Type) - current name type of the program will be shown

CT (Clock/Time) - current time from Radio Station will be displayed.

**Note:** Clock/Time will be only transmitted from local radio station once a minute. If the Clock - Time is not available the message "NO CT" will appear briefly on the display.

RT (Radiotext) - some Text messages will be shown.

### Program Type Search (PTY)

1. Press the *PTY* button on remote control, "PTY SELECT" will flash on the display.
2. Press *Tuning +/-* to choose the program type, for example NEWS or SPORT.
3. Press the *PTY* button again once you have chosen the program type.

When the selected type of program is tuned in, it will stop searching, otherwise, PTY Search will timeout after approximately 30 seconds.

### Auto Program Search (APS)

1. Press the *Tuner FM/AM* button to select the AM or FM band.
2. Press the *APS* button on the remote to begin the automatic program search through available stations. The searched stations will be memorised in the respective band memory (maximum of 15 stations).

## Audio split mode

The 640R is able to allow the user to listen to one source whilst viewing another. For instance this can be useful if it is desired to watch a sports channel from say a set-top/satellite video source whilst getting audio commentary from the Radio Tuner. Another example might be to listen to a CD whilst watching a video channel, perhaps waiting for a TV programme to start.

First select the Video channel you wish to watch in the normal way. Now press and hold down the button for the channel you wish to listen to. After 4 seconds approx "Audio Split" will scroll across the display and you will now be listening to the other source.

To cancel audio split mode simply select a new source and normal operation will be resumed.

## Recorder 1 / 2

Recorder 1 as well as having various video and audio inputs has recording outputs for Composite video, S-Video, digital audio and analog audio. Whatever source is selected for viewing/listening via the main outputs will also be automatically sent to the Recorder 1 outputs for recording purposes. Recorder 1 would typically be used for a DVD-R/RW, VCR or other device with audio and video recording capability.

Recorder 2 has analog and digital audio outputs only. Additionally the Recorder 2 outputs are completely independent from the main listening and Recorder 1 outputs and are separately set in the OSD.

This means it's possible to watch (and optionally record via Rec 1) one source whilst recording another source via Rec 2. Recorder 2 would typically be used with a Tape/MD/CD-R machine with audio recording capability.

Select the 'Rec.2 Output Select' menu and press *Enter*. Use the *Left* and *Right* arrows to set the audio source for the Rec.2 Output:

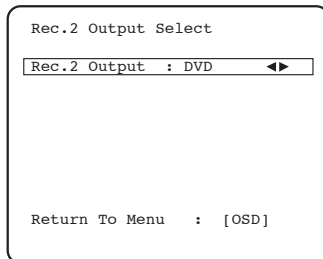

## Tone/Sub/LFE configuration

Select the 'Tone/Sub/LFE' menu:

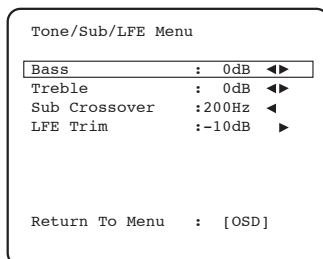

The Bass response can be adjusted +/- 10dB @ 100Hz (shelving). The Treble response can be adjusted +/-10dB @ 10kHz (shelving). The "Tone" icon will light up on the display if these controls are adjusted away from 0dB (flat). The Subwoofer crossover point can also be adjusted from 40 to 150Hz in 10Hz steps and also to 200Hz.

As covered in the "640R overview" section the 640R performs bass management for any speaker that is set to 'Small' in the OSD. This means that bass for speakers that are unable to reproduce it effectively is instead routed to the subwoofer.

The crossover adjustment in the LFE trim menu is used to determine the point as which this transition is made. In other words it sets the frequency below which bass is routed away from any 'Small' speakers and into the Subwoofer channel. It should be understood that bass sent to the subwoofer by bass management is different to bass encoded into the surround-sound material as a dedicated Low Frequency Effects channel.

If the source material contains a separate LFE channel (such as DD or DTS material) this is always routed to the subwoofer (if it is On) and is not affected by the crossover setting. Some encoding types (Such as Dolby PLII/IIx and Neo:6) do not actually have a LFE channel.

This means that if all the Speakers in your setup were set to Large, the subwoofer will in fact be inactive for these types. If it is desired to have the subwoofer running with these encoding types, all that is necessary is to set some speakers to 'Small' and then set the Crossover point to a suitable frequency by ear.

Remember that 'Small' does not mean the speaker is actually small. All it means is that if you wish the processor to perform bass management on it and re-direct low frequency energy away from the speaker at some point to the subwoofer. The crossover will then determine the point at which this happens. Thus it might not be unlikely to have physically large speakers that can reproduce good bass, but to set them to 'Small' in the OSD and then set a low (40-50Hz) Sub Crossover point so that only very low bass is directed away from them and to the Subwoofer channel.

As with all adjustments it is a good idea to experiment to determine what works and sounds best with your particular setup

**Note:** These adjustments work in all digitally processed Stereo or Surround modes but not in Analog Stereo Direct or 7.1 Direct modes.

The Sub/LFE channel can also be trimmed by up to 10dB in 1dB steps useful for late night listening or other situations where it might be desired to reduce the sub level perhaps temporarily.

**Bass/Treble adjustments can also be made from the remote without entering the OSD by pressing the Bass/Treble button and then using the Vol Up/Down buttons.**

**LFE Trim adjustments can also be made from the remote without the OSD by holding down the Sub On/Off button and using the Vol Up/Down buttons whilst it is kept down.**

## Input naming

If desired it is possible to customise the names shown on the front panel display for each source. Enter the OSD and select the 'Input Name Assign' menu. Use the *Left* and *Right* arrows to select the source you wish to edit (CD, DVD etc) then press *Enter*:

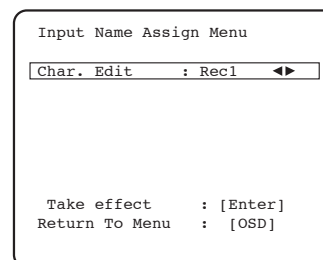

Use the *Vol Up*, *Vol Down*, *Left* and *Right* buttons to move around the character edit screen to select the required characters, press enter to move to the next character. Selecting the *<*- and *->* arrows at the bottom of the screen and pressing *Enter* also moves the currently edited character left or right.

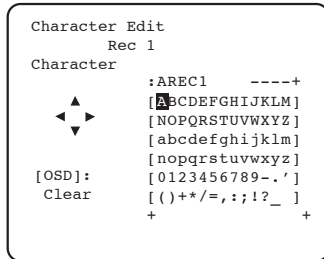

Once finished select 'OK' and press *Enter* to exit and save. Pressing the OSD button will exit the menu and discard any changes.

**Note:** The original names can be recalled by resetting the unit, see the Reset section at the end of this manual.

**Note:** If it is desired to have OSD video overlay for Component video sources simply make a Composite video connection for each Component video source to the 640R as well.

The OSD can also be shown in several different languages. To change the OSD language highlight the 'Language' menu and use the *Left* and *Right* arrows to select between English, Dutch, French, German, Spanish, Italian, Norwegian, Swedish and Danish. Press the OSD button again to exit and save the options.

## OSD setup

On-Screen Display is available on the Composite, S-Video and Component video outputs (not available on HDMI). The OSD can be shown either on a blue background or overlaid on the analog video. Select the 'OSD Setup' menu, select the 'Background' menu and use the *Left* and *Right* arrows to select between 'Blue' and 'Video' backgrounds:

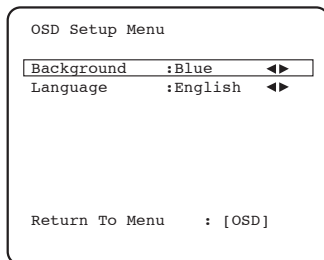

In Video Background mode the 640R will automatically use the Composite or S-Video source for background video when selected, however due to a limitation in the OSD chip it cannot directly overlay OSD on Component video. Instead for Component sources the 640R uses the equivalent Composite input for background video, adds the OSD and then transcodes the output to Component. The Composite feed is used purely when the OSD is on, when the OSD is off the Component inputs will be switched directly to the TV so that there is no loss of picture quality.

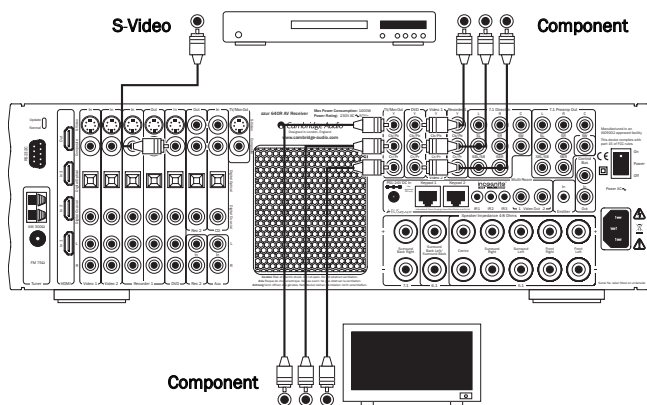

## Multi-room connections

The 640R features Incognito Ready™ / A-BUS™ Ready outputs, allowing multi-room capability. One or two amplified keypads can be plugged into the 640R (using Cat5/5e cable and RJ45 plugs) to provide multi-room audio in one or two secondary rooms or zones. The keypads are powered by an external PSU (also required) through the Cat5/5e cables and no mains connection is required in the secondary rooms.

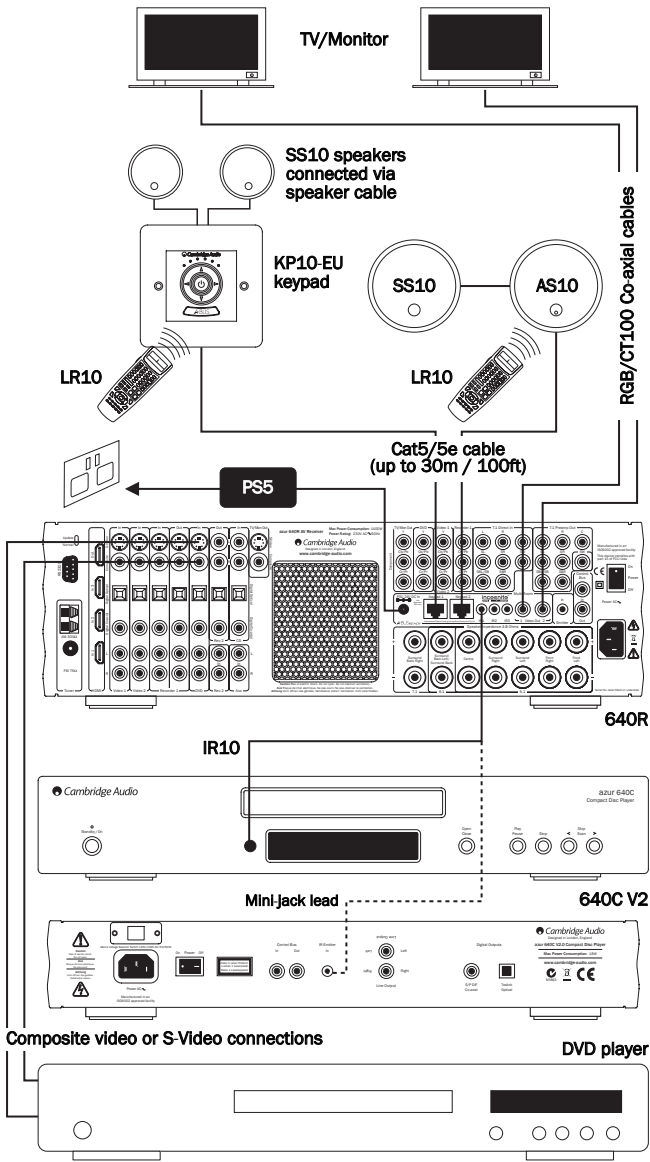

The 640R is Incognito Ready Type II, which means the keypads can operate independently of the amplifier in terms of volume/bass/treble etc, be independently turned on and off from the 640R and each other, and can also listen to a different source from that which is currently selected on the amplifier. However, both keypads can only listen to the same source.

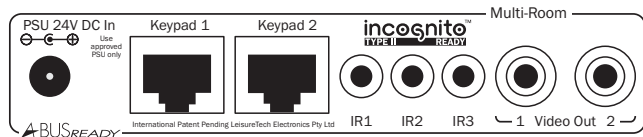

The 640R also features 2nd/3rd zone Composite video outputs which optionally allow the extra zones to have video capability. The 640R can use either Composite video or S-Video inputs as sources to supply the sub-zones, but not from Component or HDMI inputs. **Note:** If it is desired to use Component or HDMI for the main zone, the source should also be connected to the 640R by Composite or S-Video for the 2nd/3rd zone video output.

A-BUS is a standard that allows compatibility between different manufacturers equipment, so A-BUS compatible keypads from other manufacturers can also be used. If used with our own Incognito KP10 keypads, there are some extra features such as the ability to change source on the 640R from the keypad.

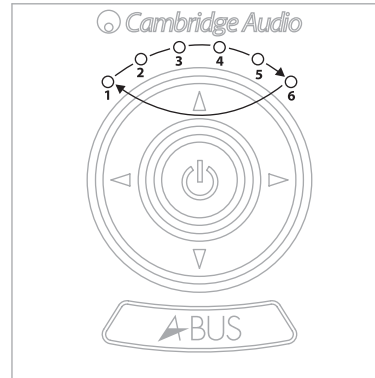

Order of selection:

1. Tuner
2. CD
3. DVD
4. Video 1
5. Video 2
6. Rec 1

Local 1 - Aux\*

Local 2 - Rec 2\*

\*Local source selection must be enabled on the keypad.

Connections to the 640R's Incognito Ready™ / A-BUS™ Ready outputs are made by Cat-5 cable (terminated with an RJ45 jack plug). The RJ45 plug must be wired to the EIA/TIA 568A wiring standard:

Wire colours:

1. Green/White
2. Green

3. Orange/White

4. Blue
5. Blue/White

6. Orange

7. Brown/White
8. Brown

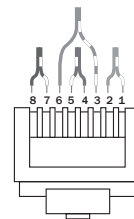

Plug view from contact end

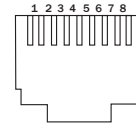

View into socket



Gather pairs, trim and insert into RJ45 plug

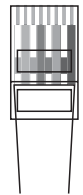

Crimp wires securely in place

To allow control of your source equipment from the remote rooms an IR emitter (IR10) is plugged into one of the IR outputs on the rear of the unit and then attached over the IR window of the source unit. Alternatively, on our own products that feature IR emitter Inputs, a mini-jack to mini-jack lead can be used. Commands received by the keypads can now be sent back to the source equipment via the 640R.

It is then possible to control the source equipment from the remote rooms by using the source equipment's own remote controls or through a learning remote. The Incognito LR10 can fully control the keypads, "learn" the source's remote control codes (including those from other manufacturers) and change source input on the 640R etc.

For further details on the Incognito multi-room system please contact your local Cambridge Audio dealer or visit [www.cambridge-audio.com](http://www.cambridge-audio.com).

## Custom installation (C.I.) use

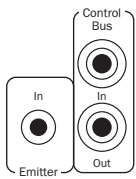

The 640R features Control Bus inputs and outputs that allow un-modulated remote control commands (positive logic, TTL level) to be received electrically by the unit. These control commands are typically generated by custom installation (multi-room) systems or remote IR receiver systems. The Control Bus sockets are colour-coded orange.

An IR Emitter Input is also provided that allows modulated IR remote control commands to be received electrically by the unit. Commands on this input operate the unit only and are not looped out demodulated on the Control Bus Output. An RS232 port is also featured which allows the 640R to be controlled by C.I. systems.



In addition the unit features 'direct' IR/Control codes as well as toggle codes for some of their features to simplify programming custom installation systems. Special direct On/Off and Mute commands can be accessed on the supplied remote control for teaching into C.I. systems as follows:

1. Press and hold the *Standby/On* button on the remote control. The remote first generates it's standby (toggle) command. Keep the button held down, after 12 seconds an AV receiver "On" command will be generated. If the button is kept held down for a further 12 seconds, an AV receiver "Off" command is generated.

Repeat this procedure with the Mute, Sub On/Off, Stereo Mono and Tuner AM/FM buttons to send On/Off commands. The Tuner AM/FM button also provides unique FM and AM commands to allow switching to a specific band.

A full code table and RS232 protocol for this product is available on the Cambridge Audio website at [www.cambridge-audio.com](http://www.cambridge-audio.com).

## Reset/Back-up memory

The 640R has a function that preserves the preset memory and other settings. In the event of a power failure, or if the power cord of the unit is disconnected from the mains outlet, the back-up memory will preserve the preset memory for approximately one week. If the power supply is interrupted for 7 days or longer, the memory settings will be erased.

If it is desired to reset all settings to their factory defaults (or in the unlikely event that the unit locks up due to an electrical discharge etc), with the unit on and out of Standby mode press and hold the *DVD* and *Analog Stereo Direct* buttons on the front panel for three seconds.

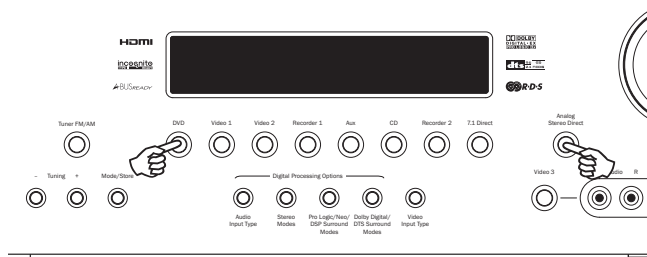

"RESET" will appear briefly on the front panel display before returning to Standby mode.

## Troubleshooting

### A low hum or buzz sound can be heard

Power cords or lighting placed near this product.  
Analog inputs not connected securely.

### Sound is not audible from one channel

Speaker connections disconnected.  
Speaker set to "None" in OSD setup menu.

### Sound cuts off when listening to music or there is no sound even though power is ON

Speaker impedance is less than prescribed for the 640R.  
The unit is not adequately ventilated and may be overheating.

### Low bass or "phasey" response

Speaker polarity (+/-) of one or more speakers is reversed.

### An unusual hissing noise is heard when listening to a radio broadcast in stereo, but not heard when listening in mono

A slight noise may be heard because the method used for modulation of FM stereo broadcasts is different than that used for mono broadcasts.

Aerial quality also effects the level of hiss heard.

### Noise is excessive in both stereo and monaural radio broadcasts

Poor location and/or direction of the antenna.  
Transmitting station is too far away.

### No sound from the rear speakers

Source being played is not recorded in surround sound.  
Speaker/s set to "None" in OSD setup menu.  
A stereo mode has been selected.

### No sound from the centre speaker

Centre speaker has been set to "None" in OSD setup menu.  
A stereo mode has been selected.

### No sound from the subwoofer

Sub has been set to 'Off' in the OSD setup menu or via the remote.

DTS Neo:6, DD PLII/IIX modes (which have no LFE channel) have been selected with all speakers set to "Large".

### Remote control is not working

The batteries are flat.  
The remote is too far from the receiver or out of the effective range.

### No sound from speakers when connected to a digital input

Audio input type is set to analogue (check display). Press the *Audio Input Type* button to switch to digital.

### No sound from speakers when connected to an analogue input

Audio input type is set to digital. Press the *Audio Input Type* button to switch to analogue (check display).

Audio input type can also be set in the Input/Output Setup menu of the OSD.



## Technical specifications

### Audio

<b>Power Output</b>	2 x 120 watts rms per channel, 8 ohms (two channels driven)
	7 x 100 watts rms per channel, 8 ohms (all 7 channels driven)
<b>THD</b>	<0.006% @1kHz
<b>Crosstalk</b>	<-60dB @ 1kHz
<b>Frequency response</b>	10Hz - 20kHz -1dB
<b>S/N Ratio</b>	>90dB 'A' weighted
<b>Audio Input Impedance / Sensitivity</b>	47kOhms / 175mV or greater
<b>Digital Input Impedance</b>	75ohms (Coaxial/SPDIF)
<b>Tone Control</b>	
- Bass	+/-10dB @ 100Hz
- Treble	+/-10dB @ 10kHz
<b>Tuner</b>	
- FM mode	87.5-108MHz, 75 ohm coaxial aerial
- AM mode	522-1629kHz, 300 ohm loop aerial

### Video

<b>Video Levels /Impedance</b>	
- Composite (CVBS)	1Vp-p / 75ohm
- S-Video (S-VHS)	Y 1Vp-p / 75ohm C 0.286 Vp-p / 75ohm
- Component	Y 1Vp-p / 75ohm Cb/Cr 0.75Vp-p / 75ohm Pb/Pr 0.75Vp-p / 75ohm

### HDMI

Transfer of all resolutions up to and including 1080p @ 50/60Hz (1920 x 1080) supported, with HDCP handshaking.

### General

<b>Architecture</b>	Crystal CS43122 24 Bit 192kHz capable DAC for Front Left & Right
	Crystal CS52526 24 Bit 192kHz capable CODEC for surround channels + 24 Bit 2 channel A/D conversion
	Crystal CS43122 32 bit DSP
<b>Audio Inputs</b>	8 Line Level Analog Tuner (FM/AM) 7.1 Analog Input 5 Digital Co-axial, 6 Digital Optical
<b>Video Inputs</b>	5 Composite, 5 S-Video, 3 Component Video, 3 HDMI
<b>Main Audio Outputs</b>	7 Amplified Speaker Outputs 7.1 Preamp outputs
<b>Main Video Outputs</b>	1 Composite, 1 S-Video, 1 Component Video, 1 HDMI
<b>Recording Audio Outputs</b>	2 Line Level Analog 2 Digital Co-Axial, 2 Digital Optical

**Recording Video Outputs** 1 Composite, 1 S-Video

**Other connections**  
1 1/4" / 6.35mm Headphone Output (32 To 600 ohms recommended)  
1 Control Bus Input / Ouput  
1 IR Emitter In  
1 RS232C  
1 IEC type mains inlet

### Incognito Ready™ / A-BUS Ready™

2 A-BUS keypad outputs (2nd/3rd Zone)  
3 IR Emitter outputs  
2 Composite video outputs (2nd/3rd Zone)  
1 External PSU input 24VDC

**Standby power consumption** <10w

**Quiescent power consumption** <70w

**Max power consumption** 1400w

**Dimensions - H x W x D** 150 x 425 x 420mm  
(inc all terminals & controls)

**Weight** 15kg (33lbs)

### Decoding modes supported

#### PCM

Stereo Linear PCM with or without digitally created Sub, 16-24 bit data, 44.1, 48 or 96kHz

#### PLII Movie

5.1 PLII matrix decode optimised for movie material

#### PLII Music

5.1 PLII matrix decode optimised for music material

#### PLII Game

5.1 PLII matrix decode optimised for game material

#### PLIIX Movie

6.1 /7.1 PLIIX matrix decode optimised for movie material

#### PLIIX Music

6.1 /7.1 PLIIX matrix decode optimised for music material

#### PLIIX Game

6.1 /7.1 PLIIX matrix decode optimised for game material

#### Dolby Digital Stereo (2/0) + PLII Movie

5 .1 PLII matrix decode of Dolby Stereo material

#### Dolby Digital Stereo (2/0) + PLII Music

5.1 PLII matrix decode of Dolby Stereo material

#### Dolby Digital Stereo (2/0) + PLII Game

5 .1 PLII matrix decode of Dolby Stereo material

#### Dolby Digital Stereo (2/0) + PLIIX Movie

6 .1/7.1 PLIIX matrix decode of Dolby Stereo material

#### Dolby Digital Stereo (2/0) + PLIIX Music

6 .1/7.1 PLIIX matrix decode of Dolby Stereo material

#### Dolby Digital Stereo (2/0) + PLIIX Game

6 .1/7.1 PLIIX matrix decode of Dolby Stereo material

#### Dolby Digital

(Up to) 5.1 digital surround sound

#### Dolby Digital + PLIIX Movie

PLIIX Movie post process of DD 5.1 giving 6.1 or 7.1 (7.1 has mono back surrounds)

#### Dolby Digital + PLIIX Music

PLIIX Music post process of DD 5.1 giving 6.1 or 7.1 (7.1 has mono back surrounds)

#### Dolby Digital EX

6.1 or 7.1 (7.1 has mono back surrounds) decode of 6.1 Dolby Digital EX material

#### DTS Neo:6 Cinema

5.1/6.1/7.1 Neo:6 matrix decode (6.1 source material) 5.1 decode has phantom rear centre, 7.1 decode has mono back surrounds)

**DTS Neo:6 Music**

5.1/6.1/7.1 Neo:6 matrix decode (6.1 source material, 5.1 decode has phantom rear centre, 7.1 decode has mono back surrounds)

**DTS Stereo (2/0) + DTS Neo:6 Cinema**

5.1/6 .1/7.1 Neo:6 matrix decode of DTS Stereo material (7.1 has mono back surrounds)

**DTS Stereo (2/0) + DTS Neo:6 Music**

5.1/6 .1/7.1 Neo:6 matrix decode of DTS Stereo material (7.1 has mono back surrounds)

**DTS Stereo (2/0) + PLIIx Movie**

5.1/6 .1/7.1 PLIIx matrix decode of DTS Stereo material

**DTS Stereo (2/0) + PLIIx Music**

5.1/6 .1/7.1 PLIIx matrix decode of DTS Stereo material

**DTS**

(Up to) 5.1 digital surround sound

**DTS ES Matrix**

6.1 or 7.1 decode of 6.1 DTS ES Matrix material (7.1 has mono back surrounds)

**DTS ES Discrete**

6.1 or 7.1 decode of 6.1 DTS ES Discrete material (7.1 has mono back surrounds)

**DTS + Neo: 6 Cinema**

Neo:6 Cinema post process of DTS 5.1 giving 6.1 or 7.1 (7.1 has mono back surrounds)

**DTS + Neo: 6 Music**

Neo:6 Music post process of DTS 5.1 giving 6.1 or 7.1 (7.1 has mono back surrounds)

**DTS + PLIIx Movie**

PLIIx Movie post process of DTS 5.1 giving 6.1 or 7.1 (7.1 has mono back surrounds)

**DTS + PLIIx Music**

PLIIx Music post process of DTS 5.1 giving 6.1 or 7.1 (7.1 has mono back surrounds)

**DTS ES Matrix/Discrete + Neo: 6 Cinema**

Neo:6 Cinema post process of DTS ES 6.1 giving 6.1 or 7.1 (7.1 has mono back surrounds)

**DTS ES Matrix/Discrete + Neo: 6 Music**

Neo:6 Music post process of DTS ES 6.1 giving 6.1 or 7.1 (7.1 has mono back surrounds)

**DTS ES Matrix/Discrete + PLIIx Movie**

PLIIx Movie post process of DTS ES 6.1 giving 6.1 or 7.1

**DTS ES Matrix/Discrete + PLIIx Music**

PLIIx Music post process of DTS ES 6.1 giving 6.1 or 7.1

**DTS 96/24**

5.1 discrete audio

**PassThru, Movie, Music, Room, Theater & Hall**

5.1/6.1/7.1 DSP effects

This guide is designed to make installing and using this product as easy as possible. Information in this document has been carefully checked for accuracy at the time of printing; however, Cambridge Audio's policy is one of continuous improvement, therefore design and specifications are subject to change without prior notice. If you notice any errors please feel free to email us at: support@cambridgeaudio.com

This document contains proprietary information protected by copyright. All rights are reserved. No part of this manual may be reproduced by any mechanical, electronic or other means, in any form, without prior written permission of the manufacturer. All trademarks and registered trademarks are the property of their respective owners.

Incognito and Incognito Ready are trademarks of Cambridge Audio Ltd. All rights reserved.

© Copyright Cambridge Audio Ltd 2007

"Dolby", "Pro Logic", "Surround EX" and the double-D symbol are trademarks of Dolby Laboratories.

"DTS", "DTS Digital Surround", "DTS-ES", "96/24" and "Neo:6" are trademarks of Digital Theater Systems, Inc.

HDMI, the HDMI logo and High-Definition Multimedia Interface are trademarks or registered trademarks of HDMI Licensing LLC.

A-BUS and A-BUS Ready are registered trademarks of LeisureTech Electronics Pty Ltd Australia.



Cambridge Audio  
Gallery Court  
Hankey Place  
London SE1 4BB  
England

[www.cambridge-audio.com](http://www.cambridge-audio.com)

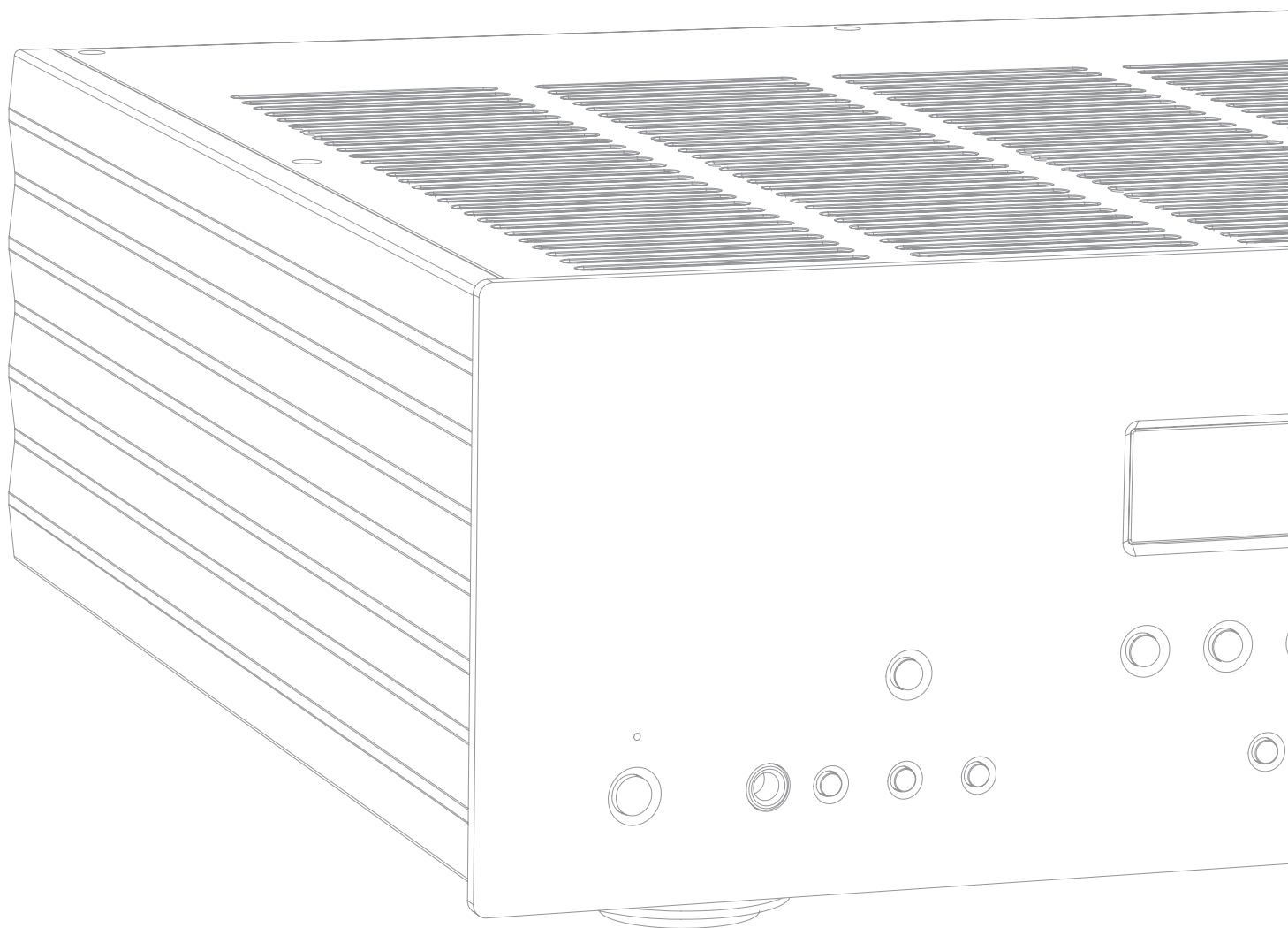

© 2007 Cambridge Audio Ltd

## Free Manuals Download Website

<http://myh66.com>

<http://usermanuals.us>

<http://www.somanuals.com>

<http://www.4manuals.cc>

<http://www.manual-lib.com>

<http://www.404manual.com>

<http://www.luxmanual.com>

<http://aubethermostatmanual.com>

Golf course search by state

<http://golfingnear.com>

Email search by domain

<http://emailbydomain.com>

Auto manuals search

<http://auto.somanuals.com>

TV manuals search

<http://tv.somanuals.com>