

# Installation Instructions



453

SIZE 36  
SERIES C

## GAS-FIRED AIR CONDITIONER

**bryant**

### Important - Read before Installing

39453D48 Rev 1  
5/20/70

1. Check all local or other applicable codes for information concerning proximity to property lines, height above roof, obstructions, etc.
2. Be sure the power supply available (voltage, frequency and phase) corresponds to that specified on the unit (115-60-1).
3. Check the electrical service provided by the utility for the building to be sure that the service capacity is sufficient to handle the load imposed by this unit.
4. Refer to the regulations of the serving gas supplier and the local building, heating, plumbing or other codes in effect in the area in which installation is to be made.
5. Refer to the dimensional drawing on page 2 for location of electrical, gas and chilled water connections prior to setting the unit in place.
6. This unit is equipped with an Alclad aluminum chiller coil and tank. For the chilled water circuit, use only chilled water additive "N" (Bryant part number 68593C1).

NOTE: When this chiller is used in conjunction with a boiler, a 4-pipe system must be used. A common piping system cannot be used. Use separate coils and piping.

### GENERAL

Model 36-453, Series C, is a gas-fired air-cooled absorption refrigeration system, suitable for residential or small commercial air conditioning system.

The 453 absorption unit is used for cooling in conjunction with indoor or outdoor coil assemblies. The chiller can also be used with a Bryant gas-fired furnace to provide "all-seasons" air conditioning for either warm or cool air, as outside temperatures dictate.

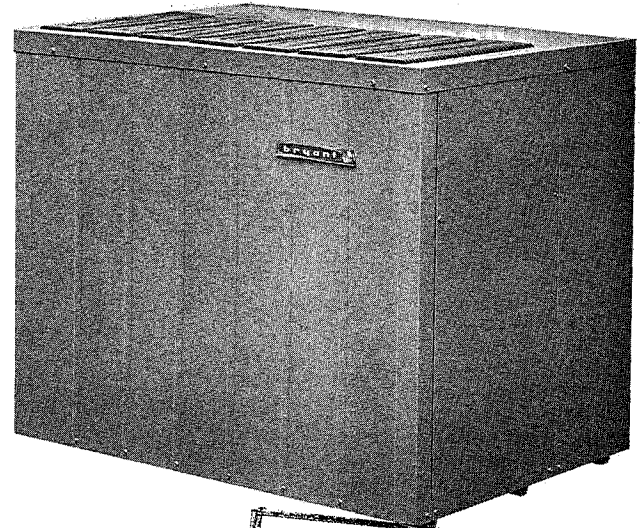

Figure 1 - Model 453 Gas Air Conditioner

### Multiple Chillers and Cooling Coils

When it is planned to connect two or more chillers or coils, additional piping and electrical information is required and should be obtained from your Bryant distributor. When making multiple chiller installations, only Model 36-453, Series C chillers can be interconnected. Do not manifold Series C units with Model 450, 451 or 452 units of any series, or with Model 453 Series A or B units.

### Operation at Atmospheric Pressure

The chilled water tank on this unit is vented to the atmosphere; consequently, the chilled water circuit operates at atmospheric pressure. Therefore, conventional piping practices for a closed, pressurized system do not apply for this unit.

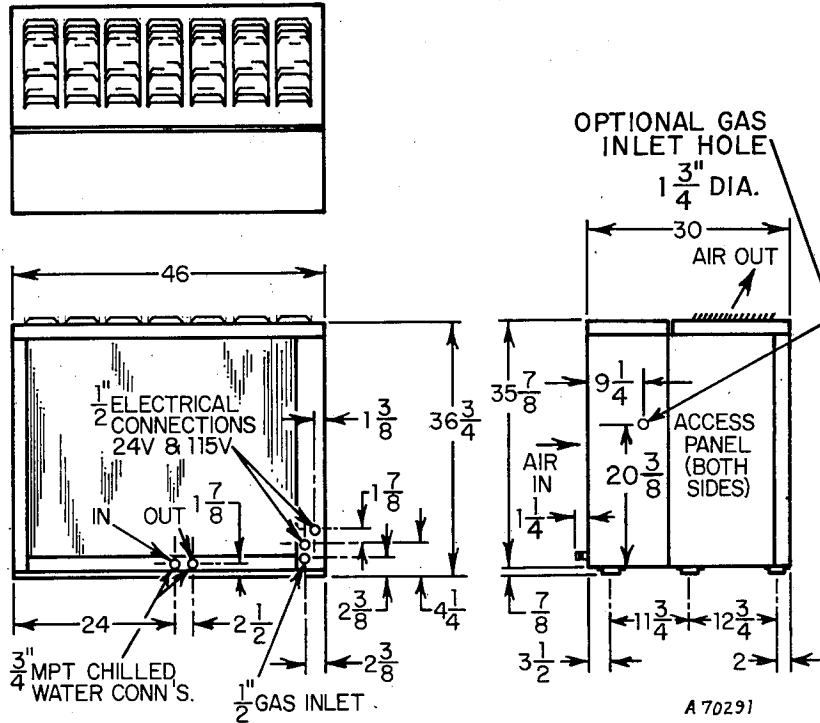

36-453, Series C

RATINGS, CAPACITIES AND COMPONENT INFORMATION

Gas Input	BTUH	85,000
Power Supply (Voltage, Cycles, Phase)		115-60-1
Electrical Input	KW	1.2
Condenser Air Flow	CFM	3,500
Refrigerant	Type	R 717
Amount	Lbs	6.8
Total Solution	Lbs	18.5
Factory Test Pressure (Refrigerant Cycle)	PSIG	450
Relief Valve Set (Refrigerant Cycle)	PSIG	450
Operating Chiller Water Volume	Gal.	2.5
Operating Chiller Water Level Above Base	Inches	9-13/16
Internal Chilled Water Pressure Loss	Ft. Water	2
Pressure in Chilled Water Tank	PSIG	*0
Nominal Chilled Water Flow Rate	GPM	7.5
Unit Weight	Lbs	550
Water-Solution Pump Motor (HP & Service Factor)		1/2 - 1.6
Speed	RPM	3450
Frame		48
Pulley Pitch Dia & Bore	Inches	3.15 - 0.50
Water Pump Pulley Pitch Dia & Bore	Inches	3.3 - .628
Solution Pump Pulley Pitch Dia & Bore	Inches	8.8 - .625
Belt Length & Width	Inches	40 x 1/2
Fan Motor HP		1/3
Speed	RPM	825
Frame		48
Fan Diameter	Inches	24

\* Atmospheric

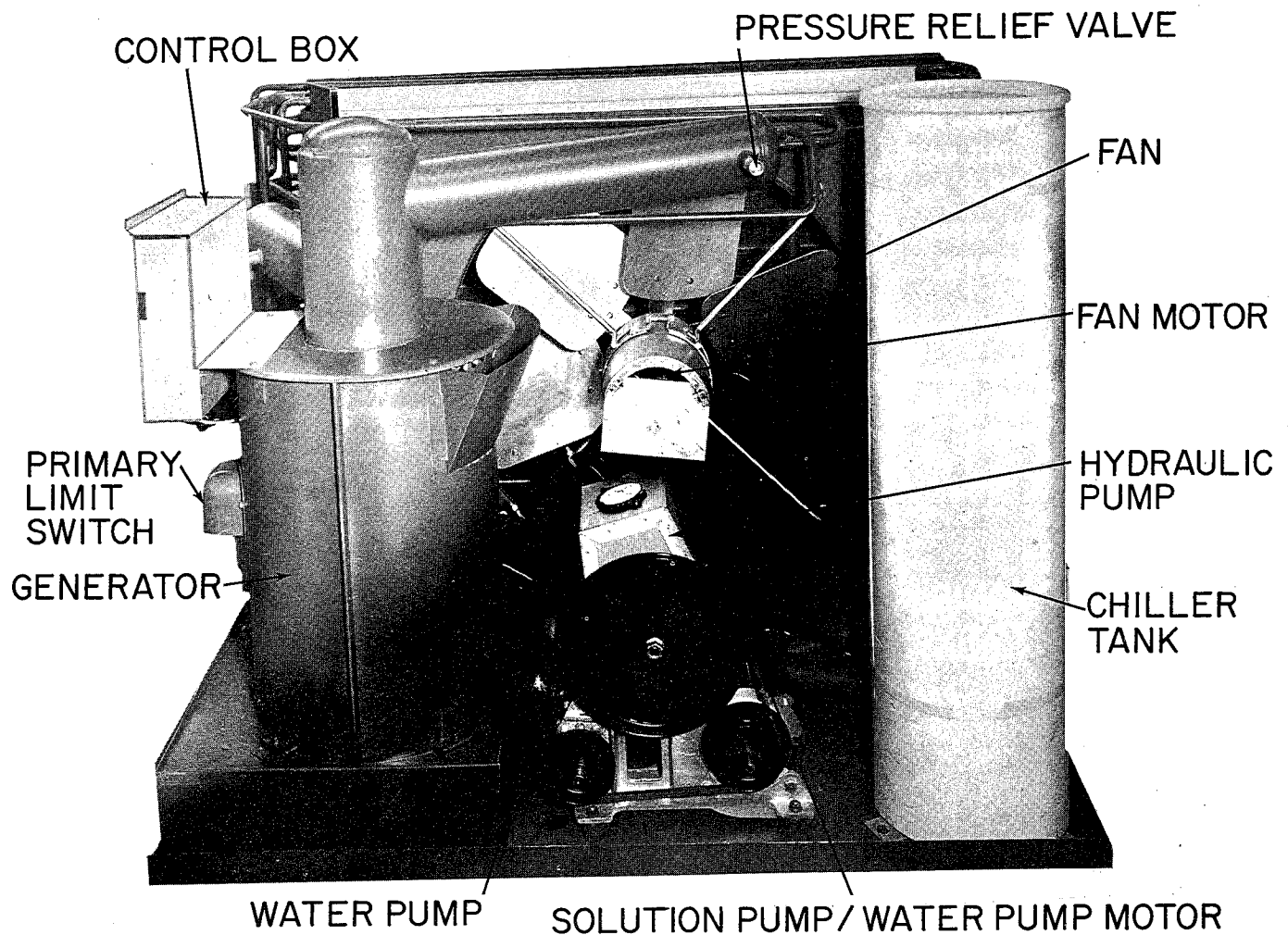

Figure 2 – Partially Disassembled Unit (Front View)

## Installation

Installation of the Model 36-453 Gas Chiller unit consists of the following steps:

- I. Locating and Mounting the Unit
- II. Connecting Chilled Water Lines
- III. Making Electrical Connections
- IV. Making Gas Connections
- V. Charging System with Water
- VI. Checking the Unit Operation
- VII. Adjusting Gas Input
- VIII. Balancing the System
- IX. Freezing Weather Protection

Each of the above steps is discussed in detail in this instruction. Read the entire instruction before starting the installation.

### I. LOCATING AND MOUNTING THE UNIT

The construction of Model 453, Series C, is such that the unit can be mounted on any suitable NON-COMBUSTIBLE BASE. However, there are several conditions, or circumstances, that result in the requirement of field-supplied supports. Some of these circumstances are:

1. When state and/or local building codes prohibit mounting the unit directly on a base.
2. When the unit is to be placed in an area where there is danger of standing water.

## Mounting Base

The unit is supported on 3 rails attached to the bottom of the base. These rails extend the full length of the unit as shown in the dimensional drawing on page 2.

The recommended types of mounting bases for all installations are:

a. Precast concrete lintels.

Use three lintels run the depth of the unit; one each under the right and left end and one at the center of the unit.

b. Concrete blocks.

Use a block under each corner plus a block under each of the two long sides midway between the corner blocks. Arrange the blocks so that the center rail as well as the front and back rail is supported.

c. Concrete slab.

Minimum thickness 4 inches.

CAUTION: ALWAYS USE NON-COMBUSTIBLE MATERIAL FOR THE BASE.

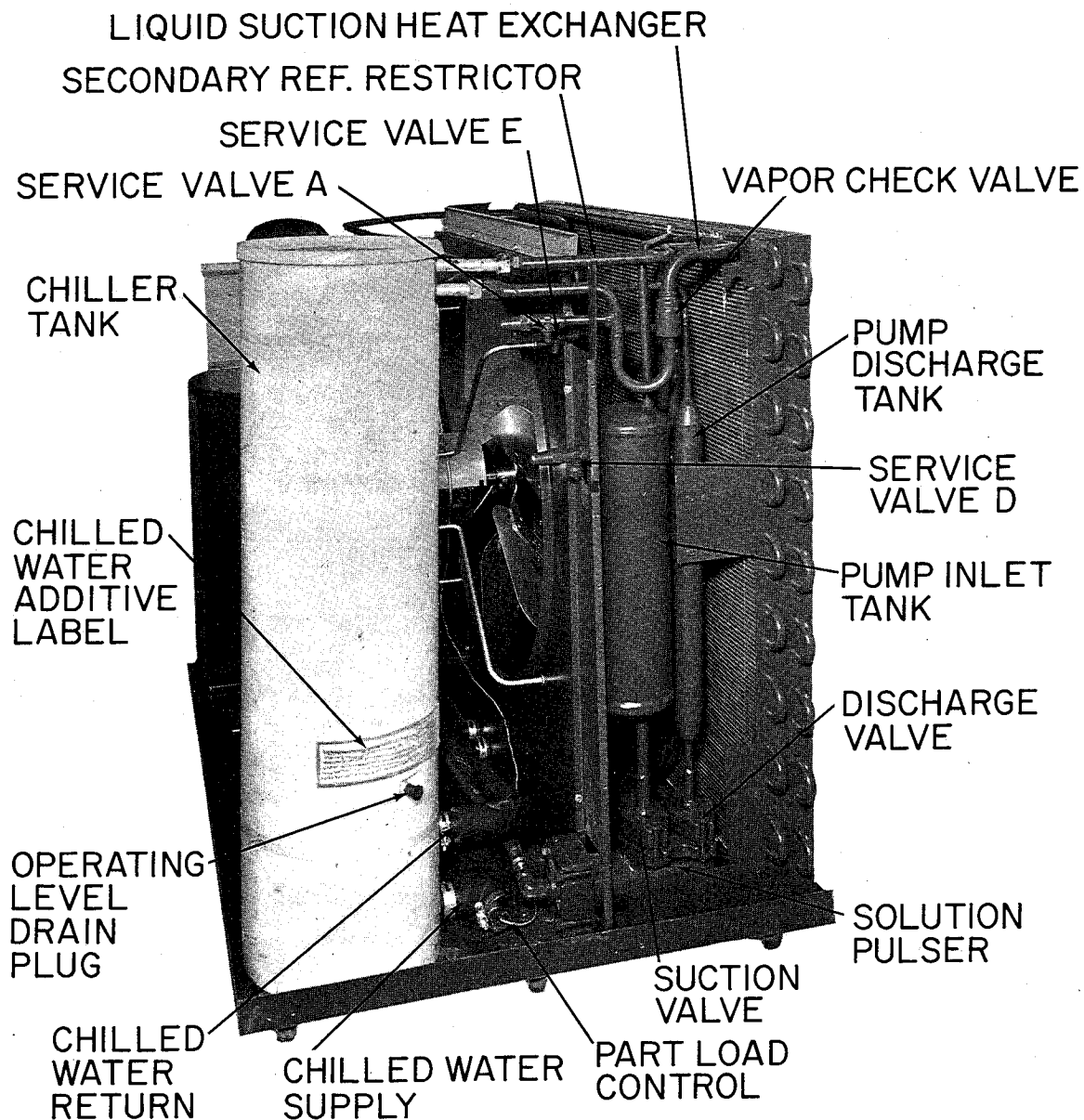

Figure 3 - Partially Disassembled Unit (Right Side View)

## Rooftop Installations

1. Place the unit above a load-bearing wall whenever possible.
2. Roof areas are susceptible to standing water; therefore, field-supplied supports

should be placed under the unit. Allow a minimum of 6 inches clearance between bottom of unit and roof.

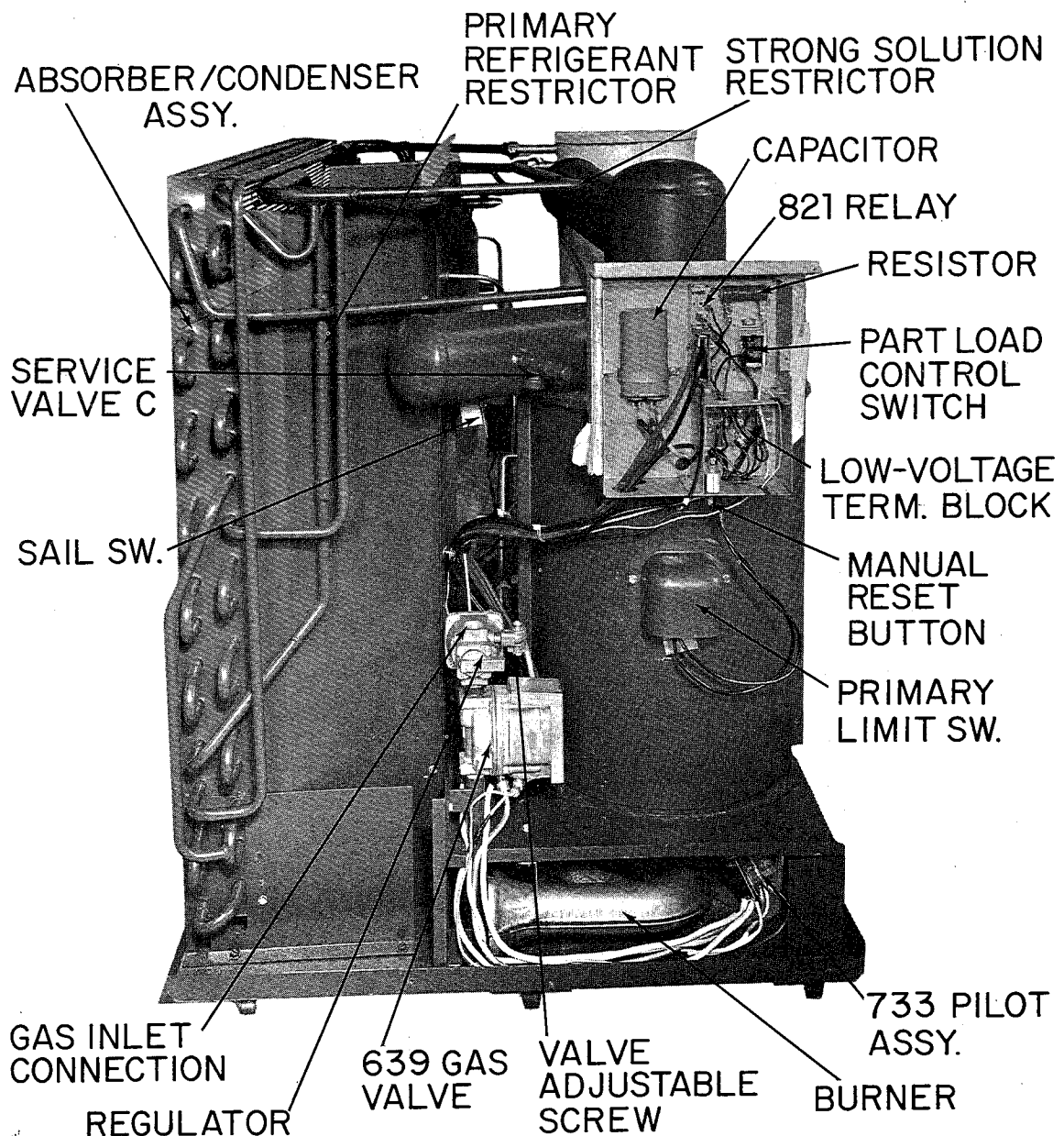

Figure 4 - Partially Disassembled Unit (Left Side View)

## Clearances

The condenser coil is located at the back of the unit with the condenser air inlet through the louvered rear panel and the discharge through the louvered top panel.

The minimum clearance between the back of the unit and a wall is 15 inches. If the overhang is less than 7 feet above the unit, the unit must be mounted outside a plumb line from the eaves of the overhang. The clearance on the right and left ends should be a minimum of 2 feet to provide access for servicing.

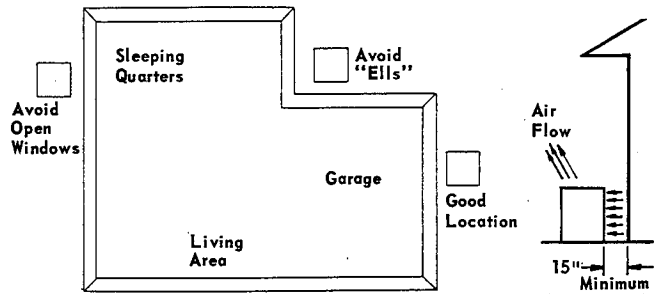

Figure 5 - Locating the Unit

## II. CONNECTING CHILLED WATER LINES

Refer to the following information: "Multiple Chillers and Cooling Coils," page 1; "Operation at Atmospheric Pressure," page 1; "Freezing Weather Protection," page 12.

TABLE I

Nominal Pipe Size Inches	Allowable Distances between Coil Models 406, 407, 408, 411, 414 and Chiller (NOTE 1)			
	Bryant Quick-Connect Tubing (NOTE 2)	Polyethylene Pipe	Copper Pipe	Galvanized Pipe (NOTE 3)
3/4	45'	65'	67'	87'
1	95'	280'	220'	304'

NOTE 1: Values shown in the above table are for one direction only, and using Bryant water coils. Total length of pipe (from chiller to coil and return) would be double the values shown. Values apply to single unit installations only. All distances shown are calculated on the predication that only long elbows are used. Brass elbows are used with polyethylene pipe. When using tubing, avoid any sharp bends that would tend to restrict or stop the flow of water.

NOTE 2: If tubing is used and coil is above chiller water level, refer to PAM 400.2.6.

NOTE 3: Galvanized pipe may only be used if no anti-freeze will be required for winter protection.

NOTE 4: When this chiller is used in conjunction with a boiler, a 4-pipe system must be used. A common piping system cannot be used. Use separate coils and piping.

## Materials

### 1. CHILLED WATER PIPING

- Use Bryant Quick-Connect Tubing.
- Polyethylene pipe - satisfactory substitute; use medium density flexible pipe whose wall thickness approximates Schedule 40 pipe (Commercial Standard CS 255-63). Pipe must

- be made from virgin material. Do not use pipe manufactured from reclaimed material.
- Copper - satisfactory substitute.
- Galvanized - may only be used if no anti-freeze will ever be required.

## 2. FITTINGS

- (a) Brass - when possible.
- (b) Galvanized - may only be used if no anti-freeze will ever be required.

### Pipe Length and Diameter

Table I shows the maximum length of pipe of different diameters that can be used between the pump discharge and the coil inlet and still maintain minimum allowable (design) water flow rate.

1. Multiply table values by two to obtain the total length of pipe from chiller to coil and return.
2. Length is measured along the pipe path and therefore includes vertical distance between the water coil and the chiller.
3. Lengths shown in Table I are based on using a total of eight elbows in the entire water line (chiller to coil and return). Lengths are predicated on the use of a Bryant matching water coil. For greater distances, use larger size pipe.
4. For calculating chilled water pipe size for coils not listed, use friction loss method with allowance for coil pressure loss. Refer to coil instructions for pressure loss at design water flow rate. Refer to Table II, showing available head with standard pump drive. For additional pump head, consult Bryant distributor.

TABLE II - MODEL 36-453, SERIES C

Water Flow Rate GPM	Pressure External to Unit Ft Water Std RPM
2.0	25.9
3.0	25.5
4.0	25.0
5.0	24.5
6.0	23.8
7.0	23.0
7.5	22.5
8.0	22.0
9.0	21.0
10.0	19.7
11.0	18.6

## Insulation

1. Insulate both supply and return lines.
- NOTE: Bryant Quick-Connect Tubing is pre-insulated.
2. Material should be of good quality and be covered with a good vapor barrier. Armaflex or equivalent is recommended. Use 1/2-inch wall thickness.

### Height of Coil above Unit

The maximum vertical distance from Model 36-453, Series C chiller to top of coil is 21 feet. For greater heights, an adjustable water pump pulley must be used.

### Water Coil Connections

1. If the cooling coil is used in connection with a heating unit and the heating unit is not approved for installation downstream from the cooling coil, install the cooling coil in parallel with or downstream from the heating unit. This will avoid condensation in the heating unit. If the coil and heating unit are installed in parallel, the dampers or other means used to control flow of air should be adequate to prevent chilled air from entering the heating unit; if manually operated, the dampers shall be equipped with some means to prevent operation of either unit unless the dampers are in full heat or full cool position.
2. If the coil is located in a warm air stream, do not connect polyethylene pipe directly to the coil. Connect a minimum of 24 inches of copper pipe to both the coil inlet and outlet; then connect the polyethylene pipe to these nipples. Note: not required when using Bryant Quick - Connect Tubing.
3. On installations where the water in the outside piping freezes and the coil is in a heated air stream, precautions must be taken to provide for water expansion. The connecting polyethylene pipe acts as an expansion vessel if there is sufficient footage in the heated space (space not subject to freezing). The following table shows the minimum lengths (total inlet and outlet) of polyethylene

piping of various diameters that are required to provide adequate expansion volume.

Nominal Pipe Size Inches	Length of Polyethylene Pipe in Feet
	Size 36
3/4	24
1	15

If the total polyethylene chilled water line footage in the heated space is not as long as the minimum values shown in the table, tee a vertical pipe of sufficient volume into either of the coil connections to provide for expansion, or drain the lines during freezing weather.

Note: No minimum run required when using Bryant Quick-Connect Tubing.

### III. MAKING ELECTRICAL CONNECTIONS

1. Make all electrical connections in accordance with the National Electrical Code and any local ordinances or codes that might apply.
2. Provide a separate power supply for the air conditioner.
3. Provide a fused disconnect switch within sight of and not more than 50 feet from the unit. A 30 amp standard fuse or 15 amp Fusetron is suggested.

Use minimum wire size of #14 copper wire or #12 aluminum wire. The power supply connects into the control box located inside the service panel on the left side of the unit. The conduit enters through a knockout located in the rear of the unit and attaches to the opening in the bottom of the control box. The low voltage (24V) wires from the thermostat control are connected to the low voltage terminal block in the control box.

#### Low Voltage Power Supply

**TRANSFORMER** - The air conditioner is not equipped with a transformer. However, when a Bryant furnace or fan coil unit is used as the air handler, the furnace transformer may be utilized as the power supply for the low

voltage control circuit in the Model 36-453, Series C.

If other than a Bryant furnace or fan coil unit is used, you must use

Bryant Part No. 64805D01 - 115V to 24V .  
The transformer listed is available as an accessory.

Length of Low Voltage Wire - If the length of the wire run between the transformer and the R terminal on the air conditioner exceeds 70 feet it will be necessary to remove the resistor from the low voltage circuit of the air conditioner as follows:

1. Remove the wire running from the resistor to "R" on the 453 terminal block.
2. Disconnect the pilot wire at the resistor and connect this wire to "R" on the terminal block.

### IV. MAKING GAS CONNECTIONS

The following recommendations apply to the installation, tests and operation of appliances and piping systems for natural and propane gases:

1. Before making any gas connections, refer to the regulations of the serving gas supplier and the local building, heating, plumbing, or other codes in effect in the area in which the installation is made.
2. The gas supply pipe enters through a knockout located in the rear of the unit near the right side. The gas connection is made at the 1/2" combination regulator-shut off valve. See Figure A for unit piping.

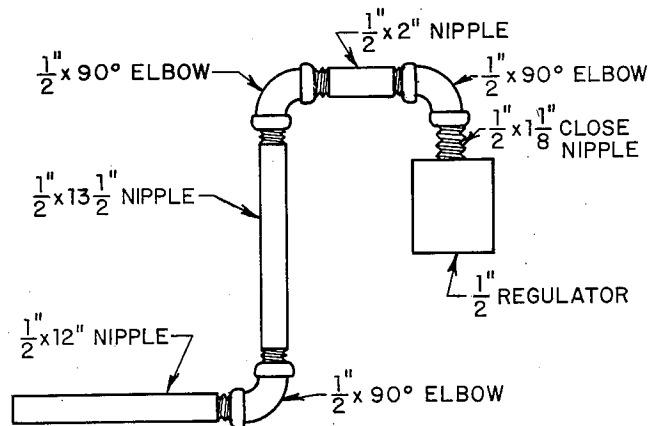

Figure A



### Bill of Materials for Figure A

Quantity	Item
3	1/2" 90° elbows
1	1/2" x 2" nipple
1	1/2" x 1-1/8" close nipple
1	1/2" x 13-1/2" nipple
1	1/2" x 12" nipple

An optional gas inlet hole has been provided in the left side corner panel so the installer can run the gas supply pipe in to the left side instead of the rear of the unit. The dimensional drawing on page 2 shows the location of optional gas inlet hole.

### Bill of Materials for Figure B

Quantity	Item
1	1/2" union
2	1/2" x 2" nipple
1	1/2" close nipple
1	1/2" x 3" nipple
2	1/2" 90° elbows

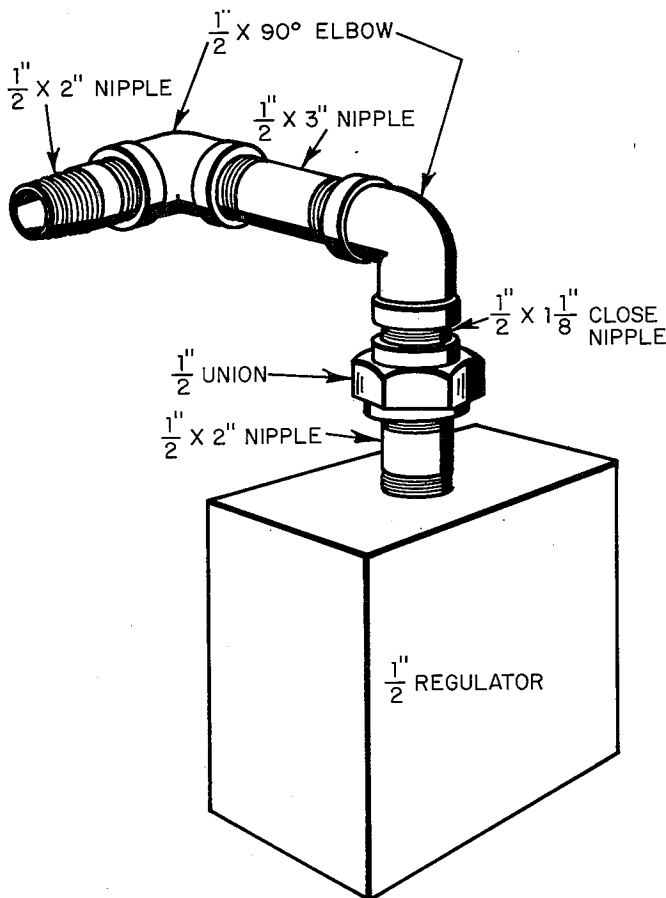

Figure B

3. A wrench-type shut-off valve should be installed in the gas line within sight of, and convenient to the unit.

4. Joint compound (pipe dope) which is resistant to the action of liquefied petroleum gases should be applied sparingly and only to the male threads of the joints.

5. Install a drip leg trap in the gas supply riser leading to the unit. After gas pipe connections have been made, purge the lines, as described below, and check for leakage. Use a soap and water or other recommended solution.

6. Never use matches, candles, flame or other source of ignition to check for leaks.

### Pilot

Light the pilot, using the procedure outlined on the lighting instructions on the rating plate. However, when lighting the pilot for the first time, perform the following additional steps:

1. If the supply line was not purged prior to connecting the unit, it will be full of air. Since it would take a long time to vent this air through the small pilot port, it is recommended that the pilot supply line be disconnected at the pilot shutoff valve and the supply line be allowed to purge until the odor of gas is detected. Never purge gas lines into the combustion chamber. Immediately upon detection of gas odor, reconnect the pilot supply tube. Allow 5 minutes to elapse and light the pilot in accordance with the instructions on the unit rating plate.

2. The pilot flame should be soft blue in color.

a. For natural gas this flame should be of sufficient length to provide good impingement on the bimetal of the Bryant pilot. The flame should extend upward and above main burner ports.

3. If the pilot flame does not have the appearance described above, it may be adjusted at the manual pilot shutoff valve.

a. The valve is equipped with an adjustable screw. Turn the handle to the full open position, and remove the screw cap to expose the adjustable screw. Turn adjusting screw until flame has the desired appearance.

b. Replace screw cap.

## V. CHARGING THE SYSTEM WITH WATER

### CAUTIONS:

1. Do not run the pump dry.
2. Do not operate the pump when the chiller water lines are frozen. Freezing temperatures, however, will not damage the pump.
3. The gas valve and electrical power to the unit should be off when operating the unit during the following procedures.

### Charge the system with water as follows:

1. Remove louvered section of the top casing and remove the cover from the chilled water tank.

2. Add tap water until the distributor pan is covered. A garden hose is useful for this operation.

NOTE: Tap water having less than 60 ppm chlorides may be used in the chilled water circuit with proper additive. In those areas where tap water contains more than 60 ppm chlorides, use distilled or deionized water with proper additive. Do not use "softened" water or otherwise treated water.

3. Start unit (be sure gas is turned off). Continue to add water until the system is primed and the water is returning to the chiller tank.

4. Check water piping for leaks throughout the chilled water system.

5. Remove the right access panel from unit and remove operating level drain plug on the side of the chiller tank.

6. The pump should still be running. When water ceases to flow from the drain opening, replace drain plug.

7. Slowly add the required amount of Chilled Water Additive "N" (Part No. 68593C1) to circulating water in distributor pan. The correct amount of Chilled Water Additive "N" is given in paragraphs (a) and (b) below.

(a) For systems using water only, use two ounces of Chilled Water Additive "N" per gallon of water.

(b) For systems containing uninhibited ethylene glycol antifreeze, use four ounces of Chilled Water Additive "N" per gallon of chilled water solution.

NOTE: The proper amount of chilled water additive concentration can be determined by using Bryant Test Kit (Part No. 61036DO3) per instructions enclosed with the test kit. To estimate chilled water capacity of system, refer to Table III.

TABLE III

	Water Capacity Gallons
36-453, Series C Chiller	2.5
Bryant 1-1/2 ton coil	.6
Bryant 3-ton coil	1.0
1 ft 3/4" pipe	.03
1 ft 1" pipe	.05

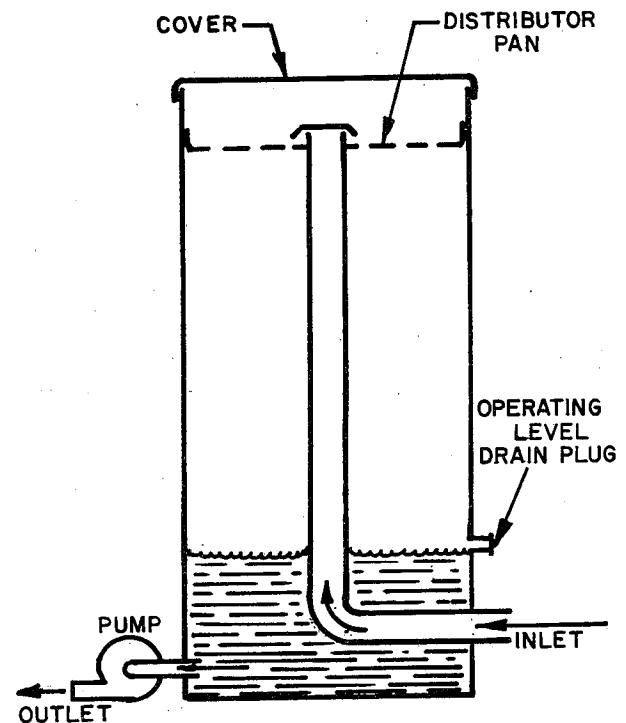

Figure 6 - Chiller Tank

## VI. CHECKING THE UNIT OPERATION

1. Be sure main manual gas valve is off. Light pilot as described on the unit rating plate.
2. Set thermostat to "cool"; set thermostat fan switch to "auto"; set thermostat below room temperature.
3. Turn on main disconnect switch to unit.
4. Check indoor fan operation by turning thermostat fan switch to "on" for continuous operation. Move thermostat above room temperature and observe that the indoor fan remains on.
5. To place the system in operation; open the main manual gas valve, replace all panels, and set the thermostat at the desired temperature.

### High Temperature Cut-Off

The high temperature circuit includes a high temperature control located on the side of the generator plus a high temperature lockout (circuit breaker) located in the control box. If the generator becomes overheated, the contacts in the high temp control open, causing the circuit breaker to go into lockout position. The gas valve closes, the fan and pumps stop and they will not recycle until the circuit breaker is reset. To reset the circuit breaker, push the red button extending through the bottom of the control box. Be sure to locate and correct the cause of the high temp cut-out.

### Cycle of Operation

The 36-453, Series C, is equipped with a fan/pump motor control (Bryant Model 821) and a sail switch. The fan/pump motor control is a single pole, single throw line voltage switch actuated by a heat motor (low voltage electric resistance coil fastened to bimetal strip next to the switch). When the thermostat calls for cooling, electric current energizes the resistance coil in the Model 821 control and in approximately one minute the line voltage switch closes, starting the condenser fan motor and solution pump - water pump motor. The opening of the gas valve

will be delayed slightly, due to the fact that it will not be energized until the condenser fan is moving a sufficient amount of air through the unit to activate the sail switch.

On shutdown by the thermostat, the gas valve will close immediately; however, the balance of the unit will continue to run for approximately 1-1/2 minutes until the line voltage switch in the Model 821 control opens.

## VII. ADJUST GAS INPUT

The gas input must be checked and adjusted if necessary to agree with the input shown on the unit's rating plate.

The natural gas units are equipped with adjustable gas pressure regulators set at factory for 3.5 inches w.c. manifold pressure.

The LP gas units are not equipped with a pressure regulator.

Check natural gas units by the following method:

1. Measure gas at meter. Be sure all other gas appliances are turned off. Increase or decrease input to burners by adjusting the gas pressure regulator.
2. Set manifold pressure according to Table IV for the Btu value and specific gravity of the gas to be supplied to the unit. Connect manometer to 1/8-inch pressure tap on manifold and, with unit in operation, set correct pressure by adjustment of the gas pressure regulator.

Example: Natural Gas

1025 Btu

0.63 Specific Gravity

3. From Table IV manifold pressure is 3.3 inches w.c.
4. With manometer connected to manifold, set pressure at 3.3 inches by adjusting gas pressure regulator.

**TABLE IV  
MANIFOLD PRESSURE CHART  
FOR MODEL 36-453, SERIES C, (Inches w.c.)**

BTU Value	Specific Gravity				
	0.59	0.61	0.63	0.65	0.67
900	4.0	4.1	4.2	4.4	4.6
950	3.6	3.7	3.8	3.9	4.1
1000	3.3	3.4	3.5	3.6	3.8
1025	3.1	3.2	3.3	3.4	3.5
1050	2.9	3.0	3.1	3.2	3.3
1100	2.7	2.8	2.85	2.9	3.1

For manifold pressures exceeding 3.0 inches + .3 inches, consult local utility.

Check LP gas units as follows:

The burner orifice is sized for rated input with a manifold pressure of 11.0 inches w.c. Connect manometer to 1/8 inch pressure tap on unit manifold and adjust regulator at the supply tank to provide a manifold pressure of 11.0 inches w.c.

Caution: The unit may be run for short periods with the panel removed. Prolonged operation with panels removed should not be attempted.

### VIII. BALANCING THE SYSTEM

After the unit is in operation and the input has been measured and adjusted to agree with the rating plate requirements, the system must be balanced.

Any approved method of checking the air flow over the water coil may be utilized. Refer to the Bryant Model 453 Service Instructions for a review of standard methods.

## IX. FREEZING WEATHER PROTECTION

### Gas Air Conditioner

The unit has built-in freeze protection sufficient to protect the chiller and pump.

### Chilled Water Pipes

If hard pipe (non-plastic) is used for the chilled water lines, it will be necessary to drain the lines or add pure ethylene glycol antifreeze.

### Chilled Water Coil

Chilled water coils cannot be completely drained; therefore, if the water coil is subject to freezing temperatures, protect it by adding Zerex anti-freeze.

### Operation at Freezing Temperatures

Unit is not to be operated at temperatures below 40° F.

### Antifreeze - Type and Amount

This unit has an Alclad aluminum chiller coil and tank. For freeze protection, use only uninhibited ethylene glycol antifreeze available at your local chemical supply house. Refer to your local Bryant Distributor for the required amount of antifreeze for protection at various outdoor temperatures.

Chilled Water Additive "N" (Part No. 68593C1) must be used in the same proportions as indicated in Section V when antifreeze is required.

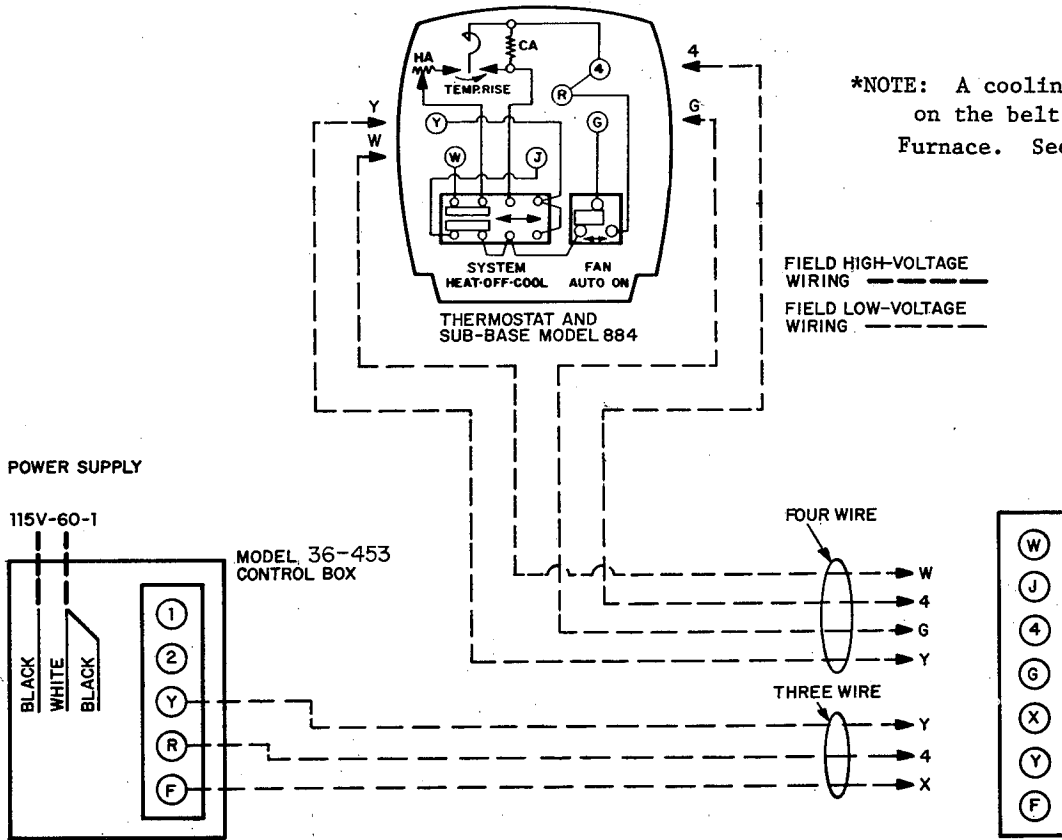

**\*NOTE:** A cooling relay must be installed on the belt drive Model 394 Series E Furnace. See the furnace wiring label.

**FIELD WIRING FOR CONNECTING MODEL 36-453, SERIES C WATER CHILLER TO MODEL 394 SERIES E DIRECT DRIVE OR \*BELT DRIVE FURNACE**

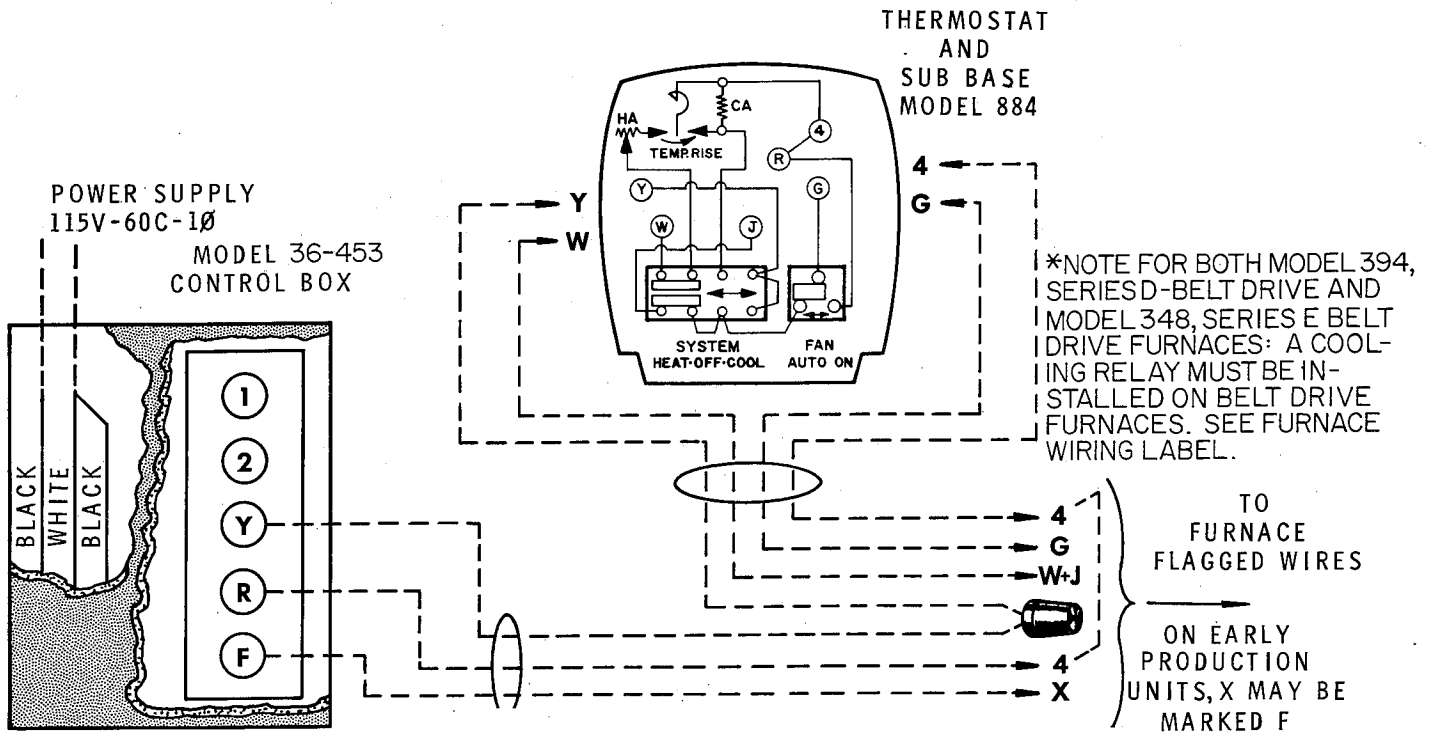

**CONNECTING THE MODEL 36-453 TO THE MODEL 394, SERIES D - DIRECT DRIVE OR \*BELT DRIVE FURNACE AND MODEL 348, SERIES E - DIRECT DRIVE OR \*BELT DRIVE FURNACE**

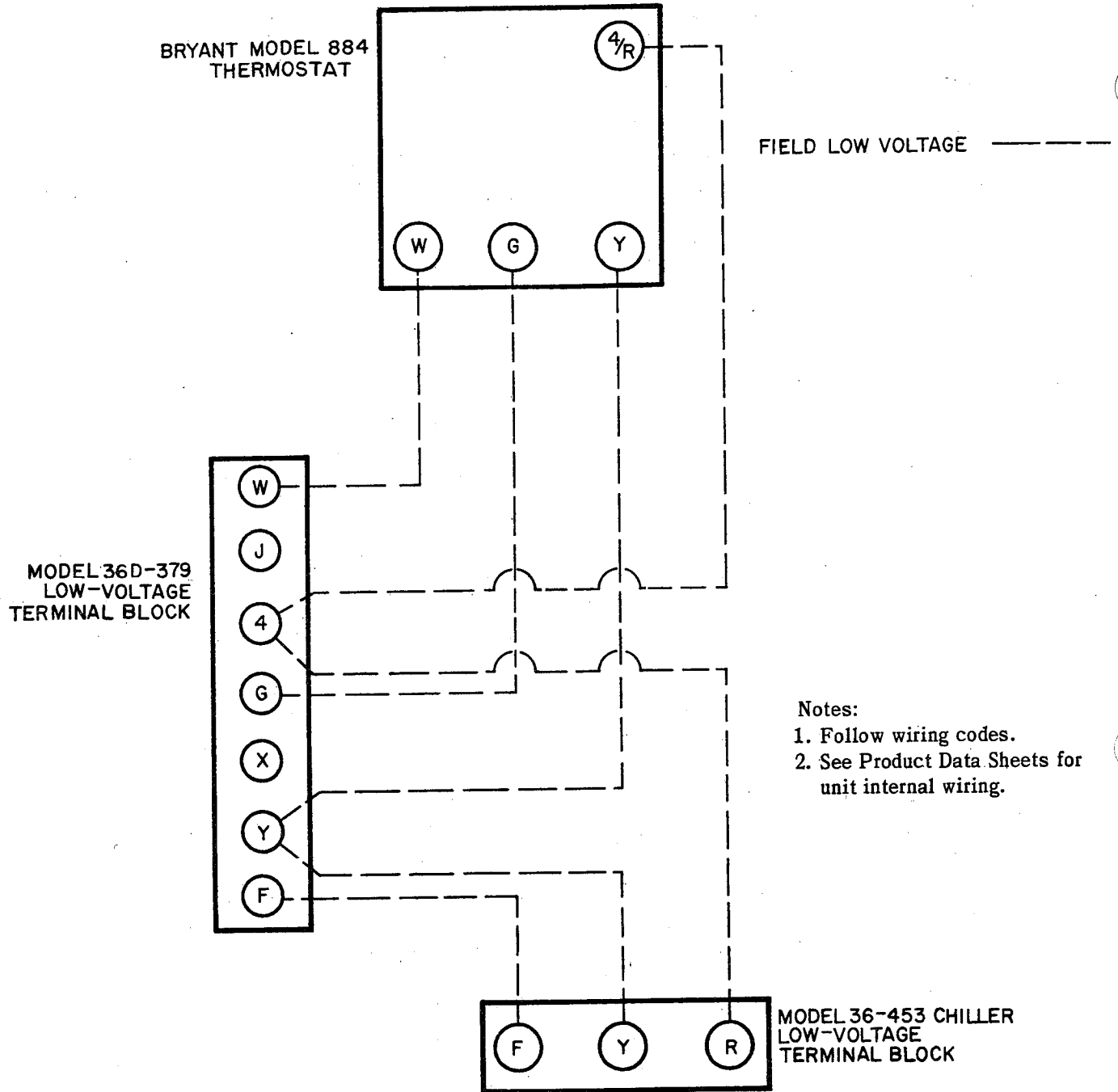

CONNECTING MODEL 36-453 CHILLER TO MODEL 36D-379 FURNACE

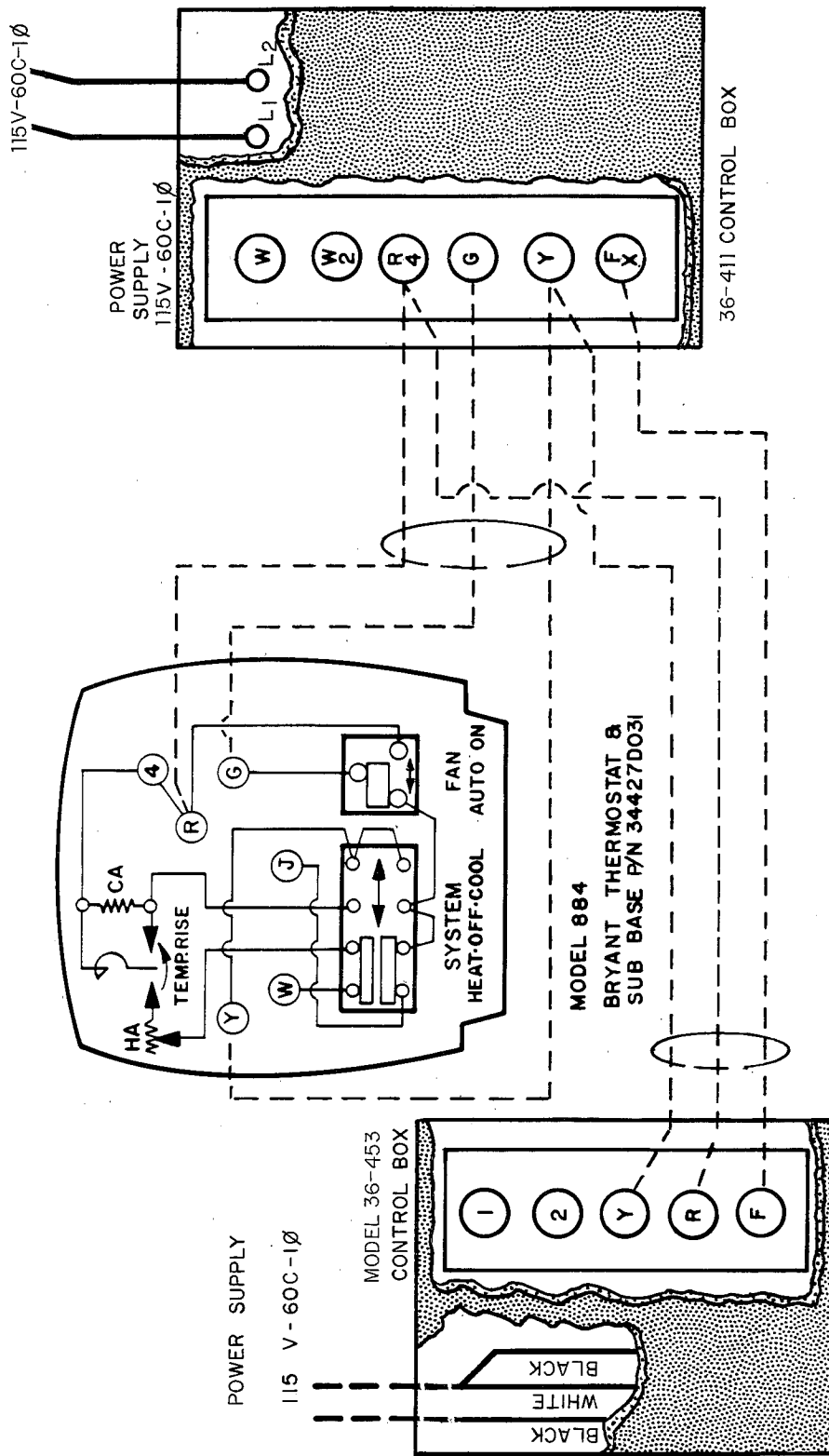

**CONNECTING THE MODEL 36-453 TO THE MODEL 36-411**

## Free Manuals Download Website

<http://myh66.com>

<http://usermanuals.us>

<http://www.somanuals.com>

<http://www.4manuals.cc>

<http://www.manual-lib.com>

<http://www.404manual.com>

<http://www.luxmanual.com>

<http://aubethermostatmanual.com>

Golf course search by state

<http://golfingnear.com>

Email search by domain

<http://emailbydomain.com>

Auto manuals search

<http://auto.somanuals.com>

TV manuals search

<http://tv.somanuals.com>