

YOUR P-TOUCH 580C

Thank you for purchasing the P-touch 580C!

Your new P-touch will allow you to design and print labels and stamps for any use. Your labels and stamps can contain characters of many sizes and styles as well as bar codes and graphics imported from other Windows applications. In addition, by using the variety of tape and ink cartridges available, you can print labels with different widths and exciting colors.

You no longer have to worry about urgent tasks that require professional printing. In the office, the factory, the lab and the home, the quality and performance of the P-Touch 580C makes it a very versatile machine.

Finally, as you may want to refer to this manual occasionally, we suggest that you keep it in a handy place.

FCC NOTICE

This equipment has been tested and found to comply with the limits for Class B digital device, pursuant to Part 15 of the FCC Rules. These limits are designed to provide reasonable protection against harmful interference in a residential installation. This equipment generates, uses, and can radiate radio frequency energy and, if not installed and used in accordance with the instructions, may cause harmful interference to radio communications. However, there is no guarantee that interference will not occur in a particular installation. If this equipment does cause harmful interference to radio or television reception, which can be determined by turning the equipment off and on, the user is encouraged to try to correct the interference by one of more of the following measures:

Reorient or relocate the receiving antenna.

Increase the separation between the equipment and receiver.

Connect the equipment into an outlet on a circuit different from that to which the receiver is connected.

Consult the dealer or an experienced radio/TV technician for help.

The enclosed interface cable should be used in order to ensure compliance with the limits for a Class B digital device.

Changes or modifications not expressly approved by Brother Industries, Ltd. could void the user's authority to operate the equipment.

This product is covered by one or more of the following patents.

USP4839742

USP4983058

EP315369

GB2223740

USP4922063

USP5009530

EP322918

USP4927278

USP5069557

EP322919

USP4966476

USP5120147

USP4976558

CONTENTS

ABOUT THIS MANUAL	1
QUICK REFERENCE GUIDE	
BEFORE YOU START	
MACHINE DIAGRAM.....	6
GENERAL PRECAUTIONS	8
POWER SUPPLY	9
OPTIONAL AC ADAPTOR.....	10
COMPUTER CONNECTION	11
TAPE CASSETTES	12
REMOVING THE LABEL BACKING.....	15
CLEANING THE PRINT HEAD AND ROLLERS	16
LEARNING THE ROPES	
INTRODUCTION.....	18
DOOR SIGN EXAMPLE.....	19
EQUIPMENT LABEL EXAMPLE.....	24
ADDRESS LABEL EXAMPLE.....	34
STOREGE SHELF LABEL EXAMPLE.....	38
FOR YOUR INFORMATION	
INTRODUCTION.....	46
FINDING YOUR WAY	47
POWER BUTTON.....	48
CURSORS	49
SHIFT, ALT & CAPS.....	50
CODE KEY.....	51
SYMBOLS.....	52
COMPOSITE CHARACTERS.....	54
RETURN	55
NEW BLOCK.....	57
SEQUENTIAL NUMBERING	58
CANCEL.....	60
CURSOR MOVEMENT.....	62

BACKSPACE	63
LINE OUT.....	64
CLEAR	65
ZOOM MODE.....	66
LABEL LENGTH	67
CONTRAST	68
AUTO FORMATS.....	69
LOCAL FORMATTING.....	75
GLOBAL FORMATTING	77
FONT	79
SIZE/WIDTH	81
STYLE/ITALIC.....	83
UNDERLINING/FRAMING.....	86
MULTI-COLOR PRINTING	87
FRAMING.....	93
TAPE FEED	94
VERTICAL PRINTING.....	95
MIRROR PRINTING.....	96
HORIZONTAL ALIGNMENT	97
VERTICAL ALIGNMENT.....	98
LENGTH.....	99
DISPLAY UNITS	100
COLORED FRAMES/SHADING	101
COLORED CHARACTERS.....	103
STORING/RECALLING/DELETING	105
NORMAL, MULTIPLE & SPLIT PRINTING.....	109
MARKING STAMPS.....	111
BAR CODING	113
ERROR MESSAGE LIST.....	118
TROUBLESHOOTING.....	125
MACHINE SPECIFICATIONS	126
FEATURES.....	127
INDEX	128
ACCESSORIES	132

ABOUT THIS MANUAL

Although this machine is easy to use, we suggest that you read this manual carefully before starting. This manual consists of a reference guide and three main sections:

- QUICK REFERENCE GUIDE** This section provides a quick, simple guide to setting up and using the machine.
- BEFORE YOU START** This section provides basic information concerning the machine itself, tape cassettes, and power supplies.
- LEARNING THE ROPES** This tutorial section leads you through easy-to-follow practice sessions designed to help you become familiar with the machine's operations.
- FOR YOUR INFORMATION** This handy reference section contains detailed explanations of all the machine's features.

The *Quick Reference Guide* contains all the information you need to immediately begin using this machine to make simple labels. Please read the brief *Before You Start* section for more details on the setup and care of the machine.

If this is your first time using this machine, or if you would like to brush up on some techniques, we suggest you work through the exercises in *Learning the Ropes*. If you have detailed questions about specific features, the *For Your Information* section will provide you with the answers.

Good luck! We hope you enjoy using your P-Touch 580C.

QUICK REFERENCE GUIDE

Power Supply (Refer to pages 9 and 10 for details.)

Inserting the Batteries

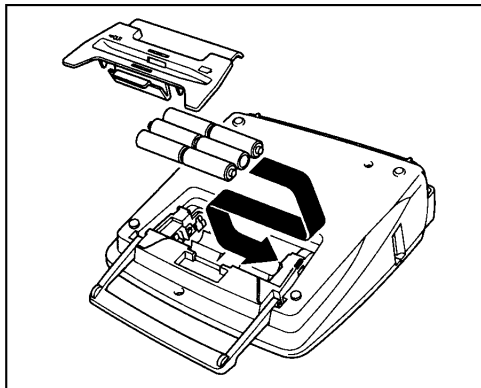

Remove the battery cover on the back of the machine and insert six **AA alkaline batteries.**

Connecting the Optional AC Adaptor

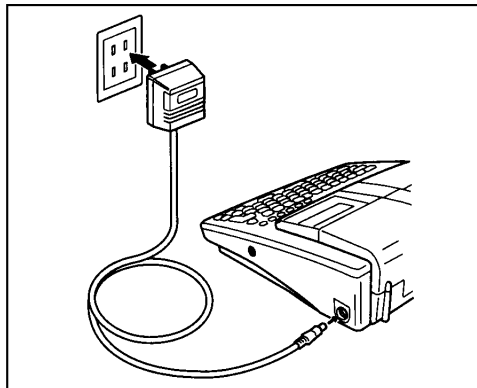

Insert the AC adaptor (model AD-30, sold separately) into the adaptor jack on the machine.

Tape Cassettes (Refer to pages 11 for details.)

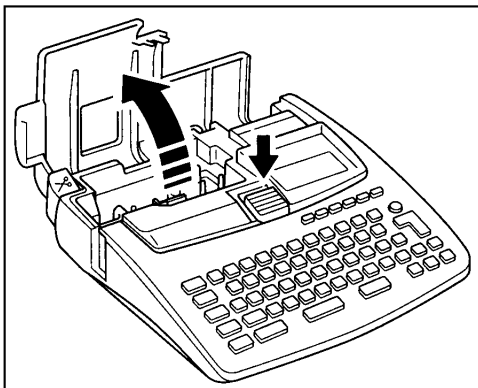

1. Press down on the cover release button and open the cover.

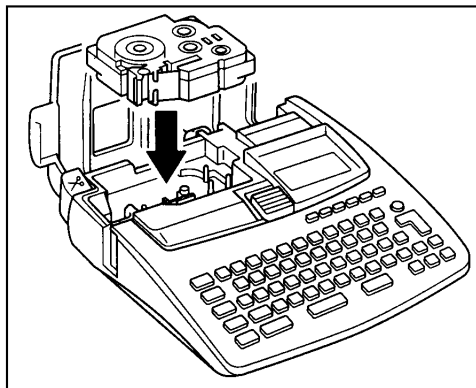

2. Insert a TZ tape cassette and close the cover.

Making Simple Labels

Mr. J. Smith

1. Press the power button.

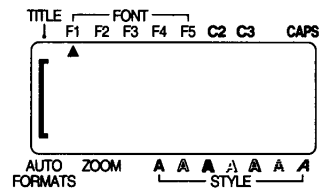

2. Enter "Mr. J. Smith".

a. Press **SHIFT** + **M**.

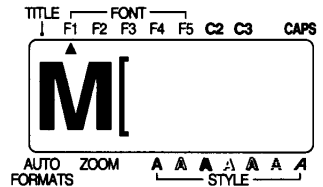

b. Press **R**, **.**, then **SPACE**.

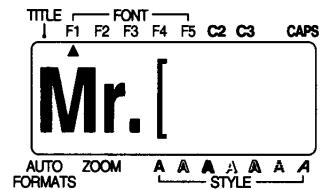

c. Press **SHIFT** + **J**. Next, press **.**, then **SPACE**.

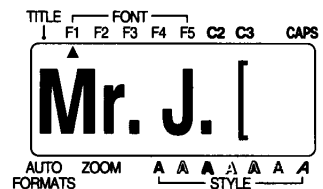

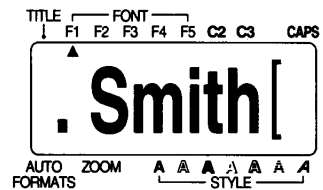

d. Press **SHIFT** + **S**. Then, press **M**, **I**, **T** and finally **H**.

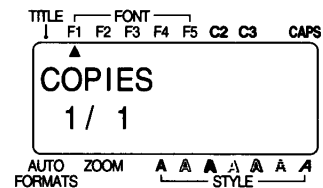

3. After entering the text, print out the label.

Press **SPECIAL PRINT** **PRINT**.



 To print multiple copies of the label,

press **CODE** + **SPECIAL PRINT** **PRINT**, then use **HOME**

and **END** to set the number of copies to be printed.

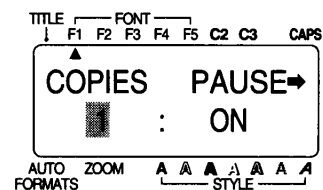

4. Affix the label.

- a. Press the tape cutter lever to cut the tape.

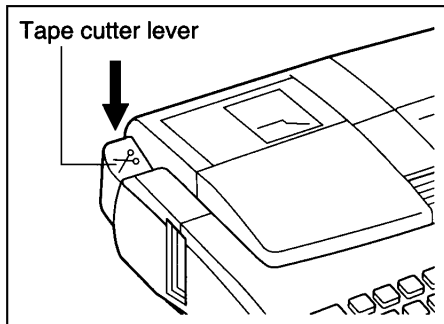

- b. Remove the label backing.

Use the enclosed lettering stick to remove the backing from the label.

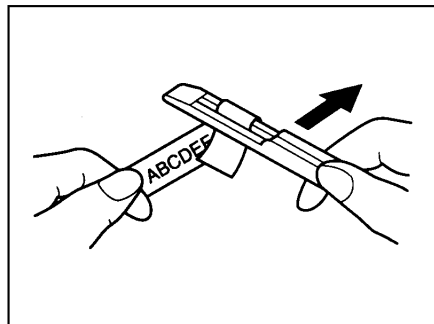
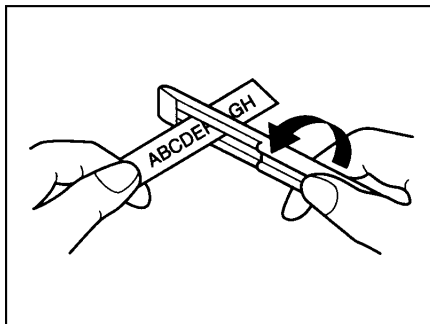

- c. Attach the label at the desired position.

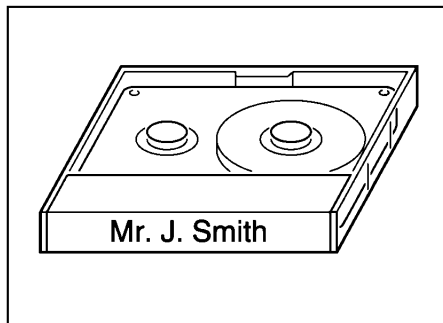

Demo printing (To print the sample label shown below, press + .)

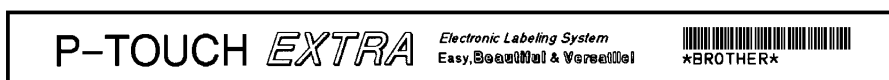

 Since three different sample labels are available, the type of sample label printed depends on the width of the tape installed.

Before You Start

MACHINE DIAGRAM

KEYBOARD

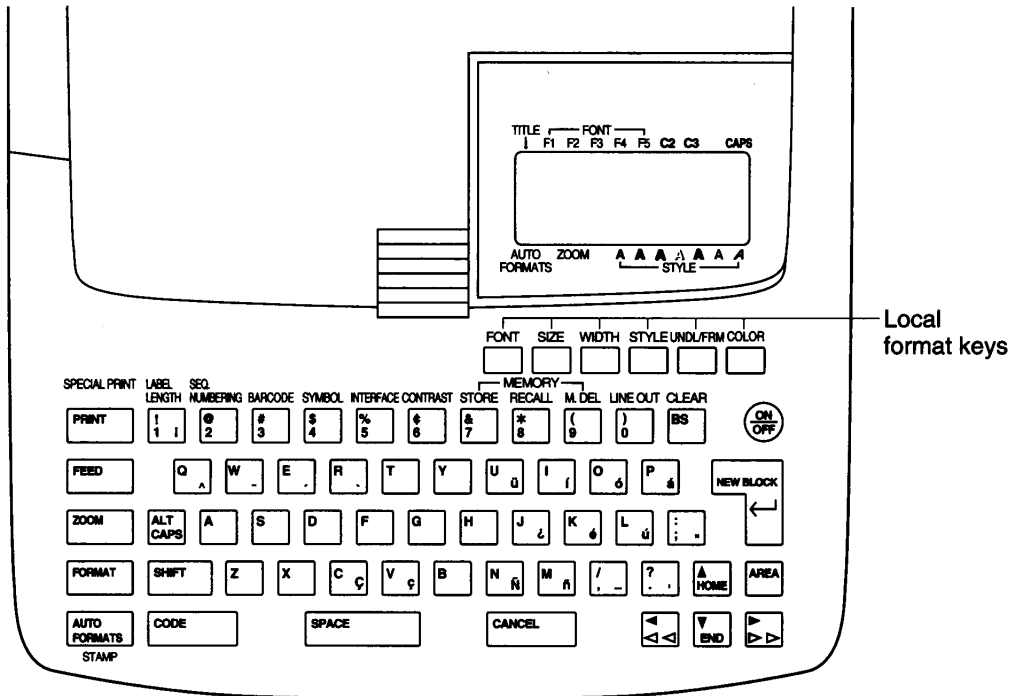

LCD DISPLAY

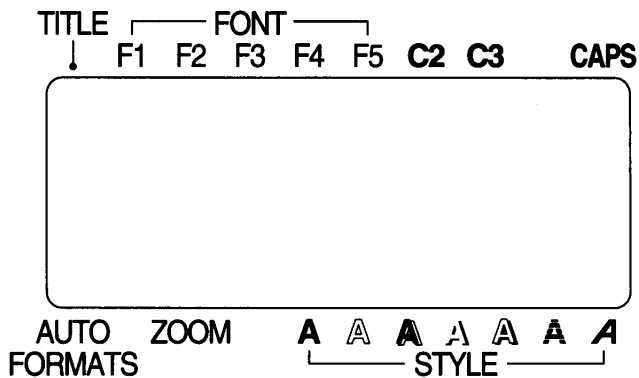

FEATURES

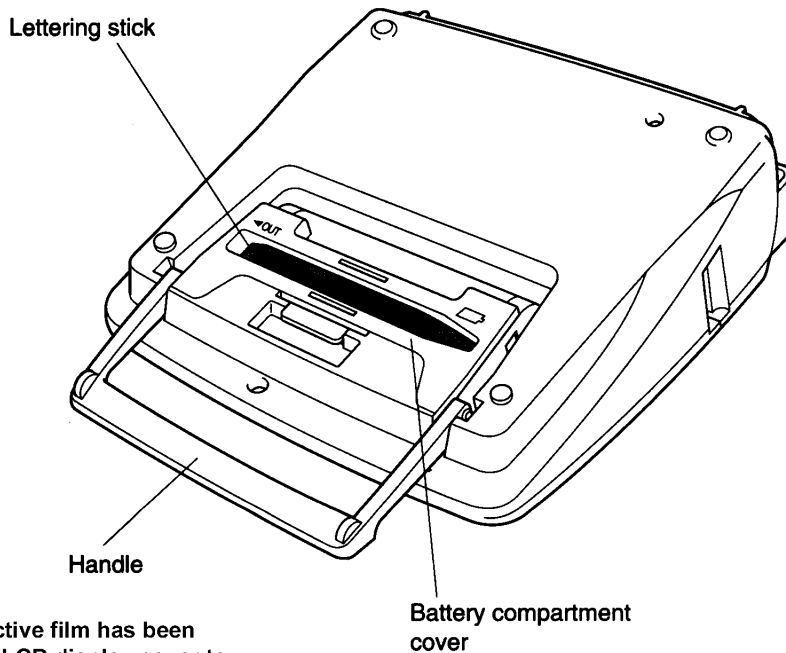
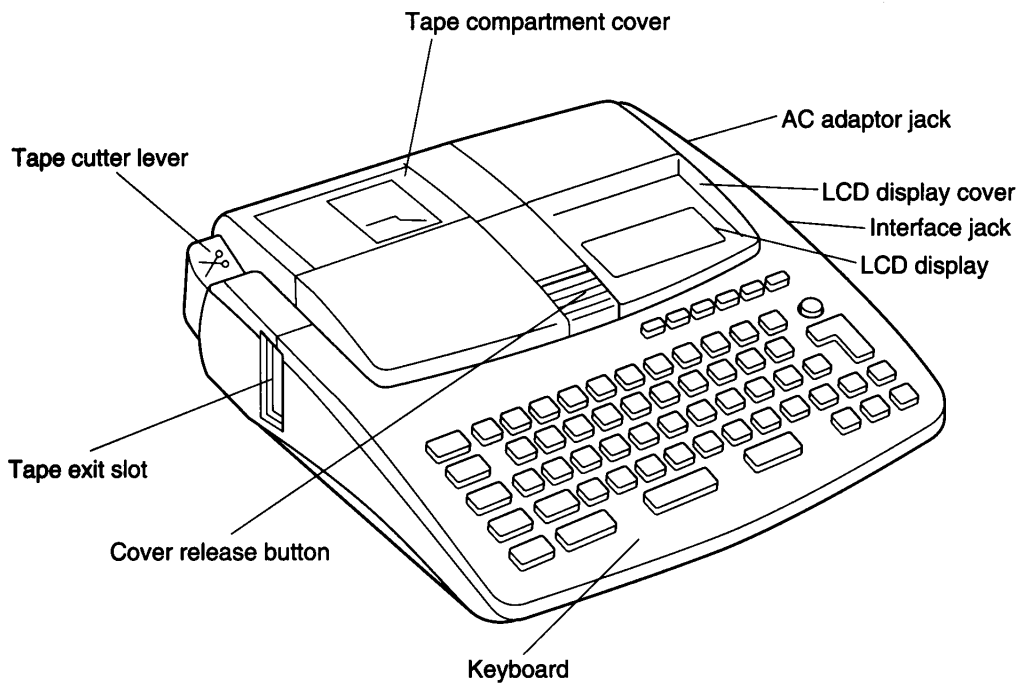

A clear protective film has been affixed to the LCD display cover to prevent it from being scratched or damaged during transport. Remove the film before operating the machine.

GENERAL PRECAUTIONS

- h Use only Brother TZ tapes with this machine. Do not use tapes that do not have the **TZ** mark.
- h Five TZ tape widths are available: 1/4" (6 mm), 3/8" (9 mm), 1/2" (12 mm), 3/4" (18 mm), and 1" (24 mm).
- h Do not pull on the tape. This may damage the tape cassette.
- h Avoid using the machine in extremely dusty places. Keep it out of both direct sunlight and rain.
- h Do not expose the machine to high temperatures or high humidity. Never leave it on the dashboard or in the back of your car.
- h Do not leave any rubber or vinyl on the machine for an extended period of time. Doing so may cause staining.
- h Do not clean the machine with alcohol or other organic solvents. Use a soft, dry cloth only.
- h Do not put any foreign objects onto or into the machine.
- h To avoid injuries, do not touch the cutter's edge.
- h When inserting new batteries, be sure to do so within five minutes of removing the old ones, otherwise all messages will be lost (unless the machine is plugged into an AC outlet with the AC adaptor).
- h Use only the AC adaptor (model AD-30) designed exclusively for this machine. Use of any other adaptor will void the warranty.
- h When the machine is not being used for a long period of time and it is not necessary to keep the messages stored in the memory, remove the batteries to prevent them from leaking and damaging the machine and disconnect the AC adaptor.
- h When the AC adaptor is plugged into the machine, unplugging the adaptor from the AC outlet can delete all messages in the memory, even though batteries are installed.
- h **Use AA alkaline batteries in the machine.**

POWER SUPPLY

This is a lightweight and portable machine. It can be used anywhere by installing six (6) **AA alkaline batteries**. When you change the batteries, always replace all six at the same time.

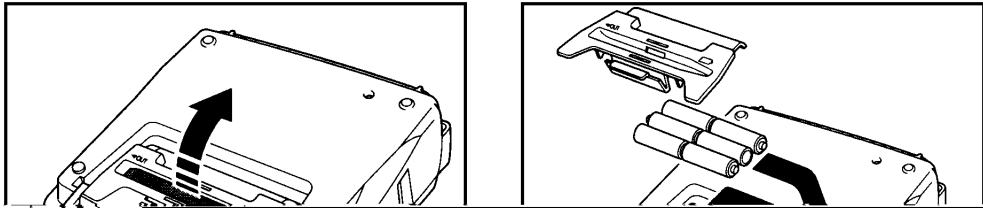

 *Be sure to insert the new batteries within five minutes of removing the old ones, otherwise the message in the working area and any messages stored in the memory will be lost (unless the machine is plugged into an AC outlet with the AC adaptor).*

If alkaline batteries are not used, large fonts and bar codes cannot be printed.

OPTIONAL AC ADAPTOR

The AC adaptor (model AD-30) allows you to use this machine anywhere a standard electrical outlet is available.

TO ATTACH THE AC ADAPTOR:

- (1) Insert the small plug on the adaptor into the jack marked DC IN 7V on the right side of the machine.
- (2) Insert the large plug into the nearest standard electrical outlet.

 *Only use the AC adaptor designed exclusively for this machine.*

Remove the batteries and disconnect the AC adaptor if you do not intend to use your machine for an extended period of time. When the power is disconnected, all messages in the working area and the memory will be lost.

It is recommended that you use the AC adaptor when printing large fonts and bar codes on 3/4" (18-mm)- or 1" (24-mm)-wide tape since these operations can quickly run down the batteries.

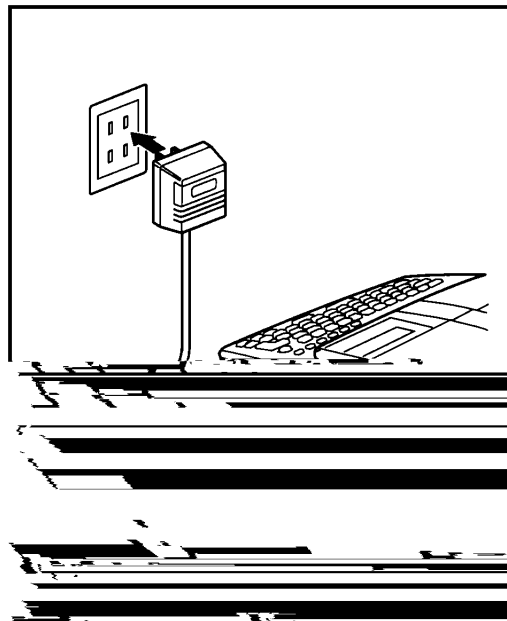

COMPUTER CONNECTION

This machine is equipped with a jack which allows you to print stamp and labels that you create with the P-touch EDITOR software installed on your IBM or compatible PC.

TO CONNECT THE COMPUTER:

- (1) Be sure both the P-Touch 580C and the computer are turned off.
- (2) Insert the small plug on the connection cable into the jack marked **INTERFACE** on the right of the P-Touch 580C.
- (3) Insert the large plug into the COM port of your IBM computer.
 - ☞ *Use the plug that is compatible with the COM port on your computer and leave the other plug unconnected.*
- (4) Turn on the P-Touch 580C, then start up the computer.
 - ☞ *Hold down the **CODE** key and press the **INTERFACE** key on the P-Touch 580C to enter Interface mode.*
Only use the connection cable designed exclusively for this machine.

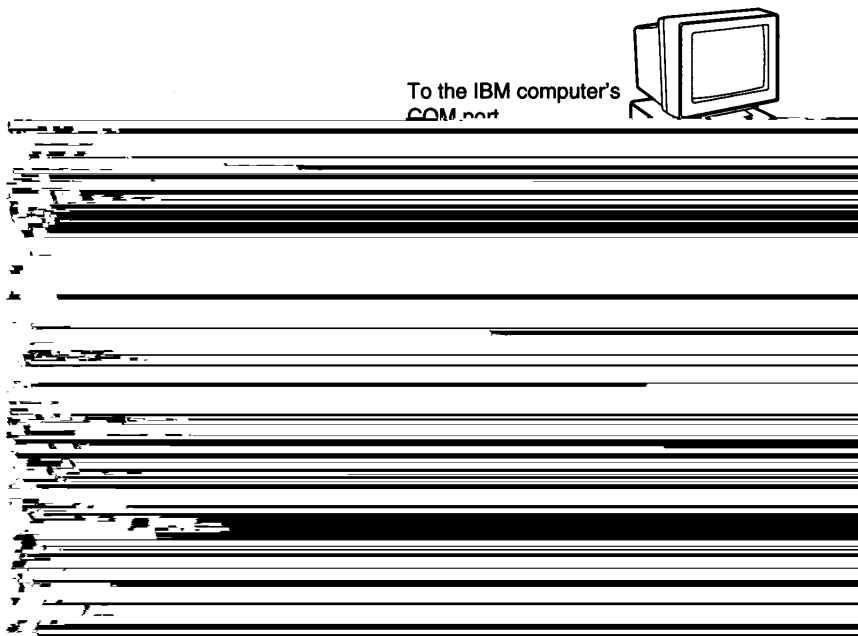

TAPE CASSETTES

A single TZ tape cassette is supplied with this unit. However, since TZ tape cassettes and multi-color ink and tape cassettes are available for this machine in a wide variety of colors and sizes, it is possible to make distinctive color-coded and stylized labels.

In addition, this machine has been designed to allow you to change the tape cassettes quickly and easily.

TO INSERT A TZ TAPE CASSETTE

- (1) Press down on the cover release button and lift open the compartment cover.
 - (2) If there is a cassette already in the compartment, remove it by pulling it straight up.
 - (3) Remove the stopper from a new tape cassette and if the ink ribbon in the cassette is loose, use your finger to wind the toothed wheel in the direction of the arrow on the tape cassette until the ribbon is taut. If you are using an old tape cassette, be sure the ribbon is taut before inserting it into the unit.
 - (4) Insert the tape cassette firmly into the compartment, making sure that the entire back of the cassette contacts the bottom of the compartment.
-  *When inserting the tape cassette, make sure that the inner ribbon does not catch on the corner of the metal guide.*
- (5) Close the compartment cover, then turn on the machine if necessary.
 - (6) Press the **FEED** key once to advance the tape and remove any slack.
 - (7) Push down on the tape cutter lever to cut off the excess tape.

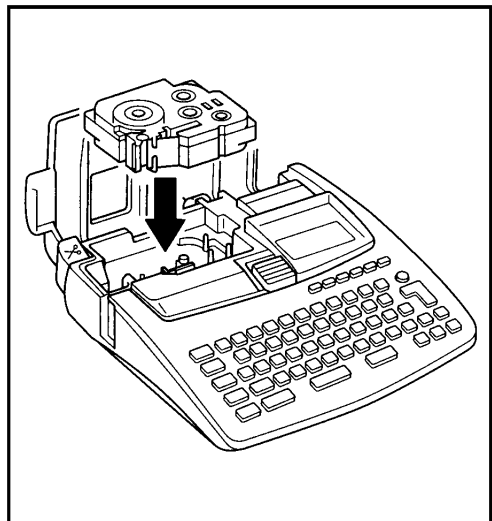
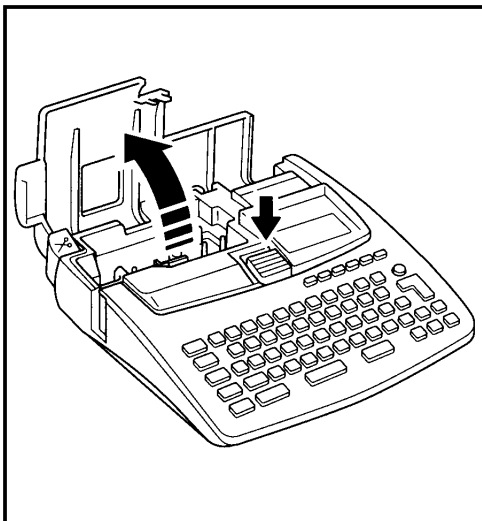

TO INSERT MULTI-COLOR INK AND TAPE CASSETTES:

- (1) Press down on the cover release button and lift open the compartment cover.
- (2) If there is a cassette already in the compartment, remove it by pulling it straight up.
- (3) If the ribbon in the ink cassette is loose, use your finger to wind the toothed wheel in the direction of the arrow on the ink cassette until the ribbon is taut. Then, insert the ink cassette straight down into the tape cassette.
- (4) Take the adhesive tape off the end of the label tape and pull out about 1/2" (12 mm) of label tape. If you are using an old tape cassette, be sure that the tape is sent through the cassette and the end of the tape goes under the tape guides.
- (5) Insert both the ink and tape cassettes firmly into the compartment.
 *When inserting the cassettes, make sure that the ribbon does not catch on the corner of the metal guide that the tape does not catch on the cutter.*
- (6) Close the compartment cover, then turn on the machine if necessary.
- (7) Press the **FEED** key once to advance the tape and remove any slack.
- (8) Push down on the tape cutter lever.

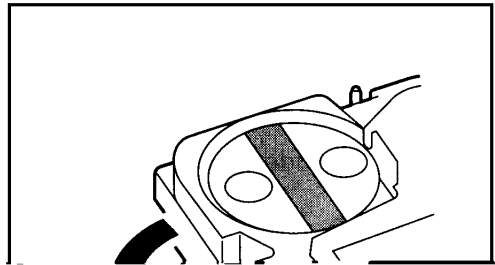
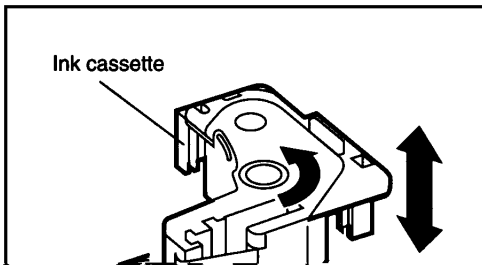

If too much of the tape is rewound back into the cassette:

- (1) Remove the tape and ink cassettes from the machine, then take the ink cassette out of the tape cassette.
- (2) Use your finger the tape into the tape cassette.

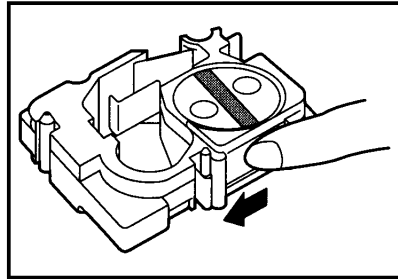

-  *If there is only a little tape left in the cassette, pull out some tape and put it into the slot with your finger.*

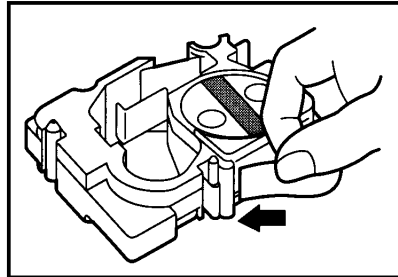

- (3) Use your finger to guide the end of the tape through the slot and around the cassette case.

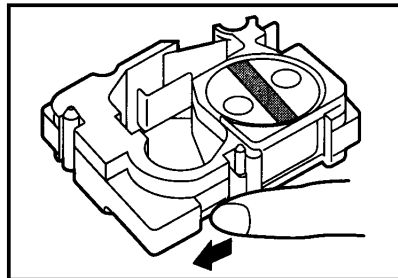

- (4) Slide the tape under the tape guides.

-  *Make sure the tape goes under the tape guide on the edge of the cassette case.*

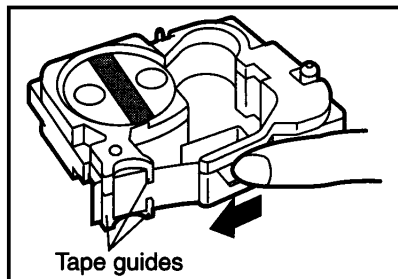

- (5) Hold the end of the tape and turn the tape roll counterclockwise to remove any slack.

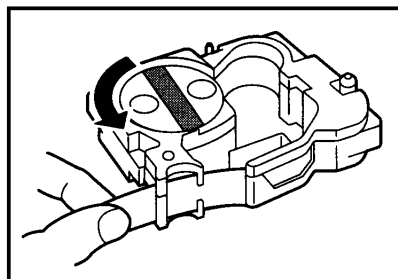

REMOVING THE LABEL BACKING

The enclosed stick enables you to remove the label backing from the tape easily.

- (1) Hold the tape in your left hand, with the printed surface facing up, and hold the stick in your right hand.
- (2) Pass the tape halfway through the long narrow hole in the stick.
- (3) After turning the stick three quarters of a turn towards you, pull the stick away from you as shown below.

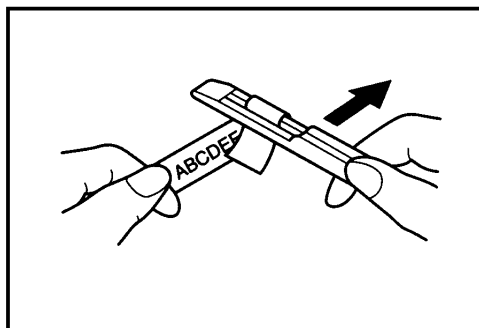
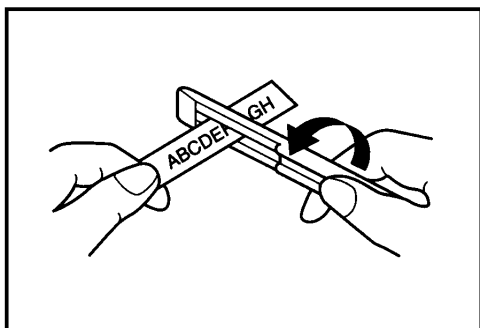

INSERT LETTERING TAPE (RUB-ON TRANSFERS)

Insert lettering tapes act as rub-on character transfers. After creating a message, position the label on a sheet of paper. Then, by simply rubbing the instant lettering tape's non-printed side with the enclosed stick or one available on the market, you can transfer the tape's contents directly onto the paper.

Caution: Hold the tape very firmly and do not move it while rubbing the tape.

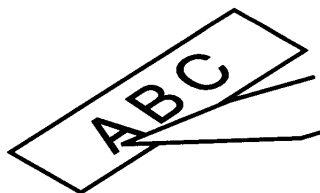
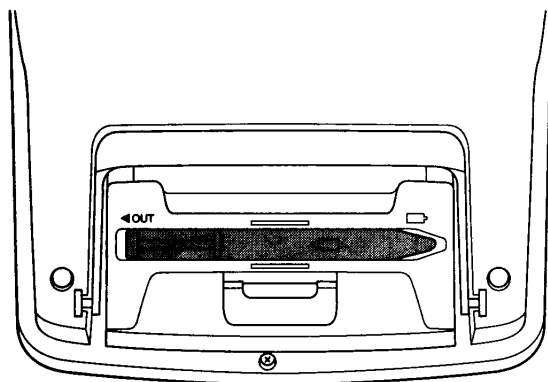

CLEANING THE PRINT HEAD AND ROLLERS

Occasionally, specks of dust or dirt become attached to the machine's print head and rollers. This is particularly likely when you are using the unit outdoors or in a very dusty environment. If a section of the print head is covered with dust, a blank horizontal streak may appear through the label message.

Therefore, as with a tape recorder, the machine's head may need to be cleaned from time to time.

TO CLEAN THE PRINT HEAD:

- (1) Turn off the machine.
- (2) Open the tape compartment cover and remove the tape cassette. The print head and rollers are located in the tape compartment.
- (3) Print head: Use a dry cotton swab to gently wipe the print head with an up-and-down motion.
Rollers: Use a dry cotton swab to wipe each roller with an up-and-down motion while rotating them with your finger.
- (4) Try printing again.

If dust still remains:

- (5) Repeat step (3) using a cotton swab dipped in isopropyl (rubbing) alcohol.

If none of the above works, contact your service representative.

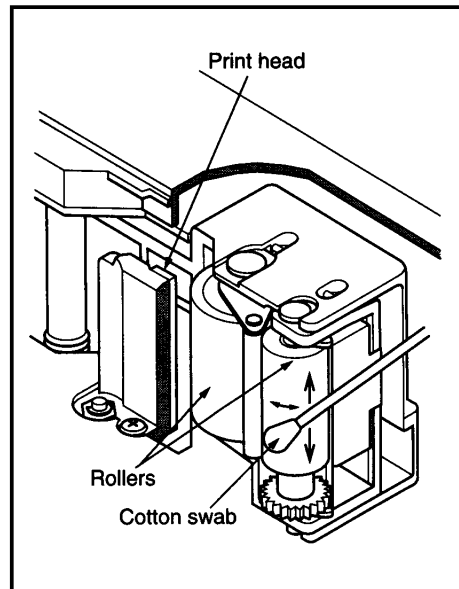
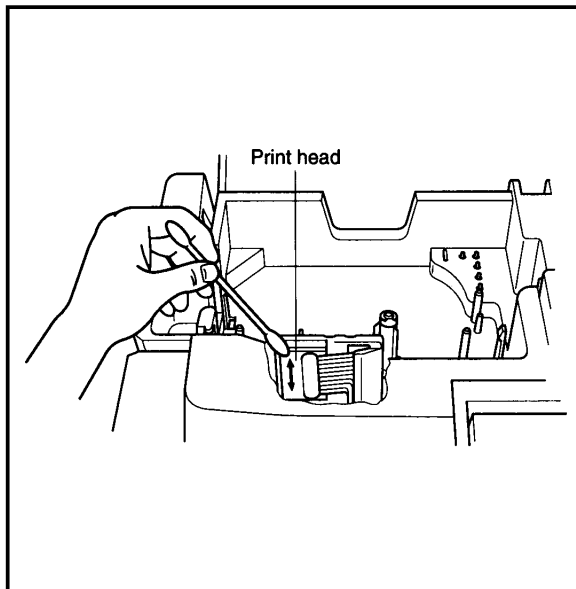

Learning the Ropes

INTRODUCTION

In *Learning the Ropes*, you will find a series of label-making examples. As the featured label designs become increasingly more complex, you will learn how to use the more advanced features of the machine. The first exercise consists of creating a simple one-line door sign. The second, an equipment instruction label, takes advantage of several additional machine capabilities. The third is a four-line address label. Finally, the storage shelf label shows you how to use the unit's more expert functions.

If you are a first time user, we suggest that you work through these exercises to become acquainted with the various features of this machine. Since they do not require much time, they can be done in four separate practice sessions or all at once.

The *Learning the Ropes* examples consist of the following parts:

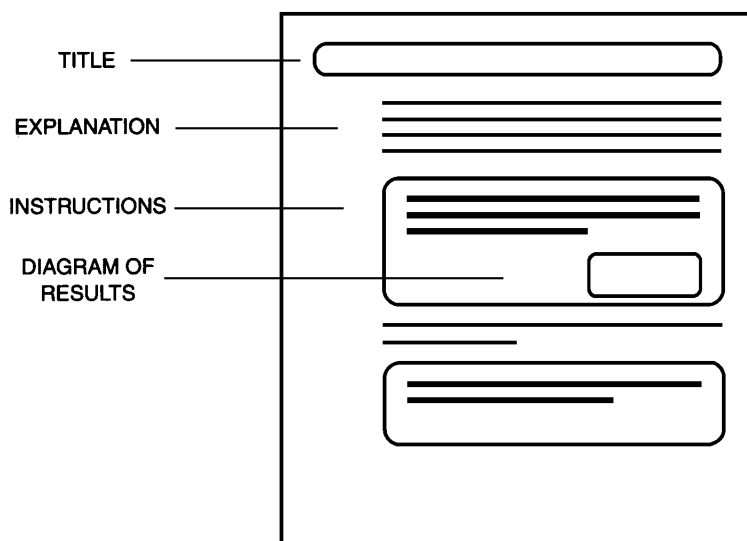

To best use this training section, simply follow the flow of the practice sessions. Read the background explanations, then follow the instructions, checking that your results match the diagrams provided. If you would like more detailed information about a particular point, simply check in the *For Your Information* section.

And now, let's see how easy it is to make beautiful labels with the P-Touch 580C!

Example 1

DOOR SIGN EXAMPLE

MEETING ROOM 

Let's begin by turning on the power to the machine. The power button is located in the top right-hand corner of the keyboard.

To turn on the machine:

- Press . When this machine is turned on, its display is in text entry mode.

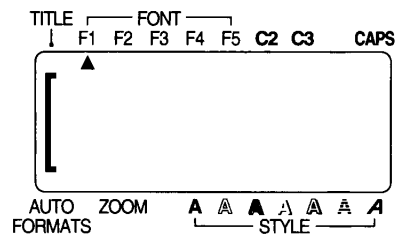

The text entry mode on this machine is WYSIWYG (What You See Is What You Get) mode, which allows you to see the label as it will appear after it is printed. The flashing mark resembling bracket is called a "cursor". The mark is like a pointer which shows your current position and lets you select certain characters in your text.

The message you create may sometimes be longer than this machine's LCD can display at one time. In this case, the cursor can be moved to view hidden parts of the text. If a character key or the cursor key is pressed when the cursor is on the right end of the display, the text scrolls to the left one character at a time and the cursor stays at the right side of the display. If the left cursor key is pressed when the cursor is on the left side of the display, the whole text scrolls to the right, leaving the cursor at its position in the text unless this would cause it to move beyond the display, in which case the cursor is positioned to the left of the last character on the right side of the display.

The format settings are shown by the triangles and circles which appear at the top and bottom of the display. The default settings shown when the power is

turned on for the first time have been preprogrammed into the machine and represent the most common style settings for labels. However, you can create your own formats and can even define local formats, which are special style settings for portions of text within the label. Detailed explanations for creating and editing global and local formats can be found in the *Global Formatting* and *Local Formatting* sections of *For Your Information*.

This machine is also equipped with an Auto format function which allows you to enter text and symbols into preset label templates. With the Auto format mode, you can enter text into common formats so labels can be create easily and printed quickly.

Now, let's begin entering the text for our first label. To do so, we must first input a capital "M".

To input a capital M (without using the Caps mode):

- Hold down **SHIFT** and press **M**.

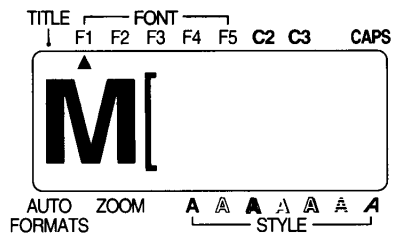

- Release **SHIFT** and type "eeting".

 Since the text is longer than the LCD display, part of the "M" moves off the display.

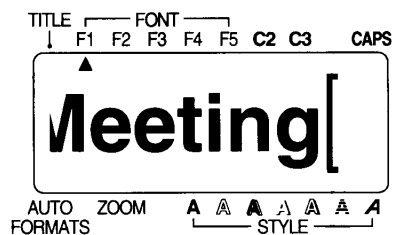

As on a typewriter, the **SPACE** key allows you to add a blank space in the message.

 The **SPACE** and **▶** keys different functions. The **▶** key moves the cursor forward through inputted text without adding blank spaces.

To complete the “Meeting Room” label:

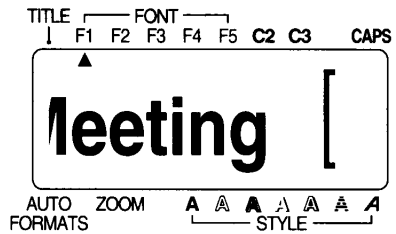

- Press  once to add a blank space.



Next, enter the word “Room”:



Once you have created a message, you can easily edit it by correcting mistakes or simply adjusting the text or style. For detailed explanations of text editing methods, see pages 63 to 65.



 The **BACKSPACE** key () allows you to remove characters from your message. The character immediately to the left of the cursor is deleted and all characters following the deleted character move one space to the left.

Now, let's revise this label using the **BACKSPACE** key to delete the lowercase letters in our message and use the Caps mode, which allows us to enter a string of capital letters without holding down the **SHIFT** key, to enter uppercase characters which are more appropriate for a door sign.

To delete lowercase letters and add uppercase letters:

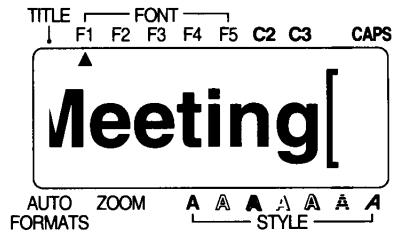
- Press  until the cursor is positioned just after the "g" in "Meeting".



- Press  to delete "eeting".
- Check the CAPS indicator at the top of the display. This indicates whether Caps mode is on or not. If the indicator is not lit, press  + . (The CAPS indicator should now come on.)

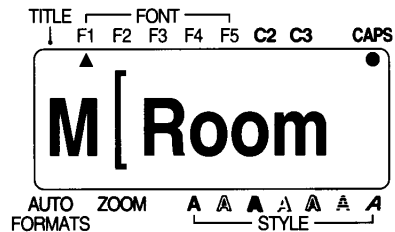

- Type "EETING". All letters automatically will be entered as uppercase without pressing .
- Now, do the same for the letters "oom" in "Room".

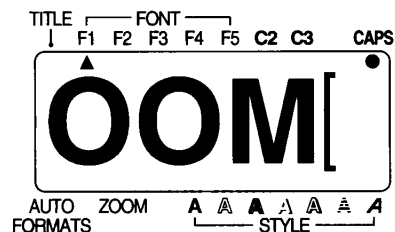

Finally, suppose we would like to add a no smoking symbol, just one of many available on this machine, to our door sign. A detailed explanations of symbol entry can be found in the *Symbols* section on page 52.

To add a no smoking symbol to the end of the message:

- Press once to add a blank space to the right of "MEETING ROOM".

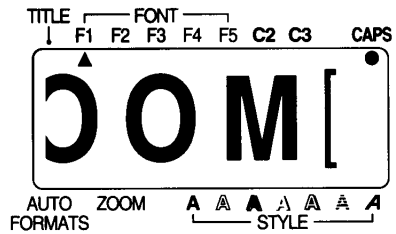

- Press + to display the first group of symbols.

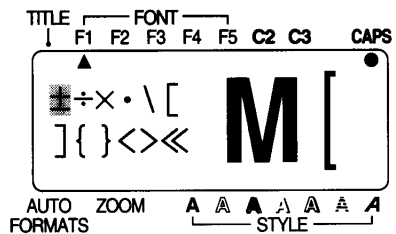

- Press or until the group with the no smoking symbol is displayed, then press

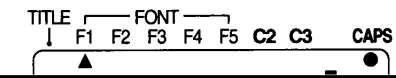

*You can press the **CANCEL** key at any time to return to text entry mode from Symbol mode.*

Since our message is finished, we can now print it. Though several print settings are available, we will use the default settings preprogrammed into the machine.

To print the label:

- Press .

Example 2

EQUIPMENT LABEL EXAMPLE



Place original face down.
Turn off when finished.
Repairs: 123-4567

 The label this example can be printed on 3/4" (18-mm)- or 1" (24-mm)-wide tape.

Although the entered characters may not seem to align properly in the LCD display, they will line up correctly on the printed label.

In this practice session, we will make a multi-line equipment instruction label.

To prepare for a new label:

- Turn on the power.
- If the previous work session's text data is still displayed, press  +  and the confirmation message "OK TO CLEAR?" is displayed.
- Press .

 Even after the text is cleared, Caps mode remains on.

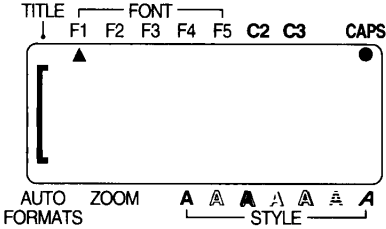

Let's assume we want to make an instruction label for an office photocopier. First, we will enter four lines of text containing both uppercase and lowercase letters, then edit it into a three-line label. If you have any questions about basic inputting, please review the previous example (Door Sign) or see pages 50 to 55 of *For Your Information*.

In our multi-line message, we will be using the **RETURN** key to end one line and start the next. This key operates like the Return on a typewriter by ending the current line and moving the cursor to the next line.

To enter a four-line message:

- Press **CODE** + **ALT CAPS** to turn Caps mode off. (The CAPS indicator should now go off.)
- Type "Place original face down."

 Since the text is longer than the LCD display, the first characters ("Place original face") move off the display to the left.

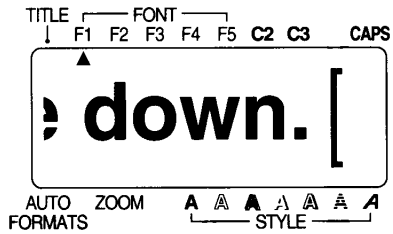

- Press **NEW BLOCK** to move the cursor to the next line so you can input another line of text.

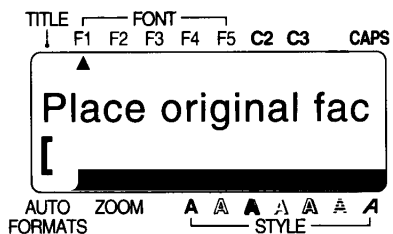

- Type "Turn off when finished." Again, the first characters will move off the display.
- Press **NEW BLOCK**.

- Then, type "Service Department" and press **NEW BLOCK**.

- Press **ZOOM** to enter Zoom mode and zoom in on the message so that it can be read more easily.

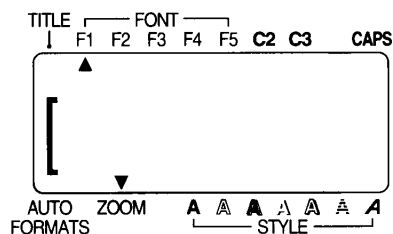

- To finish the message, type the Service Department's telephone number, "123-4567".

 To enter the dash (-), hold down **ALT CAPS** and press **/_**.

- Press **ZOOM** twice or **CANCEL** to return to text entry mode and check that the message is entered correctly.

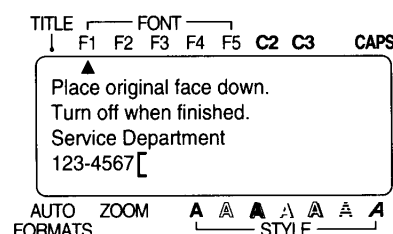

Press the **FORMAT** key at any time to view the current label formats. These settings can only be applied globally, i.e. to the entire message. For detailed explanations of the global format settings, see pages 93 to 103 of *For Your Information*.

To view the current label formats:

- Press **FORMAT**.

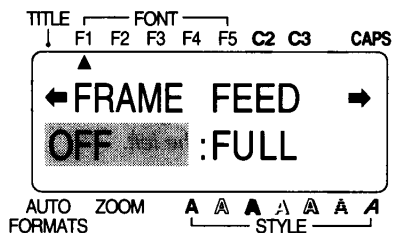

- Press and to scan through the format settings.

Pressing and changes the selected format setting.

Any time you wish to return to text entry mode from Format mode without changing any of the settings, simply press the **CANCEL** key. A detailed explanation of the **CANCEL** key can be found on page 60 of *For Your Information*.

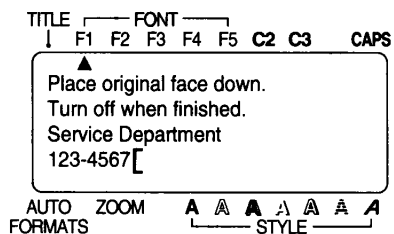

To return to the text entry mode:

- Press **CANCEL**.



Now, let's edit the message, changing it from four to three lines and adjusting some of the text.

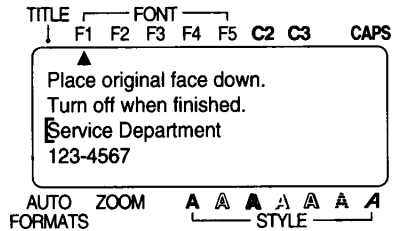

To edit the text message:

- Press  and  to move the cursor to the beginning of the third line.

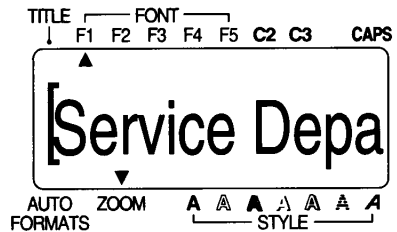

- Press  to zoom in on the message.



- Press  +  to delete all of the text in the third line.

 *The total number of lines changes from four to three.*

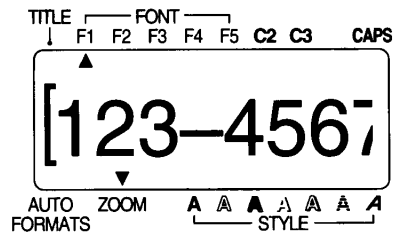

- Type "Repairs:" and add a space in front of the telephone number, "123-4567".

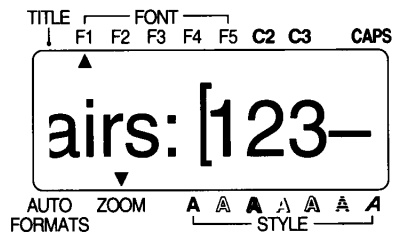

The message has been created and edited. If it were printed now, the standard default settings would be used. The text would be aligned at the left margin and would not be framed or underlined. In addition, the characters would be auto-sized and printed using font F1 (Helsinki) and a normal style. For more details concerning format settings, please see pages 75 to 103 of *For Your Information*. For this label, though, let's assume we want a different style of text: font F2 (Brussels), framed and horizontally centered. Therefore, we must change the format.

To change to font F2:

- Press **CODE** + **HOME** to move the cursor to the beginning of the message, then press **AREA**.

 The "P" will be highlighted, signifying that it will be included in the local formatting field.

- Then, use **END** and **RIGHT** to highlight all of the text.

The current FONT setting (F1) is indicated by the triangle.

- Press **FONT** until F2 is indicated, then press

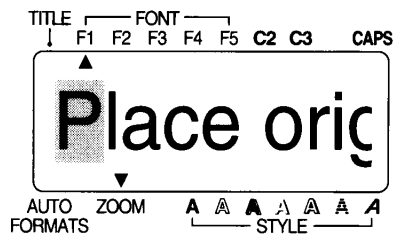

- Press **ZOOM** twice or **CANCEL** to return to text entry mode.

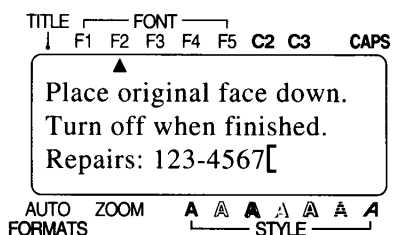
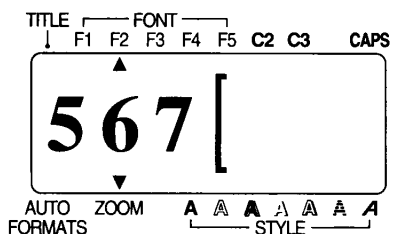

Different format settings can be chosen either before or after the text is entered. The procedure shown above can be used to edit the font, size, width, style, framing or shading, and color print settings or text already entered. With this procedure, the **AREA** and cursor keys are used to select the text, then the local format keys (Font, Size, etc) below the display allow you to change the settings. Another way of changing the format settings is to choose them before entering the text. With this method, the selected settings remain until they are changed again.

Since we wish to put a frame around the entire label and center the text, we will use the **FORMAT** key to enter these global format settings.

To edit the label formats:

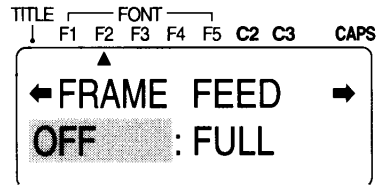

- Press **FORMAT**.

 *OFF is highlighted. This highlighting is like a cursor which shows the format setting that is currently "active". Items can only be changed when they are highlighted.*





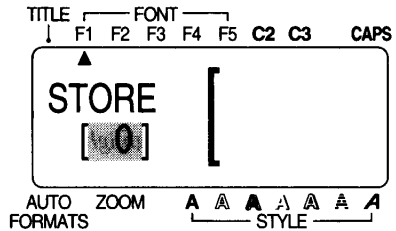

Now, let's take a look at how to store text files for future use and how to recall them when desired. Detailed explanations of the machine's memory can be found in the *Storing/Recalling/Deleting* section on pages 105 to 108.

To store the text file for future use:

- Press  + .





- Press . The text is stored as file "0" and can be recalled at any time.

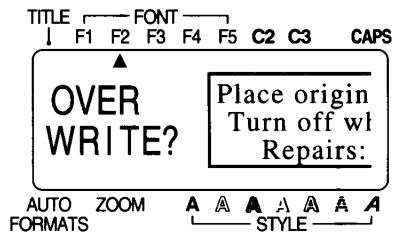

 A file can be assigned any number between 0 and 99 using  and .

Let's assume a file had already been stored as "0". In this case, the message "OVERWRITE?" would appear

when  is pressed.





- To overwrite the old file, press  to delete the old file and save the new one as "0".

 If you do not want to delete the previous file, press  to stop the operation.

Clearing removes all text from the working area. If you have not saved the information in the machine's memory, it will be lost. Since we have saved it, we can clear the working area without losing our work.

To clear the working area:

- Press  +  .
- Press  .

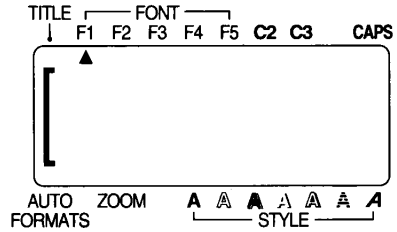

Now, even though it is no longer displayed on the LCD, we can recall our copier instruction text file and print it.

To recall the text file:

- Press  +  .

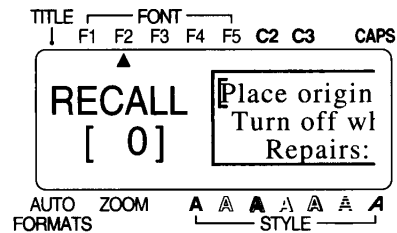

- Since the most recently stored file is displayed, which is, in this case, our desired

file, press  . The copier instruction file returns to the working area, where we can edit or print it.

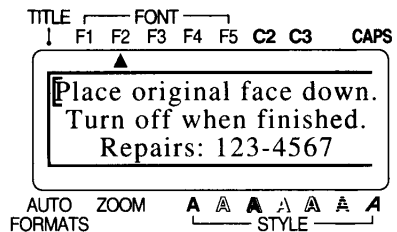

Finally, let's assume that we have three photocopier machines onto which we want to attach the same label. Therefore, we need to print three copies of the same text. A detailed explanation of the repeat printing function can be found in the *Printing & Special printing* section on pages 109 to 110.

To print three copies of the label:

- Press **CODE** + **SPECIAL PRINT PRINT**. The print options menu will be displayed.

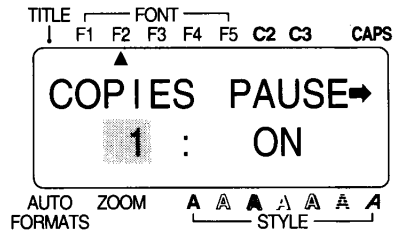

- Press **HOME** and **END** until the COPIES setting (currently 1) is set to 3.

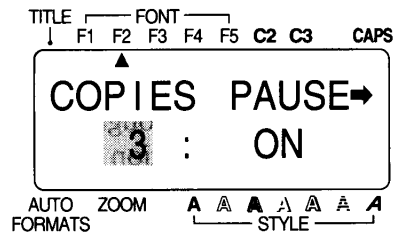

The TAUSE setting in Special print mode can be used to set whether or not the Machine will pause while printing copies of labels so the tape can be cut.

To print without pausing between copies of labels:

- Press **LEFT** and **RIGHT** to select the PAUSE setting.

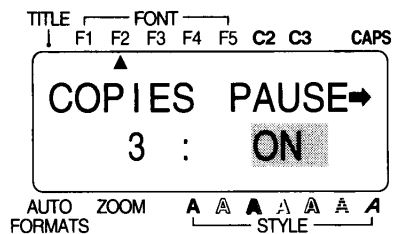

- Press **HOME** and **END** until the PAUSE setting (currently ON) is set to OFF.

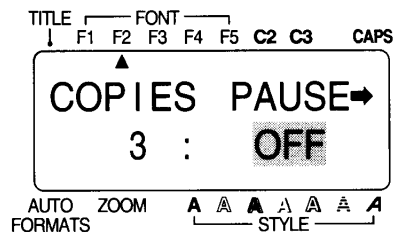

If we now wished to print three copies of the label, we could simply press the **RETURN** key. Three framed and horizontally-centered labels with characters using font F2 (Brussels) would be printed.

If the cut pause setting is turned off, the three copies would be printed continuously.

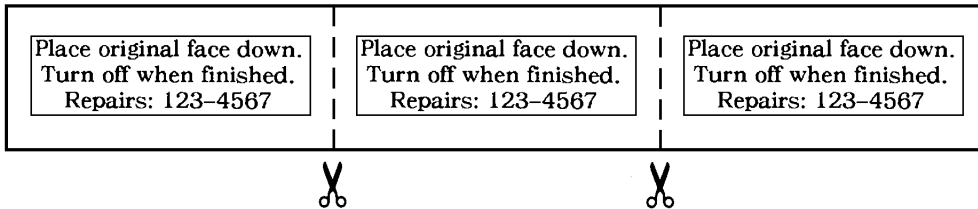

If the cut pause setting and been turned on, the machine would pause between the three copies so the tape could be cut.

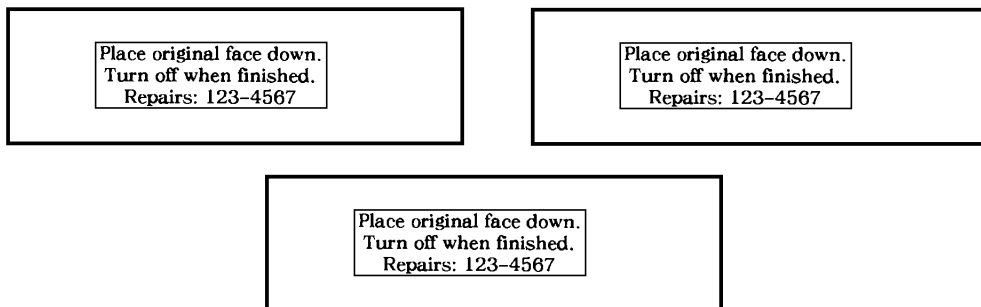

Since this would use quite a lot of tape for an example, we can now press the **CANCEL** key to escape from Special print mode and return to our text.

Example 3

ADDRESS LABEL EXAMPLE

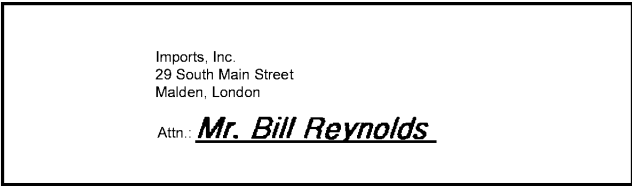

The label in this example can be printed on 3/4" (18-mm)- or 1" (24-mm)-wide tape.

Although the entered characters may not seem to align properly in the LCD display, they will line up correctly on the printed label.



In this quick practice session, we will make a multi-line address label with local formatting. The local formatting will be used to emphasize a certain portion of the message.

To prepare for a new label:

- Turn on the power.
- If the previous work session's text data is still displayed, press **CODE** + **CLEAR BS** and a confirmation message is displayed.
- Press **NEW BLOCK**.

Using the local format settings, we can now highlight a certain portion of our text by putting it in italics and underlining it. A detailed explanation of local formatting can be found on pages 79 to 92 and in the *Local Formatting* section on pages 75 to 76.

To emphasize the addressee's name:





- Press  until the cursor is positioned in front of the "M" in Mr.
- Press .

TITLE FONT
↓ F1 F2 F3 F4 F5 C2 C3 CAPS

 To: Mr. Messelton, 12345 Main St.

Now, let's assume we wish to print one copy of this label to attach to a package.

To print one copy of the label:

- Press  +  to display the print options menu.
- Press  and  until the COPIES setting (currently 3 from the previous example) is set to 1.
- Press  to begin printing.

Example 4

STORAGE SHELF LABEL EXAMPLE



 The label in this example can be printed on 3/4" (18-mm)- or 1" (24-mm)-wide tape.

Although the entered characters may not seem to align properly in the LCD display, they will line up correctly on the printed label.

In this final example, we will make a storage shelf label. This label would be used to describe the parts stored on a shelf. WYSIWYG text entry mode is very convenient when making complex, multi-block labels since it allows you to see the label as it will appear after it is printed.

Each time the number of lines changes, a new block of text must be created. Therefore, the text for our label must be entered in three separate blocks.

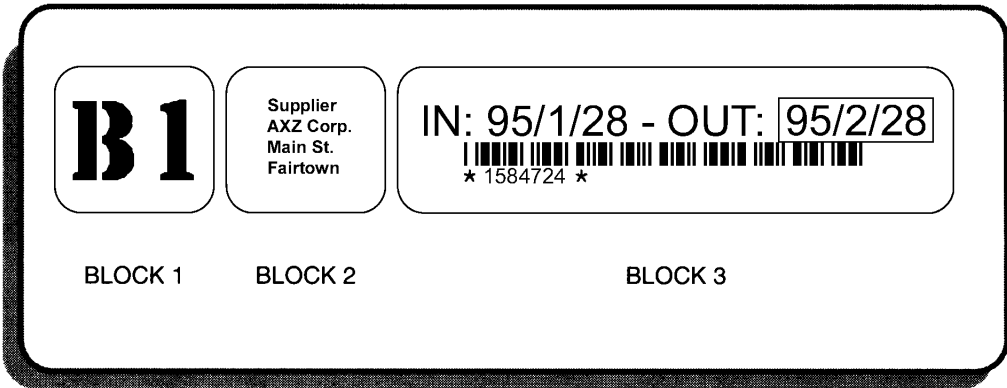

In this practice session, we will use local formatting and the multi-block applications as well as more specialized features, such as bar coding and numbering.

To prepare for a new label:

- Turn on the power.
- If the previous work session's text data is still displayed, press + and a confirmation message is displayed.

- Press .

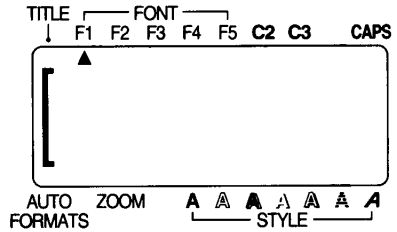

Now, we will enter the storage shelf label text.

To input the first block of text using font TITLE F1:

- Press until the TITLE and F1 indicators come on and the sample character is displayed in the font TITLE F1.
- Type "B1".

If you have any questions about basic inputting or editing, please review the previous examples or see For Your Information.

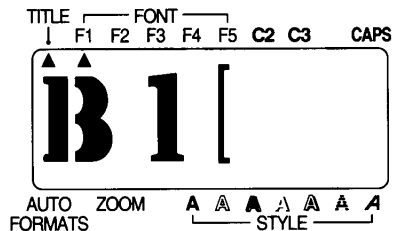

We now want to change from a one-line to a four-line block. In this case, we will not use a regular return, instead we will use the **NEW BLOCK** key.

A detailed explanation of multi-block labeling can be found in the *New Block* section of *For Your Information*.

To input the remaining text:

- Press + ↵ .

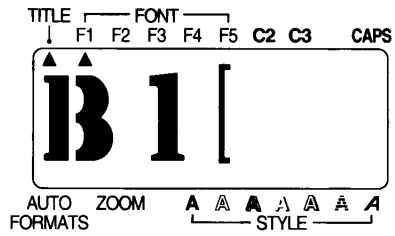

- Press until font F1 is selected and the sample character is displayed in the F1 font.

- Type "Supplier:" and press ↵ .

- Then, type "AXZ Corp." and "Main St.," pressing ↵ after each line.

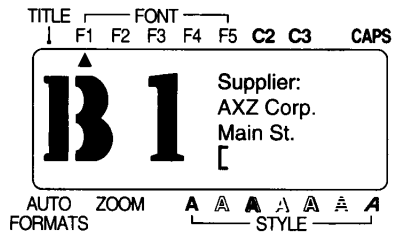

- Press to zoom in on the message.

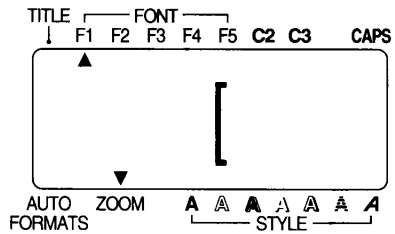

- Type "Fairtown".

- Press twice or to return to text entry mode.

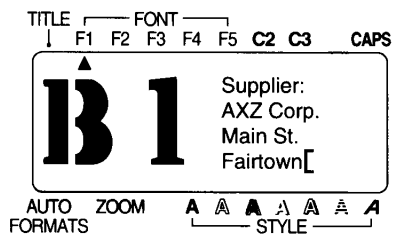

- Press + ↵ .

We now want to enter the text in the third block.

- Type "IN: 95/1/28 - OUT: 95/2/28" and

press ↵ . The cursor will move to the second line and the last characters of the line will move off the display.

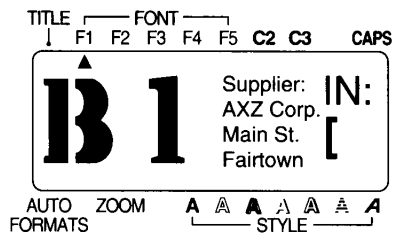

Now, we must enter the bar code information, the last portion of our message. Though many options exist for bar codes, let's assume you wish to use CODE 39 protocol with an undetermined (free) number of digits. A detailed explanation of bar coding can be found on pages 113 to 115. However, this explanation covers only the basics of this machine's bar coding function and is not intended as a comprehensive introduction to bar coding.

To enter Bar code mode:

- Press **CODE** + **BARCODE # 3**. The bar code setting screen will appear.

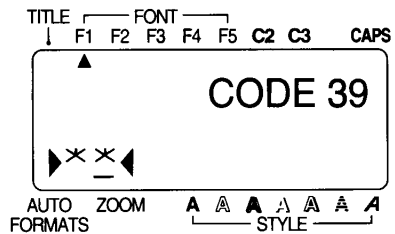

If we wished to use a different protocol or change any of the default bar code settings, we would press the **FORMAT** key. However, since we will use the default settings for this example, we can immediately input our data.

To enter the bar code data:

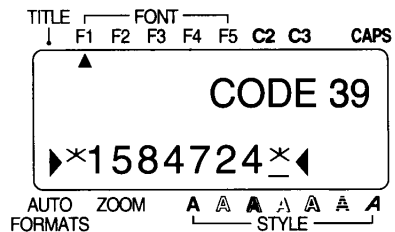

- Type the code, "1584724".



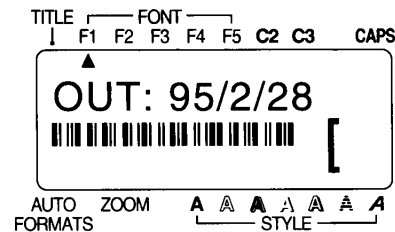

- Press **NEW BLOCK**.

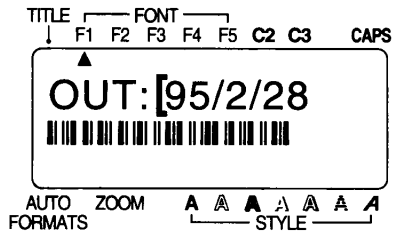

To emphasize the OUT date:

- Press  and  until the cursor is positioned to the left of the "9", the first character to be locally formatted.



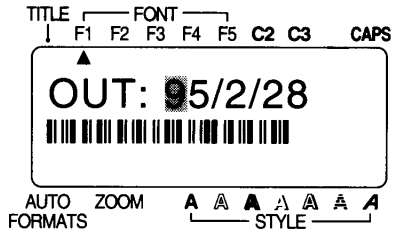

- Press .

 The "9" will be highlighted, signifying that it will be included in the local formatting field.

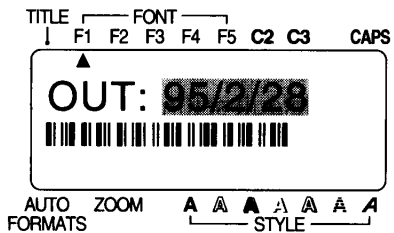

- Press  until the characters "95/2/28", all the characters to be locally formatted, are highlighted.



- Press  until the character STYLE setting changes to bold. (The indicator above **A** turns on.)

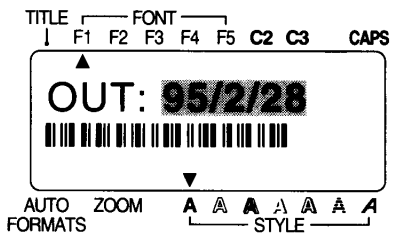

- Press  until the highlighted characters are framed with a rectangle.

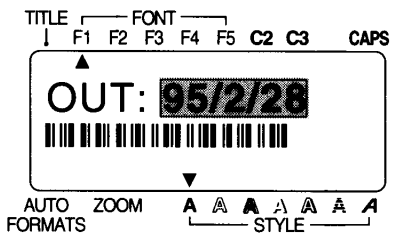

- Press . The characters "95/2/28" will now appear on the display with their own special local format: bold style and framed.

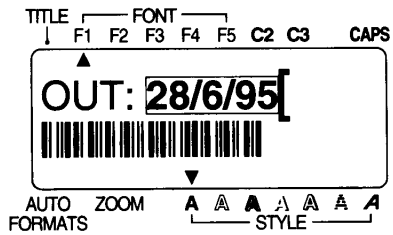



Next, we will practice using the numbering function. This feature is particularly useful for serial numbers and other codes which require sequential numbering. In this example, let's assume that we would like to increase the "1" in our parts code while the bar code information remains the same.

To make "1" a numbering field:

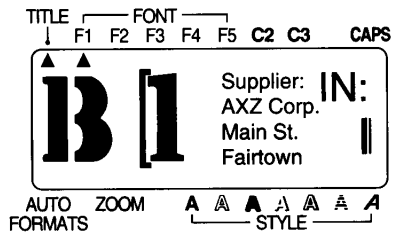
- Press  until the cursor is positioned to the left of the "1" in the parts code, the only number to be included in the numbering field.



- Press  +  and the message "SELECT FIELD!" is briefly displayed.

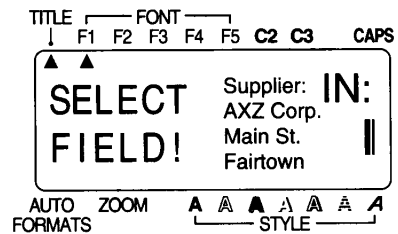



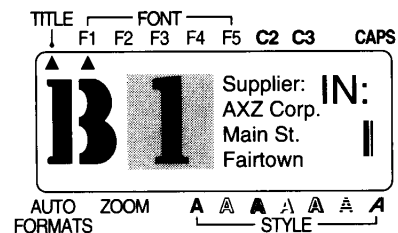

Then, the selected character will be highlighted.

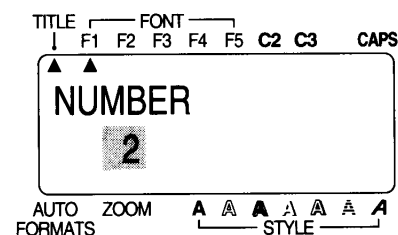



- Press  to select the numbering field and the NUMBER setting screen is displayed.



- Press  or  to print two copies of the label using the standard print settings. The number of the copy being printed is shown on the display.

 If you wished to print labels "B1", "B2" and so on, up to "B5", for example, press  and  until 5 is displayed under the NUMBER setting

before pressing  or .

The parts code increases automatically. After the designated number of labels have been printed, the numbering field of the label in the display increases to the next value after the last one in the printed series.

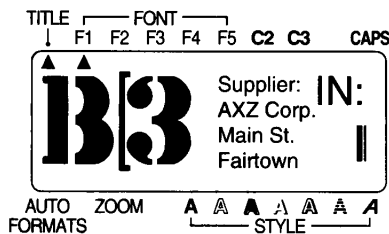
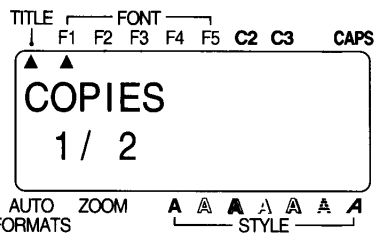

With the numbering feature, the numbers or letters included in the field will automatically increase when each labels is printed. A detailed explanation of this function can be found in the *Sequential Numbering* section on pages 58 to 59.

Congratulations! This completes the fourth and final practice session in *Learning the Ropes*. We hope that these exercises, which cover most of this machine's features, have been both informative and enjoyable. If you wish, you can now go back and repeat any of these exercises, practice on your own or begin making your own labels. If you have questions about any of the operations, please turn to the *For Your Information* section of this manual.

***For Your
Information***

INTRODUCTION

In *For Your Information*, you will find detailed explanations of all the machine's features. Each topic is given its own page, making this reference section easy to use.

Operational examples of most features can also be found in the *Learning the Ropes* practice sessions. If you are a first time P-Touch user, we suggest that you work through these exercises before starting to make labels on your own.

This *For Your Information* section provides supplementary information. When you have a question about a particular point, locate that topic in the "finding Your Way" contents list and turn to the page indicated.

FINDING YOUR WAY

This *For your Information* reference guide gives detailed explanations of all of this machine's features. The following list shows which topics are covered and on which page an explanation of their operation can be found.

	PAGE		PAGE
INPUTTING		Text Formats:	
Power Button	48	Font	79
Cursors	49	Size/Width	81
SHIFT, ALT & CAPS	50	Style/Italic	83
CODE key	51	Underlining/Framing	86
Symbols	52	Multi-Color Printing	87
Composite Characters	54	Label Formats:	
Return	55	Framing	93
New Block	57	Tape Feed	94
Sequential Numbering	58	Vertical Printing	95
Cancel	60	Mirror Printing	96
CURSOR MOVEMENT	62	Horizontal Alignment	97
EDITING		Vertical Alignment	98
Backspace	63	Length	99
Line Out	64	Display Units	100
Clear	65	Colored Frames/Shading	101
DISPLAYING		Colored Characters	103
Zoom Mode	66	MEMORY	
Label Length	67	Storing/Recalling/Deleting	105
Contrast	68	PRINTING	
FORMATTING		Normal, Multiple & Split	
Auto Formats	69	Printing	109
Local Formatting	75	Making Stamps	111
Global Formatting	77	BAR CODING	113

POWER BOTTON

BACKGROUND

The power button is located in the top right-hand corner of the machine's keyboard. When the power is turned on, the previous session's information is displayed. The machine will automatically turn off if no key is pressed within 5 minutes. In Interface mode, however, the machine will automatically turn off if it is not used for 10 minutes.

If batteries have been installed in the machine or if it has been plugged in using the optional AC adaptor, the machine's internal memory will retain the last message created and display it after the machine is turned on. This automatic backup feature allows you to stop work on a message, turn off the machine and return to later without having to re-enter the message.

 *When the AC adaptor is plugged into the machine, unplugging the adaptor from the AC outlet can delete the contents of the memory, even if batteries are installed.*

If six AA alkaline batteries have been installed or if the machine is plugged into an AC outlet using the AC adaptor, all data in the machine's memory will be retained. When changing the batteries, be sure to insert the new ones within five minutes of removing the old batteries, otherwise the messages in the working area and the memory will be lost.

The power button can also be used to "reset" the machine. This reset function is useful in two situations:

TO RESET THE MACHINE:

- (1) Turn the power off.
- (2) Hold down the **CODE** and **R** key and turn the power back on.

Since all text files and format setting changes will be cleared from the memory this should be done only as a last resort.

CURSORS

BACKGROUND

This machine has two different types of cursors.

The first, which resembles a bracket (|) in text entry mode or an underline in Auto Format or Bar Code mode, makes your current position in the text. Its operation is nearly identical to that of cursors on electronic typewriter or word processors. You can review and edit different parts of your message by moving the cursor backwards, forwards, up and down. Eight keys (◀, ▶, ▲, ▼, HOME, END, ◀◀ and ▶▶) let you move this cursor. Their operations are explained in the *Cursor Movement* section.

While the text cursor is used to mark or select points in text messages, another type of cursor allows you to choose characters and various settings. When a setting is highlighted, that setting is currently “active”. For example, if the box setting (y) is highlighted below the framing setting (FRAME) in Format mode, the characters are framed with a rectangular box. Also, when you select text fields for numbering or local formatting, the currently selected characters will be highlighted.

Both of these cursors — the text cursor for pointing and the highlighting cursor for choosing — help you create, view and edit label messages.

EXAMPLE

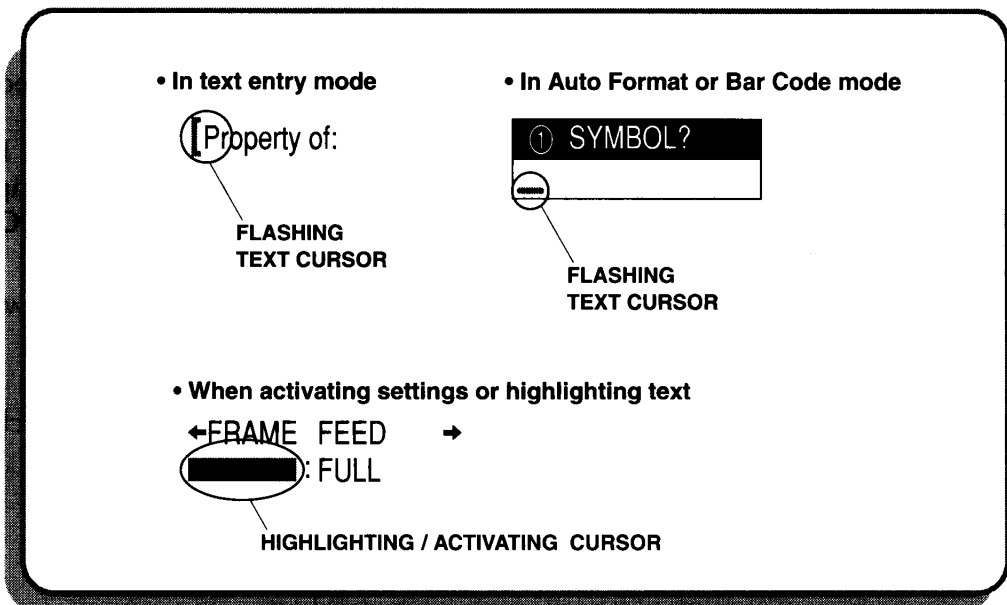

SHIFT, ALT & CAPS

BACKGROUND

Most characters can be entered simply by pressing their keys. However, to enter uppercase letters, accented characters and some common symbols, three special keys are necessary.

SHIFT KEY: This key allows you to type symbols located on the upper part of the keys and capital letters; however, capital letters of characters written in red must be entered using the **ALT** key in Caps mode. To type a capital "A", hold down the **SHIFT** key and press the **A** key.

CAPS KEY: The **SHIFT** key is very useful for inputting a single capital letter, for example, at the beginning of a name. However, when you wish to enter a series of uppercase letters, the **CAPS** key should be used. When this mode is on, the CAPS indicator at the top the LCD display comes on.

 *Using the SHIFT key in Caps mode will produce lowercase letters. TITLE fonts will only produce uppercase letters.*

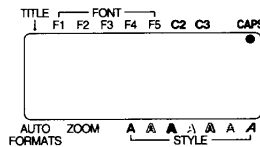

In Caps mode, uppercase letters can be typed simply by pressing the character keys (i.e. pressing the **SHIFT** key is not necessary). However, when number keys are pressed, numbers — not the symbols above them — appear. Holding down the **ALT** key and pressing a key for a character written in red types in the capital letter of that character. To exit Caps mode, hold down the **CODE** key and press the **CAPS** key. The indicator will go off.

ALT KEY: The **ALT** key allows you to input characters and symbols written in red on the keys.

TO ENTER A CHARACTER WRITTEN IN RED:

Hold down the **ALT** key and press the key of the desired character written in red. To exit Alt mode, release the **ALT** key.

CODE KEY

BACKGROUND

While the **SHIFT**, **CAPS**, and **ALT** keys allow you to select various characters and symbols, the **CODE** key allows you to choose various functions. Functions written in green can be selected by pressing the **CODE** key.

EXAMPLE

To use the memory recall function:

- Press + .

To enter Symbol mode:

- Press + .

SYMBOLS

BACKGROUND

This machine has many special marks and symbols that can be entered into your text. When entered, they act like normal characters and can be both edited and deleted.

Though several symbols can be found on the machine's key tops, 126 additional marks are available in Symbol mode.

OPERATION

TO ENTER A NON=KEYTOP SYMBOL:

- (1) Hold down the **CODE** key and press the **SYMBOL** key to enter Symbol mode.
- (2) Press the **▲** and **▼** keys until the symbol you wish to enter appears on the display.
- (3) Press the **▶** and **◀** keys until the symbol is highlighted.
- (4) Press the **RETURN** key to enter the symbol into your message.

 *To enter a sequence of symbols, select a symbol, then hold down the **CODE** key and press the **RETURN** key. Continue selecting symbols in this way and press just the **RETURN** key after the last symbol in the sequence is chosen.*

The 126 symbols in Symbol mode cannot be entered in a bar code.

LIST

•	+	×	÷	=	®	©	™	[]	§	1/2
☎	♥	★	♫	◊	Æ	æ	↑	↓	→	←	○
①	②	③	④	⑤	⑥	⑦	⑧	⑨	⑩	±	0
1	2	3	4	5	6	7	8	9	-	+	±
0	1	2	3	4	5	6	7	8	9	-	+
✂	✂	✂	✂	✂	✂	✂	✂	✂	✂	✂	✂
✂	⚡	☠	⊘	🍷	🔥	♿	👏	☔	☀	🧑	♻️
🐼	🎀	👶	🍷	👶	👶	👶	🎂	🎬	👁	👤	🔍
🔑	⊕	👤	🏀	🏆	👏	👶	👶	💣	📖	🎯	🏠
👶	🐱	👤	🐾	👙	🐌	👶	🐼	🐟	🚲	🍷	🍴
🍇	🍏	🍦	🍺	🍔	🍉						

COMPOSITE CHARACTERS

BACKGROUND

In alphabets other than the English alphabet, composite characters, which consist of a letter and a diacritical mark, are often used. This machine can also display and print these characters. The diacritical marks available are ` , ´ , ` , ^ , ~ and ,.

Several composite characters can be found on the key tops. Characters such as á, é, and ü can be entered in the same way as other characters. Before inputting a composite character as described below, check whether it is already available as a keytop character.

Diacritical Mark	Letters which can be used
¨	A E I O U a e l o u
´	A E I O U a e l o u
`	A E I O U a e l o u
^	A E I O U a e l o u

OPERATION

TO INPUT A COMPOSITE CHARACTER:

- (1) Enter the diacritical mark needed for the composite character.
- (2) Type the letter you wish to combine with it.

 *The diacritical mark and the letter will alternately appear on the display. If the letter cannot be combined with the diacritical mark (see the above chart), the chosen letter will take the place of the mark.*

If you press a cursor movement key or the **PRINT** key after inputting a diacritical mark, nothing will occur. To continue inputting your message, you must either enter a character or delete the mark with the **CANCEL** key or the **BACKSPACE** key.

RETURN

BACKGROUND

The **RETURN** key is located on the right side of the keyboard. It is the largest, and one of the most often used keys. The **RETURN** key has three basic functions:

TO END A LINE:

Line the **RETURN** key on a typewriter or word processor, this machine's **RETURN** key lets you end one line of the text and begin another. While entering the message, press the **RETURN** key when you have finished entering one line and wish to start the next. The cursor moves to the next line on the LCD display.

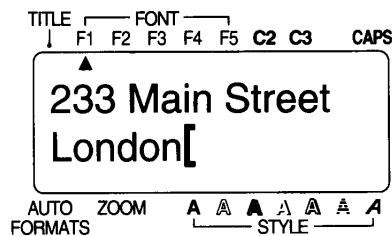

Press the **RETURN** key.

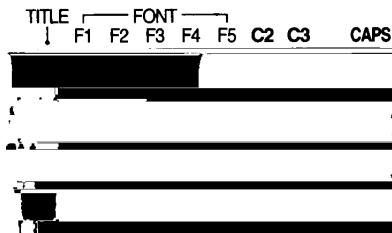

*The maximum number of the text lines in a single block is five. If the cursor is located on the fifth line and you press the **RETURN** key, an error message will appear.*

*Since a block can only contain one text line when a **TITLE** font is used, an error message will appear if the **RETURN** key is pressed.*

Tape width	Maximum number of lines that can be printed
1/4" (6 mm)	2
3/8" (9 mm)	3
1/2" (12 mm)	3
3/4" (18 mm)	5
1" (24 mm)	5

TO ENTER AND CHOOSE ITEMS:

The **RETURN** key can also be used to enter and choose items. For example, in Symbol mode, a large group of symbols are displayed. After you have chosen the symbol that you want to appear in your message, it will be highlighted, signifying that it is the “active” symbol. If the **RETURN** key is pressed, that symbol will be entered into your text message. In addition, after creating a text format, pressing **RETURN** key applies the currently displayed settings to the current label.

TO ANSWER “YES”:

Prompt questions sometimes appear on the LCD display, especially when the function that you have chosen will delete or affect files. In these cases, pressing the **RETURN** key is like answering positively. To answer “no”, press the **CANCEL** key.

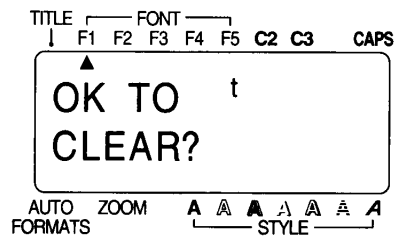

If “yes”, press the **RETURN** key.

If “no”, press the **CANCEL** key.

NEW BLOCK

BACKGROUND

Any time the number of lines in a section of the label changes, a new block must be created. Creating a new block is different from local formatting, which change the type style within that line or those groups of lines.

Compare these two labels:



AXZ CORP. (123)456-7890

This is simply a single-block, single-line label with local formatting. After all the text has been typed in, the position "(123) 456-7890" is assigned a smaller character size.



B1 Supplier
AXZ Corp.
Main St.
Fairtown IN: 1/28
OUT: 2/28

This is a multi-block label. The first portion of this label is a single line, the second is four lines and the third, two lines. Therefore, when entering this type of text message, the **NEW BLOCK** key must be used.

After typing the first block of text, hold down the **CODE** key and press the **NEW BLOCK** key. The cursor will appear at the beginning of the first line in the next block.

 *The maximum number of blocks in a single label is five. If the cursor is located in the fifth block when the **CODE** key is hold down and the **NEW BLOCK** key is pressed, an error message will appear.*

*When the cursor is positioned in the middle of a text block, holding down the **CODE** key and pressing the **NEW BLOCK** key causes the current block to be split into two.*

OPERATION

TO ENTER THE TEXT FOR THE LABEL



TOMMY CLASS 2
ROOM 104 :

- (1) Type "TOMMY".
- (2) Since the next portion of text is a new two-line block, hold down the **CODE** key and press the **NEW BLOCK** key.
- (3) Type "CLASS 2".
- (4) Press the **RETURN** key.
- (5) Type "ROOM 104".

SEQUENTIAL NUMBERING

BACKGROUND

This machine's numbering feature allows you to designate a group of numbers and letters or a bar code as a "numbering" field and print a set number of label in which the numbering field automatically increases by 1 after a label is printed. For example, a numbering field of 124 becomes 125. This type of automatic increment is very useful for printing serial number labels, production control labels or other labels requiring ascending codes.

OPERATION

TO DESIGNATE A PORTION OF TEXT AS A NUMBERING FIELD:

- (1) Position the cursor in front of first character (number or letter) or the bar code you wish to include in the field.
- (2) Hold down the **CODE** key and press the **SEQ. NUMBERING** key. The message "SELECT FIELD!" is briefly displayed. The first character is highlighted, indicating that it is "active".
- (3) Use the **▶** and **◀** keys to highlight all the characters to be included in the field.

 *The numbering field cannot contain characters with different format settings.*

A numbering field can consist of a single bar code; no additional characters can be included in that numbering field.

A numbering field must be located entirely within one line of text of a single block. If you try to include text from two different lines or two different blocks in the numbering field, an error message will appear on the display.

- (4) Press the **RETURN** key. The NUMBER setting screen will be displayed.
- (5) Press the **▲** and **▼** keys until the desired setting appears. For example, if you want to count up from 10 to 15, set NUMBER to 6.
- (6) Press the **RETURN** or **PRINT** key. After the set number of labels have been printed, the display shows the label with the numbering field increased to the next value.

 *In any text message, only one numbering field can be selected.*

The maximum number of characters in a numbering field is five. If you try to choose more than five characters, an error message will appear.

If you include a non-alphanumeric character such as a symbol in the numbering field, only the characters in the numbering field that can be increased will increment when the labels are printed, or only one label will be printed if only a non-alphanumeric character is included in the field.

- Letters and numbers automatically increase in the following manner:

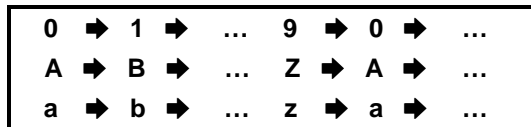

- Spaces (shown as “_” in the table below) can be used to control the number of digits printed:

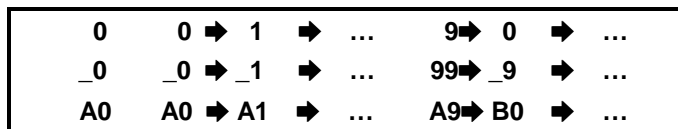

Spaces between letters in the numbering field simply adjust the space between them on the printed labels.

CANCEL

BACKGROUND

The **CANCEL** key is located in the bottom row of the keyboard. It has two basic functions.

TO LEAVE AN OPERATION MODE WITHOUT TAKING ANY ACTION:

In general, the **CANCEL** key returns you to the previous screen or activity. For example, if you enter an operation mode but decide you want to return to text entry or editing, you can press the **CANCEL** key.

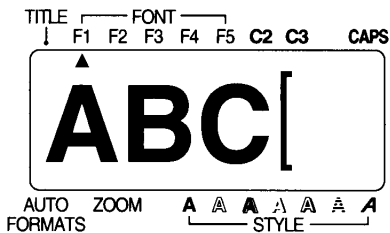

Press the **FORMAT** key to enter Format mode.

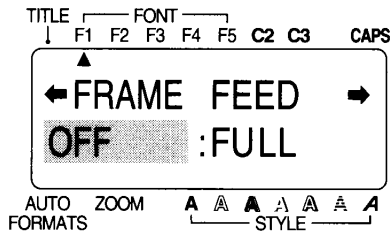

To escape from Format mode without changing any settings, press the **CANCEL** key.

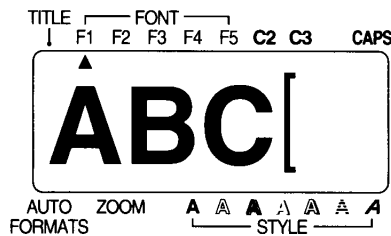

You will return to text entry mode.

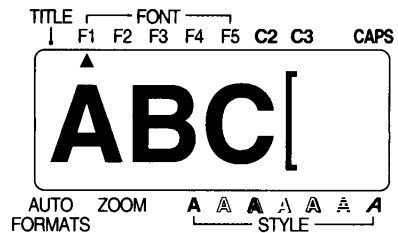

Hold down the **CODE** key and press the **SPECIAL PRINT** key to enter Special print mode.

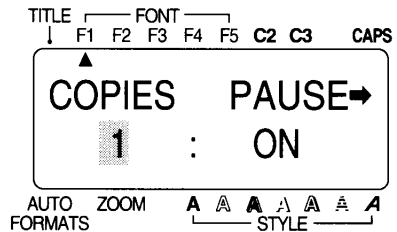

To escape from Special print mode without printing, press the **CANCEL** key.

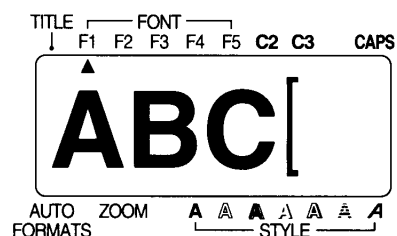

You will return to text entry mode.

TO ANSWER “NO”:

Prompt questions sometimes appear on the LCD display, especially when the function that you wish to perform will delete or affect files. In these cases, pressing the **CANCEL** key is like answering negatively. To answer “yes”, press the **RETURN** key.

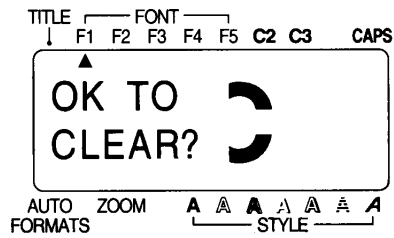

— If “no”, press the CANCEL key.

— If “yes”, press the RETURN key.

☞ *When an error message is displayed, pressing the **CANCEL** key allows you to return to what you were doing previously.*

CURSOR MOVEMENT

BACKGROUND

After you have created a message, moving the cursor allows you to view or edit different parts of the text.



In general, pressing this key moves the cursor one space or character to the left. If the cursor is positioned at the beginning of a line when this key is pressed, the cursor moves to the end of the previous line.

Holding down the **CODE** key and pressing this key moves the cursor just before the first character of the current text block. If these keys are pressed again, the cursor moves to the first character of the previous block.

Holding down the **SHIFT** key and pressing this key moves the cursor to the beginning of the current line of text.



In general, pressing this key moves the cursor one space or character to the right. If the cursor is positioned at the end of a line when this key is pressed, the cursor moves to the beginning of the next line.

Holding down the **CODE** key and pressing this key moves the cursor just before the first character of the next text block.

Holding down the **SHIFT** key and pressing this key moves the cursor to the end of the current line of text.



Pressing this key moves the cursor just before the character in the previous line directly above its current position.

Holding down the **CODE** key and pressing this key positions the cursor at the beginning of the message.



Pressing this key moves the cursor just before the character in the next line directly below its current position.

Holding down the **CODE** key and pressing this key positions the cursor at the end of the message.

BACKSPACE

BACKGROUND

The **BACKSPACE** key allows you to remove unwanted characters from your message. It differs from the **←** key, which simply moves the cursor without changing the message. The **BACKSPACE** key, however, removes the character preceding the cursor.

OPERATION

TO DELETE A CHARACTER:

- (1) Using the cursor movement keys, position the cursor immediately to the right of the character you want to delete.
- (2) Press the **BACKSPACE** key.

EXAMPLE

General operation:

- Press  five times.

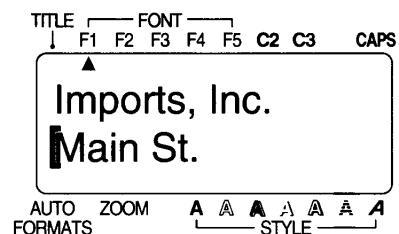
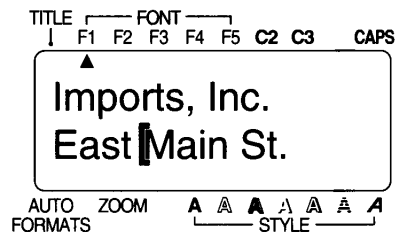

If the cursor is located in front of the first character in a line when this key is pressed, the two lines are joined together.

- Press .

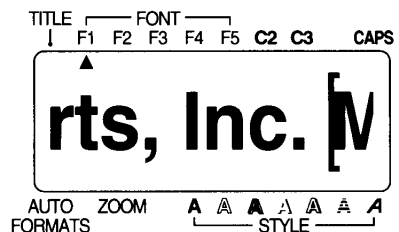

The **LINE OUT** key allows you to remove unwanted lines of text from your

CLEAR

BACKGROUND

The **CLEAR** key allows you to remove all text and symbols from the display and return the text formats to their default settings. In other words, the current text files is completely emptied. You can then begin entering an entirely new text message.

OPERATION



TO CLEAR A TEXT FILE:

- (1) Hold down the **CODE** key and press the **CLEAR** key.
- (2) Press the **RETURN** key.

 The cursor can be located anywhere in the message.

EXAMPLE

General operation:

- Press  +  and a confirmation message is displayed.

- Press .

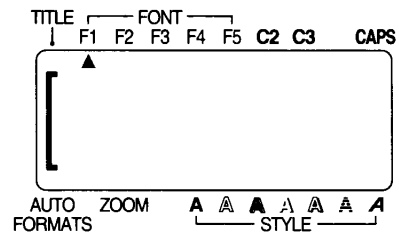
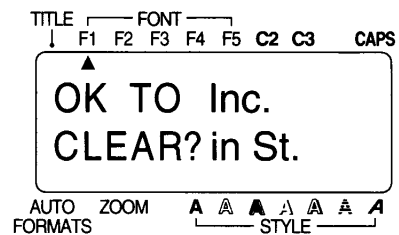
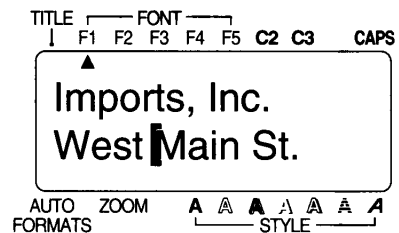

ZOOM MODE

BACKGROUND

Zoom mode allows you to see how a label will appear when it is printed by zooming out from the text, or to see parts of the message in detail by zooming in. The cursor keys can be used to move the cursor so different parts of the message can be seen.

OPERATION

TO ENTER ZOOM MODE:

- (1) Press the **ZOOM** key and the display zooms in to enlarge the message.
- (2) Press the **ZOOM** key again and the display zooms out to show the message as it will appear when it is printed.
- (3) Press the **ZOOM** key one more time or the **CANCEL** key to return the display to the text entry screen.

EXAMPLE

General operation:

- Press . The display zooms in on the message.

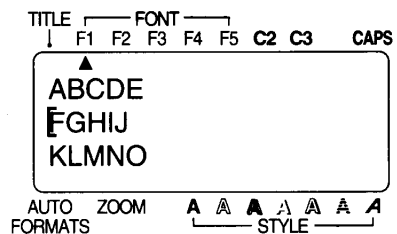

- Press . The display zooms out from the message.

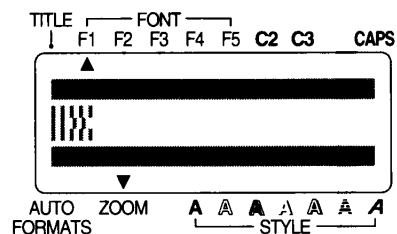
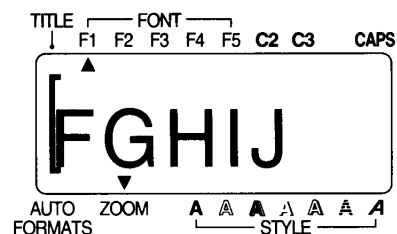

LABEL LENGTH

BACKGROUND

This mode briefly displays the length of the label in either inches or centimeters depending on the UNIT setting. For more information on changing the units that are displayed, see *Display Unit* on page 100.

OPERATION



TO ENTER LABEL LENGTH MODE:

Hold down the **CODE** key and press the **LABEL LENGTH** key.
The length of the label is displayed briefly.

EXAMPLE

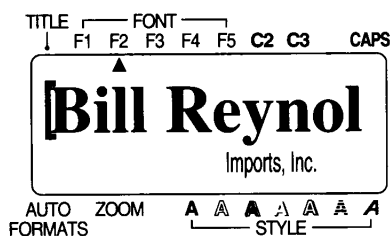
General operation:



- Press  +  and the label length is briefly displayed.

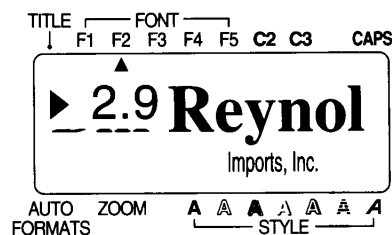

CONTRAST

BACKGROUND

This mode is used to adjust the contrast of the LCD display. Contrast mode can be entered from text entry mode or Auto format mode.

OPERATION



TO CHANGE THE CONTRAST:



- (1) Hold down the **CODE** key and press the **CONTRAST** key.
- (2) Press the **▶** and **◀** keys to adjust the contrast.
- (3) Press the **RETURN** key.

 Press the **SPACE** key to reset the contrast to its default setting.

EXAMPLE

General operation:

- Press  +  and the contrast setting is displayed.

- Press  and  to adjust the contrast, then press .

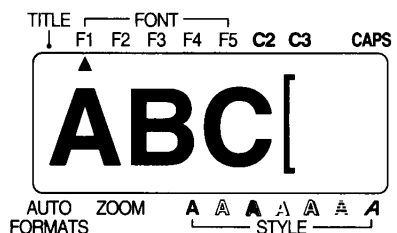
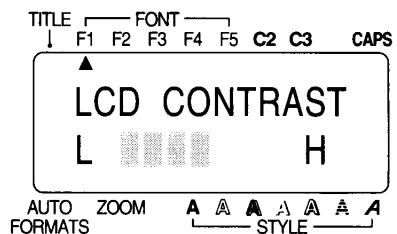
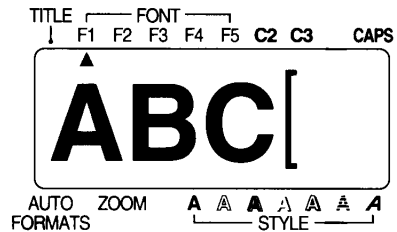

AUTO FORMATS

BACKGROUND

The AUTO FORMATS key is located in the lower left-hand corner of the keyboard. This mode allows you to enter text quickly into layout templates so that labels can be created easily using the preset formats.

OPERATION

TO PRINT A LABEL USING AUTO FORMAT MODE:

- (1) Press the **AUTO FORMATS** key.
*If text has already been entered in the display, a confirmation message appears. Press the **RETURN** key to delete the text.*
- (2) Press the **▲** and **▼** keys until your desired layout is displayed and press the **RETURN** key.
- (3) Enter the label contents and press the **RETURN** key.
- (4) Press the **PRINT** key to print the label.

EXAMPLE

General operation:

- Press **AUTO FORMATS**. The AUTO FORMATS indicator comes on.

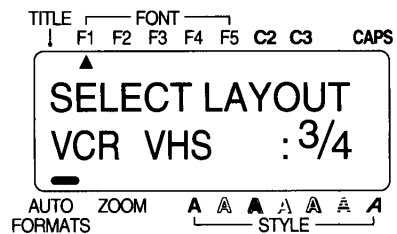

- Press **▲** and **▼** until your desired layout is displayed.

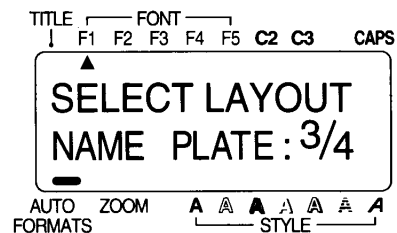

- Press **NEW BLOCK**.

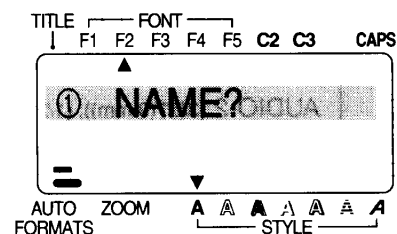

- Enter the name and press  .

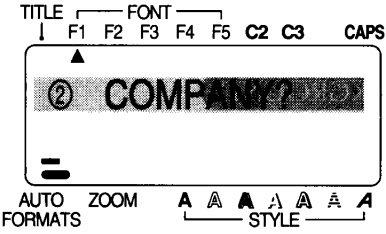

- Enter the name of the company and press  to return to the text entry mode.

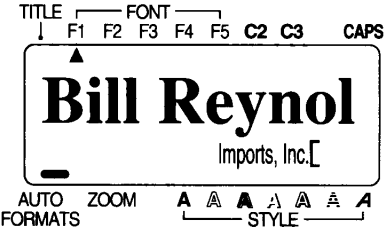

- Press  .

The following chart lists the entries for the label templates, allowing you to easily select the appropriate preset layout.

Label templates		Entries	
A	VCR VHS (3/4" (18 mm))	① SYMBOL?	④ DURATION?
		② TITLE?	⑤ REC. MODE?
		③ SUB-TITLE?	⑥ DATE?
B	VCR 8mm-1 (3/8" (9 mm))	① SYMBOL?	④ DATE?
		② TITLE?	⑤ REC. MODE?
		③ SUB-TITLE?	
C	VCR 8mm-2 (1/2" (12 mm))	① SYMBOL?	④ DURATION?
		② TITLE?	⑤ REC. MODE?
		③ SUB-TITLE?	⑥ DATE?
D	VCR VHSC-1 (1/2" (12 mm))	① TITLE?	② SUB-TITLE?
E	VCR VHSC-2 (3/4" (18 mm))	① SYMBOL?	④ DURATION?
		② TITLE?	⑤ REC. MODE?
		③ SUB-TITLE?	⑥ DATE?
F	AUDIO-1 (1/4" (6 mm))	① SYMBOL?	③ SUB-TITLE?
		② TITLE?	
G	AUDIO-2 (3/8" (9 mm)),(1/2" (12 mm))	① SYMBOL?	③ SUB-TITLE?
		② TITLE?	
H	AUDIO-3 (3/8" (9 mm)),(1/2" (12 mm))	① SYMBOL?	② TITLE?

Label templates		Entries	
I	NAME PLATE (3/4" (18 mm)), (1" (24 mm))	① NAME?	② COMPANY?
J	ADDRESS (3/4" (18 mm)), (1" (24 mm))	① NAME? ② ADDRESS1?	③ ADDRESS2? ④ ADD.3/TEL?
K	EQUIPMENT (3/4" (18 mm)), (1" (24 mm))	① TITLE? ② NAME?	③ NUMBER?
L	EQUIPMENT (1/2" (12 mm))	① TITLE? ② SUB-TITLE?	③ NAME? ④ NUMBER?
M	SLIDE (1/2" (12 mm))	① TITLE? ② DATE?	③ SUB-TITLE?
N	PRICE (3/4" (18 mm)), (1" (24 mm))	① NAME?	② PRICE?
O	SALE PRICE (3/4" (18 mm)), (1" (24 mm))	① NAME? ② OLD PRICE?	③ NEW PRICE?
P	FILE LONG (3/4" (18 mm)) (1" (24 mm))	① TITLE?	
Q	FILE LONGV (3/4" (18 mm)) (1" (24 mm))	① TITLE?	
R	FILE SHORT (3/8" (9 mm)), (1/2" (12 mm)), (3/4" (18 mm)) (1" (24 mm))	① TITLE?	
S	FLOPPY 3.5" (3/4" (18 mm)), (1" (24 mm))	① TITLE? ② SUB-TITLE?	③ NAME?
T	FLOPPY 5" (3/4" (18 mm)), (1" (24 mm))	① TITLE? ② SUB-TITLE?	③ NAME?

Ⓐ VCR VHS (3/4" (18 mm))

	CHAMPION'S CUP MEN'S SINGLE	90min STANDARD AUG.5,1995
---	---------------------------------------	---------------------------------

Ⓑ VCR 8mm-1 (3/8" (9 mm))

	A SNOWY DAY Mick's first ski experience	JAN.3.'95 Valdisei
---	---	-----------------------

Ⓒ VCR 8mm-2 (1/2" (12 mm))

	Kelly's 1st Birthday Birthday Party	120min SLOW JAN.10,1995
---	---	-------------------------------

Ⓓ VCR VHSC-1 (1/2" (12 mm))

	JOE & ANN'S WEDDING St. Michael's Church
---	--

Ⓔ VCR VHSC-2 (3/4" (18 mm))



JOE & ANN'S WEDDING

St. Michael's Church

120min
NORMAL
11.6,'95

Ⓕ AUDIO-1 (1/4" (6 mm))



FAVORITE LOVE SONGS

Mari

Ⓖ AUDIO-2 (3/8" (9 mm))



FAVORITE LOVE SONGS
Mari

AUDIO-2 (1/2" (12 mm))



FAVORITE LOVE SONGS
Mari

Ⓗ AUDIO-3 (3/8" (9 mm))



OLDIES(1960 – 1970)

AUDIO-3 (1/2" (12 mm))



OLDIES(1960 – 1970)

Ⓘ NAME PLATE (3/4" (18 mm))

Bill Reynolds

ABC INTERNATIONAL CORP.

NAME PLATE (1" (24 mm))

Bill Reynolds

ABC INTERNATIONAL CORP.

Ⓙ ADDRESS (3/4" (18 mm))

Smith's Rent-A-Bike
29 Green Road
Los Angeles, CA 88888
123-456-7890

ADDRESS (1" (24 mm))

Smith's Rent-A-Bike
29 Green Road
Los Angeles, CA 88888
123-456-7890

Ⓚ EQUIPMENT (3/4" (18 mm))

PROPERTY OF
SALES & MARKETING DIV.
0312

EQUIPMENT (1" (24 mm))

PROPERTY OF
SALES & MARKETING DIV.
0312

Ⓛ EQUIPMENT (1/2" (12 mm))

PROPERTY OF	SALES & MARKETING DIV.
NUMBER	0235

Ⓜ SLIDE (1/2" (12 mm))

HAWAII ISLAND
AUG. 15, 1994
ISO: 70

Ⓝ PRICE (3/4" (18 mm))

LABEL PRINTER
\$249

PRICE (1" (24 mm))

LABEL PRINTER
\$249

Ⓞ SALE PRICE (3/4" (18 mm))

LABEL PRINTER
~~\$249~~ → **\$229**

SALE PRICE (1" (24 mm))

LABEL PRINTER
~~\$249~~ → **\$229**

Ⓟ FILE LONG (3/4" (18 mm))

'94 MARKET RESEARCH ①

FILE LONG (1" (24 mm))

'94 MARKET RESEARCH ①

ⓐ FILE LONGV (3/4" (18 mm))

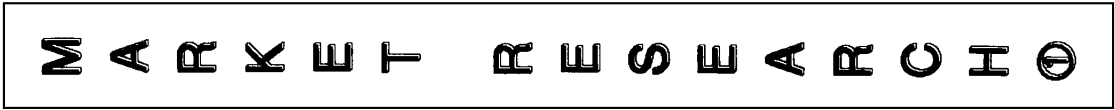

FILE LONGV (1" (24 mm))

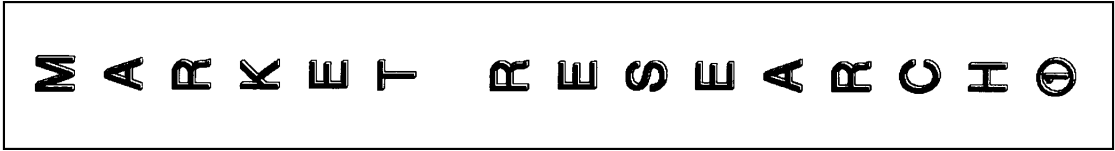

ⓑ FILE SHORT (3/8" (9 mm))



FILE SHORT (1/2" (12 mm))



FILE SHORT (3/4" (18 mm))



FILE SHORT (1" (24 mm))

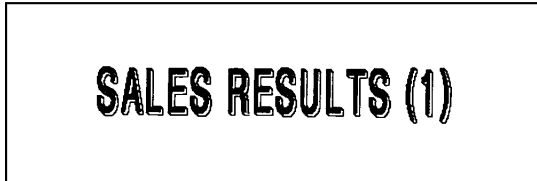

ⓒ FLOPPY 3.5" (3/4" (18 mm))



FLOPPY 3.5" (1" (24 mm))

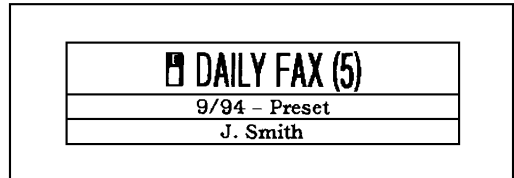

ⓓ FLOPPY 5" (3/4" (18 mm))



FLOPPY 5" (1" (24 mm))

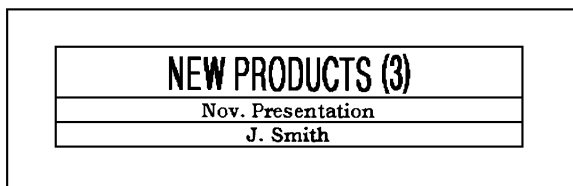

LOCAL FORMATTING

BACKGROUND

LOCAL FORMAT
FONT
SIZE
WIDTH
STYLE
UNDL / FRM
COLOR

The local format settings, shown in the table at the left, determine how the text is printed. After the text is entered, use the **AREA** and cursor keys to select the characters to be emphasized, then change the format using the local format keys (**FONT**, **SIZE**, **etc.**) below the LCD display. If the entire text is selected, the font, size, width, style, underlining or framing, and color print formats can be applied globally. In addition, local formats can be assigned before text entry.

Since the text entry mode is WYSIWYG mode, the display shows the text with the selected formats so you can see how the label will appear it is printed.

CREATING a local format can be done in two ways: by choosing the character to be included and setting the format or by setting the format before entering the text.

TO CREATE A LOCAL FORMAT AFTER TEXT ENTRY:

- (1) Position the cursor in front of the first character you wish to assign a local format.
- (2) Press the **AREA** key. The first character will be highlighted.
- (3) Use the cursor keys to highlight all characters to which you wish to assign a local format. Select all of the characters in the message to change the format of the entire text.
- (4) Press the local format key, located below the LCD display, for the format to be set until the text appears on the display in the desired format.
- (5) Repeat step (4) until the text is formatted as you wish.
- (6) Press the RETURN key. This local format is applied to the chosen characters.

 *Press the AREA or CANCEL key at any time to return to text entry mode without setting a local format.*

TO CREATE A LOCAL FORMAT BEFORE TEXT ENTRY:

- (1) Press the local format key, located below the LCD display, for the format to be set until the sample letter ("A") appears on the display in the desired format.
- (2) Repeat step (1) until the sample character is formatted as you wish.
- (3) Enter the text. All text will be entered using the applied format until the format settings are changed again.

EXAMPLE

General Operation:

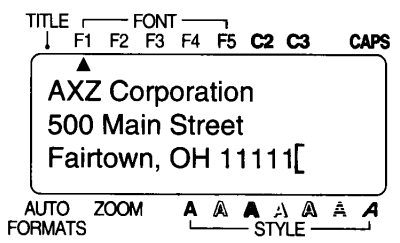

- Press **CODE** + **HOME** to move the cursor to the beginning of the message, then press **AREA**.
- Use **END** and **RIGHT** to highlight the entire message.

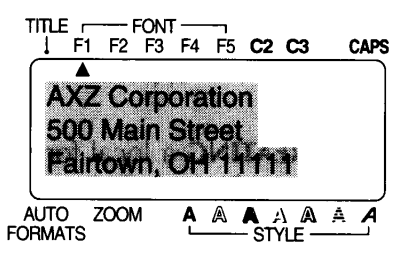

- Press **SIZE** until the character size is set to the second smallest size (10 points) and

GLOBAL FORMATTING

BACKGROUND

GROBAL FORMAT
FRAME
FEED
VERT
MIRROR
H. ALI
V. ALI
LENGTH
UNIT
C. FRAME
C. CHAR

The global format settings, shown in the table at the left, determine how the label is printed by establishing the orientation and alignment of the entire text message. Press **FORMAT** to enter the Format mode and change there formats at any time — before, during or after you enter your test.

Since the text entry mode is a WYSIWYG mode, the display shows the message with the selected formats so you can see how the label will appear after it is printed.

OPERATION

CREATING a global format is very simple.

TO CREATE A GLOBAL FORMAT:

- (1) Press the **FORMAT** key.
- (2) Press the **▶** and **◀** keys until the first setting you wish to change is highlighted.
- (3) Press the **▲** and **▼** keys until the desired setting is displayed.
- (4) Repeat steps (2) and (3) until all settings are as you wish.
- (5) Press the **RETURN** key. This new format is applied to your entire text file and the LCD display returns to text entry mode.

 Press the **FORMAT** key or **CANCEL** key at any time to leave Format mode and return to text entry mode without making any changes.

Press the **SPACE** key to return the highlighted format setting to its default setting.

Hold down the **CODE** key and press the **SPACE** key to change all format settings back to their default settings (i.e. no underlining/framing/shading, full tape feed, no vertical or mirror printing, left and bottom text alignment, automatic label length adjustment, one-color character printing and frame printing using the first color).



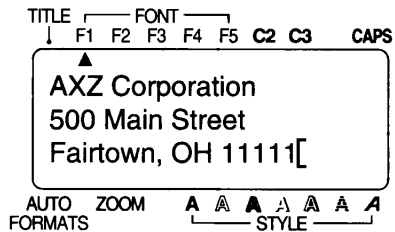

EXAMPLE

General Operation:

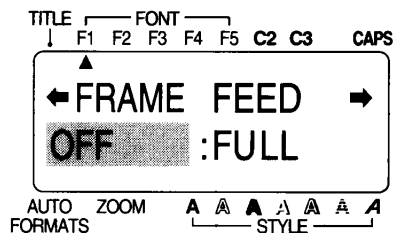

- Press  .



- Use  and  to move the cursor and  and  to choose the appropriate setting. Change the label framing format (FRAME) to the box setting () and the horizontal alignment format (H.ALI) from LEFT to CENTER.

- Press  .

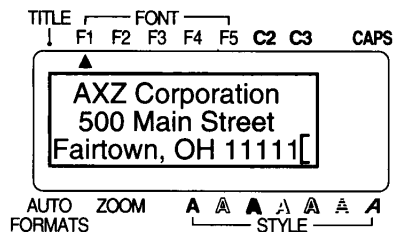

FONT

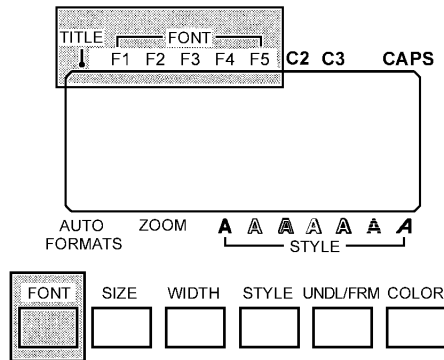

BACKGROUND

Eight different typeface, or fonts, are available on this machine. The fonts are:

F1 (Helsinki)	TITLE F2 (Calgary)
F2 (Brussels)	TITLE F3 (Florida)
F3 (Bermuda)	TITLE F4 (Istanbul)
TITLE F1 (San Diego)	TITLE F5 (US)

The default setting is font F1.

 *The TITLE fonts are only available if the message consists of only one line or if 1/2" (12-mm)-, 3/4" (18-mm)-or 1" (24-mm)-wide tape is installed. In addition, letters entered using a TITLE font will only appear in uppercase.*

OPERATION

TO ENTER TEXT WITH A DIFFERENT FONT:

- (1) Insert the cursor where you wish to begin using a new font.
- (2) Press the **FONT** key until the sample character is displayed in the font you wish to use and your desired font is shown by the indicators above the LCD display.
- (3) Enter the text to which the chosen font is to be applied.

TO APPLY A FONT TO A SELECTED AREA:

- (1) Press the **AREA** key, then use the cursor keys to select the text to which you want to apply a new font.
- (2) Press the **FONT** key until the text is displayed in the font you wish to use and your desired font is shown by the indicators above the LCD display.
- (3) Press the **RETURN** key to apply the chosen font to the selected text.

EXAMPLE

F1	ABCDE
F2	ABCDE
F3	<i>ABCDE</i>
TITLE F1	ABCDE
TITLE F2	<i>ABCDE</i>
TITLE F3	ABCDE
TITLE F4	ABCDE
TITLE F5	ABCDE

SIZE/WIDTH

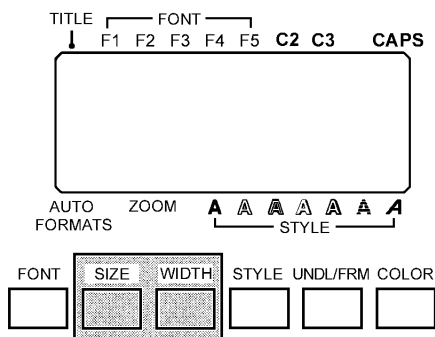

BACKGROUND

There are two character size settings: size and width. Usually, you will want to use the largest characters possible for the given tape and message. With the size set to AUTO, the machine compares your inputted message with the tape width and automatically uses the largest characters possible. Sometimes, however, you will want to assign a particular character size and width. To do so, six point sizes are available and each can be printed in narrow, medium or wide characters. The sizes and width are:

6, 10, 13, 19, 26 & 38 point (all are available in the following widths: medium, narrow, or wide)

AUTO (The largest possible character size is automatically chosen.)

The default size is AUTO and the default width is medium.

The following chart shows the character size that can be used with the tape widths listed.

Tape width	Size (pt)
1" (24 mm)	6, 10, 13, 19, 26, 38
3/4" (18 mm)	6, 10, 13, 19, 26, 38
1/2" (12 mm)	6, 10, 13, 19
3/8" (9 mm)	6, 10, 13, 19
1/4" (6 mm)	6, 10, 13

 When the Split printing parameter in Special print mode is turned on, the message will be printed using a larger character size.

OPERATION

TO ENTER TEXT WITH A DEFFERENT SIZE/WIDTH

- (1) Insert the cursor where you wish to begin using a new character size or width.
- (2) Press the **SIZE** key until the sample characters is displayed in the character size you wish to use and press the **WIDTH** key until the desired width is displayed.
- (3) Enter the text to which the chosen size or width is to be applied.

TO APPLY A SIZE/WIDTH TO THE SELECTED AREA:

- (1) Press the **AREA** key, then use the cursor keys to select the text to which you want to apply a new character size or width.
- (2) Press the **SIZE** key until the text is displayed in the character size you wish to use and press the **WIDTH** key until the text is displayed in the desired width.
- (3) Press the **RETURN** key to apply the chosen size or width to the selected text.

EXAMPLE

WIDTH SIZE	Wide	Medium	Narrow
38pt	ABC	ABC	ABC
26pt	ABC	ABC	ABC
19pt	ABC	ABC	ABC
13pt	ABC	ABC	ABC
10pt	ABC	ABC	ABC
6pt	ABC	ABC	ABC

STYLE/ITALIC

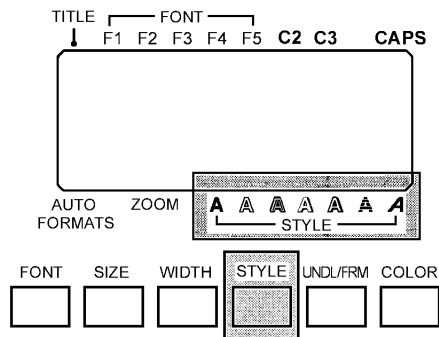

BACKGROUND

Six single styles, which can all be combined with the italic style, are available. The styles are:

Normal (No indicator)	Italic & Normal (<i>A</i>)
Bold (A)	Italic & Bold (<i>A + A</i>)
Outline (<u>A</u>)	Italic & Outline (<i>A + A</i>)
Solid (A)	Italic & Solid (<i>A + A</i>)
Shadow (<i>A</i>)	Italic & Shadow (<i>A + A</i>)
Outline + Shadow (<u><i>A</i></u>)	Italic & Outline + Shadow (<i>A + A</i>)
Striped (<i>A</i>)	Italic & Striped (<i>A + A</i>)

The default setting is the normal style. (No indicators appear in the display.)

 Characters printed using the smaller sizes may be difficult to read if certain style settings (e.g. Italic & Shadow) are applied.

OPERATION

TO ENTER TEXT WITH A DIFFERENT STYLE/ITALIC:

- (1) Insert the cursor where you wish to begin using a new character style.
- (2) Press the **STYLE** key until the sample character is displayed in the style you wish to use and your desired character style is shown by the indicators below the LCD display.
- (3) Enter the text to which the chosen style is to be applied.

TO APPLY A STYLE/ITALIC TO A SELECTED AREA:

- (1) Press the **AREA** key, then use the cursor keys to select the text to which you want to apply a new character style.
- (2) Press the **STYLE** key until the text is displayed in the style you wish to use and your desired character style is shown by the indicators below the LCD display.
- (3) Press the **RETURN** key to apply the chosen style to the selected text.

EXAMPLE

	Normal	Bold	Outline	Solid
F1	ABCDE	ABCDE	ABCDE	ABCDE
F2	ABCDE	ABCDE	ABCDE	ABCDE
F3	<i>ABCDE</i>	<i>ABCDE</i>	<i>ABCDE</i>	<i>ABCDE</i>
TITLE F1	ABCDE	ABCDE	ABCDE	ABCDE
TITLE F2	<i>ABCDE</i>	<i>ABCDE</i>	<i>ABCDE</i>	<i>ABCDE</i>
TITLE	ABCDE	ABCDE	ABCDE	ABCDE

	Italic & Normal	Italic & Bold	Italic & Outline	Italic & Solid
F1	<i>ABCDE</i>	<i>ABCDE</i>	<i>ABCDE</i>	<i>ABCDE</i>
F2	<i>ABCDE</i>	<i>ABCDE</i>	<i>ABCDE</i>	<i>ABCDE</i>
F3	<i>ABCDE</i>	<i>ABCDE</i>	<i>ABCDE</i>	<i>ABCDE</i>
TITLE F1	<i>ABCDE</i>	<i>ABCDE</i>	<i>ABCDE</i>	<i>ABCDE</i>
TITLE F2	<i>ABCDE</i>	<i>ABCDE</i>	<i>ABCDE</i>	<i>ABCDE</i>
TITLE	<i>ABCDE</i>	<i>ABCDE</i>	<i>ABCDE</i>	<i>ABCDE</i>

UNDERLINING/FRAMING

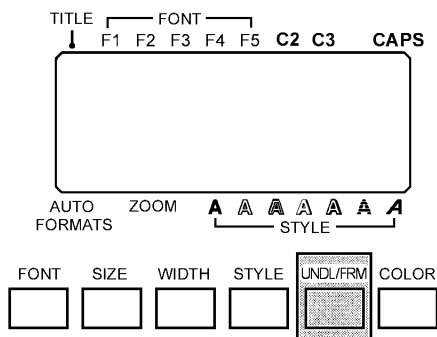

BACKGROUND

Selected characters in your message can be highlighted by framing them with a box or a rounded box, underlining them, crossing them out, or putting them in front of a shading pattern. The types of highlights are:

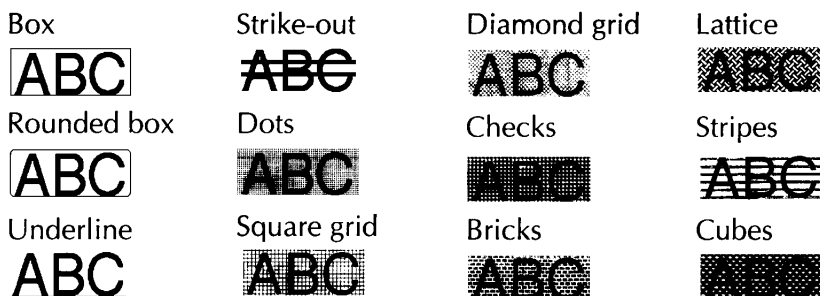

The default setting is no underline, frame or shading.

When the entire text message is removed from the display with the **CLEAR** key, this format will return to its default setting (no underline/frame/shading).

OPERATION

TO ENTER TEXT WITH UNDERLINING/FRAMING:

- (1) Insert the cursor where you wish to begin using a new frame.
- (2) Press the **UNDL/FRM** key until the sample character is displayed with the frame you wish to use.
- (3) Enter the text to which the chosen frame is to be applied.

TO APPLY UNDERLINING/FRAMING TO A SELECTED AREA:

- (1) Press the **AREA** key, then use the cursor keys to select the text to which you want to apply a new frame.
- (2) Press the **UNDL/FRM** key until the text is displayed with the frame you wish to use.
- (3) Press the **RETURN** key to apply the chosen frame to the selected text.

MULTI-COLOR PRINTING

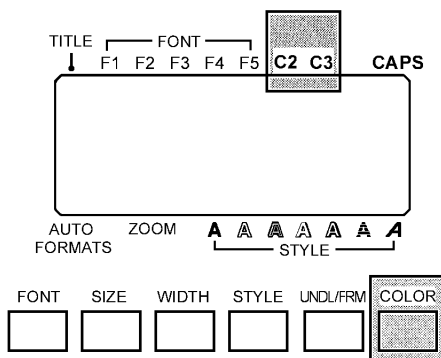

BACKGROUND

With the multi-color printing function, you can create colorful labels using different ink colors. This function is useful when part of your message must be more noticeable or when color-coded labels are needed.

The default color is COLOR1.

 When a message is stored in the memory, the order in which the characters will be printed are also saved.

The color print settings assigned using this function are the same settings used with the global format C. FRAME and C. CHAR settings.

OPERATION

TO ENTER TEXT THAT WILL BE PRINTED WITH A DIFFERENT COLOR:

- (1) Insert the cursor where you wish to begin using a new color.
- (2) Press the **COLOR** key until the color setting you wish to use appears and your desired setting is shown by the indicators above the LCD display.
- (3) Enter the text to which the chosen color is to be applied.

TO APPLY COLOR SETTINGS TO A SELECTED AREA:

- (1) Decide the color of each part of your label and the order in which the colors will be printed.

 Before printing the label, be sure to use the **FORMAT** key to select the color of the frame or shading (For more information, refer to page 101.) The part of the character that is left blank can also be printed using one of the three ink colors. (Refer to page 103 for a detailed explanation.)

- (2) Open the tape compartment cover and insert the first ink cassette into a multi-color printing tape cassette, then insert them firmly into the compartment before closing the compartment cover. Make sure that the entire back of the cassette contacts the bottom of the compartment.
- (3) Position the cursor in front of the first character you wish to print using the second ink color and press **AREA** key. The first character will be highlighted.

 All characters will automatically be printed using the first ink color, unless they are assigned a different color number.

- (4) Use the color keys to highlight the string of characters which you wish to print using the second color.
- (5) Press the **COLOR** key located below the LCD display, until COLOR2 is displayed and the C2 indicator comes on, then press the **RETURN** key. These characters will be printed using the second ink color.
- (6) Repeat steps (2) and (3) to highlight the string of characters which you wish to print using the third color.
- (7) Press the **COLOR** key until COLOR3 is displayed and the C3 indicator come on, then press the **RETURN** key. These characters will be printed using the third ink color.

 *The C2 and C3 indicators show which color has been assigned to the character that is to the left of the cursor. If no indicators are on, the first color has been assigned.*

TO PRINT THE MULTI-COLOR LABEL:

- (1) Continue assigning colors until all the characters' settings are as you wish then press the **PRINT** key. The multi-color print setting (COLOR PRINT) appears.
- (2) press the **▲** and **▼** keys to turn on the Multi-color print mode, then press the **RETURN** key. The message "INSERT COLOR1" will be displayed.

 *Before printing, be sure that there is enough tape in the tape cassette, otherwise the label may not be printed correctly.*
- (3) Open the compartment cover and check that the first ink cassette is installed, then close the cover and press the **RETURN** key. The message "WORKING" briefly flashes, then "COPIES COLOR1" appears while the characters assigned the first ink color are printed. When printing finishes, the message "REMOVE INK RIBBON" will be displayed.
- (4) Open the compartment cover, then remove the first ink cassette and press the **RETURN** key. The message "REWINDING THE TAPE" appears while the tape is rewinding. After the tape is rewound, the message "INSERT COLOR2" will be displayed.



 *Wait until the tape has finished rewinding before inserting the next ink cassette.*
- (5) Insert the second ink cassette, close the cover and press the **RETURN** key. The message "WORKING" briefly flashes, then "COPIES COLOR2" appears while the characters assigned the second ink color are printed. When printing finishes, the message "REMOVE INK RIBBON" will be displayed.
- (6) Open the compartment cover, then remove the second ink cassette and press the **RETURN** key. The message "REWINDING THE TAPE" appears while the tape is rewinding. After the tape is rewound, the message "INSERT COLOR3" will be displayed.
- (7) Insert the third ink cassette, close the cover and press the **RETURN** key. The message "WORKING" briefly flashes, then "COPIES COLOR3" appears while the characters assigned the third ink color are printed.
- (8) Push down on the tape cutter lever to cut off the label, then cut it along the two printed dots to make equal margins.

EXAMPLE

General operation:

In this example, the first color is blue, the second is red and the third, black.

- Open the tape compartment cover, insert the multi-color printing tape cassette and the ink cassette that you want to use first, then close the cover. Make sure that the entire back of the cassette contacts the bottom of the compartment.

- Press  to move the cursor in front of "l", then press .

- Press  until COLOR2 is displayed and the C2 indicator appears.

- Press .

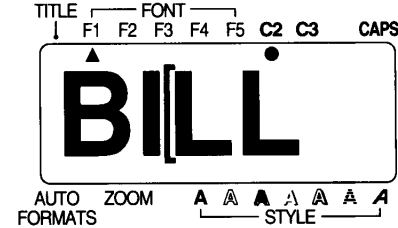
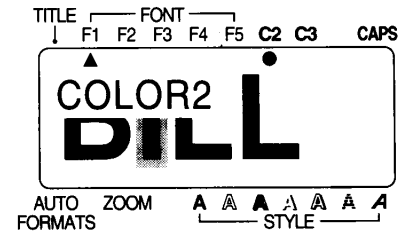
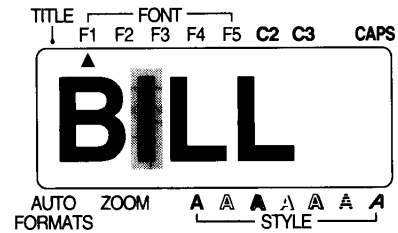
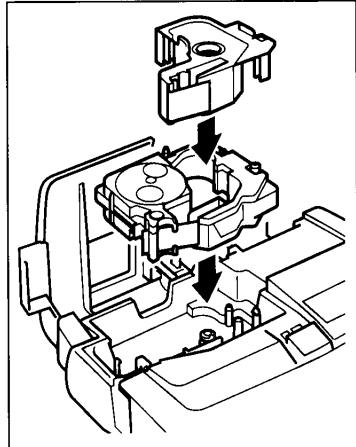
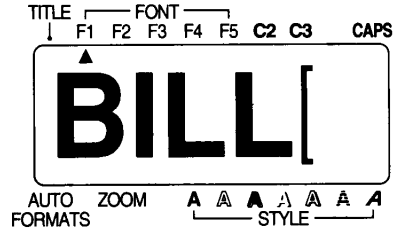



- Press .

- Press  until COLOR3 is displayed and the C3 indicator appears.

- Press .

- Press . Use  and  to turn on the Multi-color print mode.

- Press . A message reminding you to insert the first ink cassette appears in the display.

- Open the tape compartment cover, check that the first ink cassette is installed, close the cover, then press .

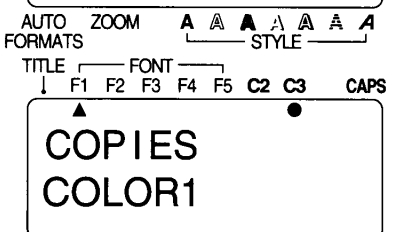
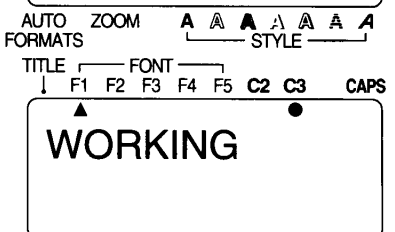
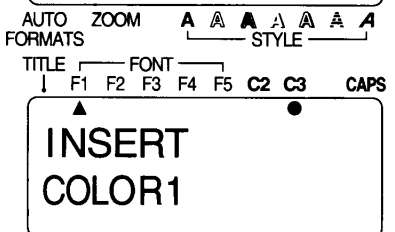
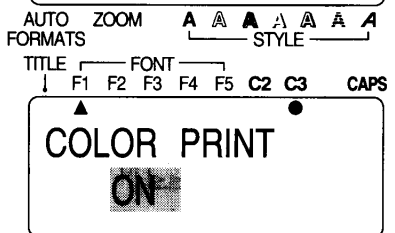
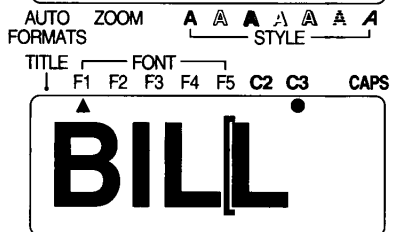
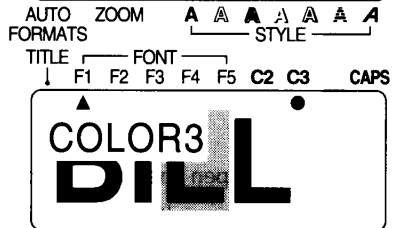
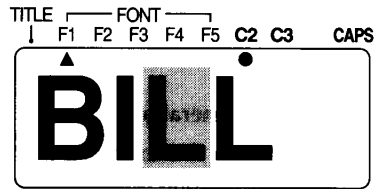

- Open the compartment cover, pull up on the first ink cassette by its tabs, then press



TITLE FONT
↓ F1 F2 F3 F4 F5 C2 C3 CAPS

REMOVE
INK RIBBON

AUTO ZOOM A A A A A A A
FORMATS STYLE

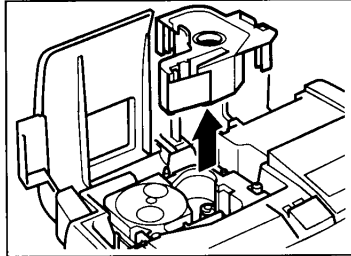

TITLE FONT
↓ F1 F2 F3 F4 F5 C2 C3 CAPS

REWINDING
THE TAPE

AUTO ZOOM A A A A A A A
FORMATS STYLE

TITLE FONT
↓ F1 F2 F3 F4 F5 C2 C3 CAPS

INSERT
COLOR2

AUTO ZOOM A A A A A A A
FORMATS STYLE

- Insert the second ink cassette, close the cover, then press

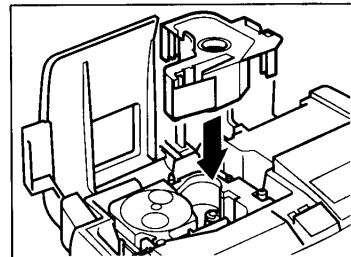

TITLE FONT
↓ F1 F2 F3 F4 F5 C2 C3 CAPS

WORKING

AUTO ZOOM A A A A A A A
FORMATS STYLE

TITLE FONT
↓ F1 F2 F3 F4 F5 C2 C3 CAPS

COPIES
COLOR2

AUTO ZOOM A A A A A A A
FORMATS STYLE

- Open the compartment cover, remove the second ink cassette, then press  .

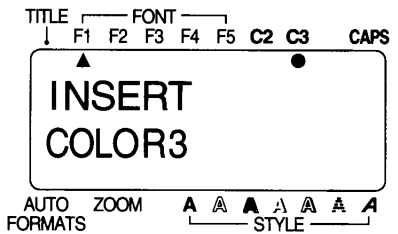
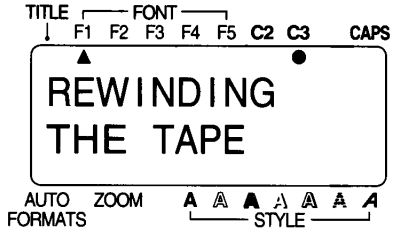
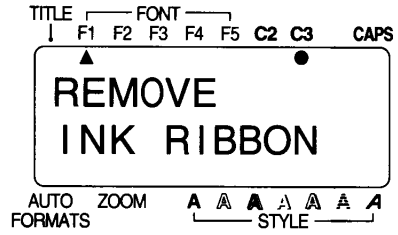

- Insert the third ink cassette, close the cover, then press  .

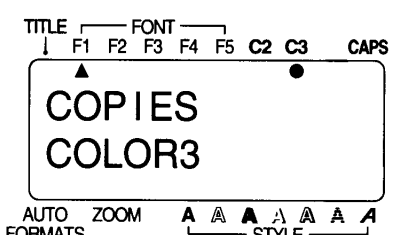
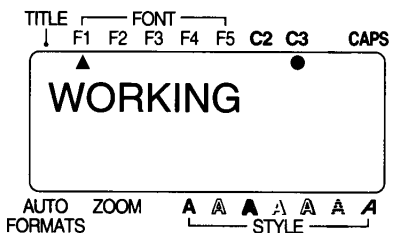

- Push down on the tape cutter lever to cut off the label, then use scissors to cut it along the two printed dots to make equal margins.

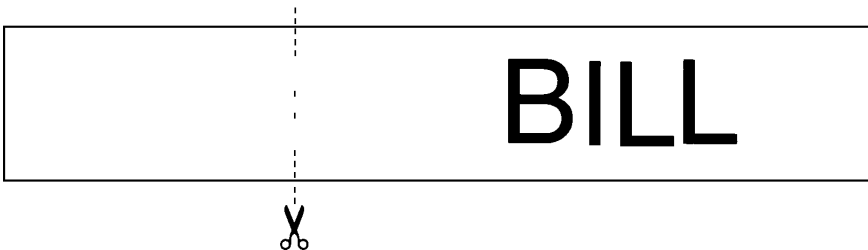

FRAMING

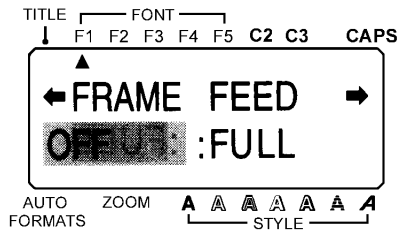

BACKGROUND

Unique labels can be created by flaming your entire message using one of the many flames available. The types of frames are:

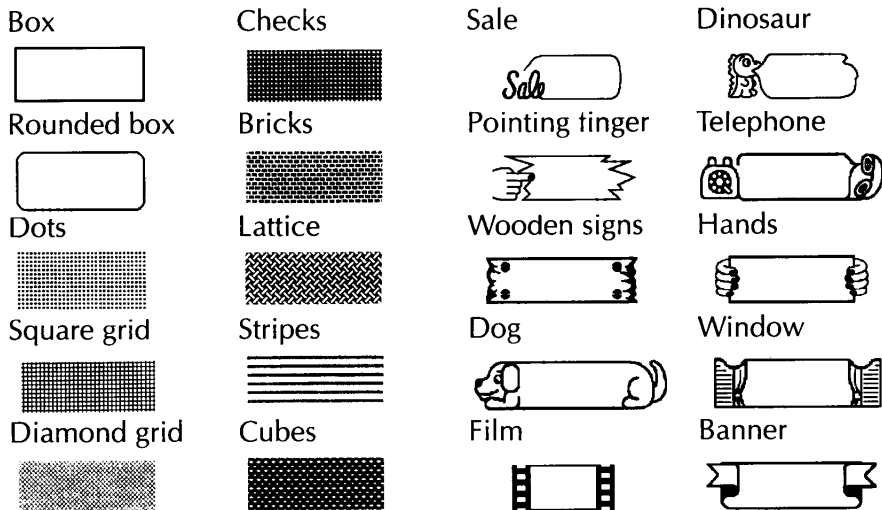

*This framing setting can only be applied to the entire label. It cannot be applied to just part of the text. However, the box, rounded box or the shading pattern can be applied locally using the **AREA** and cursor keys to select the text, then pressing the **UNDL/FRM** key until the highlight you wish to use is displayed.*

OPERATION

TO SELECT THE FRAMING STYLE:

- (1) Press the **FORMAT** key.
- (2) Press **▶** and **◀** keys until the framing setting (FRAME) is highlighted.
- (3) Press **▲** and **▼** keys until the frame you wish to use is displayed.

*The default setting (OFF) can be selected by pressing the **SPACE** key.*

- (4) Press the **RETURN** key.

TAPE FEED

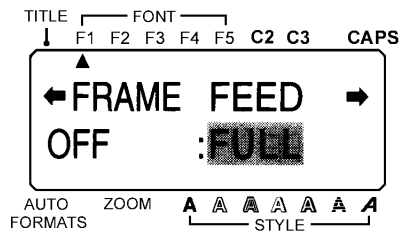

BACKGROUND

This machine can be set to leave equal margins of between 1/6" (4 mm) and 1" (24 mm) on the left and right sides of your label. The tape feed settings are:

FULL (1" (24 mm))

NONE (1/6" (4 mm))

NARROW (1/3" (8 mm))

MEDIUM (1/2" (12 mm))

 Since reducing the tape feed may decrease bar code readability, full tape feed is recommended when messages include bar code. If instant (rub-on) lettering tape is installed, this setting will be ignored and the message will be printed with full margins.

The tape feed setting can only be applied to the entire label. It cannot be applied to just part of the text.

OPERATION

TO SELECT A MARGIN WIDTH:

- (1) Press the **FORMAT** key.
- (2) Press the **▶** and **◀** keys until the tape feed setting (FEED) is highlighted.
- (3) Press the **▲** and **▼** keys until the margin width you wish to use is highlighted.

 The default setting (FULL) can be selected by pressing the **SPACE** key.

- (4) Press the **RETURN** key.

VERTICAL PRINTING

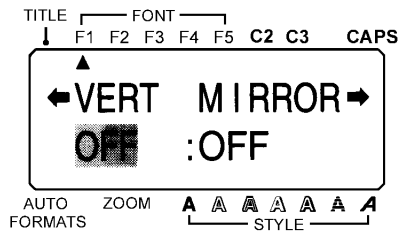

BACKGROUND

Characters in your message can be printed in a vertical orientation.

The vertical printing setting cannot be turned on if a TITLE font is used.

Vertical printing can only be applied to the entire label. It cannot be applied to just part of the text.

OPERATION

TO SET THE VERTICAL PRINTING FUNCTION:

- (1) Press the **FORMET** key.
 - (2) Press the **▶** and **◀** keys until the vertical printing setting (VERT) is highlighted.
 - (3) Press the **▲** and **▼** keys until the setting you wish to use is displayed.
- The default setting (OFF) can be selected by pressing the **SPACE** key.*
- (4) Press the **RETURN** key.

EXAMPLE

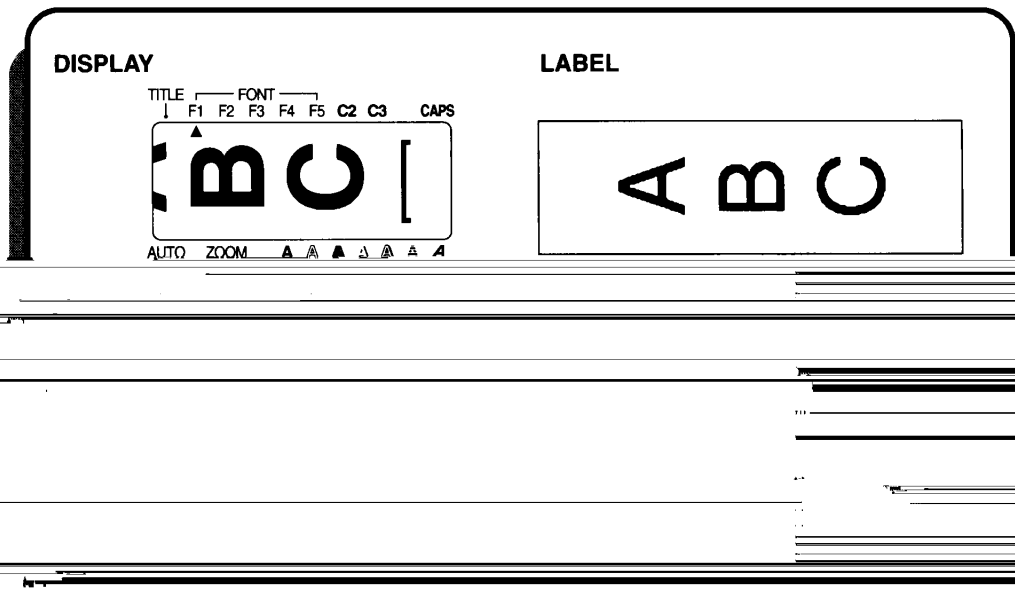

MIRROR PRINTING

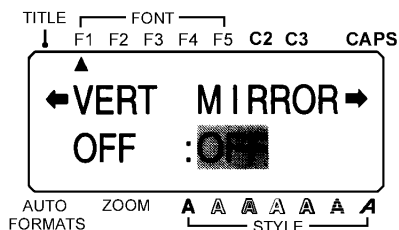

BACKGROUND

Your message can be printed as if it is seen in a mirror. When these labels (printed on clear tape) are affixed to glass, such as showroom windows, they can be correctly read from the opposite side.

- ☞ Use clear tape when using the mirror printing setting to make a label.
- Mirror printing can only be applied to the entire label. It cannot be applied to just part of the text.

OPERATION

TO SET THE MIRROR PRINTING FUNCTION:

- (1) Press the **FORMAT** key.
- (2) Press the **▶** and **◀** keys until the mirror printing setting (MIRROR) is highlighted.
- (3) Press the **▲** and **▼** keys until the setting you wish to use is displayed.
- ☞ The default setting (OFF) can be selected by pressing the **SPACE** key.
- (4) Press the **RETURN** key.

EXAMPLE

DISPLAY

LABEL

☞ Mirror printing can also be used in conjunction with other printing orientations.

HORIZONTAL ALIGNMENT

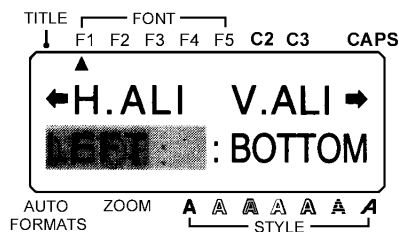

BACKGROUND

Characters in the blocks of your message can be horizontally aligned in any one of four ways:

- LEFT
- CENTER
- RIGHT
- JUSTIFY

 The horizontal alignment setting can only be applied to the entire label. It cannot be applied to just part of the text.

If a tape length has been set, multi-block message are assigned the JUSTIFY setting and spaces between the blocks are adjusted so that the text spreads out evenly the tape.

OPERATION

TO SELECT A HORIZONTAL ALIGNMENT:

- (1) Press the **FORMAT** key.
- (2) Press the **▶** and **◀** keys until the horizontal alignment setting (H.ALI) is highlighted.
- (3) Press the **▲** and **▼** keys until the setting you wish to use is displayed.
 The default setting (LEFT) can be selected by pressing the **SPACE** key.
- (4) Press the **RETURN** key.

EXAMPLE

LEFT	CENTER	RIGHT	JUSTIFY
ABC	ABC	ABC	A B C
DEFGHIJ	DEFGHIJ	DEFGHIJ	DEFGHIJ
KLNOP	KLNOP	KLNOP	K L N O P
G	G	G	G

VERTICAL ALIGNMENT

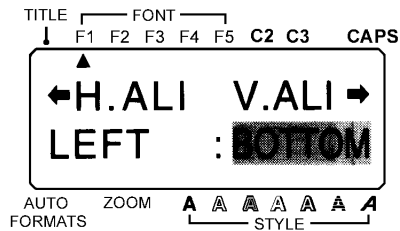

BACKGROUND

The blocks of your message can be vertically aligned in three ways:

BOTTOM
CENTER
TOP

The vertical alignment setting can only be applied to the entire label. It cannot be applied to just part of the text.

OPERATION

TO SELECT A VERTICAL ALIGNMENT

- (1) Press the **FORMAT** key.
- (2) Press the **▶** and **◀** keys until the vertical alignment setting (V.ALI) is highlighted.
- (3) Press the **▲** and **▼** keys until the setting you wish to use is displayed.

*The default setting (BOTTOM) can be selected by pressing the **SPACE** key.*

- (4) Press the **RETURN** key.

EXAMPLE

BOTTOM	ABCABCABCABCABC _{ABC}
CENTER	ABCABCABCABCABC _{ABC}
TOP	ABCABCABCABCABC ^{ABC}

LENGTH

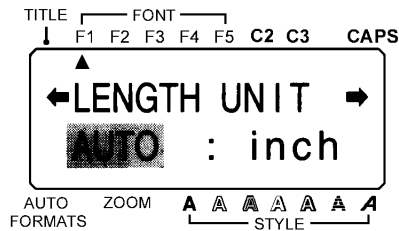

BACKGROUND

The label length can be set using two different methods. With the size set to AUTO, the machine compares your inputted message with the tape size and automatically adjusts the label length to fit your message. Sometimes, however, you will want to assign a label length regardless of the message's size. The label length can be set from 1.5" (3.8 cm) to 11.3" (28.7 cm). The label lengths are:

In inches: AUTO 1.5 1.6 ... 11.3 AUTO...

In centimeters: AUTO 3.8 3.9 ... 28.7 AUTO...

 *The length setting can only be applied to the entire label. It cannot be applied to just part of the text.*

When a setting other than AUTO is selected for the label length, the message "TOO LONG" is displayed if the text will not fit within the specified length.

OPERATION

TO SELECT A TAPE LENGTH:

- (1) Press the **FORMAT** key.
- (2) Press the **▶** and **◀** keys until the tape length setting (LENGTH) is highlighted.
- (3) Press the **▲** and **▼** keys until the setting you wish to use is displayed. Pressing either key once will change the length by 0.1" (0.1 cm when centimeters are displayed). If a key is held down, the length will continue changing in steps of 1" (1.0 cm) until the key is released.

 *The default setting (AUTO) can be selected by pressing the **SPACE** key.*

- (4) Press the **RETURN** key.

DISPLAY UNITS

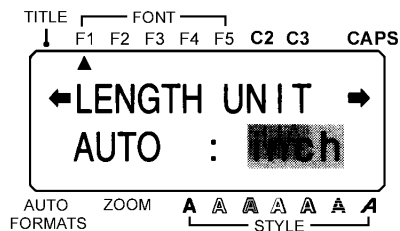

BACKGROUND

The measurements on the display are shown in either inches (inch) or centimeters (cm).

 This setting is applied to all the measurements displayed. It is not available in local formatting.

OPERATION

TO SELECT THE UNITS OF THE MEASUREMENTS:

- (1) Press the **FORMAT** key.
 - (2) Press the **▶** and **◀** keys until the display units setting (UNIT) is highlighted.
 - (3) Press the **▲** and **▼** keys until the setting you wish to use is displayed.
-  The default setting (inch) can be selected by pressing the **SPACE** key.
- (4) Press the **RETURN** key.

COLORED FRAMES/SHADING

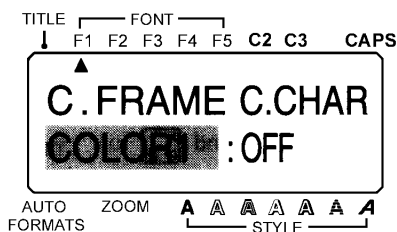

BACKGROUND

The frame or shading in your label can be assigned one of the three ink colors used during multi-color printing.

COLOR1 COLOR2 COLOR3

Before printing the label using the multi-color printing function, be sure that there is enough tape in the tape cassette, otherwise the label may not be printed properly. Also, check that the setting for the C.FRAME function has been chosen.

The color print settings assigned using this function are the same settings used in multi-color printing and with the C.CHAR function.

The C.FRAME setting can only be applied to the entire label. It cannot be applied to just part of the text. If a frame or shading has not been added to the label, this setting is ignored during printing.

OPERATION

TO SET THE COLORED FRAME/SHADING FUNCTION:

- (1) Press the **FORMAT** key.
- (2) Press the **▶** and **◀** keys until the colored frame/shading setting (C.FRAME) is highlighted.
- (3) Press the **▲** and **▼** keys until the color you wish to use is displayed.

*The default setting (COLOR1) can be selected by pressing the **SPACE** key.*

- (4) Press the **RETURN** key.

EXAMPLE

Labels like those shown below can be created using the C.FRAME setting:

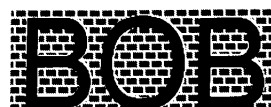

General Operation:

In this example, the first color is black and the second color is red.

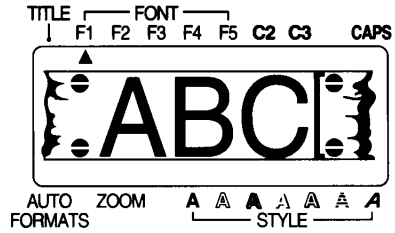

- Press **FORMAT**, then use **←** and **→** to move the cursor to the colored frame/shading setting (C.FRAME) and **HOME** and **END** to choose COLOR 2.

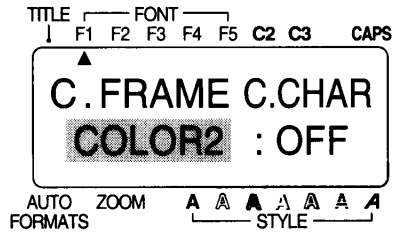

- Press **NEW BLOCK**.

- Open the tape compartment cover, insert multi-color printing ink and tape cassettes, then close the cover.

- Press **SPECIAL PRINT PRINT**.

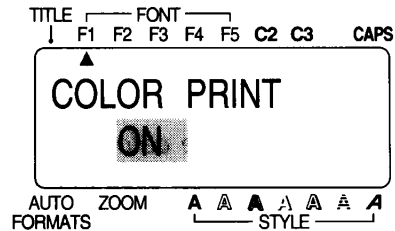

- Press **NEW BLOCK** and follow the messages to continue printing with the multi-color printing function.

Refer to the Multi-Color Printing section on pages 87 and 88 for a detailed explanation.

- Push down on the tape cutter lever to cut off the label, then use scissors to cut it along the two printed dots to make equal margins.

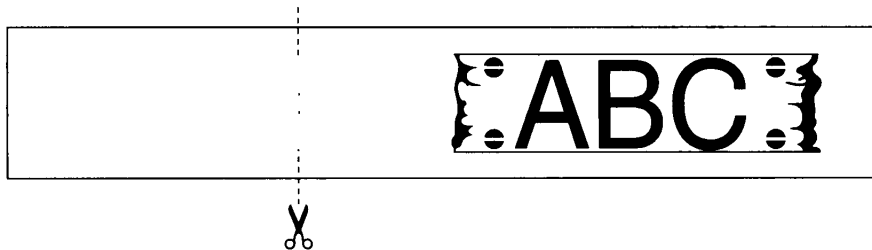

COLORED CHARACTERS

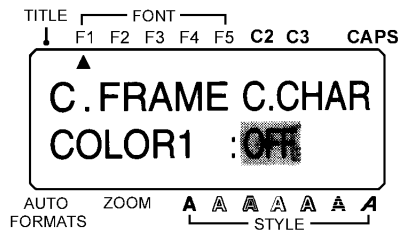

BACKGROUND

When printing multi-colored labels with character styles such as outline, solid or shadow, the part of the character that is left blank can be filled in using an ink color that is different from the one assigned to the character.

OFF COLOR1 COLOR2 COLOR3

Before printing the label, be sure that there is enough tape in the tape cassette, otherwise the label may not be printed correctly. Also check that the setting for the C.CHAR function has been chosen.

The color print settings assigned using this function are the same settings used in multi-color printing and with the C.FRAME function.

The C.CHAR setting can only be applied to the entire label. It cannot be applied to just part of the text. If only the normal and hold character styles are used in the label, this setting is ignored during printing.

OPERATION

TO SET THE COLORED CHARACTER FUNCTION:

- (1) Press the **FORMAT** key.
- (2) Press the **▶** and **◀** keys until the colored character setting (C.CHAR) is highlighted.

- (3) Press the **▲** and **▼** keys until the color you wish to use is displayed.

*The default setting (OFF) can be selected by pressing the **SPACE** key.*

- (4) Press the **RETURN** key.

EXAMPLE

The C.CHAR setting can be used with character styles other than normal and bold as shown below:

ABC
ABC

ABC
ABC

General Operation:

In this example, the first color is black and the second color is red.

- Press **AREA** and use **←** to highlight the entire message.

TITLE — FONT —
↓ F1 F2 F3 F4 F5 C2 C3 CAPS



AUTO ZOOM A A A A A A A
FORMATS — STYLE —

- Press **STYLE** until the indicator above the outline character style (A) comes on, then press **NEW BLOCK**.

TITLE — FONT —
↓ F1 F2 F3 F4 F5 C2 C3 CAPS



AUTO ZOOM A A A A A A A
FORMATS — STYLE —

- Press **FORMAT**, then use **←** and **→** to choose the colored character setting (C.CHAR) and **HOME** and **END** to select COLOR2.

TITLE — FONT —
↓ F1 F2 F3 F4 F5 C2 C3 CAPS



AUTO ZOOM A A A A A A A
FORMATS — STYLE —

- Press **NEW BLOCK**.

TITLE — FONT —
↓ F1 F2 F3 F4 F5 C2 C3 CAPS

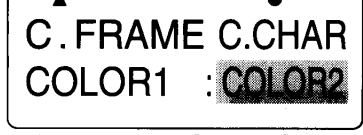

AUTO ZOOM A A A A A A A
FORMATS — STYLE —

- Open the tape compartment cover, insert multi-color printing ink and tape cassettes, then close the cover.

- Press **SPECIAL PRINT PRINT**, then press **NEW BLOCK** and follow the messages to continue printing with the multi-color printing function.

 Refer to the Multi-Color Printing section on pages 87 and 88 for a detailed explanation.

- Push down on the tape cutter lever to cut off the label, then use scissors to cut it along the two printed dots to make equal margins.

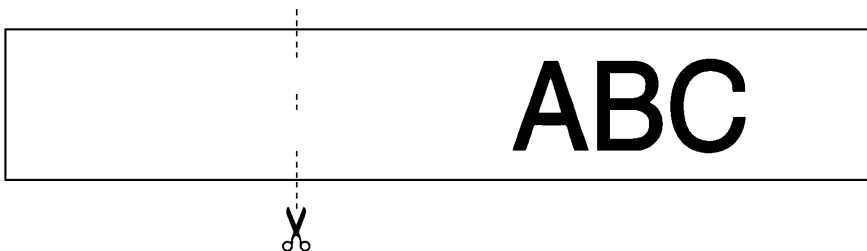

STORING/RECALLING/DELETING

BACKGROUND

The machine's memory can be used to save and recall your most frequently used text messages. These messages remain in the memory, even if you clear the working area by holding down the **CODE** key and pressing the **CLEAR** key. When stored, each file is given a number to make recall easier. File numbers are between 0 and 99. This machine's memory can store up to 3,400 characters. If the memory becomes full, subsequent storage attempts will cause the message "MEMORY FULL!" to be displayed. In this case, you must delete an existing text file before you can store the new one.

When a stored text file is recalled, a copy of that file is placed into the working area and can be edited, reformatted or printed. Since a copy is used, the original file is not removed from the memory, so you can recall the same file any number of times without changing it. When recalling a file, if some text is currently in the working area, you must choose whether to replace the working area text with the stored file or to join them.

When a file is no longer needed, you can erase it from the memory using the M.DEL function. This function can also be used to make space in the memory when it is full.

OPERATION

TO STORE A TEXT FILE IN THE MEMORY:

- (1) Hold down the **CODE** key and press the **STORE** key.
- (2) Press the **▲** and **▼** keys to choose a number between 0 and 99.
- (3) Press the **RETURN** key. The file is saved and can be recalled at any time.

 *If a file is already stored under the selected number, you will be asked whether you want to overwrite the previous message with the new one.*

To replace the stored file with the new message:

- (4) Press the **RETURN** key. The new file will be stored under the selected number and the previously stored file will be deleted.

 *Press the **CANCEL** key or the **CODE** and **STORE** keys at any time to leave Store mode without storing your message.*

TO RECALL A FILE FROM THE MEMORY:

- (1) Hold down the **CODE** key and press the **RECALL** key. The number and the first characters of the most recently stored file are displayed.
- (2) Press the **▲** and **▼** keys until the file you want to recall is displayed.
- (3) Press the **RETURN** key.

 *If there is no text in the working area, the file is now recalled. If there is some text in the working area, you will now be asked whether you want to join or overwrite the text with the recalled file.*

To replace the working area text with the recalled file.

(4) Press the **▲** and **▼** keys until OFF is displayed in the JOIN selection area.

(5) Press the **RETURN** key. The stored text file is recalled and overwrites the message in the working area.

 *If you choose to join the file and the working area text, the recalled file will be inserted in a new block at the cursor's position in the working area. Press the **CANCEL** key or the **CODE** and **RECALL** keys at any time to leave Recall mode without performing any action.*

EXAMPLE

General Operation:



- Press **CODE** + ***8** (RECALL) . Press **HOME** and **END** until the text file you want to recall, "AXZ", is displayed.

- Press **NEW BLOCK** (with left arrow). A message is shown asking whether you wish to join the recalled message with the message currently entered in the display.

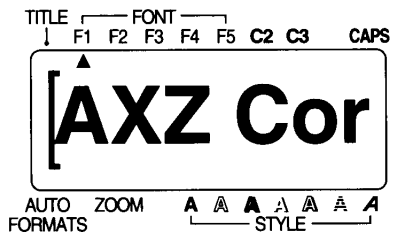
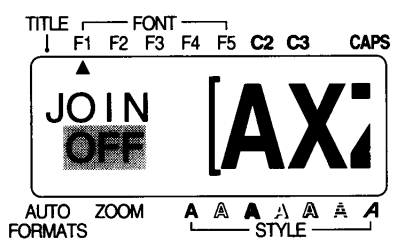
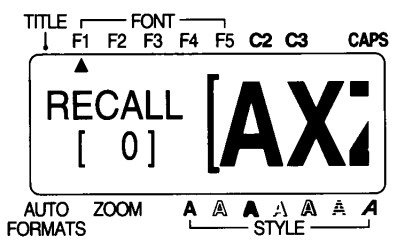
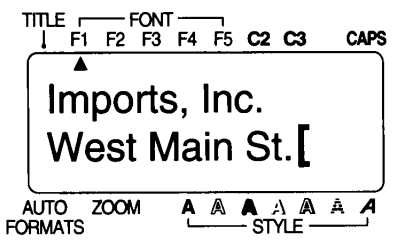
- Press **NEW BLOCK** (with left arrow) to replace the working area text with the recalled file.



TO DELETE A FILE FROM THE MEMORY:

- (1) Hold down the **CODE** key and press the **M.DEL** key.
- (2) Press the **▲** and **▼** keys until the file you want to delete is displayed.
 -  Hold down the **CODE** key and press the **SPACE** key to select all the files in the memory. If you then decide not to delete all of the files in the memory, hold down the **CODE** key and press the **CLEAR** key.
- (3) Press the **RETURN** key. The message "OK TO DELETE?" or "CLEAR ALL?" will be displayed.
- (4) To confirm, press the **RETURN** key again. The selected file or files are deleted.
 -  Press the **CANSEL** key or the **CODE** and **M.DEL** keys at any time to leave Memory delete mode without deleting the selected file or files.

NORMAL, MULTIPLE & SPLIT PRINTING

BACKGROUND

The **PRINT** key lets you print your text on the installed tape. The **SPECIAL PRINT** key allows you to set the number of copies of the label that will be printed, set whether the machine will pause between copies so that the tape can be cut, and turn the split printing function on and off.

PARAMETER	SETTINGS
Copies (COPIES) _____	1 to 99
Tape cut pause (PAUSE) _____	ON, OFF
Split printing (SPLIT) _____	OFF, ON

COPIES - This parameter determines how many copies of the current label will be printed.

TAPE CUT PAUSE - This parameter determines whether the machine will pause between copies so that the tape can be cut.

☞ *When this parameter is set to OFF, the left margin of the first label in a series of consecutively printed labels will be 1" (24 mm).*

SPLIT PRINTING - This parameter determines whether the label will be split lengthwise and printed as two labels.

☞ *These three special print parameters cannot be used with the multi-color print function.*

OPERATION

TO PRINT A LABEL:

Press the **PRINT** key. The text is printed once.

☞ *If the **PRINT** key is pressed in Auto format mode when the installed tape cassette is not the correct size for the label being printed, a message will appear to instruct you on which tape to install.*

*Press the **FEED** key to feed 1" (24 mm) of tape.*

TO PRINT A LABEL USING A SPECIAL PRINT PARAMETER:

(1) Hold down the **CODE** key and press the **SPECIAL PRINT** key.

If the default settings are O.K., press the **RETURN** key. (Refer to page 110 for the default print settings.)

To change the special print settings:

(2) Press the **▶** and **◀** keys until the first setting you wish to change is highlighted.

(3) Press the **▲** and **▼** keys until the desired setting is displayed. When the **COPIES** parameter is being set and these keys are pressed once, the setting will change

by 1. However, if either of these keys are held down, the setting will continue changing in step of 5 until the key is released.

 The default setting of the highlighted parameter can be selected by pressing the SPACE key or all special print settings can be returned to their default settings by holding down the **CODE** key and pressing the **SPACE** key.

- (4) Repeat step (2) and (3) until your desired settings are displayed.
- (5) Press the **RETURN** key. The labels are printed using the print parameter that have been set.

EXAMPLE

(Text Message)

TITLE FONT

↓ F1 F2 F3 F4 F5 C2 C3 CAPS

↑

ABC1 [

Tape feed is set to
NONE.

AUTO ZOOM A A A A A A

FORMATS STYLE

Default Print Settings

COPIES: 1

PAUSE: ON

SPLIT: OFF

Custom Print Settings

Example 1

COPIES: 2

PAUSE: OFF

SPLIT: OFF

Example 2

COPIES: 1

PAUSE: ON

SPLIT: ON

Pause

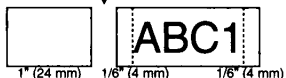

1" (24 mm) 1/6" (4 mm) 1/6" (4 mm)

Example 1



1" (24 mm) 1/6" (4 mm) 1/6" (4 mm) 1/6" (4 mm)

Example 2

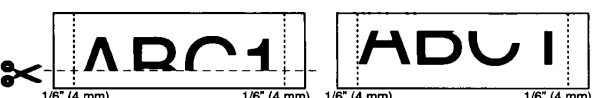

1/6" (4 mm) 1/6" (4 mm) 1/6" (4 mm) 1/6" (4 mm)

If the Split printing parameter is set to ON, labels like those shown above are printed. Cut off the blank space on the bottom of the top label and put the top and bottom parts together so that there is no break in the characters.

ABC1

 When the Split printing parameter is turned on, only one full copy of the label will be printed, regardless of the copies parameter setting.

110

Download from Wwww.Somanuals.com. All Manuals Search And Download.

MAKING STAMPS

BACKGROUND

This mode allows you to quickly and easily make pre-inked stamps for any need. After printing the stamp, affix the cut tape to a stamp holder for immediate and frequent use. Since the stamp holder is reusable, just make a new stamp tape and replace the one in the holder.

OPERATION



TO MAKE A STAMP:

- (1) Type in your text, open the tape compartment cover insert a stamp cassette, then close the cover.
- (2) Hold down the **CODE** key and press the **STAMP** key. The message "STAMP FORMAT" is displayed.
- (3) Press the **RETURN** key to enter Stamp mode. The text is centered within the preset message area and the tape length and margins are automatically adjusted.
- (4) Press the **RETURN** key. Your text is cut from the installed stamp tape.
- (5) Push down on the tape cutter lever, remove the backing paper from the stamp tape and affix it to the ink pad of a stamp holder.

 If stamp holder is being reused, peel off the old tape before affixing the new one.

EXAMPLE

General Operation:

• Press  + .

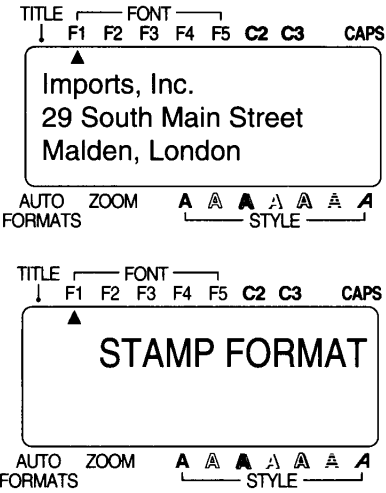

- Press  .

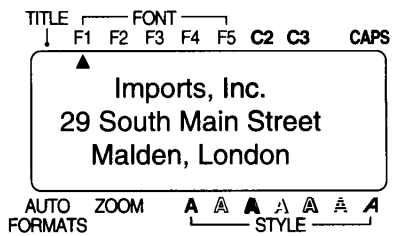

- Press  .

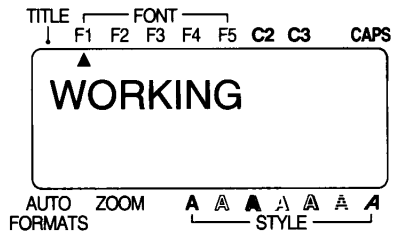

- Push down on the tape cutter lever to cut off the stamp tape, then peel off the backing paper.

- Affix the stamp tape to the ink pad on the stamp holder.



Refer to the instructions included with the stamp accessories.

BAR CODING

BACKGROUND

The bar coding function, which enables bar codes to be printed as part of labels, is one of this machine's most advanced features.

 This section will explain how to enter a bar code into your text message. It is not intended as a comprehensive introduction to the concept of bar coding. For more detailed information, please consult one of the many reference books available.

Since this machine is not specifically designed for special bar code label making, some bar code readers may not be able to read the labels.

Use tape with blank characters on white adhesive when making labels containing bar code.

In Bar code mode, six different parameters can be set, allowing you to create custom bar code.

PAREMETER	SETTINGS
Protocols (PROTO) _____	CODE 39, 1-2/5, EAN13, EAN8, UPC-A, UPC-E, CODABAR, EAN 128, CODE 128, ISBN5, ISBN2, LASER B
Bar code width (WIDTH) _____	MEDIUM, SMALL, LARGE
Numbers printed below bar code (UNDER#) _____	ON, OFF
# of characters in code (CHARS) ____	AUTO, 4 to 22
Ratio (RATIO) _____	3:1, 2.5:1, 2:1
Check digit (CH. DIG) _____	OFF, ON

We recommend printing bar codes using the MEDIUM or LARGR width and FULL tape feed.

When the tape feed is reduced or a SMALL bar code width is used, the bar code may be difficult to used.

OPERATION

TO ENTER A BAR CODE INTO YOUR MESSAGE:

- (1) Hold down the **CODE** key and press the **BARCODE** key. If the cursor is located in a bar code that has already been entered, the current bar code settings will be displayed.
- (2) Enter the bar code data. If you wish to edit an existing bar code, enter the new data.

To edit the bar code settings:

- (3) Press the **FORMAT** key.
- (4) Press the **▶** and **◀** keys until the first setting you wish to change is highlighted.
- (5) Press the **▲** and **▼** keys until the desired setting is displayed.
- (6) Repeat steps (4) and (5) until the settings are as you wish.
- (7) Press the **RETURN** key.
- (8) Hold down the **CODE** key and press the **SYMBOL** key, then press the **▲** and **▼** keys until the appropriate symbol is displayed.

The following symbols can only be entered when using protocols EAN 128 or CODE 128.

VALUE	CHARACTER	VALUE	CHARACTER	VALUE	CHARACTER
3	#	71	BEL	89	EM
4	\$	72	BS	90	SUB
11	+	73	HT	91	ESC
28	<	74	LF	91	{
29	=	75	VT	92	FS
30	>	76	FF	92	
32	@	77	CR	93	GS
59	[78	SO	93	}
60	\	79	SI	94	RS
61]	80	DLE	94	~
63	-	81	DC1	95	US
64	NUL	82	DC2	95	DEL
65	SOH	83	DC3	96	FNC 3
66	STX	84	DC4	96	FNC 2
67	ETX	85	NAK	100	FNC 4

VALUE	CHARACTER	VALUE	CHARACTER	VALUE	CHARACTER
68	EOT	86	SYN	102	FNC1
69	ENQ	87	ETB		
70	ACK	88	CAN		

The following symbols can only be entered when using protocols CODE 39 or CODEBAR.

SYMBOL	CHARACTER
1	+
2	\$

(9) When you have finished, press the **RETURN** key.

TO DESIGNATE A BAR CODE AS A NUMBERING FIELD:

- (1) Position the cursor immediately before the bar code mark which you wish to select as the numbering field.
- (2) Hold down the **CODE** key and press the **SEQ.NUMBERING** key.
- (3) Press the **▲** and **▼** keys until the desired NUMBER setting appears.
- (4) Press the **RETURN** key. The set number of labels are printed.

EXAMPLE

General Operation:

- Press **CODE** + **# 3** .

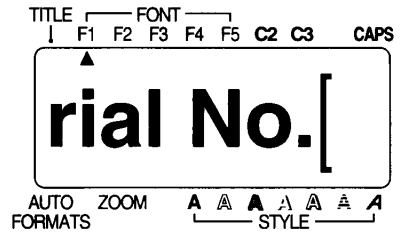

- Press **FORMAT** .

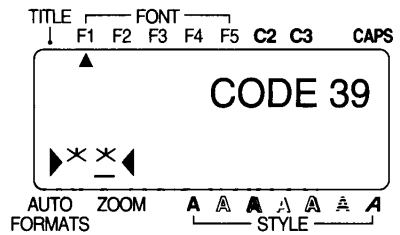

- Press **HOME** until EAN128 is displayed.

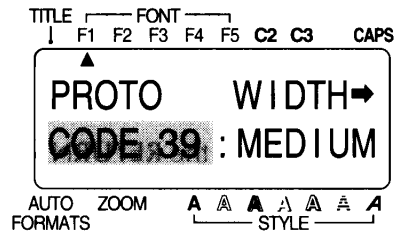

- Press **NEW BLOCK** .

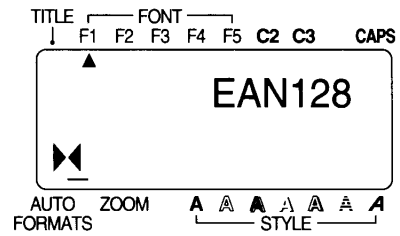
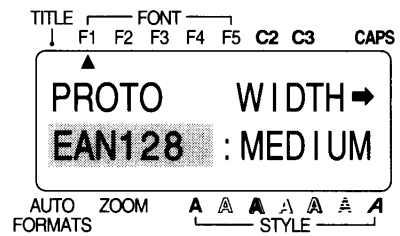

- Enter the bar code information ("123456").

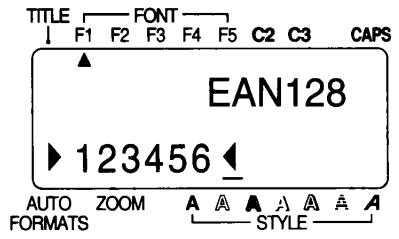

- Press

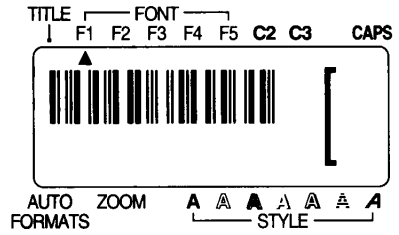

ERROR MESSAGE LIST

ERROR MESSAGE	CAUSE	REMEDY
4 DIGIT MIN.	<ul style="list-style-type: none"> •A minimum of four digits must be entered in a bar code. This message appears when less than four digits are entered. 	<ul style="list-style-type: none"> •Enter a minimum of four digits before pressing the RETURN key.
5 BARS LIMIT!	<ul style="list-style-type: none"> •Each label can contain no more than five bar codes. This message appears if five bar codes already exist when you press the BAR-CODE key or if you attempt to join a text file recalled from the memory to the current message, causing the number of bar codes to exceed the limit. 	<ul style="list-style-type: none"> •Limit the number of bar codes in the text message to five.
5 LINE LIMIT!	<ul style="list-style-type: none"> •Each block of text in a label can contain no more than five lines. This message appears if five lines already exist when you press the RETURN key or if you try to join a text file recalled from the memory to the current message, causing the block to exceed the five line limit. •This message appears if the cursor is positioned at the beginning of a block when you press the BACKSPACE key to join two blocks, resulting in a block containing a total of more than five lines. 	<ul style="list-style-type: none"> •Limit the number of lines in the current block to five and press the NEW BLOCK key. •Adjust the total number of lines in the two blocks so that they will have no more than five lines after they are joined, otherwise do not attempt to join the two blocks.
5 BLOCK LIMIT!	<ul style="list-style-type: none"> •Each label can contain no more than five blocks. This message appears if five blocks already exist when you press the NEW BLOCK key or if you try to join a text file recalled from the memory to the current message, causing the message to exceed the five block limit. 	<ul style="list-style-type: none"> •Limit the number of blocks in the text message to five.

ERROR MESSAGE	CAUSE	REMEDY
BATTERIES WEAK	<ul style="list-style-type: none"> • This message appears when the installed alkaline batteries become weak. 	<ul style="list-style-type: none"> • Replace the batteries or use the AC adaptor.
BUFFER EMPTY!	<ul style="list-style-type: none"> • This message appears if the LABEL LENGTH, AREA or SEQ. NUMBERING key is pressed when the working area buffer is empty. • This message appears if you try to print, but no text has been entered in to the working area. • This message appears if you try to store a message as a text file, but no text has been entered into the working area. 	<ul style="list-style-type: none"> • Enter some text before entering Label length, Area, or Seq. numbering mode. • Enter text before printing. • Enter text before printing.
BUFFER FULL!	<ul style="list-style-type: none"> • There is a limit on the amount of text that can be entered into the working area. This message appears if you try to enter a character, a diacritical mark, return, new block or space when the working area buffer is already full. • This message appears if a text format (font, size width, style, underling and framing, or color) key is pressed when the working area buffer is already full. • This message appears if the RETURN key is pressed in Symbol or Bar code mode when the working area buffer is already full. • This message appears if you try to join a text file recalled from the memory to the current message area buffer is already full. 	<ul style="list-style-type: none"> • You cannot enter any additional text in this text message. Delete some existing text so that more text can be entered. • Press the CANCEL key and delete some of the text before changing the text format. • Press the CANCEL key and delete some of the text before entering a symbol or bar code. • Press the CANCEL key and delete some of the text before joining the file to the current message.

ERROR MESSAGE	CAUSE	REMEDY
CANCELED DATA! PRESS ANY KEY	<ul style="list-style-type: none"> • This message appears if the CANCEL key is pressed while data is being transmitted from the computer to this unit in Interface mode. 	<ul style="list-style-type: none"> • Press any key other than the CODE, SHIFT, ALT or CAPS keys, then try again.
CAN'T DELETE TAPE EDGE!	<ul style="list-style-type: none"> • This message appears if the end of the tape cannot be detected during multi-color printing. 	<ul style="list-style-type: none"> • Pull out some excess tape and hold the end of the tape while turning the tape roll to tighten the tape in the cassette. • Align the end of the tape with the edge of the cassette, then try using the multi-color printing function again. Press the CODE and ▼ keys to skip colors and return to the point where printing stopped.
CAN'T HERE	<ul style="list-style-type: none"> • This message appears if a character, symbol, return or new block is entered while the cursor is located in a bar code field. • This message appears if the cursor is located in a bar code field and a text format (font, size width, style, underlining and framing, or color) key is pressed. • This message appears if a text file is recalled and joined to the current message while the cursor is located in a bar code field. 	<ul style="list-style-type: none"> • Move the cursor or delete the bar code field before entering the character, symbol, return or new block. • Move the cursor or delete the bar code field before pressing the text format key. • Move the cursor or delete the field before recalling the text files.
CHANGE ADAPTOR	<ul style="list-style-type: none"> • This message appears if a high-voltage adaptor is being used. 	<ul style="list-style-type: none"> • Remove the high-voltage adaptor and install the optional 7.0V 1.2A AC adaptor.
CLOSE THE COVER!	<ul style="list-style-type: none"> • This message appears in any mode when the tape compartment cover is open. 	<ul style="list-style-type: none"> • Close the compartment cover.

ERROR MESSAGE	CAUSE	REMEDY
CUT NOW	<ul style="list-style-type: none"> • This message appears after a label has been printed with the Cut pause mode on or before multi-color printing if the end of the tape is incorrectly positioned. 	<ul style="list-style-type: none"> • Press the tape cutter lever to cut the tape.
EJECT CUT TAPE & PRESS RETURN	<ul style="list-style-type: none"> • This message appears when the tape has been cut, but it not removed. 	<ul style="list-style-type: none"> • Remove the cut excess tape and press RETURN key.
ERROR!	<ul style="list-style-type: none"> • This message appears if you try printing in Interface mode without installing the correct tape cassette. 	<ul style="list-style-type: none"> • Press any key other then tape CODE, SHIFT, ALT or CAPS keys, then install the correct tape cassette.
ERROR! UL/FRM	<ul style="list-style-type: none"> • A maximum of 25 characters can be underlined or framed. This message appears if you try to underline or frame more then 25 characters. 	<ul style="list-style-type: none"> • Reduce the number of characters that are underlined or framed.
FIXED SIZE!	<ul style="list-style-type: none"> • This message appears if the RETURN key is pressed when a TITLE font is selected. • This message appears if a 1/4" (6-mm)- or 3/8" (9-mm)- wide tape is installed when text is entered using a TITLE font. • This message appears if the character size is changed when a TITLE font is selected. 	<ul style="list-style-type: none"> • Change the font. • Insert a tape cassette that is wide enough for TITLE font text to be printed on it. • Since the size is fixed, do not change it.
INPUT ABCD AT BEING & END	<ul style="list-style-type: none"> • This message appears when the CODABAR protocol is used in Bar code mode, but a letter between A and B has not been entered at the beginning and end of the bar code. 	<ul style="list-style-type: none"> • Enter a letter between A and D at the beginning and end of the bar code.
INPUT WHOLE CODE	<ul style="list-style-type: none"> • In Bar code mode, the number of digits required for a code can sometimes be set. This message appears if the set number of digits are not entered while inputting the bar code data. 	<ul style="list-style-type: none"> • Input the correct number of digits or change the number of digits set in the bar code parameters.

ERROR MESSAGE	CAUSE	REMEDY
INSTALL COLOR TAPE!	<ul style="list-style-type: none"> •This message appears if a multi-color cassette is not installed while assigning the color settings or during multi-color printing. 	<ul style="list-style-type: none"> •Install a multi-color printing ink ribbon and tape cassette.
INTERFACE ERROR!	<ul style="list-style-type: none"> •This message appears if a error occurs while data is being transmitted from the computer to this unit in interface mode. 	<ul style="list-style-type: none"> •Press any key other then the CODE, SHIFT, ALT or CAPS keys, then try
INVAL. CHRS!	<ul style="list-style-type: none"> •Numbering fields must be located within a single line. This message appears if characters in different lines are selected as the numbering field. •Numbering field cannot contain both characters and a bar code. This message appears if a bar code is selected together with other characters as a numbering field. 	<ul style="list-style-type: none"> •Adjust the numbering field so that it contains characters located within a single line of text. •Selected either the bar code or the characters alone as the numbering field.
KEY ERROR -XX-	<ul style="list-style-type: none"> •This message appears when there is a problem with the machine's circuits. 	<ul style="list-style-type: none"> •Contact your service representative.

ERROR MESSAGE	CAUSE	REMEDY
LENGTH LIMIT!	<ul style="list-style-type: none"> •The length of one label message is limited to one meter. This message appears if a character, symbol, diacritical mark, bar code, space, return or new block is entered, causing the text to exceed the one meter limit. •This message appears if the entered text exceeds the one meter limit when the power is turned on or while trying to print. •This message appears if a file is recalled and joined to the current message, causing the text to exceed the one meter limit. •This message appears if the RETURN key is pressed in Format mode, causing the text to exceed the one meter limit. 	<ul style="list-style-type: none"> •Delete some of the text or reduce the character size. •Delete some of the text or reduce the character size. •Press the CANCEL key and delete some of the text before recalling the file or joining the working area text and the file. • Press the CANCEL key and delete some of the text before entering a frame or other global format setting.
LINE LIMIT!	<ul style="list-style-type: none"> •This message appears if the number of lines in the text is greater then the maximum number of lines possible for the installed tape. 	<ul style="list-style-type: none"> •Reduce the number of lines or install a tape of greater width.
MEMORY FULL!	<ul style="list-style-type: none"> •This machine can store about 3,400 characters in its memory. This message appears when you try to store a message that is too large to fit in the available memory space. 	<ul style="list-style-type: none"> •Stop trying to store the message or delete an unwanted file to make room for the new one.
NO FILES!	<ul style="list-style-type: none"> •This message appears if you try to recall or delete a text file from the memory when none are currently stored. 	<ul style="list-style-type: none"> •Do not attempt to recall or delete a text file.
NO TAPE!	<ul style="list-style-type: none"> •This message appears if you attempt to print a label or feed the tape when a tape cassette is not installed. 	<ul style="list-style-type: none"> •Install a tape cassette and try again.

ERROR MESSAGE	CAUSE	REMEDY
NUMBERING BUFFER FULL	<ul style="list-style-type: none"> This message appears if the RETURN key is pressed in Seq. numbering mode when the working area buffer is already full. 	<ul style="list-style-type: none"> Press the CANCEL key and delete some of the text before entering Seq. numbering mode.
OPEN THE COVER!	<ul style="list-style-type: none"> This message appears when the tape compartment cover is closed while rewinding the tape during multi-color printing. 	<ul style="list-style-type: none"> Open the compartment cover, then press the RETURN key.
RAM PROBLEM!	<ul style="list-style-type: none"> This message appears if there is a problem with the machine's random access memory. 	<ul style="list-style-type: none"> Contact your service representative.
REPLACE BATTERIES!	<ul style="list-style-type: none"> This message appears when the installed alkaline batteries are about to run it. 	<ul style="list-style-type: none"> Replace the batteries or use the AC adaptor.
ROM PROBLEM!	<ul style="list-style-type: none"> This message appears if there is a problem with the machine's read only memory. 	<ul style="list-style-type: none"> Contact your service representative.
SYSTEM ERROR!	<ul style="list-style-type: none"> This message appears if there is a problem with the machine's software. 	<ul style="list-style-type: none"> Contact your service representative.
TOO HIGH!	<ul style="list-style-type: none"> This message appears if the size of the text is larger than the width of the installed tape. 	<ul style="list-style-type: none"> Reduce the size of the characters or install a tape of greater width.
TOO LONG!	<ul style="list-style-type: none"> This message appears if the width of the text is longer than the label length that has been set. This message appears if the text inputted as an entry in Auto format mode exceeds the preset length. 	<ul style="list-style-type: none"> Delete some of the text, reduce the character width or increase the preset label length. Enter fewer characters.
WRONG SELECT	<ul style="list-style-type: none"> This message appears if more than five characters are selected as the numbering field. This message appears if characters with different format settings are selected as the numbering field. 	<ul style="list-style-type: none"> Limit the numbering field to five characters. Only select characters with identical format settings.

TROUBLESHOOTING

PROBLEM	REMEDY
1. The display stays blank after you have turned on the machine or abnormal characters are displayed.	<ul style="list-style-type: none"> •Check that the AC adaptor is attached properly. •If you are using alkaline batteries, check that they are properly inserted. •If the batteries are low, replace them. •Hold down CODE and R keys and press the ON/OFF key twice to reset the machine. The display and all contents of the memory are also deleted.
2. The machine does not print or the printed characters are blurred.	<ul style="list-style-type: none"> •Check that the tape cassette has been inserted properly. •If the tape cassette is empty, replace it with a new one. •Make sure that the tape cassette cover has been closed.
3. The printed characters are not formed properly.	<ul style="list-style-type: none"> •If you are using alkaline batteries, they may be low. Try using the AC adaptor.
4. Striped tape appears.	<ul style="list-style-type: none"> •You have reached the end of the tape. Replace it with a new tape.
5. In multi-color print mode, the tape cannot be fed after the machine's power supply was suddenly cut (e.g. the power button was pressed or there was a power failure) while rewinding the tape, which caused the rewinding gear to remain engaged.	<ul style="list-style-type: none"> •Open the tape compartment cover, remove the multi-color tape cassette, then close the cover. Turn on the power and press the FEED key to disengage the rewinding gear, causing the message "NO TAPE!" to be displayed.

MACHINE SPECIFICATIONS

HARDWARE

Input device:	KEYBOARD - 63 keys
LCD	112 x 32 dots 19 indicators
Print tape	Pressure-sensitive, adhesive-based 5 widths available: 1/4" (6 mm) 3/8" (9 mm) 1/2" (12 mm) 3/4" (18 mm) 1" (24 mm)
Power supply:	6 AA alkaline batteries (optional AC adaptor model AD-30) Auto power off not key if pressed within 5 minutes or if the machine is not used for 10 minutes during Interface mode.
Print head:	128 dot / 180 dpi
Dimensions:	8 1/2" x 8 1/2" x 2 2/3"(215 x 215 x 68 mm)
Weight:	2 lbs 3 oz (1 kg)

SOFTWARE

Character size:	6 sizes (6, 10, 13, 19, 26, and 38 points) + AUTO All are available in NARROW, MEDIUM and WIDE
Character fonts:	8 built-in typefaces
Buffer size:	Single line - 1 m Multi-line Multi-block
Memory size:	3,400 characters
Number of characters:	247 characters
Print styles:	Normal, Bold, Outline, Solid, Shadow and Outline + Shadow, Striped (all can be combined with Italic)

FEATURES

The P-touch 580C features the following:

- WYSIWYG display
- Multi-color printing
- Stamp creating
- Auto format
- Multi-line printing (up to 5 lines)
- Multi-block printing (up to 5 blocks)
- 6 sizes & 14 styles
- Text and label framing
- Text underlining
- Vertical printing
- Mirror printing
- Horizontal & vertical alignment adjustment
- Adjustable tape feed
- Label length setting
- Repeat printing
- Split printing
- Numbering function
- Bar code generation
- Zooming in and out

INDEX

- A**
AC adaptor 8, 10, 48
Accented characters 54
Accessories 132
Alignment
 Horizontal 97
 Vertical 98
ALT key 50
AREA key 75
AUTO FORMATS key 69
Automatic backup 48
Automatic power off 48
- B**
BACKSPACE key 21, 63
Backup 48
Bar code
 Check digit 113
 Numbering 58, 115
 Settings 113
 Symbols 114
Batteries 8, 9, 48
Blank display 125
Blocks 57
Bold character style 83
Bottom alignment 98
Boxing 86, 93
- C**
CANCEL key 56, 60
Canceling
 Deleting stored text 108
 Operations 60
 Recalling stored text 106
 Storing text 105
CAPS key 21, 50
Cassette 8, 12
Center alignment
 Horizontal 97
 Vertical 98
Character sizes 81
Character styles 83
Character widths 81
Check digit 113
Cleaning
 Machine's surface 8
 Print head and rollers 16
CLEAR key 65
CODABAR symbols 115
CODE 39 symbols 115
CODE key 51
CODE 128 symbols 114
Color printing 87
Colored characters 103
Colored frames/shading 101
Combination character styles 83
Composite characters 54
Computer connection 11
CONTRAST key 68
COPIES setting 109
Creating
 Bar codes 113
 Blocks 57
 Global Formats 77
 Local formats 75
 Stamps 111
Cursor movement 19, 62
Cursors 19, 42
Cut pause 109
- D**
Default settings
 Character colors 103
 Font 79
 Frame color 101
 Framing
 Global format 93
 Local format 86
 Global formatting 77
 Horizontal alignment 97
 Label length 99
 Mirror printing 96
 Multi-color printing 87
 Size 81
 Style 83
 Tape feed 94
 Underlining 86
 Units 100
 Vertical alignment 98

Vertical printing	95
Width	81
Deleting	
Stored labels	108
Symbols	64
Text	63, 64
Working area text	65
Diacritical marks	54
Displaying	
Final layout	66
Label length	67
Units	100
E	
EAN 128 symbols	114
END key	62
Ending a line	55
Entering	
Capital letters	50
Composite characters	54
Diacritical marks	54
Selections	56
Symbols	50, 52
Error messages	118-124
F	
Failure to print	125
Features	7
FEED key	109
Font	79
Format indicators	19
FORMAT key	26
Framing	86, 93
Multi-color	101
G	
Global formatting	27, 77
H	
HOME key	62
Horizontal alignment	97
I	
Incrementing	58
Indicator	
AUTO FORMATS	69
C2 and C3	88
CAPS	50
Fonts	79

Italic	83
Style	83
TITLE	79
ZOOM	66
Instant lettering tape	15
Interface connection	11
Italic character style	83
J	
Joining recalled text	106
Justifying text	97
K	
Keyboard	6
Key top symbols	50
L	
Label backing removal	15
Label length	
Displaying	67
Selecting	99
Label templates	69
LCD display	6
Left alignment	97
LINE OUT key	64
Local formatting	28, 36, 75
M	
Malformed characters	125
Margin width	94
Memory	
Deleting	108
Joining	106
Overwriting with recalled text	106
Recalling	105
Storing	105
Mirror printing	96
Multi-color printing	87
Framing	101
Shading	101
Style	103
Multiple blocks	39
Multiple printing	32
N	
NEW BLOCK key	39, 57
Non-keytop symbols	52-53
Normal character style	83
Numbering	44, 58

Bar codes	58, 115
Symbols	58
O	
On/Off button.....	19
Outline character style	83
Overwriting with recalled text.....	106
P	
Pause printing	32
Power button	19, 48
Precautions	8
Print head.....	16
PRINT key.....	109
Printing	
Default settings.....	110
Failure	125
Malformed characters	125
Multi-color.....	87
Multiple copies	32
Protocols.....	113
R	
Recalling labels	31, 105
Removing label backing	15
Repeat printing	32
Resetting the machine	48
RETURN key.....	55, 61
Right alignment	97
Rollers.....	16
Rub-on transfers.....	15
S	
Selecting	
Character colors	87, 103
Character sizes.....	81
Character styles.....	83
Character widths.....	81
Fonts.....	79
Frame color	101
Framing.....	86, 93
Horizontal alignment	97
Italics.....	83
Label length.....	99
Margin width.....	94
Mirror printing	96
Numbering field.....	58
Print settings.....	109
Shading color.....	101

Tape feed.....	94
Underlining.....	86
Units	100
Vertical alignment.....	98
Vertical printing.....	95
SEQ. NUMBERING key.....	58
Shading	86, 93
Multi-color	101
Shadow character style	83
SHIFT key.....	50
Size	81
SPACE key.....	20
Special printing	32, 109
Stamps	111
Storing labels	30, 105
Striped character style.....	83
Striped tape	125
Style	83
Multi-color	103
SYMBOL key	22, 52
Symbols	
Bar codes.....	114
Deleting	63, 64
Key top	50
Non-key top.....	52-53
Numbering	58
T	
Tape cassettes.....	8, 12
Supplies	132
Tape cut pause	109
Tape cutter lever	4, 12, 13
Tape feed.....	94
Tape widths	
Maximum character sizes	81
Text	
Clearing all.....	65
Deleting	63
Joining	106
Overwriting with recalled text.....	106
Recalling	105
Storing	105
TITLE fonts.....	79
Top alignment	98
Troubleshooting	125
U	
Underlining	86

Units	100
Uppercase letters	20
V	
Vertical alignment	98
Vertical printing.....	95
Viewing	
Final layout.....	66
Label length.....	67
W	
Width	81
Working area text	
Joining.....	106
Overwriting with recalled text.....	106
WYSIWYG mode.....	19
Z	
ZOOM key.....	66

ACCESSORIES

Obtain tape cassettes and AC adaptors from your nearest authorized dealer Brother cannot be held responsible for trouble caused by use of unauthorized supplies.

Use only Brother TZ tapes with this machine. Do not use tape that do not have the TZ mark.

Stock No.	Description	QTY/ PACKAGE	PRICE
1" (24 mm) laminated tapes			
TZ-151	Black characters on clear adhesive	1	\$23.95
TZ-251	Black characters on white adhesive	1	\$23.95
TZ-451	Black characters on red adhesive	1	\$23.95
TZ-651	Black characters on yellow adhesive	1	\$23.95
TZ-252	Red characters on white adhesive	1	\$23.95
TZ-354	Gold characters on black adhesive	1	\$26.95
TZ-355	White characters on black adhesive	1	\$26.95
TZ-B51	Black characters on fluorescent orange adhesive	1	\$28.95
3/4" (18 mm) laminated tapes			
TZ-141	Black characters on clear adhesive	1	\$20.95
TZ-241	Black characters on white adhesive	1	\$20.95
TZ-242	Red characters on white adhesive	1	\$20.95
TZ-243	Blue characters on white adhesive	1	\$20.95
TZ-344	Gold characters on black adhesive	1	\$24.95
TZ-345	White characters on black adhesive	1	\$23.95
TZ-441	Black characters on red adhesive	1	\$20.95
TZ-541	Black characters on blue adhesive	1	\$20.95
TZ545	White characters on blue adhesive	1	\$23.95
TZ-641	Black characters on yellow adhesive	1	\$20.95
TZ-741	Black characters on green adhesive	1	\$20.95
TZ-B41	Black characters on fluorescent orange adhesive	1	\$24.95
TZ-M41	Black characters on clear (mat) adhesive	1	\$20.95
TZ-L041	Instant lettering tape	1	\$20.95
1/2" (12 mm) laminated tapes			
TZ-131	Black characters on clear adhesive	1	\$16.95
TZ-231	Black characters on white adhesive	1	\$17.95
TZ-232	Red characters on white adhesive	1	\$17.95
TZ-335	White characters on black adhesive	1	\$20.95

Stock No.	Description	QTY/ PACKAGE	PRICE
3/8" (9 mm) laminated tapes			
TZ-121	Black characters on clear adhesive	1	\$14.95
TZ-221	Black characters on white adhesive	1	\$16.95
TZ-325	White characters on black adhesive	1	\$18.98
TZ-421	Black characters on red adhesive	1	\$16.95
1/4" laminated tapes			
TZ-111	Black characters on clear adhesive	1	\$12.95
TZ-211	Black characters on white adhesive	1	\$14.95
TZ-315	White characters on black adhesive	1	\$17.95
Multi-color printing cassettes			
TZ-T240	White tape	1	\$19.95
TZ-R041	Black ink ribbon	1	\$12.95
TZ-R042	Red ink ribbon	1	\$12.95
TZ-R043	Blue ink ribbon	1	\$12.95

OPTIONS

Stock No.	Description	QTY/ PACKAGE	PRICE
AD-30	AC adaptor	1	\$21.95
6997	Optional carrying case	1	\$39.95

SUPPLIES ORDER FORM

Dear Customer:

Please send this order, along with proper payment, to the address below, OR, Visa, MasterCard or Discover holders, call toll free, 1-800-284-4357, or fax your completed order form to 1-800-947-1445

Stock No.	Description	Price	Quantity	Total
			Subtotal	

Name: _____
 Address: _____
 City: _____
 State/Zip: _____
 Daytime Phone: _____

Accessory Subtotal: \$ _____
 AZ, CA, CT, GA, IL, LA, MA, MI, MN,
 MO, NC, NJ, NV, NY, TN, TX, VA, WA,
 residents add applicable sales tax \$ _____

Shipping/Handling Options

Please choose one:

- Standard (\$5.00)
- 2nd day air freight (\$8.75)
 Mandatory for all deliveries
 outside of the continental U.S.
 (Alaska, Hawaii, Puerto Rico,
 Virgin Islands & Canada)
- All other overseas orders (\$25.00) \$ _____

SEND ORDER FORM TO:

Brother International Corp.
 Attn: Consumer Accessory Div.
 P.O. Box 341332
 Bartlett, TN38184-1332

TOTAL DUE \$ _____

Method of payment (Check one)

() Visa () MasterCard () Check/Money Order

Account Number _____

Expiration Date _____

Signature _____

* Prices subject to change without notice.



SUPPLIES ORDER FORM

Dear Customer:

Please send this order, along with proper payment, to the address below, OR, Visa, MasterCard or Discover holders, call toll free, 1-800-284-4357, or fax your completed order form to 1-800-947-1445

Stock No.	Description	Price	Quantity	Total
Subtotal				

Name: _____
 Address: _____
 City: _____
 State/Zip: _____
 Daytime Phone: _____

Accessory Subtotal: \$ _____
 AZ, CA, CT, GA, IL, LA, MA, MI, MN,
 MO, NC, NJ, NV, NY, TN, TX, VA, WA,
 residents add applicable sales tax \$ _____

Shipping/Handling Options
 Please choose one:
 • Standard (\$5.00)
 • 2nd day air freight (\$8.75)
 Mandatory for all deliveries
 outside of the continental U.S.
 (Alaska, Hawaii, Puerto Rico,
 Virgin Islands & Canada)
 • All other overseas orders (\$25.00) \$ _____

SEND ORDER FORM TO:
 Brother International Corp.
 Attn: Consumer Accessory Div.
 P.O. Box 341332
 Bartlett, TN38184-1332

TOTAL DUE \$ _____

Method of payment (Check one)
 Visa MasterCard Check/Money Order
 Account Number _____
 Expiration Date _____
 Signature _____

* Prices subject to change without notice.



GUÍA DEL USUARIO

SU P-TOUCH 580C

¡Muchas gracias por la adquisición del P-Touch 580C!

Su nuevo P-Touch le permitirá diseñar e imprimir etiquetas para cualquier aplicación. Como es extremadamente versátil, usted podrá crear caracteres de muchos tamaños y estilos. Además, utilizando la amplia variedad de cassettes de cinta disponibles, podrá imprimir etiquetas con anchuras diferentes y hermosos colores.

Usted ya no tendrá que preocuparse por tareas urgentes que requieran impresión profesional. En la oficina, la fábrica, el laboratorio, y el hogar, la calidad y el rendimiento del P-Touch 580C hacen que sea una máquina muy versátil.

Finamente, como es posible que desee consultar este manual de vez en cuando, le sugerimos que lo guarde en un lugar que le quede a mano.

AVISO DE FCC

Este equipo ha sido probado y se ha encontrado que satisface los límites para dispositivos digitales de Clase B, según la Parte 15 de las Normas de FCC. Estos límites están perparados para proporcionar una protección razonable contra la interferencia dañina en instalaciones residenciales. Este equipo genera, emplea, y puede radiador energía de radiofrecuencia y, si no se instala de acuerdo con las instrucciones, puede causar interferencias perjudiciales en las radiocomunicaciones. Sin embargo, no se garantiza que no ocurrirán interferencias en una instalación en particular. Si este equipo causa interferencias perjudiciales en la recepción de radio o televisión, lo cual puede determinarse conectando y desconectando el equipo, se aconseja al usuario que corrija la interferencia mediante una o más de las medidas siguientes: Reoriente l reubique la antena de recepción.

Aumente la separación entre el equipo y el receptor.

Conecte el equipo a una toma de corriente que esté en un circuito distinto al que se ha conectado el receptor.

Consulte al distribuidor o a un técnico experimentado en radio/TV.

El cable de interfaz incluido deberá utilizarse para asegurar que se setisfacen los límites para aparatos digitales de la Clase B.

Los cambios o modificaciones no expresamente aprobados por Brother Industries, Ltd. puede invalidar la autoridad del usuario para operar el equipo.

Este equipo está cubierto por una o más de las patentes siguientes.

USP4839742	USP4983058	EP315369	BB2223740
USP4922063	USP5009530	EP322918	
USP4927278	USP5069557	EP322919	
USP4966476	USP5120147		
USP4976558			

ÍNDICE

PRECAUCIONES GENERALES	2
FUENTE DE ALIMENTACIÓN/ADAPTADOR DE CA (OPCIONAL)	3
CONEXION CON UN ORDENADOR	4
CASSETTES DE CINTA	5
LIMPIEZA DEL CABEZAL DE IMPRESIÓN	8
OPERACIONES DE TECLAS	9
SÍMBOLOS	10
NUMERACIÓN SECUENCIAL	11
MOVIMIENTO DEL CURSOR	12
CANCELACIÓN	12
BORRADO DE TEXTO	13
MODO ZOOM	14
LONGITUD DE ETIQUETA	14
CONTRASTE	14
FORMATO AUTOMÁTICO	15
JUEGO TIPOGRÁFICO	16
TAMAÑO/ANCHURA	17
ESTILO/CURSIVA	18
SUBRAYADO/ENCUADRE	19
IMPRESIÓN DE COLORES MÚLTIPLES	20
ENCUADRE	22
AVANCE DE CINTA	23
IMPRESIÓN VERTICAL	24
IMPRESIÓN DE ESPEJO	24
ALINEACIÓN HORIZONTAL	25
ALINEACIÓN VERTICAL	25
LONGITUD	26
UNIDADES DE VISUALIZACIÓN	26
ENCUADRES/SOMBREADOS COLOREADOS	27
CARACTERES COLOREADOS	28
ALMACENAMIENTO/INVOCACIÓN/BORRADO DE LA MEMORIA	29
IMPRESIÓN E IMPRESIÓN ESPECIAL	31
MARCADO CON SELLO	33
CÓDIGOS DE BARRAS	34
LISTA DE MENSAJES DE ERROR	37
ESPECIFICACIONES DEL P-TOUCH	44
ACCESORIOS	45

PRECAUCIONES GENERALES

- Utilice solamente cintas TZ Brother con esta máquina. No use cintas que no posean la marca TZ.
- Existen cinco anchuras de cintas TZ disponibles: 1/4" (6 mm), 3/8" (9 mm), 1/2" (12 mm), 3/4" (18 mm), y 1" (24 mm).
- No tire de la cita. Esto podría dañar el cassette.
- Evite utilizar la máquina en lugares extremadamente polvorientos. Manténgala alejada de la luz solar directa y de la lluvia.
- No exponga la máquina a altas temperaturas ni a gran humedad. No la deje nunca en el panel de instrumentos ni en la bandeja trasera de su automóvil.
- No deje ningún objeto de goma ni de vinilo sobre la máquina durante mucho tiempo. Si lo hiciese, podría mancharla.
- No limpie la máquina con alcohol ni otros disolventes orgánicos. Utilice un paño suave y seco solamente.
- No inserte ningún objeto extraño en la máquina.
- Para evitar daños personales, no toque el borde del cortador.
- Cuando inserte pilas nuevas, cerciórese de hacerlo antes de cinco minutos de haber extraído las viejas, ya que de lo contrario todos los mensajes se perderían (a menos que la máquina esté enchufada en un tomacorriente de Ca con el adaptador CA).
- Utilice el adaptador de CA, MODELO AD-30, diseñado exclusivamente para esta máquina. La utilización de cualquier otro adaptador podría anular la garantía.
- Cuando no vaya a utilizar la máquina durante mucho tiempo, y no sea necesario mantener almacenados los mensajes en la memoria, extraiga las pilas para evitar que se fugue su electrólito y dañe la máquina, y desconecte el adaptador de CA.
- Cuando el adaptador de CA esté enchufado en la máquina, desenchufándolo del tomacorriente de CA podrá borrar todos los mensajes de la memoria, incluso aunque las pilas estén insertadas.
- **Utilice pilas alcalinas AA con esta máquina.**

Ésta es una máquina ligera y portátil. Podrá utilizarse en cualquier parte insertándole seis (6) **pilas alcalinas AA**. Cuando cambie las pilas, reemplácelas todos simple al mismo tiempo.

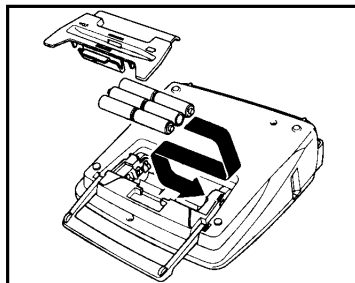
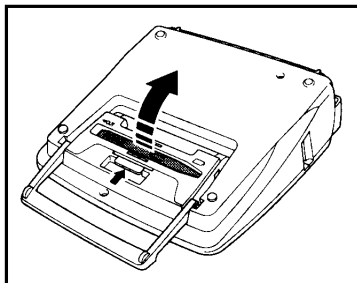

 *Cerciórese de insertar las nuevas pilas de cinco minutos de haber extraído las viejas,*

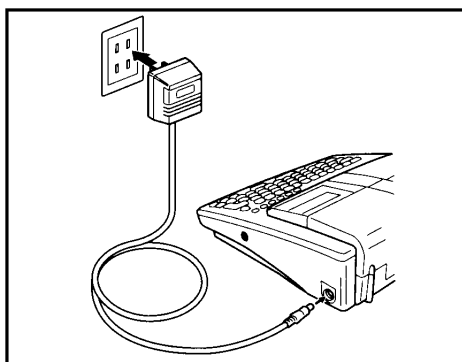

CONEXION CON UN ORDENADOR

Esta máquina está provista de una toma que permite imprimir sellos y etiquetas que usted haya creado con le programa P-Touch EDITOR instalado en su ordenador IBM o compatible.

PARA CONECTAR EL ORDENADOR:

- (1) Asegúrese de que el P-Touch 580C y el ordenador tengan la alimentación desconectada.
- (2) Inserte la clavija pequeña del cable de conexión en la toma marcada con la palabra **INTERFACE** del lado derecho del P-Touch 580C.
- (3) Inserte la clavija grande en el acceso COM de su ordenador IBM.
 - ☞ *Emplee la clavija que sea compatible con el acceso COM de su ordenador y deje la otra clavija desconectada.*
- (4) Conecte la alimentación del P-Touch 580C y luego ponga en funcionamiento el ordenador.
 - ☞ *Mantenga pulsada la tecla **CODE** y pulse la tecla **INTERFACE** del P-Touch 580C para introducir el modo de interfaz.*
 - Emplee sólo el cable de conexión diseñado exclusivamente para esta máquina.*

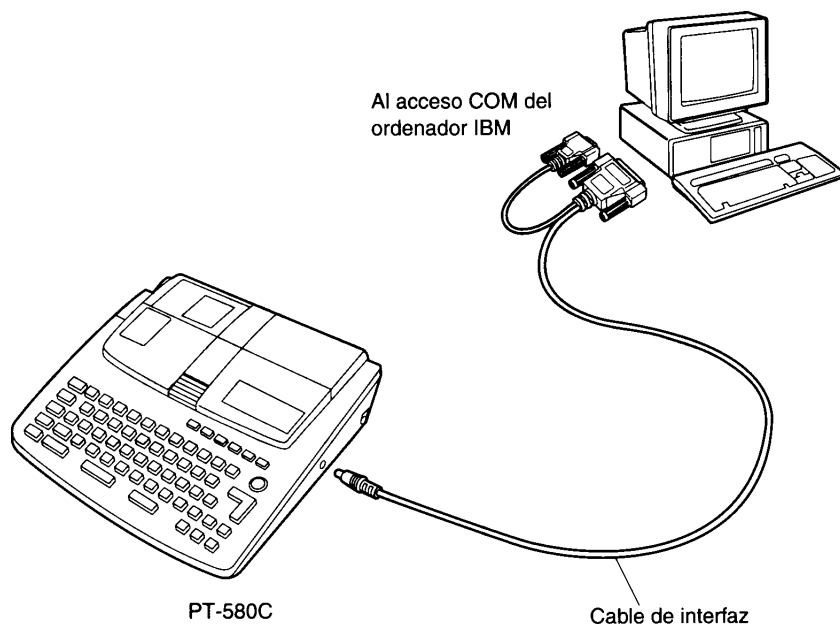

CASSETTE DE CINTA

Con esta unidad se suministra un solo cassette de cinta TZ. Como las cintas para esta máquina están disponibles en una amplia variedad de colores de fondo, colores de caracteres, y tamaños de cintas, podrá hacer rápida y fácilmente los cassettes de cinta.

PARA INSERTAR UN CASSETTE DE CINTA TZ:

- (1) Presione hacia abajo el botón liberador de la cubierta y levante la tapa del compartimiento para abrirlo.
- (2) Si ya hay un cassette de cinta en el compartimiento, extráigalo tirando de él hacia arriba.
- (3) Extraiga el tope del cartucho de cinta nuevo, y si la cinta está floja, emplee un dedo para bobinarla en la dirección de la flecha, que hay en el cartucho de cinta, hasta que quede tensada. Si emplea una cinta que ha empleado antes, asegúrese de que la cinta esté tensada antes de insertarla en la unidad. Si emplea una cinta usada, asegúrese de que la cinta esté tensa antes de insertarla en la máquina.
- (4) Inserte firmemente el cassette de cinta en el compartimiento.
 *Cuando inserte el cassette de cinta, cerciórese de que la cinta interior no quede atrapada en la esquina de la guía metálica.*
- (5) Cierre la tapa del compartimiento y presione la tecla **ON/OFF**.
- (6) Pulse una vez la tecla **FEED** para hacer que la cinta avance y tensada.
- (7) Presione hacia abajo la palanca del cortador de cinta.

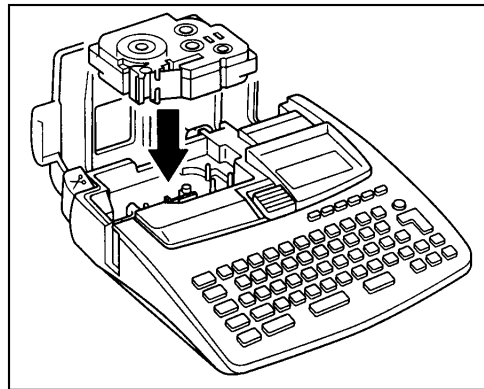
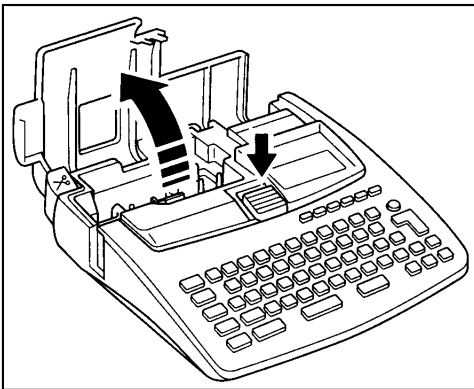

PARA INSERTAR CASSETTES DE CINTA Y DE TINTA DE COLORES MÚLTIPLES:

- (1) Presione hacia abajo el botón liberador de la cubierta y levante la tapa del compartimiento para abrirlo.
- (2) Si ya hay un cassette de cinta en el compartimiento, extraígalo tirando de él hacia arriba.
- (3) Si la cinta del cassette de tinta está floja, bobine con el dedo la rueda dentada en la dirección de la flecha del cassette de cinta hasta que la cinta esté tensa. Luego, inserte el cassette de tinta recto abajo adentro del cassette de cinta.
- (4) Saque la cinta adhesiva del extremo de la cinta de etiquetas y extraiga aproximadamente 12 mm (1/2") de cinta de etiquetas. Si emplea una cinta usada, asegúrese de que la cinta se suministre a través del cassette y que el final de la cinta quede debajo de las guías de la cinta.
- (5) Inserte los cassettes de tinta y de cinta firmemente en el compartimiento.
 *Cuando inserte los cassette, asegúrese de que la cinta no se enganche en la esquina de la guía metálica y que no se enganche tampoco en el cortador de cinta.*
- (6) Cierre la tapa del compartimiento y presione la tecla **ON/OFF**.
- (7) Pulse una vez la tecla FEED para hacer que la cinta avance y tensarla.
- (8) Presione hacia abajo la palanca del cortador de cinta.

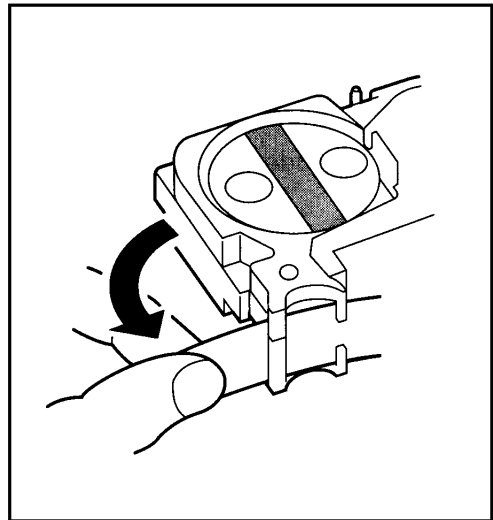
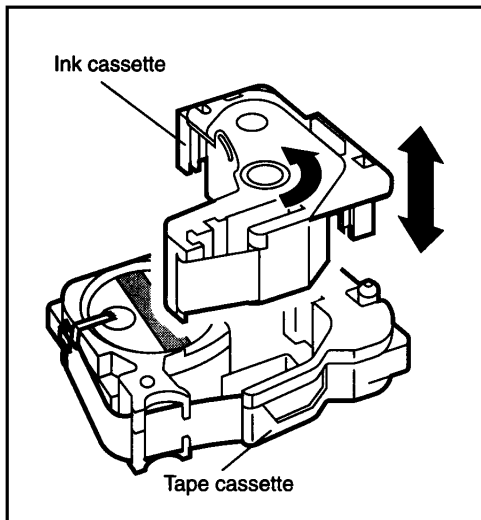

Si se rebobina demasiada cinta en el cassette:

- (1) Extraiga la cinta y los cassettes de cinta de la máquina y extraiga luego el cassette de tinta del cassette de la cinta.
- (2) Use el dedo para guiar la cinta en la caja del cassette.

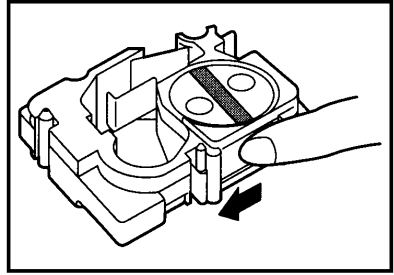

-  *Si queda poca cinta en el cassette, tire un poco de la cinta y póngala en la ranura con los dedos.*

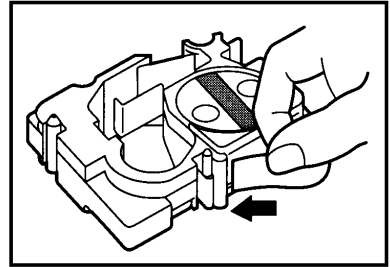

- (3) Use el dedo para guiar el extremo de la cinta por la ranura y en torno a la caja del cassette.

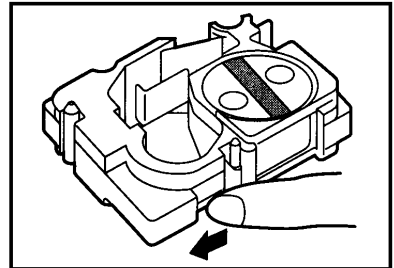

- (4) Deslice la cinta por debajo de las guías de cinta.

-  *Asegúrese de que la cinta pasa por debajo de la cinta de guía, en el borde de la caja del cassette.*

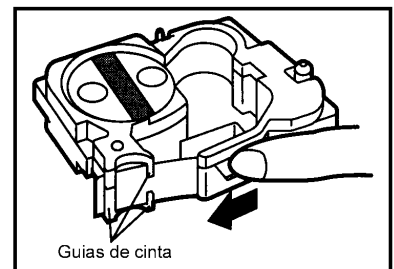

- (5) Tome el extremo de la cinta y gire el rodillo de la cinta hacia la izquierda para tensar la cinta.

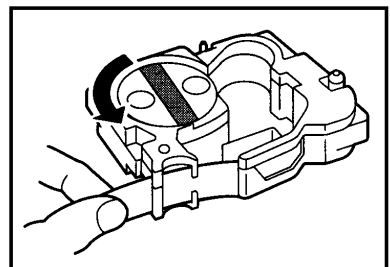

LIMPIEZA DEL CABEZAL DE IMPRESIÓN

Es posible que a veces se adhieran motas de polvo y suciedad al cabezal de impresión o a los rodillos de la máquina. Esto puede suceder especialmente cuando utilice la unidad en exteriores o en un ambiente muy polvoriento. Cuando ocurra esto, el elemento de impresión oscurecido por el polvo no podrá imprimir, causando una línea sin imprimir (en blanco) a lo largo de la etiqueta. Las líneas verticales indican que los rodillos están sucios, y las líneas horizontales indican que el cabezal de impresión está sucio. Por lo tanto, como en el caso de una grabadora de cassettes, es posible que haya que limpiar el cabezal de la máquina de vez en cuando.

PARA LIMPIAR EL CABEZAL DE IMPRESIÓN:

- (1) Desconecte la alimentación de la máquina.
 - (2) Abra la tapa del compartimiento del cassette y extraiga el cassette de cinta. El cabezal de impresión y los rodillos están situados en el compartimiento del cassette.
 - (3) Cabezal de impresión: Frote el cabezal de impresión suavemente con un palillo de algodón seco verticalmente hacia arriba.
Rodillos: Frote verticalmente cada rodillo con un palillo de algodón seco haciendo girar el rodillo con su dedo.
 - (4) Realice una impresión de prueba.
Si todavía queda polvo:
 - (5) Humedezca un palillo de algodón en alcohol isopropílico (de limpieza) y repita el paso (3).
- Si con esto no soluciona el problema, póngase en contacto con el representante de servicio.

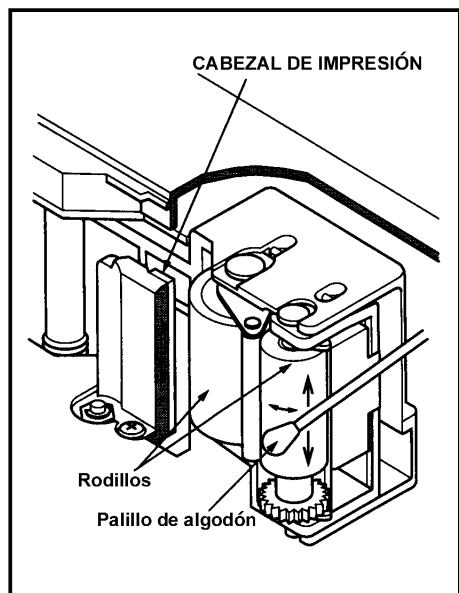
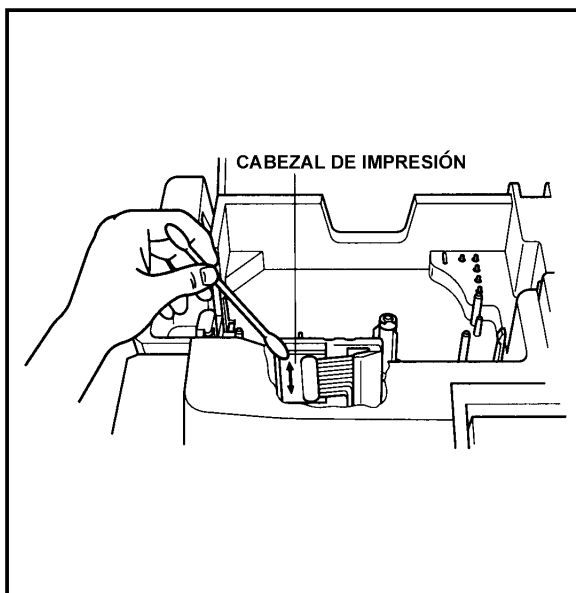

OPERACIONES DE TECLAS

La mayoría de los caracteres podrán introducirse pulsando simplemente sus teclas. Sin embargo, para introducir mayúsculas, caracteres con acentos, y algunos de los Símbolos más comunes, son necesarias ares teclas especiales.

TECLA SHIFT: Esta tecla el permitirá escribir los símbolos situados en la parte Superior de las teclas y letras mayúsculas. Sin embargo, los símbolos y las mayúsculas indicados en rojo tendrán que introducirse en el modo ALT. Para escribir una "A" mayúscula, mantenga presionada la tecla **SHIFT** y pulse la tecla **A**.

TECLA CAPS: La tecla **SHIFT** es muy útil introducir una sola mayúscula, por ejemplo, al comienzo de un nombre. Sin embargo, cuando desee introducir una serie de letras mayúsculas, tendrá que utilizar la tecla **CAPS**.

PARA ENTRAR EN EL MODO CAPS:

Mantenga presionada la tecla **CODE** y pulse la tecla **CAPS**.

Cuando este modo esté activado, estará encendido el indicador CAPS de la parte superior del visualizador de cristal líquido.

 *La utilización de la tecla SHIFT en el modo CAPS producirá letras minúsculas.*

Los juegos tipográficos de TITLE solamente producirán letras minúsculas.

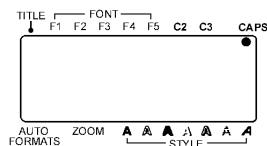

En el modo CAPS, las letras mayúsculas podrán escribirse simplemente pulsando las teclas de los caracteres (es decir, no será necesario presionar la tecla **SHIFT**). Sin embargo, cuando pulse teclas de números, aparecerán números - no símbolos sobre ellos.

Para salir del modo CAPS, mantenga presionada la tecla **CODE** y pulse la tecla **CAPS**. El indicador se apagará.

TECLA ALT: La tecla **ALT** le permitirá introducir los caracteres y los símbolos escritos rojo en las teclas.

PARA INTRODUCIR UN CARÁCTER ESCRITO EN ROJO:

Mantenga presionada la tecla **ALT** y pulse la tecla escrita en rojo.

Para salir del modo ALT, suelte la tecla **ALT**.

TECLA CODE: Mientras que las teclas **SHIFT**, **CAPS**, y **ALT** le permiten seleccionar varios caracteres y símbolos, la tecla **CODE** le permite elegir varias funciones. Las funciones escritas en verde podrán seleccionarse pulsando la tecla **CODE**.

SÍMBOLOS

Esta máquina posee muchas y símbolos especiales que podrá introducir en su texto. Cuando los introduzca, actuarán como los caracteres normales y podrán editar y borrarse. Aunque puede encontrar varios símbolos escritos en las teclas, en el modo SYMBOL están disponibles 126 marcas adicionales.

PARA INTRODUCIR UN SÍMBOLO NO ESCRITO EN UNA TECLA:

- (1) Mantenga presionada la tecla **CODE** y pulse la tecla **SYMBOL** para entrar en el modo SYMBOL.
- (2) Pulse las teclas **▲** y **▼** hasta que en el visualizador aparezca el símbolo deseado.
- (3) Pulse las teclas **▶** y **◀** hasta que el símbolo se resalte.
- (4) Para introducir el símbolo en su mensaje, pulse la tecla **RETURN**.

☞ *Para introducir continuamente muchos símbolos, seleccione cada símbolo y, después, manteniendo presionada la tecla **CODE**, pulse la tecla **RETURN**. Después de haber introducido su último símbolo, si desea abandonar del modo SYMBOL, pulse la tecla **RETURN**.*

En el código de barras no podrán introducirse los 126 símbolos del modo símbolos.

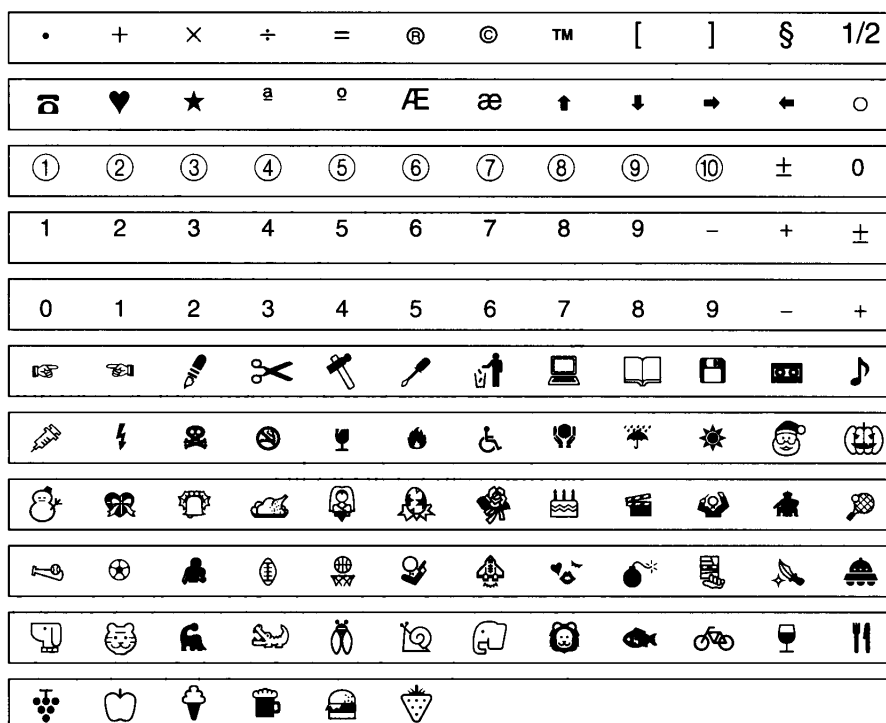

NUMERACIÓN SECUENCIAL

La función de numeración de esta máquina le permitirá designar un grupo de números y letras o un código de barras como campo de "numeración" e imprimir un juego de etiquetas en el que campo de numeración aumentará automáticamente en 1 después de haberse impreso una etiqueta.

PARA DESIGNAR UNA PARTE DE TEXTO COMO CAMPO DE NUMERACIÓN:

- (1) Coloque el cursor frente al primer carácter (número o letra) o el código de barras que desee incluir en el campo.
- (2) Mantenga presionada la tecla **CODE** y pulse la tecla **SEQ. NUMBERING**. Se visualizará brevemente el mensaje "SELECT FIELD!". El primer carácter se resaltará, indicando que está "activo".
- (3) Utilice las teclas **▶** y **◀** para mover el cursor hasta el último carácter que desee incluir. Todos los caracteres entre éste y el primero también se resaltarán.

 *El campo de numeración no podrá contener caracteres con ajustes de formato diferentes.*

Un campo de numeración podrá constar de un solo código de barras; en tal campo de numeración no podrán incluirse caracteres adicionales.

Un campo de numeración deberá encontrarse enteramente dentro de una línea de texto de un solo bloque. Si intenta incluir texto de dos líneas o de dos bloques diferentes en el campo de numeración, en el visualizador aparecerá un mensaje de error.

- (4) Pulse la tecla **RETURN**. Se visualizará la pantalla de ajuste **NUMBER**.
- (5) Pulse las teclas **▲** y **▼** hasta que aparezca el ajuste deseado. Por ejemplo si desea contar de 10 a 15, ajuste **NUMBER** a 6.
- (6) Pulse la tecla **PRINT** o **RETURN**. Después de haberse impreso el juego de etiquetas, el visualizador mostrará la etiqueta con el campo de numeración aumentado hasta el valor siguiente.

 *En cualquier mensaje de texto, solamente podrá seleccionarse un campo de numeración.*

El número máximo de caracteres de un campo de numeración es cinco.

Si trata de elegir más de cinco caracteres, insertar un carácter adicional en un campo de cinco caracteres, o incluir un carácter no alfanumérico en el campo de numeración, aparecerá un mensaje de error.

Si incluye un carácter no alfanumérico, como un símbolo en el campo de numeración, solamente aumentarán los caracteres del campo de numeración que puedan aumentar cuando imprima las etiquetas, o solamente se imprimirá una etiqueta si solamente incluye un carácter no alfanumérico en el campo.

MOVIMIENTO DEL CURSOR

Después de haber creado un mensaje, moviendo el cursor podrá ver o editar diferentes partes del texto.



En general, al pulsar esta tecla, el cursor se moverá un espacio o un carácter hacia la izquierda. Si el cursor está colocado al comienzo de una línea cuando pulse esta tecla, se moverá al final de la línea anterior. Si mantiene presionada la tecla **CODE** y presiona esta tecla, el cursor se moverá hasta antes del primer carácter del bloque de texto actual. Si vuelve a pulsar estas teclas, el cursor se moverá hasta el primer carácter del bloque anterior.

Si mantiene presionada la tecla **SHIFT** y pulsa esta tecla, el cursor se moverá hasta el comienzo de la línea actual del texto.



En general, al pulsar esta tecla, el cursor se moverá un espacio o carácter hacia la derecha. Si el cursor se encuentra al final de una línea cuando pulse esta tecla, se moverá hasta el comienzo de la línea siguiente.

Si mantiene presionada la tecla **CODE** y pulsa esta tecla el cursor se moverá hasta antes del primer carácter del siguiente bloque de texto.

Si mantiene presionada la tecla **SHIFT** y pulsa esta tecla, el cursor se moverá hasta el final de la línea actual del texto.



Al pulsa esta tecla, el cursor se moverá hasta antes del carácter situado directamente encima de su posición actual de la línea anterior.

Si mantiene presionada la tecla **CODE** y pulsa esta tecla, el cursor se colocará al comienzo del mensaje.



Al pulsar esta tecla, el cursor se moverá hasta antes del carácter inmediatamente debajo de su posición actual en la línea siguiente.

Si mantiene presionada la tecla **CODE** y pulsa esta tecla, el cursor se moverá hasta el final del mensaje.

CANCELACIÓN

La tecla CANCEL se encuentra en la fila inferior del teclado. Esta tecla posee dos funciones básicas.

PARA ABANDONAR UN MODO DE OPERACIÓN SIN REALIZAR NINGUNA ACCIÓN:

En general, la tecla **CANCEL** le devolverá a la pantalla o a la actividad anterior. Por ejemplo, si entra en un modo de operación pero decide volver a la introducción o la edición de texto, podrá pulsar la tecla **CANCEL**.

BORRADO DE TEXTO

RETROCESO

La tecla **BACKSPACE** le permitirá eliminar caracteres innecesarios de su mensaje. Difiere de la tecla **◀**, que simplemente mueve el cursor sin cambiar el mensaje. Sin embargo, la tecla **BACKSPACE** eliminará el carácter anterior al cursor.

PARA BORRAR UN CARÁCTER:

- (1) Utilizando las teclas de movimiento del cursor, coloque éste inmediatamente a la derecha del carácter que desee borrar.
- (2) Pulse la tecla **BACKSPACE**.

BORRADO DE LÍNEA

La tecla **LINE OUT** le permitirá eliminar líneas innecesarias de texto de su mensaje. También se eliminarán todos los símbolos de la línea borrada.

PARA BORRAR UNA LÍNEA DE TEXTO:

- (1) Utilizando las teclas de movimiento del cursor, coloque el cursor en la línea que desee borrar.
- (2) Mantenga presionada la tecla **CODE** y pulse la tecla **LINE OUT**.

BORRADO TOTAL

La tecla **CLEAR** le permitirá eliminar todo el texto y los símbolos del visualizador y devolver los formatos del texto a sus ajustes iniciales. En otras palabras, el archivo de texto actual se vaciará completamente. De esta forma, podrá iniciar la introducción de un mensaje de texto completamente nuevo.

PARA BORRAR UN ARCHIVO DE TEXTO:

- (1) Mantenga presionada la tecla **CODE** y pulse la tecla **CLEAR**.
- (2) Pulse la tecla **RETURN**.

 *El cursor podrá estar en cualquier punto del mensaje.*

MODO ZOOM

El modo ZOOM le permitirá ver cómo aparecerá una etiqueta cuando se imprima alejándolo del texto, o ver con detalle partes del mensaje acercándolas. Usted podrá utilizar las teclas del cursor para mover éste a fin de poder ver diferentes partes del mensaje.

PARA ENTRAR EN EL MODO ZOOM:

- (1) Pulse la tecla **ZOOM** y la visualización utilizará el acercamiento con zoom para ampliar el mensaje.
- (2) Vuelva a pulsar la tecla **ZOOM** y la visualización utilizará el alejamiento zoom para mostrar el mensaje tal cual imprimirá.
- (3) Para devolver el visualizador a la pantalla de introducción de texto, pulse una vez más la tecla **ZOOM** o pulse la tecla **CANCEL**.

LONGITUD DE ETIQUETA

Este modo visualizará brevemente la longitud de la etiqueta en pulgadas o centímetros, dependiendo del ajuste de la función UNIT.

PARA ENTRAR EN EL MODO DE LONGITUD DE ETIQUETA:

Mantenga presionada la tecla **CODE** y pulse la tecla **LABEL LENGTH**. La longitud de la etiqueta se visualizará brevemente.

CONTRASTE

Este modo se utiliza para ajustar el contraste del visualizador de cristal líquido. En el modo de contraste podrá entrarse desde el modo de introducción de texto, o desde el modo de formato automático.

PARA CAMBIAR EL CONTRASTE:

- (1) Mantenga presionada la tecla **CODE** y pulse la tecla **CONTRAST**.
- (2) Pulse las teclas **▶** y **◀** para ajustar el contraste.
- (3) Pulse la tecla **RETURN**.

 Para devolver el contraste a su ajuste inicial, pulse la tecla **SPACE**.

FOTMATO AUTOMÁTICO

La tecla **AUTO FORMATS** se encuentra en la esquina inferior izquierda del teclado. Este modo le permitirá introducir rápidamente texto en plantillas de composición a fin de poder imprimir fácilmente etiquetas utilizando los formatos preajustados.

PARA IMPRIMIR UNA ETIQUETA UTILIZANDO EL MODO DE FORMATO AUTOMÁTICO:

(1) Pulse la tecla **AUTO FORMATS**.

 Si ha se ha introducido texto en el visualizador, aparecerá un mensaje de confirmación. Presione la tecla **RETURN** para borrar el texto.

(2) Pulse las teclas **▲** y **▼** hasta que se visualice la composición deseada y presione la tecla **RETURN**.

(3) Introduzca el contenido de la etiqueta y pulse la tecla **RETURN**.

(4) Para imprimir la etiqueta, pulse la tecla **PRINT**.

En la tabla siguiente se indican introducciones para plantillas, que le permitirán seleccionar fácilmente la composición preajustada apropiada.

Plantillas de etiquetas
VCR VHS (3/4" (18 mm))
VCR 8mm-1 (3/8" (9 mm))
VCR 8mm-2 (1/2" (12 mm))
VCR VHSC-1 (1/2" (12 mm))
VCR VHSC-2 (3/4" (18 mm))
AUDIO-1 (1/4" (6 mm))
AUDIO-2 (3/8" (9 mm)), (1/2" (12 mm))
AUDIO-3 (3/8" (9 mm)), (1/2" (12 mm))
NAME PLATE (3/4" (18 mm)), (1" (24 mm))
ADDRESS (3/4" (18 mm)), (1" (24 mm))
EQUIPMENT (3/4" (18 mm)), (1" (24 mm))
EQUIPMENT (1/2" (12 mm))
SLIDE (1/2" (12 mm))
PPRICE (3/4" (18 mm)), (1" (24 mm))
SALE PRICE (3/4" (18 mm)), (1" (24 mm))
FILE LONG (3/4" (18 mm)), (1" (24 mm))
FILE LONGV (3/4" (18 mm)), (1" (24 mm))
CFIFE SHORT(3/8" (9 mm)), (1/2" (12 mm)), (3/4" (18 mm)), (1" (24 mm))
FLOPPY 3,5" (3/4" (18 mm)), (1" (24 mm))
FLOPPY 5" (3/4" (18 mm)), (1" (24 mm))

JUEGO TIPOGRÁFICO

Esta máquina dispone de ocho tipos de caracteres, o juegos tipográficos.
Los juegos tipográficos son:

F1 (Helsinki)

ABCDE

F2 (Brussels)

ABCDE

F3 (Bermuda)

ABCDE

TITLE F1 (San Diego)

ABCDE

TITLE F2 (Calgary)

ABCDE

TITLE F3 (Florida)

ABCDE

TITLE F4 (Istambul)

ABCDE

TITLE F5 (US)

ABCDE

El ajuste por defecto es el juego tipográfico F1.

 Los juegos tipográficos *TITLE* solamente estarán disponibles si el mensaje consta de una sola línea o si está instalada una cinta de ½" (12 mm), ¾" (18 mm), o de 1" (24 mm). Además, las letras introducidas utilizando un juego tipográfico *TITLE* solamente aparecerán en mayúsculas.

PARA INTRODUCIR TEXTO CON UN JUEGO TIPOGRÁFICO DIFERENTE:

- (1) Inserte el cursor donde desee comenzar a utilizar un nuevo juego tipográfico.
- (2) Presione la tecla **FONT** hasta que se visualice el carácter de ejemplo del juego tipográfico que desee utilizar, y tal juego tipográfico se mostrará con los indicadores situados sobre el visualizador de cristal líquido.
- (3) Introduzca el texto al que desee aplicar el juego tipográfico que haya elegido.

PARA APLICAR UN JUEGO TIPOGRÁFICO AL ÁREA SELECCIONADA:

- (1) Presione la tecla **AREA**, y después utilice las teclas del cursor para seleccionar el texto al que desee aplicar el juego tipográfico que haya elegido.
- (2) Presione la tecla **FONT** hasta que se visualice el texto en el juego tipográfico que desee utilizar, y tal juego tipográfico se mostrará con los indicadores situados sobre el visualizador de cristal líquido.
- (3) Presione la tecla **RETURN** para aplicar el juego tipográfico elegido el texto introducido.

TAMAÑO/ANCHURA

Existen dos ajustes de tamaño de caracteres: tamaño y anchura. Normalmente, usted deseará utilizar caracteres lo más grandes posible para la cinta y el mensaje dados. Con el tamaño ajustado a AUTO, la máquina comparará su mensaje introducido con el tamaño de la cinta y utilizará automáticamente caracteres lo más grandes posible. Sin embargo, algunas veces, usted deseará asignar un tamaño y una anchura de caracteres particulares. Para ello, están disponibles seis tamaños en puntos y cada uno podrá imprimirse en caracteres estrechos, medianos, o anchos. Los tamaños disponibles son:

Ancho de la cinta	Tamaño (punto)
1" (24 mm)	6, 10, 13, 19, 26, 38
3/4" (18 mm)	6, 10, 13, 19, 26, 38
1/2" (12 mm)	6, 10, 13, 19
3/8" (9 mm)	6, 10, 13, 19
1/4" (6 mm)	6, 10, 13

6, 10, 13, 19, 26, y 38 puntos (todos están disponibles en las anchuras siguientes: mediana, estrecha, y ancha) AUTO (se elegirá automáticamente el tamaño de caracteres más grande posible.)

El tamaño por defecto es AUTO, y la anchura por defecto es mediana.

 Cuando esté activado el parámetro de impresión dividida en el modo de impresión especial, el mensaje se imprimirá con caracteres de tamaño mayor.

PARA INTRODUCIR TEXTO CON TAMAÑO/ANCHURA DIFERENTE:

- (1) Inserte el cursor donde desee comenzar a utilizar un nuevo tamaño o anchura de caracteres.
- (2) Presione la tecla **SIZE** hasta que se visualice el carácter de ejemplo del tamaño que desee utilizar y presione la tecla **WIDTH** hasta que se visualice la anchura deseada.
- (3) Introduzca el texto al que desee aplicar el tamaño o la anchura que haya elegido.

PARA APLICAR UN TAMAÑO/ANCHURA AL ÁREA SELECCIONADA:

- (1) Presione la tecla **AREA**, y después utilice las teclas del cursor para seleccionar el texto al que desee aplicar el tamaño o la anchura que haya elegido.
- (2) Presione la tecla **SIZE** hasta que se visualice el texto en el tamaño de caracteres que desee utilizar, y presione la tecla **WIDTH** hasta que se visualice el texto en la anchura de caracteres que desee utilizar.
- (3) Presione la tecla **RETURN** para aplicar el tamaño o la anchura de caracteres que haya seleccionado elegido al texto introducido.

ESTILO/CURSIVA

Existen seis estilos únicos, que pueden combinarse todos con el estilo letra cursiva. Los estilos son:

Normal (Sin indicación):	ABCDE	Italic & Normal (A):	<i>ABCDE</i>
Bold (A):	ABCDE	Italic & Bold: (A + A)	<i>ABCDE</i>
Outline (A):	ABCDE	Italic & Outline (A + A):	<i>ABCDE</i>
Solid (A):	ABCDE	Italic & Solid (A + A):	<i>ABCDE</i>
Shadow (A):	ABCDE	Italic & Shadow (A + A):	<i>ABCDE</i>
Outline + Shadow (A):	ABCDE	Italic & Outline + Shadow (A + A):	<i>ABCDE</i>
Franjas:	ABCDE	Cursiva y franjas:	<i>ABCDE</i>
	ABCDE		<i>ABCDE</i>

El ajuste por defecto es el estilo normal. (No aparecerá ningún indicador en el visulizador.)

☞ *Los caracteres impresos utilizando los tamaños más pequeños pueden ser difíciles de leer si aplica ciertos (p. ej., Cursiva y Perfilado + Sombreado).*

PARA INTRODUCIR TEXTO CON UN ESTILO/CURSIVA DIFERENTE:

- (1) Inserte el cursor donde desee comenzar a utilizar un nuevo estilo de caracteres.
- (2) Presione la tecla **STYLE** hasta que se visualice el carácter de ejemplo del estilo de caracteres que desee utilizar, y tal estilo de caracteres se mostrará con los indicadores situados debajo del visualizador de cristal líquido.
- (3) Introduzca el texto al que desee aplicar el estilo que haya elegido.

PARA APLICAR UN ESTILO/CURSIVA AL ÁREA SELECCIONADA:

- (1) Presione la tecla **AREA**, y después utilice las teclas del cursor para seleccionar el texto al que desee aplicar el estilo de caracteres que haya elegido.
- (2) Presione la tecla **STYLE** hasta que se visualice el texto en el estilo que desee utilizar, y tal estilo de caracteres se mostrará con los indicadores situados debajo del visualizador de cristal líquido.
- (3) Presione la tecla **RETURN** para aplicar el estilo elegido el texto introducido.

SUBRAYADO/ENCUADRE

Los caracteres seleccionados de su mensaje podrán resaltarse enciadrándolos con un recuadro, con un recuadro redondeado, subrayándolos, techándolos o poniéndolos delante de un patrón sombreado. Los tipos de resulte son:

Box (recuadro)



Strike-out (tachado)



Enrejado dia-
mante



Reticulado



Rounded Box
(redondeo)



Puntos



Recuadros peque-
ños



Franjas



Underline
(subrayado)



Rejilla cuadrada



Bloques



Cubos



El ajuste por defecto es ausencia de subrayado y de encuadre.

 Cuando elimine todo el mensaje de texto del xvisualizador con la tecla **CLEAR**, este formato volverá a su ajuste por defecto (sin subrayado y sin encuadre).

PARA INTRODUCIR TEXTO CON SUBRAYADO/ENCUADRE:

- (1) Inserte el cursor donde desee comenzar a utilizar un nuevo encuadre.
- (2) Presione la tecla **UNDL/FRM** hasta que se visualice el carácter de ejemplo con el encuadre desee utilizar.
- (3) Introduzca el texto al que desee aplicar el encuadre que haya elegido.

PARA APLICAR SUBRAYADO/ENCUADRE AL ÁREA SELECCIONADA:

- (1) Presione la tecla **AREA**, y después utilice las tecla del cursor para seleccionar el texto al que desee aplicar el subrayado que haya elegido.
- (2) Presione la tecla **UNDL/FRM** hasta que se visualice el carácter de ejemplo con el encuadre que desee utilizar.
- (3) Presione la tecla **RETURN** para aplicar el encuadre elegido al texto introducido.

IMPRESIÓN DE COLORES MÚLTIPLES

Con la función de impresión en colores múltiples, podrá imprimir etiquetas usando hasta tres tintas de colores distintos. La función es útil cuando parte de su mensaje debe resaltar o cuando se requieren etiquetas de codificación por colores.

El color de ajuste por defecto es el COLOR 1.

☞ *Cuando se almacena un mensaje en la memoria, el orden en el que se imprimen los caracteres también se almacenará.*

Los ajustes de impresión en color asignados durante esta función son los mismos ajustes usados con los ajustes de C.FRAME y C.CHAR del formato global.

PARA INTRODUCIR EL TEXTO QUE SE IMPRIMIRÁ CON UN COLOR DISTINTO:

- (1) Inserte el cursor en el lugar en el que desee empezar a usar un nuevo color.
- (2) Presione la tecla **COLOR** hasta que el ajuste de color que desee utilizar aparezca y el ajuste deseado se indica con los indicadores de encima del visualizador LCD.
- (3) Introduzca el texto al que deba aplicarse el color seleccionado.

PARA APLICAR AJUSTES DE COLOR A UN ÁREA SELECCIONADA:

- (1) Decida el color de cada parte de la etiqueta y el orden en el que deban imprimirse los colores.

☞ *Antes de imprimir la etiqueta, asegúrese de emplear la tecla **FORMAT** para seleccionar el color del encuadre o sombreado. (Consulte la página 27 para ver la información pertinente.)*

Las partes en blanco de los caracteres podrán imprimirse usando uno de los Tres tintas de colores. (Para la explicación detallada, consulte la página 28.)

- (2) Sitúe el cursor delante del primer carácter que desee imprimir usando la tinta del segundo color y presione la tecla **AREA**. El primer carácter se resaltará.

☞ *Todos los caracteres se imprimirán automáticamente usando la tinta del primer color, a menos que se les haya asignado un número de color distinto.*

- (3) Emplee las teclas del cursor para resaltar la serie de caracteres que desee imprimir usando el segundo color.
- (4) Presione la tecla **COLOR**, situada debajo del visualizador de LCD, hasta que se visualice COLOR2 y se encienda el indicador C2, y presione entonces la tecla **RETURN**. Estos caracteres se imprimirán usando la tinta del segundo color.

- (5) Repita los pasos (2) y (3) para resaltar la serie de caracteres que desee imprimir usando el tercer color.
- (6) Presione la tecla **COLOR** hasta que se visualice COLOR3 y se encienda el indicador C3, y presione entonces la tecla **RETURN**. Estos caracteres se imprimirán usando la tinta del tercer color.

 *Los indicadores C2 y C3 muestran el color que ha sido asignado al carácter que está a la izquierda del cursor. Si no hay ningún indicador encendido, significa que se ha asignado el primer color.*
- (7) Siga asignando colores hasta que todos los ajustes de los caracteres sean como usted desea, y presione entonces la tecla **PRINT**. Aparecerá el ajuste de impresión en colores múltiples (COLOR PRINT).

 *Antes de la impresión, asegúrese de que haya espacio suficiente en el cassette de cinta y que el final de la cinta esté alineado con el borde de cassette.*
- (8) Presione las teclas **▲** y **▼** para activar el modo de impresión en colores múltiples, y presione entonces la tecla **RETURN**. Se visualizará el mensaje "INSERT COLOR1".
- (9) Si los cassettes de tinta impresión en colores múltiples y de cinta no están instalados, abra la cubierta del compartimiento de la cinta y saque el cassette de la cinta. Inserte primero el cassette de cinta en un cassette de cinta, e insértelos después firmemente en el compartimiento antes de cerrar la cubierta del compartimiento.
- (10) Presione la tecla **RETURN**. El mensaje "WORKING" parpadeará brevemente y aparecerá "COPIES COLOR1" mientras se imprimen los caracteres a los que se haya asignado la tinta del primer color. Cuando termine la impresión, se visualizará el mensaje "REMOVE INK RIBBON".
- (11) Abra la cubierta del compartimiento, y extraiga el cassette de la primera tinta y presione la tecla **RETURN**. Aparecerá el mensaje "REWINDING THE TAPE" mientras se rebobina la cinta. Después de haberse rebobinado la cinta, se visualizará el mensaje "INSERT COLOR2".

 *Espere a que la cinta haya terminado de rebobinarse antes de insertar el siguiente cassette de tinta.*
- (12) Inserte el cassette de la segunda tinta, cierre la cubierta y presione la tecla **RETURN**. El mensaje "WORKING" parpadeará brevemente y aparecerá "COPIES COLOR2" mientras se imprimen los caracteres a los que se haya asignado la tinta del segundo color. Cuando termine la impresión, se visualizará el mensaje "REMOVE INK RIBBON".
- (13) Abra la cubierta del compartimiento, y extraiga el cassette de la segunda tinta y presione la tecla **RETURN**. Aparecerá el mensaje "REWINDING THE TAPE" mientras se rebobina la cinta. Después de haberse rebobinado la cinta, se visualizará el mensaje "INSERT COLOR3".
- (14) Inserte el cassette de la tercera tinta, cierre la cubierta y presione la tecla **RETURN**. El mensaje "WORKING" parpadeará brevemente y aparecerá "COPIES COLOR3" mientras los caracteres a los que se haya asignado la tinta del tercer color.
- (15) Presione la palanca del cortador de la cinta para cortar la etiqueta, y córtela a lo largo de los puntos impresos para conseguir márgenes iguales.

ENCUADRE

Usted podrá crear etiquetas exclusivas encuadrando todo su mensaje utilizando uno de los muchos encuadres disponibles. Los tipos de encuadres son:

Recuadro



Recuadro redondeado

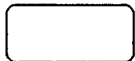

Puntos



Rejilla cuadrada

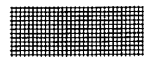

Enrejado diamante



Recuadros pequeños Ventas



Bloques



Reticulado

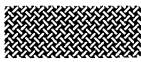

Franjas

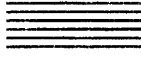

Cubos

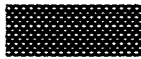

Dedo señalador

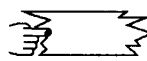

Etiqueta de nombre

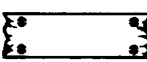

Perro

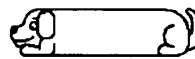

Película



Dinosaurio

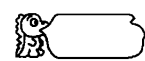

Teléfono

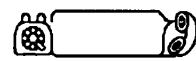

Manos

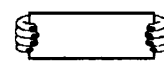

Ventanilla

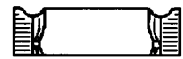

Pendón

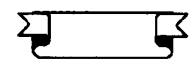

 Este ajuste de encuadre solamente podrá aplicarse a toda la etiqueta. No podrá aplicarse solamente a una parte de texto. Sin embargo, un recuadro, recuadro redondeado o de sombreado puede aplicarse localmente utilizando las teclas **AREA** y las del cursor para seleccionar el texto, y después pulsando la tecla **UNDL/FRM** hasta que se visualice el resalte que desee utilizar.

PARA SELECCIONAR EL ESTILO DE ENCUADRE:

- (1) Pulse la tecla **FORMAT**.
- (2) Pulse las teclas **→** y **←** hasta que se realce el ajuste de encuadre (FRAME).
- (3) Pulse las teclas **↑** y **↓** hasta que se visualice el encuadre que desee utilizar.
 El ajuste por defecto (OFF) podrá seleccionarse pulsando la tecla **SPACE**.
- (4) Pulse la tecla **RETURN**.

AVANCE DE CINTA

Esta máquina podrá ajustarse para que deje márgenes iguales o entre 1/6" (4 mm) y 1" (24 mm) a los lados izquierdo y derecho de su etiqueta. Los ajustes de avance de cinta son:

FULL 1"(24 mm)

NONE 1/6"(4 mm)

NARROW 1/3"(8 mm)

MEDIUM 1/2"(12 mm)

 Como la reducción del avance de la cinta puede disminuir la legibilidad del código de barras, se recomienda el avance completo de la cinta cuando los mensajes incluyan códigos de barras. Si ha instalado cinta instantánea (adhesión por frotado), este ajuste se ignorará, y el mensaje se imprimirá con los márgenes completos.

*El ajuste de avance de la cinta sólo podrá aplicarse a toda la etiqueta.
No puede aplicarse sólo a parte del texto.*

PARA SELECCIONAR UNA ANCHURA DE MARGEN:

- (1) Pulse la tecla **FORMAT**.
- (2) Pulse las teclas **▶** y **◀** hasta que se realce el ajuste de avance de cintas (FEED).
- (3) Pulse las teclas **▲** y **▼** hasta que se visualice la anchura de margen que desee utilizar.

 El ajuste por defecto (FULL) podrá seleccionarse pulsando la tecla **SPACE**.

- (4) Pulse la tecla **RETURN**.

IMPRESIÓN VERTICAL

Los caracteres de su mensaje pueden imprimirse con orientación vertical.

 *La impresión vertical no podrá utilizarse cuando se esté usando un juego de caracteres TITLE.*

La impresión vertical solamente podrá aplicarse a toda la etiqueta. No podrá utilizarse en una parte solamente del texto.

PARA AJUSTAR LA FUNCIÓN DE IMPRESIÓN VERTICAL:

- (1) Pulse la tecla **FORMAT**.
 - (2) Pulse las teclas **▶** y **◀** hasta que se realce el ajuste de impresión vertical (VERT).
 - (3) Pulse las teclas **▲** y **▼** hasta que se visualice el ajuste que desee utilizar.
-  *El ajuste por defecto (OFF) podrá seleccionarse pulsando la tecla **SPACE**.*
- (4) Pulse la tecla **RETURN**.

IMPRESIÓN DE ESPEJO

Su mensaje podrá imprimirse como si estuviese viéndose a través de un espejo. Cuando tales etiquetas (impresas en cinta transparente) se peguen en un cristal, como escaparates, podrán leerse correctamente desde el lado opuesto.

 *Para hacer una etiqueta, utilice la impresión de espejo con cinta clara.*

La impresión vertical solamente podrá aplicarse a toda la etiqueta. No podrá utilizarse en una parte solamente del texto.

PARA AJUSTAR LA FUNCIÓN DE IMPRESIÓN DE ESPEJO:

- (1) Pulse la tecla **FORMAT**.
 - (2) Pulse las teclas **▶** y **◀** hasta que se realce el ajuste de impresión de espejo (MIRROR).
 - (3) Pulse las teclas **▲** y **▼** hasta que se visualice el ajuste que desee utilizar.
-  *El ajuste por defecto (OFF) podrá seleccionarse pulsando la tecla **SPACE**.*
- (4) Pulse la tecla **RETURN**.

ALINEACIÓN HORIZONTAL

Los caracteres de los bloques de su mensaje podrán alinearse horizontalmente en cualquiera de las cuatro formas siguientes:

LEFT (Izquierda)
CENTER (Centro)
RIGHT (Derecha)
JUSTIFY (Justificación)

 *La alineación horizontal solamente podrá aplicarse a toda la etiqueta. No podrá utilizarse en una parte solamente del texto.*

Si había ajustado una longitud de cinta, los mensajes de bloques múltiples se asignarán al ajuste JUSTIFY, y los espacios entre los bloques se ajustarán de forma que el texto se esparza uniformemente a lo largo de la cinta.

PARA SELECCIONAR UNA ALINEACIÓN HORIZONTAL:

- (1) Pulse la tecla **FORMAT**.
 - (2) Pulse las teclas **▶** y **◀** hasta que se realce el ajuste de alineación horizontal (H.ALI).
 - (3) Pulse las teclas **▲** y **▼** hasta que se visualice el ajuste que desee utilizar.
-  *El ajuste por defecto (LEFT) podrá seleccionarse pulsando la tecla **SPACE**.*
- (4) Pulse la tecla **RETURN**.

ALINEACIÓN VERTICAL

Los bloques de su mensaje podrán alinearse verticalmente en cualquiera de las tres formas siguientes:

BOTTOM (Inferior)
CENTER (Centro)
TOP (Superior)

 *La alineación vertical solamente podrá aplicarse a toda la etiqueta. No podrá utilizarse en una parte solamente del texto.*

PARA SELECCIONAR UNA ALINEACIÓN VERTICAL:

- (1) Pulse la tecla **FORMAT**.
 - (2) Pulse las teclas **▶** y **◀** hasta que se realce el ajuste de alineación vertical (V.ALI).
 - (3) Pulse las teclas **▲** y **▼** hasta que se visualice el ajuste que desee utilizar.
-  *El ajuste por defecto (BOTTOM) podrá seleccionarse pulsando la tecla **SPACE**.*
- (4) Pulse la tecla **RETURN**.

LONGITUD

La longitud de la etiqueta podrá ajustarse utilizando dos métodos diferentes. Con le tamaño en AUTO, la máquina comparará el menaje introducido con el tamaño de la cinta y ajustará automáticamente la longitud de la etiqueta para que quepa su menaje. Sin embargo, algunas veces usted puede desear asignar una longitud de etiqueta específica independientemente del tamaño del mensaje. La longitud de la etiqueta podrá ajustarse de 1,5" (3,8 cm) a 11,3" (28,7 cm). Las longitudes de etiquetas son:

En pulgadas: AUTO 1,5 1,6 ...11,3 AUTO ...

En centímetros: AUTO 3,8 3,9 ...28,7 AUTO ...

 *El ajuste de longitud solamente podrá aplicarse a toda la etiqueta. No podrá utilizarse en una parte solamente del texto.*

Cuando haya seleccionado un ajuste que no sea AUTO para el tamaño, si el texto no cabe dentro de la longitud especificada, se visualizará el mensaje "TOO LONG".

PARA SELECCIONAR UNA LONGITUD DE CINTA:

- (1) Pulse la tecla **FORMAT**.
 - (2) Pulse las teclas **▶** y **◀** hasta que se realce el ajuste de longitud de cinta (LENGTH).
 - (3) Pulse las teclas **▲** y **▼** hasta que se visualice el ajuste que desee utilizar. Al pulsar una vez estas teclas, la longitud aumentará 0,1" (0,1 cm). Si mantiene presionadas estas teclas, la longitud aumentará en pasos de 1" (1 cm) hasta que las suelte.
-  *El ajuste por defecto (AUTO) podrá seleccionarse pulsando la tecla **SPACE**.*
- (4) Pulse la tecla **RETURN**.

UNIDADES DE VISUALIZACIÓN

Las medidas mostradas en el visualizador son en pulgadas (inch) o centímetros (cm).

 *El ajuste de longitud solamente podrá aplicarse globalmente. No es posible el formato local.*

PARA SELECCIONAR UNA LONGITUD DE CINTA:

- (1) Pulse la tecla **FORMAT**.
 - (2) Pulse las teclas **▶** y **◀** hasta que se realce el ajuste de unidades (UNIT).
 - (3) Pulse las teclas **▲** y **▼** hasta que se visualice el ajuste que desee utilizar.
-  *El ajuste por defecto (INCH) podrá seleccionarse pulsando la tecla **SPACE**.*
- (4) Pulse la tecla **RETURN**.

ENCUADRES/SOMBREADOS COLOREADOS

El encuadre o sombreado de la etiqueta podrá asignarse en una de las tres tintas de colores usadas durante la impresión en colores múltiples.

COLOR1 COLOR2 COLOR3

 Antes de imprimir la etiqueta, asegúrese de que haya cinta suficiente en el cassette y que se haya seleccionado el ajuste para la función C. FRAME. Los ajustes de impresión en color asignados usando esta función son los mismos ajustes usados en la impresión de colores múltiples y con la función C. CHAR.

El ajuste de C. FRAME sólo podrá aplicarse a toda la etiqueta. No podrá aplicarse sólo a parte del texto. Si no se ha añadido un encuadre o sombreado a la etiqueta, este ajuste se ignorará durante la impresión.

PARA AJUSTAR LA FUNCIÓN DE ENCUADRE/SOMBREADO COLOREADO:

- (1) Pulse la tecla **FORMAT**.
- (2) Pulse las teclas **▶** y **◀** hasta que se realce el ajuste de encuadre/sombreado coloreado (C. FRAME).
- (3) Pulse las teclas **▲** y **▼** hasta que se visualice el color que desee utilizar.
 El ajuste por defecto (COLOR1) puede seleccionarse presionando la tecla **SPACE**.
- (4) Pulse la tecla **RETURN**.

CARACTERES COLOREADOS

Cuando se impriman etiquetas de colores múltiples con estilos de caracteres tales como perfilado, sólido o sombreado, los resaltes de los caracteres podrán rellenarse usando una tinta de un color que sea distinto al asignado para el carácter.

OFF COLOR1 COLOR2 COLOR3

 *Antes de imprimir la etiqueta, asegúrese de que haya cinta suficiente en el cassette y que se haya seleccionado el ajuste para la función C. CHAR. Los ajustes de impresión en color asignados usando esta función son los mismos ajustes usados en la impresión de colores múltiples y con la función C. FRAME.*

El ajuste de C. CHAR sólo podrá aplicarse a toda la etiqueta. No podrá aplicarse sólo a parte del texto. Si en esta etiqueta sólo se usan estilos de caracteres normales y de negrilla, este ajuste se ignorará durante la impresión.

PARA AJUSTAR LA FUNCIÓN DE CARACTER COLOREADO:

- (1) Presione la tecla **FORMAT**.
- (2) Presione las teclas **▶** y **◀** hasta que se realce el ajuste de carácter coloreado (C.CHAR).
- (3) Presione las teclas **▲** y **▼** hasta que se visualice el color que desee utilizar.
 *El ajuste por defecto (OFF) podrá seleccionarse presionando la tecla **SPACE**.*
- (4) Presione la tecla **RETURN**.

ALMACENAMIENTO/INVOCACIÓN/BORRADO DE LA MEMORIA

La memoria de la máquina podrá utilizarse para almacenar e invocar los mensajes de texto más frecuentemente utilizados. Estos mensajes permanecerán en la memoria, incluso aunque borre el área de trabajo manteniendo presionada el tecla **CODE** y pulsando la tecla **CLEAR**.

Cuando almacene, a cada archivo se le asignará un número para facilitar su invocación. Los números de archivo son entre 0 y 99. La memoria de esta máquina puede almacenar hasta 3.400 caracteres. Si la memoria se llena, los siguientes intentos de almacenamiento causarán la visualización del mensaje "MEMORY FULL!". En este caso, usted tendrá que borrar un archivo de texto existente antes de poder almacenar otro nuevo.

Cuando invoque un archivo de texto almacenado, una copia del mismo se colocará en el área de trabajo y podrá editar, reformatizar, o imprimirse. Como se utiliza una copia, el archivo original no desaparecerá de la memoria, por lo que usted podrá invocar el mismo archivo las veces que desee sin que se altere. Cuando invoque un archivo, si hay texto en el área de trabajo, tendrá que elegir entre reemplazar tal texto por el del archivo almacenado o enlazar los dos.

Cuando ya no necesite un archivo, podrá borrarlo de memoria utilizando la función M. DEL. Esta función también podrá utilizarse para hacer espacio en la memoria cuando ésta se haya llenado.

PARA ALMACENAR UN ARCHIVO DE TEXTO EN LA MEMORIA:

- (1) Mantenga presionada la tecla **CODE** y pulse la tecla **STORE**.
- (2) Pulse las teclas **▶** y **◀** para elegir un número entre 0 y 99.
- (3) Pulse las teclas **RETURN**. El archivo se almacenará y podrá invocarse en cualquier momento.

 *Si ya hay un archivo almacenado en el número seleccionado, la máquina le preguntará si reescribir el mensaje anterior con el nuevo.*

Para reemplazar el archivo almacenado por el nuevo texto:

- (4) Pulse la tecla **RETURN**. El nuevo archivo se almacenará en el número seleccionado, y el archivo anteriormente almacenado se borrará.

 *Para abandonar el modo STORE sin almacenar su mensaje, pulse la tecla **CANSEL** o las teclas **CODE** y **STORE** al mismo tiempo.*

PARA INVOCAR UN ARCHIVO DE LA MEMORIA:

- (1) Mantenga presionada la tecla **CODE** y pulse la tecla **RECALL**. Se visualizarán el número y primeros caracteres del último archivo almacenado.
- (2) Pulse las teclas **▲** y **▼** hasta que se visualice el archivo que desee invocar.
- (3) Pulse la tecla **RETURN**.

- ☞ *Si no hay texto en el área de trabajo, el archivo se invocará. Si hay cierto texto en el área de trabajo, la máquina le preguntará si desea enlazar o reescribir el texto con el del archivo invocado.*

Para reemplazar el texto del área de trabajo por el del archivo invocado:

- (4) Pulse las teclas **▲** y **▼** hasta que en el área de selección JOIN se visualice OFF.
- (5) Pulse la tecla **RETURN**. El archivo de texto almacenado se invocará y reescribirá sobre el mensaje del área de trabajo.

- ☞ *Si elige enlazar el archivo y el texto del área de trabajo, el archivo invocado se insertará en la posición del cursor en el área de trabajo.
Para abandonar el modo RECALL sin realizar ninguna acción, pulse la tecla **CANSEL** o las teclas **CODE** y **RECALL** mismo tiempo.*

PARA BORRAR UN ARCHIVO DE LA MEMORIA:

- (1) Mantenga presionada la tecla **CODE** y pulse la tecla **M.DEL**.
- (2) Pulse las teclas **▶** y **◀** hasta que se visualice el archivo que desea borrar.
 - ☞ *Mantenga presionada la tecla **CODE** y pulse la tecla **SPACE** para seleccionar todos los archivos de la memoria. Si después decide no borrar ninguno de los archivos de la memoria, mantenga presionada la tecla **CODE** y pulse la tecla **CLEAR**.*
- (3) Pulse las teclas **RETURN**. Se visualizará el mensaje "OK TO DELETE?" o "CLEAR ALL?".
- (4) Para confirmar, vuelva a pulsar la tecla **RETURN**. El archivo, o los archivos, seleccionado(s) se borrará(n).
 - ☞ *Para abandonar el modo M.DEL sin borrar el (los) archivo(s) seleccionado(s), pulse la tecla **CANSEL** o las teclas **CODE** y **M.DEL** al mismo tiempo.*

IMPRESIÓN E IMPRESIÓN ESPECIAL

La tecla **PRINT** le permitirá imprimir su texto en la cinta instalada. La tecla **SPECIAL PRINT** le permitirá indicar el número de copias de la etiqueta que desea imprimir, decidir si la máquina realizará una pausa o no entre copias a fin de cortar la cinta, y activar/desactivar la función de impresión dividida.

PARÁMETRO	AJUSTES
COPIES (Copias) _____	1 a 99
PAUSE (Pausa para cortar la cinta) _	ON, OFF
SPLIT (Impresión dividida) _____	OFF, ON

COPIES – Este parámetro determina cuántas copias de la etiqueta actual se imprimen.

PAUSE – Este parámetro determina si la máquina se para entre copias para poder cortar la cinta.

☞ *El margen izquierdo de la primera etiqueta será de 1" (24 mm) si este parámetro está ajustado a OFF.*

SPLIT PRINTING – Este parámetro determina si la etiqueta se divide a lo largo y se imprime como dos etiquetas.

☞ *Estos tres parámetros especiales de impresión no pueden usarse con la función de impresión en colores múltiples.*

PARA IMPRIMIR UNA ETIQUETA:

Pulse la tecla **PRINT**. El texto se imprimirá una vez.

☞ *Si pulsa la tecla **PRINT** en el modo **AUTO FORMAT** y el cassette de cinta instalado no sea del tamaño correcto para la etiqueta que desea imprimir, aparecerá un mensaje para indicarle qué cinta deberá instalar.*

*Pulse la tecla **FEED** para hacer que la cinta avance 1" (24 mm).*

PARA IMPRIMIR UNA ETIQUETA UTILIZANDO UN PARÁMETRO DE IMPRESIÓN ESPECIAL:

(1) Mantenga presionada la tecla **CODE** y pulse la tecla **SPECIAL PRINT**.

Si los ajustes por defecto son satisfactorios, presione la tecla **RETURN**. (Consulte la página 29 para ver los ajustes de impresión por defecto.)

Para cambiar los ajustes de impresión especial:

(2) Pulse las teclas **▶** y **◀** hasta que se realce el primer ajuste que desee cambiar.

- (3) Pulse las teclas **▲** y **▼** hasta que se visualice el ajuste deseado. Cuando esté ajustando el parámetro **COPIES** y presione una vez estas teclas, el ajuste cambiará a 1. Sin embargo, si mantiene presionada cualquiera de estas teclas, el ajuste continuará cambiando en pasos de 5 hasta que la suelte.
-  *El ajuste por defecto del parámetro realzado podrá seleccionarse pulsando la tecla **SPACE**, o todos los ajustes podrán devolverse a sus ajustes por defecto manteniendo presionada la tecla **CODE** y pulsando la tecla **SPACE**.*
- (4) Repita los pasos (2) y (3) hasta que se visualicen los ajustes deseados.
- (5) Pulse la tecla **RETURN**. Las etiquetas se imprimirán utilizando los parámetros de impresión que haya ajustado.

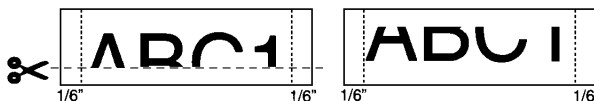

Si el parámetro **SPLIT** está ajustado a **ON**, las etiquetas como las mostradas arriba se imprimirán. Para colocarlas juntas de forma que no se dividan los caracteres, corte el espacio en blanco de la parte inferior de la etiqueta superior, y la parte superior de la etiqueta inferior.



-  *Cuando el parámetro **SPLIT** esté activado, solamente se imprimirá una copia completa de la etiqueta, independientemente del ajuste del parámetro de copias.*

MARCADO CON SELLO

Este modo le permite hacer sellos de forma rápida y fácil para cualquier aplicación. Después de imprimir el sello, coloque la cinta cortada a un portasellos para poderlo emplear con frecuencia. Puesto que el portasello es reutilizable, podrá hacer un sello nuevo y cambiarlo por otro que haya en el portasellos.

PARA HACER UN SELLO:

- (1) Escriba el texto, abra la cubierta del compartimiento de la cinta, inserte un cassette de sello, y cierre la cubierta.
- (2) Mantenga presionada la tecla **CODE** y presione la tecla **STAMP**. Se visualizará el mensaje "STAMP FORMAT".
- (3) Presione la tecla **RETURN** para introducir el modo de sello. El texto se centrará dentro del área de mensaje preajustada y la longitud y márgenes de la cinta se ajustarán automáticamente.
- (4) Presione la tecla **PRINT**. El texto se cortará de la cinta de sello instalada.
- (5) Presione la palanca del cortador de cinta, extraiga el papel del dorso de la cinta del sello y fíjelo en la almohadilla de un portasellos.

 *Si se reutiliza un portasellos, pele la cinta vieja antes de fijar la nueva.*

CÓDIGOS DE BARRAS

La función de código de barras, que permite imprimir códigos de barras como parte de etiquetas, es una de las características más avanzadas de esta máquina.

 En esta sección se explica cómo introducir un código de barras en su mensaje de texto. No se pretende ofrecer una introducción al concepto de codificación con barras. Para más información, consulte uno de los muchos libros de referencia existentes.

Como esta máquina no ha sido específicamente diseñada para hacer etiquetas especiales de códigos de barras, es posible que algunos lectores de códigos de leer las etiquetas.

Para las etiquetas que contengan códigos de barras, utilice una cinta con caracteres negros en cinta adhesiva blanca.

En el modo BAR CODE, podrá ajustar seis parámetros diferentes, lo que le permitirá crear códigos de barras personales.

PARÁMETRO	AJUSTES
PROTOCOL (Protocolo) _____	CODE 39, 1-2/5, EAN 13, EAN8, UPC-A, UPC-E, CODABAR, EAN128, CODE 128, ISBN5, ISBN2, LASERB
WIDTH (Anchura de código de barras) _____	MEDIUM, SMALL, LARGE
UNDER#S (Números impresos debajo del código de barras) _____	ON, OFF
CHARS (Número de caracteres del código) _____	AUTO, 4 a 22
RATIO (Relación) _____	3:1, 2,5:1, 2:1
CH. DIG (Dígito de comprobación) _____	OFF, ON

Recomendamos imprimir códigos de barras utilizando la anchura MEDIUM o LARGE y el avance de la cinta FULL.

Cuando reduzca el avance de la cinta, o utilice la anchura de código de barras SMALL, el código de barras puede ser difícil de leer.

PARA INTRODUCIR UN CÓDIGO DE BARRAS EN SU MENSAJE:

- (1) Mantenga presionada la tecla **CODE** y pulse la tecla **BAR CODE**. Si el cursor se encuentra en un código de barras ya introducido, se visualizaràn los ajustes del código de barras actual.
- (2) Introduzca los datos del código de barras. Si desea editar un código de barras existente, introduzca los nuevos datos.

Para editar ajustas de códigos de barras:

- (3) Pulse la tecla **FORMAT**.
- (4) Pulse las teclas **▶** y **◀** hasta que se realce el ajuste que desee cambiar.
- (5) Pulse las teclas **▲** y **▼** hasta que se visualice el ajuste deseado.
- (6) Repita los pasos (4) y (5) hasta que haya cambiado todos los ajustes deseados.
- (7) Pulse la tecla **RETURN**.
- (8) Mantenga presionada la tecla **CODE** y pulse la tecla **SYMBOL**, después presione las teclas **▲** y **▼** hasta que aparezca el símbolo apropiado. Los símbolos solamente podrán introducirse utilizando los protocolos EAN 128 y CODE 128.

VALOR	CARÁCTER	VALOR	CARÁCTER	VALOR	CARÁCTER
3	#	71	BEL	89	EM
4	\$	72	BS	90	SUB
11	+	73	HT	91	ESC
28	<	74	LF	91	{
29	=	75	VT	92	FS
30	>	76	FF	92	
32	@	77	CR	93	GS
59	[78	SO	93	}
60	\	79	SI	94	RS
61]	80	DLE	94	~
63	_	81	DC1	95	US
64	NUL	82	DC2	95	DEL
65	SOH	83	DC3	96	FNC3
66	STX	84	DC4	97	FNC2
67	ETX	85	NAK	100	FNC4
68	EOT	86	SYN	102	FNC1
69	ENQ	87	ETB		

VALOR	CARÁCTER	VALOR	CARÁCTER	VALOR	CARÁCTER
70	ACK	88	CAN		

Lo símbolos siguientes solamente podrán introducirse utilizando protocolos CODE 39 o CODABAR.

VALOR	CARÁCTER
1	+
2	\$

(9) Cuando haya finalizado, pulse la tecla **RETURN**.

PARA DESIGNAR UN CÓDIGO DE BARRAS COMO CAMPO DE NUMERACIÓN:

- (1) Coloque el cursor inmediatamente antes de la marca de código de barras que desee seleccionar como campo de numeración.
- (2) Mantenga presionada la tecla **CODE**, y pulse la tecla **SEQ. NUMBERING**.
- (3) Pulse las teclas **▲** y **▼** hasta que aparezca el ajuste **NUMBER**.
- (4) Pulse la tecla **RETURN**. Se imprimirá el número especificado de etiquetas.

LISTA DE MENSAJE DE ERROR

MENSAJE DE ERROR	CAUSA	SOLUCIÓN
4 DIGIT MIN.	<ul style="list-style-type: none"> •En un código de barras habrá que introducir un mínimo de cuatro dígitos. Este mensaje aparecerá cuando haya introducido menos de cuatro dígitos. 	<ul style="list-style-type: none"> •Introduzca un mínimo de cuatro dígitos antes de pulsar tecla RETURN.
5 BARS LIMIT!	<ul style="list-style-type: none"> •Cada etiqueta no podrá contener más de cinco códigos de barras. Este mensaje aparecerá si ya existen cinco códigos de barras y pulsa la tecla BAR-CODE, o cuando intente enlazar un archivo de texto invocado de la memoria con el mensaje actual, haciendo que el número de códigos de barras sobrepase el límite. 	<ul style="list-style-type: none"> •Limite el número de códigos de barras del mensaje de texto a cinco.
5 LINE LIMIT!	<ul style="list-style-type: none"> •Cada bloque de texto de una etiqueta no podrá contener más de cinco líneas. Este mensaje aparecerá si ya existen cinco líneas y pulsa la tecla RETURN, o si intenta enlazar un archivo de texto invocado de la memoria en el mensaje actual, haciendo que el bloque sobrepase el límite de cinco líneas. •Este mensaje aparecerá si el cursor está al comienzo de un bloque cuando pulse la tecla BACKSPACE para enlazar dos bloques, y resulta bloque que contiene un total de más de cinco líneas. 	<ul style="list-style-type: none"> •Limite el número de líneas del bloque actual a cinco y pulse la tecla NEW BLOCK. •Ajuste el número total de líneas de los dos bloques de forma que no sumen más de cinco líneas después de haberse enlazado, o no trate de enlazar dos bloques.
5 BLOCK LIMIT!	<ul style="list-style-type: none"> •Cada etiqueta no podrá contener más de cinco bloques. Este mensaje aparecerá si ya existen cinco bloques y pulsa la tecla NEW BLOCK, o si intenta enlazar un archivo de texto invocado de la memoria con el mensaje actual, haciendo que el mensaje sobrepase el límite de cinco bloques. 	<ul style="list-style-type: none"> •Limite el número de bloques del mensaje de texto cinco.

MENSAJE DE ERROR	CAUSA	SOLUCIÓN
BATTERIES WEAK	<ul style="list-style-type: none"> •Este mensaje aparecerá cuando las pilas alcalinas instaladas se debiliten. 	<ul style="list-style-type: none"> •Reemplace las pilas o utilice el adaptador de CA.
BUFFER EMPTY!	<ul style="list-style-type: none"> •Este mensaje aparecerá si pulsa la tecla LABEL LENGTH, AREA o SEQ. NUMBERING cuando la memoria intermedia del área de trabajo esté vacía. • Este mensaje aparecerá si trata de imprimir, pero no ha introducido texto en el área de trabajo. • Este mensaje aparecerá si trata de almacenar un mensaje como archivo de texto, pero no ha introducido texto en el área de trabajo. 	<ul style="list-style-type: none"> •Introduzca algún texto antes de entrar en el modo de longitud de la etiqueta, área, o numeración. •Introduzca texto antes de imprimir. •Introduzca texto antes de almacenar.
BUFFER FULL!	<ul style="list-style-type: none"> •Existe un límite en la cantidad de texto que puede introducirse en el área de trabajo. Este mensaje aparecerá si intenta introducir, una marca diacrítica, un retorno, un bloque nuevo, o un espacio cuando la memoria del área de trabajo esté llena. •Este mensaje aparecerá si se presiona una tecla de formato de texto (juego tipográfico, anchura de tamaño, estilo, subrayado y encuadre, o color) cuando el área de la memoria intermedia de trabajo ya esté llena. • Este mensaje aparecerá si pulsa la tecla RETURN en el modo de símbolos o de código barras cuando la memoria intermedia del área de trabajo esté llena. • Este mensaje aparecerá si trata de enlazar un archivo de texto invocado de la memoria cuando la memoria intermedia del área de trabajo esté llena. 	<ul style="list-style-type: none"> •Usted no podrá introducir texto adicional en este mensaje de texto. Borre algo del texto existente a fin de poder introducir más. •Pulse la tecla CANCEL y borre algo del texto antes de cambiar el formato del texto. •Pulse la tecla CANCEL y borre algo del texto antes de introducir un símbolo o un código de barra. •Pulse la tecla CANCEL y borre algo del texto antes de enlazar el archivo con el mensaje actual.

MENSAJE DE ERROR	CAUSA	SOLUCIÓN
CANCELED DATA! PRESS ANY KEY	<ul style="list-style-type: none"> • Este mensaje aparecerá si se presiona la tecla CANCEL mientras se están transmitiendo datos desde el ordenador a esta unidad en el modo de interfaz. 	<ul style="list-style-type: none"> • Presione cualquier tecla que no se CODE, SHIFT, ALT o CAPS, y vuélvalo a intentar.
CAN'T DELETE TAPE EDGE!	<ul style="list-style-type: none"> • Este mensaje aparecerá si no puede detectarse el fin de la cinta 	<ul style="list-style-type: none"> • Saque algo de exceso de cinta y sostenga el extremo de la cinta mientras gira el rollo de la cinta para tensarla en el cassette. • Alinee el extremo de la cinta con el borde del cassette, y entonces pruebe usar otra vez la función de impresión en colores múltiples. Presione las teclas CODE y ▼ para saltar los colores y volver al punto donde se paró la impresión.

CAN'T HERE

- Este mensaje aparecerá si introduce un carácter un símbolo, o

- Este mensaje

MENSAJE DE ERROR	CAUSA	SOLUCIÓN
CUT NOW	<ul style="list-style-type: none"> •Este mensaje aparecerá si después de haberse impreso una etiqueta con el modo de pausa de corte o en impresión de colores múltiples si el final de la cinta está incorrectamente situado. 	<ul style="list-style-type: none"> •Presione la palanca del cortador de la cinta para cortar la cinta.
EJECT CUT TAPE & PRESS RETURN	<ul style="list-style-type: none"> •Este mensaje aparecerá cuando se haya cortado la cinta, pero no se haya sacado. 	<ul style="list-style-type: none"> •Saque la cinta cortada sobrando y presione la tecla RETURN
ERROR!	<ul style="list-style-type: none"> •Este mensaje aparece si intenta imprimir en el modo de interfaz sin instalar el cassette de cinta correcto. 	<ul style="list-style-type: none"> •Presione cualquier tecla que no se CODE, SHIFT. ALT o CAPS, e instale entonces el cassette de cinta correcto.
ERROR! UL/FRM	<ul style="list-style-type: none"> •El número máximo de caracteres que podrán subrayar o encuadrarse es de 25. Este mensaje aparecerá si trata de subrayar o encuadrar más de 25 caracteres. 	<ul style="list-style-type: none"> •Reduzca el número de caracteres a subrayar o encuadrar.
FIXED SIZE!	<ul style="list-style-type: none"> •Este mensaje aparecerá si pulsa la tecla RETURN cuando haya seleccionado un juego tipográfico TITLE. •Este mensaje aparecerá si hay una cinta de 6 mm o de 9 mm de anchura cuando se introduce texto utilizando un juego tipográfico TITLE. •Este mensaje aparecerá si cambia el tamaño cuando haya seleccionado un juego tipográfico TITLE. 	<ul style="list-style-type: none"> •Cambie el juego tipográfico. •Inserte un cassette de cinta con anchura suficiente para que quepa el texto de juego tipográfico TITLE que desea imprimir. •Como el tamaño se fija, no lo cambie.
INPUT ABCD AT BEING & END	<ul style="list-style-type: none"> •Este mensaje aparecerá cuando se utilice el protocolo CODABAR en el modo de código de barras, pero no se haya introducido una letra entre A y D al comienzo ni al fin del código de barras. 	<ul style="list-style-type: none"> •Introduzca una letra entre A y D al comienzo y al final del código de barras.
INPUT WHOLE CODE	<ul style="list-style-type: none"> •En modo de código de barras, el número de dígitos requeridos para un código puede ajustarse a veces. Este mensaje aparecerá si el número ajustado de dígitos no se introdujo al introducir de barras. 	<ul style="list-style-type: none"> •Introduzca el número correcto de dígitos, cambie el número de dígitos ajustado en los parámetros del código de barras.

MENSAJE DE ERROR	CAUSA	SOLUCIÓN
INSTALL COLOR TAPE!	<ul style="list-style-type: none"> •Este mensaje aparecerá si no se ha instalado un cassette de colores múltiples de colores o durante la impresión en colores múltiples. 	<ul style="list-style-type: none"> •Instale una cinta de tinta de impresión en colores múltiples y un cassette de cinta.
INTERFACE ERROR!	<ul style="list-style-type: none"> •Este mensaje aparecerá si ocurre un error mientras se están transmitiendo datos desde el ordenador a esta unidad en el modo de interfaz. 	<ul style="list-style-type: none"> •Presione cualquier tecla que no se CODE, SHIFT, ALT o CAPS y vuélvalo a intentar.
INVAL. CHRS!	<ul style="list-style-type: none"> •Los campos de numeración deberán encontrarse dentro de una sola línea. Este mensaje aparecerá si se seleccionan caracteres de líneas diferentes como campo de numeración. •Los campos de numeración no pueden contener caracteres y un código de barras. Este mensaje aparecerá si selecciona un código de barras junto con otros caracteres como campo de numeración. 	<ul style="list-style-type: none"> •Ajuste el campo de numeración de forma que contenga caracteres situados dentro de una sola línea de texto. •Seleccione solamente el código de barras o los caracteres como campo de numeración.
KEY ERROR -XX-	<ul style="list-style-type: none"> •Este mensaje aparecerá cuando haya algún problema en los circuitos de la máquina. 	<ul style="list-style-type: none"> •Póngase en contacto con el representante de servicio.

MENSAJE DE ERROR	CAUSA	SOLUCIÓN
LENGTH LIMIT!	<ul style="list-style-type: none"> • La longitud de un mensaje de etiqueta está limitado a un metro. Este mensaje aparecerá si introduce un carácter, un símbolo, una marca diacrítica, un código de barras, un espacio, un retorno, o un nuevo bloque que haga que el texto sobrepase el límite de un metro. • Este mensaje aparecerá si el texto introducido sobrepasa el límite de un metro cuando la alimentación esté conectada o cuando esté intentando imprimir. • Este mensaje aparecerá si se invoca un archivo, se enlaza con el mensaje actual, y el resultado sobrepasa el límite de un metro. • Este mensaje aparecerá si pulsa la tecla RETURN en el modo de formato, haciendo que el texto sobrepase el límite de un metro. 	<ul style="list-style-type: none"> • Borre algo de texto o reduzca el tamaño de los caracteres. • Borre algo de texto o reduzca el tamaño de los caracteres. • Pulse la tecla CANCEL y borre algo de texto antes de invocar el archivo o de enlazar el texto del área de trabajo y el archivo. • Pulse la tecla CANCEL y borre algo del texto antes de introducir un símbolo o un ajuste de encuadre u otro de formato global.
LINE LIMIT!	<ul style="list-style-type: none"> • Este mensaje aparecerá si el número de líneas del texto es superior al número máximo posible de líneas para la cinta instalada. 	<ul style="list-style-type: none"> • Reduzca el número de líneas o instale una cinta de mayor anchura.
MEMORY FULL!	<ul style="list-style-type: none"> • Esta máquina puede almacenar aproximadamente 3.400 caracteres en su memoria. Este mensaje aparecerá cuando intente almacenar un mensaje demasiado grande como para dentro del espacio de memoria disponible. 	<ul style="list-style-type: none"> • Deje de intentar almacenar el mensaje o borre un archivo innecesario a fin de dejar espacio para el nuevo.
NO FILES!	<ul style="list-style-type: none"> • Este mensaje aparecerá si intenta invocar o borrar un archivo de texto de la memoria cuando no haya nada actualmente almacenado. 	<ul style="list-style-type: none"> • No intente invocar ni borrar un archivo de texto.
NO TAPE!	<ul style="list-style-type: none"> • Este mensaje aparecerá si intenta imprimir una etiqueta o hacer avanzar la cinta cuando no haya cassette de cinta instalado. 	<ul style="list-style-type: none"> • Instale un cassette de cinta y vuelva a intentarlo.

MENSAJE DE ERROR	CAUSA	SOLUCIÓN
NUMBERING BUFFER FULL	<ul style="list-style-type: none"> • Este mensaje aparecerá si pulsa la tecla RETURN en el modo de numeración cuando la memoria intermedia del área de trabajo esté llena. 	<ul style="list-style-type: none"> • Pulse la tecla CANCEL y borre algo del texto antes de entrar en el modo de numeración.
OPEN THE COVER!	<ul style="list-style-type: none"> • Este mensaje aparecerá cuando se cierre la cubierta del compartimiento de la cinta mientras se rebobina la cinta durante la impresión en colores múltiples. 	<ul style="list-style-type: none"> • Abra la cubierta del compartimiento y presione luego la tecla RETURN.
RAM PROBLEM!	<ul style="list-style-type: none"> • Este mensaje aparecerá cuando haya algún problema con la memoria de acceso aleatorio de la máquina. 	<ul style="list-style-type: none"> • Póngase en contacto con el representante de servicio.
REPLACE BATTERIES!	<ul style="list-style-type: none"> • Este mensaje aparecerá cuando las pilas alcalinas instaladas estén a punto de agotarse agotadas. 	<ul style="list-style-type: none"> • Reemplace las pilas o utilice el adaptador de CA.
ROM PROBLEM!	<ul style="list-style-type: none"> • Este mensaje aparecerá cuando haya algún problema con la memoria de lectura solamente de la máquina. 	<ul style="list-style-type: none"> • Póngase en contacto con el representante de servicio.
SYSTEM ERROR!	<ul style="list-style-type: none"> • Este mensaje aparecerá cuando haya algún problema con el software de la máquina. 	<ul style="list-style-type: none"> • Póngase en contacto con el representante de servicio.
TOO HIGH!	<ul style="list-style-type: none"> • Este mensaje aparecerá si el tamaño del texto es mayor que lo que permite la anchura de la cinta instalada. 	<ul style="list-style-type: none"> • Reduzca el tamaño de los caracteres, o instale una cinta de mayor anchura.
TOO LONG!	<ul style="list-style-type: none"> • Este mensaje aparecerá si la longitud del texto es mayor que la longitud establecida para la etiqueta. • Este mensaje aparecerá cuando el texto introducido en el modo de formato automático sobrepasa la longitud preajustada. 	<ul style="list-style-type: none"> • Borre algo del texto, reduzca la anchura de caracteres, o aumente la longitud preajustada de la etiqueta. • Introduzca menos caracteres.
WRONG SELECT	<ul style="list-style-type: none"> • Este mensaje aparecerá si ha seleccionado más de cinco caracteres como campo de numeración. • Este mensaje aparecerá si como campo de numeración selecciona caracteres con diferentes de formato. 	<ul style="list-style-type: none"> • Limite el campo de numeración a cinco caracteres. • Seleccione solamente caracteres con ajustes de formato idénticos.

ESPECIFICACIONES DEL P-TOUCH

HARDWARE

Dispositivo de entrada de datos:	TECLADO - 63 teclas
LCD:	112 x 32 puntos 19 indicadores
Cinta de impresión:	Sensible a la presión con base adhesiva (cintas TZ Solamente) 8 m de longitud. 5 anchuras disponibles: 6 mm (1/4") 9 mm (3/8") 12 mm (1/2") 18 mm (3/4") 24 mm (1")
Alimentación:	6 pilas alcalinas AA (adaptador de CA opcional) La alimentación se desconecta automáticamente si no se presiona ninguna tecla en 5 minutos o si no se usa la máquina durante 10 minutos durante el modo de interfaz.
Cabezal de impresión:	128 puntos / 180 dpi
Dimensiones:	25 mm (An) x 215 mm (Prf) x 68 mm (Al) (8,4" (An) x 8,4"(Prf) x 2,7" (Al))
Peso:	1,0 kg (2,2 lb)
Equipo opcional:	Adaptador de CA (MODELO AD-30)

SOFTWARE

Tamaño de los caracteres:	6 tamaños seleccionables (6, 10, 13, 19, 26 y 38 puntos) + Automático Todos disponibles en Estrecho, Medio y Ancho.
Juegos de caracteres:	8 tipos de caracteres incorporados
Tamaño de la memoria Intermedia:	Una línea 1 m (3,3') ó 255 caracteres Múltiples líneas 21 cm (8,3") para cada bloque Múltiples bloques
Tamaño de la memoria:	3,400 caracteres
Número de caracteres:	218 caracteres
Estilos de impresión:	Normal, Negrilla, Solida, Sombreado, Perfilado + Sombreado y Franjas. (Todos podrán combinarse con cursiva.)

ACCESORIOS

Adquiera los cassettes de cinta y los adaptadores de CA a un distribuidor autorizado. Brother no asumirá ningún tipo de responsabilidad por los problemas causados por la utilización de suministros no autorizados.

Utilice solamente cintas TZ Brother con esta máquina. No use cintas que no posean la marca TZ.

Num. de existencias	Descripción	Cantidad/Paquete	Precio
Cintas laminadas de 1" (24 mm)			
TZ-151	Caracteres negros en cinta adhesiva transparente	1	\$23,95
TZ-251	Caracteres negros en cinta adhesiva blanca	1	\$23,95
TZ-451	Caracteres rojos en cinta adhesiva roja	1	\$23,95
TZ-651	Caracteres negros en cinta adhesiva amarilla	1	\$23,95
TZ-252	Caracteres rojos en cinta adhesiva blanca	1	\$23,95
TZ-354	Caracteres dorados en cinta adhesiva negra	1	\$26,95
TZ-355	Caracteres blancos en cinta adhesiva negra	1	\$26,95
TZ-B51	Caracteres negros en cinta adhesiva anaranjada fluorescente	1	\$28,95
Cintas laminadas de 3/4" (18 mm)			
TZ-141	Caracteres negros en cinta adhesiva transparente	1	\$20,95
TZ-241	Caracteres negros en cinta adhesiva blanca	1	\$20,95
TZ-242	Caracteres rojos en cinta adhesiva blanca	1	\$20,95
TZ-243	Caracteres azules en cinta adhesiva blanca	1	\$20,95
TZ-344	Caracteres dorados en cinta adhesiva negra	1	\$24,95
TZ-345	Caracteres blancos en cinta adhesiva negra	1	\$23,95
TZ-441	Caracteres negros en cinta adhesiva roja	1	\$20,95
TZ-541	Caracteres negros en cinta adhesiva azul	1	\$20,95
TZ-545	Caracteres blancos en cinta adhesiva azul	1	\$23,95
TZ-641	Caracteres negros en cinta adhesiva amarilla	1	\$20,95
TZ-741	Caracteres negros en cinta adhesiva verde	1	\$20,95
TZ-B41	Caracteres negros en cinta adhesiva anaranjada fluorescente	1	\$24,95
TZ-M41	Caracteres negros en cinta adhesiva transparente (mate)	1	\$20,95
TZ-L041	Caracteres de rotulación instantánea	1	\$20,95

Num. de existencias	Descripción	Cantidad/ Paquete	Precio
Cintas laminadas de 1/2" (12 mm)			
TZ-131	Caracteres negros en cinta adhesiva transparente	1	\$16,95
TZ-231	Caracteres negros en cinta adhesiva blanca	1	\$17,95
TZ-232	Caracteres rojos en cinta adhesiva blanca	1	\$17,95
TZ-335	Caracteres blancos en cinta adhesiva negra	1	\$20,95
Cintas laminadas de 3/8" (9 mm)			
TZ-121	Caracteres negros en cinta adhesiva transparente	1	\$14,95
TZ-221	Caracteres negros en cinta adhesiva blanca	1	\$16,95
TZ-325	Caracteres blancos en cinta adhesiva negra	1	\$18,98
TZ-421	Caracteres negros en cinta adhesiva roja	1	\$16,95
Cintas laminadas de 1/4" (6 mm)			
TZ-111	Caracteres negros en cinta adhesiva transparente	1	\$12,95
TZ-211	Caracteres negros en cinta adhesiva blanca	1	\$14,95
TZ-315	Caracteres blancos en cinta adhesiva negra	1	\$17,95
Cassettes de impresión en colores múltiples			
TZ-T240	Cinta blanca	1	\$19,95
TZ-R041	Cinta de tinta negra	1	\$12,95
TZ-R042	Cinta de tinta roja	1	\$12,95
TZ-R043	Cinta de tinta azul	1	\$12,95

OPCIONAL

Num. de existencias	Descripción	Cantidad/ Paquete	Precio
AD-30	Adaptador de CA	1	\$21,95
6997	Funda de transporte opcional	1	\$31,95

brother®

UN342001
Printed in Japan

Free Manuals Download Website

<http://myh66.com>

<http://usermanuals.us>

<http://www.somanuals.com>

<http://www.4manuals.cc>

<http://www.manual-lib.com>

<http://www.404manual.com>

<http://www.luxmanual.com>

<http://aubethermostatmanual.com>

Golf course search by state

<http://golfingnear.com>

Email search by domain

<http://emailbydomain.com>

Auto manuals search

<http://auto.somanuals.com>

TV manuals search

<http://tv.somanuals.com>