

Breville

the Milk Café™

Instruction Booklet



BMF600

CONGRATULATIONS

on the purchase of your new
Breville Milk Café™

CONTENTS

- 4** Breville recommends safety first
- 7** Know your Breville Milk Café
- 10** Operating your Breville Milk Café™
- 16** Care & cleaning for your Breville Milk Café™
- 18** Hints & tips
- 20** Troubleshooting
- 22** Recipes

At Breville we are very safety conscious. We design and manufacture consumer products with the safety of you, our valued customer, foremost in mind. In addition we ask that you exercise a degree of care when using any electrical appliance and adhere to the following precautions.

IMPORTANT SAFEGUARDS

READ ALL INSTRUCTIONS BEFORE USE AND SAVE FOR FUTURE REFERENCE

- Carefully read all instructions before operation and save for future reference.
- Remove and safely discard any packaging material and promotional labels before using the Breville Milk Café™ for the first time.
- To eliminate a choking hazard for young children, remove and safely discard the protective cover fitted to the power plug of this appliance.
- Do not place the Breville Milk Café™ near the edge of a bench or table during operation.
- Do not place the appliance on or near a hot gas burner, electric element or where it could touch a heated oven.
- Do not operate the appliance on a sink drain board.
- Ensure that the surface is level, clean and free of water.
- The Breville Milk Café™ is not intended to be operated by means of an external timer or separate remote control system.
- To protect against electric shock, do not immerse the power base, power cord or power plug in water or allow moisture to come in contact with these parts.
- Always switch the Breville Milk Café™ off at the power outlet and unplug if appliance is to be left unattended, if not in use, before cleaning, before attempting to move the appliance, disassembling, assembling and when storing the appliance.
- The Breville Milk Café™ is not intended for use by young children or infirm persons unless they have been adequately supervised by a responsible person to ensure they can use the appliance safely.
- The Breville Milk Café™ has been designed specifically for the purpose of foaming milk and other dairy milk alternatives and is not intended to thicken or heat other food substances eg. cream, custards, soups, gravies.
- The Breville Milk Café™ is not designed to mix a large quantity of dry ingredients or melt large food pieces eg. cubed chocolate, ground nuts, whole spices, fresh herbs.
- The underside of the jug must always be dry before placing onto power base before use.
- The jug must only be used with the power base provided. Do not use attachments other than those provided with the Breville Milk Café™.
- Attach the jug lid securely to the jug before operation. Do not open the jug lid during operation.
- Use caution when pouring foamed milk from the jug after heating as hot milk may scald at high temperatures.
- Do not operate the appliance without liquid. Always fill to at least the 'MIN' marking and no more than the 'MAX' marking inside the jug.
- Do not put metal or similar items into the jug as this may damage or affect the operation of the unit.
- Keep the appliance and accessories clean. Follow the Care and Cleaning instructions provided on Page 16.

IMPORTANT SAFEGUARDS FOR ALL ELECTRICAL APPLIANCES

- Fully unwind the power cord before use.
- Do not let the power cord hang over the edge of a bench or table, touch hot surfaces or become knotted.
- To protect against electric shock do not immerse the power cord, power plug or appliance in water or any other liquid.
- The appliance is not intended for use by persons (including children) with reduced physical, sensory or mental capabilities, or lack of experience and knowledge, unless they have been given supervision or instruction concerning use of the appliance by a person responsible for their safety.
- Children should be supervised to ensure that they do not play with the appliance.
- It is recommended to regularly inspect the appliance. To avoid a hazard do not use the appliance if power cord, power plug or appliance becomes damaged in any way. Return the entire appliance to the nearest authorised Breville Service Centre for examination and/or repair.
- If the supply cord is damaged, it must be replaced by the manufacturer, its service agent or similarly qualified persons in order to avoid a hazard.
- Any maintenance other than cleaning should be performed at an authorised Breville Service Centre.
- This appliance is for household use only. Do not use this appliance for anything other than its intended use. Do not use in moving vehicles or boats. Do not use outdoors. Misuse may cause injury.
- The installation of a residual current device (safety switch is recommended to provide additional safety protection when using electrical appliances. It is advisable that a safety switch with a rated residual operating current not exceeding 30mA be installed in the electrical circuit supplying the appliance. See your electrician for professional advice.

WARNING

Always ensure frothing disc is inserted firmly into jug before use.

WARNING

Frothing disc is a choking hazard. Children must always be supervised and never left unattended with appliance.

WARNING

Never immerse the power base, power cord or power plug in water or allow moisture to come into contact with these parts.

BREVILLE ASSIST™ PLUG

- Your Breville appliance comes with a unique Assist™ Plug, conveniently designed with a finger hole in the power plug for easy and safe removal from the wall outlet. For safety reasons it is recommended you plug your Breville appliance directly into its own electrical outlet on a dedicated circuit separate from other appliances. If the electrical circuit is overloaded with other appliances, your appliance may not function properly. Using in conjunction with a power strip or extension cord is not recommended.

**SAVE THESE
INSTRUCTIONS**

KNOW

your Breville Milk Café™

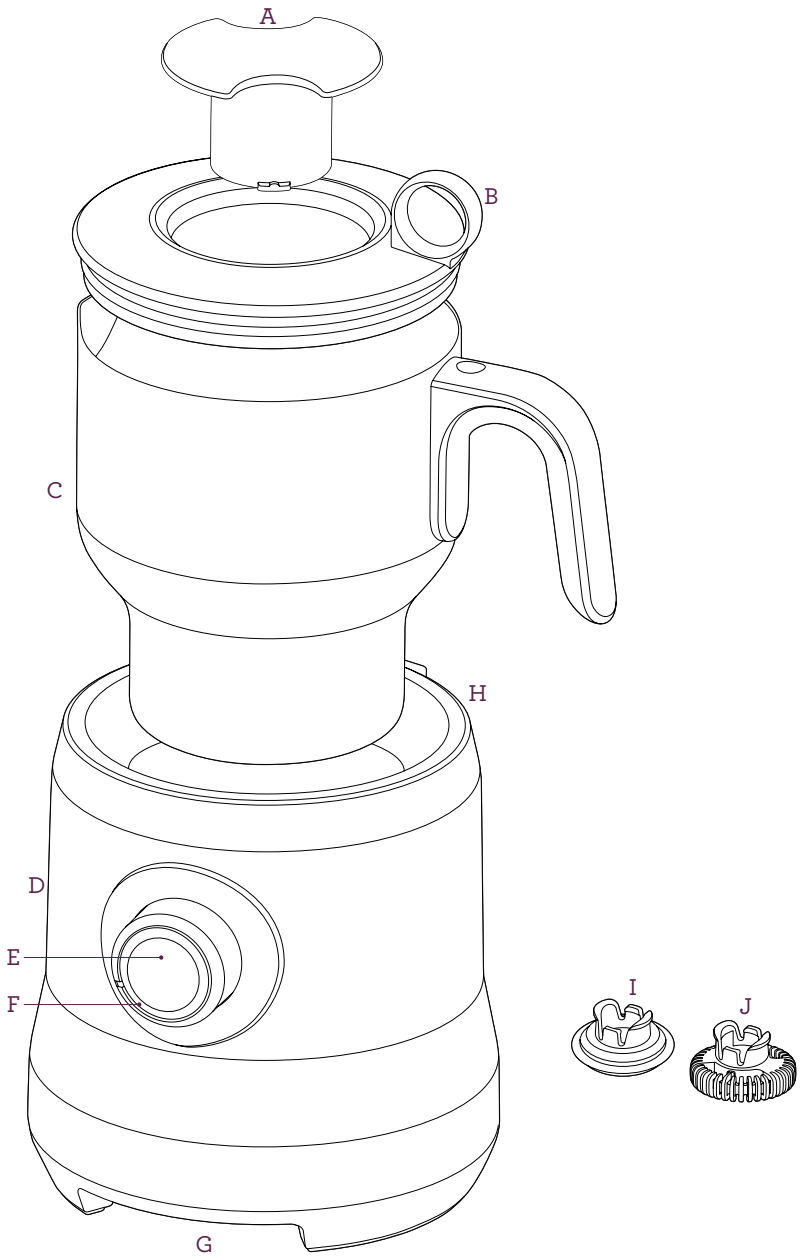

- A. **Measuring Cap**
For measuring and adding ingredients once mixing has started.
- B. **Jug Lid**
With Breville Assist™ Ring-Pull Removal.
- C. **Dishwasher Safe Jug**
Stainless steel jug with inner measurement markings and pouring spout.
- D. **Power Base**
Induction Heating Technology provides gentle, even heat distribution.
- E. **START | STOP Push-Dial**
Press the centre of the dial to start or stop operation. Turn the dial to adjust the temperature. 'COLD STIR' setting stirs without heating.
- F. **LED Indicator**
Displays 'Power On/Off' and heating
- G. **Cord Wrap**
- H. **'On Board' Disc Storage**
- I. **'Latte' Frothing Disc**
For smooth and silky milk.
- J. **'Cappuccino' Frothing Disc**
For thick and creamy froth.

OPERATING

your Breville Milk Café™

OPERATING YOUR BREVILLE MILK CAFÉ™

BEFORE FIRST USE

Before first use, remove and safely discard all promotional labels and packing materials attached to the Breville Milk Café™.

Wash the jug, lid and measuring cap in warm soapy water and dry thoroughly. Wipe exterior of appliance with a soft damp cloth and dry thoroughly.

Place appliance on a flat level surface and plug power cord into 230-240V outlet and turn power 'On'.

FROTHING HOT MILK

1. Turn the appliance 'On' at the power outlet.

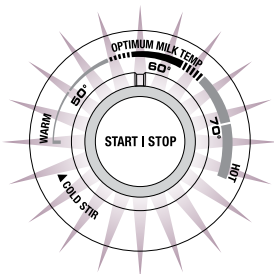

2. Select the 'Capp' or 'Latté' frothing disc.

Choose 'Capp' disc for thick and creamy froth or the 'Latté' disc for smooth and silky milk.

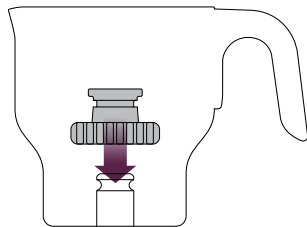
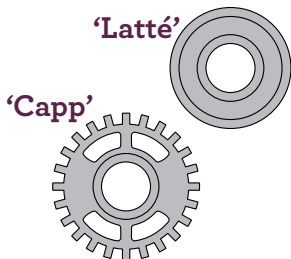

3. Insert frothing disc firmly into position onto the shaft at the base of the jug.

NOTE

Always ensure frothing disc is firmly inserted into jug before adding liquid. If disc is not inserted correctly it may dislodge during operation.



WARNING

Frothing disc is a choking hazard. Children must always be supervised and never left unattended with appliance.

4. Pour the required amount of cold fresh milk into the jug and cover with jug lid. Always use cold milk and fill the jug between the MIN and MAX level markings.

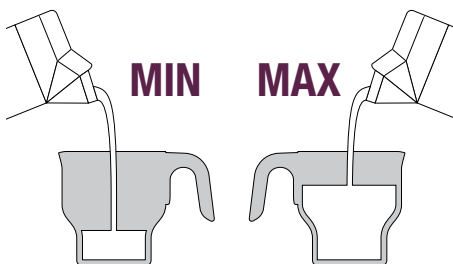

NOTE

For optimum frothing results, do not exceed the CAPP/LATTE MAX (500ml) marking inside the jug.

OPERATING YOUR BREVILLE MILK CAFÉ™

NOTE

Never operate the appliance without the minimum level of liquid in the jug. The appliance will automatically turn off if jug is empty. Wait for appliance to cool down before re-use.

- Place the jug correctly onto the power base, ensuring the jug is dry and clean.
- Turn the START | STOP dial to the desired temperature. When frothing milk for a cappuccino or latte, we recommend staying within the 'OPTIMUM MILK TEMP' range, however this is up to your personal preference.

If temperature setting is changed whilst in operation, the appliance will stop at the new temperature selected.

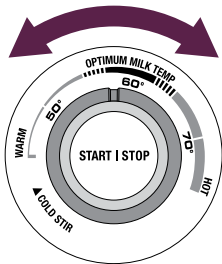

- Press the START | STOP button to commence frothing. The button surround will start flashing.

NOTE

Do not remove jug during operation. To stop operation at any time, press the START | STOP button once.

- When liquid has reached set temperature, the appliance will stop. This will take anywhere between 2 -7 minutes depending on the quantity of milk used.

Carefully remove the jug from the power base as the jug and contents will be hot. Always remove the jug using the jug handle. Do not place the jug on a table, plastic surface or heat sensitive surface which may scorch or melt. Remove the jug lid and pour the frothed milk.

NOTE

The frothing disc will be hot after operation. Wait for jug to cool before removing disc.



WARNING

Surface of the jug will be hot during and after operation. Do not place hot jug on heat sensitive surface



WARNING

Do not place hot jug onto power cord.

NOTE

The milk frother has been designed specifically for the purpose of foaming milk and other dairy milk alternatives and is not intended to whip, thicken or heat other food substances eg. cream, custard, soup, gravy etc.

The milk frother is not designed to mix a large quantity of dry ingredients or melt large food pieces eg. cubed chocolate, ground nuts, whole spices or fresh herbs.

USING THE 'COLD STIR' SETTING

By selecting the 'Cold Stir' setting on the temperature dial, you can froth cold or hot milk without heating.

The 'Cold Stir' setting is ideal for making cold beverages or blending ingredients.

The 'Cold Stir' setting will operate for 60 seconds.

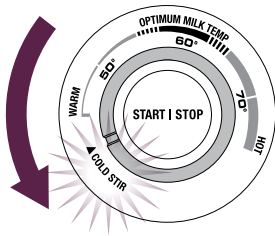

NOTE

Avoid adding sugary powders using 'Cold Stir' setting. Toppings and syrups work best.

ADDING INGREDIENTS

Using the measuring cap, gradually add ingredients a few minutes after the stirring cycle has commenced, allowing the milk to warm first.

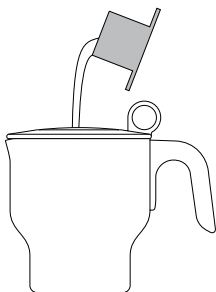

Always add ingredients slowly and in small quantities. Adding ingredients too quickly may cause the frothing disc to dislodge or stop spinning.

NOTE

A different frothing result may be achieved depending on the ingredients added.

Experiment with different milk options, ingredients and frothing discs to achieve the desired result.

SAFETY FEATURES

Standby

After 30 seconds of non use the milk frother will enter standby mode and the button surround will cease to illuminate.

To activate the milk frother out of standby mode, press the START | STOP button.

Boil Dry Protection

The milk frother will automatically cease to operate if the jug overheats. This can be caused if the jug is empty, if liquid is below the MIN measurement marking, or after consecutive uses. Wait approximately 5 minutes for the milk frother to cool down or fill the jug with water for faster cooling. Once adequately cooled, you will be able to activate the milk frother and recommence frothing.

Thermal Fuse Protection

This feature protects the milk frother in case of major fault.

The appliance will no longer be able to operate. Immediately cease use and return appliance to Breville.

Call Breville Customer Service on
Ph: 1300 139 798 (Australia) or
Ph: 0800 273 845 (New Zealand).

PREPARATION GUIDE

SUITABLE LIQUIDS	FRESH MILK	COW Full cream low fat, skim	SOY Full cream & low fat	GOAT	SHEEP	
	UHT MILK	COW Full cream low fat, skim	SOY Full cream & low fat	GOAT / SHEEP	OAT / RICE	ALMOND
SUITABLE INGREDIENTS	POWDERS/ FLAKES	DRINKING CHOCOLATE	COCOA POWDER	CHAI TEA	CHOCOLATE FLAKES	
	TOPPINGS/ SYRUPS	CHOCOLATE	COCOA POWDER	HONEY	MAPLE	
RECIPES	HOT DRINKS	HOT CHOCOLATE	CAPPUCCINO	LATTÉ	FLAT WHITE	CHAI LATTÉ
	COLD DRINKS	ICED CHOCOLATE	ICED COFFEE	ICED MOCHA		

CARE & CLEANING

for your Breville Milk Café™

CARE & CLEANING FOR YOUR BREVILLE MILK CAFÉ™

1. Unplug the power cord from the power outlet before cleaning.
2. The jug and frothing disc will be hot after use. Wait for jug and disc to cool before rinsing in tap water.
3. Wash the jug, jug lid, measuring cap and frothing disc in warm soapy water, rinse and dry thoroughly.
The seal from the lid can be removed and washed separately.
4. Wipe exterior of appliance with a soft, damp cloth.

NOTE

Do not use alkaline or abrasive cleaning agents, steel wool or scouring pads as these can damage the surface.

NOTE

Never immerse the power base in water or any other liquid. The underside of the jug must always be dry before placing on power base prior to use.

NOTE

Only the jug, jug lid, measuring cap and frothing discs can be washed in the dishwasher (top shelf only).

HINTS & TIPS

for your Breville Milk Café™

HINTS & TIPS

- Always use cold, fresh (or freshly opened) milk.
- For optimum frothing results, do not exceed the CAPP/LATTE MAX (500ml) marking inside the jug.
- For best results, always start cycle and warm milk first before adding ingredients.
- Remove excess air bubbles from frothed milk by gently tapping jug on a bench.
- Swirl frothed milk in a circular motion before pouring milk into a cup or glass.
- Pour frothed milk promptly to avoid the milk from separating. Frothed milk that is not used immediately should not be reheated.
- Ensure jug and frothing disc are clean before use.

TROUBLESHOOTING

TROUBLESHOOTING

PROBLEM	POSSIBLE CAUSE	WHAT TO DO
Milk is not foaming?	<ul style="list-style-type: none"> Milk is warm or too hot to foam. 	<ul style="list-style-type: none"> Use cold, fresh milk. Do not re-foam already heated milk. Try reducing milk volume in jug.
Milk is not heating?		<ul style="list-style-type: none"> Ensure jug is correctly positioned onto power base. Press START/STOP button to commence cycle. Ensure light is illuminated and not flashing. Increase temperature by turning the START STOP dial to the right.
Frothing disc is not moving or is dislodged?	<ul style="list-style-type: none"> Frothing disc is not inserted correctly. Frothing disc has dislodged during operation. Ingredients have been added too quickly. 	<ol style="list-style-type: none"> Stop operation. Remove liquid from jug. Insert disc firmly into jug. Refill jug with liquid. Add ingredients (if desired) slowly and in small quantities.
Ingredients are not melting?	<ul style="list-style-type: none"> Ingredients have been added before milk has warmed up. Ingredients are too large. 	<ul style="list-style-type: none"> Allow the milk frother to stir for a few seconds before adding ingredients. Ensure ingredients are in small pieces.
Milk is too cold/ too hot?		<ul style="list-style-type: none"> Adjust temperature dial to suit personal preference. Always operate unit between MIN and MAX level markings inside jug.
Emergency stop		<ul style="list-style-type: none"> To stop operation at any time, press the START STOP button. Operation has stopped once the button surround has stopped flashing.

RECIPES



HOT CHOCOLATE

A heated beverage of shaved chocolate, melted chocolate or cocoa powder blended with heated and foamed milk or water and sugar.



CAPPUCCINO

Cappuccino is served very light and luke warm with $\frac{1}{3}$ espresso to $\frac{1}{3}$ heated milk and a generous final third of creamy froth. For added finesse, dust with powdered chocolate.



CHAI LATTÉ

A chai latté is $\frac{3}{4}$ heated and foamed milk flavoured with spiced tea concentrate including sugar and spices and topped with ground nutmeg or cinnamon.



FLAT WHITE

A single dose of espresso in a cup topped with heated and foamed milk, $\frac{1}{3}$ coffee and $\frac{1}{3}$ milk.



LATTÉ

Latté is a blend of $\frac{1}{3}$ espresso to $\frac{2}{3}$ milk is made with a single shot of espresso. Top with heated and foamed milk, poured down the inside rim of the glass to give a creamy consistency and perfect layer of froth.



ICED COFFEE/ICED CHOCOLATE

A cold beverage of cold, foamed milk mixed with coffee and topped with ice cream, whipped cream and chocolate shavings*.

* Substitute coffee with chocolate powder or topping to make iced chocolate.



Breville

Breville Customer Service Centre

Australian Customers

Mail: PO Box 22
Botany NSW 2019
AUSTRALIA

Phone: 1300 139 798

Fax: (02) 9384 9601

Email: Customer Service:
askus@breville.com.au

New Zealand Customers

Mail: Private Bag 94411
Botany Manukau 2163
Auckland NEW ZEALAND

Phone: 0800 273 845

Fax: 0800 288 513

Email: Customer Service:
askus@breville.com.au

www.breville.com.au

Breville is a registered trademark of Breville Pty. Ltd. A.B.N. 98 000 092 928.
Copyright Breville Pty. Ltd. 2010.

Due to continued product improvement, the products illustrated/photographed
in this booklet may vary slightly from the actual product.

BMF600 Issue - B 10

Free Manuals Download Website

<http://myh66.com>

<http://usermanuals.us>

<http://www.somanuals.com>

<http://www.4manuals.cc>

<http://www.manual-lib.com>

<http://www.404manual.com>

<http://www.luxmanual.com>

<http://aubethermostatmanual.com>

Golf course search by state

<http://golfingnear.com>

Email search by domain

<http://emailbydomain.com>

Auto manuals search

<http://auto.somanuals.com>

TV manuals search

<http://tv.somanuals.com>