

Horizon Duo

High Performance Tabletop Music System
AM/FM Stereo Radio

Español

Sistema de audio de mesa
de alto rendimiento
Radio AM/FM estéreo

Italiano

Impianto musicale da tavolo
ad alte prestazioni
Radio stereo AM/FM

Deutsch

Hochleistungsfähiges Kompakt-
Musiksystem
MW-/UKW-Stereoradio

Français

Système de musique de table à
haute performance
Radio AM/FM stéréo

Svenska

Högpresterande musiksystem
AM/FM-stereoradio



IMPORTANT SAFETY INSTRUCTIONS



This symbol found on the apparatus indicates hazards arising from dangerous voltages.



This symbol found on the apparatus indicates the user should read all safety statements found in the user manual.



This symbol found on the apparatus indicates double insulation.

1. Read these instructions.
2. Keep these instructions.
3. Heed all warnings.
4. Follow all instructions.
5. Do not use this apparatus near water.
6. Clean only with dry cloth.
7. Do not block any ventilation openings. Install in accordance with the manufacturer's instructions.
8. Do not install near any heat sources such as radiators, heat registers, stoves, or other apparatus (including amplifiers) that produce heat.
9. Do not defeat the safety purpose of the polarized or grounding type plug. A polarized plug has two blades with one wider than the other. A grounding-type plug has two blades and a third grounding prong. The wide blade or the third prong is provided for your safety. If the provided plug does not fit into your outlet, consult an electrician for replacement of the obsolete outlet.
10. Protect the power cord from being walked on or pinched particularly at plugs, convenience receptacles, and the point where they exit from the apparatus.
11. Only use attachments/accessories specified by the manufacturer.
12. Unplug this apparatus during lightning storms or when unused for long periods of time.
13. Refer all servicing to qualified service personnel. Servicing is required when the apparatus has been damaged in any way, such as power-supply cord or plug is damaged, liquid has been spilled or objects have fallen into the apparatus, the apparatus has been exposed to rain or moisture, does not operate normally, or has been dropped.
14. Maintain a minimum distance of 2" (50mm) around the front, rear, and sides of the apparatus for sufficient ventilation. The ventilation should not be impeded by covering the ventilation openings or placing on or around the apparatus items such as newspapers, tablecloths, curtains, etc.
15. No open flame sources, such as lighted candles, should be placed on the apparatus.
16. The apparatus shall not be exposed to dripping or splashing. No objects filled with liquids, such as vases, shall be placed on the apparatus.



Warning! To reduce the risk of fire or electrical shock, do not expose this apparatus to rain or moisture.



This symbol found on the apparatus indicates that the apparatus must be placed in a separate collection facility for electronic waste and not disposed with household waste.

17. Either the power inlet connector on the rear of the apparatus or the power plug at the wall must remain accessible, to be able to disconnect power from the apparatus.
18. To completely disconnect this apparatus from the AC Mains, disconnect the power supply cord plug from the AC receptacle.
19. The mains plug of the power supply cord shall remain readily operable.

American Users:

Note: This equipment has been tested and found to comply with the limits for a Class B digital device, pursuant to part 15 of the FCC Rules. These limits are designed to provide reasonable protection against harmful interference in a residential installation. This equipment generates, uses, and can radiate radio frequency energy and, if not installed and used in accordance with the instructions, may cause harmful interference to radio communications. However, there is no guarantee that interference will not occur in a particular installation. If this equipment does cause harmful interference to radio or television reception, which can be determined by turning the equipment off and on, the user is encouraged to try to correct the interference by one or more of the following measures:

- Reorient or relocate the receiving antenna.
- Increase the separation between the equipment and receiver.
- Connect the equipment into an outlet on a circuit different from that to which the receiver is connected.
- Consult the dealer or an experienced radio/TV technician for help.

Caution: Unauthorized changes or modifications to the receiver could void user's authority to operate the equipment.

Canadian Users:

This class B digital apparatus complies with Canadian ICES-003.

Cet appareil numérique de classe B est conforme à la norme NMB-003 du Canada.

Introduction

Thank you for choosing Boston Acoustics and congratulations on your purchase of the Horizon Duo High Performance Tabletop Music System. If you own other Boston products, the outstanding audio performance and ease-of-use of the Duo should come as no surprise. If you're new to Boston, welcome – we think you've made a great choice. The Duo is a sophisticated stereo radio and speaker system with dual alarms, auxiliary inputs and outputs, all in a high-style, soft-touch enclosure – all the things that "Play Smart." In addition, with the optional HRD-i docking adapter, you can play your iPod music and videos through the Duo. So check out all the features and functions of your new music system. We know you'll enjoy it for years to come.

Features

- Outstanding audio performance from dual 3 1/2-inch speakers in separate acoustic chambers, vented for extended response
- BassTrac® audio processing for satisfying bass at any volume
- Three intuitive, easy to use controls operate all the Duo features
- Multi-function remote control-
- Large, easy to read display with adjustable brightness that dims automatically in low light conditions
- Highly sensitive AM/FM Stereo tuner
- 10 FM radio station presets; 5 AM radio presets
- External antenna inputs for maximum reception
- Dual alarm functions each with wake-to-alarm and/or wake-to-music
- Easy to use, one-button alarm setting
- Alarms gradually increase in volume for a gentle wake up
- S-n-o-o-o-o-z-e bar – the entire outer aluminum trim is a touch sensitive, can't-miss-it snooze bar
- Sleep function lets you listen to music up to 90 minutes before the Duo turns itself off
- Make it your own! Customize your Duo with optional grilles available at www.bostonacoustic.com/POP
- Time setting, station presets, and alarms settings are remembered during power outages
- Headphone output on the front panel
- Dual auxiliary inputs - front and rear panel
- Internal power supply - no bulky external adapter needed

With the optional HRD-i docking adapter:

- Play your iPod through the Duo speakers
- Use the Duo remote to control your iPod
- The composite video output lets you play iPod TV program through a television
- Your iPod is charged while placed in the HRD-i

© 2008. All rights reserved. Boston, Boston Acoustics and BassTrac are registered trademarks, and the B/A ellipse symbol, make it your own, and Play Smart are trademarks of Boston Acoustics, Inc.

Contents

Unpacking and Setting Up Your Horizon Duo	4	Other Control Settings	12
Placement	4	Display Information	12
Power Connection	4	Display Brightness	12
AM and FM Antennas	5	Connecting Other Equipment	13
About the Front Panel Controls	5	Connecting Headphones	13
About the Remote Control	5	Using Aux Inputs	13
Basic Control Operations	6	The HRD-i – iPod Docking Adapter	13
Turning the Horizon Duo On or Off	6	Connecting the HRD-i	13
Adjusting the Volume	6	Selecting the iPod Source	14
Setting the Clock	6	Front Panel Control iPod Operation	14
Selecting a Source	7	Remote Control iPod Operation	14
Tuning In a Radio Station	7	About Clock Memory	15
Station Seek	8	Security Cable Connection	15
Setting a Station Preset	8	Service Port	15
Selecting a Preset Station	9	Maintenance and Service	15
Adjusting Bass and Treble	9	Limited Warranty	16
Alarm Clock Features	10	If Service Seems Necessary	16
Setting the Alarm Time	10		
Setting an Alarm	10		
How the Alarms Work	10		
The Snooze Feature	11		
The Sleep Function	11		

Unpacking and Setting Up Your Horizon Duo

Carefully unpack the Horizon Duo. If there is any sign of damage from transit, report it immediately to your dealer and/or delivery service. Keep the shipping carton and packing materials for future use. Be sure to keep your purchase receipt in a safe place, as it may be required for warranty purposes.

In the box you should find the Horizon Duo, the remote control and the power cord.

Placement

Your Horizon Duo will sound great just about anywhere. But if you put it near a wall or corner the bass response will be enhanced. Don't block the bass port. Be sure the vents on the top of the cabinet are unobstructed to allow for ventilation.

Power Connection

Just connect the power cord to the back of the Horizon Duo and plug it into the wall power outlet.

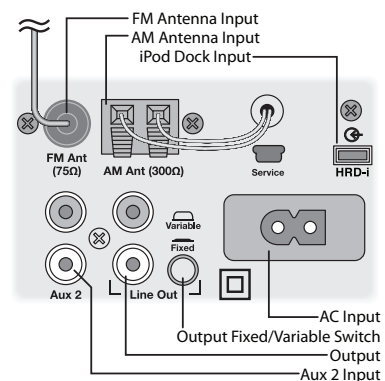

AM and FM Antennas

The Horizon Duo comes out of the box ready to use. The internal AM antenna is connected. The FM antenna is also connected. Just extend the wire connected to the plug. With the standard antennas you'll probably pull in more stations than any other radio you own. But if you want to listen to stations that are very far away then external antennas can be connected to the antenna inputs.

About the Front Panel Controls

Most of the Horizon Duo functions are operated by the three controls on the front panel.

Power/Volume – Is controlled by the large knob in the center of the panel.

Mode – Selects the input you want to use or the function you want to adjust.

Tune – Tunes in a new radio station.

These logical, intuitive controls make it easy to operate the Horizon Duo. The way you use each control is the same for each feature. Once you learn how to control one of the features the rest of them will be easy. You may not need to refer to this manual once you understand the way the controls work.



About the Remote Control

Most of the features of the Horizon Duo can be operated with the supplied remote control. When it's not being used, the remote control can be conveniently stored in the recess on top of the Horizon Duo. The remote also has a magnetic backing so it can be attached to many metal surfaces.

Note: When you unpack your remote control there will be a plastic insulation tab extending from the battery compartment. Pull out this tab before using the remote control.

There must be an unobstructed line of sight to the front of the Horizon Duo when using the remote control. Point the remote control at the front panel of the Horizon Duo when pressing the buttons. For best results you should be within 20 feet of the unit and no more than 45° off axis.

Note: Eventually you'll need to replace the remote battery. If the remote doesn't reliably operate the Duo, put in a new CR2025 3V lithium coin type battery.

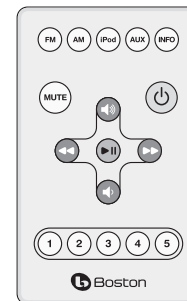



Basic Control Operations

Turning the Horizon Duo On or Off



Press the **POWER/VOLUME** control on the center of the front panel or the green  button on the remote control.

Adjusting the Volume

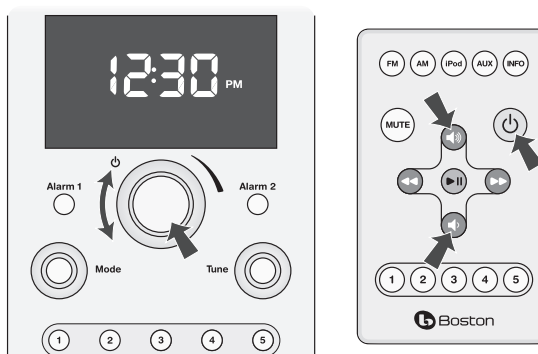

Turn the front panel **POWER/VOLUME KNOB** or press the **VOLUME UP**  or **VOLUME DOWN**  buttons on the remote control.



Note: On the control illustrations –

-  Regular arrows indicate to press and release the button or control.
-  Double headed arrows indicate to press and hold the button or control.
-  This symbol indicates the control is turned then pressed.

Setting the Clock

- 1** Turn the **MODE** control until the clock icon  is highlighted with brackets .
- 2** Press the **MODE** control. The clock icon and time display will flash.
- 3** Turn the **MODE** control to adjust the time.
- 4** Press the **MODE** control again to set the time. The display reverts to its previous mode and the new time is set.

Note: The clock can display time in either 12 hour or 24 hour format. To change the time display turn the **MODE** control to highlight the clock icon with brackets . Press and hold the **MODE** control for 5 seconds. The display will show "12H" or "24H". Turn the **MODE** control to select the time format you want, then press the control.

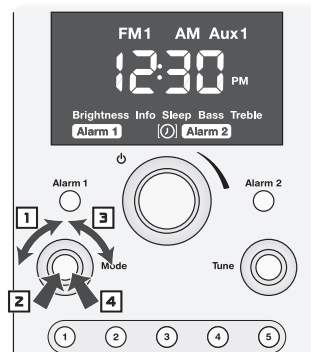

Selecting a Source

Using the Front Panel Controls

- 1 Turn the **MODE** control until the source you want is highlighted with brackets. Note that other function and alarm setting control icons also may be selected.
- 2 Press the **MODE** control to select the highlighted item. Or just wait a few seconds and the source is automatically selected. The Duo begins playing the source selected.

Using the Remote Control

Press the button for the source you want to select. Press the **FM** and **AUX** buttons once for FM 1 or AUX 1 and twice for FM 2 or AUX 2.

Notes:

- There are FM 1 and FM 2 source options. They correspond to the two FM radio preset groups.
- There are Aux 1 and Aux 2 source options. Aux 1 is the front panel input. The Aux 2 input is on the rear panel.

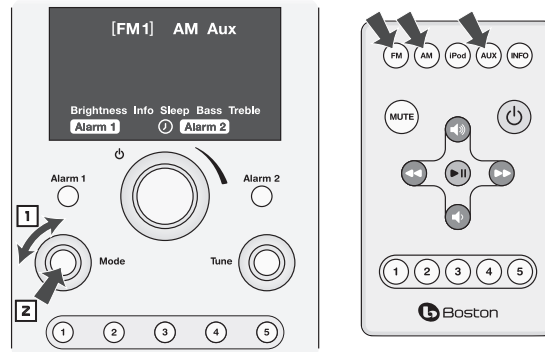

Tuning In a Radio Station

Using the Front Panel Controls

- 1 Use the **MODE** control to select the AM radio source or one of the FM radio sources.
- 2 Turn the **TUNE** control until the station frequency you want shows in the display.

Using the Remote Control

- 1 Press the **AM** or **FM** radio source button.
- 2 Press the **◀◀** or **▶▶** button once to step up or down the radio band to the next station frequency.

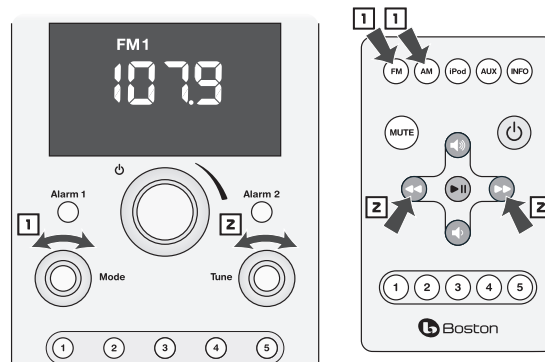

Notes:

- If the radio source you want is already selected you can skip step 1 and use the front panel **TUNE** control or the remote **◀◀** or **▶▶** buttons to tune in a new station.
- If the station you select has been assigned to a station preset, the preset indicator and number are displayed.

Station Seek

Using the Front Panel Control

Press the **TUNE** button. The Duo will seek up the radio band for the next receivable station.

Using the Remote Control

Press and hold the **◀◀** or **▶▶** button. The Duo will seek up or down the radio band for the next receivable station.

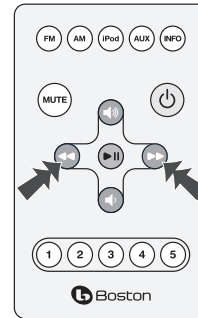

Setting a Station Preset

- 1 Use the **MODE** control, or press the **AM** or **FM** button on the remote control to select the radio band you want to use. There are two sets of FM presets. They are selected by choosing the FM 1 or FM 2 sources.
- 2 Use the front panel **TUNE** control, or the **◀◀** or **▶▶** buttons on the remote control to tune in the station you want to assign to a preset.
- 3 Press and hold the front panel or remote control **PRESET BUTTON** (1-5) you want to set up. A tone will sound and the preset number will light indicating the station has been assigned to the preset.

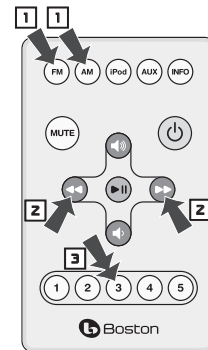
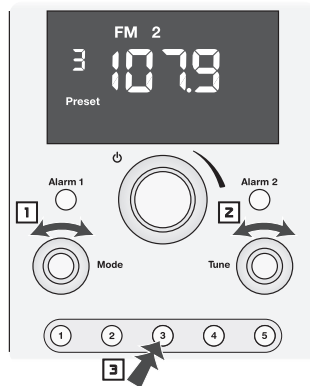

In this example FM station 107.9 has been assigned to preset 3 in the FM 2 group.

Selecting a Preset Station

- 1 Turn the **MODE** control to highlight the radio band of the preset you want to select. There are two sets of FM presets. They are selected by choosing the FM 1 or FM 2 source.
- 2 Press and quickly release the **PRESET BUTTON** (1-5) you want to select. The preset indicator, the preset number and the station frequency will light.

In this example AM preset 5, with station frequency 1050 assigned to it, has been selected.

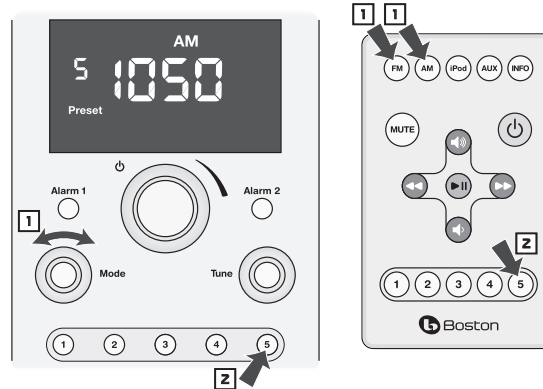

Note: Pressing a **PRESET BUTTON** more than once will switch to the other radio band or preset group. Using this example, if you press **PRESET BUTTON 5** again, then preset 5 in the FM 1 group is selected. Another press selects preset 5 in the FM 2 group. Press the button one more time and AM preset 5 is selected again.

Adjusting Bass and Treble

- 1 Turn the **MODE** control to select the Bass or Treble icon in the display. The Bass or Treble icon and the current setting flashes in the display.
- 2 Turn the **MODE** control clockwise to increase, or counter-clockwise to decrease the Bass or Treble

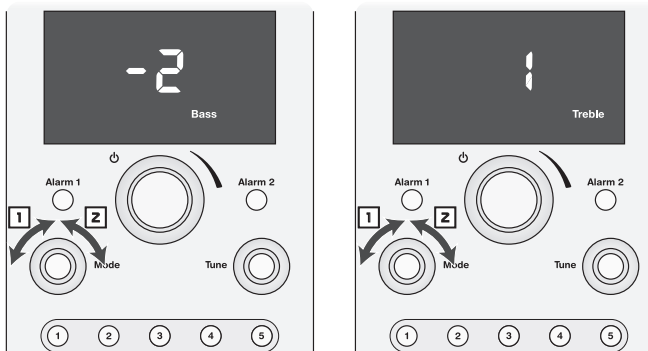

In these examples the Bass is set to -2 and the Treble is set to +1.

Alarm Clock Features

The Horizon Duo has two independent alarm settings. Each can have its own type of alarm—wake to tone, wake to music or both. Both types of alarms start at a low volume level that gently increases.

Setting the Alarm Time

The alarm time can be set when the Duo is turned on or off.

- 1 Press and hold the **ALARM 1** or **ALARM 2** button for one second. The alarm time and the **Alarm 1** or **Alarm 2** icon will flash.
- 2 Turn the **MODE** control to adjust the alarm time.
- 3 Press the **MODE** control to set the alarm time.

In this example Alarm 2 is set to 7:15 AM.

Note: The alarm time can also be set by using the **MODE** control to highlight the **Alarm 1** or **Alarm 2** icon. Then press the **MODE** control and follow steps 2 and 3 above.

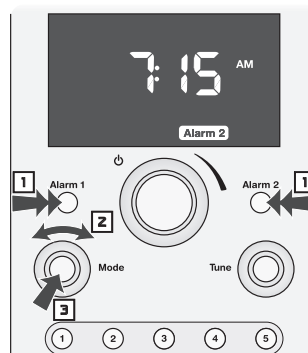

Setting an Alarm

If you plan to use the wake to music function, note that the last source and volume level settings will be used for this alarm.

- 1 Press the **ALARM 1** or **ALARM 2** buttons one or more times to turn on the alarm and set the alarm type. One press selects wake to music (M). A second press selects wake to tone (T). A third press selects both. Press the button a fourth time to cancel the alarm.

This example shows how the display might look after the Duo is turned off. The current time is displayed and the icons show Alarm 1 is on set for wake to music and tone and Alarm 2 is on set to tone only.



How the Alarms Work

When an alarm is triggered the icon for the alarm starts flashing.

If you selected wake to tone, the alarm tone starts sounding, quietly at first then with increasing volume.

If you selected wake to music with a radio, the station you last tuned to is played at a gradually increasing volume.

If you selected wake to music and tone, the radio station you selected begins playing at a gradually increasing volume. If you do not turn off the music source alarm after five minutes the music stops playing and the alarms tone begins to sound at a gradually increasing volume.

To turn off the alarm press the **POWER/VOLUME** control.

The Snooze Feature

If you want to sleep a while longer after the alarm sounds you can use the "Snooze" feature. Simply touch the outer metal rim around the Duo. This will delay the alarm for ten minutes. Each additional touch of the rim increases the length of the "Snooze" alarm delay by 5 minutes. The maximum delay is 60 minutes. The display shows the time and a flashing Alarm icon.

Touch Sensitive Rim

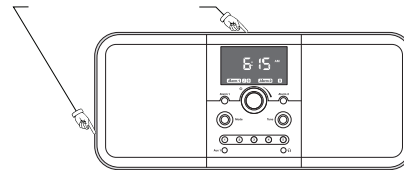

To see how much "Snooze" time is left touch the metal rim once. If you touch the rim again another five minutes is added to the "Snooze" time for each additional touch.

To cancel the "Snooze" function press the **ALARM 1** or **ALARM 2** button for the active Alarm or the **POWER/VOLUME** button.

The Sleep Function

You can set the Horizon Duo to play for up to 90 minutes. After the specified time the Duo shuts off.

- 1** Select the source and set the volume level. Use the **MODE** control to highlight the Sleep icon in the display.
- 2** Press the **MODE** control. The Sleep icon and "OFF" will flash in the display.
- 3** Turn the **MODE** control clockwise until the number of minutes you want is displayed.
- 4** Press the **MODE** control. The brackets around the Sleep icon will flash a few times. The display will return to its previous state with the Sleep icon lit.

In this example the Sleep turn off delay is set to 30 minutes.

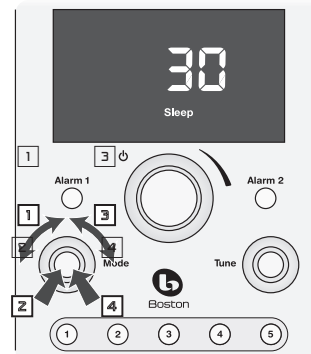

Notes:

- To cancel the Sleep delay before it has finished press the **POWER/VOLUME** control to turn off the Duo.

Other Control Settings

Display Information

When you adjust the controls or settings of the Duo the display shows information and symbols related to what you are doing. After a few seconds the display goes back to showing the time or the source you are listening to. You can select which of the default displays you want.

Using the Front Panel Controls

- 1 Turn the **MODE** control to highlight the Info icon of the display.
- 2 Turn the **MODE** control to select the Source display or the Time display. Press the **MODE** control to set the default display.

Using the Remote Control

Press the **INFO** button to switch between Source or Time display.

If the display default was set to show the Time the icon for the currently selected source flashes a few times. The display now defaults to show the Source.

If the display default was set to show the Source the clock icon flashes a few times. The display now defaults to show the Time. Note that the icon for the current source displays in addition to the time.

In the example shown above the default display is set to Time and the source is FM1.

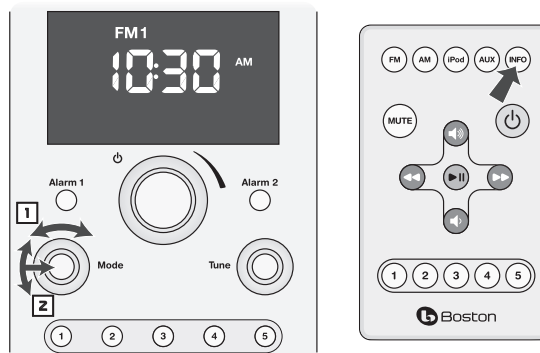

Display Brightness

The display brightness varies automatically with changing light conditions. In addition the overall range of the display brightness can be adjusted to suit personal preference.

- 1 Turn the **MODE** control to highlight the Brightness icon.
- 2 Press the **MODE** control. The Brightness icon and the current brightness setting will flash.
- 3 Turn the **MODE** control to adjust the brightness setting. The setting can range from 1 – 20.
- 4 Press the **MODE** control again to set the new display brightness setting. The brackets around the Brightness icon flash a few times. Then the display reverts to its previous state.

In this example the brightness is set to 12.

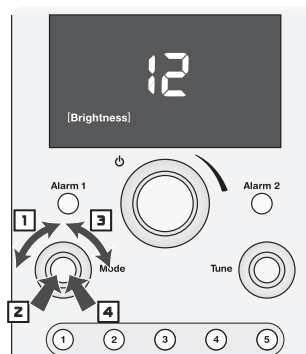

Connecting Other Equipment

Connecting Headphones

Connect the headphone plug to the jack beside the  symbol. This turns off the Duo internal speakers. If your headphones have a 1/4-inch plug you will need an adapter.



Using Aux Inputs

Other audio equipment, such as a portable CD player, can be connected to the Duo through the Aux inputs. The Aux 1 input on the front panel has an 1/8-inch jack. The Aux 2 input on the rear panel uses two RCA jacks. The right and left channel jacks are color coded red and white respectively. Select the Aux 1 or Aux 2 input using the **MODE** control as described in the "Selecting a Source" section of this manual.

The HRD-i - iPod Docking Adapter

With the optional HRD-i docking adapter you can use your iPod as a music source for general playback or to wake to music when using the alarm clock function. If your iPod can store video tracks you can watch them on an external television when it is docked to the HRD-i.

Connecting the HRD-i

Connect one end of the supplied cable to the output connector beside the  symbol on the rear of the HRD-i. Connect the other end to the input on the rear of the Duo below the  symbol. To play video tracks stored on your iPod connect a standard RCA plug cable between the output on the back of the HRD-i beside the  symbol and the composite input of your television. Typically the composite video input of a television is color coded yellow. Refer to the manual for your television for information on this input and how to use it.

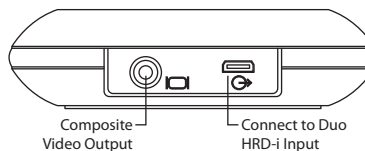

The HRD-i is supplied with seven docking adapters. These fit in the docking well of the HRD-i to support various iPod models. The table below lists the iPod models and the docking adapters to use with them. The number of the docking adapter is molded into the back of the part. Place the appropriate adapter in the docking well and plug your iPod into the dock.

iPod Model (Capacity)	Adapter Number
iPod photo (40 / 60GB), iPod with color display (60GB)	7
iPod nano (2 / 4GB)	8
5G and U2 iPod (30 GB with video), iPod classic (80GB)	9
5G iPod with video (60GB / 80GB), iPod classic (160GB)	10
iPod nano - 2nd generation (2 / 4 / 8GB)	11
iPod nano - 3rd generation (4 / 8GB)	13
iPod touch 8GB & 16GB	14

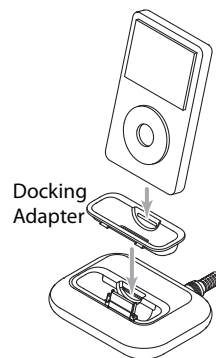

Selecting the iPod Source

Using the Front Panel Controls

- 1 Turn the **MODE** control until the iPod icon is highlighted with brackets.
- 2 Press the **MODE** control to select the iPod source. Or just wait a few seconds and the iPod is automatically selected.

Using the Remote Control

Press the iPod button

Note:

- The iPod source can be selected only when your iPod is in the dock.

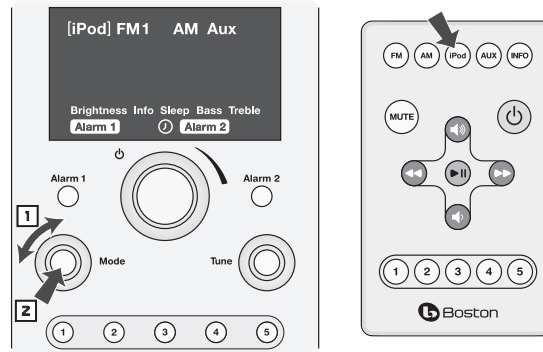

Front Panel Control iPod Operation

- 1 Press the **TUNE** button to start or pause playback of the selected track.
- 2 Turn the **TUNE** control to skip forward or back one or more tracks.
- 3 Press, hold and turn the **TUNE** button to start fast forward or rewind. Press the **TUNE** button again to stop fast forward or rewind and resume playback.

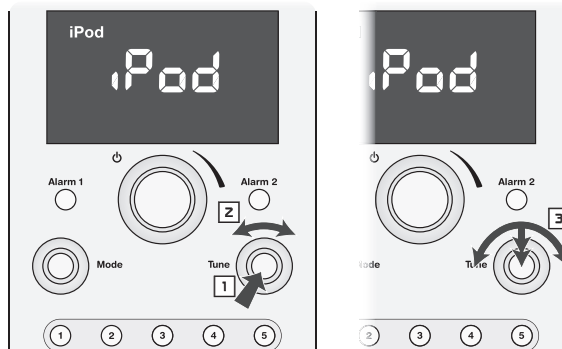

Remote Control iPod Operation

- 1 Press the **II ►** button to play or pause the iPod.
- 2 Press the **◀◀** or **►►** button to skip back or forward one track.
- 3 Press and hold the **◀◀** or **►►** button to start fast forward or rewind.

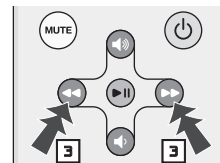
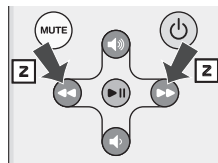
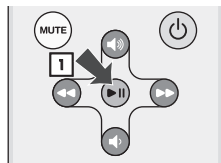

About Clock Memory

When power to the Duo is interrupted a special power component called a "super-cap" will keep the clock functions active for a period of 24-48 hours. If the Duo is without power for a longer period of time you may need to reset the clock when power is restored.

Security Cable Connection

There is a security cable connection point on the rear of the Duo to the right of the power input connector. This is the same as the connection point found on most laptop computers. Connect a computer security cable between the Duo and a solid anchor point to help prevent theft of your Duo.

Service Port

The Service port on the rear panel is for use only qualified service technician.

Maintenance and Service

The Duo enclosures may be cleaned using a soft cloth to remove fingerprints or to wipe off dust. All wiring connections should be inspected and remade at least once a year.

In the event that your speakers ever need service, contact your local Boston Acoustics dealer or visit www.bostonacoustics.com/dealers for a list of dealers in your area.

Limited Warranty

Boston Acoustics warrants to the original purchaser of the Horizon Duo that it will be free of defects in materials and workmanship in its mechanical parts for a period of one year from the date of purchase.

Your responsibilities are to install and use the Duo according to the instructions supplied, to provide safe and secure transportation to an authorized Boston Acoustics service representative, and to present proof of purchase in the form of your sales slip when requesting service.

Excluded from this warranty is damage that results from abuse, misuse, improper installation, accidents, shipping, or repairs/modifications by anyone other than an authorized Boston Acoustics service representative.

This warranty is limited to the Boston Acoustics product and does not cover damage to any associated equipment. This warranty does not cover the cost of removal or reinstallation. This warranty is void if the serial number has been removed or defaced. This warranty gives you specific legal rights, and you may also have other rights which vary from state to state.

If Service Seems Necessary

First, contact the dealer from whom you purchased the product. If that is not possible, write to:

Boston Acoustics, Inc.
300 Jubilee Drive
Peabody, MA 01960 USA

Or contact us via e-mail at:

US: support@bostona.com

Japan: ba_info@dm-holdings.com

Asia Pacific: service@dm-singapore.com

We will promptly advise you of what action to take. If it is necessary to return your Horizon Duo to the factory, please ship it prepaid. After it has been repaired, we will return it freight prepaid in the United States and Canada.



For EU Customers Only

This symbol found on the product indicates that the product must not be disposed of with household waste. Instead, it may be placed in a separate collection facility for electronic waste or returned to a retailer when purchasing similar product. The producer paid to recycle this product. Doing this contributes to reuse and recycling, minimizes adverse effects on the environment and human health and avoids any fines for incorrect disposal.

Free Manuals Download Website

<http://myh66.com>

<http://usermanuals.us>

<http://www.somanuals.com>

<http://www.4manuals.cc>

<http://www.manual-lib.com>

<http://www.404manual.com>

<http://www.luxmanual.com>

<http://aubethermostatmanual.com>

Golf course search by state

<http://golfingnear.com>

Email search by domain

<http://emailbydomain.com>

Auto manuals search

<http://auto.somanuals.com>

TV manuals search

<http://tv.somanuals.com>