

Boston GT-20 GT-22

2-Channel, High-Current/High-Power Amplifiers

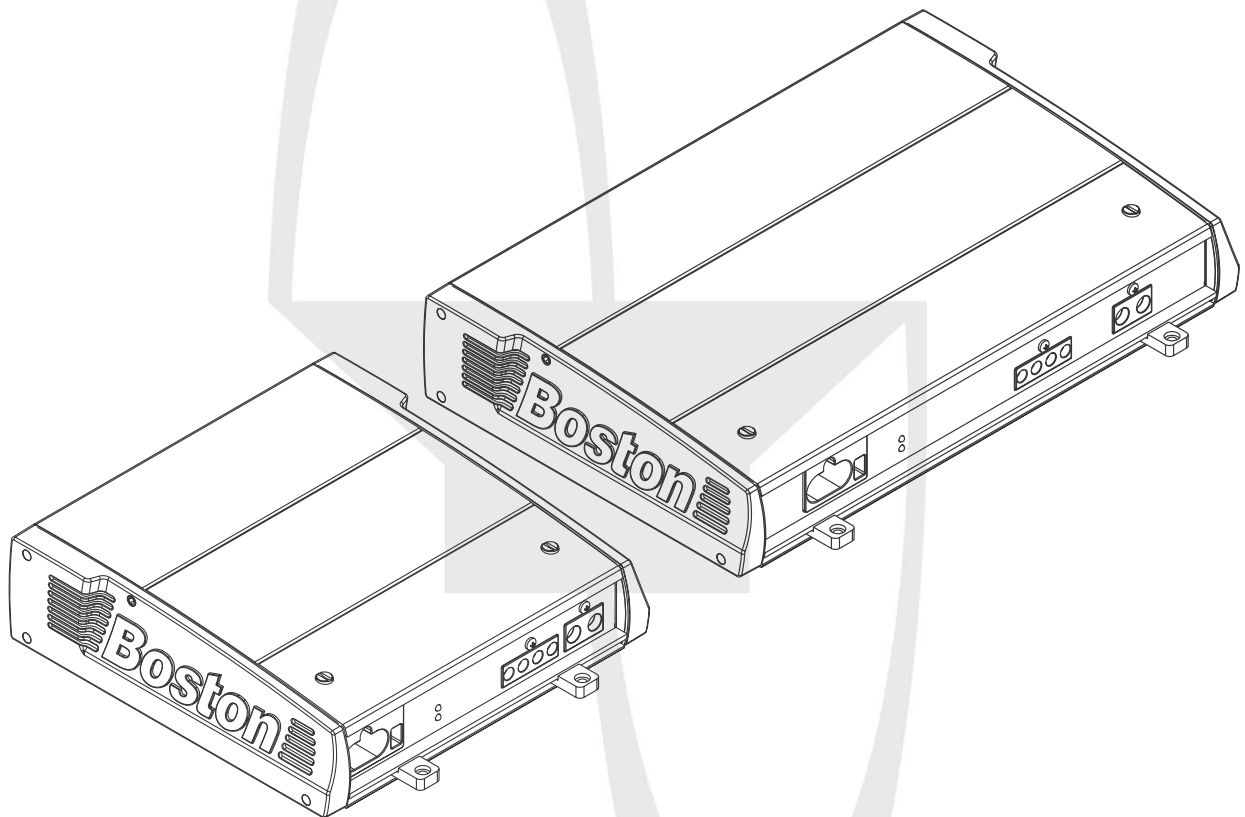

Boston
Boston Acoustics

Table of Contents

Parts List	3
Features and Specifications	3
Control Functions	4
Control functions (cont.)	5
Mechanical Functions	6
Recessed RCA inputs	6
Control cover removal & reinstallation	6
Multi-position mounting feet	6
Vents (side & rear)	6
Mechanical functions (cont.)	7
Amplifier linking	7
Wire connection	7
Fuses	7
General Installation Precautions	8
Before you install	8
Battery & charging system	8
Wire routing	8
Installation—Amplifier Mounting	9
Choose the mounting location	9
Height, width, and depth diagrams	9
Installation—amplifier mounting (cont.)	10
Passenger & trunk compartment mounting	10
Installation—Fuses & Wiring	10
Amplifier fuses	10
Wire gauge	10
Installation—fuses & wiring (cont.)	11
Power/B+ & power/ground (GND) connection	11
Remote input connection	11
Speaker output connection	11
Installation—fuses & wiring (cont.)	12
Mono subwoofer operation	12
Setup Tuning—Full-range Speakers	12
Music	12
Sensitivity controls	12
Highpass & lowpass crossover controls	12
Setup tuning—full-range speakers (cont.)	13
Head unit	13
Volume	13
Input sensitivity control	13
Crossover controls	13
Setup tuning—full-range speakers (cont.)	14
“Q” control	14
Setup Tuning—Rear Fill Speakers	14
Setup Tuning—Subwoofers	14
Input switch	14
Setup tuning—subwoofers (cont.)	15
Head unit	15
Volume	15
Input sensitivity control	15
Lowpass crossover control	15
Phase	15
System Examples	16,17
Amplifier Troubleshooting Guide	18
Contact and Warranty Information	19

Parts List

Included Hardware: GT-20 & GT-22

- (1) owner's manual
- (1) female quick-connect terminal
- (1) 2mm hex wrench (for speaker input)
- (1) 3mm hex wrench (for power input)
- (4) mounting screws

Features and Specifications

GT-20 & GT-22 Features

2-Channel, High-Current Amplifier	Continuously Variable Crossover and Q-factor Settings
2Ω Mono Operation	Selectable Highpass, Lowpass, and Bandpass Settings
Power Increase with Input Voltage Rise	Bandpass Configurable for Midbass or Subwoofer
Advanced Cooling Allows Varied Mounting Positions	Terminals Accept Bare, Heavy-Gauge Wire
Adjustable Feet for Varied Mounting Surfaces	Screw-Down Security Cover Protects Tuning Controls

Technical Specifications

	GT-20	GT-22
14.4VDC Power		
@ 4 Ohms	2x55W	2x100W
@ 2 Ohms	2x100W	2x175W
@ 4 Ohms (mono)	1x200W	1x350W
@ 2 Ohms (mono)	1x250W	1x500W
12.6VDC Power		
@ 4 Ohms	4x45W	2x75W
@ 2 Ohms	2x80W	2x135W
@ 4 Ohms (mono)	1x165W	1x275W
@ 2 Ohms (mono)	1x220W	1x375W
Frequency Response (-3dB)	10Hz-95kHz	10Hz-95kHz
Signal-to-Noise Ratio (A Weighted)	>100dB	>100dB
Dimensions (HxWxD)	2 ¹ / ₄ x7 ¹ / ₈ x8 ⁷ / ₈ " (57x200x225mm)	2 ¹ / ₄ x12 ¹ / ₈ x8 ⁷ / ₈ " (57x308x225mm)

Control Functions

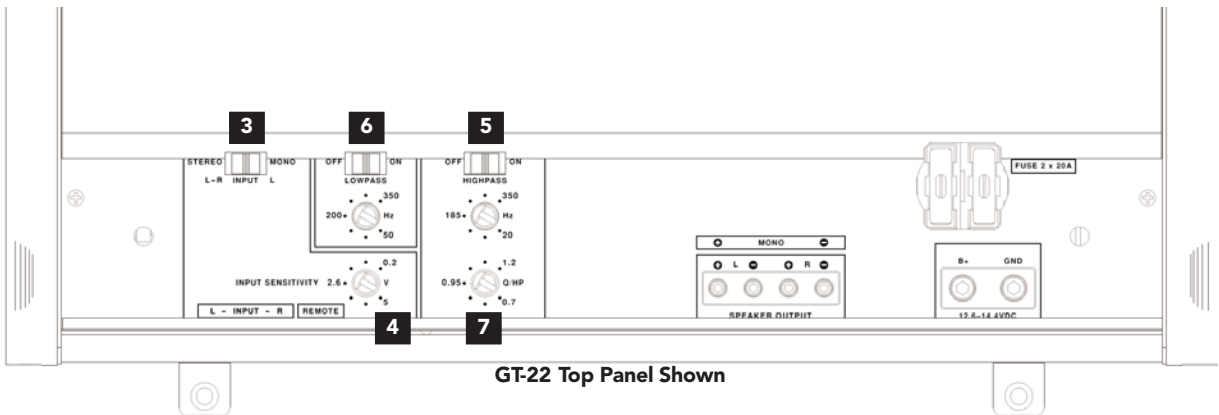

① RCA Inputs

RCA cables from head unit or from other line level device should be connected here. Use both inputs (L & R) for stereo; use "L" input for mono.

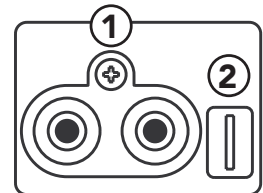

② Remote Input

Use the supplied FEMALE quick-connector to connect the REMOTE trigger lead from the head unit to the amplifier. Amplifier turns "ON" when head unit is turned "ON." One FEMALE .210" connector is supplied with amplifier.

③ Input Switch

In the left position, the L & R inputs go to the L & R channels of the amplifier. In the right position, the input is for mono operation.

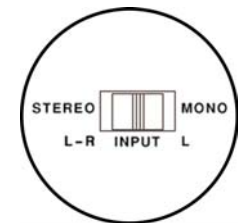

④ Input Sensitivity Control

Turn control clockwise to increase the amplifier sensitivity to incoming signals. Turn control counterclockwise to decrease the amplifier sensitivity.

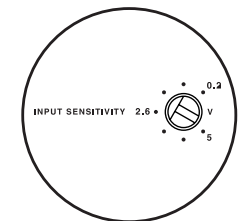

⑤ Highpass Crossover Controls

To use 12dB/octave crossover, move switch to right-hand position. Highpass crossover frequency is adjustable from 20Hz to 350Hz by rotary control. (Moving switch to left-hand position will bypass crossover functions.)

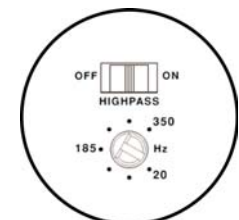

Control Functions (cont.)

⑥ Lowpass Crossover Controls

To use 12dB/octave crossover, move switch to right-hand position. Lowpass crossover frequency is adjustable from 50Hz to 350Hz by rotary control. (Moving switch to left-hand position will bypass crossover functions.)

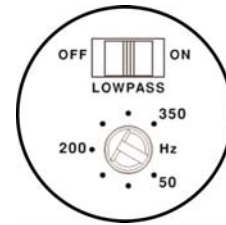

⑦ "Q" Control

The "Q" Control is active when the highpass crossover is engaged and is centered on the selected crossover point. The range of operation is 0.7–1.2.

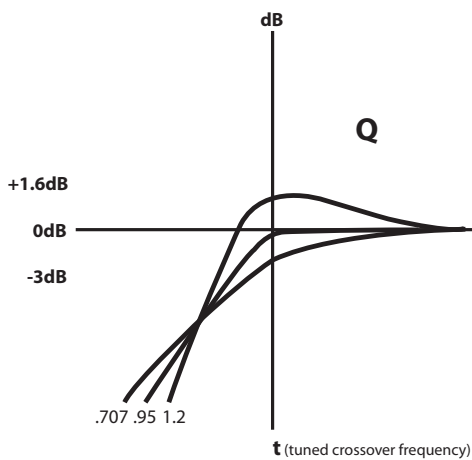
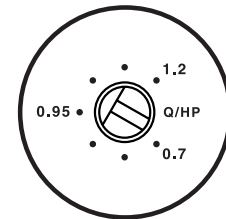

⑧ Status LED Indicators

GREEN indicates the normal operating condition; the amplifier is "ON." GREEN and RED together are normal when the amplifier is first turned "ON"; RED will turn off after a few seconds. When both GREEN and RED remain on, the amplifier is in thermal shutdown condition. RED only indicates a fault condition, "SAFE."

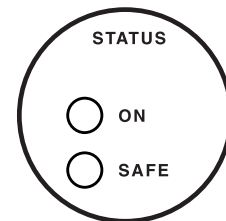

Mechanical Functions

Recessed RCA Inputs

The input jacks are recessed into the body of the amplifier to provide clearance in tight mounting locations.

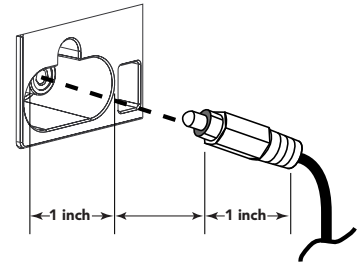

Control Cover Removal & Reinstallation

The cover panel is secured with two (2) captive coin-slotted screws. Coin-slotted screws allow a coin edge to be used as a screwdriver to remove the panel.

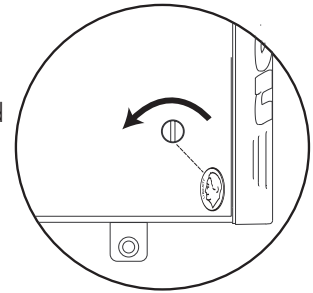

Multi-position Mounting Feet

The mounting feet are designed to slide in both directions to clear installation obstructions on the mounting surface.

WARNING! Before driving the mounting screws through any surface, be sure of what is behind that surface. Check for the gas tank, brake lines, and any vehicle wiring harness.

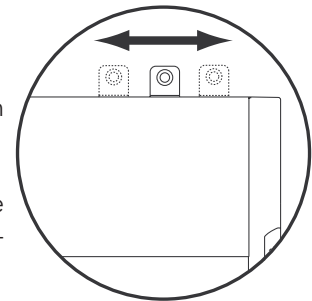

Vents (Side & Rear)

The cooling vents must be kept clear of obstructions once the amplifier is installed. Failure to do this could lead to premature thermal shutdown or amplifier failure.



Mechanical Functions (cont.)

Amplifier Linking

The design of the side panels enables multiple amplifiers to be used together without additional hardware.

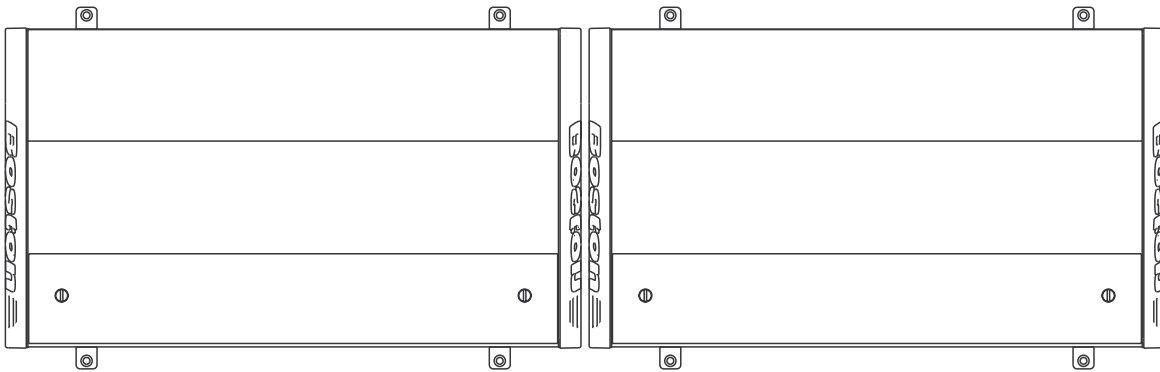

Wire Connection

Amplifier accepts stripped wire directly into the terminal blocks. Speaker outputs accept 8-gauge, and the DC power and ground accept 4-gauge. Tighten with supplied hex wrenches.

Fuses

Amplifier accepts standard AT-style automotive blade fuses.

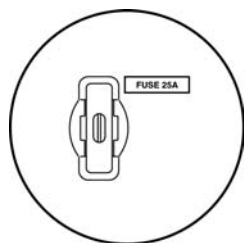

GT-20

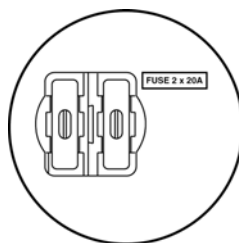

GT-22

General Installation Precautions

WARNING! Before driving the amplifier mounting screws through any surface, be sure of what is behind that surface. Check for the gas tank, brake lines, and any vehicle wiring harness. Never run wires outside or under the vehicle or where they could become broken or interfere with the safe operation of the vehicle.

Before You Install

Before you install the unit, disconnect the negative (-) battery cable in the engine compartment of the vehicle. Doing so will prevent damage to both the electrical system of the vehicle and the amplifier during installation.

Battery & Charging System

In order for the amplifier to function correctly, the electrical system of the vehicle should be professionally checked for overall electrical capacity. When used, the amplifier will increase the demand on the battery and alternator. Therefore, both should be thoroughly evaluated before installing the amplifier to ensure they are in normal operating condition and able to handle the increased demand the amplifier will present to the vehicle's electrical system.

Wire Routing

Do not run the power wire near any low-level signals or audio cables such as the RCAs from the head unit. (Noise can be introduced into the amplifier when this occurs.) It is helpful to diagram the wire layout first before any installation is attempted.

Installation—Amplifier Mounting

Choose the Mounting Location

Plan your installation so that the amplifier is mounted where adequate ventilation is available.

Never mount an amplifier in the engine compartment of a vehicle!

WARNING! Before driving the mounting screws through any surface, be sure of what is behind that surface. Check for gas tank, brake lines, and any vehicle wiring harness.

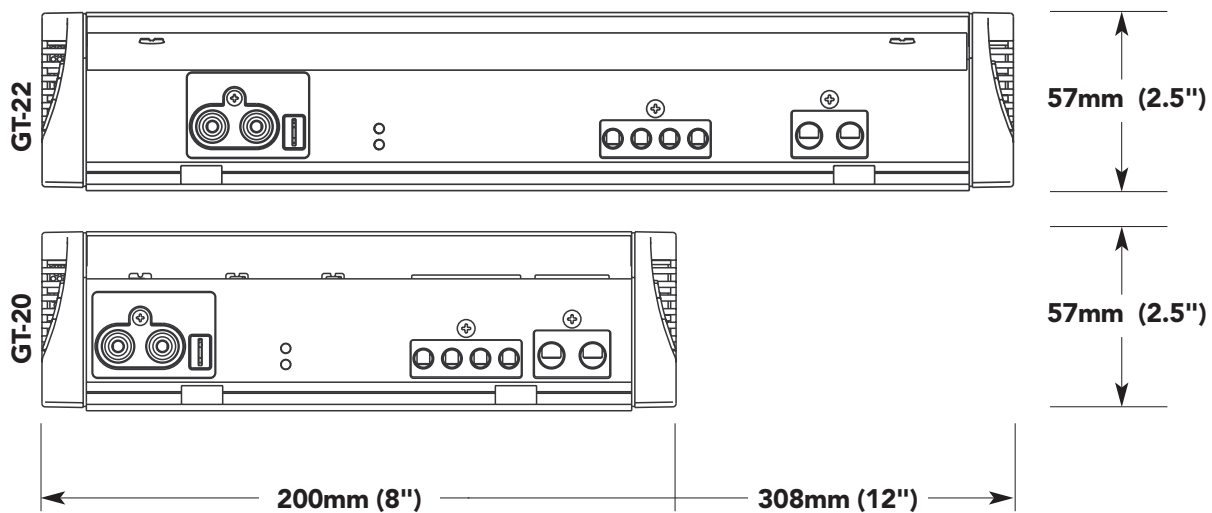
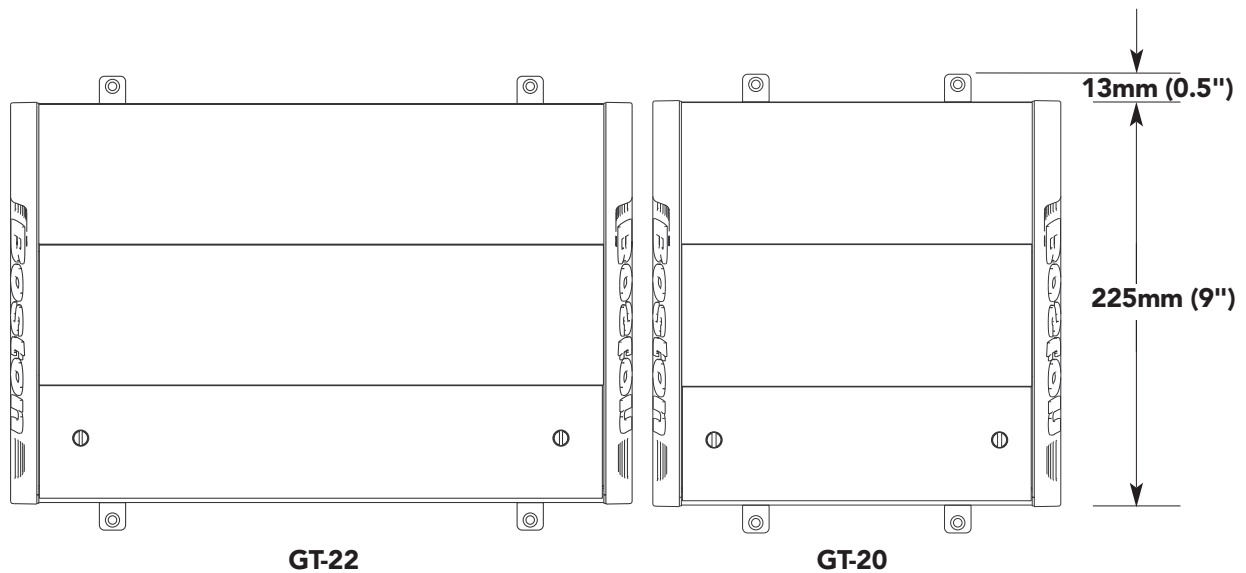

Installation—Amplifier Mounting (cont.)

Passenger & Trunk Compartment Mounting

If the amplifier is mounted under a seat, be sure that the vents do not become blocked. Do not allow seat padding or other obstructive material to press down on the amplifier.

All Boston GT amplifiers have top panel controls. If the amplifier is mounted under a seat, position the amplifier so the cover panel can be removed with the seat forward or back to allow adjustment of the audio settings.

When mounting in a trunk, choose a location that will be protected from sliding cargo or other materials. Mount the amplifier to solid surfaces only. Do not mount to plastic trim panels. Do not mount the amplifier with Velcro, double-stick tape, or by wedging into position. Amplifier should be mounted using the movable mounting feet and the provided mounting screws.

Installation—Fuses & Wiring

Amplifier Fuses

Although the amplifier has internal fuses, additional fusing should be provided at the battery on the positive (+) power wire going to the amplifier. An inline fuse should be installed at no more than 18" (46cm) on the positive (+) power wire. The rating of the inline fuse should equal the value of the internal fuses of the amplifier if only the amplifier is connected to this wire. If other devices are connected to this wire, the fuse value should be of sufficient capacity to handle the demand.

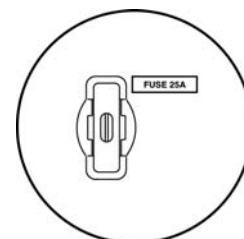

GT-20

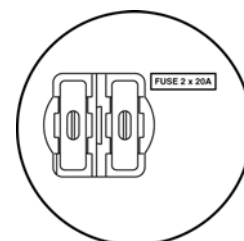

GT-22

Wire Gauge

The amplifier accepts up to 4-gauge stripped wire at the DC power and ground input terminals, and 4-gauge is recommended. Wire runs should be kept to the minimum practical length.

Installation—Fuses & Wiring (cont.)

Power/B+ & Power/GND Connection

Strip approximately $\frac{5}{8}$ " (16mm) of insulation. The positive (+) power wire is installed into the amplifier terminal marked "B+". The negative (-) wire is installed into the terminal marked "GND". The ground wire should be as short as possible and connected directly to the chassis of the vehicle. Make sure that the chassis connection point is free of rust, grease, dirt, paint, and other materials that may insulate the ground wire from making proper connection. Tighten the B+ and GND terminals with the supplied 3mm hex wrench to secure the wire into the terminals. If the power wire must be routed through a drilled or existing hole, use a nylon panel grommet to prevent fraying the wire insulation. Failure to do so could lead to an electrical short if the wire insulation is worn through and the power wire is shorted to ground.

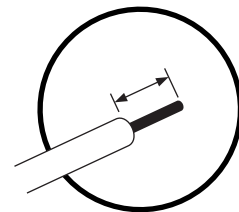

Strip $\frac{5}{8}$ " (16mm)

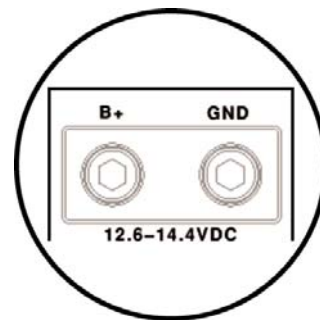

Remote Input Connection

Use the supplied FEMALE quick-connector to connect the REMOTE trigger lead from the head unit to the amplifier. Crimp connector to wire from head unit that controls remote turn-on (refer to head unit owner's manual). Once the quick-connector is crimped into place, carefully push connector onto recessed MALE REMOTE terminal adjacent to the RCA input pair. Only one (1) remote turn-on terminal should be connected.

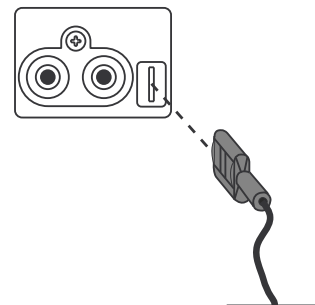

Speaker Output Connection

Prepare each wire by stripping approximately $\frac{5}{8}$ " (16mm) of insulation. The positive (+) speaker wires are installed into the amplifier terminals marked "SPEAKER OUTPUT" / "+". The negative (-) speaker wires are installed into the amplifier terminals marked "SPEAKER OUTPUT" / "-". Tighten the "SPEAKER OUTPUT", "+", and "-" terminals with the supplied 2mm hex wrench to secure the wires into the terminals. If the speaker wires must be routed through a drilled or existing hole, use a nylon panel grommet to prevent fraying the wire insulation. Failure to do so could lead to an electrical short if the wire insulation is worn through and the speaker wires are shorted to ground.

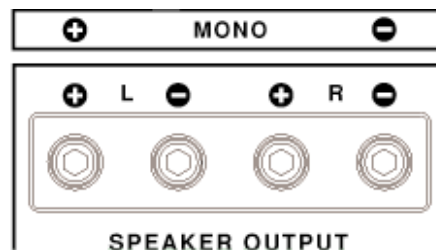

Installation—Fuses & Wiring (cont.)

Mono Subwoofer Operation

When the amplifier is configured for mono operation, use the speaker output terminals marked for mono use.

WARNING! Subwoofer impedance must not fall below 2 ohms when in MONO mode.

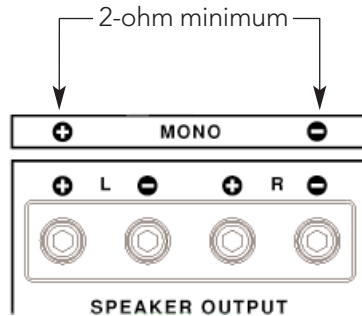

Setup Tuning—Full-range Speakers

1) Music

The material chosen for head unit/amplifier system setup must be both clear in recording quality and dynamic in amplitude. Many audiophile “test” discs have musical tracks with both of these characteristics and should be used.

2) Input Sensitivity Control

Turn control all the way counterclockwise (minimum position). In this position, the amplifier will be less sensitive to the input signal from the head unit.

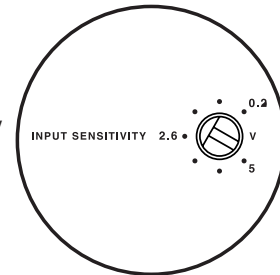

3) Highpass & Lowpass Crossover Controls

Crossovers should be turned “OFF” during this phase of setup. Move the HIGHPASS and LOWPASS switches to the “OFF” position—with these settings, full-range signal is sent to the speaker outputs. If bottoming is detected from speakers, move HIGHPASS switch to “ON” and slowly rotate clockwise until bottoming is eliminated.

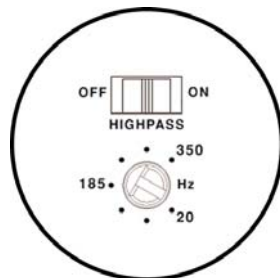

Highpass Crossover Control

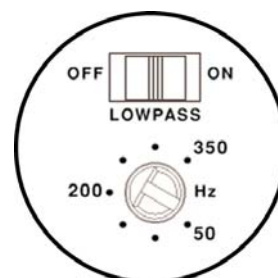

Lowpass Crossover Control

Setup Tuning—Full-range Speakers (cont.)

4) Head Unit

The head unit should have all controls such as bass, treble, balance, and fader set to the flat or centered position. The volume control should be at the minimum setting. If the head unit has any equalization or bass management features such as *boost*, they should be defeated at this time. Turn head unit on, and verify that the GREEN status LED is lit on the amplifier.

5) Volume

With the chosen musical track playing, turn the head unit volume control up until the maximum level of undistorted signal is heard from the speakers. (For most head units, this will be near the end of the volume control range.)

WARNING! A distorted signal from the head unit sent to the amplifier can cause loudspeaker failure at higher listening levels!

6) Input Sensitivity Control

Slowly rotate control clockwise until maximum undistorted playing level is heard from the speakers. Listen closely for bottoming from the speakers. If detected, rotate Input Sensitivity control counterclockwise until it is eliminated.

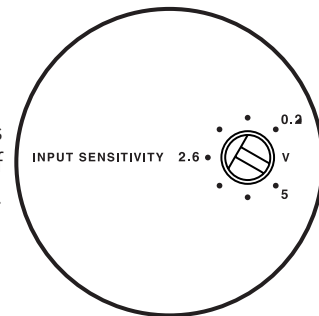

7) Crossover Controls

To achieve higher undistorted playing levels from the main speakers, the high-pass crossover must be engaged. Rotate crossover control fully clockwise. The highpass crossover point is now set at 350Hz. Rotate "Q" Control fully counterclockwise. Move crossover switch to the right (ON) position.

Slowly rotate the Input Sensitivity control clockwise until maximum undistorted playing level is heard from the speakers. Listen closely for bottoming from the speakers. If detected, rotate the input sensitivity control counterclockwise until it is eliminated. Slowly rotate the highpass crossover control counterclockwise while listening for bottoming. You are lowering the crossover point, which means that more bass signal is being sent to the speakers. If bottoming is detected, rotate the input sensitivity control counterclockwise until it is eliminated and/or rotate the high-pass crossover control clockwise to raise the crossover point.

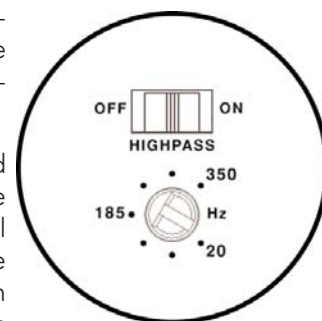

Setup Tuning—Full-range Speakers (cont.)

8) "Q" Control

Once the highpass crossover point has been determined, use the "Q" control to increase the bass information centered around the crossover point.

Setting the "Q" control is done in conjunction with setting the levels on the input sensitivity and highpass crossover frequency controls. You may find while setting the "Q" that bottoming may be detected in the front speakers; lowering the "Q" input sensitivity or raising the highpass crossover point will eliminate this. Minor adjustments to each setting are required to fine-tune the system.

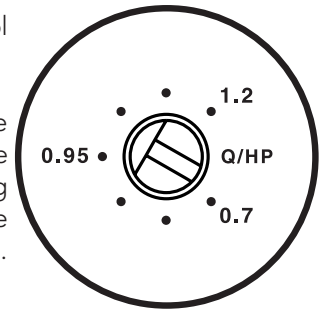

Setting the "Q" is a subtle process. It is recommended that the "Q" setting be left in the 0.7 position and adjusted only after the input sensitivity and highpass crossover ranges are known. Small adjustments to the "Q" setting are all that are required to fine-tune the system.

Setup Tuning—Rear Fill Speakers

You may set the channels for summed mono operation from the L & R RCA inputs by setting the INPUT switch to the right-hand, MONO, position and then connecting the L & R REAR loudspeakers normally as you would for regular stereo operation. This configuration is beneficial for rear fill in some applications.

Setup Tuning—Subwoofers

1) Input Switch

Move switch to the right-hand (MONO) position; the inputs are summed to mono. Connect the subwoofer to the SPEAKER OUTPUT terminals marked for MONO operation. NOTE: Subwoofer impedance is 2 ohms minimum.

Setup Tuning—Subwoofers (cont.)

2) Head Unit

The head unit should have all controls such as bass, treble, balance, and fader set to the flat or centered position. The volume control should be at the minimum setting. If the head unit has any equalization or bass management features such as *boost*, they should be deactivated at this time. Turn head unit on, and verify that the GREEN status LED is lit on the amplifier.

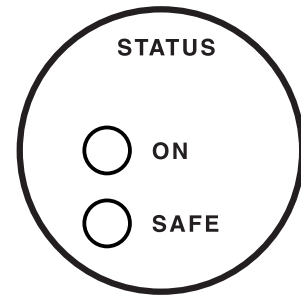

3) Volume

With the chosen musical track playing, turn the head unit volume control up until the maximum level of undistorted signal is heard from the speakers. For most head units, this will be at the end of the volume control range.

WARNING! A distorted signal from the head unit sent to the amplifier can cause loudspeaker failure at higher listening levels!

4) Input Sensitivity Control

Turn control all the way counterclockwise (minimum position). In this position, the amplifier will be less sensitive to the input signal from the head unit. Slowly rotate this control clockwise until maximum undistorted playing level is heard from the subwoofer(s). Listen closely for faults such as bottoming from the subwoofer(s). If fault is detected, rotate Input Sensitivity control counterclockwise until fault is eliminated. At this point, the maximum undistorted subwoofer playing level has been defined.

5) Lowpass Crossover Control

Move the selector switch to "ON." In this setting, lowpass signal is sent to the speaker outputs. Experiment with the crossover point settings while the subwoofer is active. A higher setting will increase the perceived output, and a lower setting will make the bass response more omnidirectional. Find the balance between the two that works best for the vehicle.

6) Phase

Subwoofer phase is relative to the front loudspeakers. Correct electrical phase does not always mean correct acoustic phase. Swap positive (+) and negative (-) connections at the speaker outputs where the subwoofer is connected to the amplifier. It is beneficial to listen to the subwoofer connected in both phase conditions. The subwoofer should be left in the condition in which the strongest bass response is noted.

System Examples

System A—Full-range Front Speakers

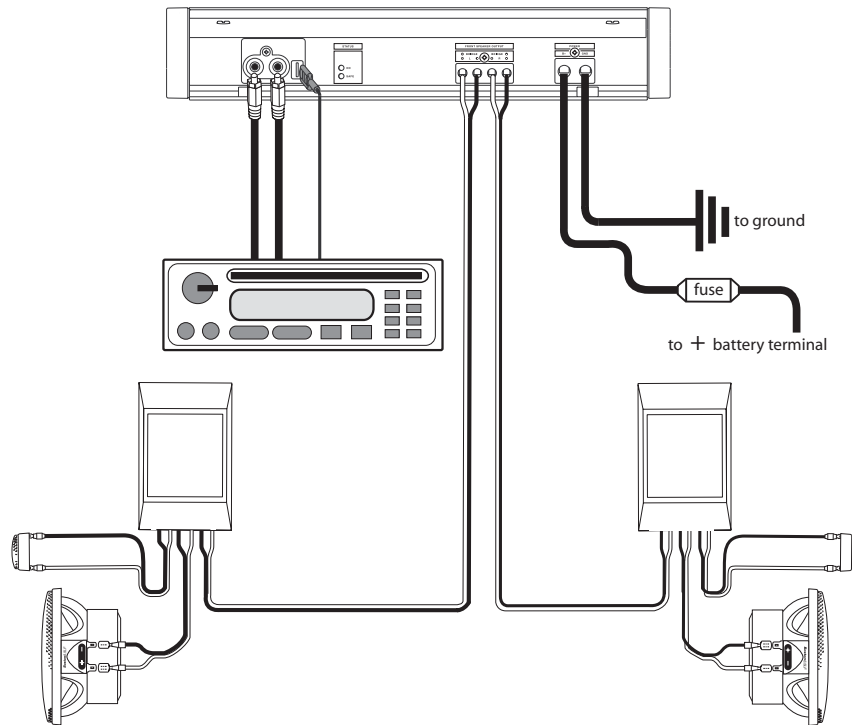

System B—Rear Fill Speakers

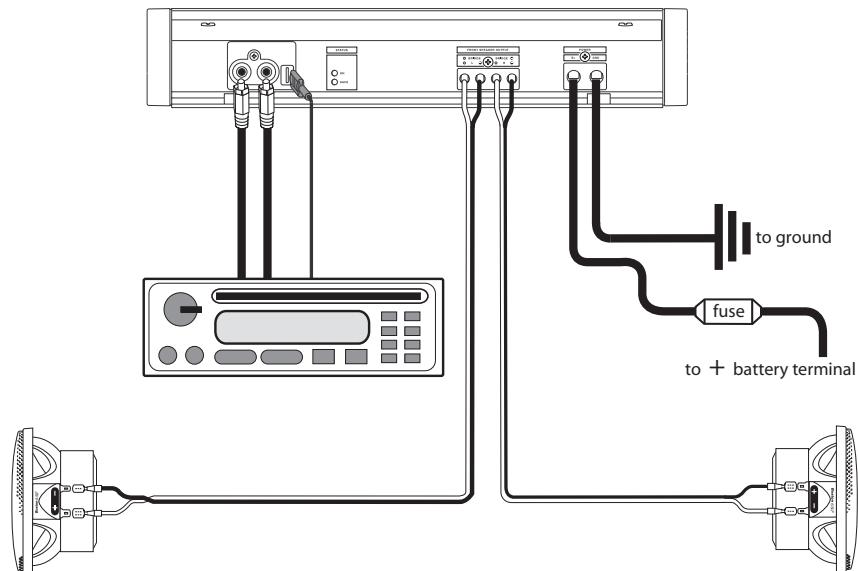

System Examples (cont.)

System C—Single Subwoofer (2Ω)

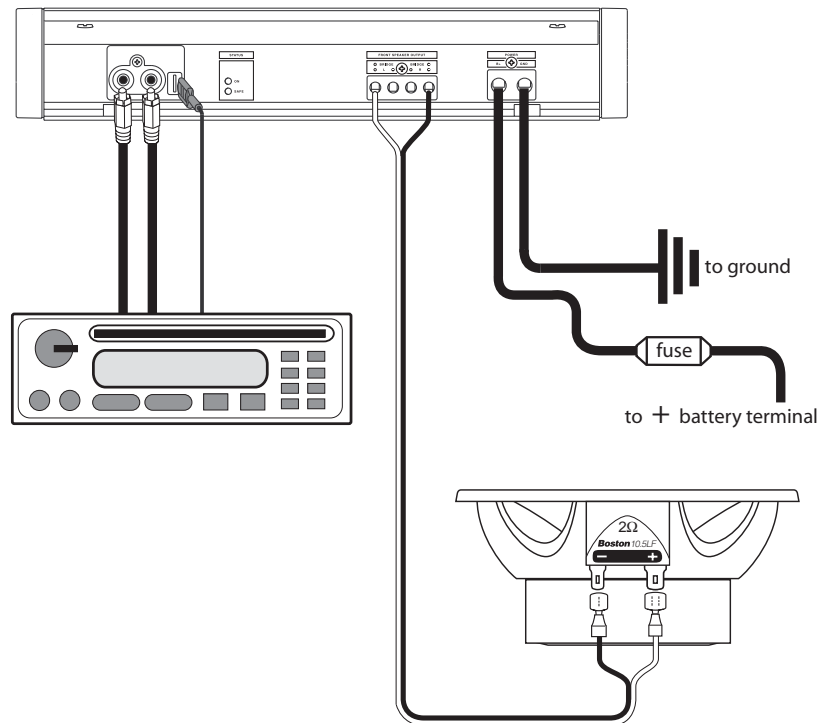

System D—Parallel 4Ω Subwoofers (2Ω load)

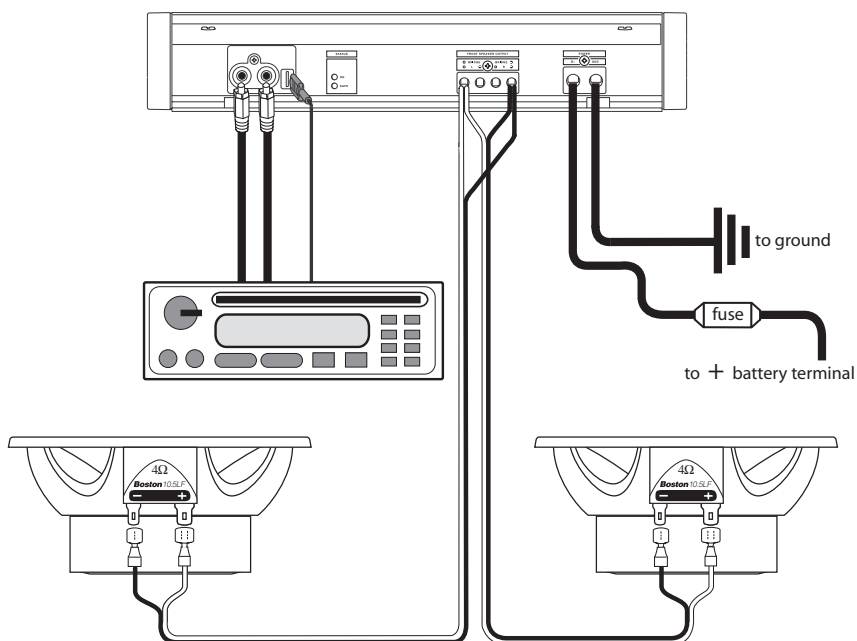

Amplifier Troubleshooting Guide

Status LEDs on Amplifier not Lit—Head Unit (Source) Turned "ON"

- Verify Remote turn-on wire from source to amplifier has proper voltage
Power (B+) connections at amplifier, terminal blocks, and battery are secure
Ground (GND) connections at amplifier and vehicle chassis are secure
Battery B+ fuse is OK
Amplifier fuse is OK
B+ at battery and B+ at amplifier have proper voltage

Status LEDs Lit, no Output from Speakers—Speakers in Normal Operating Condition

- Verify High-level cables from speaker(s) to amplifier are securely connected
RCA cables from amplifier to source are securely connected
Sensitivity adjustment on amplifier is correctly adjusted

Engine Noise from Speaker(s)

- Turn source "OFF"
 Disconnect RCA cables at amplifier
 If noise stops, check equipment and cables leading to amplifier
- Verify RCA cables are of good quality with no breakage to internal shields
RCA cables from source to amplifier are not run alongside power

Amplifier Output Distorted—Music not Recorded with Intentional Distortion

- Verify Source output to amplifier is not distorted
Amplifier input sensitivity is correctly adjusted

Amplifier Shutting Down, Red and Green LEDs Lit—Amplifier in Thermal Protection Mode

- Verify Amplifier is mounted with adequate air circulation around vents
Amplifier does not have obstructions blocking back or side panel vents
Amplifier is not mounted under carpet
Speakers meet correct impedance for application (mono or stereo hookup)

Amplifier not Turning "ON", Red LED Lit—Amplifier not Connected to a Shorted Speaker

- Verify Speaker crossover is not defective
High-level cables from speaker to amplifier are not shorted

Amplifier not Turning "ON", Red LED Lit—Speakers, Crossovers, and Cable OK

- Amplifier requires service

Contact and Warranty Information

Limited Warranty (US)

For one (1) year from the date of purchase, Boston Acoustics will repair for the original owner any defect in materials or workmanship that occurs in normal use, without charge for parts and labor—when purchased from an authorized Boston Acoustics retailer.

If an authorized Boston Acoustics retailer installs your amplifier, the warranty will be extended one (1) additional year. Installation of the amplifier must be noted on the original purchase receipt. The receipt must be presented at the time a warranty claim is made.

Your responsibilities are to use the system according to the instructions supplied, to provide safe and secure transportation to an authorized Boston Acoustics service representative, and to present proof of purchase in the form of your sales slip when requesting service.

Excluded from this warranty is damage that results from abuse, misuse, accidents, shipping, or repairs or modifications by anyone other than an authorized Boston Acoustics service representative.

This warranty is void if the serial number has been removed or defaced.

This warranty gives you specific legal rights, and you may also have other rights that vary from state to state.

If Service Seems Necessary

First, contact the dealer from whom you purchased the amplifier. If that is not possible, write to:

Boston Acoustics, Inc., 300 Jubilee Drive, Peabody, MA 01960 U.S.A.,
or your authorized Boston Acoustics distributor

We will promptly advise you of what action to take. If it is necessary to return your unit to the factory, please ship it pre-paid. After it has been repaired, we will return it freight prepaid in the U.S.A. and Canada.

Boston
Boston Acoustics

www.bostonacoustics.com

300 Jubilee Drive
Peabody, MA 01960 U.S.A.
(978) 538-5000

Boston, Boston Acoustics, and the Boston logo are registered trademarks of Boston Acoustics, Inc.

© 2003 Boston Acoustics, Inc. All rights reserved.
Specifications subject to change without notice.

P/N 042-001565-2

Free Manuals Download Website

<http://myh66.com>

<http://usermanuals.us>

<http://www.somanuals.com>

<http://www.4manuals.cc>

<http://www.manual-lib.com>

<http://www.404manual.com>

<http://www.luxmanual.com>

<http://aubethermostatmanual.com>

Golf course search by state

<http://golfingnear.com>

Email search by domain

<http://emailbydomain.com>

Auto manuals search

<http://auto.somanuals.com>

TV manuals search

<http://tv.somanuals.com>