



The Bose® Lifestyle® Powered Speaker System

Owner's Guide

December 20, 2001

AM262842_00_V.pdf

 **WARNING:** To reduce the risk of fire or electric shock, do not expose the system to rain or moisture.



These CAUTION marks are located on the back panel of your Lifestyle® powered speaker system:



The lightning flash with arrowhead symbol, within an equilateral triangle, is intended to alert the user to the presence of uninsulated dangerous voltage within the system enclosure that may be of sufficient magnitude to constitute a risk of electric shock.



The exclamation point within an equilateral triangle, as marked on the system, is intended to alert the user to the presence of important operating and maintenance instructions in this owner's guide.

 **CAUTION:** To prevent electric shock, match wide blade of plug to wide slot, insert fully.

 **CAUTION:** No naked flame sources, such as lighted candles, should be placed on the apparatus.

Additional safety information

See the additional instructions on the *Important Safety Information* page enclosed with this owner's guide.

Please read this owner's guide

Please take the time to follow this owner's guide carefully. It will help you set up and operate your Lifestyle® powered speaker system properly. Save your owner's guide for future reference.

Important Safety Instructions

1. **Read these instructions** – for all components before using this product.
2. **Keep these instructions** – for future reference.
3. **Heed all warnings** – on the product and in the owner's guide.
4. **Follow all instructions.**
5. **Do not use this apparatus near water or moisture** – Do not use this product near a bathtub, washbowl, kitchen sink, laundry tub, in a wet basement, near a swimming pool, or anywhere else that water or moisture are present.
6. **Clean only with a dry cloth** – and as directed by Bose® Corporation. Unplug this product from the wall outlet before cleaning.
7. **Do not block any ventilation openings. Install in accordance with the manufacturer's instructions** – To ensure reliable operation of the product and to protect it from overheating, put the product in a position and location that will not interfere with its proper ventilation. For example, do not place the product on a bed, sofa, or similar surface that may block the ventilation openings. Do not put it in a built-in system, such as a bookcase or a cabinet that may keep air from flowing through its ventilation openings.
8. **Do not install near any heat sources, such as radiators, heat registers, stoves or other apparatus (including amplifiers) that produce heat.**
9. **Do not defeat the safety purpose of the polarized or grounding-type plug. A polarized plug has two blades with one wider than the other. A grounding-type plug has two blades and a third grounding prong. The wider blade or third prong are provided for your safety. If the provided plug does not fit in your outlet, consult an electrician for replacement of the obsolete outlet.**
10. **Protect the power cord from being walked on or pinched, particularly at plugs, convenience receptacles, and the point where they exit from the apparatus.**
11. **Only use attachments/accessories specified by the manufacturer.**
12. **Use only with the cart, stand, tripod, bracket or table specified by the manufacturer or sold with the apparatus. When a cart is used, use caution when moving the cart/apparatus combination to avoid injury from tip-over.**
13. **Unplug this apparatus during lightning storms or when unused for long periods of time** – to prevent damage to this product.
14. **Refer all servicing to qualified service personnel. Servicing is required when the apparatus has been damaged in any way: such as power-supply cord or plug is damaged; liquid has been spilled or objects have fallen into the apparatus; the apparatus has been exposed to rain or moisture, does not operate normally, or has been dropped** – Do not attempt to service this product yourself. Opening or removing covers may expose you to dangerous voltages or other hazards. Please call Bose to be referred to an authorized service center near you.
15. **To prevent risk of fire or electric shock, avoid overloading wall outlets, extension cords, or integral convenience receptacles.**
16. **Do not let objects or liquids enter the product** – as they may touch dangerous voltage points or short-out parts that could result in a fire or electric shock.
17. **See product enclosure for safety related markings.**

Information about products that generate electrical noise

If applicable, this equipment has been tested and found to comply with the limits for a Class B digital device, pursuant to Part 15 of the FCC rules. These limits are designed to provide reasonable protection against harmful interference in a residential installation. This equipment generates, uses, and can radiate radio frequency energy and, if not installed and used in accordance with the instructions, may cause harmful interference to radio communications. However, this is no guarantee that interference will not occur in a particular installation. If this equipment does cause harmful interference to radio or television reception, which can be determined by turning the equipment off and on, you are encouraged to try to correct the interference by one or more of the following measures:

- Reorient or relocate the receiving antenna.
- Increase the separation between the equipment and receiver.
- Connect the equipment to an outlet on a different circuit than the one to which the receiver is connected.
- Consult the dealer or an experienced radio/TV technician for help.

Note: *Unauthorized modification of the receiver or radio remote control could void the user's authority to operate this equipment.*

This product complies with the Canadian ICES-003 Class B specifications.



Important Safety Instructions

18. **Use proper power sources** – Plug the product into a proper power source, as described in the operating instructions or as marked on the product.
19. **Avoid power lines** – Use extreme care when installing an outside antenna system to keep from touching power lines or circuits, as contact with them may be fatal. Do not install external antennas near overhead power lines or other electric light or power circuits, nor where an antenna can fall into such circuits or power lines.
20. **Ground all outdoor antennas** – If an external antenna or cable system is connected to this product, be sure the antenna or cable system is grounded. This will provide some protection against voltage surges and built-up static charges.

Section 810 of the National Electrical Code ANSI/NFPA No. 70 provides information with respect to proper grounding of the mast and supporting structure, grounding of the lead-in wire to an antenna discharge unit, size of grounding conductors, location of antenna-discharge unit, connection to grounding electrodes, and requirements for the ground electrode. Refer to the antenna grounding illustration on this page.

Antenna grounding

Example of antenna grounding as per National Electrical Code, ANSI/NFPA 70.

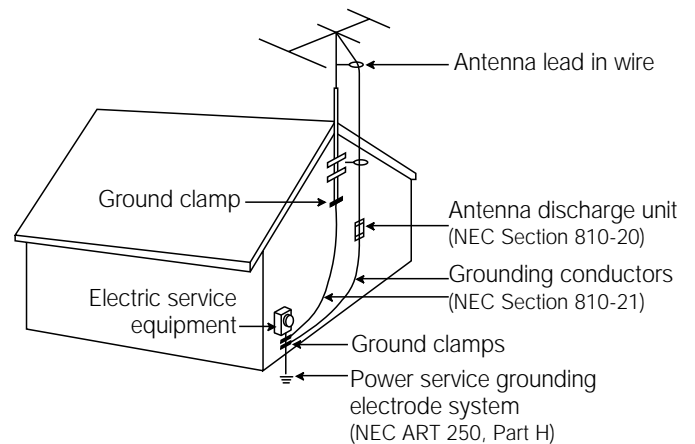

Note to CATV system installer

This reminder is provided to call the CATV system installer's attention to Article 820-40 of the NEC (of USA) that provides guidelines for proper grounding. In particular, it specifies that the cable ground shall be connected to the grounding system of the building, as close to the point of cable entry as is practical.

BOSE[®]
Better sound through research[®]

©2001 Bose Corporation,
The Mountain, Framingham, MA
01701-9168 USA
255805 AM Rev.00 JN10494

Where to find...

Setting Up

- Before you begin 4
- Unpacking the carton 4
- Selecting the locations for your Lifestyle® powered speaker system 4
- Before making connections, unplug your system 5
- Selecting the correct voltage 5
- Connecting the Lifestyle® powered speakers to each other 5

Connecting the Speakers

- Connecting the speakers to another music source 6
- Which Lifestyle® system do you own? 7
- Connecting the speakers to multi-room interface systems 8
- Connecting the speakers to the Lifestyle® media center 10
- Connecting the speakers to the Model 20 music center 12
- Connecting the speakers to the Model 5 music center 13
- Operating tips 14
- Troubleshooting 14
- Customer service 14

Product Information

- Technical information 15
- Accessories 15
- Warranty period 15
- Cleaning the Lifestyle® powered speaker system 15

Before you begin

Thank you for purchasing the Bose® Lifestyle® powered speaker system. These speakers are designed specifically for use with any Lifestyle® system to deliver high-fidelity, room-filling sound to additional rooms in your home.

Unpacking the carton

Carefully unpack your speakers. Save all packing materials for possible future use. The original packing materials provide the safest way to transport your speaker system. If any part of the product appears damaged, do not attempt to use the system. Notify Bose or your authorized Bose dealer immediately.

Check to be sure your Lifestyle® powered speaker system contains the parts identified in Figure 1.

Figure 1

What comes with your Lifestyle® powered speaker system:

- Owner's guide
- Quick set-up guide
- Powered speaker (left)
- Accessory speaker (right)
- 6-foot (attached) audio input cable
- 50-foot extension cable
- 3-foot VAR adapter cable
- 3-foot FIX adapter cable for Lifestyle® DVD systems
- Speaker wire
- Adapter plug (in dual voltage speaker systems)

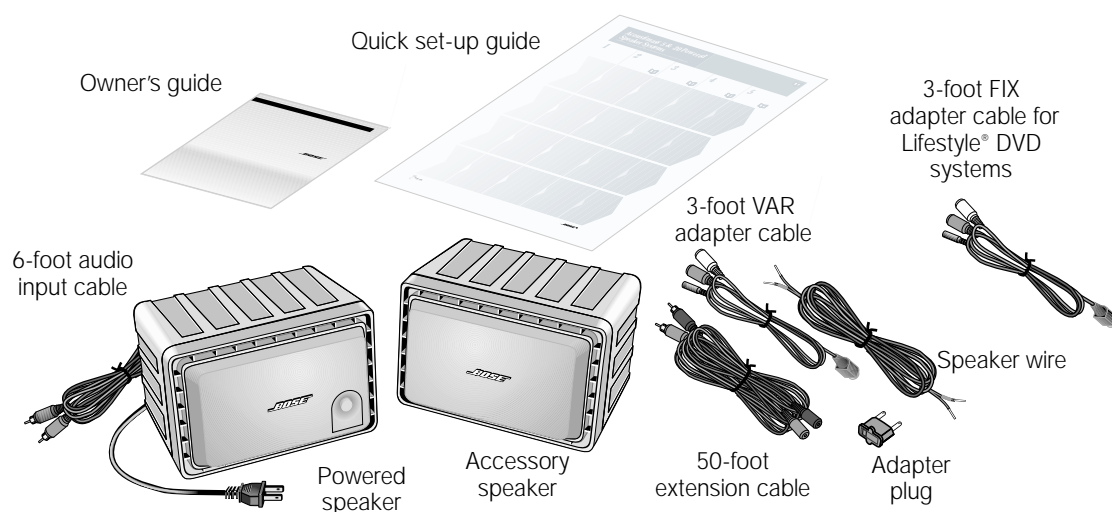

Selecting the locations for your Lifestyle® powered speaker system

Follow these guidelines to select locations for your Lifestyle® speakers:

Place the left and right speakers in their respective locations in your room. You can put these compact speakers in just about any room and location, such as a bookcase, desk, or in your kitchen. Be sure to place them close to an AC power (mains) outlet. To avoid interference with your TV picture, allow at least 9 inches (23 cm) of clearance between the speakers and the TV screen. Optional Bose ceiling and wall-mount brackets offer even greater placement flexibility. See page 15 for details.



WARNING: To avoid danger of suffocation, keep the plastic bags out of the reach of children.



CAUTION: Choose a stable and level surface for your speakers. Vibration can cause the speakers to move, particularly on smooth surfaces like marble, glass, or highly polished wood. For additional stability, you can add rubber feet to your speakers. You may obtain rubber feet (PN 178321-04) free of charge from Bose. Contact Bose customer service for more information.



Note: If you put the speakers in a bookcase unit, be sure to place each one at the front edge of the shelf. Placing speakers in an enclosed space can change the tonal quality of the sound. This effect is minimized if the shelves are filled with books.

Before making connections, unplug your system

- ⚠ CAUTION:** It is important that you unplug your Lifestyle® system or other music source before making any connections.

Selecting the correct voltage

If you purchased a dual-voltage product, please be sure that your speakers are set to the correct voltage for your geographical area. Use the adapter plug provided when appropriate.

- ⚠ CAUTION:** Make sure the voltage selector switch is set correctly on dual-voltage systems.

Figure 2

Voltage selector switch settings

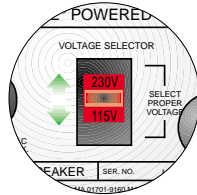

Connecting the Lifestyle® powered speakers to each other

Follow the steps below to connect your Lifestyle® powered speakers to each other:

1. Connect the speaker wire
 - The wire marked with the red collar is positive (+) and the ribbed wire is negative (-). These wires correspond respectively to the positive (red) and negative (black) terminals on the back of the speakers.
 - As illustrated in Figure 3, connect the positive and negative conductors at one end of the speaker wire to the corresponding positive and negative terminals on the LEFT speaker. Connect the other end of the wire to the RIGHT speaker. To do so, simply push down the tab at the bottom of each terminal, insert the bare end of the conductor into the hole, and release the tab to secure the wire in place.
2. Check your connections
 - Make sure the wires are connected positive to positive (+ to +) and negative to negative (- to -). Incorrect wiring will affect stereo imaging. Also, check to make sure that no strands of wire from any terminal are brushing against any other terminal. Such “bridged” wires create short circuits that may damage your Lifestyle® powered speaker system.

Figure 3

Lifestyle® powered speakers connected to each other

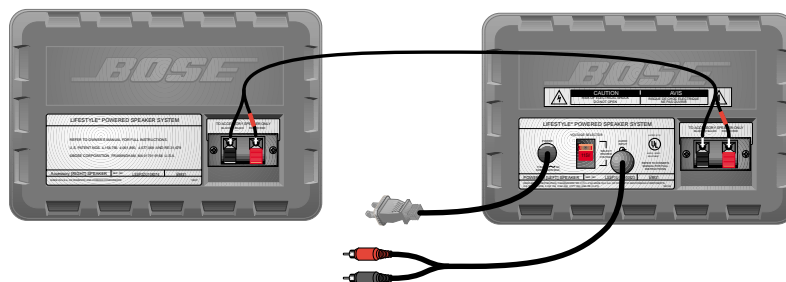

Connecting the speakers to another music source

If you will be connecting your Lifestyle® powered speaker system to a CD player, DVD player, cassette deck, or other music source, follow these instructions:

1. Unplug the music source from the AC power (mains) outlet.
2. Insert the red and black plugs from the left speaker's input cable into the left and right audio outputs of the music source (Figure 4).
3. If you wish to locate the speakers farther away from the music source, use the supplied 50-foot extension cable as follows:
 - a. Insert the red and black plugs from the powered (left) speaker's input cable into the corresponding red and black jacks on one end of the 50-foot extension cable.
 - b. Insert the red and black plugs on the other end of the extension cable into the RIGHT and LEFT outputs of the source. Portable CD players often use a 3.5 mm stereo headphone jack, instead of the RCA jacks found on larger components. If this is the case, you can use an adapter, available from your Bose® dealer.
4. Turn the volume control on the left speaker all the way down (counterclockwise). Plug the music source and the Lifestyle® powered speaker system into the AC power (mains) outlet.
5. Set the volume control to the two-o'clock position and turn on your music.

Figure 4

Connecting to another music source

AUDIO OUTPUT

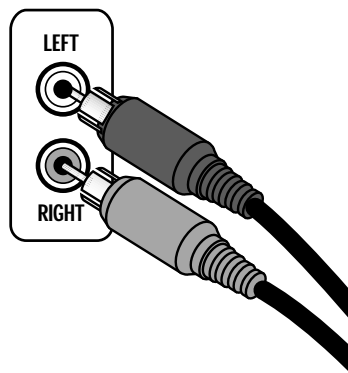

Which Lifestyle® system do you own?

If you will be connecting your Lifestyle® powered speaker system to a Lifestyle® system, you need to determine which system you own before attempting to connect the speakers.

Identifying multi-room interface systems

Figure 5

Front and rear of the multi-room interface, and Personal® music center



The multi-room interface allows you to connect up to four rooms or listening areas with additional speakers. These systems are operated using a Personal music center. To connect additional speakers to a multi-room interface, see "Connecting the speakers to multi-room interface systems" on page 8.

Identifying systems with the Lifestyle® media center

Figure 6

Front and rear of the Lifestyle® media center

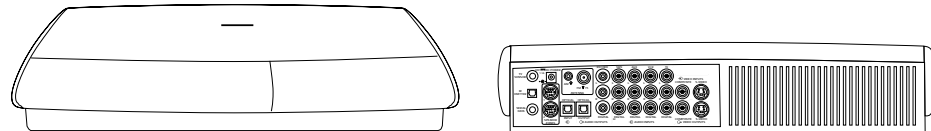

The Lifestyle® media center includes a single-disc DVD/CD player and two mini-DIN speaker output jacks on the rear panel. To connect additional speakers to the Lifestyle® media center, see "Connecting the speakers to the Lifestyle® media center" on page 10.

Identifying systems with the Model 20 music center

Figure 7

Front and rear of the Model 20 music center

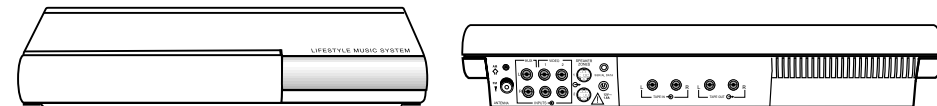

The Model 20 music center includes a six-disc CD player and two mini-DIN speaker output jacks, labeled ZONE 1 and ZONE 2, on the rear panel. To connect additional speakers to a Model 20 music center, see "Connecting the speakers to the Model 20 music center" on page 12.

Identifying systems with the Model 5 music center

Figure 8

Front and rear of the Model 5 music center

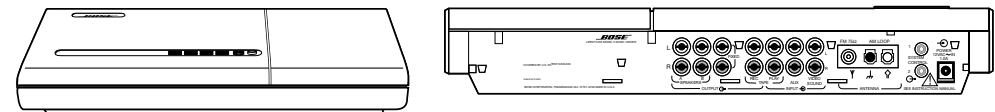

The Model 5 music center includes a single-disc CD player and three pairs of RCA speaker output jacks, labeled A, B, and FIXED, on the rear panel. To connect additional speakers to a Model 5 music center, see "Connecting the speakers to the Model 5 music center" on page 13.

Connecting the speakers to multi-room interface systems

Figure 9

Connecting the speakers to your multi-room interface

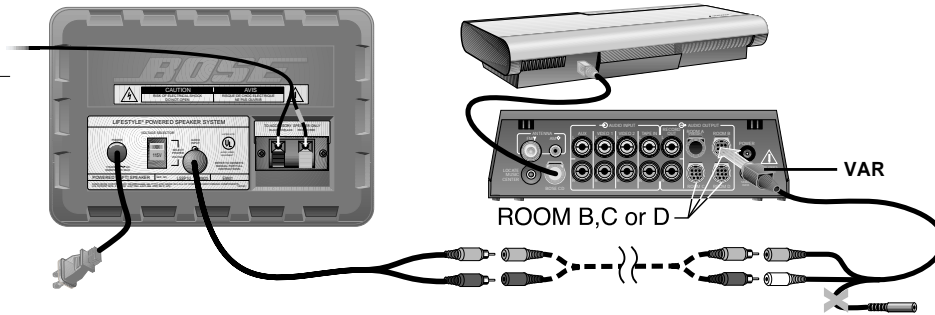

To connect the Lifestyle® powered speaker system to your Lifestyle® system refer to Figure 9. Then follow these steps:

1. Make sure all components are unplugged from the AC power (mains) outlet before making any connections.
2. Connect the attached 6-foot audio input cable to the supplied 3-foot VAR adapter cable (labeled VAR on the single-connector end).
3. Attach the other end of the 3-foot VAR adapter cable to one of the unused ROOM output jacks (B, C, D) on the rear of the multi-room interface.

Note: To extend the length of the cables, use the supplied 50-foot extension cable (shown as dotted line above). This cable connects between the 6-foot audio input and the 3-foot VAR adapter cable.

Connecting power to your system

If you purchased a dual-voltage system, it is important that you set the speakers to the correct voltage setting. To do this, refer to “Selecting the correct voltage” on page 5.

Follow these steps to connect power to your Lifestyle® powered speaker system:

1. With the volume control on the left speaker turned all the way down (counterclockwise), plug the power cord from the left speaker into an AC power (mains) outlet.
2. Insert the power cord of the Lifestyle® system into an AC power (mains) outlet.
3. Set the speaker’s volume control to the two-o’clock position and turn on your music.

Operating speakers in more than one room

Your Lifestyle® Personal® music center can control up to four sets of Bose® powered speakers, allowing your family to enjoy four different audio sources (CD, radio, TV, etc.) in up to four rooms. These rooms are referred to as room A, B, C, and D, with room A being the primary room (the one used for a one-room system). If two or more rooms are connected to your system, the Personal music center displays ROOM and HOUSE buttons, and room indicators A, B, C, and/or D. Figure 10 shows a sample display for a two-room system.

The ROOM button lets you control a single room, or two or more rooms that share a source

The HOUSE button lets you control all connected rooms as one

The room indicators tell you what was selected by the ROOM or HOUSE button

Figure 10

Sample display for a two-room system

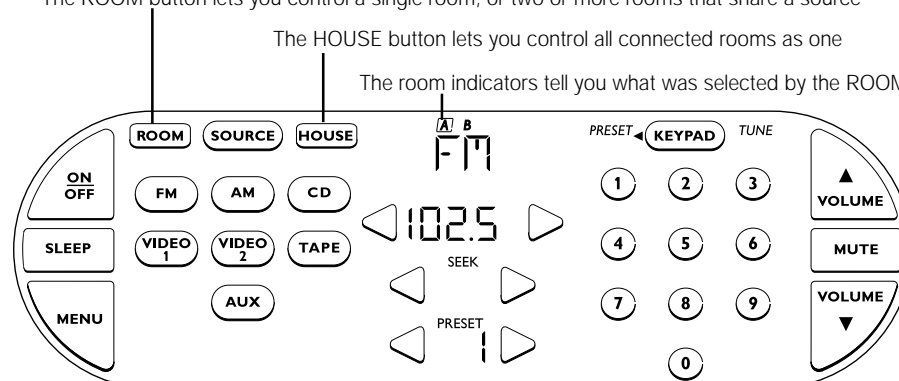

- A A boxed letter indicates the presently-selected room or rooms.
- B An unboxed letter indicates a room listening to a *shared source*.
- An empty box appears for each connected room when you press the HOUSE button.

Turning on different sources in more than one room

Let's say you have a two-room system (rooms A and B) and the entire system is off. To turn on a different source in each room:

1. Wake up the touchscreen.
2. Press the ROOM button until the room indicator A is displayed. Press a source button, such as VIDEO 1, to turn on the system and listen to your DVD player in room A. Adjust the volume to the desired level.
3. Press the ROOM button again. The room indicator B is displayed. Press a different source button, such as CD, to listen to a CD in room B. Again, adjust the volume to the desired level.
4. Press the ROOM button again and notice that the room indicator A is displayed. You are controlling room A once again and the display indicates that the VIDEO 1 source is on.

Setting up a shared source

Now, let's say the system is already on and you want to play the FM radio in rooms A and B:

1. Wake up the touchscreen.
2. Press the ROOM button until the room indicator A is displayed. Press the FM source button and adjust the volume to the desired level for room A.
3. Press the ROOM button again to select room B. Press the FM source button and adjust the volume to the desired level for room B. Now, the indicators A B are displayed.
4. Press the ROOM button again. The indicators A B appear on the touchscreen indicating that you can control these two rooms together. Any button command given now (SOURCE, VOLUME, MUTE, ON/OFF, SLEEP) is applied to both rooms.

Using the HOUSE button

Using the HOUSE button, you can link all the rooms together and control them as one. When you press the HOUSE button, an empty box indicator is displayed for each connected room. Any button pressed after that (any source button, VOLUME, MUTE, or SLEEP) affects every room. When you are done listening you can press OFF to turn off the entire system.

 **Note:** If you do not press any other buttons after pressing HOUSE, pressing HOUSE again cancels HOUSE mode.

Using more than one Personal® music center

If you have a multi-room system, you can add Personal music centers for some or all of the connected rooms. Each multi-room interface can be controlled by a maximum of four Personal music centers. Each Personal music center can control up to four rooms.

Connecting the speakers to the Lifestyle® media center

Figure 11

Connecting the speakers to the Lifestyle® media center

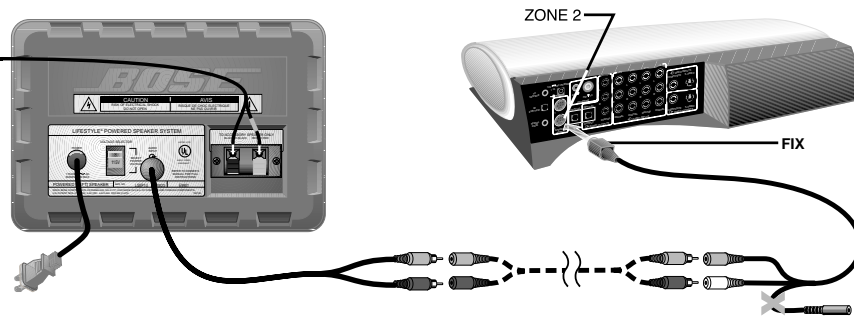

Note: To extend the length of the cables, use the supplied 50-foot extension cable (shown as a dotted line above). This cable connects the 6-foot audio input cable to the 3-foot FIX adapter cable.

To connect the Lifestyle® powered speaker system to your media center refer to Figure 11. Then follow these steps:

1. Make sure all components are unplugged from the AC power (mains) outlet before making any connections.
2. Connect the attached 6-foot audio input cable to the supplied 3-foot adapter cable labeled FIX on the single-connector cable end.
3. Attach the smaller connector on the 3-foot FIX adapter cable to the ZONE 2 output jack on the rear of the Lifestyle® media center.

Setting up the Zone 2 remote control

You must set up a second remote control to operate the ZONE 2 output.

1. Remove the remote control battery cover and locate the miniature switches (Figure 12a).
2. Make sure the house code settings (switches 1, 2, 3, and 4) match those on your first remote.
3. Make sure switches 5, 7, and 8 are up, and 6 and 9 are down.

Note: Refer to your Lifestyle® system owner's guide for more information on operating your system in more than one room.

Figure 12a

Setting up a Zone 2 remote control

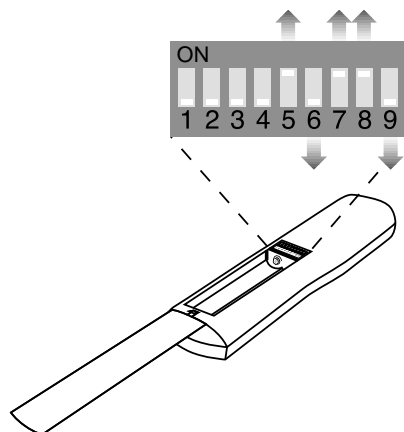

Note: If you would like to adjust volume using your Lifestyle® powered speaker system's volume control knob instead of a remote control, change "Zone 2 Protocol" to "Legacy" in the last (3 of 3 screen) system settings menu.

Setting Zone 2 Protocol

For the Lifestyle® powered speaker system to work properly with a Lifestyle® media center, you will need to check the Zone 2 Protocol to ensure that it is set to Normal mode.

1. While your Lifestyle® system is on, press the Settings button (Figure 12b) on your remote control. This will open the on-screen display.
2. Scroll down with the down-arrow button and select System Setup using the Enter button.
3. You will now see a menu entitled System Setup (1 of 3). Scroll down to “more...”.
Continue to scroll down through (2 of 3) to (3 of 3). The last item on System Setup (3 of 3) is Zone 2 Protocol.
4. If necessary, use the right-arrow button to set the protocol from Legacy to Normal.
5. If you changed the Zone 2 Protocol, turn off the system and turn it on again; this ensures that the Zone 2 Protocol is reset to Normal mode.

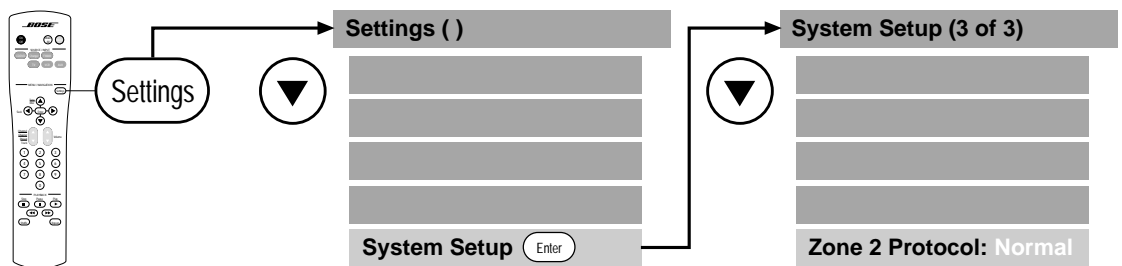

Figure 12b

Setting Zone 2 Protocol

Connecting power to your system

⚠ CAUTION: If you purchased a dual-voltage system, it is important that you set the speakers to the correct voltage. To do this, refer to “Selecting the correct voltage” on page 5.

Follow these steps to connect power to your Lifestyle® powered speaker system:

1. With the volume control on the left speaker turned all the way down (counterclockwise), plug the power cord from the left speaker into an AC power (mains) outlet.
2. Insert the power cord of the Lifestyle® system into an AC power (mains) outlet.
3. Set the volume control for the speakers to the two-o’clock position and turn on your music.

Connecting the speakers to the Model 20 music center

Figure 13

Connecting the speakers to the Model 20 music center

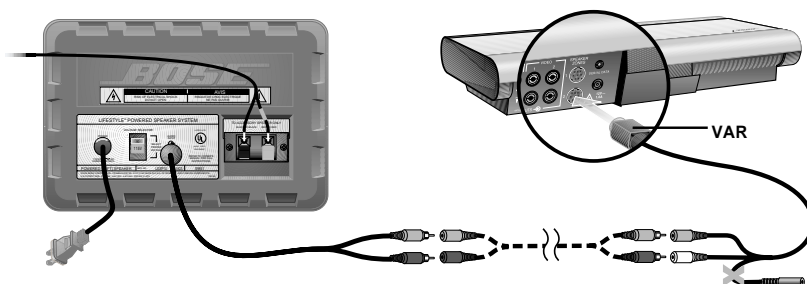

To connect the Lifestyle® powered speaker system to your Lifestyle® system refer to Figure 13. Then follow these steps:

- ♪ **Note:** When making the connections, be sure to always connect the RED ends of the speaker wire to the RED ends of the other wire or terminal.
1. Make sure all components are unplugged from the AC power (mains) outlet before making any connections.
 2. Connect the attached 6-foot audio input cable to the supplied 3-foot adapter cable labeled VAR on the single-connector end.
 3. Attach the other end of the 3-foot VAR adapter cable to the ZONE 2 output jack on the rear of the Model 20 music center (not shown).

- ♪ **Note:** To extend the length of the cables, use the supplied 50-foot extension cable (shown in dotted line above). This cable connects the 6-foot audio input to the 3-foot VAR adapter cable.

Setting up the remote control

You must set up a second remote control to operate the ZONE 2 output.

1. Remove the remote control battery cover and locate the miniature switches (Figure 14).
2. Make sure that the house code settings (switches 1, 2, 3, and 4) match those on your first remote.
3. Slide switch 8 up.

Figure 14

Setting up the RC-20 remote control

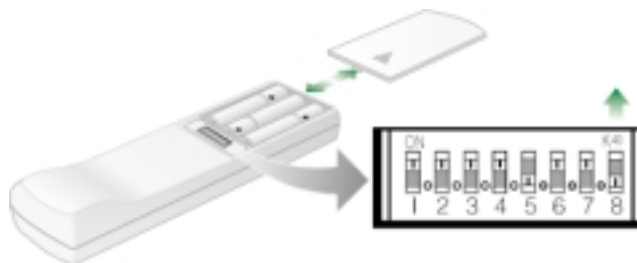

Connecting power to your system

- ⚠ **CAUTION:** If you purchased a dual-voltage system, it is important that you set the speakers to the correct voltage. To do this, refer to "Selecting the correct voltage" on page 5.

Follow these steps to connect power to your Lifestyle® powered speaker system:

1. With the volume control on the left speaker turned all the way down (counterclockwise), plug the power cord from the left speaker into an AC power (mains) outlet.
2. Insert the power cord of the Lifestyle® system into an AC power (mains) outlet.
3. Set the volume control for the speakers to the two-o'clock position and turn on your music.

Connecting the speakers to the Model 5 music center

Figure 15

Connecting the speakers to the Model 5 music center

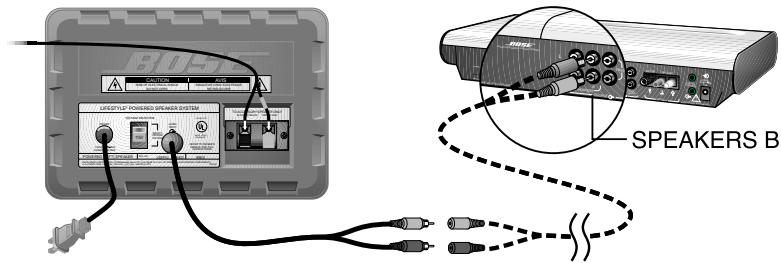

Note: To extend the length of the cables, use the supplied 50-foot extension cable (shown as dotted line). This cable connects between the 6-foot audio input cable and the SPEAKERS B output on the music center.

To connect the Lifestyle® powered speaker system to your existing Lifestyle® system refer to Figure 15. Then follow these steps:

1. Make sure all components are unplugged from the AC power (mains) outlet before making any connections.
2. Connect the attached 6-foot audio input cable directly into the SPEAKERS B output on the music center.

Setting up the remote control

You need to set up a second remote control to operate the SPEAKERS B output.

1. Remove the remote control battery cover and locate the miniature switches.
2. Make sure that the house code settings (switches 1-4) match those in your first remote.
3. Set switches 5 down, and 6 up for SPEAKERS B.

Figure 16

Setting up the RC-5 remote control

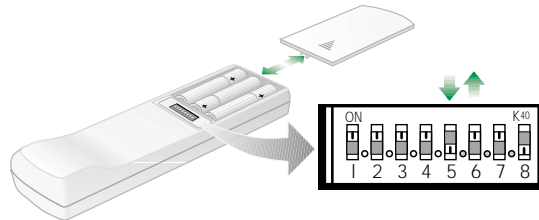

Connecting power to your system

Caution: If you purchased a dual-voltage system, it is important that you set the speakers to the correct voltage. To do this, refer to "Selecting the correct voltage" on page 5.

Follow these steps to connect power to your Lifestyle® powered speaker system:

1. With the volume control on the left speaker turned all the way down (counterclockwise), plug the power cord from the left speaker into an AC power (mains) outlet.
2. Insert the power cord of the Lifestyle® system into an AC power (mains) outlet.
3. Set the speaker's volume control to the two-o'clock position and turn on your music.

Operating tips

The volume control (located on the front of the left speaker) should be used in addition to the volume control on your Lifestyle® music center (or other source). It is particularly convenient when your music source has no remote control or when the remote control has been removed from your listening area. To increase volume, turn the control clockwise. To decrease volume, turn the control counterclockwise.

The following suggestions are provided to help you get the most enjoyment out of your system:

Starting your musical selection – When the music begins to play, *slowly* increase the volume of the *music source* to the desired level. Use the volume control on the left speaker if any further adjustment is desired.

When the music is over – It is a good idea to turn the volume control all the way to the left when you have finished listening to your Lifestyle® powered speaker system. This will prevent you from accidentally playing music to an empty room. Just remember to return the control to the two-o'clock position before you use the speakers again.

If the system is not to be used for an extended period – Unplug the Lifestyle® powered speaker system from the wall outlet.

Adjusting tone – The Lifestyle® powered speaker system incorporates an optimized, preset equalizer for proper bass and treble balance. This tone setting cannot be adjusted. However, any tone controls on the source unit can be used when the source unit is playing through the Lifestyle® powered speaker system.

Troubleshooting

Problem	What to do
System doesn't play at all	<ul style="list-style-type: none"> • Check power cord and connections. It may be unplugged or improperly connected. • On models equipped with a power switch, make sure the switch is in the on (I) position. • Increase volume on the speaker from the main system.
No sound when system is plugged in	<ul style="list-style-type: none"> • The source component is not properly connected to the system; check connections. • Make sure the source is operating properly (CD has been installed, batteries are working, etc.). • Check volume controls.
Only one speaker plays	<ul style="list-style-type: none"> • The accessory (RIGHT) speaker may be improperly connected. Check connection, wires, and terminals.
Sound is too loud/distorted	<ul style="list-style-type: none"> • The source component's volume may be too high. Turn the source volume down, and use the volume control on the Lifestyle® powered speaker system.
Diminished bass	<ul style="list-style-type: none"> • Accessory (RIGHT) speaker wire connections may be reversed. Check connections.
Hear only static	<ul style="list-style-type: none"> • Check 3-foot adapter cable. If you are using a Lifestyle® DVD system, make sure the 3-foot adapter cable plugged into the media center reads FIX on the mini-DIN end.

Customer Service

For additional help in solving problems, contact Bose® customer service. Refer to the address list enclosed in the product packaging for correct phone numbers.

Technical Information

Power rating

USA/Canada: 120V ~ 50/60 Hz, 30W
 Dual Voltage: 115/230V ~ 50/60 Hz, 30W
 Europe/Australia: 220-240V ~ 50/60 Hz, 30W

Features

High-impact polystyrene copolymer ported enclosure
 Built-in volume control
 Patented signal processing
 Syncom® computer tested

Dimensions

6"H x 9"W x 6"D
 (15.2 x 22.9 x 15.2 cm)

Weight

In carton, 16.25 lb (7.4 kg)

Finish

High-impact polystyrene copolymer, black or white

Accessories

The following accessories are available to enhance the flexibility of your Lifestyle® powered speaker system. Contact your Bose® dealer, or call Bose directly (see inserted sheet for list of phone numbers).

WB-10 Wall Bracket:

Mount your Lifestyle® powered speaker system directly against a wall or other surface.

SM-1 Wall/Ceiling Brackets:

Mounts your Lifestyle® powered speakers to a wall for the greatest flexibility.

Warranty period

The Bose Lifestyle® powered speaker system is covered by a limited one-year transferable warranty. Details are provided on the warranty card that came with your system. Please fill out the information section on the card and mail it to Bose Corporation.

Cleaning the Lifestyle® powered speaker system

Clean the surface of your speakers with a soft, damp cloth. Do not use any sprays near the system. Do not use any solvents, chemicals, or cleaning solutions containing alcohol, ammonia, or abrasives. Do not allow liquids to spill into any openings.

The speaker grille panels require no special care, though you may vacuum them carefully with a soft-bristled attachment, if necessary.



CAUTION: If liquids get into the product, unplug the speakers, disconnect the speaker wires, and allow them to air dry. Then, reconnect the speakers and plug them in again. If you notice any problems with their functioning, unplug them and contact Bose customer service.



Note: Your Lifestyle® powered speakers should be mounted only in the manner recommended by Bose. Consult the instructions supplied with the mounting accessories.

BOSE[®]
Better sound through research[®]

©2002 Bose Corporation,
The Mountain,
Framingham, MA 01701-9168 USA
262842 AM Rev. 00 JN20603

Free Manuals Download Website

<http://myh66.com>

<http://usermanuals.us>

<http://www.somanuals.com>

<http://www.4manuals.cc>

<http://www.manual-lib.com>

<http://www.404manual.com>

<http://www.luxmanual.com>

<http://aubethermostatmanual.com>

Golf course search by state

<http://golfingnear.com>

Email search by domain

<http://emailbydomain.com>

Auto manuals search

<http://auto.somanuals.com>

TV manuals search

<http://tv.somanuals.com>