



DINION 5000 AN

VBN-5085



BOSCH

en Installation Manual

Table of Contents

1	Safety	5
1.1	Safety precautions	5
1.2	System ground/Safety ground	5
1.3	Important safety instructions	6
1.4	Important notices	7
1.5	FCC information	8
1.6	UL certification	9
1.7	Bosch notice	9
<hr/>		
2	Introduction	10
2.1	Features	10
<hr/>		
3	Installation	11
3.1	Unpacking	11
<hr/>		
4	Connection and mounting	12
4.1	Power connection	12
4.1.1	Low voltage cameras	12
4.1.2	High voltage cameras	13
4.2	Video connections	14
4.2.1	Output Video signal	14
4.3	Alarm and relay connector	15
4.4	Lens mounting	16
4.5	Back focus adjustment	17
4.6	Mounting the camera	19
<hr/>		
5	Configuration	20
5.1	Menus	20
5.1.1	Top level menus	20
5.1.2	Menu navigation	21
5.2	Pre-defined modes	22
5.3	Day/Night switching	23
5.4	Camera control communication (Bilinx)	23
5.5	Main menu structure	24
5.5.1	Mode submenu	24

5.5.2	Exposure submenu	25
5.5.3	Day/Night submenu	27
5.5.4	Enhance / Dynamic Engine submenu	29
5.5.5	Color submenu	31
5.5.6	VMD submenu	32
5.5.7	Image Adjustment submenu	33
5.6	Install menu structure	34
5.6.1	Language submenu	35
5.6.2	Lens Wizard submenu	35
5.6.3	Synchronization submenu	37
5.6.4	Alarm I/O submenu	38
5.6.5	Connections submenu	39
5.6.6	Test signal submenu	39
5.6.7	Camera ID submenu	40
5.6.8	Privacy masking submenu	41
5.6.9	Flip submenu	41
5.6.10	Defaults submenu	42
<hr/>		
6	Troubleshooting	43
6.1	Resolving problems	43
6.2	Customer service	44
<hr/>		
7	Maintenance	45
7.1	Repairs	45
7.1.1	Transfer and disposal	45
<hr/>		
8	Technical Data	46
8.1	Specifications	46
8.1.1	Dimensions	48
8.1.2	Accessories	49

1 Safety

1.1 Safety precautions

**DANGER!**

High risk: This symbol indicates an imminently hazardous situation such as "Dangerous Voltage" inside the product. If not avoided, this will result in an electrical shock, serious bodily injury, or death.

**WARNING!**

Medium risk: Indicates a potentially hazardous situation. If not avoided, this could result in minor or moderate bodily injury.

**CAUTION!**

Low risk: Indicates a potentially hazardous situation. If not avoided, this could result in property damage or risk of damage to the unit.

1.2 System ground/Safety ground

System (video) ground is indicated by the symbol .

Safety (power) ground is indicated by the symbol .

The system ground is only used to comply with safety standards or installation practices in certain countries. Bosch does **not** recommend connecting system ground to safety ground unless it is explicitly required. However, if the system ground and safety ground are connected and grounding loops are causing interference in the video signal, use an isolation transformer (available separately from Bosch).

**CAUTION!**

Connecting System ground to Safety ground may result in ground loops that can disrupt the CCTV system.

1.3 Important safety instructions

Read, follow, and retain for future reference all of the following safety instructions. Heed all warnings on the unit and in the operating instructions before operating the unit.

1. **Cleaning** - Generally, using a dry cloth for cleaning is sufficient but a moist, fluff-free cloth or leather shammy may also be used. Do not use liquid cleaners or aerosol cleaners.
2. **Heat Sources** - Do not install the unit near any heat sources such as radiators, heaters, stoves, or other equipment (including amplifiers) that produce heat.
3. **Water** - Never spill liquid of any kind on the unit.
4. **Lightning** - Take precautions to protect the unit from power and lightning surges.
5. **Controls adjustment** - Adjust only those controls specified in the operating instructions. Improper adjustment of other controls may cause damage to the unit.
6. **Power sources** - Operate the unit only from the type of power source indicated on the label.
7. **Servicing** - Unless qualified, do not attempt to service this unit yourself. Refer all servicing to qualified service personnel.
8. **Replacement parts** - Use only replacement parts specified by the manufacturer.
9. **Installation** - Install in accordance with the manufacturer's instructions and in accordance with applicable local codes.
10. **Attachments, changes or modifications** - Only use attachments/accessories specified by the manufacturer. Any change or modification of the equipment, not expressly approved by Bosch, could void the warranty or, in the case of an authorization agreement, authority to operate the equipment.

1.4 Important notices



Disposal - Your Bosch product was developed and manufactured with high-quality material and components that can be recycled and reused. This symbol means that electronic and electrical appliances, which have reached the end of their working life, must be collected and disposed of separately from household waste material. Separate collecting systems are usually in place for disused electronic and electrical products. Please dispose of these units at an environmentally compatible recycling facility, per *European Directive 2002/96/EC*

WARNING!



Power disconnect for high voltage versions: A unit has power supplied whenever the power cord is inserted into the power source. The power cord plug is the main power disconnect for the unit. For pluggable equipment, install the socket outlet near the equipment so it is easily accessible.

WARNING!



All-pole power switch: Incorporate an all-pole power switch, with a contact separation of at least 3 mm in each pole, into the electrical installation of the building.

CAUTION!



Fuse rating: The branch circuit protection must be secured with a maximum fuse rating of 16 A. This must be in accordance with *NEC800 (CEC Section 60)*.

CAUTION!



The Low Voltage power supply unit must comply with EN/UL 60950. The power supply must be a SELV-LPS unit or a SELV - Class 2 unit (Safety Extra Low Voltage - Limited Power Source).

1.5 FCC information

FCC & ICES Information

(U.S.A. and Canadian Models Only)

This equipment has been tested and found to comply with the limits for a **Class B** digital device, pursuant to *part 15* of the *FCC Rules*. These limits are designed to provide reasonable protection against harmful interference in a **residential installation**. This equipment generates, uses, and can radiate radio frequency energy and, if not installed and used in accordance with the instructions, may cause harmful interference to radio communications. However, there is no guarantee that interference will not occur in a particular installation. If this equipment does cause harmful interference to radio or television reception, which can be determined by turning the equipment off and on, the user is encouraged to try to correct the interference by one or more of the following measures:

- reorient or relocate the receiving antenna;
- increase the separation between the equipment and receiver;
- connect the equipment into an outlet on a circuit different from that to which the receiver is connected;
- consult the dealer or an experienced radio/TV technician for help.

Intentional or unintentional modifications, not expressly approved by the party responsible for compliance, shall not be made. Any such modifications could void the user's authority to operate the equipment. If necessary, the user should consult the dealer or an experienced radio/television technician for corrective action.

The user may find the following booklet, prepared by the Federal Communications Commission, helpful: How to Identify and Resolve Radio-TV Interference Problems. This booklet is available from the U.S. Government Printing Office, Washington, DC 20402, Stock No. 004-000-00345-4.

1.6 UL certification

Disclaimer

Underwriter Laboratories Inc. ("UL") has not tested the performance or reliability of the security or signaling aspects of this product. UL has only tested fire, shock and/or casualty hazards as outlined in UL's *Standard(s) for Safety for Information Technology Equipment, UL 60950-1*. UL Certification does not cover the performance or reliability of the security or signaling aspects of this product.

UL MAKES NO REPRESENTATIONS, WARRANTIES, OR CERTIFICATIONS WHATSOEVER REGARDING THE PERFORMANCE OR RELIABILITY OF ANY SECURITY OR SIGNALING-RELATED FUNCTIONS OF THIS PRODUCT.

1.7 Bosch notice

More information

For more information please contact the nearest Bosch Security Systems location or visit www.boschsecurity.com

2 Introduction

2.1 Features

The DINION 5000 Day/Night WDR camera is a high-performance, smart, surveillance color camera. It uses a wide dynamic range 960H CCD sensor for outstanding picture performance.

The camera is easy to install and ready to use, and offers the best solution for demanding scene conditions. Features include:

- 1/3-inch 960H CCD sensor with wide dynamic range
- True Day/Night performance with switchable IR filter
- 720TVL sensor resolution
- High Dynamic Range
- Privacy zones
- Detail enhancement
- Bilinx (bi-directional coaxial communication)
- Wide operating temperature range
- Lens wizard
- Six pre-programmed operation modes
- Dynamic noise reduction
- Multiple language on-screen display
- Built-in test pattern generator

3 Installation

3.1 Unpacking

Unpack carefully and handle the equipment with care.

The packaging contains:

- DINION 5000 camera
- CCD protection cap (mounted on camera)
- Alarm I/O connector
- Power connector
- Important safety instructions
- Quick install instructions
- CD-ROM
 - Installation instructions

If equipment has been damaged during shipment, repack it in the original packaging and notify the shipping agent or supplier.



WARNING!

Installation should only be performed by qualified service personnel in accordance with the National Electrical Code *NEC800 (CEC Section 60)* or applicable local codes.



CAUTION!

The camera module is a sensitive device and must be handled carefully.

4 Connection and mounting



CAUTION!

Before proceeding, disconnect the power from the power supply cable. Ensure that the voltage of the unit matches the voltage and type of the power supply being used.

4.1 Power connection

4.1.1 Low voltage cameras

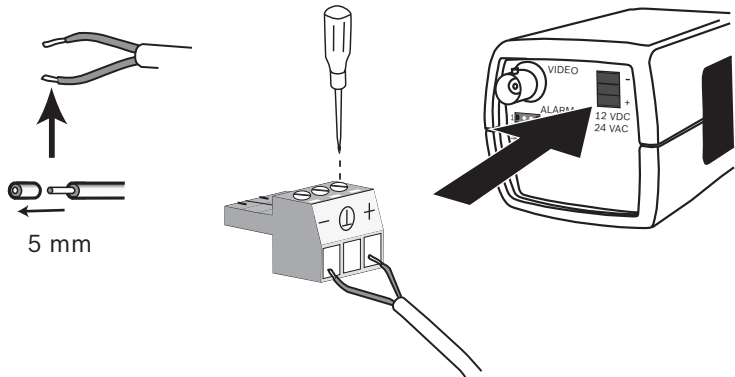

Figure 4.1 Low voltage power connection

Connect power from a 24 VAC or 12 VDC class 2 power supply as follows:

- Use AWG16 to 22 stranded wire or AWG16 to 26 solid wire; cut back 5 mm (0.2 in) of insulation.
- Remove the 3-pole connector from the camera body.
- Loosen the screws and insert the wires.

Note

The central connection for System (video) ground is optional. Connecting System ground to Safety ground may result in ground loops that can disrupt the CCTV system.

- Tighten the screws and reconnect the 3-pole connector to the camera.

Note

For a **DC supply** the polarity is important. Incorrect polarity does not damage the camera but it will not switch on. For an **AC supply** maintain a consistent wiring polarity in multiple camera systems to help avoid potential camera video rolling.

4.1.2 High voltage cameras

Figure 4.2 High voltage power connection

Connect the power cable of a high voltage camera to a 230 VAC power supply outlet.

4.2 Video connections

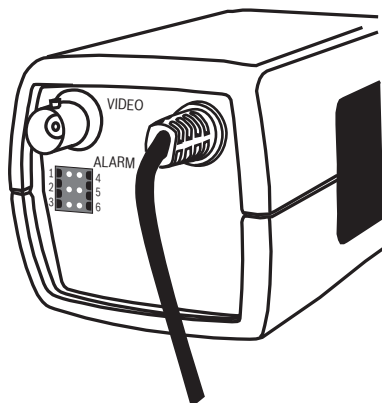
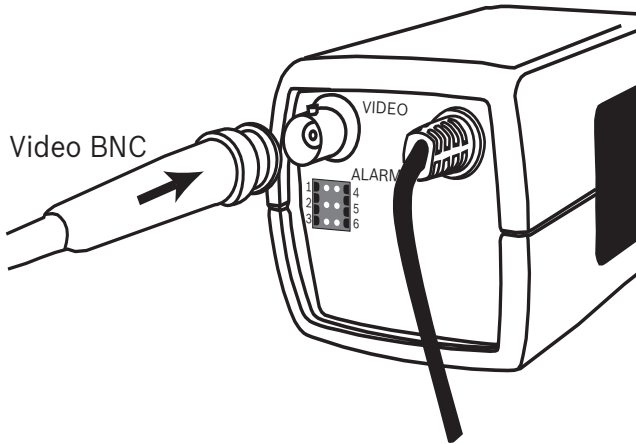

Figure 4.3 BNC connectors

4.2.1 Output Video signal

The camera has a BNC connector to connect the video coax cable with a male BNC connector. A UTP adapter (VDA-455UTP) is available as an optional accessory to allow a UTP video cable to be connected to the BNC connector.

4.3 Alarm and relay connector

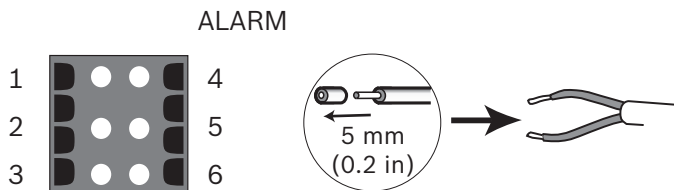

Figure 4.4 Alarm and relay connector pins

Pin	Alarm socket
1	Alarm in
2	not used
3	Relay out contact 2
4	Alarm in ground
5	not used
6	Relay out contact 1

- Max. wire diameter AWG 22-28 for both stranded and solid; cut back 5 mm (0.2 in) of insulation.
- Alarm output relay switching capability: Max voltage 30VAC or +40 VDC. Max 0.5 A continuous, 10 VA.
- Alarm in: TTL logic, +5V nominal, +40 VDC max, DC coupled with 22 kOhm pull-up to +3.3 V.
- Alarm in: configurable as active low or active high.
- Max. 42 V allowed between camera ground and each of the relay pins.

4.4 Lens mounting

The camera accepts CS-mount lenses. C-mount lenses can be mounted using the lens adapter ring. DC-iris lenses are recommended for the best picture performance.



CAUTION!

To avoid damaging the CCD sensor when using a C-mount lens, make sure the supplied lens adapter ring is mounted onto the camera before mounting the lens.

Lenses weighing more than 0.5 kg (1.1lbs) must be separately supported.

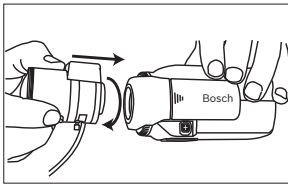

Figure 4.5 Mounting a lens

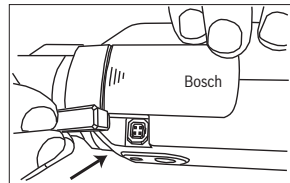

Figure 4.6 Lens connector

Pin	Video iris lens	DC iris lens	
1	Supply (11.5V \pm 0.5, 50mA max.)	Damp -	
2	Not used	Damp +	
3	Video signal 1Vpp 1kOhm	Drive +	
4	Ground	Drive -	

Note

If a short circuit is detected on the lens connector, the on-screen display (OSD) failure message LENS SHORT CIRCUIT is shown. The lens circuit is automatically disabled to avoid internal damage. Remove the lens connector and check the pin connections.

4.5 Back focus adjustment

To optimize picture sharpness in both bright and low-level lighting, adjust the back focus. Use the camera's unique Lens Wizard. This ensures that the object of interest always remains in focus, even when focusing at the maximum lens iris opening (for example, at night).

- When back focusing varifocal lenses, adjust to obtain a sharp picture in both wide-angle and tele positions for both far and near focus.
- When back focusing zoom lenses, ensure the object of interest remains in focus throughout the entire zoom range of the lens.

To adjust back focus:

1. Open the slide door panel at the side of the camera.

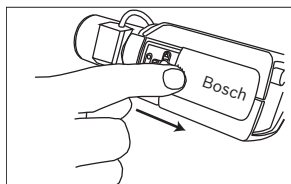

1. Unlock the back focus locking button.

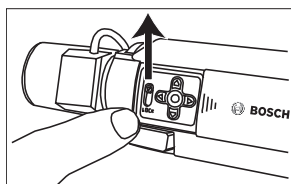

2. Press and hold the center key for more than 1 second until the **Install** menu appears.
3. Select **Len Wizard** and move cursor to the **Set Back Focus Now** item.
4. Turn the back focus adjustment as required.

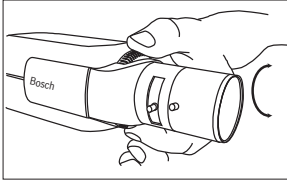

5. Lock the back focus locking button.

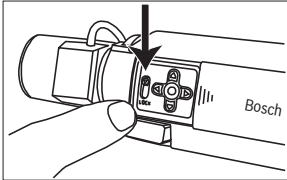

6. Press and hold the center key for more than 1 second until all the menus disappear.
7. Close the side door panel.

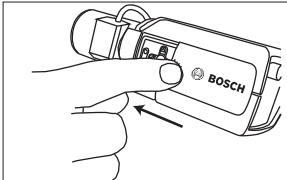

4.6 Mounting the camera

The camera can be mounted either from the top or from the bottom (1/4" 20 UNC thread). The bottom mounting is isolated from ground to prevent ground loops.

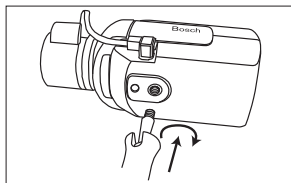

Figure 4.7 Mounting a camera



CAUTION!

Do not point the camera/lens into direct sunlight as this may damage the sensors.

Note:

A wide range of accessories is available for indoor and outdoor mounting.

5 Configuration

The camera normally provides an optimal picture without the need for further adjustments. Advanced set-up options are available in a menu system for getting the best results under special circumstances.

The camera implements your changes immediately so that before and after settings are easily compared.

5.1 Menus

5.1.1 Top level menus

There are two upper level menus: a **Main** menu and an **Install** menu. The menus have functions that can be selected directly or submenus for more detailed set-up.

- To access the **Main** menu, press the menu/select button (center) for less than 1 second. The **Main** menu appears on the monitor. The **Main** menu allows you to select and set-up the picture enhancement functions. If you are not happy with your changes, you can always recall the default values for the mode.
- The camera also has an **Install** menu in which the installation settings can be set. To access the **Install** menu, press the menu/select button (center) for longer than 2 seconds.

5.1.2 Menu navigation

Five keys, located behind the side door panel, are used for navigating through menu system.

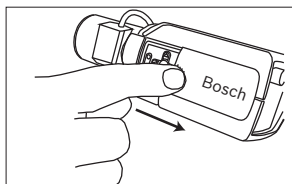

Figure 5.1 Side panel door

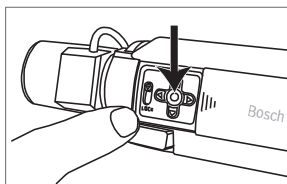

Figure 5.2 Menu/select key

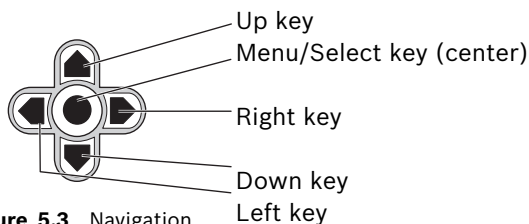

Figure 5.3 Navigation

- Use the up or down keys to scroll through a menu.
- Use the left or right keys to move through options or to set parameters.
- When in a menu, quickly double-press the menu/select key to restore the selected item to its factory default.
- To close all menus at once hold down the menu/select key until the menu display disappears or continually select the **Exit** item.

Some menus automatically close after about two minutes; other menus have to be closed manually.

5.2 Pre-defined modes

There are six pre-defined modes with settings to make configuration easier. You can select one of the six pre-defined modes in the Install/Mode submenu. The modes are defined as follows;

1. **24-hour**
Default installation mode to provide stable pictures over a 24-hour period. These settings are optimized for out-of-the-box installation.
2. **Traffic**
Capture high-speed objects using default shutter in variable lighting conditions.
3. **Low light**
Provide extra enhancement, such as AGC and SensUp to make usable pictures in low-light conditions.
4. **Smart BLC**
Settings optimized to capture details in high contrast and extremely bright-dark conditions.
5. **Low noise**
Enhancements are set to reduce picture noise. Useful for conditional refresh DVR and IP storage systems because reducing noise reduces the amount of storage required.
6. **Vibrant**
This mode has enhanced contrast, sharpness and saturation.

5.3 Day/Night switching

The camera is equipped with a motorized IR filter. The mechanical IR filter can be removed in low-light or IR illuminated applications by software configuration settings. If **Auto** switching mode is selected, the camera automatically switches the filter depending on the observed light level. The switching level is programmable. In **Auto** switching mode the camera prioritizes motion (the camera gives sharp images without motion blur as long as the light level permits) or color (the camera gives color pictures as long as the light level permits). The camera recognizes IR illuminated scenes to prevent unwanted switching to color mode.

There are four different methods of controlling the IR filter:

- via an alarm input,
- via Bilinx communication,
- automatically, based on the observed light levels, or
- as part of the programmable mode profile.

5.4 Camera control communication (Bilinx)

This camera is equipped with a coaxial communications transceiver (also referred to as Bilinx). In combination with VP-CFGSFT, the camera setting can be changed from any point along the coaxial cable. All menus can be accessed remotely giving full control of the camera. With this method of communication it is also possible to disable the local keys on the camera. To avoid loss of communication on an installed camera, the **Communication On/Off** selection is not available while using remote control. This function can only be accessed with the camera buttons. Bilinx communications can only be disabled using the buttons on the camera.

Disabled camera buttons

When the Bilinx communications link is active, the buttons on the camera are disabled.

5.5 Main menu structure

Item	Selection	Description
Mode	Submenu	Sets up operating modes 1 to 6
Exposure	Submenu	Exposure control
Day/Night	Submenu	Day/Night for color/mono operation
Enhance	Submenu	Picture enhancement and performance
Color	Submenu	White balance and color rendition
VMD	Submenu	Video motion detection
Image Adjustment	Submenu	Sets up digital zoom or digital image stabilization

5.5.1 Mode submenu

Item	Selection	Description
Mode	1 to 6	Selects operating mode.
Mode ID	Alphanumeric	Mode name (11 characters maximum)
Copy active mode	Available mode numbers	Copies current mode settings to the mode number selected.
Mode Defaults	Submenu	Restores camera to the factory default settings.
EXIT		Returns to main menu.

5.5.2 Exposure submenu

Item	Selection	Description
ALC level	-15 to +15	Selects the video level range. A positive value is more useful for low-light conditions; a negative value is more useful for very bright conditions. Some ALC adjustment may improve scene content when Smart BLC is enabled.
ALC speed	Slow, medium, fast	Adjusts the speed of the video level control loop. For most scenes it should remain at the default value.
Shutter	AES, FL, Fixed	AES (auto-shutter) - the camera automatically sets the optimum shutter speed. FL - flickerless mode avoids interference from light sources (recommended for DC-iris lenses only). FIXED - allows a user defined shutter speed.
Default (AES) shutter or Fixed shutter	1/50 (PAL) 1/60 (NTSC), 1/100 (PAL) 1/120 (NTSC), 1/250, 1/500, 1/1000, 1/2000, 1/4000, 1/10K, 1/100K	In DEFAULT (AES) mode, the camera tries to maintain the selected shutter speed as long as the light level of the scene is high enough. In Fixed mode, selects shutter speed.

Item	Selection	Description
Actual shutter		Displays the actual shutter value from the camera to help compare lighting levels and optimum shutter speed during set-up.
Gain control	On, Fixed	On - the camera automatically sets the gain to the lowest possible value needed to maintain a good picture. Fixed - sets Fixed AGC value.
Maximum AGC or Fixed AGC	0 to 40 dB	Selects the maximum value the gain can have during AGC operation. Selects the gain setting for Fixed gain operation (0 is no gain).
Actual AGC		Displays the actual AGC value from the camera to help compare gain level with lighting levels and picture performance.
SensUp Dynamic	Off, 2x, 3x, ..., 10x	Selects the factor by which the sensitivity of the camera is increased. When active, some noise or spots may appear in the picture. This is normal camera behavior. It may also cause motion blur on moving objects.
EXIT		Returns to main menu.

5.5.3 Day/Night submenu

Item	Selection	Description
Day/Night	Auto, Color, Monochrome	<p>Auto - the camera switches the IR cut-off filter on and off depending on the scene illumination level.</p> <p>Color - the camera always produces a color signal regardless of light levels.</p> <p>Monochrome - the IR cut-off filter is removed, giving full IR sensitivity.</p>
Switch level	-15 to +15	<p>Sets the video level in Auto mode at which the camera switches to monochrome operation.</p> <p>A low (negative) value means that the camera switches to monochrome at a lower light level. A high (positive) value means that the camera switches to monochrome at a higher light level.</p>
Switch delay	1, 2, 3, 5, 10, 20, 30, 60, 120, 240 s	Sets the evaluation time in Auto mode for day to night transitions.
Priority	Motion, Color	<p>In AUTO mode:</p> <p>Color - the camera gives a color image as long as the light level permits.</p> <p>Motion - the camera avoids motion blur as long as the light level permits (it switches to monochrome earlier than it would with Color priority).</p>

Item	Selection	Description
IR contrast (mono)	Enhanced, Normal	<p>Enhanced - the camera optimizes contrast in applications with high IR illumination levels. Select this mode for IR (730 to 940 nm) light sources and for scenes with grass and green foliage.</p> <p>Normal - the camera optimizes contrast in mono applications with visible light illumination.</p>
IR illumination (mono)	0 to +15	Enter the strength of the external IR illumination to determine the night to day transition moment. 0 is no IR illuminator; +15 is very strong illumination.
Color burst (mono)	On, Off	<p>Off - the color burst in the video signal is switched Off in monochrome mode.</p> <p>On - the color burst remains active even in monochrome mode (required by some DVRs and IP encoders).</p>
EXIT		Returns to main menu.

5.5.4 Enhance / Dynamic Engine submenu

Item	Selection	Description
Dynamic Engine	Off, XF DYNAMIC, HDR, Smart BLC	<p>Off: - turns off all automatic scene detail and enhancements (only recommended for testing).</p> <p>XF DYNAMIC: - extra internal processing is enabled for enhancing the visibility.</p> <p>HDR: - adds dual sensor exposure to the XF DYNAMIC features. In harsh lighting conditions, pixels from each exposure are mixed to give a more detailed image.</p> <p>Smart BLC: - BLC window and weighting factor are automatically defined. Camera dynamically adjusts these for changing light conditions.</p>
Contrast Enhancement	Low, Medium, High	<p>Increases the contrast at medium brightness levels.</p> <p>Select Low for high contrast scenes.</p> <p>Select High for low contrast scenes (e.g. fog).</p>
Sharpness	-15 to +15	<p>Adjusts the sharpness of the picture. 0 corresponds to the default position.</p> <p>A low (negative) value makes the picture less sharp. Increasing sharpness brings out more detail.</p> <p>Extra sharpness can enhance the details of license plates, facial features and the edges of certain surfaces.</p>

Item	Selection	Description
3D-NR	Off, Low, Medium, High	Automatically reduces the noise in the picture. This may cause some motion blur on exceptionally fast moving objects immediately in front of the camera. This can be corrected by widening the field of view or lowering the selection value.
2D-NR	Off, Low, Medium, High	Automatically reduces the noise in the picture. A high selection may cause blur. A lower selection improves sharpness at the cost of more noise
Peak White Invert	On, Off	Use Peak White Invert to reduce glare from the CRT/LCD display. Use in ANPR/LPR applications to reduce headlight glare. (Test on-site to ensure that it does benefit the application and is not distracting for operators of the security system.)
EXIT		Returns to main menu.

5.5.5 Color submenu

Item	Selection	Description
White balance	ATW indoor, ATW Outdoor, ATW hold, Manual	ATW - Auto tracking white balance allows the camera to constantly adjust for optimal color reproduction. ATW hold - Puts the ATW on hold and saves the color settings. Manual - the Red and Blue gain can be manually set to a desired position.
Speed	Fast, Medium, Slow	Adjusts the speed of the white balance control loop.
Red gain	-50 to +50	Manual and ATW hold - adjusts the Red gain.
Blue gain	-50 to +50	Manual and ATW hold - adjusts the Blue gain.
Saturation	-15 to +5	Adjusts the color saturation. -15 gives a monochrome image; 0 gives the default saturation; +15 gives the most saturation.
EXIT		Returns to main menu.

5.5.6 VMD submenu

Item	Selection	Description
VMD area	Submenu	Select 1 of the 4 areas to enter the area set-up menu to define the detection area.
VMD mode	Off, Silent, OSD	Off - Video Motion Detection (VMD) is off. Silent - video motion generates silent alarm. OSD - video motion generates on-screen text message alarm.
VMD sensitivity	0 to 127	Sets the sensitivity for motion to the desired level. The longer the white bar, the more motion is required to activate the VMD alarm. Motion above this level activates alarm.
OSD alarm text	Alphanumeric	Text for on-screen display alarm (16 characters maximum).
EXIT		Returns to main menu.

Selecting an area for VMD masking

To set-up an area for VMD masking, access the area menu by selecting the **VMD Area** option from the VMD menu. Upon entering the **Area** menu, the current area is displayed with the upper left corner flashing. The flashing corner of the image can be moved with the Up, Down, Left, Right arrow keys. Pressing the Select key moves the flashing cursor to the opposite corner, which can now be moved. Pressing Select again freezes the area and exits the area menu.

5.5.7 Image Adjustment submenu

Item	Selection	Description
Digital Zoom	x1, x2, x4, x8, x16	Select the zoom factor
DIS	Off, On	Select On to stabilize the image.
EXIT		Returns to main menu.

5.6 Install menu structure

Item	Selection	Description
Language	Submenu	Select on-screen display (OSD) language
Lens Wizard	Submenu	Select to optimize the camera-lens combination backfocus point.
Synchronization	Submenu	Sets synchronization parameters
Alarm I/O	Submenu	Program the alarm input and output functionality.
Connections	Submenu	Connection parameters
Test signals	Submenu	Test patterns and texts
Camera ID	Submenu	Select to access ID submenu
Privacy masking	Submenu	Sets up a masking area
Flip	Submenu	Selects flip submenu
Default ALL	Submenu	Returns all settings for all modes to factory defaults

5.6.1 Language submenu

Item	Selection	Description
Language	English Spanish French German Portuguese Russian Simplified Chinese	Displays the menus on the OSD in the chosen language.
EXIT		Returns to Install menu.

5.6.2 Lens Wizard submenu

Item	Selection	Description
Lens type	Manual, DC-iris	Select the matching lens type to force the camera to the correct lens mode.
DC- iris setup	Open, Close, Auto	Selects the type of control for DC-iris lens. Open - the DC-iris is fixed to open. Close - the DC-iris is fixed to close. Auto - the aperture of the lens is adjusted automatically.
DC-iris speed	0,1,2...255	Adjusts the convergence speed of DC-iris.
DC-iris calibration		The convergence speed is automatically determined using the built-in calibration mechanism.

Item	Selection	Description
Set Backfocus now		Select to fully open the iris. Follow the instructions below for setting the backfocus for your particular lens type. After focusing the object of interest remains in focus under bright and low light conditions.
EXIT		Returns to Install menu.

Adjustment procedure DC-iris Lens

1. Unlock the back focus locking button.
2. Access the **Lens Wizard** menu.
3. **Set Back Focus Now** is highlighted in the menu.
4. Turn the back focus adjustment as required.
5. Lock the back focus locking button.
6. Exit the menu.

Adjustment procedure Manual-iris Lens

1. Unlock the back focus locking button.
2. Adjust the lens to the maximum lens opening.
3. Turn the back focus adjustment as required.
4. Lock the back focus locking button.
5. Adjust lens opening to suit scene.

5.6.3 Synchronization submenu

Item	Selection	Description
Synchroniza- tion	Internal Line lock	Internal - for free running camera operation. Line lock - to lock to the AC power supply
Vertical phase	0, 1, ... 359	Adjusts the vertical phase offset (when in LINE LOCK mode and a valid power supply frequency is detected).
EXIT		Returns to Install menu.

5.6.4 Alarm I/O submenu

Item	Selection	Description
Input	None, high, low	Select none to disable the alarm input. Select active-high or active-low for the alarm input connector.
Input action	None, Mode 1 to 6, Night mode	Selects the operating mode of the camera when the alarm input is active.
Output	Normally open, Normally closed	Selects the relay output mode.
Output action	VMD, Ext. device, Night mode, Filter toggle	VMD: - output relay closes on VMD alarms. External device: - make the output relay available to remote communication devices. Night mode: - output relay closes when camera is in monochrome mode. Filter toggle: - output relay closes just before the IR filter starts moving and opens when video level has stabilized (2 to 3 seconds)
EXIT		Returns to Install menu.

5.6.5 Connections submenu

Item	Selection	Description
Bilinx Comms.	On, Off	If Off, Bilinx communications is disabled.
Camera buttons	Enable, disable	Enable or disable the camera buttons from working.
Cable compensation	Off, Default, RG59, RG6	Cable compensation is used to avoid the need for amplifiers in long distance coaxial connections up to 1000 m (3000 ft). For optimum results select the coaxial cable type used or, if unknown, select default.
Compensation level	0,1,2 . . .+15	Sets the level of cable compensation
EXIT		Returns to Install menu.

5.6.6 Test signal submenu

Item	Selection	Description
Show camera ID	Off, On	Select On to overlay the camera ID on the video test signal.
Test pattern	Color bars, Raster, Impulse, Cross Impulse, Crosshatch	Select the desired test pattern to help installation and fault-finding.
EXIT		Returns to Install menu.

5.6.7 Camera ID submenu

Item	Selection	Description
Camera ID		Enter a 17-character camera name. Use Left/Right to change position in the string; use up/down to select character. Use Select to exit.
Display ID pos.	Off, Top left, Top right, Bottom left, Bottom right	Select the screen position of the camera ID.
Camera ID border	On, Off	Displays a grey border behind the camera ID to make it easier to read.
MAC address		Shows MAC address (factory set, cannot be changed).
Ticker bars	On, Off	The ticker bar moves continuously to show that the image is live and not frozen or played back.
Mode ID pos.	Off, Top left, Top right, Bottom left, Bottom right	Camera mode is displayed on the screen in the selected position.
EXIT		Returns to Install menu.

5.6.8 Privacy masking submenu

Item	Selection	Description
Mask	1 to 15	15 different areas can be masked.
Pattern	Black, Grey, White, Noise	Selects pattern for all masks.
Active	On, Off	Turns each of the masks on or off.
Mosaic	On, Off	Turns mosaic on or off.
Window	Submenu	Select to open a window in which to define the mask area.

Selecting an area for privacy masking

To set-up an area for privacy masking, access the area menu by selecting the **Area** option from the privacy masking menu. Upon entering the **Area** menu, the current area is displayed with the upper left corner flashing. The flashing corner of the image can be moved with the Up, Down, Left, Right arrow keys. Pressing the Select key moves the flashing cursor to the opposite corner, which can now be moved. Pressing Select again freezes the area and exits the area menu.

5.6.9 Flip submenu

Item	Selection	Description
Flip	Off horizontal Vertical Both	Selects the flip mode.
EXIT		Returns to Install menu.

5.6.10 Defaults submenu

Item	Selection	Description
Restore All	No, Yes	Restores all settings of the six modes to their default (factory) values. Select YES then press the Menu/Select button to restore all values. When completed the message RESTORED! is shown.

6 Troubleshooting

6.1 Resolving problems

The following table is intended to help you identify the causes of malfunctions and correct them when possible.

Malfunction	Possible causes	Solution
No image transmission to remote location.	Defective camera.	Connect a local monitor to the camera and check the camera function.
	Faulty cable connections.	Check all cables, plugs, contacts and connections.
	Incorrect cable connections.	When using DC power ensure that polarity is correct.
No connection established, no image transmission.	The unit's configuration.	Check all configuration parameters.
	Faulty installation.	Check all cables, plugs, contacts and connections.

6.2 Customer service

If you cannot resolve a fault, please contact your supplier or system integrator, or contact Bosch Security Systems Customer Service directly.

The Installer should write down all information regarding the unit so that it can be referenced for warranty or repair. The version numbers of the firmware and other status information can be seen when the unit starts or by opening the **Install** menu. Note down this information and the information found on the camera label before contacting customer service.

7 Maintenance

7.1 Repairs

**CAUTION!**

Never open the casing of the camera. The unit does not contain any user serviceable parts. Ensure that all maintenance or repair work is performed only by qualified personnel (electrical engineering or network technology specialists). If in doubt, contact your dealer's technical service center.

7.1.1 Transfer and disposal

The camera should only be passed-on together with this installation guide. The unit contains environmentally hazardous materials that must be disposed of according to law. Defective or superfluous devices and parts should be disposed of professionally or taken to your local collection point for hazardous materials.

8 Technical Data

8.1 Specifications

Type number	VBN-5085-C11	VBN-5085-C21	VBN-5085-C51
Standard	PAL	NTSC	PAL
Active pixels	976 x 582	976 x 494	976 x 582
Rated supply voltage	+12 VDC 24 VAC (50 Hz)	+12 VDC 24 VAC (60 Hz)	230 VAC 50 Hz

All versions

Imager	1/3-inch 960H CCD
Resolution	720TVL sensor resolution
Sensitivity (30IRE)	<0.04 lux <0.02 lux (in monochrome mode)
SNR	> 54 dB
Video output	1 Vpp, 75 Ohm
Synchronization	Internal, Line Lock
Shutter	Auto (1/60 [1/50] to 1/100000) Selectable, fixed, flickerless, default
Day/Night	Color, Mono, Auto
Sens Up	Adjustable from Off to 10x
AGC	AGC On or Off (0 - 40 dB) selectable
Dynamic engine	XF Dynamic, HDR, Smart BLC
Dynamic Range	94 dB
Dynamic Noise Reduction	3D-NR, 2D-NR
Sharpness	Sharpness enhancement level selectable
White Balance	ATW indoor, ATW outdoor, ATW hold and manual
Contrast Enhancement	Low, Medium, High
Lens type	Manual or DC iris

Lens mount	CS compatible, C-mount compatible with optional adapter ring
Test pattern generator	Color bar, Raster, Impulse, Cross Impulse, Cross hatch
Video Motion Detection (VMD)	4 areas, fully programmable
Privacy Masking	15 independent areas, fully programmable; black, white, grey, noise
E-zoom	Up to 16x
Digital Image Stabilizer	On/Off
Communication	Two-way Bilinx (bi-directional)
Languages (OSD)	English, Spanish, French, German, Portuguese, Russian, Simplified Chinese
Modes	6 programmable (preset) modes: 24-hour, Traffic, Low-light, Smart BLC, Low noise, Vibrant
Peak White Invert	Suppresses highlights in scenes
Power consumption	12 VDC 360 mA 24 VAC 330 mA 120-240 VAC 60 mA
Dimensions (H x W x L)	58 x 66 x 122 mm (2.28 x 2.60 x 4.80 in) without lens
Weight (12 VDC/ 24 VAC)	500 g (1.10 lb) without lens
Weight (230 VAC)	600 g (1.32 lb) without lens
Tripod mount	Bottom (isolated) and top 1/4" 20 UNC
Operating temperature	-20 °C to +55 °C (-4 °F to +131 °F)
Controls	OSD with softkey operation

8.1.1 Dimensions

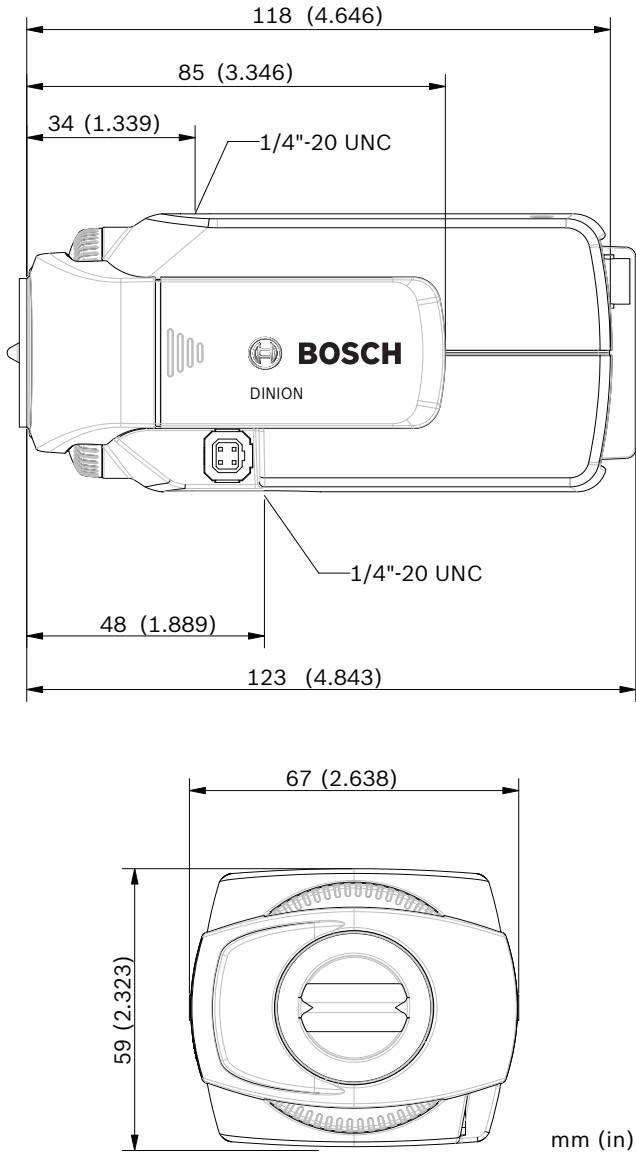

Figure 8.1 Dimensions

8.1.2 Accessories

- Indoor mounting brackets
- Outdoor environmental housings
- Lenses (varifocal, fixed and motorized zoom)
- Bilinx communication interface box and software

Contact a Bosch representative in your area for the latest available accessories or visit our website at

www.boschsecurity.com

Bosch Security Systems

www.boschsecurity.com

© Bosch Security Systems, 2013

Free Manuals Download Website

<http://myh66.com>

<http://usermanuals.us>

<http://www.somanuals.com>

<http://www.4manuals.cc>

<http://www.manual-lib.com>

<http://www.404manual.com>

<http://www.luxmanual.com>

<http://aubethermostatmanual.com>

Golf course search by state

<http://golfingnear.com>

Email search by domain

<http://emailbydomain.com>

Auto manuals search

<http://auto.somanuals.com>

TV manuals search

<http://tv.somanuals.com>