

Plena Mixer Amplifier



Security Systems

en | Installation and User Instructions
PLE-2MA120-US
PLE-2MA240-US

BOSCH

Important safeguards

Alerts on the apparatus



This symbol found on the apparatus indicates hazards arising from dangerous voltages.



This symbol found on the apparatus indicates the user should read all safety statements found in the operating instructions.



This symbol found on the apparatus indicates double insulation.



Warning

To reduce the risk of fire or electrical shock, do not expose this apparatus to rain or moisture.



This symbol found on the apparatus indicates that the apparatus must be placed in a separate collection facility for electronic waste and not disposed with household waste.

- 1 Read instructions - All the safety instructions for use should be read before the system is operated.
- 2 Retain instructions - The safety instructions and operating instructions should be retained for future reference.
- 3 Heed warnings - All warnings on the unit and in the operating instructions should be adhered to.
- 4 Follow instructions - All operating instructions and instructions for use should be followed.
- 5 Cleaning - Unplug system units from the mains outlet before cleaning. Do not use liquid cleaners or aerosol cleaners. Use only a dry cloth for cleaning.
- 6 Attachments - Do not use attachments not recommended by the product manufacturer as they may cause hazards.
- 7 Water and Moisture - Do not use this unit near water, for example near a bathtub, washbowl, kitchen sink, or laundry basket, in a wet basement, near a swimming pool, in an unprotected outdoor installation or any area which is classified as a wet location.
- 8 Accessories - Do not place this unit on an unstable stand, tripod, bracket or mount. This unit may fall, causing serious injury to a person and serious damage to the unit. Use only a stand, tripod, bracket or mount recommended by the manufacturer, or sold with the product. Any mounting of the unit should follow the manufacturer's instructions, and should use a mounting accessory recommended by the manufacturer. An appliance and cart combination should be moved with care. Quick stops, excessive force, and uneven surfaces may cause the appliance and cart combination to overturn.
- 9 Ventilation - Openings in the enclosure, if any, are provided for ventilation and to ensure reliable operation of the unit and to protect it from overheating. These openings must not be blocked or covered. The unit should not be placed in a built-in installation unless proper ventilation is provided or the manufacturer's instructions have been adhered to. Maintain a minimum distance of 2 inch (50 mm) around the front, the rear, and the sides of the unit for sufficient ventilation.
- 10 Heat sources - Do not install the unit near any heat sources such as radiators, stoves, or other apparatus that produce heat (including amplifiers).
- 11 Open flames - No open flames, such as lighted candles, should be placed on the unit.
- 12 Power sources - Units should be operated only from the type of power source indicated on the marking label. If you are not sure of the type of power supply you plan to use, consult your appliance dealer or local power company. For units intended to operate from battery power, or other sources, refer to the "Installation and User Instructions".
- 13 Grounding or polarisation - This unit may be equipped with a polarised alternating current line plug (a plug having one blade wider than the other). This plug will fit into the power outlet only one way. This is a safety feature. If you are unable to insert the plug fully into the outlet, try reversing the plug. If the plug still fails to fit, contact your electrician to replace your obsolete outlet. Do not defeat the safety purpose of the polarised plug. Alternatively, this unit may be equipped with a 3-wire grounding type plug having a third (grounding) pin. This plug will only fit into a grounding-type power outlet. This is a safety feature. If you are unable to insert the plug into the

- outlet, contact your electrician to replace your obsolete outlet. Do not defeat the safety purpose of the grounding-type lug.
- 14 Power-Cord Protection - Power supply cords should be routed so that they are not likely to be walked on or pinched by items placed upon or against them, paying particular attention to cords and plugs, convenience receptacles, and the point where they exit from the appliance.
- 15 Overloading - Do not overload outlets and extension cords as this can result in a risk of fire or electrical shock.
- 16 Object and Liquid Entry - Never push objects of any kind into this unit through openings as they may touch dangerous voltage points or short-out parts that could result in a fire or electric shock. Never spill liquid of any kind on the unit.
- 17 Servicing - Do not attempt to service this unit yourself as opening or removing covers may expose to dangerous voltage or other hazards. Refer all servicing to qualified service personnel.
- 18 Damage Requiring Service - Unplug the unit from the outlet and refer servicing to qualified service personnel under the following conditions:
- When the power-supply cord or plug is damaged.
 - If liquid has been spilled, or objects have fallen into the unit.
 - If the unit has been exposed to rain or water.
 - If the unit does not operate normally by following the instructions for use. Adjust only those controls that are covered by the instructions for use, as an improper adjustment of other controls may result in damage and will often require extensive work by a qualified technician to restore the units to their normal operation.
 - If the unit has been dropped or the unit has been damaged.
 - When the unit exhibits a distinct change in performance; this indicates a need for service.
- 19 Replacement Parts - When replacement parts are required be sure the service technician has used replacement parts specified by the manufacturer or parts which have the same characteristics as the original part. Unauthorised substitutions may result in fire, electric shock or other hazards.
- 20 Safety Check - Upon completion of any service or repairs to the units, ask the service technician to perform safety checks to determine that the unit is in proper operating condition.
- 21 Lightning - For added protection of the units during a lightning storm, or when it is left unattended and unused for long periods of time, unplug it from the wall outlet and disconnect the cable system. This will prevent damage to the unit due to lightning and power-line surges.
- 22 Disconnection - To completely disconnect this unit from the AC mains, disconnect the power supply cord plug from the AC receptacle. The mains plug of the power supply cord shall remain readily operable to be able to disconnect power from the unit.
- 23 Before installing or operating this product, always read the Safety Instructions, which are available as a separate document (9922 141 7014x). These instructions are supplied together with all equipment that can be connected to the mains.

**American Users****Note**

This equipment has been tested and found to comply with the limits for a Class B digital device, pursuant to part 15 of the FCC rules. These limits are designed to provide reasonable protection against harmful interference in a residential installation.

This equipment generates, uses, and can radiate radio frequency energy and, if not installed and used in accordance with the instructions, may cause harmful interference to radio communications. However, there is no guarantee that interference will not occur in a particular installation. If this equipment does cause harmful interference to radio or television reception, which can be determined by turning the equipment OFF and ON, the user is encouraged to try to correct the interference by one or more of the following measures:

- Reorient or relocate the receiving antenna.
- Increase the separation between the equipment and the receiver.
- Connect the equipment into an outlet on a circuit different from that to which the receiver is connected.
- Consult the dealer or an experienced radio/TV technician for help.

**Canadian Users****Note**

This Class B digital device complies with Canadian ICES-003.

Cet appareil numérique de classe B est conforme à la norme NMB-003 du Canada.

Thank you for choosing a Bosch Security Systems product!

Table of contents

Important safeguards	2
Table of contents	3
1. Introduction	5
1.1 Purpose	5
1.2 Digital document	5
1.3 Intended audience	5
1.4 Related documentation	5
1.5 Alerts	5
1.6 Icons	5
1.6.1 Note icons	5
1.6.2 Caution, Warning, and Danger icons	5
1.7 Conversion tables	6
2. Description	7
2.1 The Plena product range	7
2.2 Contents of box	7
2.3 The Plena Mixer Amplifier	7
2.4 Controls, connectors and indicators	9
2.4.1 Front panel	9
2.4.2 Plena PLE-WP2Z3S wall panel	9
2.4.3 Rear panel	10
3. Installation	13
3.1 Unpack unit	13
3.2 Install unit in rack (optional)	13
3.3 Check settings/connections	13
3.4 Connect unit to mains	13
4. Connections and settings	15
4.1 Connecting inputs	15
4.1.1 DC supply (battery)	15
4.1.2 Priority microphone (input 1)	16
4.1.3 Secondary microphone (input 2)	17
4.1.4 Additional microphones (inputs 3 through 6)	17
4.1.5 Emergency inputs	18
4.1.6 Music source inputs	20
4.2 Connecting outputs	21
4.2.1 Zone 1 and 2	21
4.2.2 Call only	21
4.2.3 Music only	21
4.2.4 Line out/ loop through	21
4.2.5 Connecting speakers	22
4.3 Unit settings	23
4.3.1 Rear panel settings	23
4.3.2 Pin settings and labelling	25

5. Operation	27
5.1 Switch on and off	27
5.1.1 Switch on	27
5.1.2 Switch off	27
5.2 Microphone/line controls	28
5.3 Music controls	28
5.3.1 Source selection	28
5.3.2 Volume control	28
5.4 Tone control	28
5.4.1 Introduction	28
5.4.2 Microphone/line tone control	28
5.4.3 Music tone control	28
5.5 Output controls	29
5.5.1 Zone selection	29
5.5.2 Master volume control	29
6. Technical data	31
6.1 Electrical	31
6.1.1 Mains power supply	31
6.1.2 Battery power supply	31
6.1.3 Power consumption	31
6.1.4 Performance	31
6.1.5 RJ-45 input 2 x	31
6.1.6 Mic/line input 6 x	31
6.1.7 Music inputs 3x	32
6.1.8 Emergency / telephone 1 x	32
6.1.9 Loop through insert 1 x	32
6.1.10 Master/music output 1 x	32
6.1.11 Loudspeaker outputs 70 V, 25 V*	32
6.1.12 Loudspeaker output 4 Ohm*	32
6.2 Mechanical	32
6.3 Environmental	32

1 Introduction

1.1 Purpose

The purpose of these Installation and User Instructions is to provide information required for installing, configuring and operating a Plena Mixer Amplifier.

1.2 Digital document

These Installation and User Instructions are also available as a digital document in the Adobe Portable Document Format (PDF).

1.3 Intended audience

These Installation and User Instructions are intended for installers and users of a Plena system.

1.4 Related documentation

Safety Instructions (9922 141 1036x).

1.5 Alerts

Four types of alerts are used in this manual. The alert type is closely related to the effect that may be caused if it is not observed. These alerts - from least severe effect to most severe effect - are:

- **Note**
Alert containing additional information. Usually, not observing a note alert does not result in damage to the equipment or personal injuries.
- **Caution**
The equipment can be damaged if the alert is not observed.
- **Warning**
Persons can be (severely) injured, or the equipment can be seriously damaged, if the alert is not observed.
- **Danger**
Not observing the alert can result in death.

1.6 Icons

1.6.1 Note icons

The icons used in combination with Notes provide extra information about the Note. See the following examples:

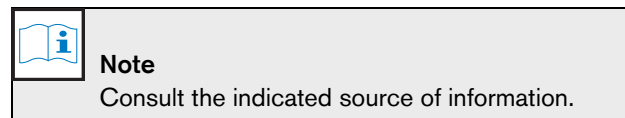
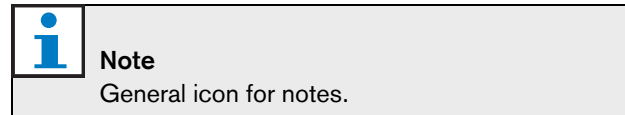

1.6.2 Caution, Warning, and Danger icons

The icons used in combination with Caution, Warnings, and Dangers indicate the type of hazard present. See the following examples:

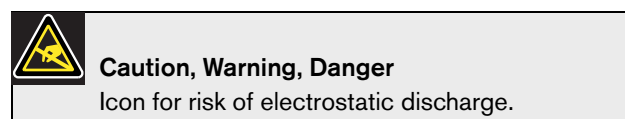
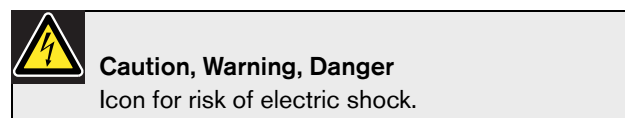
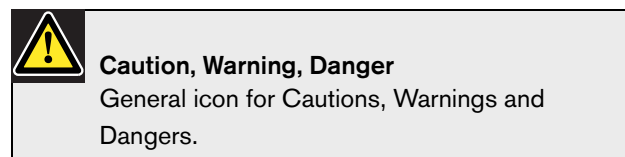

1.7 Conversion tables

In this manual, SI units are used to express lengths, masses, temperatures etc. These can be converted to non-metric units using the following information.

table 1.1: Conversion of units of length

1 in =	25.4 mm	1 mm =	0.03937 in
1 in =	2.54 cm	1 cm =	0.3937 in
1 ft =	0.3048 m	1 m =	3.281 ft
1 mi =	1.609 km	1 km =	0.622 mi

table 1.2: Conversion of units of mass

1 lb =	0.4536 kg	1 kg =	2,2046 lb
--------	-----------	--------	-----------

table 1.3: Conversion of units of pressure

1 psi =	68.95 hPa	1 hPa =	0.0145 psi
---------	-----------	---------	------------



Note

1 hPa = 1 mbar.

table 1.4: Conversion of units of temperature

$^{\circ}F = \frac{9}{5} \cdot (^{\circ}C + 32)$	$^{\circ}C = \frac{5}{9} \cdot (^{\circ}F - 32)$
--	--

2 Description

2.1 The Plena product range

The Plena Mixer Amplifier is part of the Plena product range. Plena provides public address solutions for places where people gather to work, worship, trade, or relax. It is a family of system elements that are combined to create public address systems tailored for virtually any application.

The Plena product range includes:

- mixers
- power amplifiers
- a music source unit
- a digital message manager
- a feedback suppressor
- call stations
- an All-in-One system
- a timer

The various elements are designed to complement each other thanks to matched acoustical, electrical and mechanical specifications.

2.2 Contents of box

The packaging box contains the following contents:

- PLE-2MA120-US, or PLE-2MA240-US
- Labels and colored pins for indicating favorite settings
- Power cord
- Plena Bonus CD
- Mounting brackets (LBC 1901/00)

2.3 The Plena Mixer Amplifier

The Plena Mixer Amplifier is a high performance, professional public address unit for mixing up to six separate microphone/line signals, and any one of three separate music signals. For a schematic overview of the Plena Mixer Amplifier, see figure 2.1 on the next page.

The volume of each microphone/line signal can be individually adjusted to obtain the required mix; the mixed output is controlled via the master volume control and separate high/low tone controls.

The unit is easy to use, and provides a crisp call or clear music. The amplifier also has enhanced features such as ducking level control, priority, labelling, and setting indicators.

All Microphone/line inputs can be switched between microphone level and line level sensitivity. The inputs are balanced but can also be used unbalanced. Phantom power can be selected via a DIP switch to provide power to condenser microphones. Input channels 1 and 2 can take priority over all other microphone and music inputs:

- Input 1 can be activated by contact closure on a PTT (push to talk). A chime can be configured to precede an announcement.
- Input 2 can be switched automatically if a signal is available at the input, for example, if someone speaks into the microphone (VOX activation).

A telephone/70 V emergency input with VOX activation is also provided for easy integration with another PA system or a telephone paging system. It has its own volume control and overrides all other inputs, including the call station and inputs 1 and 2.

The unit also has a line output to add amplifiers for larger systems that require more output power. This output can be switched to music only, for example, so that music on hold can be provided for the telephone system. Loop through input and output connections enable external sound processing equipment (for example, an equalizer or Plena feedback suppressor) to be connected between the preamplifier and the power amplifier stages. A feedback suppressor can ensure feedback-free, clear speech for all microphones.

Users can create custom labels for inputs, music sources, and output zones. These labels can be attached to the special holders at the front of the mixer amplifier. Colored pins can also be inserted at various positions around the volume and tone dial controls to indicate favorite settings for a particular application.

An LED meter monitors the master output before the zone selection. This signal is also present on the headphone connector below the output meter. For total reliability and ease of use, a limiter is integrated into the output stage to restrict output if the user applies too much signal.

The unit has 24 VDC backup input with built in 24 VDC battery charger. A separate battery charger is, therefore, not required. The charger charges the battery with a 0.5 A constant current until the battery voltage reaches 27.4 VDC. The charger then switches over to constant voltage charging (also known as float charging).

Note
 When using the unit with backup power of 24 V, make sure that the unit is always powered ON. When the unit is switched OFF, the batteries will be drained as this will be regarded as a power source. Consequently the unit will revert to 24 VDC power from the 24 V input

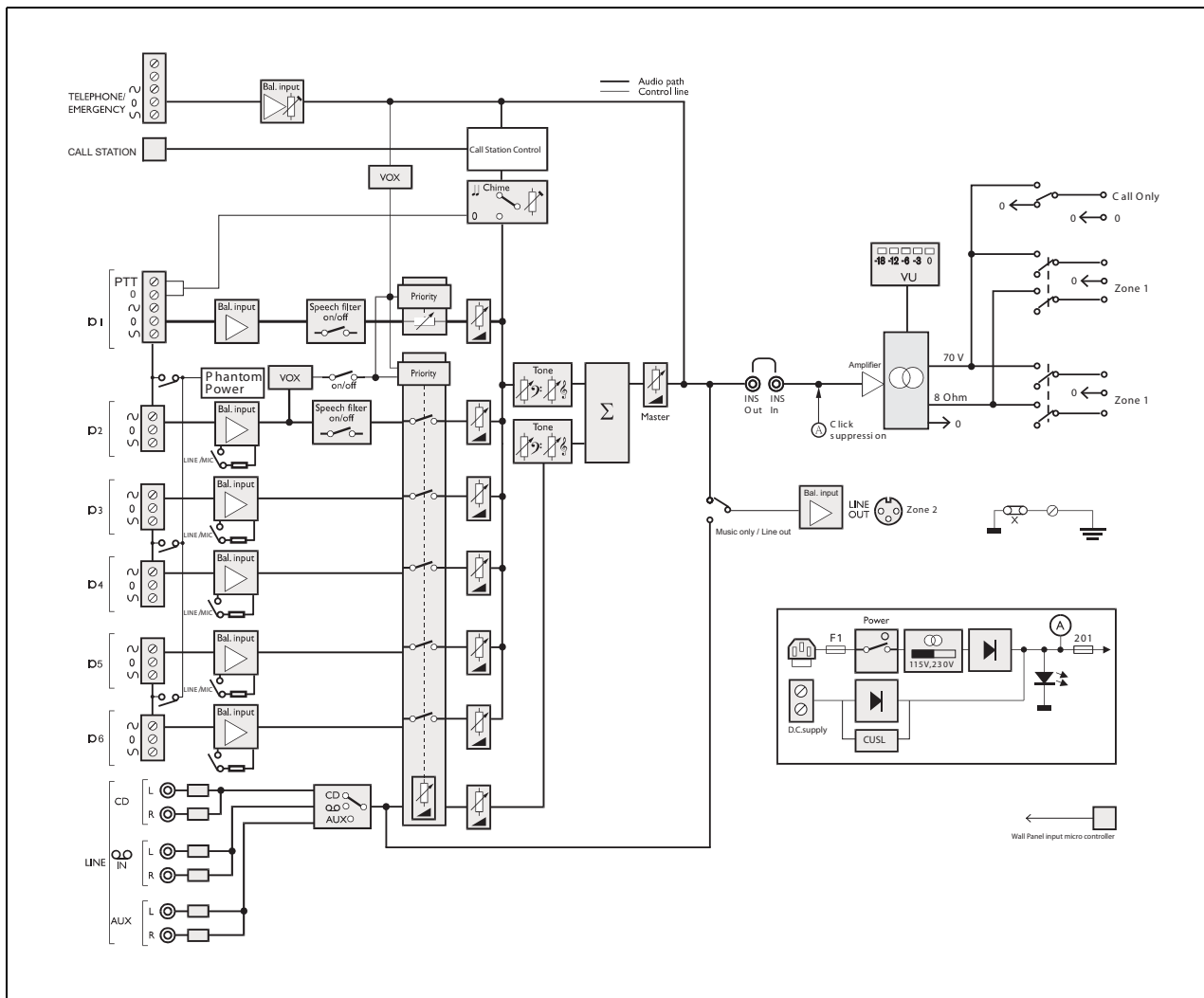

figure 2.1: Schematic overview of the Plena Mixer Amplifier

2.4 Controls, connectors and indicators

2.4.1 Front panel

See figure 2.2 for an overview of the controls and indicators.

- 1 Power button.
- 2 Label holder for user-defined description of microphone/line inputs - custom labels can be created by user.
- 3 Master high tone control for microphone/line inputs.
- 4 Label holder for user-defined description of music sources - custom labels can be created by user.
- 5 Master high tone control for music inputs.
- 6 Label holder for user-defined description of zone names - custom labels can be created by user.
- 7 Master volume control - controls all inputs except emergency and call station.
- 8 Output level meter (-18 db, 0 db)
- 9 Input level control:
 - microphone/line 1
 - microphone/line 2
 - microphone/line 3
 - microphone/line 4
 - microphone/line 5
 - microphone/line 6
- 10 Master low tone control for microphone/line inputs.
- 11 Music source selector (for music inputs 1, 2, and 3).
- 12 Music source volume control.
- 13 Master low tone control for music inputs.
- 14 Zone 1 selection button.
- 15 Zone 2 selection button.

16 Air inlet holes.

Note
Do not obstruct the airflow into the unit.

17 Headphone socket.

Note
Users can create custom labels for the: microphone/line inputs, description of the music sources, and audio output zones 1 and 2. These labels can be attached to the mixer amplifier at position numbers 2, 4, and 6 (see figure 2.2). Colored pins can also be inserted at various positions around the dial controls to indicate the favorite settings for a particular application. For more information on inserting and removing pins, see section 4.3.2.

2.4.2 Plena PLE-WP2Z3S wall panel

The optional Plena PLE-WP2Z3S wall panel can be used to remotely control the unit from a maximum of four remote locations. The appearance of the wall panel is matched to the Bosch loudspeaker volume controls.

The zone can be activated or deactivated, and the music source can be easily changed. The status of each zone and music source is indicated by an LED.

A standard CAT 5 cable is used to connect the wall panel to the mixer-amplifier. The maximum distance is 200 m. Please refer to the relevant datasheet for more information.

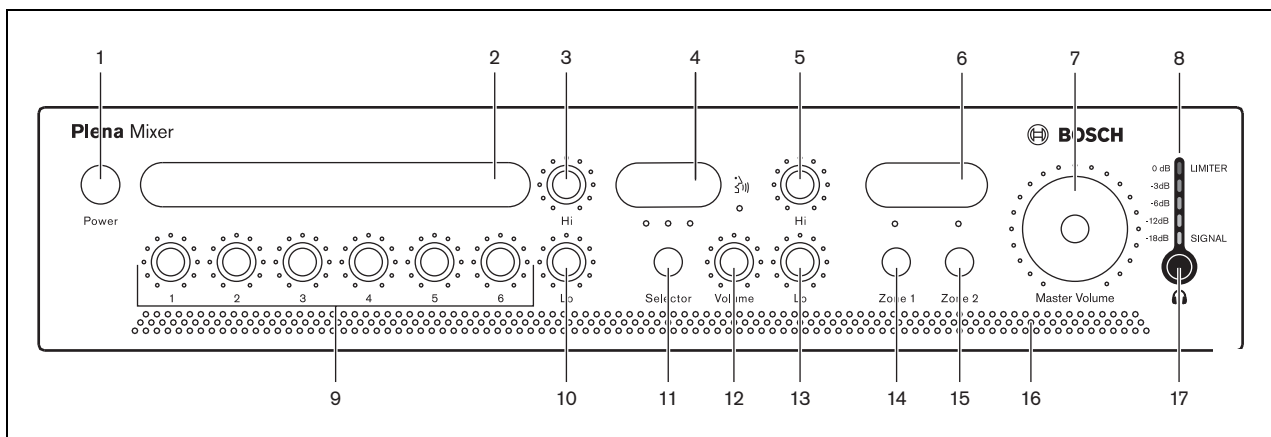



figure 2.2: Front panel

2.4.3 Rear panel

See figure 2.3 for an overview of the connectors and switches:

- 1 Cooling fan.

	Note Always allow adequate space at the rear of the unit for ventilation.
---	---

- 2 Microphone/line 1 input with trigger, Euro style pluggable screw terminal connector - DIP switch settings for: chime, PTT (push to talk), mic/line, speech filter, and phantom power (see number 3).
- 3 DIP switch for microphone/line 1 and microphone/line 2 (see numbers 2 and 4 respectively).
- 4 Microphone/line 2 input, 3 pin Euro style pluggable screw terminal connector - DIP switch settings for speech filter, mic/line, VOX, and phantom power (see number 3).
- 5 Microphone/line 3 input, 3 pin Euro style pluggable screw terminal connector - DIP switch settings for mic/line, and phantom power (see number 6).
- 6 DIP switch for microphone/line 3 and microphone/line 4 (see numbers 5 and 7 respectively).
- 7 Microphone/line 4 input, 3 pin Euro style pluggable screw terminal connector - DIP switch settings for mic/line, and phantom power (see number 6).
- 8 Microphone/line 5 input, 3 pin Euro style pluggable screw terminal connector - DIP switch settings for mic/line, and phantom power (see number 9).
- 9 DIP switch for microphone/line 5 and microphone/line 6 (see numbers 8 and 10 respectively).
- 10 Microphone/line 6 input, 3 pin Euro style pluggable screw terminal connector - DIP switch settings for mic/line, and phantom power (see number 9).
- 11 Mains voltage switch, C13 - 115/230 VAC 50/60 Hz.
- 12 Tel. emergency/70V input, Euro style pluggable screw terminal connector - VOX function. This input has highest priority.
- 13 Call station input, RJ-45 connector - PLE-2CS or PLE-2CS-MM, chimes are in call station. This input has second highest priority.

- 14 Remote control wall-panel-input, RJ-45 connector. Wall panel incorporates: BGM source selection, and zone on/off control.
- 15 Telephone emergency/70V input volume control - control range -25 dB to 0dB (see number 12).
- 16 Chime volume control for microphone/line input 1 (see number 2).
- 17 Ducking level control for microphone/line inputs 1 and 2 and call stations.
- 18 Music input (number 1 disc), 2x RCA/cinch connectors. Stereo, summed mono.
- 19 Music input (number 2 radio), 2x RCA/cinch connectors. Stereo, summed mono.
- 20 Music input (number 3 auxiliary), 2x RCA/cinch connectors. Stereo, summed mono.
- 21 Pre-out, amp in insert, 2x RCA/cinch connector - can be used for EQ or feedback suppressor.
- 22 Master switch for line out or music (see number 23).
- 23 Music master output, XLR connector - switch setting for line out, or music only (see number 22).
- 24 Outputs and 24 VDC in/out:
 - Zone 1 output, Euro style pluggable screw terminal connector - 70 V, 25 V and 4 Ohm.
 - Zone 2 output, Euro style pluggable screw terminal connector - 70 V, 25 V and 4 Ohm.
 - Call only, Euro style pluggable screw terminal connector 70 V.
 - 24 VDC in/out:
 - Input: 24 VDC backup power.
 - Output: built in charger, maximum 0.5 A. regulated output current. If battery charging is not required, output can be used for volume overrides or other purposes.
- 25 Mains fuse.
- 26 Ground connection screw.

	Note The unit must be earthed.
---	--

- 27 Mains connector (3-pole).

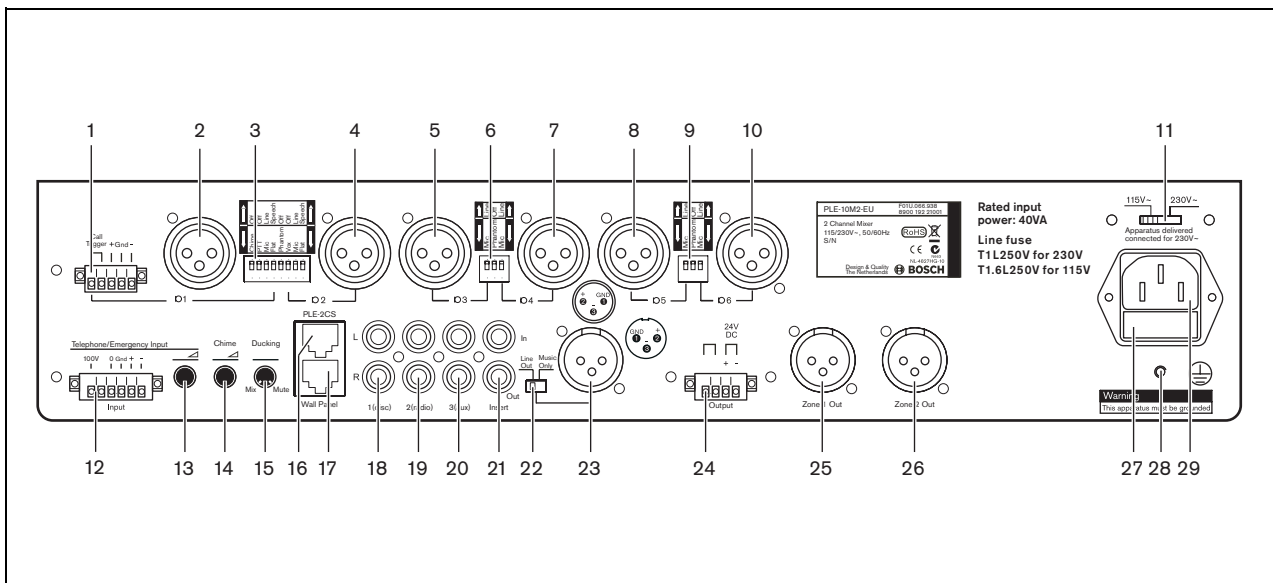

figure 2.3: Rear panel

Intentionally left blank

3 Installation

3.1 Unpack unit

- 1 Remove the unit from the box, and discard the packaging material according to local regulations.
- 2 Use your fingernails to carefully peel off the protective plastic film from the label holders. Do not use sharp or pointed objects.

3.2 Install unit in rack (optional)

The Plena Mixer Amplifier is intended for tabletop use, but you can also mount the unit in a 19" rack (see figure 3.1).

If you mount the unit in a rack, you must:

- ensure that it does not exceed the overheating temperature (55 °C ambient).
- use the included Bosch mounting brackets (LBC 1901/00).
- remove the 4 feet from the bottom of the unit.

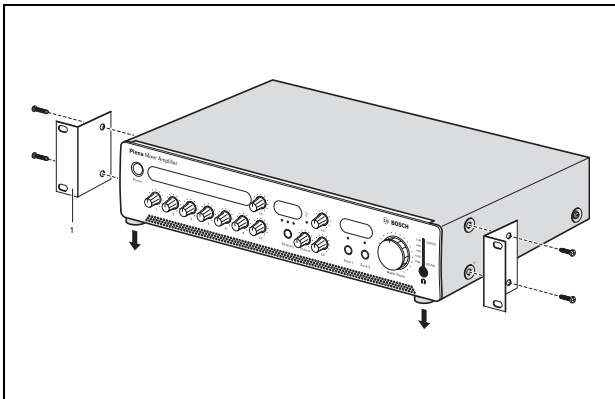

figure 3.1: Installing the unit in a rack

3.3 Check settings/connections

- 1 Connect any additional equipment (see section 4.1 and 4.2).
- 2 Check the settings (see section 4.3).

3.4 Connect unit to mains



Caution

Potential equipment damage. Before connecting power, always check the voltage selector on the rear panel of the unit.

- 1 Make sure the voltage selector (115V/ 230V) is correctly set for the country's main voltage (see figure 3.2).
- 2 Make sure the power switch on the front of the unit is set to Off.
- 3 Connect the power cord to the mains connector and plug it into the mains outlet.

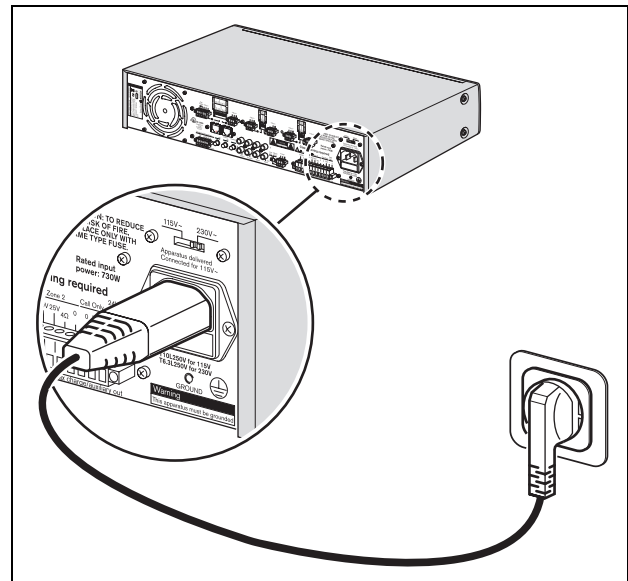

figure 3.2: Power connection and voltage selector

Intentionally left blank

4 Connections and settings

4.1 Connecting inputs

4.1.1 DC supply (battery)



Caution

The connection cable must have an in-line fuse. Use the type of fuse shown in the following figure.



Caution

Make sure the unit is grounded.

The Plena Mixer Amplifier has a 24 VDC input (terminal screw). This input can be used in mobile applications, such as boats where 120 or 230 VAC is not available or in applications that must continue to operate in case of a power failure.

When a 24 VDC battery is connected (typically consisting of two 12 VDC lead-acid batteries in series), the unit will operate on the supplied DC voltage.

The Plena Mixer Amplifier has as a built in charger, which charges the connected battery (or batteries if connected in series). A separate battery charger is, therefore, not required. The charger charges the battery with a 0.5 A constant current until the battery voltage reaches 27.4 VDC. The charger then switches over to constant voltage charging (also known as float charging). This means that a battery can be charged at the same rate it is discharging, and thus full capacity battery can be assured.

This type of charging is suited for low duty-cycle applications where a relatively high current or power is infrequently required.



Note

If battery charging is not required, the 0.5 A maximum output current can be used for volume overrides or other purposes instead.

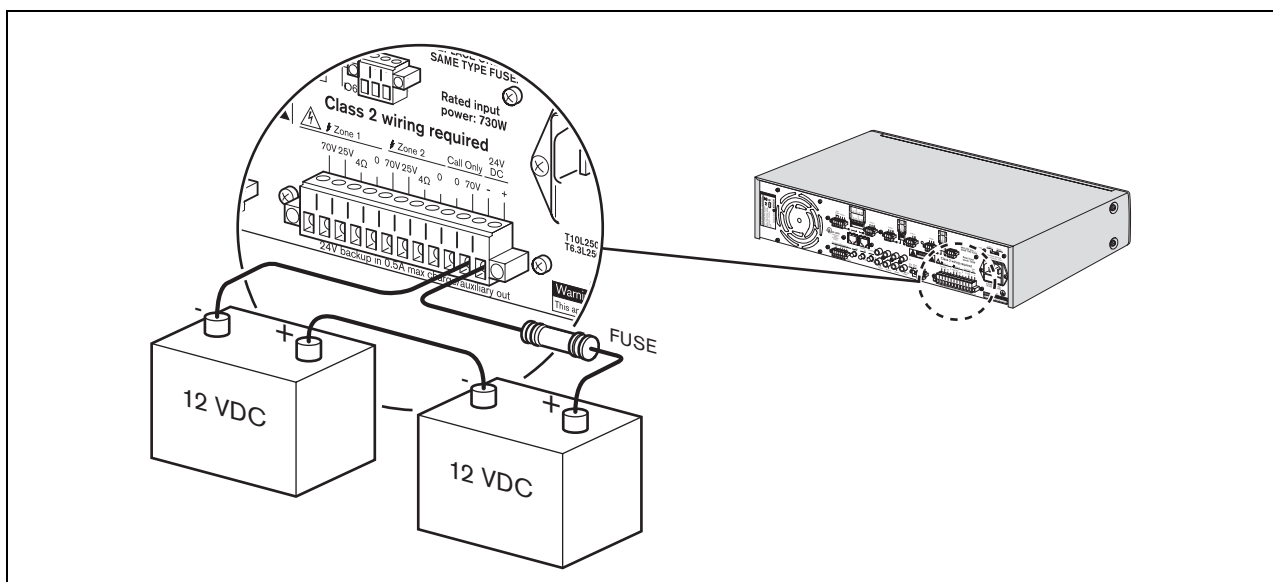

figure 4.1: Connecting a DC power supply

4.1.2 Priority microphone (input 1)

The priority microphone (or a generic call station) that can be used with push to talk (PTT) should be connected to “microphone/line 1 input with trigger”. The PTT mode can be activated by setting the DIP switch (3) at the rear of the unit.

Microphone/line 1 input with trigger has priority over all other microphone/line inputs. If, however, the “Tel. emergency/70V input” receives a signal, all inputs including microphone/line 1 input with trigger will be overruled.

The microphone/line 1 input with trigger has a Euro style pluggable screw terminal connector. This Euro style pluggable screw terminal connector has a trigger input which can be used in combination with the Euro connector.

The priority microphone can be connected to the microphone/line 1 input with trigger as follows:

- Euro connector with trigger. See figure 4.2.
- Euro connector only (without trigger).

Set the DIP switch settings for microphone/line 1 with trigger, as required. See section 4.3.



Note

When connecting an unbalanced line level (200 mV) signal to the microphone/line input, connect it as follows: Signal to +, connect to - and GND to ground.

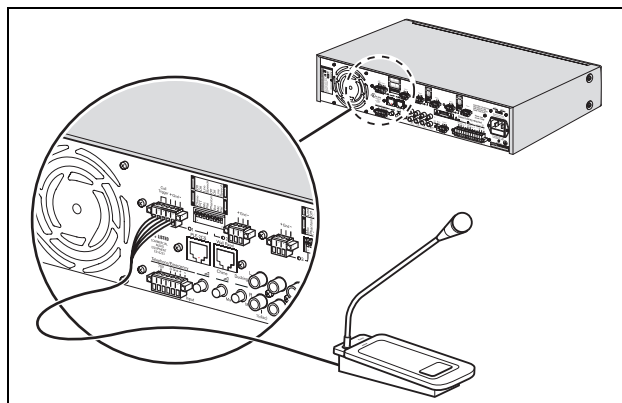

figure 4.2: Euro connector with trigger

4.1.3 Secondary microphone (input 2)

Connect a secondary microphone to “microphone/line input 2”. See figure 4.3.

Microphone/line input 2 has a DIP switch (3) at the rear of the unit for setting the VOX mode. If the DIP switch is set to VOX, the microphone/line input will automatically be switched when a signal is sensed at the microphone/line 2 input. For example, when someone speaks into the microphone, other sound will either be muted or ducked, depending on the setting of the ducking level control at the rear of the unit. See section 4.3.

The Tel. emergency/70V input, Call station input, and Microphone/line input 1 with trigger all have priority over the Microphone/line input 2. Therefore, any signal received on any one of these inputs will always be heard regardless of the ducking level control setting for Microphone/line input 2.

Set the DIP switch settings for microphone/line input 2 as required. See section 4.3.

4.1.4 Additional microphones (inputs 3 through 6)

Connect additional microphones to microphone/line inputs 3 through 6, as required. See figure 4.3. These microphones will mix with the background music.

Set the DIP switch settings for microphone/lines 3 through 6, as required. See section 4.3.

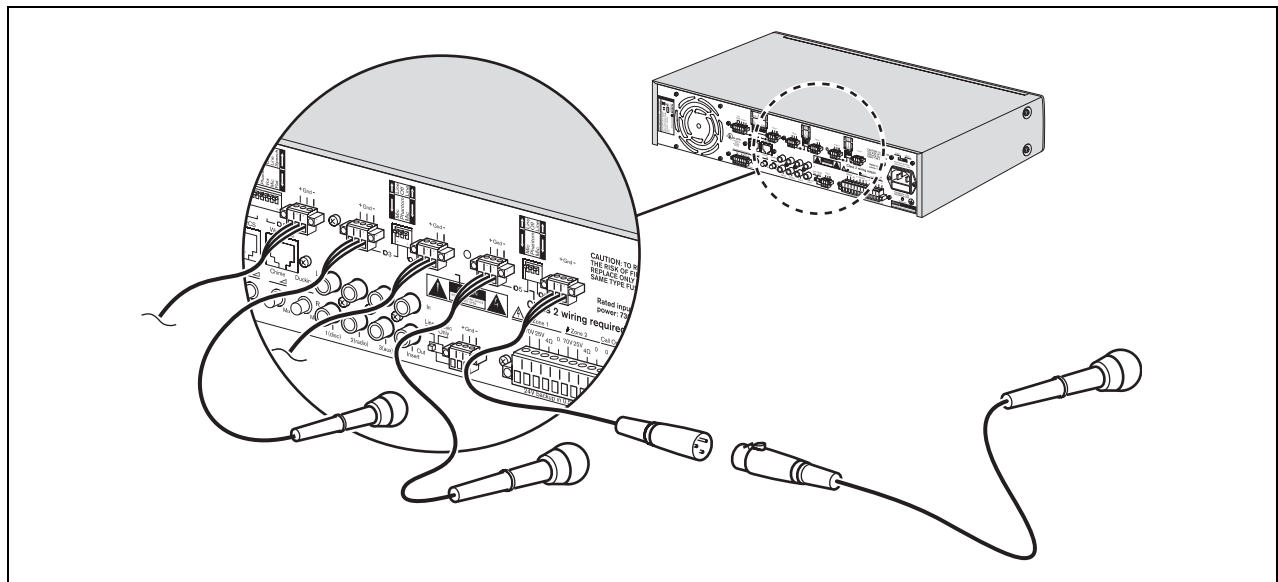

figure 4.3: Connecting microphone inputs

4.1.5 Emergency inputs

The Tel. emergency/70V input, with VOX functionality, is used for receiving emergency announcements or signals (such as a fire alarm). This input has absolute priority, and will overrule all inputs when an emergency announcement or signal is received.

Either a telephone line or a 70 V input signal can be connected to the Euro style pluggable screw terminal connector (12) at the rear of the unit. See section 4.1.5.1 and section 4.1.5.2.



Caution

Never connect telephone lines and a 70 V signal to the Euro style connector at the same time.

To adjust the volume of the emergency announcement or signal, turn the rotary dial (15) at the rear of the unit. For safety reasons, the volume of the emergency announcement or signal cannot be set to zero.

The master volume control setting (7) does not influence the volume setting of the emergency announcement or signal.



Note

Tel. emergency input does not mute the incoming signal so that an incoming pilot tone will be fed to the zone outputs. With this feature it is possible to use the mixer amplifier in a Bosch Voice Alarm System when using end of line boards (PLN-1EOL).

The signal that is delivered to the unit should be quiet when a call is not made. The pilot tone and frequencies below 300 Hz are filtered from the trigger signal so that the input will not trigger from a pilot tone or low frequency rumble.

4.1.5.1 Connecting 70 Volt input signal

Connect the 70 Volt input signal as shown in figure 4.4.

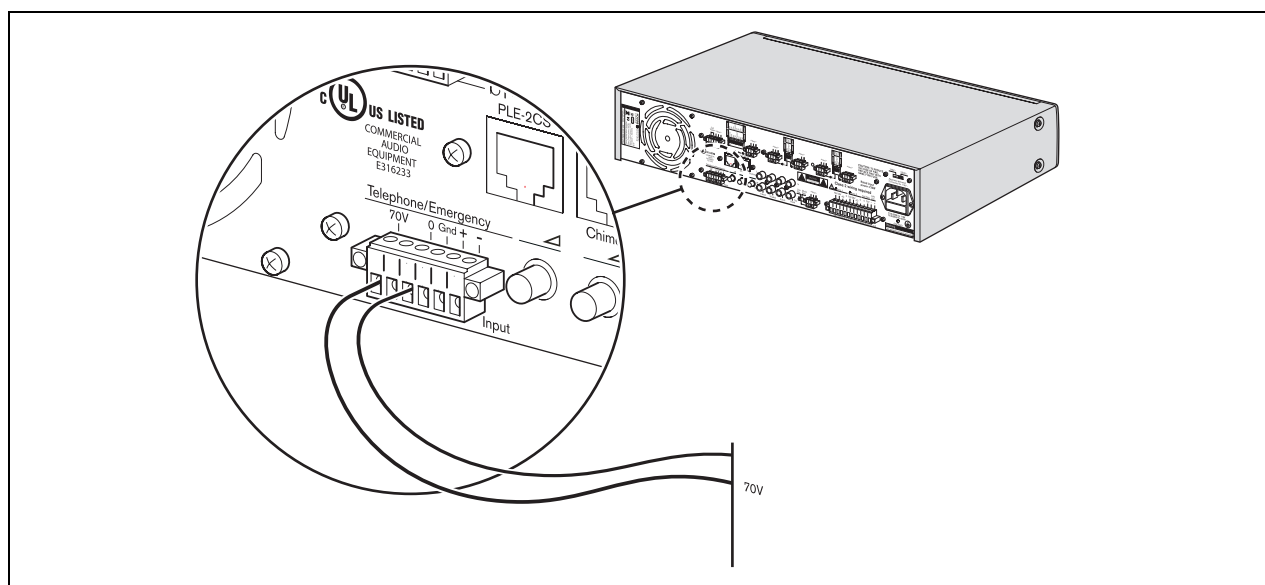

figure 4.4: Connecting 70 Volt input signal

4.1.5.2 Connecting telephone lines

Connect the telephone lines as shown in figure 4.5.



Caution

A connection to a telephone network must always be made via a telephone coupler that provides adequate isolation between the telephone network (PBX) and the Plena system. The telephone coupler must also meet all relevant requirements for this type of communication equipment as imposed by law and/or responsible telecommunication organizations in the country of use. Never try to make a direct connection between the telephone network and the mixer amplifier.

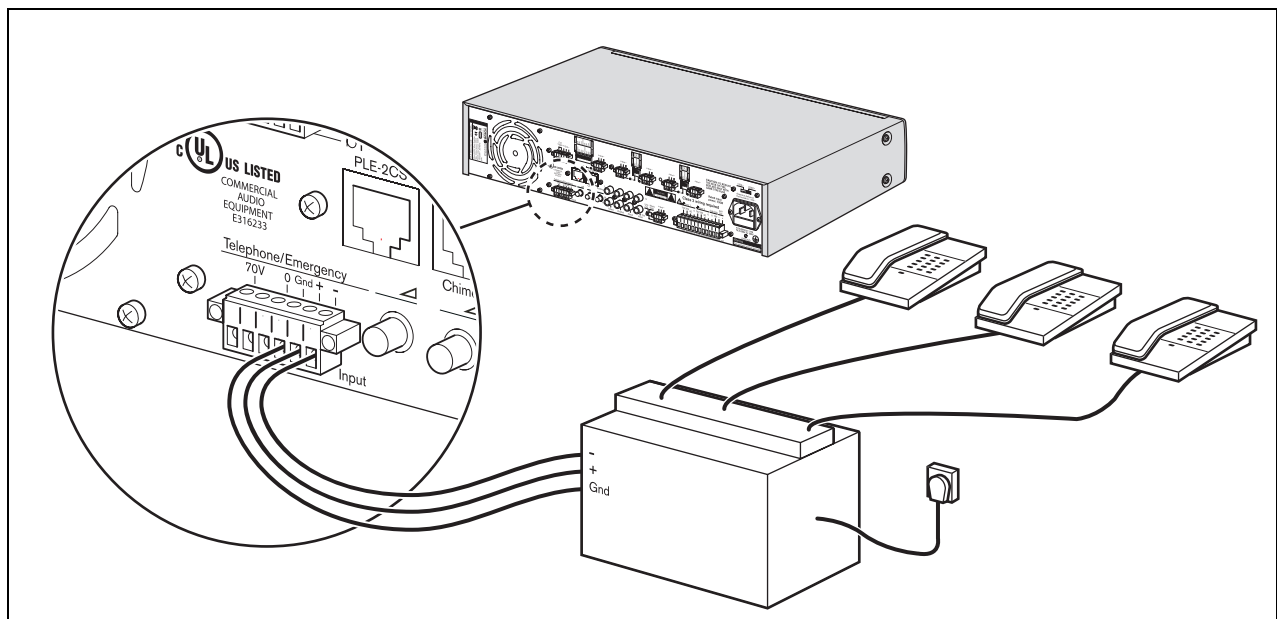

figure 4.5: Connecting emergency telephone lines

4.1.6 Music source inputs

When using a CD player, tuner or other auxiliary device for background music, connect the line-out connectors of the music source to the appropriate line-in connectors of the mixer amplifier.

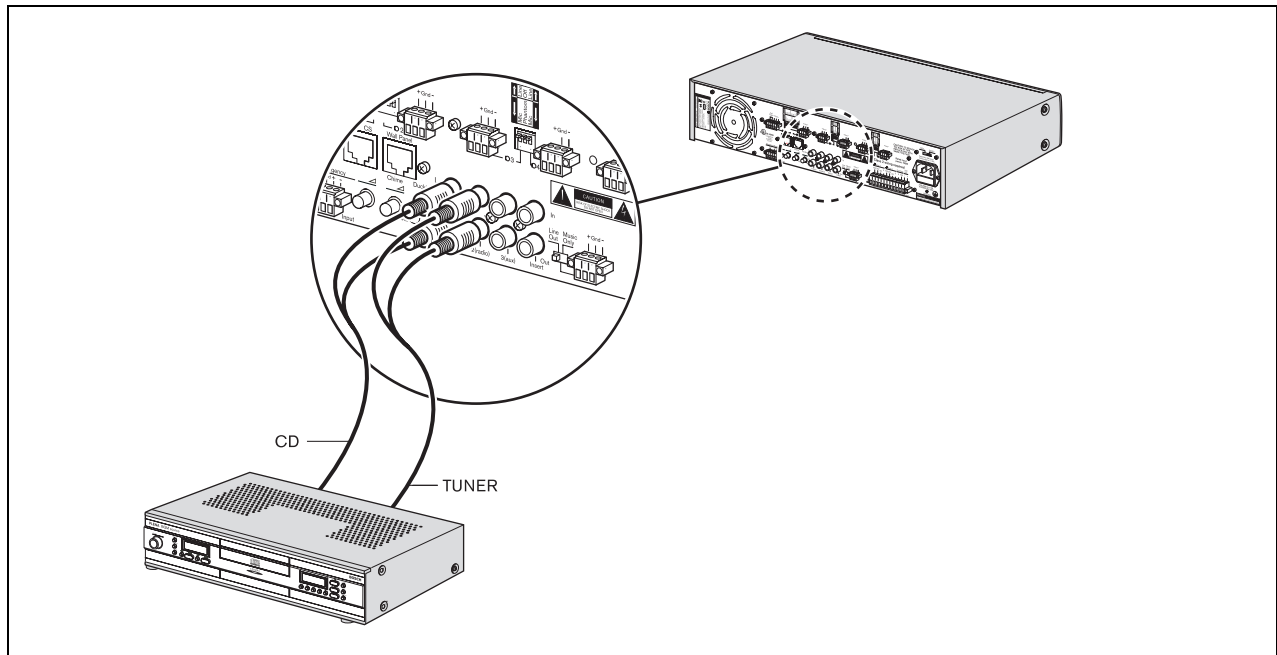

figure 4.6: Connecting music source inputs

4.2 Connecting outputs

4.2.1 Zone 1 and 2

Connect speakers to the 70 V, 25 V or 4 Ohm terminal on the Euro style pluggable screw terminal connector (24) at the rear of the unit.

Also see section 4.2.5 “Connecting speakers”.

4.2.2 Call only

Connect speakers to the 70 V terminal on the Euro style pluggable screw terminal connector (24) at the rear of the unit.

Also see section 4.2.5 “Connecting speakers”.

4.2.3 Music only

Use the music master output connector (23) to provide a dedicated music out source for another device. For example, the music master output can be connected to a telephone coupler, so that callers can listen to music when they are put on hold (see figure 4.7).

To select the dedicated music out source, set the master switch for “line out or music only” (22) to “music only”. Only the music inputs (18, 19, and 20) will be audible. All other inputs, including the Tel. emergency/70V input will not be sent to this output.

To hear all mixed inputs (microphone/line, emergency, and music) set the master switch for “line out or music only” (22) to “line out”.

4.2.4 Line out/ loop through

Use the Pre-out, amp in insert (21) external sound processing equipment (e.g. an equalizer or Plena feedback suppressor) to be connected between the preamplifier and the power amplifier stages. See figure 4.7.

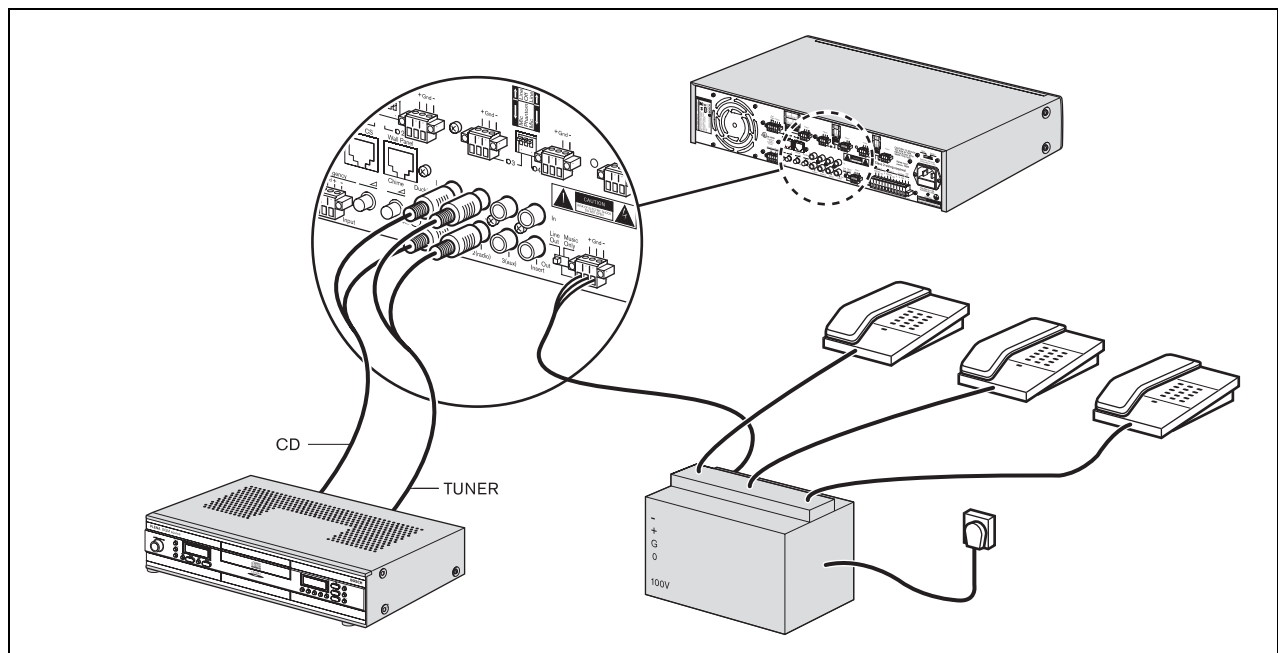

figure 4.7: Connecting music source inputs

4.2.5 Connecting speakers

4.2.5.1 Constant voltage loudspeakers

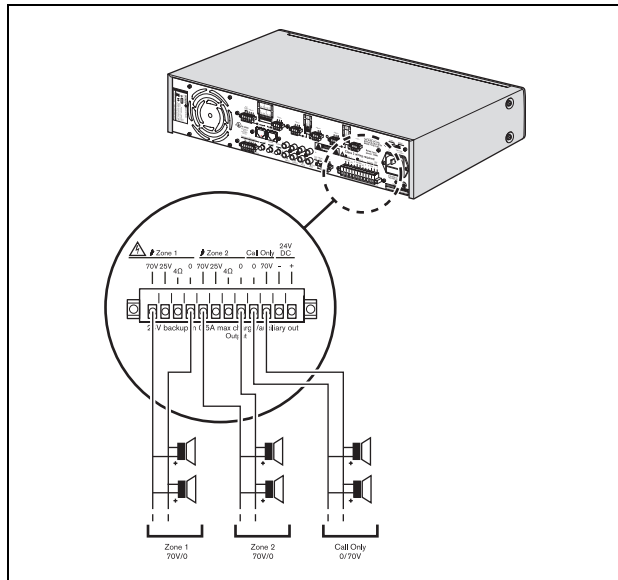

figure 4.8: Connecting speakers

The mixer amplifier can drive 70 V constant voltage loudspeakers.

Connect the loudspeakers in parallel and check the loudspeaker polarity for in-phase connection. The summed loudspeaker power should not exceed the rated amplifier output power.

You can use the Call Only output for 3-wire remote volume control override. You can also use this output as an extra zone where announcements can be heard, but not music.

4.2.5.2 Low impedance loudspeakers

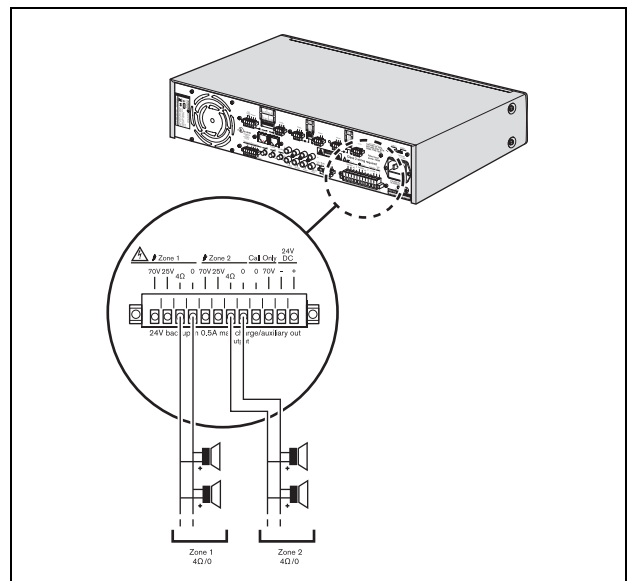

figure 4.9: Connecting speakers

Connect low impedance loudspeakers to the 4 Ohm/0 terminals. This output can deliver the rated output power into an 4 Ohm load. Connect multiple loudspeakers in a series/parallel-arrangement to make the combined impedance 4 Ohm or higher. Check the loudspeaker polarity for in-phase connection.

4.3 Unit settings

4.3.1 Rear panel settings

The unit can be quickly set-up for operation by setting the following controls at the rear of the unit:

- DIP switches
- Rotary dials
- Master switch for line out or music only.

See the following tables for an overview of the settings and typical examples of their use.

table 4.1: DIP switch settings

DIP switch	On	Off	Typical example (On)
Chime (mic/line 1)	Chime will be sounded at the beginning of an announcement.	Chime will not be sounded at the beginning of an announcement.	Announcement of train departure time.
PTT "Push to talk" (mic/line 1 only)	This input is muted when the push to talk contact is open. When the push to talk contact is closed: <ul style="list-style-type: none"> • this input is available for speech. • a chime will sound, if selected. • the music and other mic/line inputs will be reduced in volume to the level set by the ducking level control knob. 	Push to talk off. The signal will be mixed with the other mic/line signals. Microphone 1 will mix with the background music or the other microphones in the selected zones.	Users can have private conversations during live broadcasts (for example, with an all call call-station, such as the PLE-1CS).
Line	Input signal from line.	Input signal from microphone.	Depends on set-up.
Speech filter	Enhances clarity of speech, by cutting-off the lower frequencies of the signal.	Speech filter inactive.	Use for announcements
Phantom power	Provides power to condenser microphones.	Phantom power unavailable.	Enable phantom power if you use electret or condenser microphones.
VOX (mic/line 2 only)	Temporarily suppresses the background music to an adjustable "ducking level" (see table 4.2) while you speak into the microphone. The VOX mode is normally used with hand-held microphones such as the LBC 2900/15. Background music and announcements will be heard in the selected zones. A chime is not available in this mode.	VOX inactive. Microphone 2 will mix with the background music or the other microphones in the selected zones.	Use to make casual announcements (such as announcing the winner of a competition) while temporarily suppressing the background music to an adjustable ducking level.

table 4.2: Rotary controls

Rotary control	Effect	Typical example
Ducking level control	Sets the required ducking level when VOX and/or push to talk is active (see table 4.1). When the ducking level is set to mute, the music volume will be fully attenuated; when the ducking level is set to mix, both music and speech inputs can be heard - music and speech will be mixed. When ducking the music input is ducked (attenuated), the microphone/line inputs are always muted when a call is made.	Set the ducking level control to mute if you want the announcement to be heard without background music.
Chime volume control	Alters the chime volume. The mid range is -8 dB (40 V), which should be sufficient for most applications. Test the chime by switching on microphone 1. Remove the microphone after testing if it is not further required.	Set the volume of the chime to a higher level when the system is being used in large open areas or when important announcements have to be made.
Telephone emergency/70V volume control	Attenuates the emergency announcement or signal. Control range from -25 dB to 0 dB. For safety reasons, the volume of the emergency announcement or signal cannot be fully set to zero.	Set the volume of the emergency announcement to a higher level when the system is being used in large open areas.

**Note**

When PTT or VOX are selected, the ducking control controls between 3 dB attenuation (very little ducking) to $-\infty$ dB (muted).

When ducking, the music is also present on the Call only output. If you do not want this, set the ducking control to mute.

When ducking, music in a non-selected zone is also affected.

table 4.3: Master switch for line out or music only

Slide switch setting	Effect	Typical example
Line out	All mixed inputs (microphone/line, emergency, and music) are available.	Various set-ups are possible.
Music only	A dedicated music out source is available for another external device. Only the music inputs (18, 19, and 20) are available. All other inputs, including the Tel. emergency/70V input will be overridden.	The "music master output" can be connected to a telephone system, so that callers can listen to music when they are put on hold.

4.3.2 Pin settings and labelling

Users can create custom labels for the: microphone/line inputs, description of the music sources, and audio output zones 1 and 2. These labels can be attached to the mixer amplifier at position numbers 2, 4, and 6 (see figure 2.2). Colored pins can also be inserted at various positions around the dial controls to indicate the favorite settings for a particular application.

The pins are engineered in such a way that they cannot be taken out by hand. This is to prevent tampering. The pins are intended to be inserted once, during installation of the unit. The silver pins should be used to indicate the preferred settings of the unit. The red pins can optionally be used to indicate the maximum setting of a knob.

If these settings have to be changed, use a pair of soft-tipped pliers to carefully remove the pins. If you do not have a pair of soft-tipped pliers, you can use ordinary pliers instead, but first place some plastic tape on the tips of the pliers to prevent damaging the front of the unit.

To remove the clear plastic covers in front of the labels:

- 1 Carefully insert a small screwdriver into the cut-out at the bottom of the plastic cover.
- 2 Gently lift the cover, and bend it in the middle. Take care not to force the cover or the front panel.

To reattach the plastic covers with paper labels:

- 1 Insert the paper label into the holder at the front of the unit.
- 2 Pick up the cover, and then bend it slightly in the middle by hand.
- 3 Fit the cover into the slot at the front of the unit, and then gently release the cover, making sure that the paper label stays in place.

Intentionally left blank

5 Operation

5.1 Switch on and off

5.1.1 Switch on

**Caution**

Potential equipment damage. Before applying power, always check the voltage selector at the rear of the unit.

- 1 Make sure the voltage selector (115V/ 230V) is correctly set for the country's main voltage (see figure 5.1).
- 2 Set the power button (1) on the front of the unit to Off - popped out (see figure 5.2).

5.1.2 Switch off

Set the power button (1) on the front of the unit to Off - popped out (see figure 5.2).

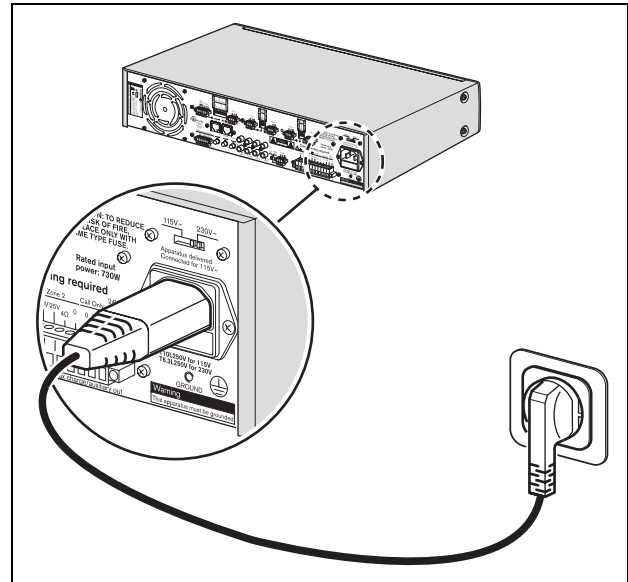

figure 5.1: Voltage selector

5.2 Microphone/line controls

Use the volume controls (9) to individually control the sound level of microphone/line inputs 1 through 6.



Note

Users can create custom labels for the: microphone/line inputs, description of the music sources, and audio output zones 1 and 2. These labels can be attached to the mixer amplifier at position numbers 2, 4, and 6 (see figure 5.2). Colored pins can also be inserted at various positions around the dial controls to indicate the favorite settings for a particular application.

5.3 Music controls

5.3.1 Source selection

Use the music source selector (11) to select one of the connected music sources.

5.3.2 Volume control

Use the music source volume control (12) to control the sound level of the selected music source.

5.4 Tone control

5.4.1 Introduction

The unique tone controls provide separate control for mic/line inputs and music inputs so that the voice on the microphones can be specifically optimized for excellent speech or singing. Correspondingly, the tone controls for background music provide the most appropriate music reproduction.

The tone controls are not standard bass and treble controls: they can be used as a traditional tone control with high and low control, but also have a powerful contour that addresses problems found in real situations.

5.4.2 Microphone/line tone control

The tone control for the microphone and line inputs boosts warmth in voices without boosting rumble, and cuts rumble without losing warmth in the low frequencies. In the high frequencies, the tone control boosts sparkle without adding sharpness, but when cutting is first, cuts harshness and sharpness without reducing clarity.

Use the Hi (high) and Lo (low) tone controls (see figure 5.2, numbers 3 and 10) to collectively change the tone of microphone/line inputs 1 through 6.

5.4.3 Music tone control

The tone control for the music inputs boosts deep bass first without making the sound boomy, and cuts rumble without losing warmth in the low frequencies. In the high frequencies, the tone control is similar to the microphone inputs, with slightly different frequencies to suit music reproduction.

Use the Hi (high) and Lo (low) tone controls (see figure 5.2, numbers 5 and 13) to change the tone of the selected music source.

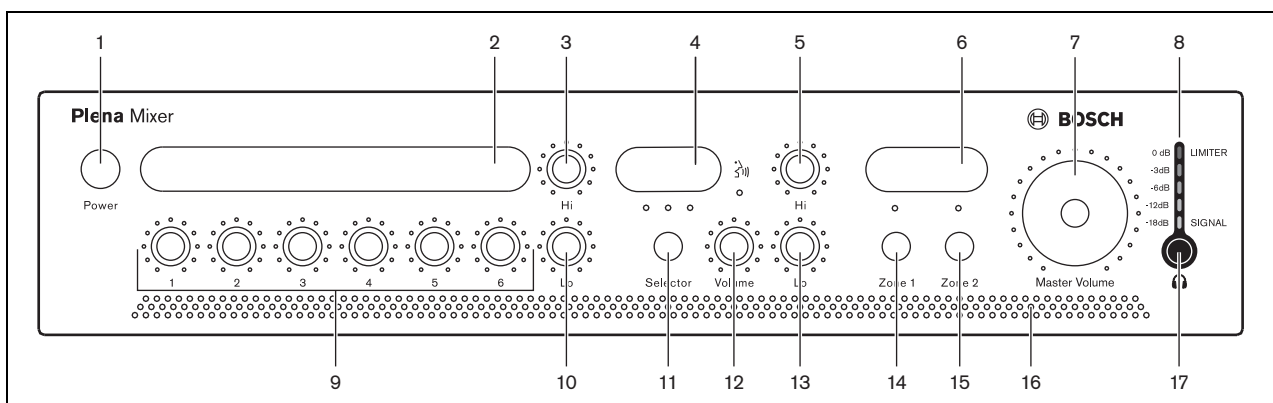

figure 5.2: Front panel

5.5 Output controls

5.5.1 Zone selection

Use the zone selection buttons (14 and 15) to route the music/microphone, line mix from the amplifier output to loudspeaker zone 1 and/or loudspeaker zone 2.

Announcements, however, are always routed to both zones, irrespective of the position of the zone selection buttons.

5.5.2 Master volume control

Use the master volume control dial (7) to collectively control the sound level of all outputs, except the emergency announcement/signal.

Intentionally left blank

6 Technical data

6.1 Electrical

6.1.1 Mains power supply

Voltage

115 - 230 VAC, $\pm 10\%$, 50/60 Hz

Inrush Current PLE-2MA120-US

8/16 A (230/115 VAC)

Inrush Current PLE-2MA240-US

9/19 A (230/115 VAC)

6.1.2 Battery power supply

Voltage

24 VDC, $\pm 15\%$

Current PLE-2MA120-US

6 A

Current PLE-2MA240-US

12 A

Charge current

0.5 ADC

Charge float voltage

27.4 VDC

6.1.3 Power consumption

PLE-2MA120-US (mains)

400 VA

PLE-2MA240-US (mains)

800 VA

6.1.4 Performance

Frequency response

50 Hz to 20 kHz (+1/-3 dB @ -10 dB ref. rated output)

Distortion

<1% @ rated output power, 1 kHz

Low Control

Max -12/+12 dB (frequency is level dependent)

Hi Control

Max -12/+12 dB (frequency is level dependent)

6.1.5 RJ-45 input 2 x

Call station input

For PLE-2CS(MM)

Wall panel input

For PLE-WP3S2Z

6.1.6 Mic/line input 6 x

Input 1 (Push-to-talk contact with ducking functionality)

5-pin Euro style, balanced, phantom

Input 2-6 (VOX with ducking functionality on input 2)

5-pin Euro style, balanced, phantom

Sensitivity

1 mV (mic); 200 mV (line)

Impedance

>1 kohm (mic); >5 kohm (line)

S/N (flat at max volume)

63 dB

S/N (flat at min volume/muted)

>5 dB

Dynamic range

100 dB

S/N (flat at max volume)

>63 dB (mic); >70 dB (line)

S/N (flat at min volume/muted)

>75 dB

CMRR

>40 dB (50 Hz to 20 kHz)

Headroom

>25 dB

Speech filter

-3 dB @ 315 Hz, high-pass, 6 dB/oct

Phantom power supply

16 V via 1.2 kohm (mic)

Speech filter

-3 dB @ 315 Hz, high-pass,

6 dB/oct

VOX (input 1 & 2)

attack time 150 ms; release time 2 s

6.1.7 Music inputs 3x

Connector	Cinch, stereo converted to mono
Sensitivity	200 mV
Impedance	22 kohm
S/N (flat at max volume)	>70 dB
S/N (flat at min volume/muted)	>75 dB
Headroom	>25 dB

6.1.8 Emergency / telephone 1 x

Connector	7-pin, Euro style pluggable screw terminal
Sensitivity tel	100 mV – 1 V adjustable
Sensitivity 70V	7 V – 70 V adjustable
Impedance	>10 kohm
S/N (flat at max volume)	>65 dB
VOX	threshold 50 mV; attack time 150 ms; release time 2 s

6.1.9 Loop through insert 1 x

Connector	Cinch
Nominal level	1 V
Impedance	>10 kohm

6.1.10 Master/music output 1 x

Connector	3-pin XLR, balanced
Nominal level	1 V
Impedance	<100 ohm

6.1.11 Loudspeaker outputs 70 V, 25 V*

Connector	Screw, floating
Max / rated PLE-2MA120-US	180 W / 120 W
Max / rated PLE-1906/10	360 W / 240 W

6.1.12 Loudspeaker output 4 Ohm*

Connector	Euro style pluggable screw terminal, floating
PLE-2MA120-US	22 V (120 W)
PLE-2MA240-US	31 V (240 W)
* Subtract 1 dB for 24 V battery operation.	

6.2 Mechanical

Dimensions (H x W x D)	100 x 430 x 270 mm (19" wide, 2U high)
Mounting	Stand-alone, 19" rack
Color	Charcoal
Weight (PLE-2MA120-US)	Approx. 10.5 kg
Weight (PLE-2MA240-US)	Approx. 12.5 kg

6.3 Environmental

Operating temperature	-10 to +55 °C
Storage temperature	-40 to +70 °C
Relative humidity	<95%
Acoustic noise level of fan	<33 dB SPL @ 1 m temperature control

© Bosch Security Systems B.V.

Data subject to change without notice

2007-10 | PLE-2MA120-US, PLE-2MA240-US en

BOSCH

Free Manuals Download Website

<http://myh66.com>

<http://usermanuals.us>

<http://www.somanuals.com>

<http://www.4manuals.cc>

<http://www.manual-lib.com>

<http://www.404manual.com>

<http://www.luxmanual.com>

<http://aubethermostatmanual.com>

Golf course search by state

<http://golfingnear.com>

Email search by domain

<http://emailbydomain.com>

Auto manuals search

<http://auto.somanuals.com>

TV manuals search

<http://tv.somanuals.com>