

OWNER'S MANUAL

20" REAR DISCHARGE ROTARY MOWER

**Model Number
113-330A**

**Important:
Read Safety Rules and
Instructions Carefully**

Thank you for purchasing an
American built product.

INDEX

Safe Operation Practices	3	Maintenance	11
Assembly	4	Off-Season Storage	12
Controls	8	Illustrated Parts	14
Operation	9	Repair Parts List	15
Adjustments	10	Parts Information	Back Cover
Lubrication	11		

LIMITED WARRANTY

For one year from the date of original retail purchase, MTD PRODUCTS INC will either repair or replace, at its option, free of charge, F.O.B. factory or authorized service firm, any part or parts found to be defective in material or workmanship. Transportation charges for the movement of any power equipment unit or attachment are the responsibility of the purchaser. Transportation charges for any parts submitted for replacement under this warranty must be paid by the purchaser unless such return is requested by MTD PRODUCTS INC.

This warranty will not apply to any part which has become inoperative due to misuse, excessive use, accident, neglect, improper maintenance, alterations, or unless the unit has been operated and maintained in accordance with the instructions furnished. This warranty does not apply to the engine, motor, battery, battery charger or component parts thereof. Please refer to the applicable manufacturer's warranty on these items.

This warranty will not apply where the unit has been used commercially.

Warranty service is available through your local authorized service dealer or distributor. If you do not know the dealer or distributor in your area, please write to the Customer Service Department of MTD.

The return of a complete unit will not be accepted by the factory unless prior written permission has been extended by MTD.

This warranty gives you specific legal rights. You may also have other rights which vary from state to state.



This unit is equipped with an internal combustion engine and should not be used on or near any unimproved forest-covered, brush-covered or grass-covered land unless the engine's exhaust system is equipped with a spark arrester meeting applicable local or state laws (if any). If a spark arrester is used, it should be maintained in effective working order by the operator.

In the State of California the above is required by law (Section 4442 of the California Public Resources Code). Other states may have similar laws. Federal laws apply on federal lands. A spark arrester muffler is available at your nearest engine authorized service center.



To reduce the potential for any injury, comply with the following safety instructions. Failure to comply with the instructions may result in personal injury.

SAFE OPERATION PRACTICES FOR WALK-BEHIND MOWERS

TRAINING

1. Read this owner's manual carefully in its entirety before attempting to assemble or operate this machine. Be completely familiar with the controls and the proper use of this machine before operating it. Keep this manual in a safe place for future and regular reference and for ordering replacement parts.
2. Your rotary mower is a precision piece of power equipment, not a plaything. Therefore, exercise extreme caution at all times.
3. Never allow children to operate a power mower. Only persons well acquainted with these rules of safe operation should be allowed to use your mower.
4. Keep the area of operation clear of all persons, particularly small children and pets. Stop engine when they are in the vicinity of your mower. Although the area of operation should be completely cleared of foreign objects, an object may have been overlooked and could be accidentally thrown by the mower in any direction and cause serious personal injury to the operator or any others allowed in the area.

PREPARATION

1. Thoroughly inspect the area where the equipment is to be used. Remove all stones, sticks, wire, bones and other foreign objects which could be picked up and thrown by the mower in any direction and cause serious personal injury to the operator or any others allowed in the area.
2. Do not operate equipment when barefoot or wearing open sandals. Always wear substantial footwear.
3. Do not wear loose fitting clothing that could get caught on the mower.
4. Check the fuel before starting the engine. Gasoline is an extremely flammable fuel. Do not fill the gasoline tank indoors, while the engine is running, or while the engine is still hot. Wipe off any spilled gasoline before starting the engine as it may cause a fire or explosion.
5. Disengage the self-propelled mechanism or drive clutch on units so equipped before starting the engine.
6. The blade control handle is a safety device. Never attempt to bypass its operation. Doing so makes the safety device inoperative and may result in personal injury through contact with the rotating blade. The blade control handle must operate easily in both directions.
7. Never attempt to make a wheel or cutting height adjustment while the engine is running.
8. Mow only in daylight or in good artificial light.
9. Never operate the equipment in wet grass. Always be sure of your footing. A slip and fall can cause serious personal injury. Keep a firm hold on the handle and walk, never run.

OPERATION

1. Do not change the engine governor settings or overspeed the engine. Excessive engine speeds are dangerous.
2. Do not put hands or feet near or under rotating parts. Keep clear of the discharge opening at all times as the rotating blade can cause injury.
3. Stop the blade when crossing gravel drives, walks or roads.
4. After striking a foreign object, stop the engine, remove the wire from the spark plug, and thoroughly inspect the mower for any damage. Repair the damage before restarting and operating the mower.
5. If the equipment should start to vibrate abnormally, stop the engine and check immediately for the cause. Vibration is generally a warning of trouble.
6. Shut the engine off and wait until the blade comes to a complete stop before removing the grass catcher or unclogging the chute. The cutting blade continues to rotate for a few seconds after the engine is shut off. Never place any part of the body in the blade area until you are sure the blade has stopped rotating.
7. Before cleaning, repairing or inspecting, make certain the blade and all moving parts have stopped. Disconnect the spark plug wire, and keep the wire away from the spark plug to prevent accidental starting.
8. Do not run the engine indoors.
9. Mow across the face of slopes, never up-and-down. Exercise extreme caution when changing direction on slopes. Do not mow excessively steep slopes. Always be sure of your footing. A slip and fall can cause serious personal injury.
10. Always disconnect electric mowers (line operated) before cleaning, repairing or adjusting.
11. Never operate mower without proper guards, plates or other safety protective devices in place.
12. **DO NOT OPERATE** this mower unless the complete grass catcher is properly mounted on the mower.

MAINTENANCE AND STORAGE

1. Check the blade and engine mounting bolts at frequent intervals for proper tightness.
2. Keep all nuts, bolts, and screws tight to be sure the equipment is in safe working condition.
3. Never store the equipment with gasoline in the tank inside of a building where fumes may reach an open flame or spark. Allow the engine to cool before storing in any enclosure.
4. To reduce fire hazard, keep the engine free of grass, leaves, or excessive grease.
5. Check the grass catcher bag frequently for wear or deterioration. For safety protection, replace only with new bag meeting original equipment specifications.



Reference to right or left hand side of the mower is observed from the operating position.

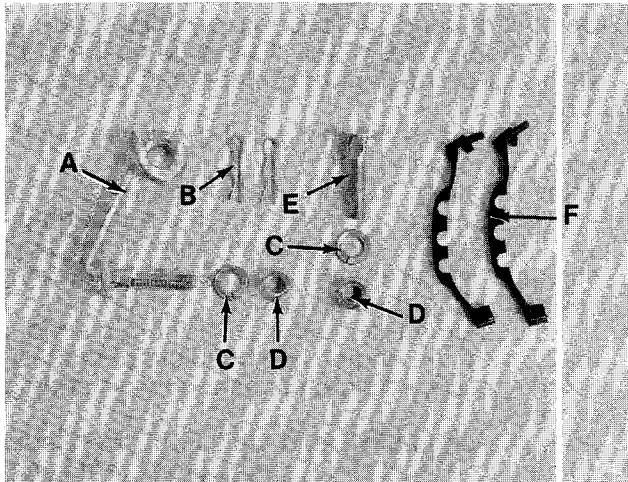

FIGURE 1.

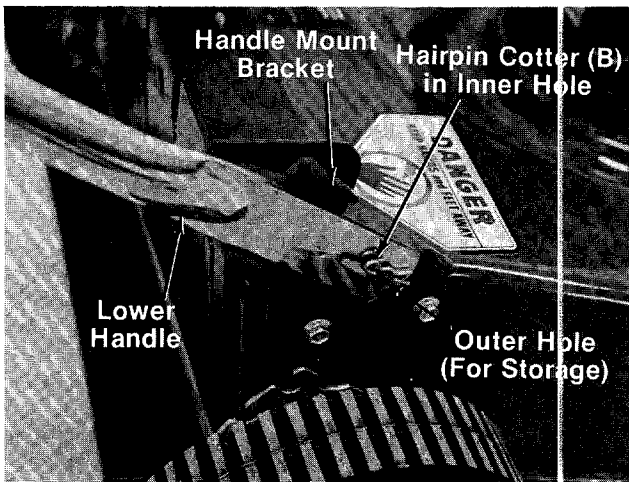

FIGURE 2.

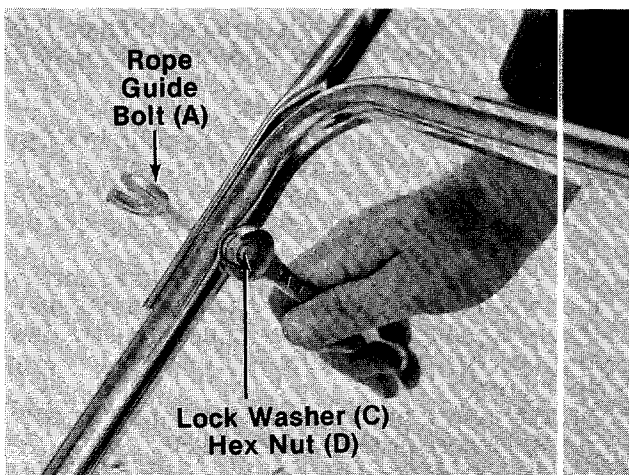

FIGURE 3.

ASSEMBLY INSTRUCTIONS



This unit is shipped WITHOUT GASOLINE or OIL. After assembly, see separate engine manual for proper fuel and engine oil recommendations.

← Contents of hardware pack: (See figure 1)

- A (1) Rope Guide Bolt
- B (2) Hairpin Cotters
- C (2) Lock Washers 5/16" I.D.
- D (2) Hex Nuts 5/16-18 Thread
- E (1) Curved Head Carriage Bolt
- F (2) Cable Ties

1. Remove lawn mower and loose parts from carton. Make certain all parts and literature have been removed from the carton before the carton is discarded.
2. Extend the throttle control cable (attached to the upper handle) and the brake cable (attached to the engine) and place on the floor. Be careful not to bend or kink control cables.
3. Attach the lower handle by placing the bottom holes in the lower handle over the weld pins on the handle mount brackets. Make certain the instruction label on the lower handle can be read from the operating position. Secure with hairpin cotters (B) in inner holes on weld pins. See figure 2.



There are two (2) holes in the handle mount brackets. Place the hairpin cotter in the inner hole for operation. Outer hole is for storage.



It may be necessary to bend the ends of the lower handle inward slightly to obtain a tight fit against the handle mount brackets.

4. Place the upper handle in position over the lower handle. The throttle control must be on the left hand side of the handle. Secure the right hand side of upper handle using the rope guide bolt (A), lock washer (C) and hex nut (D) as shown in figure 3.



Left handed operators may assemble the rope guide bolt to the left hand side of the handle for easier starting.

5. Secure the other side of the handle with curved head bolt (E), lock washer (C) and hex nut (D).

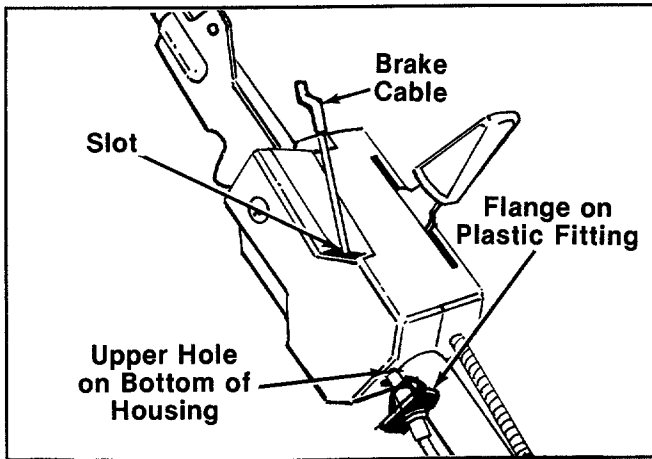

FIGURE 4.

6. Route the brake cable under the lower handle. Place end of cable into the upper hole on the bottom of the control housing, and through the slot as shown. The angle of the flange on the plastic fitting must be positioned as shown in figure 4. Be careful not to bend or kink the cable.

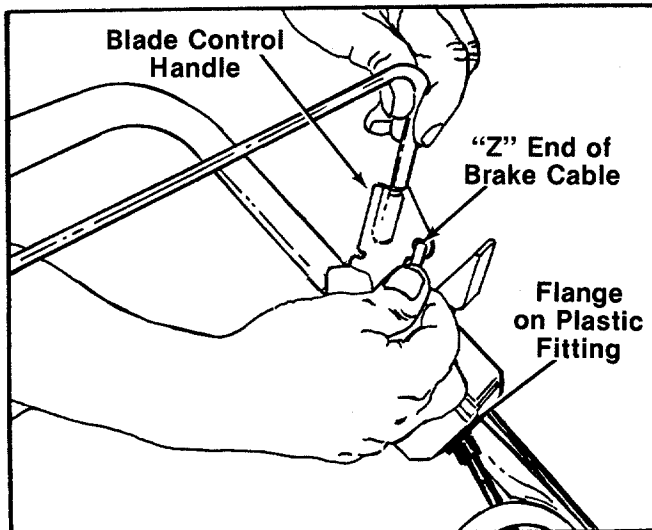

FIGURE 5.

7. Snap the plastic fitting on the end of the cable into the control housing.
8. Hook the "Z" end of the brake cable into the hole in the blade control handle. See figure 5. If additional slack is needed in order to hook the cable into the handle, proceed as follows.

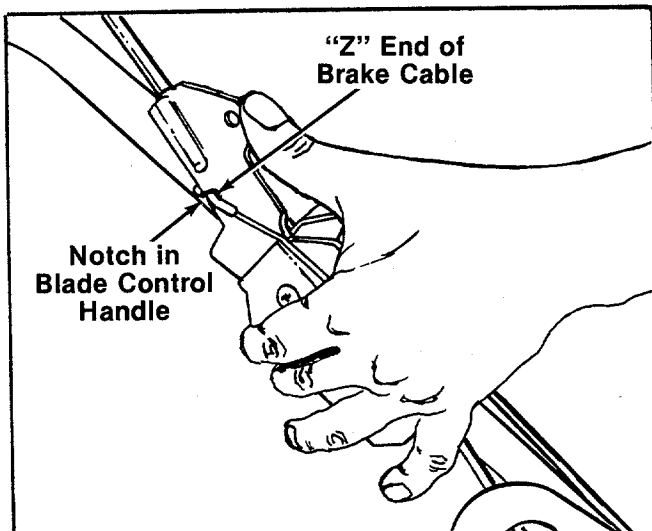

FIGURE 6.

- a. Hook the "Z" end of the cable into notch provided in the blade control handle. See figure 6.
- b. Squeeze blade control handle against upper handle.
- c. Release the blade control handle, unhook the cable from the notch and hook it into the hole in the blade control handle.

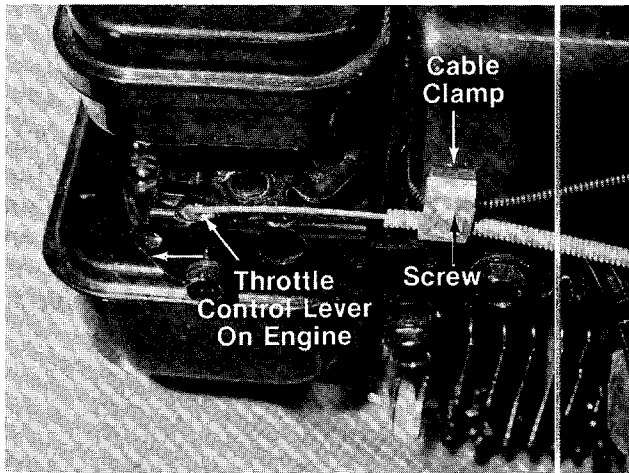

FIGURE 7.

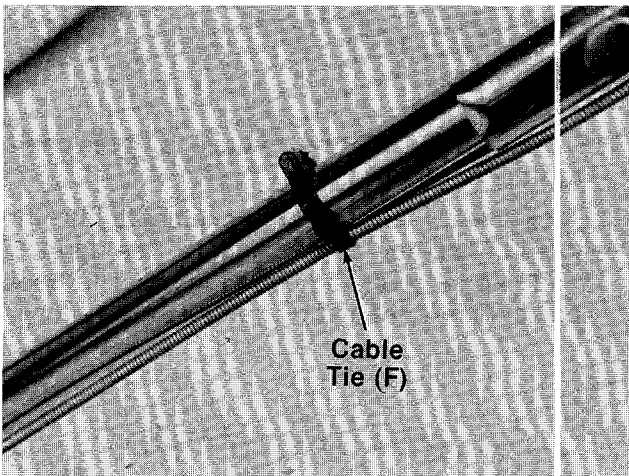

FIGURE 8.

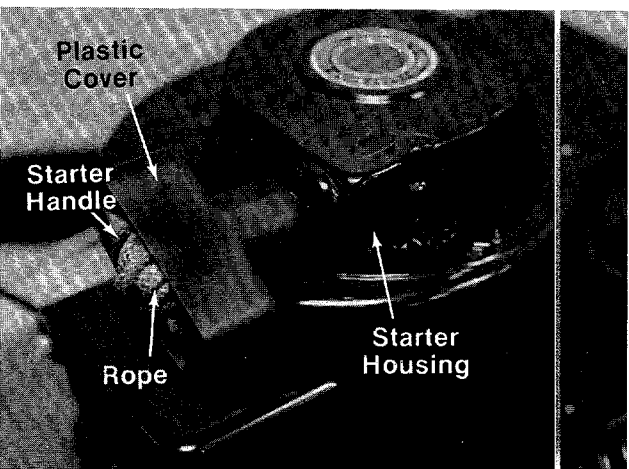

FIGURE 9.

9. Place the throttle control lever on the handle in "Fast" position. Refer to figure 14.

10. Push the throttle control lever on the engine to the full open position (as far toward the outside of the unit as it will go) as shown in figure 7.



11. Hook the "Z" end of the throttle control cable into the hole in the control lever on the engine.

12. Loosen (do not remove) the screw on the cable clamp shown in figure 7. Slip the control casing under the clamp. With the throttle lever on the engine still in the full open position, tighten the screw to secure the throttle control cable.

13. Loosen the screw on the clamp on the side of the engine. Secure the cable away from the muffler. Be careful not to bend or kink the cable. Tighten the screw.

14. Secure throttle control and brake cables to upper and lower handles with cable ties (F). See figure 8.



15. The starter rope is pulled out from the engine, wrapped around the starter handle and secured with a plastic cover for shipping purposes. Hold the rope so that it does not retract into the starter housing on the engine. Remove the plastic cover and discard. See figure 9.

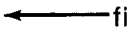

NOTE

If the rope should accidentally retract, disconnect and ground the spark plug wire. Depress the blade control handle and pull the starter rope out from the engine.

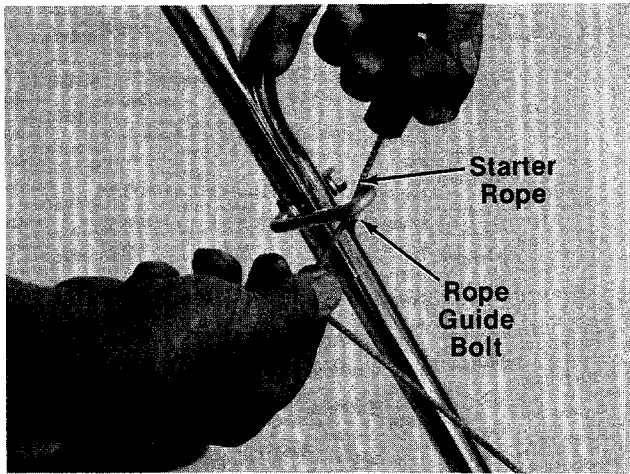

FIGURE 10.

16. Slip the starter rope into the rope guide bolt as shown in figure 10.
17. Check ALL nuts and bolts for correct tightness.

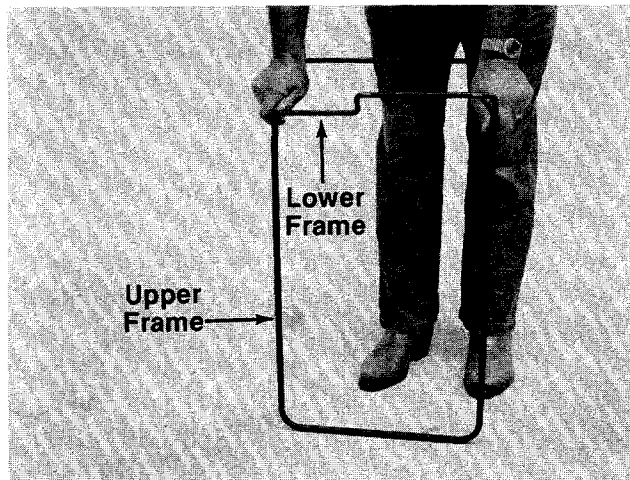

FIGURE 11.

Grass Catcher Assembly

1. Join the upper frame and lower frame assembly as shown in figure 11.

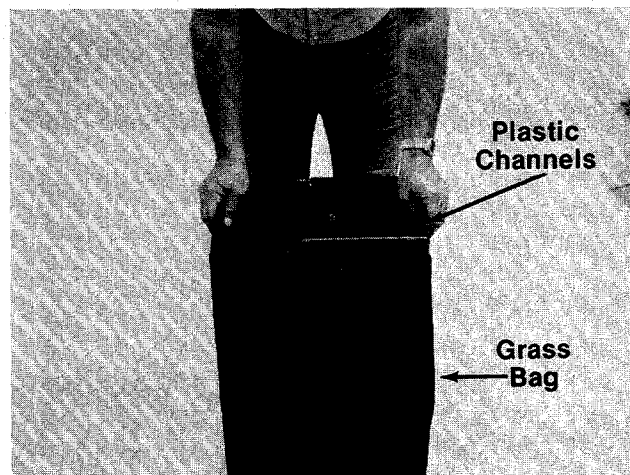

FIGURE 12.

2. Place bag over frame (black plastic side is the bottom of bag). Upper frame goes to the top of bag.
3. Secure bag to frame by slipping plastic channels on bag over frame. See figure 12.

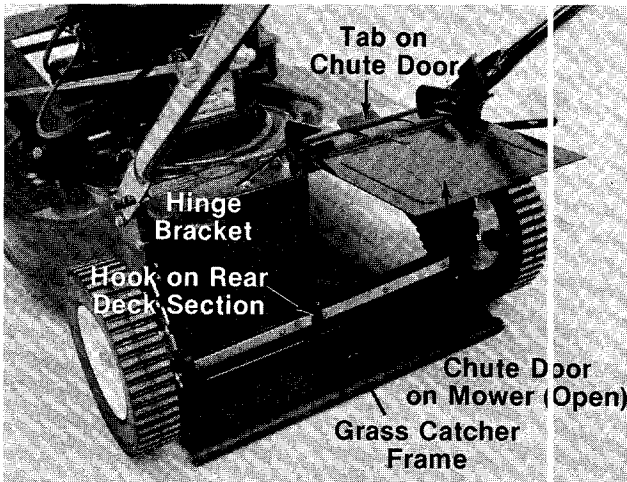

FIGURE 13.

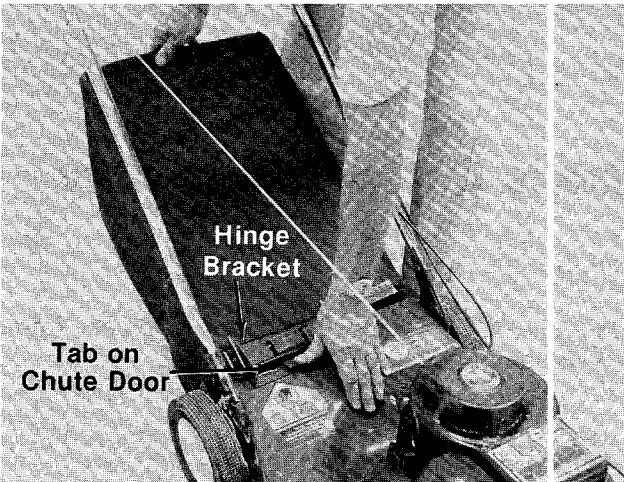

FIGURE 14.

To Attach Bag To Mower



DO NOT operate the mower unless the complete grass catcher is properly mounted on the mower.

1. Attach the grass catcher frame to rear of the mower by hooking grass catcher into hook on rear deck section. See figure 13.



Figure 13 is shown with the chute door open for photo clarity only.

2. Lift the rear of grass catcher up and slip the grass catcher frame into the slots on the hinge bracket. See figures 13 and 14.
3. Push the tab on the chute door. The grass catcher frame will snap into place, secured by the chute door. See figure 14.

To remove the grass catcher, press the tab on the chute door and slip the grass catcher off the unit. See figure 14.

CONTROLS

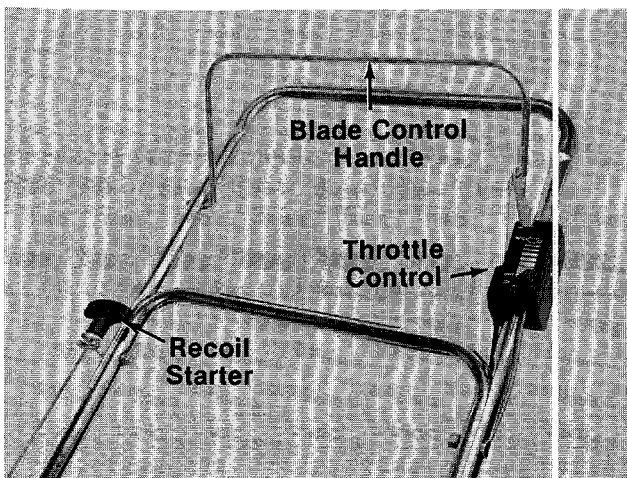

FIGURE 15.

BLADE CONTROL HANDLE

WARNING
THIS CONTROL MECHANISM IS A SAFETY DEVICE NEVER ATTEMPT TO BYPASS ITS OPERATIONS

The blade control handle is located on the upper handle of the mower. See figure 15. The blade control handle must be depressed in order to operate the unit. Release the blade control handle to stop the engine and blade.



The blade will be rotating whenever the engine is running.

THROTTLE CONTROL

The throttle control is located on the left side of the upper handle. It is used to regulate the engine speed. The engine should be started with the engine in the FAST or START position.



The throttle control cannot be used to stop the engine.

RECOIL STARTER

The recoil starter handle is attached to the handle. See figure 15. Stand behind the unit in the operating position to start the unit.

OPERATION

DO NOT OPERATE THIS MOWER UNLESS THE COMPLETE GRASS-CATCHER IS PROPERLY MOUNTED ON THE MOWER.



FIGURE 16.

Keep hands and feet away from the chute area on cutting deck. See figure 16.



For shipping purposes your mower is set with the wheels in a low cutting height position. For best results raise the cutting position until it is determined which height is best for your lawn. See cutting height adjustment section.

BEFORE STARTING

1. Fill sump with oil as instructed in the separate engine manual packed with your unit.
2. Fill fuel tank, using clean, fresh, unleaded, low-lead or regular grade leaded gasoline. Fill tank completely!

DO NOT MIX OIL WITH GASOLINE.

3. Attach spark plug wire to spark plug.

TO START ENGINE AND ENGAGE BLADE

1. Move the throttle control lever to FAST or START position.
2. Standing behind the unit, depress the blade control handle and hold it against the upper handle as shown in figure 17.
3. Grasp the recoil starter handle as shown and pull up rapidly. Return it slowly to the rope guide bolt.
4. After engine starts, move throttle control to desired engine speed.

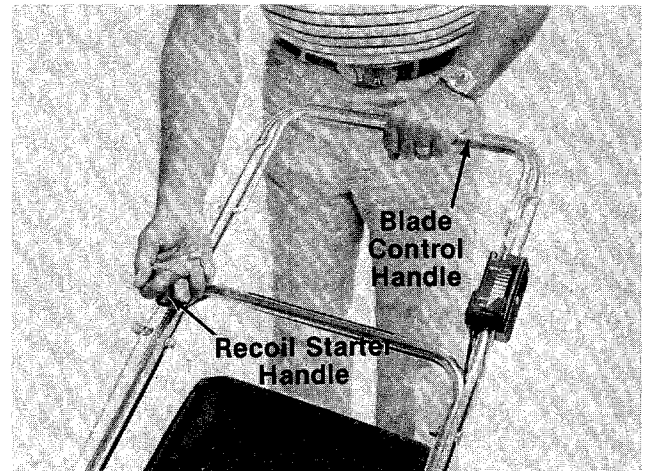

FIGURE 17.

TO STOP ENGINE AND BLADE

1. Release the blade control handle to stop the engine and blade.



The blade continues to rotate for a few seconds after the engine is shut off.

2. Disconnect the spark plug wire and ground it against the engine to prevent accidental starting while equipment is unattended.

USING YOUR ROTARY MOWER



Do not operate the mower unless the complete grass catcher is properly mounted on the mower.

Be sure that lawn is clear of stones, sticks, wire, or other objects which could damage lawn mower or engine. Such objects could be accidentally thrown by the mower in any direction and cause serious personal injury to the operator and others.

Operate a new engine at intermediate speeds and light load for the first few hours as you would a new automotive engine.

For the best results, do not cut wet grass because it tends to stick to the underside of the mower, preventing proper discharge of grass clippings, and could cause you to slip and fall. New grass, thick grass or wet grass may require a narrower cut. Blade speed should be adjusted to the condition of the lawn.

For best results, cut off one-third or less of the total length of the grass. Lawn should be cut in the fall as long as there is growth.

This mower is designed to be operated at full throttle to give you the best cut and do the most effective job of bagging the cut grass.



If you strike a foreign object, stop the engine. Remove wire from spark plug, thoroughly inspect the mower for any damage, and repair the damage before restarting and operating the mower. Extensive vibration of the mower during operation is an indication of damage. The unit should be promptly inspected and repaired.

ADJUSTMENTS



Do not at any time make any adjustment to lawn mower without first stopping engine and disconnecting spark plug wire.

CUTTING HEIGHT ADJUSTMENT

An adjusting plate and thumb lever at each wheel position provides cutting height adjustment. Each adjusting plate has five holes. Height of cut will be changed when the thumb lever is moved from one hole to another. Simply depress the lever towards wheel and move wheel and lever assembly to desired position. See figure 18.

Cutting height will be raised as front and rear levers are lowered. Cutting height will be lowered as front and rear levers are raised. All wheels must be placed in the same relative position.

For rough or uneven lawns, move the wheels to a position which will give a higher cutting height.

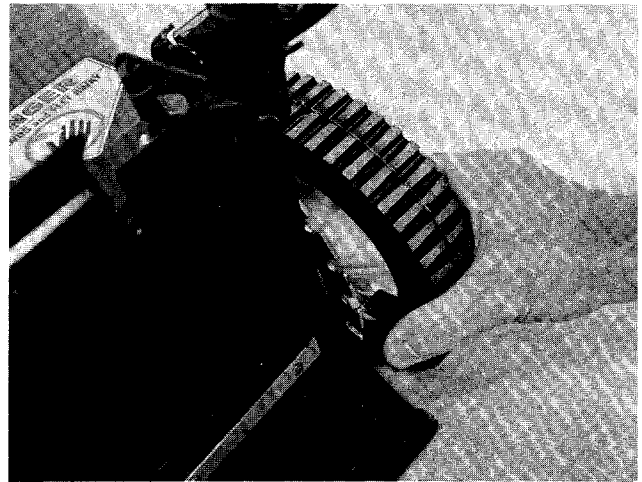

FIGURE 18.

THROTTLE

If adjustment becomes necessary, the throttle control wire assembly can be reset as follows:

1. Loosen, but do not remove, screw securing throttle control wire assembly at engine. See figure 7.
2. Move throttle control lever on handle to "FAST" position.
3. Move control lever on engine to full open position. Retighten screw to secure throttle control wire assembly.

CARBURETOR ADJUSTMENTS



If any adjustments are made to the engine while the engine is running (e.g. carburetor), keep clear of all moving parts. Be careful of heated surfaces and muffler.

Minor carburetor adjustment may be required to compensate for differences in fuel, temperature, altitude and load.

Refer to the separate engine manual packed with your mower for carburetor adjustment information.

LUBRICATION



Always stop engine and disconnect spark plug wire before cleaning, lubricating or doing any kind of work on lawn mower.

Blade Control—Lubricate the pivot points on the blade control handle and the brake cable at least once a season with light oil. See figure 19. The blade control must operate freely in both directions.

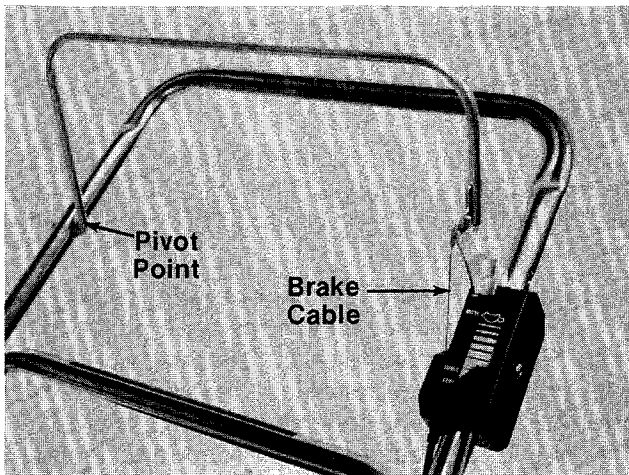

FIGURE 19.

Discharge Chute Door Mechanism—The torsion spring and pivot point should be lubricated periodically with light oil to prevent any rust or binding. Door must work freely.

Wheels—The wheels require no lubrication. However, if the wheels are removed for any reason, lubricate the surface of the axle bolt and the inner surface of the wheel with light oil. A 4 oz. plastic bottle of light oil lubricant is available. Order part number 737-0170. Engine oil may also be used.

Engine—Follow engine manual for lubrication instructions.

Throttle—Periodically lubricate throttle control lever and throttle wire assembly with a few drops of light oil for ease of operation.

MAINTENANCE



When tipping the unit, empty the fuel tank and keep engine spark plug side up.

CUTTING BLADE

A. Removal for Sharpening or Replacement



Be sure to disconnect and ground the spark plug wire before working on the cutting blade to prevent accidental engine starting.

Remove the large bolt and lock washer which holds the blade and adapter to the engine crankshaft. Remove the blade and adapter from the crankshaft.

If the blade or blade adapter needs replacing, remove the two small bolts, lock washers and nuts which hold the blade to the adapter.



Periodically inspect the blade adapter for cracks, especially if you strike a foreign object. Replace when necessary.

B. Sharpening

Remove the cutting blade by following the directions of the preceding section.

When sharpening the blade, follow the original angle of grind as a guide. It is **extremely important** that each cutting edge receives an equal amount of grinding to prevent an unbalanced blade. An unbalanced blade will cause excessive vibration when rotating at high speeds, may cause damage to the mower and could break, causing personal injury.

It is recommended that the blade always be removed from the adapter for the best test of balance. The blade can be tested by balancing it on a round shaft screwdriver. Remove metal from the heavy side until it balances evenly.

C. Reassembly

Before reassembling the blade and the blade adapter to the unit, lubricate the engine crankshaft and the inner surface of the blade adapter with light oil. Lubricating the bolt holes, bolts and inner surface of the nuts with light oil is also recommended. A 4 oz. plastic bottle of light oil lubricant is available. Order part number 737-0170. Engine oil may also be used.

When replacing the blade, be sure to install the blade with the side of the blade marked "Bottom" (or with part number) facing the ground when the mower is in the operating position.

Blade Mounting Torque

3/8" Dia. Bolt 375 in. lb. min., 450 in. lb. max.

5/16" Dia. Bolt 150 in. lb. min., 250 in. lb. max.

To insure safe operation of your unit, all nuts and bolts must be checked periodically for correct tightness.

DECK

The underside of mower deck should be cleaned after each period of use as grass clippings, leaves, dirt and other matter will accumulate. This accumulation of grass clippings, etc., is undesirable as it will invite rust and corrosion and may cause an uneven discharge of grass clippings at the next cutting.

The deck may be cleaned by tilting the mower forward or on its side and scraping clean with a suitable tool or by washing with a stream of water from a garden hose.



CAUTION

Do not direct the stream of water at a hot engine as damage to the engine may result.

ENGINE OIL

Check oil level before starting engine and after every 5 hours of operation. ADD oil as necessary to keep level to full mark on dipstick. Before removing dipstick, clean area around dipstick to prevent dirt from entering oil fill opening. Engine should be in a level position when checking oil.

Change oil after first 5 hours of operation. Thereafter change every 25 hours. Change oil while engine is warm. Oil may be drained thru oil drain on bottom of the engine. Oil capacity 1-1/4 pints.

AIR CLEANER

Service air cleaner every 25 hours under normal conditions. Clean every few hours under extremely dusty conditions. Poor engine performance and flooding usually indicates that the air cleaner should be serviced.

To service the air cleaner, refer to the separate engine manual packed with your unit.

SPARK PLUG

The spark plug should be cleaned and the gap reset once a season. Spark plug replacement is recommended at the start of each mowing season; check engine manual for correct plug type and gap specifications.

OFF-SEASON STORAGE

The following steps should be taken to prepare lawn mower for storage.

1. Clean and lubricate mower thoroughly as described in the lubrication instructions.
2. Refer to engine manual for correct engine storage instructions.
3. Coat mower's cutting blade with chassis grease to prevent rusting.
4. Store mower in a dry, clean area.

HANDLE STORAGE

The handle may be placed in an upright position for storage.

Move hairpin cotter to outer hole on weld pins. See figure 2. Press outward on the bottom of the lower handle and push forward. The handle will lock in this position.

To place the handle in the operating position, remove the starter rope from the rope guide bolt. Grasp the lower handle at the bottom, pull apart slightly and tip the handle backward. Place the cotter hairpins in the inner holes. With the spark plug wire disconnected and grounded, depress the blade control handle and pull the starter rope out from the engine. Slip the starter rope into the rope guide bolt.



The use of any accessory on this Rotary Mower other than those manufactured by the mower manufacturer is **not** recommended.

GRASS CATCHER Model 061 is available as replacement equipment for the mower shown in this manual.



1. DO NOT operate the mower unless the complete grass catcher is properly mounted on the mower.
2. DO NOT operate the mower without the protective shield on the rear of the deck in place.



Under normal usage bag material is subject to wear and should be checked periodically. Be sure any replacement bag complies with the mower manufacturer's recommendations.

For replacement bags, use only factory authorized replacement bag No. 764-0197.

Model 330

Meets CPSC Blade Safety Requirements

Lot/Model

Mfg. Date

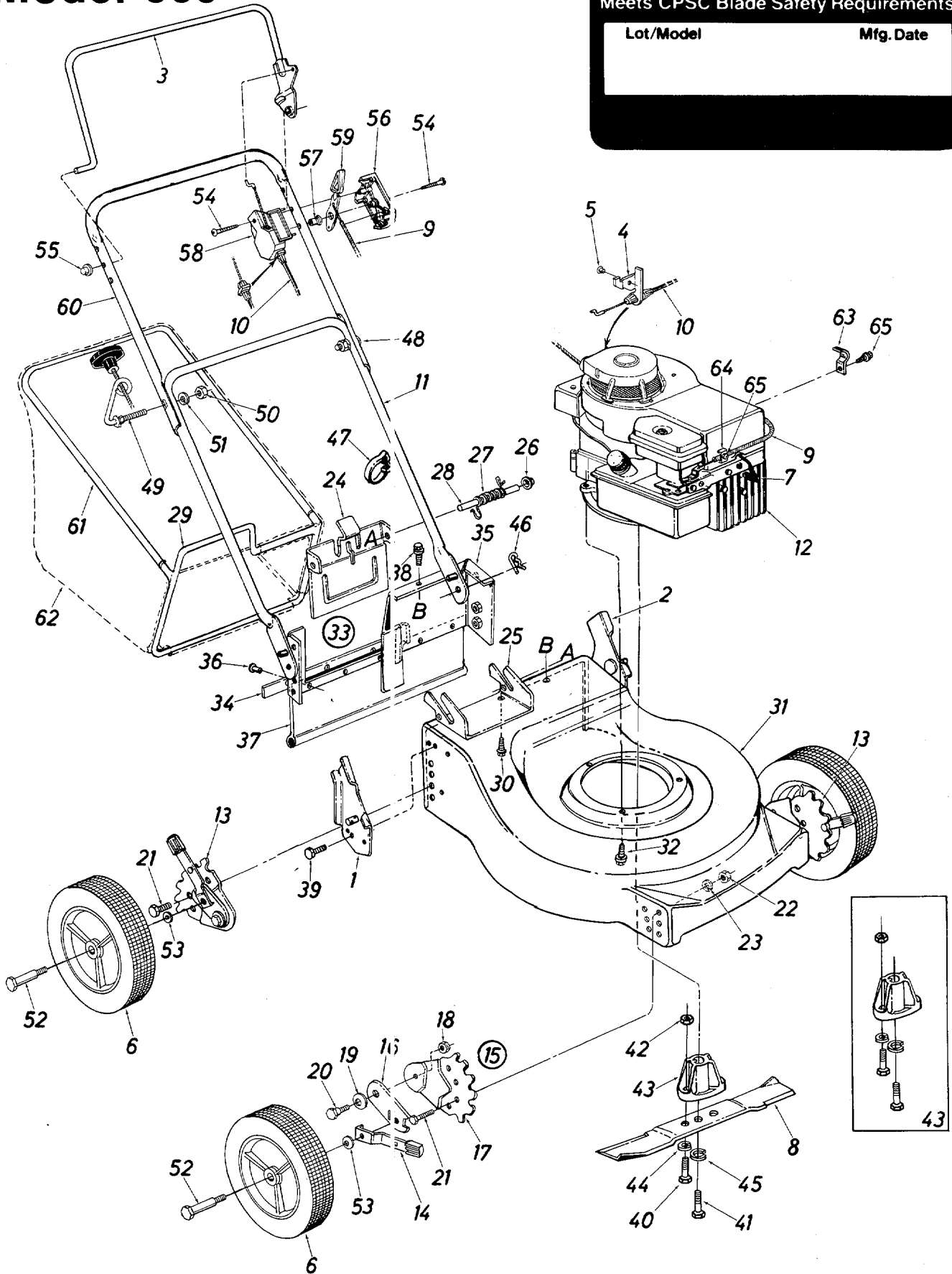

Model 330

PARTS LIST FOR MODEL 330 ROTARY MOWER

REF. NO.	PART NO.	COLOR CODE	DESCRIPTION	NEW PART	REF. NO.	PART NO.	COLOR CODE	DESCRIPTION	NEW PART
1	12296		Handle Brkt. Ass'y.—R.H.		35	15685		Rear Deck Section	
2	12297		Handle Brkt. Ass'y.—L.H.		36	728-0131		Rivet	
3	14321		Control Handle Ass'y.—L.H.		37	731-0592		Rear Flap Ass'y.	
4	14924		Cable Brkt.		38	710-0599		Hex Wash. Hd. S-Tap Scr. 1/4-20 x .50" Lg.	
5	728-0171		Pop Rivet					Hex Wash. Hd. AB-Tap Scr. 1/4 x .62" Lg.	
6	734-0841		Plastic Wheel 8 x 1.75		39	710-0776		Hex Bolt 5/16-24 x 1.0" Lg.	
7	735-0639		Spark Plug Boot		40	710-0888		Hex Bolt 3/8-24 x 2.25" Lg.*	
8	742-0123		20" Blade		41	710-0331		Hex Nut 5/16-24 Thd.*	
9	746-0472		Throttle Wire—58.0"		42	712-0123		Blade Adapter Kit	
10	746-0477		Control Cable—43.0"		43	753-0348		L-Wash. 5/16" I.D.*	
11	749-0505		Lower Handle		44	736-0119		L-Wash. 3/8" I.D.—H.D.	
12	—		Engine		45	736-0217		Internal Cotter Pin 5/16" Dia.	
13	12321		Height Adjust. Ass'y.—L.H.		46	714-0104		Cable Tie	
14	10531		Spring Lever Ass'y. w/Knob		47	726-0192		Curved Carr. Bolt 5/16-18 x 1.38" Lg.	
15	12322		Height Adjust. Ass'y.—R.H.		48	710-0671		Rope Guide Bolt	
16	10619		Pivot Bar		49	710-0842		Hex Nut 5/16-18 Thd.*	
17	12323		Index Plate		50	712-0267		L-Wash. 5/16" I.D.*	
18	712-0375		Hex Cent. L-Nut 3/8-16 Thd.		51	736-0119		Shld. Bolt .498" Dia. x 1.45"	
19	736-0255		Bell-Wash. .515" I.D. x 1.14" O.D.		52	738-0102		Bell-Wash. .400" I.D. x .88" O.D.	
20	738-0269		Shld. Bolt .500" Dia. x .295"		53	736-0105		Truss Mach. Scr. #12 x 1.5" Lg.	
21	710-0216		Hex Bolt 3/8-16 x .75" Lg.*		54	710-0796		Push Nut 5/16" Rod	
22	712-0798		Hex Nut 3/8-16 Thd.*		55	726-0135		Control Panel Half	
23	736-0169		L-Wash. 3/8" I.D.*		56	731-0523		Control Disc Pin	
24	14417		Chute Door	N	57	731-0524		Clutch Panel Half	
25	14418		Hinge Brkt.	N	58	731-0526		Throttle Control Lever	
26	726-0106		Push Cap 1/4" Rod		59	731-0528		Upper Handle	
27	732-0406		Torsion Spring		60	749-0436		Upper Frame—Grass Catcher	N
28	747-0375		Hinge Rod		61	749-0468		Grass Bag	N
29	14447		Lower Frame Ass'y.—Grass Catcher	N	62	764-0197		Casing Clamp	
30	710-0599		Hex Wash. Hd. S-Tap Scr. 1/4-20 x .50" Lg.		63	12894		Casing Clamp	
31	15681 —462		20" Deck Ass'y.	N	64	751-0333		Hex AB-Tap Scr. #10 x .38" Lg.	
32	710-0654		Hex Wash. Hd. TT-Tap Scr. 3/8-16 x 1.0" Lg.		65	710-0429			
33	15684		Rear Deck Section Ass'y.	N					
34	14419		Reinforcement Strap						

(462—Red Flake)

*For faster service obtain standard nuts, bolts, and washers locally. If these items cannot be obtained locally, order by part number and size as shown on parts list.

When ordering parts if color or finish is important, use the appropriate color code shown at left. (e.g. Red Flake Finish—12191 (462).)

NOTE: The engine is not under warranty by the mower manufacturer...If repairs or service is needed on the engine, please contact your nearest authorized engine service outlet. Check the "Yellow Pages" of your telephone book under "Engines—Gasoline."



NOTE

Specifications subject to change without notice or obligation.

PARTS INFORMATION

POWER EQUIPMENT PARTS AND SERVICE

Parts and service are available through the authorized service firms listed below. All orders should specify the model number of your unit, part numbers, description of parts and the quantity of each part required.

BRIGGS AND STRATTON, TECUMSEH AND PEERLESS PARTS AND SERVICE

Briggs & Stratton, Tecumseh and Peerless parts and service should be handled by your nearest authorized engine service firm. Check the yellow pages of your telephone directory under the listing **Engines—Gasoline**, Briggs & Stratton or Tecumseh Lauson.

NOTE: If any parts are found to be missing or defective upon assembly of this unit, write to advise the factory so that immediate replacement can be made.

ALABAMA Auto Electric & Carburetor Co. 2625 4th Ave. S. 35233	BIRMINGHAM	NORTH CAROLINA Smith Hardware Co. 515 N. George St. 27530	GOLDSBORO 515 N. George St. 27530
ARKANSAS Sutton's Lawn Mower Shop 5301 Roundtop Drive Box 368, Rt. 4 72117	NORTH LITTLE ROCK	Dixie Sales Company 335 N. Green 27402	GREENSBORO 335 N. Green 27402
CALIFORNIA Billious 75 North D Street 93257	PORTERVILLE	OHIO Stebe's Mid-State Mower Supply Box 366, 71 High St. 43112	CARROLL Box 366, 71 High St. 43112
COLORADO Spitzer Industrial Products Co. Box 29114, 6601 N. Washington St. 80229	DENVER	Bleckrie, Inc. 7900 Lorain Ave. 44102	CLEVELAND 7900 Lorain Ave. 44102
FLORIDA Radco Distributors 4909 Victor St. Box 5459 32207	JACKSONVILLE	National Central 687 Seville Rd. 44281	WADSWORTH 687 Seville Rd. 44281
Small Eng. Dist. 2351 N.W. 147th St. 33054	OPA LOCKA	Burton Supply Co. 1301 Logan Ave. Box 929 44501	YOUNGSTOWN 1301 Logan Ave. Box 929 44501
GEORGIA East Point Cycle & Key 2834 Church St. 30344	EAST POINT	OKLAHOMA Victory Motors, Inc. 605 S. Cherokee 74401	MUSKOGEE 605 S. Cherokee 74401
ILLINOIS Keen Edge Co. 8615 Ogden Ave. 60534	LYONS	OREGON Kenton Supply Co. 8216 N. Denver Ave. 97217	PORTLAND 8216 N. Denver Ave. 97217
INDIANA Parts & Sales Inc. 2101 Industrial Pkwy. 46514	ELKHART	PENNSYLVANIA EECO Inc. 4021 N. 6th St. 17110	HARRISBURG 4021 N. 6th St. 17110
IOWA Power Lawn & Garden Equip. 2551 J.F. Kennedy 52001	DUBUQUE	Thompson Rubber Co. 5222-24 N. Fifth St. 19120	PHILADELPHIA 5222-24 N. Fifth St. 19120
LOUISIANA Mid-South Power 700 Pine St. 71201	MONROE	Bluemont Co. 11125 Frankstown Rd. 15235	PITTSBURGH 11125 Frankstown Rd. 15235
Suhren Engine Co. 8330 Earhart Blvd. 70118	NEW ORLEANS	Frank Roberts & Sons R. D. 2 15767	PUNXSUTAWNEY R. D. 2 15767
MARYLAND Center Supply Co. 6867 New Hampshire Ave. 20912	TAKOMA PARK	TENNESSEE Master Repair Service 2000 Western Ave. 37921	KNOXVILLE 2000 Western Ave. 37921
MASSACHUSETTS Morton B. Collins Co. 300 Birnie Ave. 01107	SPRINGFIELD	American Sales & Service, Inc. 3035-43 Bellbrook 38116	MEMPHIS 3035-43 Bellbrook 38116
MICHIGAN Lorenz Service Co. 2500 S. Pennsylvania 48910	LANSING	TEXAS Marr Brothers, Inc. 423 E. Jefferson 75203	DALLAS 423 E. Jefferson 75203
Power Equipment Dist. 340 Hubbard 48043	MOUNT CLEMENS	Woodson Sales Corp. 1702 N. Sylvania 76111	FORT WORTH 1702 N. Sylvania 76111
MINNESOTA Hance Distributing Inc. 420 Excelsior Ave. W. 55343	HOPKINS	Bullard Supply Co. 2409 Commerce St. 77003	HOUSTON 2409 Commerce St. 77003
MISSISSIPPI Biloxi Sales & Service, Inc. 506 Caillavet St. 39533	BILOXI	Engine House Inc. 8610 Botts Lane P.O. Box 17867 78217	SAN ANTONIO 8610 Botts Lane P.O. Box 17867 78217
MISSOURI Automotive Equip. Service 3117 Holmes St. 64109	KANSAS CITY	UTAH A-1 Engine & Mower Co. 439 E. 900 So. 84111	SALT LAKE CITY 439 E. 900 So. 84111
Ross-Frazier Supply Co. 8th and Monterey 64503	ST. JOSEPH	VIRGINIA RBI Corp. Lake Ridge Rd. 101 Cedar Run Dr. 23005	ASHLAND Lake Ridge Rd. 101 Cedar Run Dr. 23005
Henzler, Inc. 2015 Lemay Ferry Road 63125	ST. LOUIS	WASHINGTON Bailey's Inc. 1414 14th Ave. 98122	SEATTLE 1414 14th Ave. 98122
NEW JERSEY Lawnmower Parts Inc. 717 Creek Rd. 08030	BELLMAWR	WISCONSIN Power Pac 301 E. 29th St. 54449	MARSHFIELD 301 E. 29th St. 54449
NEW MEXICO Spitzer Eng. & Parts 1023 Third Ave. N.W. 87103	ALBUQUERQUE	Appleton Automotive Supply Co. 123 S. Linwood Ave. P.O. Box 798 54911	APPLETON 123 S. Linwood Ave. P.O. Box 798 54911
NEW YORK Gamble Dist., Inc. West End Ave. 13619	CARTHAGE	E-Kon Small Engine Spec. 122 Lance Dr. 53181	TWIN LAKES 122 Lance Dr. 53181

WARRANTY PARTS AND SERVICE POLICY

(0782)

The purpose of warranty is to protect the customer from defects in workmanship and materials, defects which are NOT detected at the time of manufacture. It does not provide for the unlimited and unrestricted replacement of parts. Use and maintenance are the responsibility of the customer. The manufacturer cannot assume responsibility for conditions over which it has no control. Simply put, if it's the manufacturer's fault, it's the manufacturer's responsibility; if it's the customer's fault, it's the customer's responsibility.

CLAIMS AGAINST THE MANUFACTURER'S WARRANTY INCLUDES:

1. Replacement of Missing Parts on new equipment.
2. Replacement of Defective Parts within the warranty period.
3. Repair of Defects within the warranty period.

All claims MUST be substantiated with the following information:

1. Model Number of unit involved.
2. Date unit was purchased or first put into service.
3. Date of failure.
4. Nature of failure.

Free Manuals Download Website

<http://myh66.com>

<http://usermanuals.us>

<http://www.somanuals.com>

<http://www.4manuals.cc>

<http://www.manual-lib.com>

<http://www.404manual.com>

<http://www.luxmanual.com>

<http://aubethermostatmanual.com>

Golf course search by state

<http://golfingnear.com>

Email search by domain

<http://emailbydomain.com>

Auto manuals search

<http://auto.somanuals.com>

TV manuals search

<http://tv.somanuals.com>