

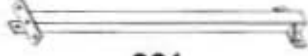









**ASSEMBLY INSTRUCTION MANUAL
MODEL: F415 DIP STATION**

PARTS CHART

NO.	DESCRIPTION	QTY.		
301	UPRIGHT FRAME	1	301	302
302	WEIGHT SUPPORT	1		
311	1-1/4" ROUND PLUG	2		
312	50 SQ. END PLUG	2	311	312
313	HAND GRIP	2		
321	1/2" X 3" HEX HEAD BOLT	3		
322	1/2" NYLON NUT	3	321	322
323	1/2" WASHER	6		



The Dip attachment can attach to either side of the F410 Linear Smith.

1. Removed the two Bolts(20) attaching side Base Frame(1 or 2) to the Rear Stabilizer (3). Discard the Connect Plate(14). Attach Upright frame(301) to Base Frame(1) and tighten Bolts(20) , Washer(27) and Nut(29) again.
2. Attach Weight Support(302) onto Upright Frame(301) , tighten three Bolts(321) , six Washers(322) and three Nuts(323).
3. Wet Hand Grip(313) and slide into the Weight Support(302).
4. Attach Round Plug(311) and End Cap(312) onto Weight Support(302).

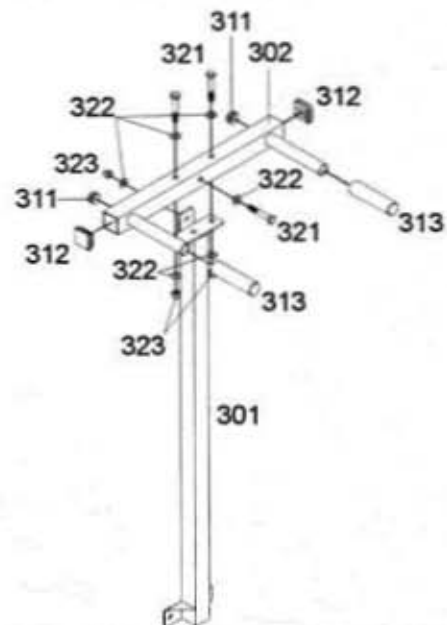
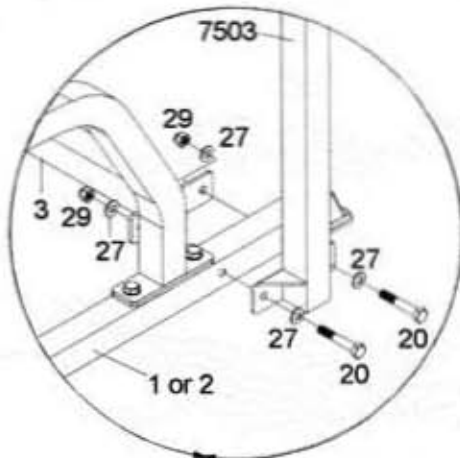

Thank you for purchasing the Bodycraft Smith Attachment Strength Training System. If You have any questions, please call your local BodyCraft dealer or call our customer service department at 800-990-5556.

Free Manuals Download Website

<http://myh66.com>

<http://usermanuals.us>

<http://www.somanuals.com>

<http://www.4manuals.cc>

<http://www.manual-lib.com>

<http://www.404manual.com>

<http://www.luxmanual.com>

<http://aubethermostatmanual.com>

Golf course search by state

<http://golfingnear.com>

Email search by domain

<http://emailbydomain.com>

Auto manuals search

<http://auto.somanuals.com>

TV manuals search

<http://tv.somanuals.com>