

CHICAGO

Electric[®] Power Tools

MAGNESIUM HEAVY DUTY 7" ANGLE GRINDER

Model 97588

SET UP AND OPERATING INSTRUCTIONS

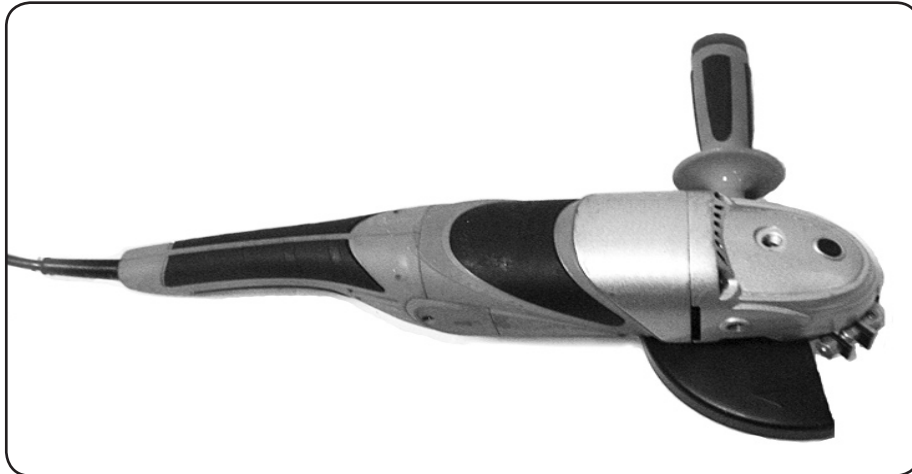

Distributed exclusively by Harbor Freight Tools[®].

3491 Mission Oaks Blvd., Camarillo, CA 93011

Visit our website at: <http://www.harborfreight.com>



**Read this material before using this product.
Failure to do so can result in serious injury.
SAVE THIS MANUAL.**

Copyright[®] 2008 by Harbor Freight Tools[®]. All rights reserved. No portion of this manual or any artwork contained herein may be reproduced in any shape or form without the express written consent of Harbor Freight Tools. Diagrams within this manual may not be drawn proportionally. Due to continuing improvements, actual product may differ slightly from the product described herein.

For technical questions or replacement parts, please call 1-800-444-3353.
REV 11h

SAVE THIS MANUAL

Keep this manual for the safety warnings and precautions, assembly, operating, inspection, maintenance and cleaning procedures. Write the product's serial number in the back of the manual near the assembly diagram (or month and year of purchase if product has no number). Keep this manual and the receipt in a safe and dry place for future reference.

IMPORTANT SAFETY INFORMATION

In this manual, on the labeling, and all other information provided with this product:



This is the safety alert symbol. It is used to alert you to potential personal injury hazards. Obey all safety messages that follow this symbol to avoid possible injury or death.

DANGER

DANGER indicates a hazardous

situation which, if not avoided, will result in death or serious injury.

WARNING

WARNING indicates a

hazardous situation which, if not avoided, could result in death or serious injury.

CAUTION

CAUTION, used with the safety

alert symbol, indicates a hazardous situation which, if not avoided, could result in minor or moderate injury.

NOTICE

NOTICE is used to address practices not related to personal injury.

CAUTION

CAUTION, without the safety alert symbol, is used to address practices not related to personal injury.

General Power Tool Safety Warnings



WARNING Read all safety warnings and instructions.

Failure to follow the warnings and instructions may result in electric shock, fire and/or serious injury.

Save all warnings and instructions for future reference.

The term "power tool" in the warnings refers to your mains-operated (corded) power tool or battery-operated (cordless) power tool.

1. **Work area safety**
 - a. **Keep work area clean and well lit.** *Cluttered or dark areas invite accidents.*
 - b. **Do not operate power tools in explosive atmospheres, such as in the presence of flammable liquids, gases or dust.** *Power tools create sparks which may ignite the dust or fumes.*
 - c. **Keep children and bystanders away while operating a power tool.** *Distractions can cause you to lose control.*
2. **Electrical safety**
 - a. **Power tool plugs must match the outlet. Never modify the plug in any way. Do not use any adapter**

- plugs with grounded power tools.** *Unmodified plugs and matching outlets will reduce risk of electric shock.*
- b. Avoid body contact with grounded surfaces such as pipes, radiators, ranges and refrigerators.** *There is an increased risk of electric shock if your body is grounded.*
 - c. Do not expose power tools to rain or wet conditions.** *Water entering a power tool will increase the risk of electric shock.*
 - d. Do not abuse the cord. Never use the cord for carrying, pulling or unplugging the power tool. Keep cord away from heat, oil, sharp edges or moving parts.** *Damaged or entangled cords increase the risk of electric shock.*
 - e. When operating a power tool outdoors, use an extension cord suitable for outdoor use.** *Use of a cord suitable for outdoor use reduces the risk of electric shock.*
 - f. If operating a power tool in a damp location is unavoidable, use a Ground Fault Circuit Interrupter (GFCI) protected supply.** *Use of a GFCI reduces the risk of electric shock.*
- 3. Personal safety**
- a. Stay alert, watch what you are doing and use common sense when operating a power tool. Do not use a power tool while you are tired or under the influence of drugs, alcohol or medication.** *A moment of inattention while operating power tools may result in serious personal injury.*
 - b. Use personal protective equipment. Always wear eye protection.** *Safety equipment such as dust mask, non-skid safety shoes, hard hat, or hearing protection used for appropriate conditions will reduce personal injuries.*
 - c. Prevent unintentional starting. Ensure the switch is in the off-position before connecting to power source and/or battery pack, picking up or carrying the tool. Carrying power tools with your finger on the switch or energizing power tools that have the switch on invites accidents.**
 - d. Remove any adjusting key or wrench before turning the power tool on.** *A wrench or a key left attached to a rotating part of the power tool may result in personal injury.*
 - e. Do not overreach. Keep proper footing and balance at all times.** *This enables better control of the power tool in unexpected situations.*
 - f. Dress properly. Do not wear loose clothing or jewelry. Keep your hair, clothing and gloves away from moving parts.** *Loose clothes, jewelry or long hair can be caught in moving parts.*
 - g. If devices are provided for the connection of dust extraction and collection facilities, ensure these are connected and properly used.** *Use of these devices can reduce dust-related hazards.*
 - h. Only use safety equipment that has been approved by an appropriate standards agency.** *Unapproved safety equipment may not provide adequate protection. Eye protection must be ANSI-approved and breathing protection must be NIOSH-approved.*

proved for the specific hazards in the work area.

4. **Power tool use and care**

- a. **Do not force the power tool. Use the correct power tool for your application.** *The correct power tool will do the job better and safer at the rate for which it was designed.*
- b. **Do not use the power tool if the switch does not turn it on and off.** *Any power tool that cannot be controlled with the switch is dangerous and must be repaired.*
- c. **Disconnect the plug from the power source and/or the battery pack from the power tool before making any adjustments, changing accessories, or storing power tools.** *Such preventive safety measures reduce the risk of starting the power tool accidentally.*
- d. **Store idle power tools out of the reach of children and do not allow persons unfamiliar with the power tool or these instructions to operate the power tool.** *Power tools are dangerous in the hands of untrained users.*
- e. **Maintain power tools. Check for misalignment or binding of moving parts, breakage of parts and any other condition that may affect the power tool's operation. If damaged, have the power tool repaired before use.** *Many accidents are caused by poorly maintained power tools.*
- f. **Keep cutting tools sharp and clean.** *Properly maintained cutting tools with sharp cutting edges are less likely to bind and are easier to control.*

- g. **Use the power tool, accessories and tool bits etc. in accordance with these instructions, taking into account the working conditions and the work to be performed.** *Use of the power tool for operations different from those intended could result in a hazardous situation.*

5. **Service**

- a. **Have your power tool serviced by a qualified repair person using only identical replacement parts.** *This will ensure that the safety of the power tool is maintained.*

Grinding, Sanding or Wire Brushing Operation Safety Warnings

- 1. **This power tool is intended to function as a grinder, sander or wire brushing tool. Read all safety warnings, instructions, illustrations and specifications provided with this power tool.** Failure to follow all instructions listed below may result in electric shock, fire and/or serious injury.
- 2. **Operations such as polishing or cutting-off are not recommended to be performed with this power tool.** Operations for which the power tool was not designed may create a hazard and cause personal injury.
- 3. **Do not use accessories which are not specifically designed and recommended by the tool manufacturer.** Just because the accessory can be attached to your power tool, it does not assure safe operation.
- 4. **The rated speed of the accessory must be at least equal to the maxi-**

imum speed marked on the power tool. Accessories running faster than their RATED SPEED can break and fly apart.

5. **The outside diameter and the thickness of your accessory must be within the capacity rating of your power tool.** Incorrectly sized accessories cannot be adequately guarded or controlled.
6. **The arbor size of wheels, flanges, backing pads or any other accessory must properly fit the spindle of the power tool.** Accessories with arbor holes that do not match the mounting hardware of the power tool will run out of balance, vibrate excessively and may cause loss of control.
7. **Do not use a damaged accessory. Before each use inspect the accessory such as abrasive wheels for chips and cracks, backing pad for cracks, tear or excess wear, wire brush for loose or cracked wires. If power tool or accessory is dropped, inspect for damage or install an undamaged accessory. After inspecting and installing an accessory, position yourself and bystanders away from the plane of the rotating accessory and run the power tool at maximum no-load speed for one minute.** Damaged accessories will normally break apart during this test time.
8. **Wear personal protective equipment. Depending on application, use face shield, safety goggles or safety glasses. As appropriate, wear dust mask, hearing protectors, gloves and workshop apron capable of stopping small abra-**
9. **sive or work piece fragments. The eye protection must be capable of stopping flying debris generated by various operations.** The eye protection must be capable of stopping flying debris generated by various operations. The dust mask or respirator must be capable of filtering particles generated by your operation. Prolonged exposure to high intensity noise may cause hearing loss.
9. **Keep bystanders a safe distance away from work area. Anyone entering the work area must wear personal protective equipment.** Fragments of work piece or of a broken accessory may fly away and cause injury beyond immediate area of operation.
10. **Hold power tool by insulated gripping surfaces only, when performing an operation where the cutting accessory may contact hidden wiring or its own cord.** Cutting accessory contacting a "live" wire may make exposed metal parts of the power tool "live" and shock the operator.
11. **Position the cord clear of the spinning accessory.** If you lose control, the cord may be cut or snagged and your hand or arm may be pulled into the spinning accessory.
12. **Never lay the power tool down until the accessory has come to a complete stop.** *The spinning accessory may grab the surface and pull the power tool out of your control.*
13. **Do not run the power tool while carrying it at your side. Accidental contact with the spinning accessory**

could snag your clothing, pulling the accessory into your body.

14. **Regularly clean the power tool's air vents.** *The motor's fan will draw the dust inside the housing and excessive accumulation of powdered metal may cause electrical hazards.*
15. **Do not operate the power tool near flammable materials.** *Sparks could ignite these materials.*
16. **Do not use accessories that require liquid coolants.** *Using water or other liquid coolants may result in electrocution or shock.*
17. Maintain labels and nameplates on the tool. These carry important safety information. If unreadable or missing, contact Harbor Freight Tools for a replacement.
18. Avoid unintentional starting. Prepare to begin work before turning on the tool.
19. Do not lay the tool down until it has come to a complete stop. Moving parts can grab the surface and pull the tool out of your control.
20. Do not leave the tool unattended when it is plugged into an electrical outlet. Turn off the tool, and unplug it from its electrical outlet before leaving.
21. This product is not a toy. Keep it out of reach of children.
22. People with pacemakers should consult their physician(s) before use. Electromagnetic fields in close proximity to heart pacemaker could cause pacemaker interference or pacemaker failure. In addition, people with pacemakers should:
 - Avoid operating alone.
 - Do not use with power switch locked on.
 - Properly maintain and inspect to avoid electrical shock.
 - Any power cord must be properly grounded. Ground Fault Circuit Interrupter (GFCI) should also be implemented – it prevents sustained electrical shock.
23. Some dust created by power sanding, sawing, grinding, drilling, and other construction activities, contains chemicals known [to the State of California] to cause cancer, birth defects or other reproductive harm. Some examples of these chemicals are:
 - Lead from lead-based paints
 - Crystalline silica from bricks and cement or other masonry products
 - Arsenic and chromium from chemically treated lumberYour risk from these exposures varies, depending on how often you do this type of work. To reduce your exposure to these chemicals: work in a well ventilated area, and work with approved safety equipment, such as those dust masks that are specially designed to filter out microscopic particles. (California Health & Safety Code § 25249.5, *et seq.*)
24. **WARNING:** Handling the cord on this product will expose you to lead, a chemical known to the State of California to cause cancer, and birth defects or other reproductive harm. Wash hands after handling. (California Health & Safety Code § 25249.5, *et seq.*)
25. The warnings, precautions, and instructions discussed in this instruction

manual cannot cover all possible conditions and situations that may occur. It must be understood by the operator that common sense and caution are factors which cannot be built into this product, but must be supplied by the operator.

Kickback and Related Warnings

Kickback is a sudden reaction to a pinched or snagged rotating wheel, backing pad, brush or any other accessory. Pinching or snagging causes rapid stalling of the rotating accessory which in turn causes the uncontrolled power tool to be forced in the direction opposite of the accessory's rotation at the point of the binding.

For example, if an abrasive wheel is snagged or pinched by the workpiece, the edge of the wheel that is entering into the pinch point can dig into the surface of the material causing the wheel to climb out or kick out. The wheel may either jump toward or away from the operator, depending on direction of the wheel's movement at the point of pinching. Abrasive wheels may also break under these conditions.

Kickback is the result of power tool misuse and/or incorrect operating procedures or conditions and can be avoided by taking proper precautions as given below.

1. **Maintain a firm grip on the power tool and position your body and arm to allow you to resist kickback forces. Always use auxiliary handle, if provided, for maximum control over kickback or torque reaction during start-up.** *The operator can control torque reactions or kickback forces, if proper precautions are taken.*
2. **Never place your hand near the rotating accessory.** *Accessory may kickback over your hand.*
3. **Do not position your body in the area where power tool will move if kickback occurs.** *Kickback will propel the tool in direction opposite to the wheel's movement at the point of snagging.*
4. **Use special care when working corners, sharp edges etc. Avoid bouncing and snagging the accessory.** *Corners, sharp edges or bouncing have a tendency to snag the rotating accessory and cause loss of control or kickback.*
5. **Do not attach a saw chain wood-carving blade or toothed saw blade.** *Such blades create frequent kickback and loss of control.*

Safety Warnings Specific for Grinding Operations

1. **Use only wheel types that are recommended for your power tool and the specific guard designed for the selected wheel.** *Wheels for which the power tool was not designed cannot be adequately guarded and are unsafe.*
2. **The guard must be securely attached to the power tool and positioned for maximum safety, so the least amount of wheel is exposed towards the operator.** *The guard helps to protect operator from broken wheel fragments and accidental contact with wheel.*
3. **Wheels must be used only for recommended applications. For example: do not grind with the**

side of cut-off wheel. *Abrasive cut-off wheels are intended for peripheral grinding, side forces applied to these wheels may cause them to shatter.*

- 4. Always use undamaged wheel flanges that are of correct size and shape for your selected wheel.** *Proper wheel flanges support the wheel thus reducing the possibility of wheel breakage. Flanges for cut-off wheels may be different from grinding wheel flanges.*
- 5. Do not use worn down wheels from larger power tools.** *Wheel intended for larger power tool is not suitable for the higher speed of a smaller tool and may burst.*

Safety Warnings Specific for Sanding Operations

- 1. Do not use excessively oversized sanding disc paper. Follow manufacturer's recommendations, when selecting sanding paper.** *Larger sanding paper extending beyond the sanding pad presents a laceration hazard and may cause snagging, tearing of the disc or kickback.*

Safety Warnings Specific for Wire Brushing Operations

- 1. Be aware that wire bristles are thrown by the brush even during ordinary operation. Do not overstress the wires by applying excessive load to the brush.** *The wire bristles can easily penetrate light clothing and/or skin.*
- 2. If the use of a guard is recommended for wire brushing, do not allow any interference of the wire**

wheel or brush with the guard. *Wire wheel or brush may expand in diameter due to work load and centrifugal forces.*

Vibration Safety

This tool vibrates during use. Repeated or long-term exposure to vibration may cause temporary or permanent physical injury, particularly to the hands, arms and shoulders. To reduce the risk of vibration-related injury:

- 1. Anyone using vibrating tools regularly or for an extended period should first be examined by a doctor and then have regular medical check-ups to ensure medical problems are not being caused or worsened from use.** Pregnant women or people who have impaired blood circulation to the hand, past hand injuries, nervous system disorders, diabetes, or Raynaud's Disease should not use this tool. If you feel any medical or physical symptoms related to vibration (such as tingling, numbness, and white or blue fingers), seek medical advice as soon as possible.
- 2. Do not smoke during use.** Nicotine reduces the blood supply to the hands and fingers, increasing the risk of vibration-related injury.
- 3. Wear suitable gloves to reduce the vibration effects on the user.**
- 4. Use tools with the lowest vibration when there is a choice between different processes.**
- 5. Include vibration-free periods each day of work.**

6. Grip tool as lightly as possible (while still keeping safe control of it). Let the tool do the work.
7. To reduce vibration, maintain the tool as explained in this manual. If any abnormal vibration occurs, stop use immediately.



SAVE THESE INSTRUCTIONS.

GROUNDING

⚠️ WARNING TO PREVENT ELECTRIC SHOCK



AND DEATH FROM INCORRECT GROUNDING WIRE CONNECTION: Check with a qualified electrician if you are in doubt as to whether the outlet is properly grounded. Do not modify the power cord plug provided with the tool. Never remove the grounding prong from the plug. Do not use the tool if the power cord or plug is damaged. If damaged, have it repaired by a service facility before use. If the plug will not fit the outlet, have a proper outlet installed by a qualified electrician.

Note: This is a double insulated tool. Information on grounded tools is provided for reference only.

Grounded Tools: Tools with Three Prong Plugs

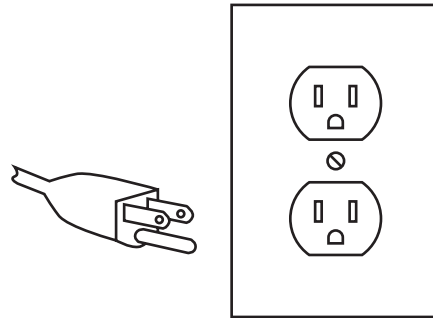

3-Prong Plug and Outlet

1. Tools marked with “Grounding Required” have a three wire cord and three prong grounding plug. The plug must be connected to a properly grounded outlet. If the tool should electrically malfunction or break down, grounding provides a low resistance path to carry electricity away from the user, reducing the risk of electric shock. **(See 3-Prong Plug and Outlet.)**
2. The grounding prong in the plug is connected through the green wire inside the cord to the grounding system in the tool. The green wire in the cord must be the only wire connected to the tool’s grounding system and must never be attached to an electrically “live” terminal. **(See 3-Prong Plug and Outlet.)**
3. The tool must be plugged into an appropriate outlet, properly installed and grounded in accordance with all codes and ordinances. The plug and outlet should look like those in the preceding illustration. **(See 3-Prong Plug and Outlet.)**

Double Insulated Tools: Tools with Two Prong Plugs

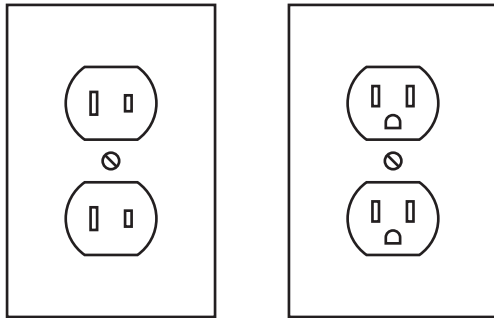

Outlets for 2-Prong Plug

1. Tools marked “Double Insulated” do not require grounding. They have a special double insulation system which satisfies OSHA requirements and complies with the applicable standards of Underwriters Laboratories, Inc., the Canadian Standard Association, and the National Electrical Code. **(See Outlets for 2-Prong Plug.)**
2. Double insulated tools may be used in either of the 120 volt outlets shown in the preceding illustration. **(See Outlets for 2-Prong Plug.)**

Extension Cords

1. **Grounded** tools require a three wire extension cord. **Double Insulated** tools can use either a two or three wire extension cord.
2. As the distance from the supply outlet increases, you must use a heavier gauge extension cord. Using extension cords with inadequately sized wire causes a serious drop in voltage, resulting in loss of power and possible tool damage. **(See Table A.)** The smaller the gauge number of the wire, the greater the capacity of the cord. For ex-







ample, a 14 gauge cord can carry a higher current than a 16 gauge cord. **(See Table A.)**

3. When using more than one extension cord to make up the total length, make sure each cord contains at least the minimum wire size required. **(See Table A.)**
4. If you are using one extension cord for more than one tool, add the nameplate amperes and use the sum to determine the required minimum cord size. **(See Table A.)**
5. If you are using an extension cord outdoors, make sure it is marked with the suffix “W-A” (“W” in Canada) to indicate it is acceptable for outdoor use.
6. Make sure the extension cord is properly wired and in good electrical condition. Always replace a damaged extension cord or have it repaired by a qualified electrician before using it.
7. Protect the extension cords from sharp objects, excessive heat, and damp or wet areas.

RECOMMENDED MINIMUM WIRE GAUGE FOR EXTENSION CORDS* (120/240 VOLT)					
NAMEPLATE AMPERES (at full load)	EXTENSION CORD LENGTH				
	25'	50'	75'	100'	150'
0 – 2.0	18	18	18	18	16
2.1 – 3.4	18	18	18	16	14
3.5 – 5.0	18	18	16	14	12
5.1 – 7.0	18	16	14	12	12
7.1 – 12.0	18	14	12	10	-
12.1 – 16.0	14	12	10	-	-
16.1 – 20.0	12	10	-	-	-

TABLE A * Based on limiting the line voltage drop to five volts at 150% of the rated amperes.

Symbology

	Double Insulated
	Canadian Standards Association
	Underwriters Laboratories, Inc.
	Volts Alternating Current
	Amperes
	No Load Revolutions per Minute (RPM)

SPECIFICATIONS

Electrical Requirements	120 V~ / 60 Hz / 15 A
Motor No Load Speed	8000 RPM
Wheel Diameter	7 inches
Arbor Diameter	7/8 inch
Spindle Thread	5/8 inch x 11 TPI



UNPACKING

When unpacking, check to make sure that the item is intact and undamaged. If any parts are missing or broken, please call Harbor Freight Tools at the number shown on the cover of this manual as soon as possible.

List of contents

Description	Q'ty
Angle Grinder	1
Grinding Wheel	1
Quick Release Wheel Guard	1
Auxiliary Handle	1
Pin Wrench	1
Owner's Manual	1

INSTRUCTIONS FOR PUTTING INTO USE



Read the **ENTIRE IMPORTANT SAFETY INFORMATION** section at the beginning of this manual including all text under subheadings therein before set up or use of this product.

⚠ WARNING TO PREVENT SERIOUS INJURY FROM ACCIDENTAL OPERATION:
Turn the Power Switch of the tool to its "OFF" position and unplug the tool from its electrical outlet before assembling or making any adjustments to the tool.

Note: For additional information regarding the parts listed in the following pages, refer to the Assembly Diagram near the end of this manual.

Assembly

Installing the Wheel Guard

1. The Wheel Guard (7) must be installed before installing a grinding wheel or other disc.
2. Loosen the Wheel Guard Quick Release (6) by pulling the lever outward.
3. Slide the collar of the Wheel Guard (7) over the rim of the Front Cap (13).
4. Rotate the position of the Wheel Guard as needed for the planned work.
5. Tighten the Wheel Guard Quick Release by pressing the lever back in place. The clamping pressure of the Quick Release may be adjusted using the Nut (4).
6. Check the Wheel Guard to ensure it is firmly in place. Adjust if necessary before proceeding.

Installing the Auxiliary Handle

⚠ WARNING TO PREVENT SERIOUS INJURY:
Do not operate this tool with one hand only or without the Auxiliary Handle properly installed.

7. The Auxiliary Handle may be installed in one of three positions, on either side or on top of the Gear Housing (26). (See Photo.)
8. Screw the threaded end of the Auxiliary Handle into the selected position. Tighten securely before beginning work.

Functions

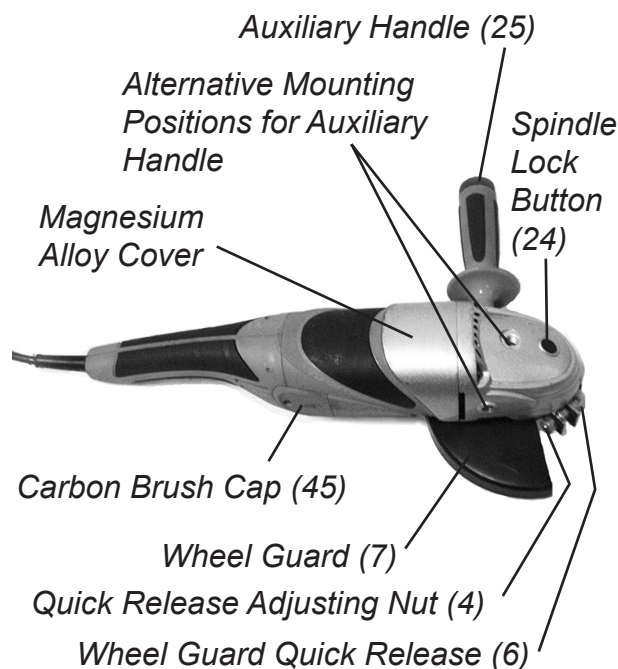

This hand-held tool may be used for grinding, sanding, scaling, and other related operations.

OPERATING INSTRUCTIONS



Read the **ENTIRE IMPORTANT SAFETY INFORMATION** section at the beginning of this manual including all text under subheadings therein before set up or use of this product.

Tool Set Up

⚠ WARNING TO PREVENT SERIOUS INJURY FROM ACCIDENTAL OPERATION:
Turn the Power Switch of the tool to its "OFF" position and unplug the tool from its electrical outlet before performing any inspection, maintenance, or cleaning procedures.

Installing a Grinding Wheel

1. Before installing a grinding wheel, review the warnings on pages 5 - 7. The Grinding Wheel MUST be:
 - rated to at least 8000 RPM.
 - no larger than 7" in diameter.
 - fitted with a 7/8" round arbor hole.
 - 3/8" thick or less.
 - a type of grinding wheel suitable for surface grinding, not edge grinding.
 - dry and clean.
 - proven undamaged by inspection and by the ring-test explained below.
2. Press in and hold the Spindle Lock Button (24) to prevent the Spindle (8) from turning.
3. Remove the Outer Flange (1). Keep the Inner Flange (3) in position on the Spindle.

4. Closely inspect the Grinding Wheel before mounting. Perform a ring-test on the wheel (unless wheel is smaller than 4" or is an unusual shape) as follows:
 - a. Suspend wheel using a pin or finger through the arbor hole.

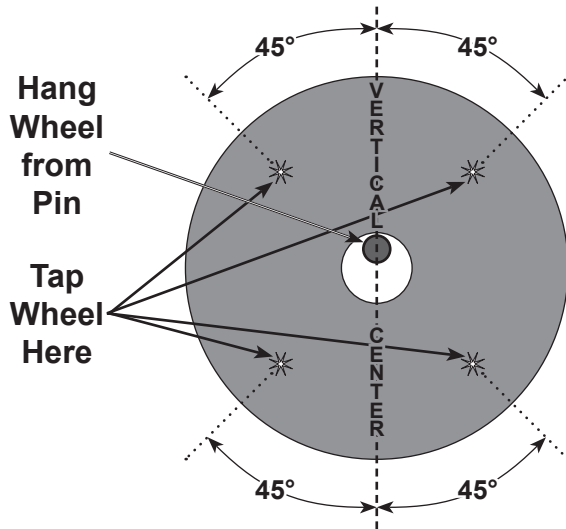

- b. Tap the flat side of the wheel with a light non-metallic object, such as a screwdriver handle, at a point 45° from the vertical center line on each side of the wheel and 1 – 2 inches from the edge of the wheel (see Illustration).
 - c. Rotate the wheel 45 degrees and repeat the test until the entire wheel has been checked.
 - d. An undamaged wheel will give a clear tone. If cracked, there will be a dead sound and not a clear ring.
5. Slip the grinding wheel onto the Spindle with a paper gasket, or blotter, first. The blotter should be centered on the grinding wheel and the wheel and blotter should rest flat against the Inner Flange.

⚠WARNING: To prevent serious injury, blotters must be used for all grinding wheels they are provided

with. Blotters help prevent grinding wheel damage and wheel slippage, causes of wheel failure.

6. Thread the Outer Flange Arbor Nut onto the Spindle. Wrench tighten only enough so that the wheel is securely held on the spindle.

⚠WARNING: To prevent serious injury, do not overtighten flange. Overtightening can damage the wheel, causing wheel failure.

Installing a Threaded Accessory

⚠CAUTION TO PREVENT INJURY:

Wear heavy-duty work gloves when handling wire wheels and brushes. These accessories are sharp and can cause injury.

1. Before installing an accessory, review the warnings on pages 5 - 7. The accessory **MUST** be:
 - rated to at least 8000 RPM.
 - no larger than 7" in diameter.
 - fitted with a threaded opening of 5/8" x 11 TPI.
 - undamaged.
 - a sanding disc and backing pad, a sanding flap disc, a wire wheel or a wire cup brush (accessories not included).
2. Press in and hold the Spindle Lock Button (24) to prevent the Spindle (8) from turning.
3. Remove the Outer Flange Arbor Nut (1) and the Inner Flange (3) and keep in a safe place.
4. Thread disc accessory firmly onto the Spindle. Wrench tighten onto the spindle.

Work Piece and Work Area Set Up

1. Designate a work area that is clean and well-lit. The work area must not allow access by children or pets to prevent injury and distraction.
2. Route the power cord along a safe route to reach the work area without creating a tripping hazard or exposing the power cord to possible damage. The power cord must reach the work area with enough extra length to allow free movement while working.
3. Secure loose work pieces using a vise or clamps (not included) to prevent movement while working.
4. There must not be hazardous objects, such as utility lines or foreign objects, nearby that will present a hazard while working.
5. You must use personal safety equipment including, but not limited to, ANSI-approved eye and hearing protection, as well as heavy work gloves.
6. Before beginning work, provide for sparks and debris that will fly off the work surface.

General Operating Instructions

⚠ WARNING **TO PREVENT SERIOUS INJURY:**
Grip the tool firmly in both hands.

1. This tool has a lock-on Trigger Switch. Push the switch, and then push forward the tab to lock the switch for continuous running.
2. Allow the tool to come up to full speed before touching the work material.
3. Apply the wheel to the work material, allowing the tool to operate at full speed. If the tool bogs down, use lighter pressure.
4. To create a smoother surface, keep the tool moving over the work surface.
5. Release the Trigger Switch to stop the tool.
6. Allow the tool to come to a complete stop before setting it down.
7. To prevent accidents, turn off the tool and disconnect its power supply after use. Clean, then store the tool indoors out of children's reach.

MAINTENANCE AND SERVICING



Procedures not specifically explained in this manual must be performed only by a qualified technician.

⚠️ WARNING

TO PREVENT SERIOUS INJURY

FROM ACCIDENTAL OPERATION:

Turn the Power Switch of the tool to its “OFF” position and unplug the tool from its electrical outlet before performing any inspection, maintenance, or cleaning procedures.

TO PREVENT SERIOUS INJURY FROM TOOL FAILURE:

Do not use damaged equipment. If abnormal noise or vibration occurs, have the problem corrected before further use.

Cleaning, Maintenance, and Lubrication

1. **BEFORE EACH USE**, inspect the general condition of the tool. Check for loose screws, misalignment or binding of moving parts, cracked or broken parts, damaged electrical wiring, and any other condition that may affect its safe operation.
2. Periodically blow dust and grit out of the motor vents using dry compressed air. Always wear safety glasses when performing this maintenance operation.
3. **AFTER USE**, clean external surfaces of the tool with clean cloth. Never use solvents or harsh cleaners as they may damage the housing. **To prevent electrical shock, do not allow water or other liquids to enter the motor vent holes in the Gear Housing (26).**
4. **GRINDING WHEEL CARE:**
 - Handling** - Do not lean grinding wheels against an object, or rest objects on grinding wheels. Do not drop grinding wheels or roll them across the floor.
 - Storage** - Store thick grinding wheels on appropriate racks and store thin grinding wheels flat on a dry surface. Store in a relatively constant temperature and do not expose to moisture or freezing temperatures.
 - ⚠️ WARNING:** To prevent serious injury from grinding wheel failure, discard any wheels that have been improperly handled or stored.
5. **OTHER ACCESSORY CARE:**
 - Handling** - Do not drop accessories. Do not bend or flex accessories that are not intended to bend.
 - Storage** - Store accessories in dry, cool area.
6. **CARBON BRUSH MAINTENANCE.** The carbon brushes may require maintenance when the motor performance of the tool decreases or stops working completely. To maintain the brushes:
 - a. Remove the Screws (40) and Brush Caps (41 and 45) from the sides of the motor housing.

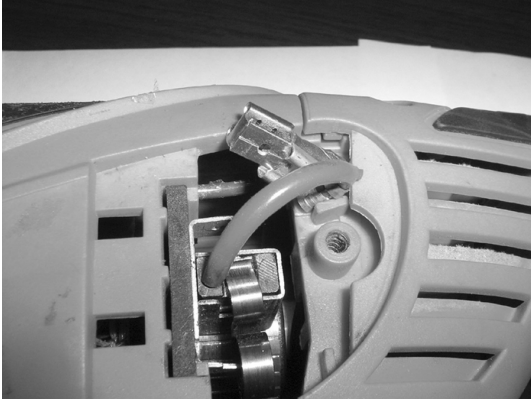

- b. Disconnect the Carbon Brush Leads as shown in the illustration above.

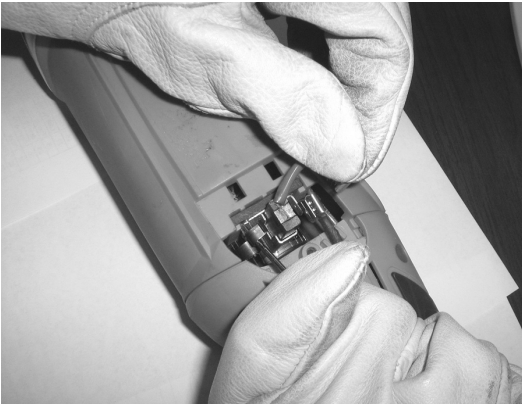

- c. Use a small prying tool (not included) to hold the Spring Clips to the side while you remove the carbon brushes. **Keep track of which orientation the old carbon brushes were in to prevent needless wear if they will be reinstalled.**
- d. If either carbon brush is worn down by more than 1/2, replace **both** carbon brushes.
- e. To clean old carbon brushes before reusing them, rub the contact areas with a pencil eraser.
- f. Hold the spring clips to the side and reinsert the old carbon brushes in the same orientation to reduce wear.
- g. When installing the carbon brushes, make sure the carbon portions of the carbon brushes contact the motor

armature, and that the springs face away from the motor. Also, make sure the springs operate freely.

- h. Reconnect the Carbon Brush Leads.
- i. Replace the Brush Caps and Screws. Do not overtighten.

Note: New carbon brushes tend to spark when first used until they wear and conform to the motor's armature.

7. **⚠WARNING!** If the supply cord of this power tool is damaged, it must be replaced only by a qualified service technician.

<u>Troubleshooting</u>		
Problem	Possible Causes	Likely Solutions
Tool will not start	<ol style="list-style-type: none"> 1. No power at outlet. 2. Cord not connected. 3. Carbon Brushes may be worn or damaged. 	<ol style="list-style-type: none"> 1. Check power at outlet. 2. Check that cord is plugged in. 3. Inspect Carbon Brushes and replace if necessary.
Tool operates slowly or erratically.	<ol style="list-style-type: none"> 1. Carbon Brushes may be worn or damaged. 2. Excess pressure applied to workpiece. 	<ol style="list-style-type: none"> 1. Inspect Carbon Brushes and replace if necessary. 2. Decrease pressure, allow tool to do the work.
Tool does not grind, sand or brush effectively.	<ol style="list-style-type: none"> 1. Disc accessory may be loose on Spindle. Check tightness of Outer Flange Arbor Nut or threaded disc accessory on Spindle. 2. Disc accessory may be damaged, worn or wrong type for the material. 	<ol style="list-style-type: none"> 1. Be sure disc accessory is of correct dimension and Outer Flange Arbor Nut is tight. 2. Check condition and type of disc accessory. Use only proper type of disc accessory in good condition.
 Follow all safety precautions whenever diagnosing or servicing the tool. Disconnect power supply before service.		

PLEASE READ THE FOLLOWING CAREFULLY

THE MANUFACTURER AND/OR DISTRIBUTOR HAS PROVIDED THE PARTS LIST AND ASSEMBLY DIAGRAM IN THIS MANUAL AS A REFERENCE TOOL ONLY. NEITHER THE MANUFACTURER OR DISTRIBUTOR MAKES ANY REPRESENTATION OR WARRANTY OF ANY KIND TO THE BUYER THAT HE OR SHE IS QUALIFIED TO MAKE ANY REPAIRS TO THE PRODUCT, OR THAT HE OR SHE IS QUALIFIED TO REPLACE ANY PARTS OF THE PRODUCT. IN FACT, THE MANUFACTURER AND/OR DISTRIBUTOR EXPRESSLY STATES THAT ALL REPAIRS AND PARTS REPLACEMENTS SHOULD BE UNDERTAKEN BY CERTIFIED AND LICENSED TECHNICIANS, AND NOT BY THE BUYER. THE BUYER ASSUMES ALL RISK AND LIABILITY ARISING OUT OF HIS OR HER REPAIRS TO THE ORIGINAL PRODUCT OR REPLACEMENT PARTS THERETO, OR ARISING OUT OF HIS OR HER INSTALLATION OF REPLACEMENT PARTS THERETO.

PARTS LIST

Part	Description	Qty.
1	Outer Flange Arbor Nut	1
2	Grinding Wheel (not included)	-
3	Inner Flange	1
4	Quick Release Adjusting Nut m8	1
5	Washer	1
6	Wheel Guard Quick Release	1
7	Wheel Guard	1
8	Spindle	1
9	Woodruff Key	1
10	Phillips Pan Head Screw m5 x 16	4
11	Spring Washer m5	4
12	Flat Washer	8
13	Front Cap	1
14	Bearing 6203	1
15	Bearing Retaining Plate	1
16	Spring Washer m4	7
17	Phillips Pan Head Screw m4 x 12	7
18	Bevel Gear	1
19	Open Circlip	1
20	Needle Gear	1
21	Open Circlip	1
22	Phillips Pan Head Screw m4.8 x 28	1
23	Spring	1
24	Spindle Lock Button	1
25	Auxiliary Handle	1
26	Gear Housing	1
27	Lock Nut m8 (black)	1

PARTS LIST

Part	Description	Qty.
28	Pinion	1
29	Bearing 6201	1
30	Bearing Retaining Plate	1
31	Rotor	1
32	Bearing 629	1
33	Bearing Sleeve	1
34	Baffle Ring	1
35	Self Tapping Screw m4.2 x 71	1
36	Stator	1
37	Lug	1
38	Heat Shrinkable Tube	1
39	Magnesium Alloy Cover	1
40	Self Tapping Screw m4.2 x 14	4
41	Carbon Brush Cap (left)	1
42	Motor Housing	1
43	Carbon Brush	2
44	Carbon Brush Holder	2
45	Carbon Brush Cap (right)	1
46	Coil Spring	2
47	Nameplate	1
48	Self Tapping Screw	5
49	Left Handle	1
50	Power Cable & Plug	1
51	Cable Clamp	1
52	Cable Sleeve	1
53	Right Handle	1
54	Trigger Switch	1

ASSEMBLY DIAGRAM

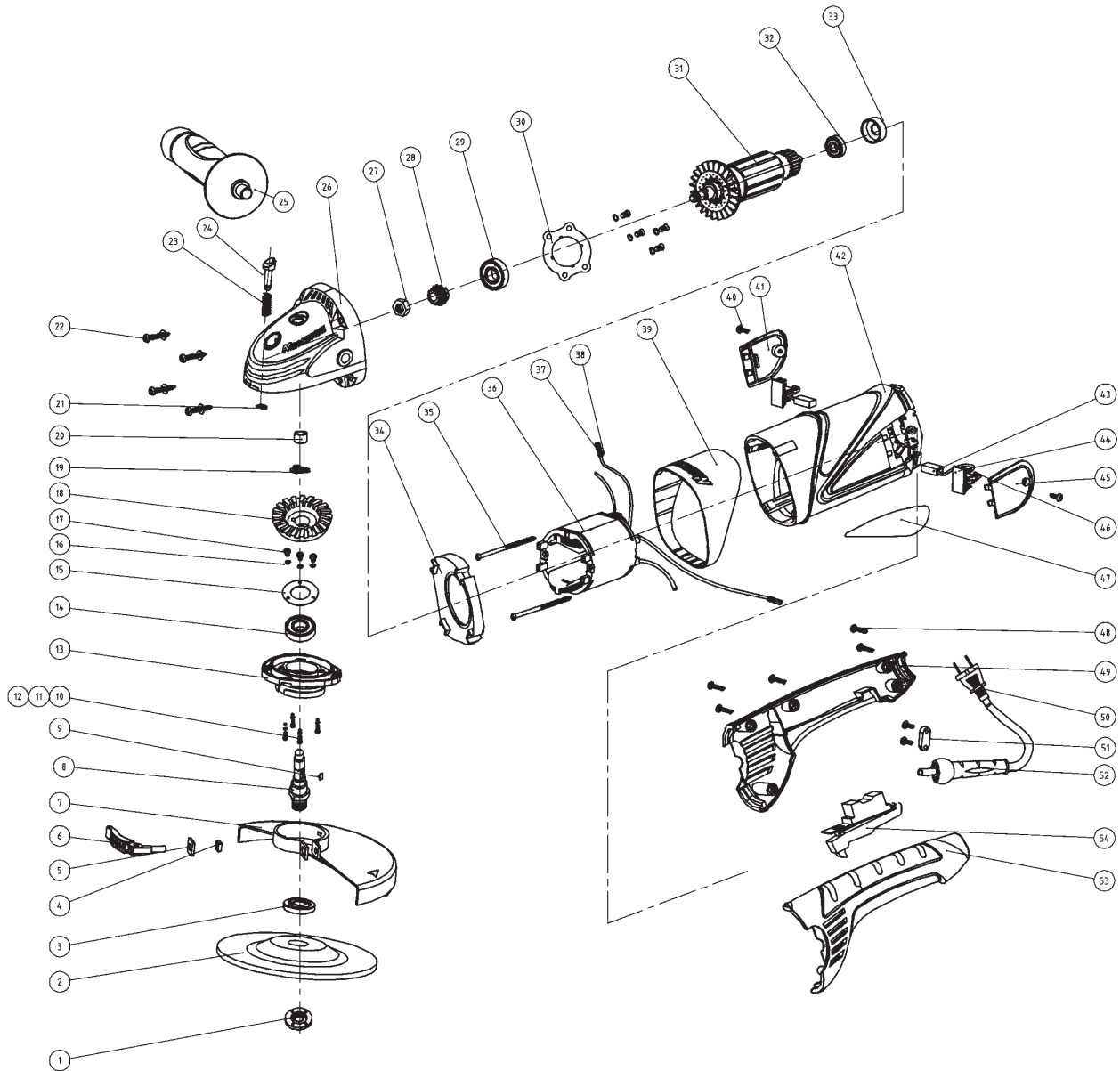

Record Product's Serial Number Here: _____

Note: If product has no serial number, record month and year of purchase instead.

Note: Some parts are listed and shown for illustration purposes only, and are not available individually as replacement parts.

90 DAY WARRANTY

Harbor Freight Tools Co. makes every effort to assure that its products meet high quality and durability standards, and warrants to the original purchaser that this product is free from defects in materials and workmanship for the period of 90 days from the date of purchase. This warranty does not apply to damage due directly or indirectly, to misuse, abuse, negligence or accidents, repairs or alterations outside our facilities, criminal activity, improper installation, normal wear and tear, or to lack of maintenance. We shall in no event be liable for death, injuries to persons or property, or for incidental, contingent, special or consequential damages arising from the use of our product. Some states do not allow the exclusion or limitation of incidental or consequential damages, so the above limitation of exclusion may not apply to you. This warranty is expressly in lieu of all other warranties, express or implied, including the warranties of merchantability and fitness.

To take advantage of this warranty, the product or part must be returned to us with transportation charges prepaid. Proof of purchase date and an explanation of the complaint must accompany the merchandise. If our inspection verifies the defect, we will either repair or replace the product at our election or we may elect to refund the purchase price if we cannot readily and quickly provide you with a replacement. We will return repaired products at our expense, but if we determine there is no defect, or that the defect resulted from causes not within the scope of our warranty, then you must bear the cost of returning the product.

This warranty gives you specific legal rights and you may also have other rights which vary from state to state.

3491 Mission Oaks Blvd. • PO Box 6009 • Camarillo, CA 93011 • (800) 444-3353

Free Manuals Download Website

<http://myh66.com>

<http://usermanuals.us>

<http://www.somanuals.com>

<http://www.4manuals.cc>

<http://www.manual-lib.com>

<http://www.404manual.com>

<http://www.luxmanual.com>

<http://aubethermostatmanual.com>

Golf course search by state

<http://golfingnear.com>

Email search by domain

<http://emailbydomain.com>

Auto manuals search

<http://auto.somanuals.com>

TV manuals search

<http://tv.somanuals.com>